

OPERATING INSTRUCTIONS UPS

AEG



PROTECT C.

PROTECT C. 1000 (S)

PROTECT C. 2000 (S)

PROTECT C. 3000 (S)

**Thank you for purchasing the AEG UPS PROTECT C.
from AEG Power Solutions.**

**Safety information and operating instructions are
included in this manual. To ensure correct use of the
UPS, please read this manual thoroughly before
operating it. Save this manual properly.**

1 Notes on these Operating Instructions

Duty to Provide Information

These operating instructions will help you to install and operate the **U**ninterruptible **P**ower **S**upply (UPS) PROTECT C. 1000 (S), PROTECT C. 2000 (S) or PROTECT C. 3000 (S) as well as the associated external battery units PROTECT C.1000BP or PROTECT C. 2030 BP – all referred to as PROTECT C. in this document – safely and properly, and for its intended purpose. These operating instructions contain important information necessary to avoid dangers during operation.

Please read these instructions carefully prior to commissioning!

These operating instructions are a composite part of the PROTECT C.

The owner of this unit is obliged to communicate the full content of these operating instructions to all personnel transporting or starting the PROTECT C. or performing maintenance or any other work on the unit.

Validity

These operating instructions comply with the current technical specifications of the PROTECT C. at the time of delivery. The contents do not constitute a subject matter of the contract, but serve for information purposes only.

Warranty and Liability

We reserve the right to alter any specifications given in these operating instructions, especially with regard to technical data and operation, prior to start-up or as a result of service work.

Claims in connection with supplied goods must be submitted within one week of receipt, along with the packing slip. Subsequent claims cannot be considered.

The warranty does not apply to damage caused by non-compliance with these instructions (such damage also includes damaging the warranty seal). AEG will accept no liability for consequential damage. AEG reserves the right to rescind all obligations such as warranty agreements, service contracts, etc. entered into by AEG and its representatives without prior notification in the event of maintenance and repair work being carried out with anything other than original AEG spare parts or spare parts purchased by AEG.

Handling

PROTECT C. is designed and constructed so that all necessary steps for start-up and operation can be performed without any internal manipulation of the unit. Maintenance and repair work may only be performed by trained and qualified personnel.

Illustrations are provided to clarify and facilitate certain steps.

If danger to personnel and the unit cannot be ruled out in the case of certain work, it is highlighted accordingly by pictograms explained in chapter 3.

Hotline

If you still have questions after having read these operating instructions, please contact your dealer or our "Hotline":

Tel.: ++49 (0)180 5 234 787

Fax: ++49 (0)180 5 234 789

Internet: www.aegpartnet.net

Copyright

No part of these operating instructions may be transmitted, reproduced and/or copied by any electronic or mechanical means without the express prior written permission of AEG.

© Copyright AEG 2009. All rights reserved.

Table of Contents

1	Notes on these Operating Instructions	3
2	General Information	7
2.1	Technology	7
2.2	System Description	8
3	Safety	9
3.1	General Safety Instructions	9
3.2	Safety Instructions for PROTECT C.	9
3.3	CE-Certificate	13
3.4	Technical Data	14
4	Set-Up and Operation	19
4.1	Unpacking and Inspection	19
4.2	Point of Installation	20
4.3	Overview: Connections, Operating / Display Elements ...	21
4.3.1	Front View	21
4.3.2	Display	22
4.3.3	Rear view (connections):	23
5	Commissioning	25
5.1	Mechanical Set-Up	25
5.2	External Battery Expansions	26
5.2.1	Electrical Start-Up	27
5.3	Operating Statuses	29
5.3.1	Normal Operation	29
5.3.2	Battery Operation / Autonomy Operation	30
5.3.3	Bypass Operation	31
5.3.4	Unit Overload	32
5.4	Interfaces and communication	33
5.4.1	Data line protection RJ11 and RJ45	33
5.4.2	Computer interfaces RS232	33
5.4.3	Communication Slot	33
5.4.4	Shutdown and UPS management software	34

6	Signalling and Error Correction	35
6.1	Signalling.....	35
6.2	Fault Diagnosis / Fault Rectification.....	37
6.2.1	Error Messages.....	37
7	Maintenance	39
7.1	Charging the Battery	39
7.2	Maintenance.....	39
7.2.1	Visual Check	39
7.2.2	Checking the Battery	40
7.2.3	Fan Checking.....	40
8	Storage, Dismantling and Disposal	41
8.1	Storage.....	41
8.2	Dismantling	41
8.3	Disposal	41
9	Glossary	42
9.1	Technical terms.....	42

2 General Information

2.1 Technology

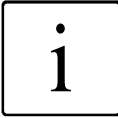

PROTECT C. is an Uninterruptible Power Supply (UPS) for essential loads such as PCs, workstations, servers, network components, telecommunication equipment and similar devices. It consists of:

- ◆ Mains filter with surge voltage protection (equipment protection/class D) and mains energy backfeed protection
- ◆ Rectifier section with PFC logic (power factor correction unit)
- ◆ Separate battery charger with switch mode power supply technology
- ◆ Sealed, zero-maintenance battery system as energy storage medium with downstream DC/DC converter unit
- ◆ IGBT inverter for continuous supply of connected loads with sinusoidal AC voltage
- ◆ Automatic bypass as additional passive redundancy
- ◆ Microprocessor controlled control unit

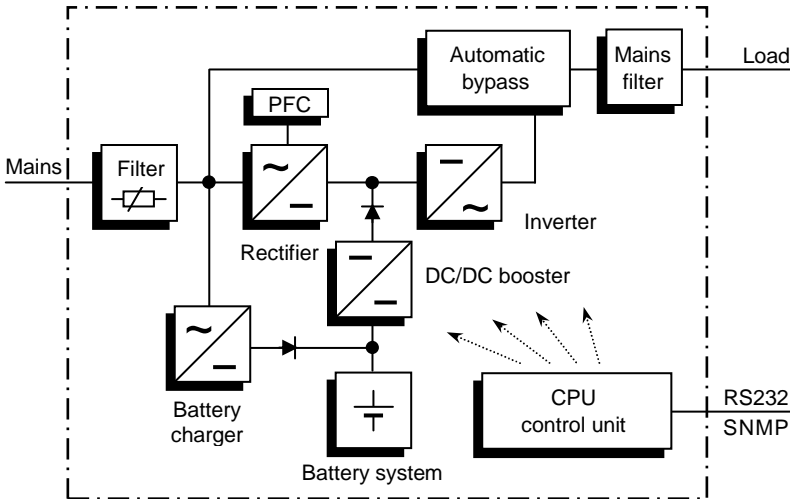

View of the PROTECT C. components

2.2 System Description

The UPS is connected to a shockproof socket between the public utility's mains and the loads to be protected.

The power section of the rectifier converts the mains voltage to DC voltage for supplying the inverter. The circuit technology used (PFC) enables sinusoidal current consumption and therefore operation with little system disturbance. A separate, second rectifier (charging REC set up using switch mode power supply technology) is responsible for charging or trickle-charging the battery connected in the intermediate circuit. The configuration of this charging REC means the harmonic content of the charging current for the battery is almost zero, so the service life of the battery is increased even more. The inverter is responsible for converting the DC voltage into a sinusoidal output voltage. A microprocessor-controlled control system based on pulse-width modulation (PWM) in conjunction with an extremely quickly pulsating IGBT power semiconductors of the inverter guarantee that the voltage system on the protected busbar is of the highest quality and availability.

In the event of mains faults (e.g. current failures), the voltage continues to be supplied from the inverter to the load without any interruption. From this point onwards, the inverter draws its power from the battery instead of the rectifier. No switching operations are necessary; this means there is no interruption in the supply to the load.

For safety reasons (as required by German standards, VDE), the mains input in the unit will be disconnected by a two-pole switch in the event of a mains failure. Energy backfeed to the mains and voltage supply to the pins of the mains connector are thus reliably avoided.

The automatic bypass serves to increase the reliability of the supply further. It switches the public mains directly through to the load if there is an inverter malfunction. As a result, the automatic bypass represents an extra passive redundancy for the load.

3 Safety

3.1 General Safety Instructions

Read these operating instructions prior to start-up of the PROTECT C. UPS and its external battery modules (special accessories), and observe the safety instructions!

Only use the unit if it is in a technically perfect condition and always in accordance with its intended purpose, while being aware of safety and danger aspects, and in accordance with the operating instructions! Immediately eliminate any faults that could be detrimental to safety.

The following pictograms are used in these operating instructions to identify dangers and important information:



Danger!

Identifies risk of fatal injury to the operator.



Attention!

Identifies risk of injury and risk of damage to the unit and parts of the unit.

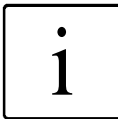

Information!

Useful and important hints for the operation of the UPS and its external battery modules (special accessories).

3.2 Safety Instructions for PROTECT C.

This chapter contains important instructions for the PROTECT C. UPS and its external battery modules (special accessories). These must be followed during assembly, operation and maintenance of the uninterruptible power supply and the battery systems (internal and, if appropriate, external as well).



The UPS carries high voltage. Danger! **The unit may only be opened by trained and qualified personnel.** Repairs may only be carried out by qualified customer service staff!



The output may be live, even if the UPS is not connected to the mains, since the UPS has its own internal power supply (battery)!



For health and safety reasons, the unit must be **earthed correctly!**

PROTECT C. may only be operated with or connected to a 220 V / 230 V / 240 V mains with protective grounding using a CE marked mains connection cable with PE conductor (included in the delivery) that has been tested in accordance with national standards.

Danger! Risk of burning!



The battery has **powerful short-circuit currents**. Incorrect connection or isolation faults can lead to melting of the plug connections, sparking potential and severe burns!



The unit has a warning signal that sounds when the battery voltage of PROTECT C. is exhausted or when the UPS is not working in its normal mode (see also chapter 6.1).



Observe the following safety instructions to ensure permanent operational safety of and safe work with the UPS and the battery modules (special accessories):

- ◆ Do not dismantle the UPS!
(The UPS does not contain any parts that require regular maintenance. Bear in mind that the warranty will be invalidated if the unit is opened!)
- ◆ Do not install the unit in direct sunshine or in close proximity of heaters!

- ◆ The unit is designed to be installed inside in heated rooms. Never install the housing in the vicinity of water or in an excessively damp environment!
- ◆ Condensation may occur if the UPS is brought from a cold environment into the room where it is to be installed. The UPS must be absolutely dry prior to start-up. As a result, leave it to acclimatise for at least two hours.
- ◆ Never connect the mains input to the UPS output, and vice versa!
- ◆ Ensure that no fluids or foreign bodies can penetrate the housing!
- ◆ Do not block the air vents of the unit! Keep children away from the unit and ensure that objects are never inserted through the air vents!
- ◆ Do not connect household appliances such as hairdryers to the UPS! Also take care when working with motor loads. It is essential to avoid back-feeding the inverter, e.g. if the load is intermittently operated in regenerative mode.
- ◆ The mains connection should be near the unit and easily accessible to facilitate disconnecting the AC input or pulling out the plug!
- ◆ During operation, do not disconnect the mains connection cable from the UPS or from the socket outlet in the building (shockproof socket), otherwise the protective grounding of the UPS and all the loads connected to it will be cancelled.



Danger! Electric shocks!

Even after the mains voltage has been disconnected, the components within the UPS remain connected to the battery and can thus cause electric shocks. It is therefore imperative to disconnect the battery circuit before carrying out any maintenance or repair work!



If it is necessary to replace the battery or carry out maintenance work, this must be done by or under the supervision of a specialist familiar with batteries and the necessary safety precautions!

Only authorised persons are allowed in the vicinity of the batteries!

When replacing the batteries, the following must be observed:
Only ever use identical maintenance-free sealed lead batteries with the same data as the original batteries.



Danger! Explosive!

Never throw batteries into open fire.

Never open or damage batteries. (Electrolyte may leak out and damage skin and eyes. It may be toxic!)



Batteries can cause electric shocks and high short-circuit currents.

Take the following safety precautions when working with the batteries:

- ◆ Take off watches, rings and other metallic objects!
- ◆ Always use tools with insulated handles!

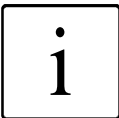

Do not switch loads on and off using the UPS main switch. Do not use multiple outlet adapters with a central on/off switch, in order to avoid peak inrush currents.

Switch OFF the UPS using its main switch “OFF” if you do not intend to use it for some time. PROTECT C. must be switched off every evening if the electricity supply in your company is switched off every night. Otherwise, the battery will be discharged (assumed power failure). Frequent and complete discharging of the battery leads to a shorter service life of the battery and should therefore be avoided!



For personal safety reasons, never switch on the main switch when the mains connector of PROTECT C. is disconnected!

3.3 CE-Certificate

AEG

Power Solutions

Declaration of Conformity

Document - No. CE 0062

We

AEG Power Solutions GmbH
Emil – Siepmann – Straße 32, D – 59581 Warstein

declare under our sole responsibility that the product

Uninterruptible Power Supply (UPS)
Protect C.1000(S) / C.2000(S) / C.3000(S)
Protect C.1000R(S) / C.2000R(S) / C.3000R(S)

to which this declaration relates is in conformity with the following standards or other normative documents

EN 50091-1-1:1996
EN 50091-2:1995 clause 2.4/2.5 class B
EN 61000-3-2:1995
EN 61000-3-3:1995

Following the provisions of directives

89 / 336 / EEC	EMC Directive
73 / 23 / EEC	Low Voltage Directive
93 / 68 / EEC	Marking Directive

Year of labelling the CE – Mark: 2005

Germany, 59581 Warstein, 03.12.2008

AEG Power Solutions GmbH
Quality Management

.....
(Filmar)

AEG Power Solutions GmbH
Product Management
Compact UPS

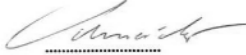
.....
(Schneider)

3.4 Technical Data

Type power

PROTECT C. 1000 (S)	1000 VA (cos φ = 0.7 lag.) 700 W
PROTECT C. 2000 (S)	2000 VA (cos φ = 0.7 lag.) 1400 W
PROTECT C. 3000 (S)	3000 VA (cos φ = 0.7 lag.) 2100 W

UPS Input (single phase)

Rated input voltage	220 / 230 / 240 Vac
Voltage tolerance range	160 Vac – 300 Vac \pm 5 Vac Bypass 80 Vac – 264 Vac
Nominal frequency	50 Hz / 60 Hz (automatic detection)
Frequency tolerance range	\pm 4 Hz
Current consumption at full load (max.)	
PROTECT C. 1000 (S)	7 A
PROTECT C. 2000	10 A
PROTECT C. 2000 S	12 A
PROTECT C. 3000 (S)	16 A
Input power factor	$\lambda \geq 0.96$
Connection	Non-heating appliance connector
Datalines	RJ11 (phone, fax, modem)
overvoltage protection	RJ45 (Ethernet 10/100MBit/s)

UPS Output (single phase)

Rated output voltage	220 / 230 / 240 Vac \pm 2 % (configuration via software "CompuWatch")
Nominal frequency	50 Hz / 60 Hz \pm 0,2 % (depending on mains)
Voltage waveform	Harmonic distortion \leq 4 % THD (linear load) \leq 7 % THD (non-linear load)

Connection	Non-heating appliance connectors
Current Crest Ratio	3:1
Overload behaviour in battery mode	up to 105 % ± 5 % continuous; > 105 % ± 5 % – < 150 % ± 5 % for 25 s; 150 % ± 5 % for 200 ms
Overload behaviour with existing mains	up to 105 % ± 5 % continuous; > 105 % ± 5 % – < 150 % ± 5 % for 30 s; 150 % ± 5 % for 300 ms Then automatic inverter to Bypass in < 4 ms (switches back when overload damps = Load < 90%)
Short circuit behaviour	3 x I _N for 140 ms

Battery

Autonomy time (full load with internal battery)

PROTECT C. 1000	6 min
PROTECT C. 2000	10 min
PROTECT C. 3000	5 min

Autonomy time with external optional battery expansions (only for PROTECT C. – models):

Coupled battery modules	Autonomy time (full load)		
	C. 1000	C. 2000	C. 3000
1	38 min	55 min	30 min
2	76 min	106 min	60 min

Rated direct voltage (intermediate circuit)

PROTECT C. 1000 (S)	36 V
PROTECT C. 2000 (S)	96 V
PROTECT C. 3000 (S)	96 V

Battery charging current (max.)	
PROTECT C. 1000	1 A
PROTECT C. 1000 S	7 A
PROTECT C. 2000	1 A
PROTECT C. 2000 S	9.6 A
PROTECT C. 3000	1 A
PROTECT C. 3000 S	9.6 A
Recharge time (to 90% of rated capacity)	~ 5 h (with internal battery only) ~ 24 h (with 1 battery expansion) ~ 40 h (with 2 battery expansions)
Battery type	Sealed, maintenance-free
PROTECT C. 1000	12 V 7.2 Ah x 3
PROTECT C. 2000	12 V 7.2 Ah x 8
PROTECT C. 3000	12 V 7.2 Ah x 8
PROTECT C. 1000BP	12 V 7.2 Ah x 3 x 2
PROTECT C. 2030BP	12 V 7.2 Ah x 8 x 2
	“S” versions with increased battery charger for charging external battery systems (no integrated battery)

Communication

Ports	RS232 SUB-D (9-pin) additional: communication slot for expansion (e.g. AS/400, USB, SNMP, ...)
Shutdown Software on CD	“CompuWatch” for all popular operating systems like Windows, Linux, Mac, Unix, FreeBSD, Novell, Sun

General data

Classification VFI SS 211 acc. to IEC 62040-3
Double conversion technology

Overall efficiency AC-AC (full load)

PROTECT C. 1000 (S) $\geq 85\%$

PROTECT C. 2000 (S) $\geq 85\%$

PROTECT C. 3000 (S) $\geq 88\%$

Noise level (1m distance)

PROTECT C. 1000 (S) < 45 dB (A)

PROTECT C. 2000 (S) < 50 dB (A)

PROTECT C. 3000 (S) < 50 dB (A)

Type of cooling

Forced cooling
by variable speed fans

Operating temperature range

0°C to +40°C
Recommendation +15°C to
+25°C (due to battery
system)

Storage temperature range

0°C to +40°C

Relative humidity

$< 95\%$, non-condensing

Max. site altitude

up to 1000 m above sea level
If the UPS is installed or used
in a place where the altitude is
above than 1000m, the output
power has to be reduced:

Altitude (m)	1000	1500	2000	2500	3000
Derating Power	100%	95%	90%	85%	80%

Outlets

PROTECT C. 1000 (S) 4 x IEC 320-10A

PROTECT C. 2000 (S) 6 x IEC 320-10A

PROTECT C. 3000 (S) 4 x IEC 320-10A
+ 1 x IEC 320-16A

Equipment colour

Black line

Weights:

PROTECT C. 1000	15 kg
PROTECT C. 1000 S	8 kg
PROTECT C. 1000 BP	19 kg
PROTECT C. 2000	34 kg
PROTECT C. 2000 S	15 kg
PROTECT C. 3000	35 kg
PROTECT C. 3000 S	16 kg
PROTECT C. 2030 BP	52 kg

Dimensions W x H x D:

PROTECT C. 1000 (S)	145 mm x 220 mm x 400 mm
PROTECT C. 1000 BP	145 mm x 220 mm x 400 mm
PROTECT C. 2000 (S)	192 mm x 340 mm x 460 mm
PROTECT C. 3000 (S)	192 mm x 340 mm x 460 mm
PROTECT C. 2030 BP	192 mm x 340 mm x 460 mm

Guidelines

The PROTECT C. complies with the product norm EN 50091.

The CE symbol on the unit certifies the compliance to the EG guidelines for 73/23 EEC low voltage and for 89/336 EEC electromagnetic compatibility (EMC), when following the installation instructions in the manual.

For the 73/23 EEC low voltage guidelines

Reference number EN 62040-1-1 : 2003

For 89/336-EMC guidelines

Reference number EN 50091-2 : 1995

EN 61000-3-2 : 1995

EN 61000-3-3 : 1995

4 Set-Up and Operation

4.1 Unpacking and Inspection

The device has been fully tested and inspected. Although the device has been packed and shipped with the usual degree of care, damage during transport cannot be ruled out completely.

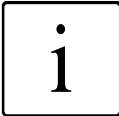

Claims for damage during transport must always be made with the transport company!

Check the shipping container for damage on arrival. If necessary, ask the transport company to check the goods and make a record of the damage in the presence of the member of staff from the transport company. Don't turn on the unit and register the damage with the AEG representative or dealer immediately.

Check the delivery is complete:

- ◆ PROTECT C.(S) with 1000, 2000 or 3000 VA
- ◆ Mains connection cable with shockproof plug
- ◆ Three load connection cables (10 A)
- ◆ Communication cable
- ◆ CD with "CompuWatch" shutdown software
- ◆ Operating instructions

Delivery of external battery modules includes:

- ◆ External battery unit
- ◆ Special battery connection cable

Please contact our hotline (see page 4) in case of any discrepancy.

The original packaging provides effective protection against mechanical shocks and should be retained so the unit can be transported safely later on.



Please keep the plastic packaging bags away from babies and children in order to safeguard against suffocation accidents.



Handle the components with care. Please take into account the weight. It may be necessary to engage the help of a second person, particularly in the case of the 2 and 3 kVA models and if there are external battery units.

4.2 Point of Installation

PROTECT C. is designed to be installed in a protected environment. When installing the unit, pay attention to such factors as sufficient ventilation and suitable ambient conditions.



PROTECT C. is air-cooled. Do not obstruct the air vents!

The UPS and in particular its external battery modules should preferably be operated at room temperature (between 15°C and 25°C).

Install the units in a room that is dry, relatively dust-free and free of chemical vapours.

Make sure that no magnetic storage media are stored and/or operated close to PROTECT C.



Check the nameplate to make sure the voltage and frequency data correspond to the values applicable to your loads.

4.3 Overview: Connections, Operating / Display Elements

4.3.1 Front view

PROTECT C.1000 (S)



PROTECT C.2000 (S)



PROTECT C.3000 (S)



PROTECT C.1000 BP



PROTECT C.2030 BP



4.3.2 Display

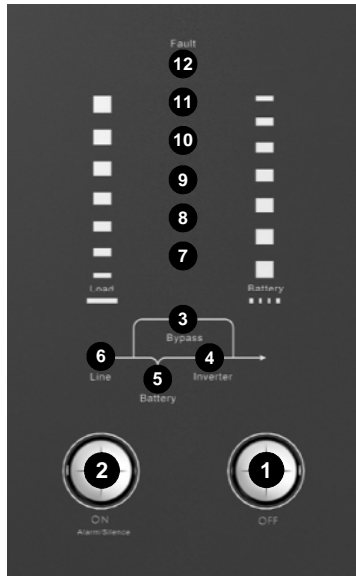

Explanations:

1. OFF-Pushbutton (OFF)
2. ON-Pushbutton (ON) / Alarm off
3. Orange LED bypass (Bypass)
4. Green LED inverter (Inverter)
5. Orange LED for battery (Battery)
6. Green LED for utility power (Line)
7. - 11. Bar graph LEDs (7-10 green / 11 orange) for UPS battery utilization respectively capacity (remaining autonomy time)
 7. LED load (0-35%) battery capacity (96-100%)
 8. LED load (36-55%) battery capacity (76-95%)
 9. LED load (56-75%) battery capacity (51-75%)
 10. LED load (76-95%) battery capacity (26-50%)
 11. LED load (96-105%) battery capacity (0-25%)
12. Red LED fault (Fault)

You will find detailed explanations of the displays on page 35.

4.3.3 Rear view (connections):

PROTECT C. 1000 (S)

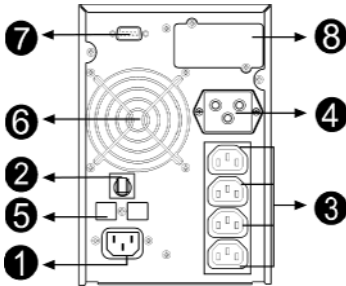

PROTECT C. 2000 (S)

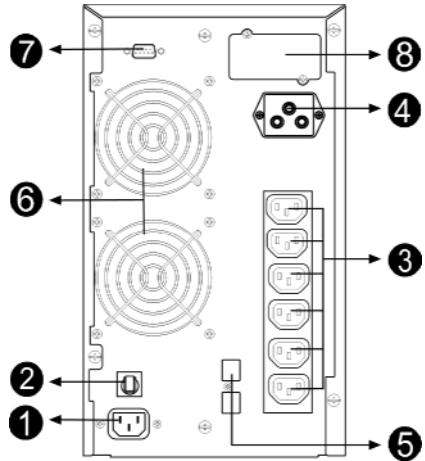

PROTECT C. 3000 (S)

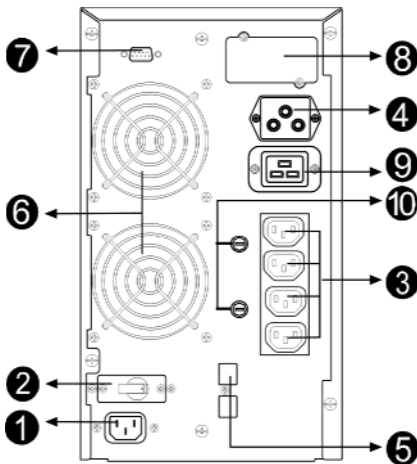

Comments:

1. Mains connection (UPS input)
2. Mains input circuit breaker
3. Load connections (UPS outputs)
PROTECT C. 3000 (S) with additional load connection (IEC 320-16A)
4. Connection for external battery module
5. Data interface for telephone, modem fax (RJ11) or 10/100 MBit/s network (RJ45)
6. Vent (Attention: At least 10 cm of free area are required behind the vent for free ventilation!)
7. Communication interface RS232 (9-pin SUB-D socket)
8. Communication slot for optional expansion cards: SNMP, USB, AS/400
9. Outlet 16A (only for PROTECT C. 3000 (S))
10. 2 circuit breaker for a pair of non-heating outlet appliance connectors (only PROTECT C. 3000 (S))

5 Commissioning

5.1 Mechanical Set-Up

Note the following points when setting up the UPS system and its external battery units (special accessories):

- ◆ The contact surface must be smooth and level. It must also be sufficiently strong and sturdy to avoid vibration and shock loads.
- ◆ Make sure the mounting is able to support the weight: This is particularly important in conjunction with external battery units (special accessories).
- ◆ Set up the units so that adequate air circulation is assured. There must be at least 100 mm clearance at the back for ventilation purposes. Do not block the intake openings on the front and, if present, on the side of the unit. There must be a gap of at least 50 mm here.
- ◆ Set up external battery units (special accessories) to the side of the UPS system. To ensure the greatest possible mechanical stability, you should not set up the external battery unit(s) above or below the UPS system.
- ◆ Avoid extreme temperatures! We recommend an ambient temperature of 15 °C to 25 °C in order to maximise the service life of the batteries. Do not expose the units to direct sunlight or operate them close to other heat sources such as radiators.
- ◆ Protect the units against external effects (in particular moisture and dust). In this regard, please also refer to the instructions in chapter 4.2, page 20 in these operating instructions.

If you transport the unit from a cold room into a warm one, or if the room temperature suddenly drops then condensation may form inside the unit. To avoid any damage due to condensation, leave the unit to acclimatise for 2 hours before you switch it on.

5.2 External Battery Expansions

To achieve longer backup time, it is possible to connect multi-battery packs. Connect **exclusively** the following products together:

PROTECT C. 1000	with	PROTECT C. 1000 BP
PROTECT C. 2000	with	PROTECT C. 2030 BP
PROTECT C. 3000	with	PROTECT C. 2030 BP

PROTECT C. with 1 battery expansion

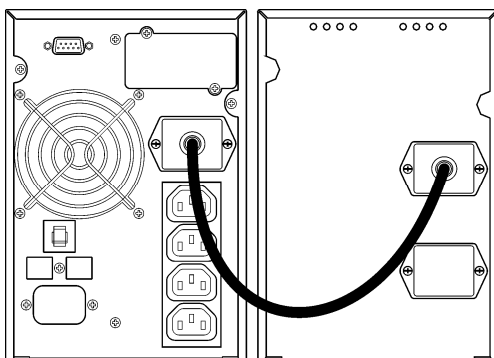

Fig.: PROTECT C. 1000 and C. 1000BP

1. Check the correct fit of the UPS and the battery unit (the casings e.g. have to have the same dimension).
2. Now connect both battery connectors using the supplied battery connection cable. When connecting, make sure that you push the plug quickly and firmly in the battery connectors.

PROTECT C. with 2 battery expansions

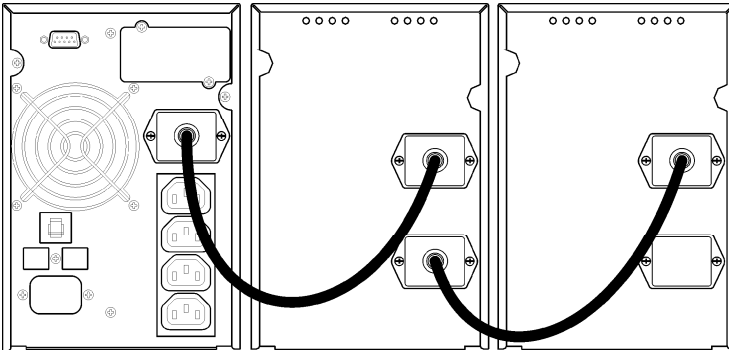

Fig.: PROTECT C. 1000 and two C. 1000BP

1. Check the correct fit of the UPS and the battery unit (the casings e.g. have to have the same dimension).
2. Now connect the corresponding battery connectors using the supplied battery connection cables as shown in the figure above. When connecting, make sure that you push the plug quickly and firmly in the battery connectors.

5.2.1 Electrical Start-Up

Verify that UPS voltage of your country corresponds to your equipment voltage. The default setting is set to 230 V. Output voltage on the UPS system can be adjusted with the software "CompuWatch" in steps of 220 Vac, 230 Vac and 240 Vac.

Turn on the PROTECT C. to the mains

1. Now connect the input of the UPS to the mains connection cable provided and plug the mains connector into a suitable shockproof socket. Avoid using extension cables and / or adapters. In particular in the case of high-capacity types, ensure that the fusing in your sub-distribution is adequately dimensioned: The 3kVA system for example requires its own connection with a 16 A fuse. No other loads should be connected to this circuit!
2. Activate the mains input circuit breaker. If necessary switch it to "ON".

i

Default setting: No automatic supply for load over integrated bypass after executing step 1 and 2 (Modification of the configuration with the provided Software "CompuWatch").

3. Then connect the outputs of your UPS to your loads. Use the load connection cables provided for this. **Don't switch on the loads yet.** Please contact your dealer if you require additional load connection cables.
4. Now switch on the UPS. To do this, press and hold the UPS ON switch for about 2 seconds.
5. When being powered on, the UPS will perform self-diagnosis, the Load/Battery level LEDs will be turned on and then off one after another in ascending order. After synchronising the inverter successfully the LED "Inverter" will go on after some seconds, with the UPS in normal mode. If the power supply is in order (mains within the range) an additionally the LED "Line" will go on. If this LED is flashing, the phase and neutral of the UPS are exchanged. In this case turn the mains connector 180° in the shockproof socket.

i

Please shut down the entire system if you cannot solve any problems which occur. Press the OFF button for about 2 seconds. Disconnect the UPS from the mains by pulling the mains connector. Please contact our hotline (s.p. 4).

6. When all displays are lit as described, switch on your loads one after the other. Note the maximum permitted UPS load when doing this. Keep in mind that especially loads like laser printers and big CTRs have high power consumption and can cause an overload of the UPS quickly.

i

Behaviour when switching on / off:

The behaviour after switching on (On-Pushbutton) or off (Off-Pushbutton) the UPS can be defined with the Software "CompuWatch": Activation of the automatic bypass or either deactivation (latter = factory-made presetting).

5.3 Operating Statuses

5.3.1 Normal Operation

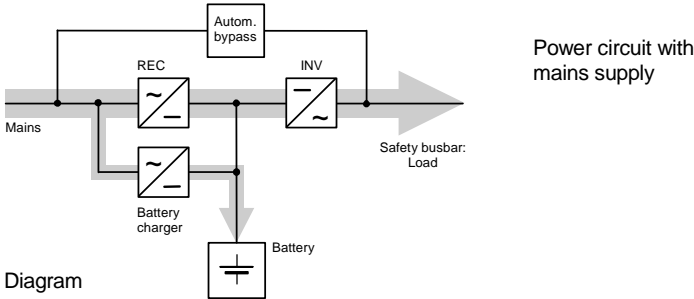

Once you have connected the UPS to a suitable mains connection, you can start operation using the UPS main switch (see also "Electrical Start-Up" on page 27). Normally, the UPS operates continuously. The UPS now supplies the output with voltage, this being signalled by the symbols mains (LED Line) and rectifier (LED Inverter) symbols which light up permanently.

This is often referred to as "online" mode. It offers the greatest protection, in particular when there are mains fluctuations and mains failures, because the loads are supplied continuously with voltage with no interruptions in this operating mode.

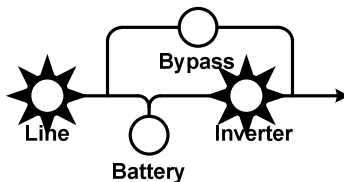

The LED bar graph (LED chain above the pictogram) show during operation the actual utilization of the UPS (s. chapter 6, page 35).

5.3.2 Battery Operation / Autonomy Operation

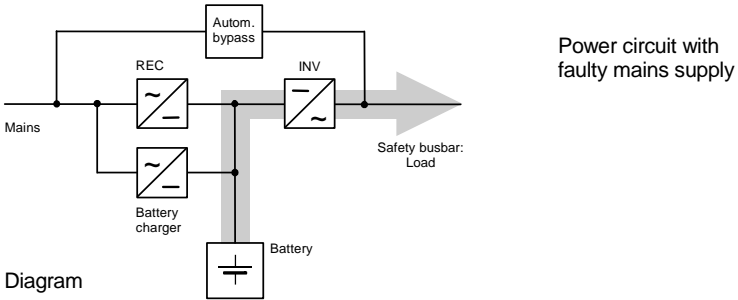

The mains is not within the required tolerance range or has failed. In this case power is supplied to the inverter from the charged battery without interruption. The power supply to the loads is therefore also ensured in the event of a mains failure. This drains the capacity of the battery and it is discharged. This status is signalled by the battery symbol (LED Battery) lighting up, as well as an intermittent acoustic signal every 4 seconds and every second before switching off. This can be suppressed by pressing the “Alarm off” button. With decreasing battery capacity the alarm is activated automatically. Depending on the expansion level, age and condition of the battery and in particular on the load to be supplied, the standby time can vary from a few minutes to several hours.

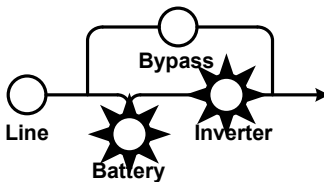

The LED bar graph (LED chain above the pictogram) show during operation the actual utilization of the UPS (s. chapter 6, page 35).

The inverter is switched off if the battery voltage drops below a factory-set minimum voltage value.

Never store the unit in this condition! The discharged battery system should be recharged within a week at the latest.

When the voltage and frequency are within the tolerance range once more, the rectifier and the battery charger switch back on automatically. The rectifier then continues supplying the inverter and the battery charger takes over charging the battery.

5.3.3 Bypass Operation

If the inverter is overloaded or if overtemperature is detected, e.g. also if an inverter defect is detected, voltage is supplied to the load via the bypass that switches on automatically. This is signalled by the bypass symbol.

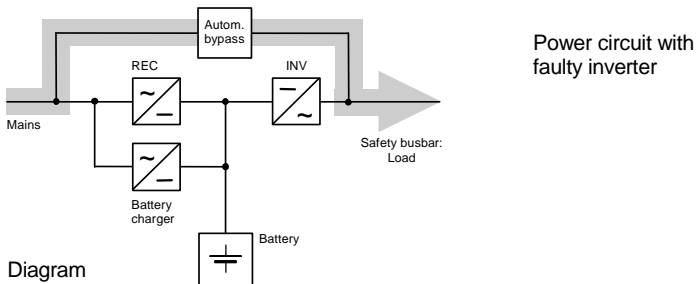

This function is also referred to as passive redundancy. It protects against total failure of the voltage supply on the protected busbar, however in the operating status that is now attained, mains faults would have a direct effect on the load.

As a result, the electronics continuously attempt to switch back to "online" / normal operating status (e.g. when the overload or overtemperature no longer applies).

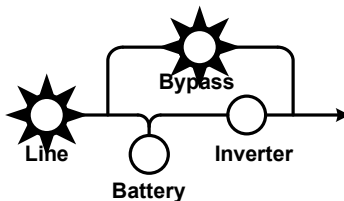

The bypass is a mechanical link that switches extremely rapidly. It is located between the load and the mains. The synchronisation unit ensures that the frequency and phase of the inverter voltage is synchronised with the mains.

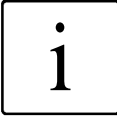

The LED bar graph functions as display for UPS utilisation. The signal goes off during this operations status every 2 seconds.

5.3.4 Unit Overload

The load on the UPS should never exceed the specified rated load of the unit. If a unit overload occurs nevertheless (from $105\% \pm 5\%$ of the specified unit rated load) the fault LED is turned on accompanied with a signal tone (twice per second). The connected loads continue to be supplied for a certain time depending on the level of the overload. However, the connected load must be reduced without delay.

Non-observance of the "Unit overload" condition may cause the total loss of all UPS functions!

Also avoid short-term unit overloads, which may, for example, occur when connecting a laser printer or laser fax machine. Do not connect any household appliances or machine tools to the UPS.



Never connect or switch on any additional loads to the UPS if there is a mains failure, i.e. if the UPS is working in emergency power operation!

As a rule, if there has never been an overload during normal operation, there will not be one during battery operation either.



The signalling of the fault LED in combination with a continuous alarm points out a switching of fault. Follow the instructions in chapter 6.

5.4 Interfaces and communication

5.4.1 Data line protection RJ11 and RJ45

The incoming data lines are connected to the “IN” line at the rear of the UPS. The “OUT” line is connected via data line with your terminal.



The data line protection supports networks with transfer rates between 10 and 100 MBit/s.

5.4.2 Computer interfaces RS232

The UPS offers various interfaces to manage the system and to comfortable readout state information and important parameters. The communication protocol is optimized for operation with the shutdown and UPS management software “CompuWatch” from AEG. To connect to the UPS to your computer use the provided RS232 communication cable by attaching them to a free serial port of your pc.

RS232 interface: The interface is connected via a 9 pole Sub-D connector on the back of the unit (pos. 4 p. 23 / 24).
PINS: 2 = TxD; 3 = RxD; 5 = GND.

5.4.3 Communication Slot

If the cover on the rear of the UPS is removed (pos. 8 p. 23/24), additional optionally available communication components can be installed there.

AS/400 board: Slot card with status messages, realised via potential-free relay contacts.

USB board: Slot card for communication via USB.

SNMP board: Slot card for direct connection of the UPS to the Ethernet network with RJ 45 (TCP/IP).

Details can be found in the description enclosed with the particular optional component. Other boards are in preparation.



Using the communication slot deactivates the RS232 interface of chapter 5.4.2.

5.4.4 Shutdown and UPS management software

The "CompuWatch" software specially developed for these purposes by AEG continuously checks the mains supply and the UPS status.



In conjunction with the "intelligent" UPS, this ensures that the availability of IT components and data security is guaranteed.

The "CompuWatch" shutdown software supports different operating systems: Windows 98SE/ME, Windows NT/2000/XP, Windows Vista, Linux, Novell Netware, IBM AIX, HP-UX, SUN Solaris, Mac OS X, and others.

Refer to the manual on the CD for details about installing the software on the various operating systems.

Download of Updates: www.AEGpartnet.com >> PRODUCTS >> Software >> CompuWatch

6 Signalling and Error Correction

6.1 Signalling

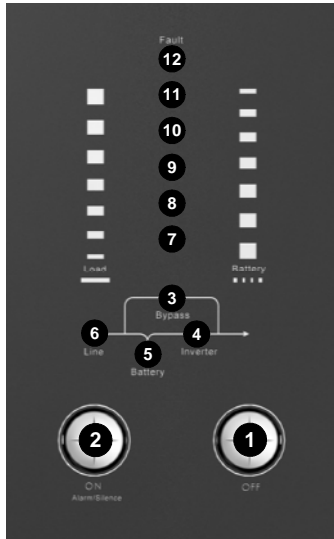

1. **OFF push button (OFF):** Press the OFF switch for about 2 seconds to switch on the UPS
2. **ON push button (ON):** Press the ON switch for about 2 seconds to switch off the UPS.
Deactivate **acoustic alarm**: By pressing this switch for about 2 seconds during the alarm an acoustic alarm can be deactivated.
UPS Test: To execute an UPS self test press this button for about 2 seconds in the normal operation mode.
3. **LED Bypass (Bypass):** The orange-coloured LED lights up when the UPS system is supplying voltage provided by the mains power via the bypass.
4. **LED Inverter (Inverter):** The green-coloured LED lights up if the UPS system is supplying voltage provided by the mains power via the inverter.
5. **LED Battery (Battery):** The orange-coloured LED lights up when power is supplied by the batteries.

6. **LED Line (Mains status):** The green LED lights up if mains voltage is in a specified range of tolerance. The LED Line flashes when the phase and neutral conductor have been reversed at the input of the UPS system. In this case turn the mains connector 180° in the shockproof socket.

7. -11. **LED Bargraph** for UPS battery utilization resp. capacity (remaining autonomy time)

These LEDs show the load of the UPS system if the mains power is available (normal operation):

11. orange LED	96% – 105%
10. green LED	76% – 95%
9. green LED	56% – 75%
8. green LED	36% – 55%
7. green LED	0% – 35%

In the battery operation, the LEDs indicate the capacity of the batteries:

11. orange LED	0% – 25%
10. green LED	26% – 50%
9. green LED	51% – 75%
8. green LED	76% – 95%
7. green LED	96% – 100%

12. **LED Fault:** The red LED lights up and an acoustic warning signal is issued continuously when the UPS system is in fault condition.

6.2 Fault Diagnosis / Fault Rectification

The PROTECT C. generates detailed error messages. Support personal can localise and interpret faults quickly and precisely.

6.2.1 Error Messages

Problem	Cause	Solution
UPS does not start. No indication, no audible signal even though system is connected to mains power supply.	Mains and battery voltage not in the tolerance range, possible battery deep discharge.	Check building wiring socket outlet and input cable.
LED "Line" flashes and audible signal sounding every 3 minutes.	Phase and neutral conductor at input of UPS system are reversed.	Rotate mains power socket by 180° or connect UPS system.
LED "Line" flashes and LED "Battery" lights up.	Input power and/or frequency are out of tolerance.	Check input power source (Voltage, frequency) and inform house electrician if necessary.
LED "Line" and LED "Bypass" light up even though the power supply is available. No supply of connected loads.	Inverter not switched on.	Press On-Switch "ON" for about 2 seconds.
LED "Inverter" and LED "Battery" lights up, and audible signal sounding every 4 seconds.	Mains power supply has failed. Automatic switch to battery mode.	Try to replace mains supply (possibly triggered fuse in sub distribution). When audible alarm sounding every second, battery is almost unloaded. At this point it is time to proceed with an system shutdown of all you IT equipment.
LED "fault" lights, audible signal once a second.	Overload of the UPS system.	Reduce utilizations of UPS by removing loads of UPS output.

Emergency supply period shorter than nominal value	Batteries not fully charged / batteries old resp. defect	Charge the batteries for at least for the charging time acc. Chapter 3.4, page 16 and then check capacity. If the problem still persists, consult your dealer.
LED "fault" lights, LED "Battery" flashes, audible signal once a second	Charger or Batteries damaged	Notify dealer!
LED "fault" lights up, permanent audible signal	UPS fault	Notify dealer!

If you cannot solve the problem that has occurred, stop the entire procedure, switch off the UPS and disconnect the connector from the socket. Please contact our hotline in this case (see page 4).

Please have the serial number of the unit as well as the purchase date to hand in this case. The hotline will provide you with technical support and can inform you about further procedures once you have described the problem.

7 Maintenance

The PROTECT C. consists of advanced and resistant components. To guarantee a continuous and high availability it is recommended to check the unit (especially the batteries and the fans) in regular intervals (at least every 6 months).



CAUTION:
Follow safety and security regulations unconditionally!

7.1 Charging the Battery

The battery is automatically charged when the mains is present, irrespective of the operating mode. This is signalled by the "Line" LED lighting up (see also chapter 6).

The complete charging time of the battery after a length discharge period depends, above all, on the number of additional external battery units.

Charging time up to 90% of rated capacity

Only with internal UPS battery	approx.	5 hours
One additional battery unit	approx.	24 hours
Two additional battery units	approx.	40 hours

7.2 Maintenance

The following maintenance work should be performed:

Task	Interval	Described in
Visual check	6 months	Chapter 7.2.1
Battery/fan check	6 months	Chapters 7.2.2 / 7.2.3

7.2.1 Visual Check

When visually checking the unit, check whether:

- ◆ there is any mechanical damage or foreign bodies can be found in the system,
- ◆ any conductive dirt or dust has accumulated in the unit,
- ◆ accumulation of dust affects heat supply and dissipation.



CAUTION:

PROTECT C. must be disconnected from the power supply prior to carrying out the following work.

If large quantities of dust have accumulated, the unit should, as a precaution, be cleaned with dry compressed air, in order to ensure adequate heat dissipation.

The intervals at which visual checks should be performed are largely determined by the site conditions.

7.2.2 Checking the Battery

Progressive ageing of the battery system can be detected by regular capacity checks. Every 6 months, perform measurements to compare the achievable standby times, e.g. by simulating a mains failure. In this case, the load should always have approximately the same capacity demand. Please contact our hotline if the time drops drastically compared to the previous measurement (see page 4).

7.2.3 Fan Checking

Regularly check the fans for dust build-up and noticeably untypical noise development. Clean the intake openings if they are blocked. Contact our hotline if a fan is running unusually loud or irregularly (see page 4).

8 Storage, Dismantling and Disposal

8.1 Storage



Long storage times without charging or discharging the battery at regular intervals may lead to permanent damage of the battery.

If the battery is stored at room temperature (20° C to 30° C) it will automatically discharge at a rate of 3 - 6% per month due to internal reactions. Storing the battery at temperatures above room temperature should be avoided. A high storage temperature also means greater battery self-discharge.

Batteries that are stored at room temperature should be recharged every six months to maintain their full capacity and service life.

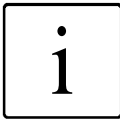

Connect PROTECT C. to the mains before putting it into storage, in order to make sure that the battery is fully charged. The charging time should at least match the time specified in chapter 7.1 Charging the Battery on page 39.

8.2 Dismantling

The system is dismantled in reverse order of the installation instructions.

8.3 Disposal

In the interest of environmental protection and recycling, please dispose of the individual system components in accordance with the regulations and legal guidelines when permanently taking the system out of operation. Please consider that infringements to these regulations may result in civil or criminal prosecution.

9 Glossary

9.1 Technical terms

Class D, Class III	see equipment protection
DC/DC Booster	Circuit technology to boost the direct voltage on a higher voltage level
Equipment protection	Technology term of the surge voltage protection: the conventional surge voltage protection consists of a lightning current protection (class B, class I), a surge voltage protection (class C, class II) and an equipment protection (class D, class III) – see also e.g. http://www.phoenixcontact.de (topic „TRABTECH“)
IGBT	<u>I</u> nsulated <u>G</u> ate <u>B</u> ipolar <u>T</u> ransistor The latest design of high-performance transistors with minimum control power requirement (MOSFET structure) and minimum losses on the output side (structure of a bipolar transistor)
LED	<u>L</u> ight <u>E</u> mitting <u>D</u> iode Electronic semiconductor component, commonly called light diode. Used for optical signalling.
PFC	<u>P</u> ower <u>F</u> actor <u>C</u> orrection Circuit technology for sine-wave input current; less mains distortion (important for non linear loads)
PWM	<u>P</u> ulse <u>W</u> idth <u>M</u> odulation Here: Circuit technology for generating a sinusoidal voltage of the highest quality from an existing DC voltage
SNMP	Simple Network Management Protocol common protocol in networks to manage / control appliances
VFD	<u>O</u> utput <u>V</u> oltage and <u>F</u> requency <u>D</u> ependent from mains supply The UPS output depends of mains voltage and frequency variations. Former notation: OFFLINE
VI	<u>O</u> utput <u>V</u> oltage <u>I</u> ndependent from mains supply The UPS output is independent of mains voltage and frequency variations. The mains voltage however is rectified by electronic / passive voltage regulators. Former notation: LINE-INTERACTIVE
VFI	<u>O</u> utput <u>V</u> oltage and <u>F</u> requency <u>I</u> ndependent from mains supply The UPS output is independent of mains voltage and frequency variations. Former notation: ONLINE

Guarantee certificate

Type:

Serial-no.:

Date of purchase:

Trading stamp / Signature

Specifications are subject to change without notice.

AEG

Power Solutions

AEG Power Solutions GmbH

Emil-Siepmann-Straße 32

59581 Warstein-Belecke

Germany

Operating Instructions

BAL 8000019812_01 EN

Free Manuals Download Website

<http://myh66.com>

<http://usermanuals.us>

<http://www.somanuals.com>

<http://www.4manuals.cc>

<http://www.manual-lib.com>

<http://www.404manual.com>

<http://www.luxmanual.com>

<http://aubethermostatmanual.com>

Golf course search by state

<http://golfingnear.com>

Email search by domain

<http://emailbydomain.com>

Auto manuals search

<http://auto.somanuals.com>

TV manuals search

<http://tv.somanuals.com>