

LAVAMAT 52840



Instruction booklet

Washing machine

AEG

PERFEKT IN FORM UND FUNKTION

Electrolux

Download from www.Somanuals.com. All Manuals Search And Download.

Dear Customer

Thank you for choosing one of our high-quality products.

With this appliance you will experience the perfect combination of functional design and cutting edge technology.

Convince yourself that our appliances are engineered to deliver the best performance and control - indeed we are setting the highest standards of excellence.

In addition to this you find environmental and energy saving aspects as an integral part of our products.

To ensure optimal and regular performance of your appliance please read this instruction manual carefully. It will enable you to navigate all processes perfectly and most efficiently.

To refer to this manual any time you need to, we recommend you to keep it in a safe place. And please pass it to any future owner of the appliance.

We wish you much joy with your new appliance.

The following symbols are used in this manual:



Important information concerning your personal safety and information on how to avoid damaging the appliance



General information and tips



Environmental information

Contents

Instruction booklet	6
Safety information	6-8
Product description	9
Detergent dispenser drawer	9
Control panel	10
First use	10
Daily use	11
Load the laundry	11
Measure out the detergent and the fabric softener	11
Select the required programme	12
Select the spin speed or the Rinse Hold option	12
Programm option button	13
Select the Stain option	13
Select the Extra Quick	14
Select the Start/Pause	14
Select the Delay Start	15
Programme progress display	15
Select an additional rinse	16
Altering an option or a running programme	16
Interrupting a programme	16
Cancelling a programme	16
Opening the door after the programme has started	16
At the end of the programme	17
Washing programmes	18-19
Programme informations	20

Preparing the wash cycle	21-25
Sorting out the laundry	21
Temperatures	21
Before loading the laundry	21
Maximum loads	22
Laundry weights	22
Removing stains	23
Detergents and additives	24
Quantity of detergent to be used	24
Degrees of water hardness	25
International wash code symbols	26
Care and cleaning	27
Descaling	27
After each wash	27
Maintenance wash	27
External cleaning	27
Detergent dispenser drawer	27
Washing drum	28
Door seal	28
Drain pump	29
Water inlet filter	30
Emergency emptying out	30
Frost precautions	31
Something not working	32-35
Technical Data	36
Consumption value	37

Installation	38-42
Unpacking	38
Positioning and levelling	40
Water inlet	40
Water drainage	41
Electrical connection	42
Permanent connection	42
Enviroment concerns	43
Packaging materials	43
Old machine	43
Ecological hints	43
Guarantee	44
Customer service centres	45

Instruction booklet

Safety information

Prior to using for the first time

- The safety of AEG/ELECTROLUX appliances complies with the industry standards and with legal requirements on the safety of appliances. However, as manufacturers, we feel it is our duty to provide the following safety notes. You **MUST** read them carefully before installing or using the appliance.
- It is most important that this instruction book should be retained with the appliance for future reference. Should the appliance be sold or transferred to another owner, or should you move house and leave the appliance, always ensure that the book is supplied with the appliance in order that the new owner can get to know the functioning of the appliance and the relevant warnings.
- You **MUST** read them carefully before installing or using the appliance.
- Before first starting up, check the machine for any damage incurred during transport. Never connect up a damaged machine. If parts are damaged, contact your supplier.
- If the appliance is delivered in the winter months when there are minus temperatures: Store the washing machine at room temperature for 24 hours before using for the first time.

General safety

It is dangerous to alter the specifications or attempt to modify this product in any way.

During high temperature wash programmes the door glass may get hot. Do not touch it!

Make sure that small pets do not climb into the drum. To avoid this, please check into the drum before using.

Any objects such as coins, safety pins, nails, screws, stones or any other hard, sharp material can cause extensive damage and must not be placed into the machine.

Only use the advised quantities of fabric softener and detergent. Damage to the fabric can ensue if you over-fill. Refer to the manufacturer's recommendations of quantities.

Wash small items such as socks, laces, washable belts etc in a washing bag or pillow case as it is possible for such items to slip down between the tub and the inner drum.

Do not use your washing machine to wash articles with whalebones, material without hems or torn material.

Always unplug the appliance and turn off the water supply after use, clean and maintenance.

Under no circumstances should you attempt to repair the machine yourself. Repairs carried out by inexperienced persons may cause injury or serious malfunctioning. Contact your local Service Centre. Always insist on genuine spare parts.

Installation

This appliance is designed for domestic use. It must not be used for purposes other than those for which it was designed.

When unpacking the appliance, check that it is not damaged. If in doubt, do not use it and contact the Service Centre.

All packing and transit bolts must be removed before use. Serious damage can occur to the product and to property if this is not adhered to. See relevant section in the user manual.

After having installed the appliance, check that it is not pressing or standing on its electrical supply cable, inlet hose and drain hose.

If the machine is situated on a carpeted floor, please adjust the feet in order to allow air to circulate freely

Always be sure, that there is no water leakage from hoses and their connections after the installation.

If the appliance is installed in a location subject to frost, please read the "**dangers of freezing**" chapter.

Any plumbing work required to install this appliance should be carried out by a qualified plumber or competent person.

Any electrical work required to install this appliance should be carried out by a qualified electrician or competent person.

Use

This appliance is designed for domestic use. It must not be used for purposes other than those for which it was designed.

Only wash fabrics which are designed to be machine washed. Follow the instructions on each garment label.

Do not overload the appliance. See the relevant section in the user manual.

Before washing, ensure that all pockets are empty and buttons and zips are fastened. Avoid washing frayed or torn articles and treat stains such as paint, ink, rust, and grass before washing. Underwired bras must NOT be machine washed.

Garments which have been in contact with volatile petroleum products should not be machine washed. If volatile cleaning fluids are used, care should be taken to ensure that the fluid is removed from the garment before placing in the machine.

Never pull the power supply cable to remove the plug from the socket; always take hold of the plug itself.

Never use the washing machine if the power supply cable, the control panel, the working surface or the base are damaged so that the inside of the washing machine is accessible.

Child Safety

This washing machine is not intended for use by young children or infirm persons without supervision.

Young children should be supervised to ensure that they do not play with the appliance.

The packaging components (e.g. plastic film, polystyrene) can be dangerous to children - danger of suffocation! Keep them out of children's reach.

Keep all detergents in a safe place out of children's reach.

Make sure that children or pets do not climb into the drum. To avoid this the machine incorporates special feature. To activate this device, rotate the button (without pressing it) inside the door clockwise until the groove is horizontal. If necessary use a coin. To disable this device and restore the possibility of closing the door, rotate the button anti-clockwise until the groove is vertical.

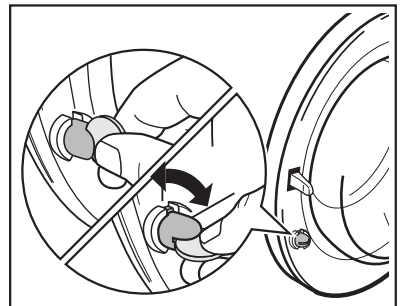

Product description

Your new appliance meets all modern requirements for effective treatment of laundry with low water, energy and detergent consumption.

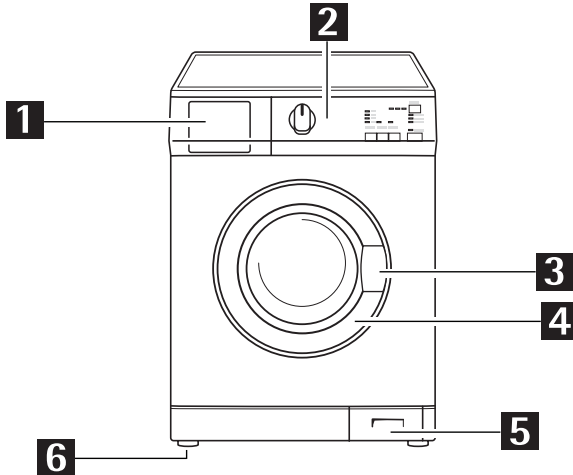

The **ECO valve** system allows total use of detergent and reduces water consumption so saving energy.

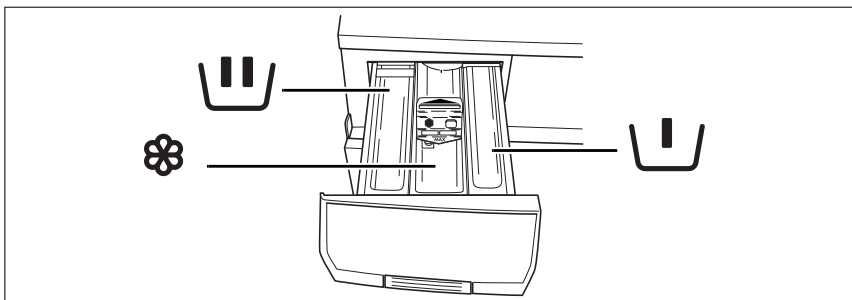

- | | | | |
|----------|----------------------------|----------|-----------------|
| 1 | Detergent dispenser drawer | 4 | Rating plate |
| 2 | Control panel | 5 | Drain pump |
| 3 | Door opening handle | 6 | Adjustable feet |

Detergent dispenser drawer



-  Compartment for prewash phase or stain remover used for **main wash**. The prewash detergent is added at the beginning of the wash programme. The stain remover is added during the **STAIN-Action phase** in the main wash.
-  Compartment for powder or liquid detergent used for **main wash**.
-  Compartment for **liquid additives** (fabric softener, starch).

Control panel

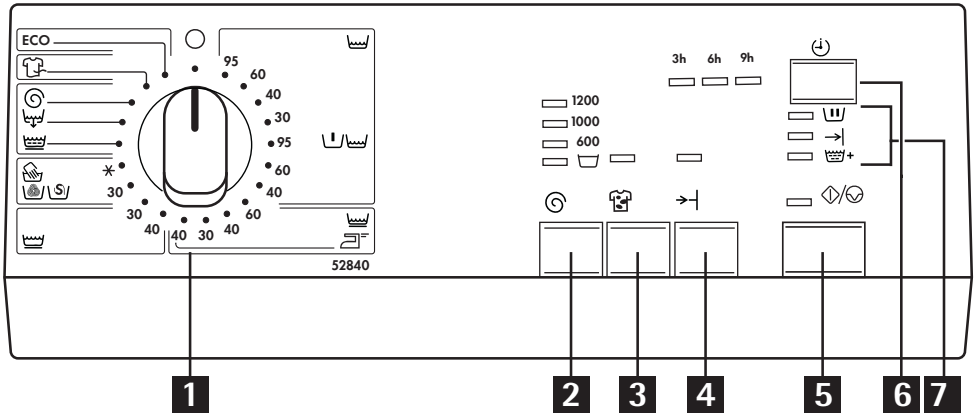

- | | |
|----------------------------------|-------------------------------------|
| 1 Programme selector dial | 6 «Delay start» button |
| 2 Spin reduction button | 7 Programme progress display |
| 3 «Stain» button | |
| 4 «Extra quick» button | |
| 5 «Start/Pause» button | |

First Use

- i** Ensure that the electrical and water connections comply with the installation instructions.
- i** Remove the polystyrene block and any material from the drum.
- i** Pour 2 litres of water into the main wash compartment (III) of the detergent drawer in order to activate the ECO valve. Then run a cotton cycle at 95°C, without any laundry in the machine, to remove any manufacturing residue from the drum and tub. Pour 1/2 a measure of detergent into the dispenser drawer and start the machine.

Daily Use

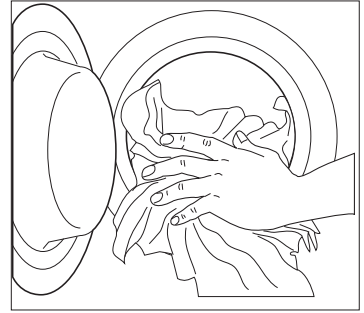

Load the laundry

1. Open the door by carefully pulling the door handle outwards. Place the laundry in the drum, one item at a time, shaking them out as much as possible.
2. Close firmly the door. You must hear a click during closing.
Attention! Do not embed the laundry between the door and the rubber joint.



Measure out the detergent and the fabric softener

Your new appliance was designed to reduce water, energy and detergent consumption.

1. Pull out the dispenser drawer until it stops. Measure out the amount of detergent required, pour it into the main wash compartment  and, if you wish to carry out the **prewash** phase or to perform the **stain** function, pour the detergent or the stain remover into the compartment marked .
2. If required, pour fabric softener into the compartment marked  (the amount used must not exceed the **MAX** mark in the drawer). Close the drawer gently.

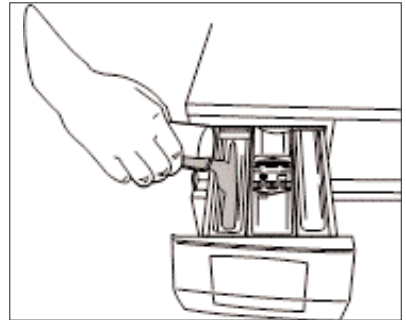

Select the required programme

You can choose the right programme for any type of laundry following the descriptions on the washing programme tables (see Washing Programmes).

Turn the programme selector dial to the required programme. The programme selector determines the type of washing cycle (e.g. water level, drum movement, number of rinses) and the washing temperature according to the type of laundry.

✱ = Cold Wash

The light **Start/Pause** starts to flash.

The selector dial is divided into following sections:

Cottons 

Synthetics 

Delicates 

Wool , Handwash , Silk 

Special programme: Rinses , Drain , Spin 

Refresh 

Economy programme (**ECO**)

The selector dial can be turned either clockwise or anticlockwise. Position **O** to Reset programme/ Switching OFF of the machine.

At the end of the programme the selector dial must be turned to position O, to switch the machine off.

Attention!

If you turn the programme selector dial to another programme when the machine is working, the red **Start/Pause** pilot light will flash 3 times to indicate a wrong selection. The machine will not perform the new selected programme.

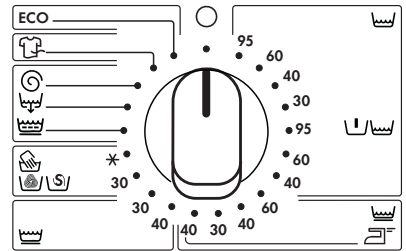



Select the spin speed or the rinse hold option

Press the **Spin** button repeatedly to change the spin speed, if you want your laundry to be spun at a speed different from the one proposed by the washing machine.

The relevant light will light up.

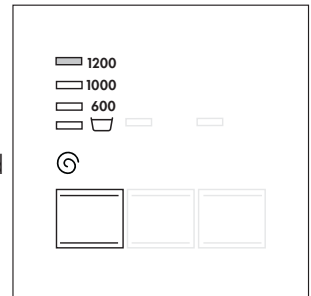
Maximum speed is 1200 rpm for all type of fabrics.



Rinse Hold : by selecting this option the water of the last rinse is not emptied out to prevent the fabrics from creasing. When the programme has finished the pilot lights →| (End) goes on, the **Start/Pause** light and the **functioning**  pilot light are off and the door is blocked to indicate that the water must be emptied out.

To empty the water out:

turn the programme selector dial to **O**

select the  (Drain) or  (Spin)

reduce the spin speed if needed, by means of the relevant button

press **Start/Pause** button

when the programme has finished only the pilot lights →| (End) comes on.

Programme option button

Depending on the programme, different functions can be combined. These must be selected after choosing the desired programme and before depressing the **Start/Pause** button.

When these buttons are pressed, the corresponding pilot lights come on. When they are pressed again, the pilot lights go out.

If an incorrect option is selected, an integrated yellow pilot light of the **Start/Pause** button flashes for 3 times.

Important!

For the compatibility among the washing programmes and the options see chapter **Washing Programmes**.

Select the Stain option

To treat heavily soiled or stained laundry with stain remover (extended main wash with time optimised stain action phase).

Attention! If you wish to perform a programme with the stain option, pour stain remover into compartment .

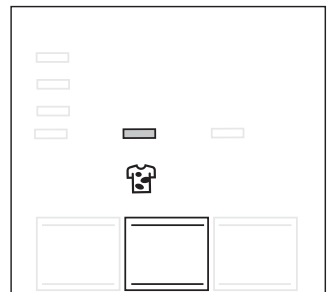

Select the Extra Quick →| option

By pressing this button, the relative pilot light comes on and the washing duration will be reduced to wash lightly soiled laundry. This option is suitable for items that have been used or worn for a short time.

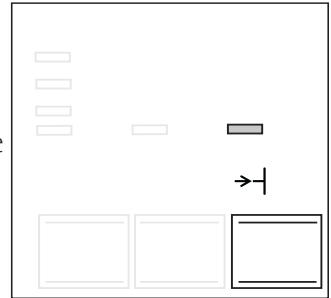

Select the «Start/Pause» ⏪/⏩ button

To start the selected programme, press the **Start/Pause** button; the corresponding red pilot light stops flashing.

The **functioning** |II light is on to indicate that the appliance starts operating and the door is locked.

To interrupt a programme which is running, depress the **Start/Pause** button: the corresponding red pilot light starts to flash.

To restart the programme from the point at which it was interrupted, **press** the **Start/Pause** button **again**.

If you have chosen a delayed start, the machine will begin the countdown.

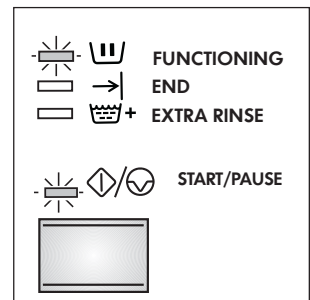

Select the Delay Start

Before you start the programme, if you wish to delay the start, press the Delay Start button repeatedly, to select the desired delay. The relevant light illuminates.

This button makes it possible to delay the starting of the washing programme by 3, 6, and 9 hours.

You must select this option after you have set the programme and before you press the **Start/Pause** button.

You can cancel the delay time at any moment, before you press the **Start/Pause** button. If the **Start/Pause** button has already been pressed:

set the washing machine to PAUSE by pressing the **Start/Pause** button;

press the **Delay Start** button once, the light relevant to the selected delay goes off;

press the **Start/Pause** button again to start the programme.

Important!

The selected delay can be changed only after selecting the washing programme again.

The door will be locked throughout the delay time. If you need to open the door, you must first set the washing machine to PAUSE by pressing the **Start/Pause** button and then wait some minutes. After you have closed the door, press the Start/Pause button again.

The **Delay Start** can not be selected with Drain  programme.

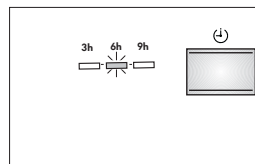

Programme progress display

After having pressed the **Start/Pause** button, the **functioning**  pilot lights comes on.

When the pilot light **functioning** comes on this means that the machine is performing the washing cycle.

When the programme has finished, the **end**  pilot light comes on.

When the appliance is performing additional rinses the **extra rinse**  pilot light comes on.

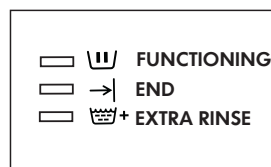

Select an additional rinse

This appliance is designed for saving water. However, for people with a very delicate skin (allergic to detergents) it may be necessary to rinse the laundry using an extra quantity of water (extra rinse).

Press simultaneously buttons  and  for some seconds: the light + comes on in the programme progress display. This function stays permanently on. To remove it press the same buttons again until the light + goes off.

Altering an option or a running programme

It is possible to change any option before the programme carries it out. Before you make any change, you must pause the washing machine by pressing the **Start/Pause** button.

Changing a running programme is possible **only by resetting it**. Turn the programme selector dial to  and then to the new programme position. The washing water in the tub will not emptied out. Start the new programme by depressing the **Start/Pause** button again.

Interrupting a programme

Depress the **Start/Pause** button to interrupt a programme which is running, the corresponding light starts to flash. Depress the button again to restart the programme.

Cancelling a programme

Turn the selector dial to  to cancel a programme which is running. Now you can select a new programme.

Opening the door after the programme has started

First set the machine to pause by pressing the **Start/Pause** button.

After some minutes the door can be opened.

If the **door** remains locked, this means that the machine is already heating, that the water level is above the bottom edge of the door. In this case the door can not be opened.

If you cannot open the door but you need to open it you have to switch the machine off by turning the selector dial to . After about some minutes the door can be opened (**pay attention to the water level and temperature!**).

At the end of the programme

The machine stops automatically. The **Start/Pause** light goes off and the phase light **end** →| illuminates.

















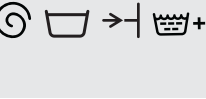



If the **Rinse Hold** □ option has been selected, the light □ remains lit, the phase light **end** →| illuminates, the door remains locked to indicate that the water must be emptied out before opening the door.

To empty out the water please read the steps on the Rinse Hold option paragraph.

Turn the programme selector dial to ○ to switch the machine off. Remove the laundry from the drum and carefully check that the drum is empty.













If you do not intend to carry out another wash, close the water tap. Leave the door open to prevent the formation of mildew and unpleasant smells.

Washing programmes

Programme/ Temperature	Type of laundry	Options	Description of programme
 Cottons 95°	White cotton: e.g. sheets, tablecloths, household linen.		Main wash at 95°C 3 rinses Long spin
 Cottons 60°-30°	White and coloured cotton: work garments, sheets, household linen, underwear, towels.		Main wash from 60°C to 30°C 3 rinses Long spin
  Cottons 95°-40°	White and coloured cotton: (heavy soiled cotton items): e.g. sheets, tablecloths, household linen with stains.		Prewash at 30°C Main wash from 95°C to 40°C 3 rinses Long spin
 Synthetics 60°-30°	Synthetic or mixed fabrics: underwear, coloured garments, non-shrink shirts, blouses.		Main wash from 60°C to 30°C 3 rinses Short spin
 Synthetics Easy Iron  40°	Synthetics to be gentle washed and spun.		Main wash at 40°C 4 rinses Short spin
 Delicates 40°-30°	Delicate fabrics: for example curtains		Main wash from 40°C to 30°C 3 rinses Short spin
   Handwash Wool, Silk 30° - 	Special programme for wool, silk and hand washing fabrics.		Main wash from 30°C to  (Cold) 3 rinses Short spin











* Stain option can be selected only at the temperature of 40°C or higher.

Washing programmes

Programme/ Temperature	Type of laundry	Options	Description of programme
 Rinses	Separate rinse cycle for hand washed items.	  	3 rinses Short spin
 Drain	For emptying out the last rinse water in programmes with the Rinse Hold option.		Draining of water
 Spin	Separate spin for cottons.		Drain and long spin
 Refresh	Quick wash for sport items, new clothing or items worn once.		Main wash at 30°C 2 rinses Short spin
ECO	White and fast coloured cotton economy , lightly-heavy soiled items, shirts, underwear.	   	Main wash at 60°C 2 rinses Long spin
Off/O	For cancelling the programme which is running or to switch the machine off.		

Type of fabric	Max. Load
Cottons	6 kg
Synthetics and Delicates	3 kg
40° Easy Iron	1,5 kg
Wool/Handwash/Silk	2 kg
Refresh	3 kg

Programme informations

40° Easy Iron 	Selecting this programme the laundry is gently washed and spun to avoid any creasing. In this way ironing is easier. Furthermore the machine will perform additional rinses.
Wool  Handwash  / Silk 	Washing programme for machine washable wool  as well as for hand washable woollens and delicate fabrics with the "hand washing" care symbol  .
Delicate rinses 	With this programme it is possible to rinse and spin cotton garments which have been washed by hand. The machine performs some rinses, followed by a final spin at 1200 r.p.m.. The spin speed can be reduced by depressing the Spin Speed Reduction button.
Drain 	For emptying out the water of the last rinse in programmes with the Rinse Hold option. Turn first the programme selector dial to O , then select programme Drain and depress the Start/Pause button.
Spin 	Separate spin for hand washed garments and after programmes with Rinse Hold option. Before selecting this programme the selector dial must be turned to O . You can choose the speed by means of the relevant button to adapt it to the fabrics to be spun.
Refresh 	This programme can be selected with the following options: Spin Speed Reduction and Delay Start. This programme must be used for half load of slightly or normally soiled cotton items. Max. load: 3 kg Washing temperature: 30°C Programme duration: 30 minutes Final short spin: 1200 r.p.m.
ECO	This programme can be selected for slightly or normally soiled cotton items. The temperature will decrease and the washing time will be extended. This allows to obtain a good washing efficiency by saving energy.
OFF/O	To reset a programme and to switch off the machine turn the selector dial to O . Now can a new programme be selected.

Preparing the wash cycle

Sorting out the laundry

Follow the wash code symbols on each garment label and the manufacturer's washing instructions. Sort the laundry as follows: whites, coloureds, synthetics, delicates, woollens.

Temperatures

95° or 90°	for normally soiled white cottons and linen (e.g. tea cloths, towels, tablecloths, sheets...).
60°/50°	for normally soiled, colour fast garments (e.g. shirts, night dresses, pyjamas...) in linen, cotton or synthetic fibres and for lightly soiled white cotton (e.g. underwear).
40°-30°- Cold	for delicate items (e.g. net curtains), mixed laundry including synthetic fibres and woollens bearing the label «pure new wool, machine washable, non-shrink».

Before loading the laundry

Never wash whites and coloureds together. Whites may lose their "whiteness" in the wash.

New coloured items may run in the first wash; they should therefore be washed separately the first time.

Make sure that no metal objects are left in the laundry (e.g. hair clips, safety pins, pins).

Button up pillowcases, close zip fasteners, hooks and poppers. Tie any belts or long tapes.

Remove persistent stains before washing.

Rub particularly soiled areas with a special detergent or detergent paste.

Treat curtains with special care. Remove hooks or tie them up in a bag or net.

Maximum loads

Recommended loads are indicated in the washing programme charts.

General rules:

Cotton, linen: drum full but not too tightly packed;

Synthetics: drum no more than half full;

Delicate fabrics and woollens: drum no more than one third full.

Washing a maximum load makes the most efficient use of water and energy.

For heavily soiled laundry, reduce the load size.

Washing a maximum load makes the most efficient use of water and energy. For heavily soiled laundry, reduce the load size.

Laundry weights

The following weights are indicative:

bathrobe	1200 g
napkin	100 g
quilt cover	700 g
sheet	500 g
pillow case	200 g
tablecloth	250 g
towelling towel	200 g
tea cloth	100 g
night dress	200 g
ladies' briefs	100 g
man's work shirt	600 g
man's shirt	200 g
man's pyjamas	500 g
blouse	100 g
men's underpants	100 g

Removing stains

Stubborn stains may not be removed by just water and detergent. It is therefore advisable to treat them prior to washing.

Blood: treat fresh stains with cold water. For dried stains, soak overnight in water with a special detergent then rub in the soap and water.

Oil based paint: moisten with benzine stain remover, lay the garment on a soft cloth and dab the stain; treat several times.

Dried grease stains: moisten with turpentine, lay the garment on a soft surface and dab the stain with the fingertips and a cotton cloth.

Rust: oxalic acid dissolved in hot water or a rust removing product used cold. Be careful with rust stains which are not recent since the cellulose structure will already have been damaged and the fabric tends to hole.

Mould stains: treat with bleach, rinse well (whites and fast coloureds only).

Grass: soap lightly and treat with bleach (whites and fast coloureds only).

Ball point pen and glue: moisten with acetone (*), lay the garment on a soft cloth and dab the stain.

Lipstick: moisten with acetone as above, then treat stains with methylated spirits. Treat any residual marks with bleach.

Red wine: soak in water and detergent, rinse and treat with acetic or citric acid, then rinse. Treat any residual marks with bleach.

Ink: depending on the type of ink, moisten the fabric first with acetone (*), then with acetic acid; treat any residual marks on white fabrics with bleach and then rinse thoroughly.

Tar stains: first treat with stain remover, methylated spirits or benzine, then rub with detergent paste.

(*) do not use acetone on artificial silk.

Detergents and additives

Good washing results also depend on the choice of detergent and use of the correct quantities to avoid waste and protect the environment.

Although biodegradable, detergents contain substances which, in large quantities, can upset the delicate balance of nature.

The choice of detergent will depend on the type of fabric (delicates, woollens, cottons, etc.), the colour, washing temperature and degree of soiling.

All commonly available washing machine detergents may be used in this appliance:

- powder detergents for all types of fabric,
- powder detergents for delicate fabrics (60°C max) and woollens,
- liquid detergents, preferably for low temperature wash programmes (60°C max) for all types of fabric, or special for woollens only.

The detergent and any additives must be placed in the appropriate compartments of the dispenser drawer before starting the wash programme.

If using concentrated powder or liquid detergents, a programme **without** prewash must be selected.

The washing machine incorporates a recirculation system which allows an optimal use of the concentrated detergent.

Pour liquid detergent into the dispenser drawer compartment marked  **just before** starting the programme.

Any fabric softener or starching additives must be poured into the compartment marked  before starting the wash programme.

Follow the product manufacturer's recommendations on quantities to use and **do not exceed the «MAX» mark in the detergent dispenser drawer.**

Quantity of detergent to be used

The type and quantity of detergent will depend on the type of fabric, load size, degree of soiling and hardness of the water used.

Follow the product manufacturers' instructions on quantities to use.

Use less detergent if:

- you are washing a small load,
- the laundry is lightly soiled,
- large amounts of foam form during washing.

Degrees of water hardness













Water hardness is classified in so-called "degrees" of hardness. Information on hardness of the water in your area can be obtained from the relevant water supply company, or from your local authority.



Note: A water softener must be added when water has a medium-high degree of hardness (from degree of hardness II). Follow the manufacturer's instructions. The quantity of detergent can then always be adjusted to degree of hardness I (= soft).





Level	Characteristic	Degrees of water hardness	
		German °dH	French °T.H.
1	soft	0-7	0-15
2	medium	8-14	16-25
3	hard	15-21	26-37
4	very hard	> 21	> 37





i International wash code symbols







These symbols appear on fabric labels, in order to help you choose the best way to treat your laundry.

<p>Energetic wash</p>   <p>Delicate wash</p>	 <p>Max. wash temperature 95°C</p>	 <p>Max. wash temperature 60°C</p> 	 <p>Max. wash temperature 40°C</p>  	 <p>Max. wash temperature 30°C</p> 	 <p>Hand wash</p>	 <p>Do not wash at all</p>
--	---	---	---	---	--	--

 <p>Bleaching</p>	 <p>Bleach in cold water</p>	 <p>Do not bleach</p>
---	---	--

 <p>Ironing</p>	 <p>Hot iron max 200°C</p>	 <p>Warm iron max 150°C</p>	 <p>Lukewarm iron max 110°C</p>	 <p>Do not iron</p>
---	---	--	--	--

 <p>Dry cleaning</p>	 <p>Dry cleaning in all solvents</p>	 <p>Dry cleaning in perchlorethylene, petrol, pure alcohol, R 111 & R 113</p>	 <p>Dry cleaning in petrol, pure alcohol and R 113</p>	 <p>Do not dry clean</p>
--	---	--	---	---

 <p>Drying</p>	 <p>Flat</p>	 <p>On the line</p>	 <p>On clothes hanger</p>	 <p>high temperature</p>  <p>low temperature</p> <p>Tumble dry</p>	 <p>Do not tumble dry</p>
--	---	--	--	--	--

Care and cleaning

You must DISCONNECT the appliance from the electricity supply, before you can carry out any cleaning or maintenance work.

Descaling

The water we use normally contains lime. It is a good idea to periodically use a water softening powder in the machine. Do this separately from any laundry washing, and according to the softening powder manufacturer's instructions.

This will help to prevent the formation of lime deposits.

After each wash

Leave the door open for a while. This helps to prevent mould and stagnant smells forming inside the appliance. Keeping the door open after a wash will also help to preserve the door seal.

Maintenance wash

With the use of low temperature washes it is possible to get a build up of residues inside the drum.

We recommend that a maintenance wash be performed on a regular basis.

To run a maintenance wash:

- The drum should be empty of laundry.
- Select the hottest cotton wash programme.
- Use a normal measure of detergent, must be a powder with biological properties.

External cleaning

Clean the exterior cabinet of the appliance with soap and water only, and then dry thoroughly.

Important: do not use methylated spirits, solvents or similar products to clean the cabinet.

Detergent dispenser drawer

The detergent dispenser drawer should be cleaned regularly.

1. Remove the detergent dispenser drawer by pulling it firmly.

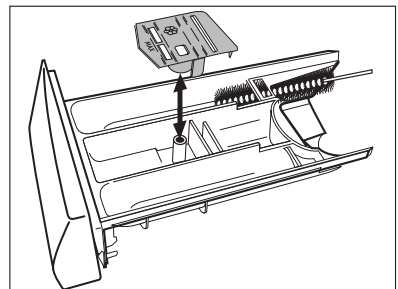

2. Remove the conditioner insert from the middle compartment.
3. Clean all parts with water.
4. Put the conditioner insert in as far as it will go, so that it is firmly in place.
5. Clean all parts of the washing machine, especially the nozzles in the top of the washing-in chamber, with a brush.
6. Insert the detergent dispenser drawer in the guide rails and push it in.

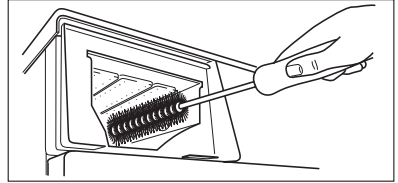

Washing drum

Rust deposits in the drum may occur due to rusting foreign bodies in the washing or tap water containing iron.

Important! Do not clean the drum with acidic descaling agents, scouring agents containing chlorine or iron or steel wool.

1. Remove any rust deposits on the drum with a cleaning agent for stainless steel.
2. Run a washing cycle without any washing to clean off any cleaning agent residues. Programme: COTTONS 95, press the EXTRA QUICK button, add approx. 1/2 measuring cup of detergent.

Door seal

Check from time to time the door seal and eliminate eventual possible objects that could be trapped in the fold.

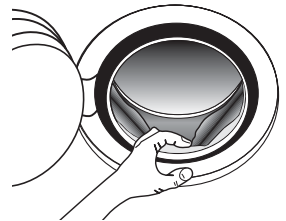

Drain pump

The pump should be inspected regularly and particularly if

- the machine does not empty and/or spin
- the machine makes an unusual noise during draining due to objects such as safety pins, coins etc. blocking the pump.

Proceed as follows:

1. Disconnect the appliance.
2. If necessary wait until the water has cooled down.
3. Open the pump door.
4. Place a container close to the pump to collect any spillage.

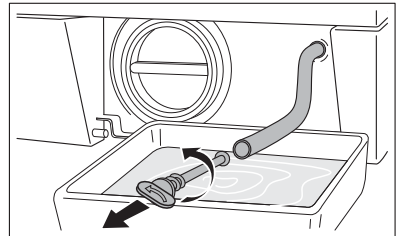
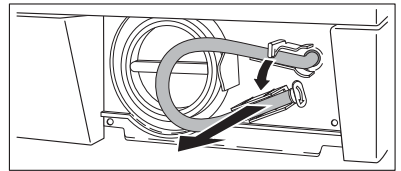
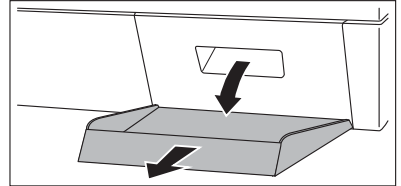

5. Release the emergency emptying hose, place it in the container and remove its cap.
6. When no more water comes out, unscrew the pump and remove it. Always keep a rag nearby to dry up spillage of water when removing the pump.
7. Remove any objects from the pump impeller by rotating it.

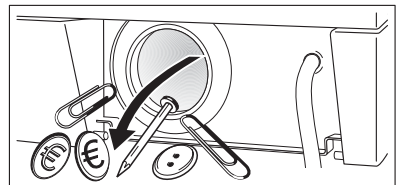
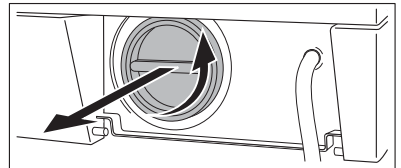

8. Put the cap back on the emergency emptying hose and place the latter back in its seat.
9. Screw the pump fully in.
10. Close the pump door.

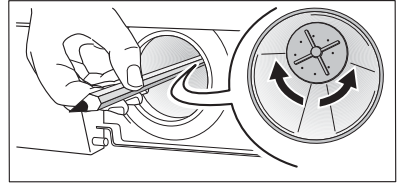

Warning!

When the appliance is in use and depending on the programme selected there can be hot water in the pump. Never remove the pump cover during a wash cycle, always wait until the appliance has finished the cycle, and is empty. When replacing the cover, ensure it is securely retightened so as to stop leaks and young children being able to remove it.

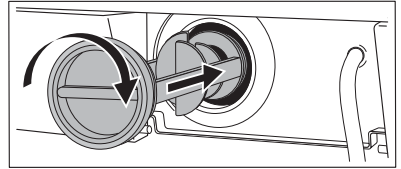

Water inlet filter

If you notice that the machine is taking longer to fill, check that the filter in the water inlet hose is not blocked.

1. Turn off the water tap.
2. Unscrew the hose from the tap.
3. Clean the filter in the hose with a stiff brush.
4. Screw the hose back onto the tap.

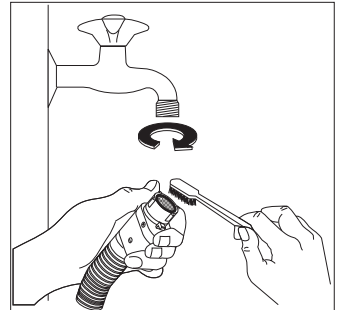

Emergency emptying out

If the water is not discharged, proceed as follows to empty out the machine:

1. pull out the plug from the power socket;
2. close the water tap;
3. if necessary, wait until the water has cooled down;
4. open the the pump door;
5. place a bowl on the floor and place the end of the emergency emptying hose into the bowl. Remove its cap. The water should drain by gravity into the bowl. Whe the bowl is full, put the cap back on the hose. Empty the bowl. Repeat the procedure until water stops flowing out;
6. clean the pump if necessary as previously described;

7. replace the emergency emptying hose in its seat after having plugged it;
8. screw the pump again and close the door.

Frost precautions

If the machine is installed in a place where the temperature could drop below 0°C, proceed as follows:

1. Close the water tap and unscrew the water inlet hose from the tap.
2. Place the end of the emergency emptying hose and that of the inlet hose in a bowl placed on the floor and let water drain out.
3. Screw the water inlet hose back on and reposition the emergency emptying hose after having put the cap on again.

By doing this, any water remaining in the machine is removed, avoiding ice forming and consequently damage to the appliance.

When you use the machine again, make sure that the ambient temperature is above 0°C.

Important! Every time you drain the water through the emergency emptying hose you must pour 2 litres of water into the main wash compartment of the detergent drawer and then run the drain programme. This will activate the ECO VALVE device avoiding that part of the detergent remains unused at next washing.





Something not working

Certain problems are due to lack of simple maintenance or oversights, which can be solved easily without calling out an engineer. Before contacting your local Service Centre, please carry out the checks listed below.

During machine operation it is possible that the **yellow Start/Pause** pilot light flashes to indicate that the machine is not working.

Once the problem has been eliminated, press the **Start/Pause** button to restart the programme. If after all checks, the problem persists, contact your local Service Centre.

Problem	Possible cause/Solution
<p>The washing machine does not start:</p>	<p>The door has not been closed. (Yellow Start/Pause pilot light flashes)</p> <ul style="list-style-type: none"> • Close firmly the door. <p>The plug is not properly inserted in the power socket.</p> <ul style="list-style-type: none"> • Insert the plug into the power socket. <p>There is no power at the socket.</p> <ul style="list-style-type: none"> • Please check your domestic electrical installation. <p>The main fuse has blown.</p> <ul style="list-style-type: none"> • Replace the fuse. <p>The selector dial is not correctly positioned and the Start/Pause button has not been depressed.</p> <ul style="list-style-type: none"> • Please turn the selector dial and press the Start/Pause button again. <p>The delay start has been selected.</p> <ul style="list-style-type: none"> • If the laundry are to be washed immediately, cancel the delay start.
<p>The machine does not fill:</p>	<p>The water tap is closed. (Yellow Start/Pause pilot light flashes)</p> <ul style="list-style-type: none"> • Open the water tap. <p>The inlet hose is squashed or kinked. (Yellow Start/Pause pilot light flashes)</p> <ul style="list-style-type: none"> • Check the inlet hose connection. <p>The filter in the inlet hose is blocked. (Yellow Start/Pause pilot light flashes)</p> <ul style="list-style-type: none"> • Clean the water inlet hose filter. <p>The door is not properly closed. (Yellow Start/Pause pilot light flashes)</p> <ul style="list-style-type: none"> • Close firmly the door.

Problem	Possible cause/Solution
<p>The machine fills then empties immediately:</p>	<p>The end of the drain hose is too low.</p> <ul style="list-style-type: none"> • Refer to relevant paragraph in «water drainage» section.
<p>The machine does not empty and/or does not spin:</p>	<p>The drain hose is squashed or kinked. (Yellow Start/Pause pilot light flashes)</p> <ul style="list-style-type: none"> • Check the drain hose connection. <p>The drain pump is clogged. (Yellow Start/Pause pilot light flashes)</p> <ul style="list-style-type: none"> • Clean the drain pump. <p>The option  has been selected.</p> <ul style="list-style-type: none"> • Disable the option . • Select the option  or . <p>The laundry is not evenly distributed in the drum.</p> <ul style="list-style-type: none"> • Redistribute the laundry.
<p>There is water on the floor:</p>	<p>Too much detergent or unsuitable detergent (creates too much foam) has been used.</p> <ul style="list-style-type: none"> • Reduce the detergent quantity or use another one. <p>Check whether there are any leaks from one of the inlet hose fittings. It is not always easy to see this as the water runs down the hose; check to see if it is damp.</p> <ul style="list-style-type: none"> • Check the water inlet hose connection. <p>The drain hose is damaged.</p> <ul style="list-style-type: none"> • Change it with a new one. <p>The cap on the emergency emptying hose has not been replaced after cleaning the pump.</p> <ul style="list-style-type: none"> • Put the cap back on the emergency emptying and place the latter back in its seat.

Problem	Possible cause/Solution
Unsatisfactory washing results:	<p>Too little detergent or unsuitable detergent has been used.</p> <ul style="list-style-type: none"> • Increase the detergent quantity or use another one. <p>Stubborn stains have not been treated prior to washing.</p> <ul style="list-style-type: none"> • Use commercial products to treat the stubborn stains. <p>The correct temperature was not selected.</p> <ul style="list-style-type: none"> • Check if you have selected the correct temperature. <p>Excessive laundry load.</p> <ul style="list-style-type: none"> • Introduce into the drum less laundry.
The door will not open:	<p>The programme is still running.</p> <ul style="list-style-type: none"> • Wait the end of washing cycle. <p>The door lock has not been released.</p> <ul style="list-style-type: none"> • Wait some minutes. <p>There is water in the drum.</p> <ul style="list-style-type: none"> • Select drain or spin programme to empty out the water.
The machine vibrates is noisy:	<p>The transit bolts and packing have not been removed.</p> <ul style="list-style-type: none"> • Check the correct installation of the appliance. <p>The support feet have not been adjusted</p> <ul style="list-style-type: none"> • Check the correct levelling of the appliance. <p>The laundry is not evenly distributed in the drum.</p> <ul style="list-style-type: none"> • Redistribute the laundry. <p>Maybe there is very little laundry in the drum.</p> <ul style="list-style-type: none"> • Load more laundry.
Spinning starts late or the machine does not spin:	<p>The electronic unbalance detection device has cut in because the laundry is not evenly distributed in the drum. The laundry is redistributed by reverse rotation of the drum. This may happen several times before the unbalance disappears and normal spinning can resume. If, after some minutes, the laundry is still not evenly distributed in the drum, the machine will not spin.</p> <ul style="list-style-type: none"> • Redistribute the laundry.

Problem	Possible cause/Solution
<p>The machine makes an unusual noise:</p>	<p>The machine is fitted with a type of motor which makes an unusual noise compared with other traditional motors. This new motor ensures a softer start and more even distribution of the laundry in the drum when spinning, as well as increased stability of the machine.</p>
<p>No water is visible in the drum:</p>	<p>Machines based on modern technology operate very economically using very little water without affecting performance.</p>

If you are unable to identify or solve the problem, contact our service centre. Before telephoning, make a note of the model, serial number and purchase date of your machine: the Service Centre will require this information.

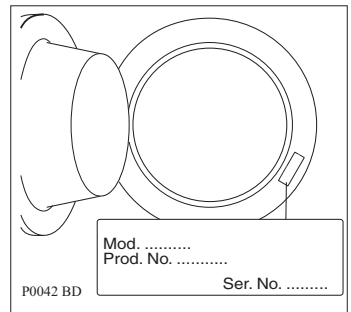

Technical Data

Dimensions	Width Height Depth (door included)	60 cm 85 cm 63 cm
Electrical connection Voltage - Overall power - Fuse	Information on the electrical connection is given on the rating plate on the inner edge of the appliance door	
Water supply pressure	Minimum Maximum	0,05 MPa 0,8 MPa
Maximum Load	Cotton Synthetics Delicates Wollens and handwash Refresh	6 kg 3 kg 3 kg 2 kg 3 kg
Spin Speed	Maximum	1200 rpm



Consumption value

Programme	Water consumption (in litres)	Energy consumption (in kWh)	Programme duration (in minutes)
White Cottons 95°	61	2.0	135
Cottons 60°	58	1.3	120
Cottons + Prewash 95°	71	2.15	155
Synthetics 60°	54	1.0	90
Easy Iron 40°	60	0.35	90
Delicates 40°	60	0.55	65
Wool/Handwash/Silk 30°	53	0.4	60
Delicate rinses	50	0.05	30
Drain	-	-	2
Spin	-	-	10
Refresh	57	0.28	30
Eco	46	1.02	145



The consumption data shown on this chart is to be considered purely indicative, as it may vary depending on the quantity and type of laundry, on the inlet water temperature and on the ambient temperature. It refers to the highest temperature for each wash programme.



(*) "Cottons Eco 60°" is the reference programme for the data entered in the energy label, in compliance with EEC 92/75 standards.

Installation

Unpacking

All transit bolts and packing must be removed before using the appliance.

You are advised to keep all transit devices so that they can be refitted if the machine ever has to be transported again.

1. After removing all the packaging, carefully lay machine on it's back to remove the polystyrene base from the bottom.



2. Remove the power supply cable and the draining hose from the hose holders on the rear of the appliance.

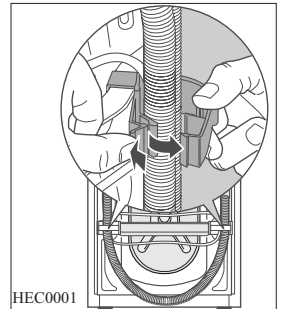

3. With a suitable spanner unscrew and remove the central rear bolt **A**.

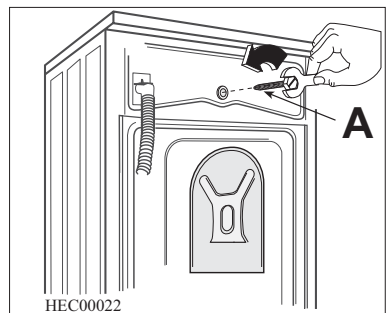

4. Unscrew and remove the two large rear bolts **B** and the six smaller bolts **C**.

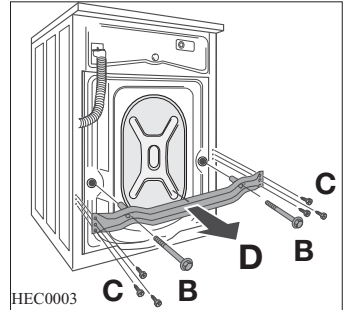

5. Remove the bracket **D** and tighten up the six smaller bolts **C**. Slide out the relevant plastic spacer **E**.

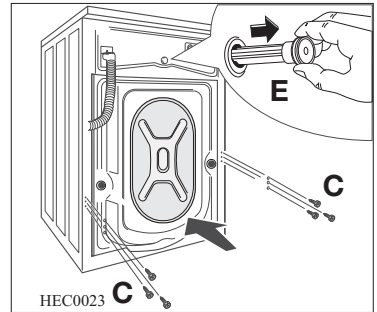

6. Open the porthole, take out the inlet hose from the drum and remove the polystyrene block fitted with the adhesive tape on the door seal.

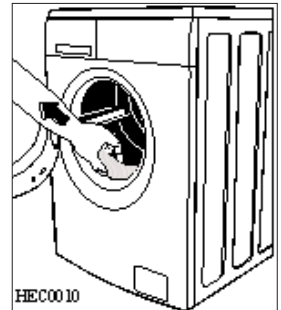

7. Fill the smaller upper hole and the two large ones with the corresponding plastic plug caps supplied in the bag containing the instruction booklet.
8. Connect the water inlet hose as described under the paragraph «Water inlet».

All the different plug caps are supplied with the appliance in the plastic bag containing the instruction booklet.

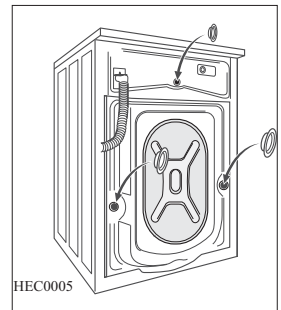

Positioning and levelling

Install the machine on a flat hard floor.

Make sure that air circulation around the machine is not impeded by carpets, rugs etc.

Before placing it on small tiles, apply a rubber coating.

Never try to correct any unevenness in the floor by putting pieces of wood, cardboard or similar materials under the machine.

If it is impossible to avoid positioning the machine next to a gas cooker or coal-burning stove, an insulating panel covered with aluminium foil on the side facing the cooker or stove, must be inserted between the two appliances.

The machine must not be installed in rooms where the temperature can drop below 0.

The water inlet hose and the drain hose must not be kinked.

Please ensure that when the appliance is installed, it is easily accessible for the engineer in the event of a breakdown.

Carefully level by screwing the adjustable feet in or out. Never place cardboard, wood or similar materials under the machine to compensate for any unevenness in the floor.

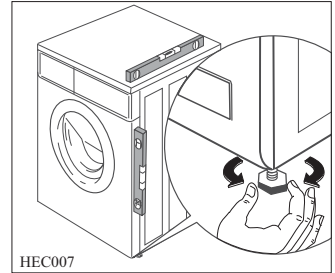

Water inlet

An inlet hose is supplied and can be found inside the machine drum.

Do not use the hose from your previous machine to connect to the water supply.

This appliance must be connected to a cold water supply.

1. Open the porthole and extract the inlet hose.
2. Connect the hose with the angled connection to the machine.

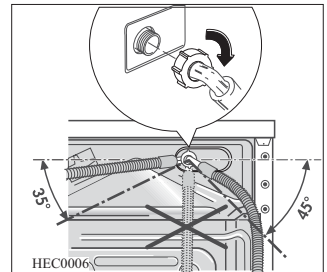

Do not place the inlet hose downwards. Angle the hose to the left or right depending on the position of your water tap.

3. Set the hose correctly by loosening the ring nut. After positioning the inlet hose, be sure to tighten the ring nut again to prevent leaks.
4. Connect the hose to a tap with a 3/4" thread. Always use the hose supplied with the appliance.

Installation should comply with local water authority and building regulations requirements. A minimum water pressure of 0.05 MPa is required for safe operation of the appliance.

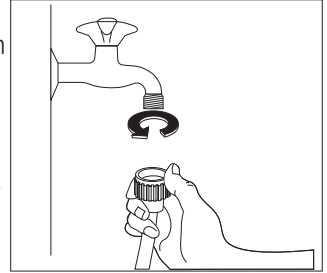

If you cannot make the cold water connection direct from the rising mains, you may be able to operate the appliance from your cold water storage system. There should be a minimum distance of between the appliance's inlet and the bottom of the water storage tank.

Water drainage

The end of the drain hose can be positioned in three ways:

Hooked over the edge of a sink using the plastic hose guide supplied with the machine.

In this case, make sure the end cannot come unhooked when the machine is emptying.

This could be done by tying it to the tap with a piece of string or attaching it to the wall.

In a sink drain pipe branch. This branch must be above the trap so that the bend is at least 60 cm above the ground.

Directly into a drain pipe at a height of not less than 60 cm and not more than 90 cm.

The end of the drain hose must always be **ventilated**, i.e. the inside diameter of the drain pipe must be larger than the outside diameter of the drain hose.

The drain hose must not be kinked.

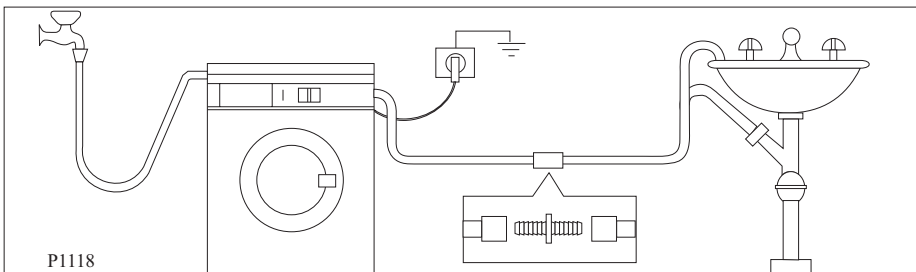
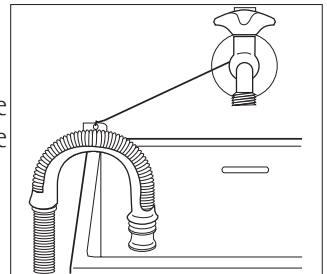

Important!

The drain hose may be extended to a maximum of 4 metres. An additional drain hose and joining piece is available from your local Service Centre.

Electrical connection

This machine is designed to operate on a 220-230 V, single-phase, 50 Hz supply.

Check that your domestic electrical installation can take the maximum load required (2.2 kW), also taking into account any other appliances in use.



Connect the machine to an earthed socket.



The manufacturer does not accept any responsibility for damage or injury through failure to comply with the above safety precaution.

Permanent connection

In the case of a permanent connection it is necessary that you install a double pole switch between the appliance and the electricity supply (mains), with a minimum gap of 3 mm between the switch contacts and of a type suitable for the required load in compliance with the current electrical regulations.

The switch must not break the yellow and green earth cable at any point.

This operation must be performed by a qualified electrician.



The power supply cable must be easily accessible after installing the machine.

Environment concerns

Packaging materials

The materials marked with the symbol  are recyclable.

>PE<=polyethylene

>PS<=polystyrene

>PP<=polypropylene

This means that they can be recycled by disposing of them properly in appropriate collection containers.

Old machine

Use authorised disposal sites for your old appliance. Help to keep your country tidy!

The symbol  on the product or on its packaging indicates that this product may not be treated as household waste. Instead it shall be handed over to the applicable collection point for the recycling of electrical and electronic equipment. By ensuring this product is disposed of correctly, you will help prevent potential negative consequences for the environment and human health, which could otherwise be caused by inappropriate waste handling of this product. For more detailed information about recycling of this product, please contact your local city office, your household waste disposal service or the shop where you purchased the product.

Ecological hints

To save water, energy and to help protect the environment, we recommend that you follow these tips:

- Normally soiled laundry may be washed without prewashing in order to save detergent, water and time (the environment is protected too!).
- The machine works more economically if it is fully loaded.
- With adequate pre-treatment, stains and limited soiling can be removed; the laundry can then be washed at a lower temperature.
- Measure out detergent according to the water hardness, the degree of soiling and the quantity of laundry being washed.



European Guarantee

This appliance is guaranteed by Electrolux in each of the countries listed at the back of this user manual, for the period specified in the appliance guarantee or otherwise by law. If you move from one of these countries to another of the countries listed, the appliance guarantee will move with you subject to the following qualifications:

- The appliance guarantee starts from the date you first purchased the appliance which will be evidenced by production of a valid purchase document issued by the seller of the appliance.
- The appliance guarantee is for the same period and to the same extent for labour and parts as exists in your new country of residence for this particular model or range of appliances.
- The appliance guarantee is personal to the original purchaser of the appliance and cannot be transferred to another user.
- The appliance is installed and used in accordance with instructions issued by Electrolux and is only used within the home, i.e. is not used for commercial purposes.
- The appliance is installed in accordance with all relevant regulations in force within your new country of residence.

The provisions of this European Guarantee do not affect any of the rights granted to you by law.

www.electrolux.com

		
Albania	+35 5 4 261 450	Rr. Pjeter Bogdani Nr. 7 Tirane
Belgique/België/Belgien	+32 2 363 04 44	Bergensesteenweg 719, 1502 Lembeek
Česká republika	+420 2 61 12 61 12	Budějovická 3, Praha 4, 140 21
Danmark	+45 70 11 74 00	Sjællandsgade 2, 7000 Fredericia
Deutschland	+49 180 32 26 622	Muggenhofer Str. 135, 90429 Nürnberg
Eesti	+37 2 66 50 030	Mustamäe tee 24, 10621 Tallinn
España	+34 902 11 63 88	Carretera M-300, Km. 29,900 Alcalá de Henares Madrid
France	www.electrolux.fr	
Great Britain	+44 8705 929 929	Addington Way, Luton, Bedfordshire LU4 9QQ
Hellas	+30 23 10 56 19 70	4, Limnou Str., 54627 Thessaloniki
Hrvatska	+38 51 63 23 338	Slavonska avenija 3, 10000 Zagreb
Ireland	+353 1 40 90 753	Longmile Road Dublin 12
Italia	+39 (0) 434 558500	C.so Lino Zanussi, 26 - 33080 Porcia (PN)
Latvija	+37 17 84 59 34	Kr. Barona iela 130/2, LV-1012, Riga
Lituanija	+370 5 27 80 609	Verkių 2 9, 09108 Vilnius, Lithuania
Luxembourg	+35 2 42 43 13 01	Rue de Bitbourg, 7, L-1273 Hamm
Magyarország	+36 1 252 1773	H-1142 Budapest XIV, Erzsébet királyné útja 87
Nederland	+31 17 24 68 300	Vennootsweg 1, 2404 CG - Alphen aan den Rijn
Norge	+47 81 5 30 222	Risløkkvn. 2, 0508 Oslo
Österreich	+43 18 66 400	Herziggasse 9, 1230 Wien
Polska	+48 22 43 47 300	ul. Kolejowa 5/7, Warsaw
Portugal	+35 12 14 40 39 39	Quinta da Fonte - Edifício Gonçalves Zarco - Q35 - 2774-518 Paço de Arcos
Romania	+40 21 451 20 30	Str. Garii Progresului 2, S4, 040671 RO
Schweiz-Suisse-Svizzera	+41 62 88 99 111	Industriestrasse 10, CH-5506 Mägenwil
Slovenija	+38 61 24 25 731	Tr aška 132, 1000 Ljubljana
Slovensko	+421 2 43 33 43 22	Electrolux Slovakia s.r.o., Electrolux Domáce spotrebiče SK, Seberinoho 1, 821 03 Bratislava
Suomi	www.electrolux.fi	
Sverige	+46 (0)771 76 76 76	Electrolux Service, S:t Göransgatan 143, S-105 45 Stockholm
Türkiye	+90 21 22 93 10 25	Tarlabaşı caddesi no : 35 Taksim Istanbul
Россия	+7 095 937 7837	129090 Москва, Олимпийский проспект, 16, БЦ «Олимпик»

www.electrolux.com

www.aeg-electrolux.uk

Subject to change without notice

192 999 930-01-252008

PERFEKT IN FORM UND FUNKTION



Free Manuals Download Website

<http://myh66.com>

<http://usermanuals.us>

<http://www.somanuals.com>

<http://www.4manuals.cc>

<http://www.manual-lib.com>

<http://www.404manual.com>

<http://www.luxmanual.com>

<http://aubethermostatmanual.com>

Golf course search by state

<http://golfingnear.com>

Email search by domain

<http://emailbydomain.com>

Auto manuals search

<http://auto.somanuals.com>

TV manuals search

<http://tv.somanuals.com>