

ÖKO-LAVAMAT 70730 update

The Environmentally-Friendly Washing Machine

User Information



Dear customer,

Please read this user information carefully.

In particular, pay attention to the section "Safety" on the first pages. Keep this user information in a safe place for later reference. Pass it on to any subsequent owners of the unit.



Points which are necessary for your safety or which are important for the unit's functional capability are highlighted by a warning triangle and/or signal words (**Warning!**, **Caution!**, **Attention!**). Always remember.



1. This symbol guides you step by step in operating the unit.

2. ...



After this symbol you will find detailed information on operation and practical use of the unit.



The clover leaf indicates tips and information on the economical and environmentally-responsible use of the unit.

This user information contains information on remedying any faults which may occur, see the section "What to do if ...".

If these instructions are not sufficient, our After-Sales Service is at your disposal at any time:

ELGROEP & AEG SERVICE

Bergensesteenweg 719

1502 Lembeek

Tel.: 02/3630444

Here you will receive an answer to any question concerning the features and use of your unit. Of course, we are also pleased to receive any requests, suggestions and criticism. Our aim is to further improve our products and services for the benefit of our customers.

In the event of technical problems, our factory customer service in your area is at your disposal at all times. Also refer to the section "Service".

Printed on recycled paper.

Those who think ecologically act ecologically ...

CONTENTS

Instructions for use	6
Safety	6
Disposal	8
Environment Tips	8
Unit Description	9
Front View	9
Drawer for Washing Powder and Care Agent	9
Control Panel	10
Program Selector	10
Additional Program Buttons	12
Consumption Values and Time Requirements	13
What Does "Update" Mean?	14
Water Protection Aqua Control	14
Before the First Wash	15
Prepare the Washing Cycle	15
Sort and Prepare the Washing	15
Washing Types and Care Codes	16
Washing Detergents and Care Agents	17
Which washing detergent and care agent?	17
How much washing detergent and care agent?	17
Water Softener	17
Run a Washing Cycle	18
Brief Instructions	18
Set the Washing Program	19
Change Spin Speed / Select Rinse Hold	19
Set the Delay Timer/Soaking Duration	20
Opening and Closing the Filling Door	22
Add the Washing	22
Add Washing Detergent/Care Agent.	23
Start the Washing Program	24
Completion of the Washing Program	25
Changing a Washing Program	25
Washing Cycle Ended/Remove Washing	27

Program Tables	28
Washing	28
Separate Conditioning/Starching/Impregnating	30
Separate Rinse	30
Separate Spin	30
Cleaning and Care	31
Control Panel	31
Washing Detergent Drawer	31
Washing Drum	32
Filling Door	32
What to do if	33
Remedying Faults	33
If the washing result is not satisfactory	37
Carry Out an Emergency Emptying Operation	38
Clean the Solution Pump	39
Emergency Unlocking of the Filling Door	40
Additional Rinse (RINSE+/SPOELEN+/RINCAGE+)	41
Child Safety Feature	42
Setting up and connection instructions	43
Safety Instructions for Installation	43
Setting Up the Unit	44
Transporting the Unit	44
Remove the Transport Safeguard	44
Prepare the Installation Location	46
Setting Up on a Concrete Pedestal	46
Setting Up on a Vibrating floor	46
Compensate for Floor Unevenness	47

Electrical Connection	48
Water Connection	48
Permissible Water Pressure	48
Water Inflow	49
Water Drainage	50
Delivery Heads over 1 m	51
Technical Data	51
Dimensions	51
Index	54
Service	55

INSTRUCTIONS FOR USE



Safety

The safety of AEG electrical appliances conforms to the recognised technical regulations and the legislation covering the safety of appliances. However, as manufacturers, we still regard it as our responsibility to inform you of the following safety information.

Before Putting into Operation for the First Time

- Refer to the **"Installation and Connection Instructions"** later in this user information.
- When the unit is delivered in winter months with minus temperatures: Store the washing machine for 24 hours at room temperature before putting it into operation.

Correct Use

- The washing machine is only designed for normal domestic washing. If the unit is used for purposes other than that for which it is designed, the manufacturer can accept no liability for any resulting damages.
- For safety reasons, conversions or modifications to the washing machine are not permissible.
- Use only detergents which are suitable for washing machines. Follow the washing detergent manufacturer's instructions.
- The washing must not contain any flammable solvents. Also remember this when washing pre-cleaned washing.
- Do not use the washing machine for chemical cleaning.
- Dyes/dye removers may only be used in washing machines if the manufacturer expressly allows these products. We cannot be held liable for any resulting damage.
- Use only water from the water mains. Use rainwater or service water only if it meets the requirements outlined in DIN 1986 and DIN 1988.
- Frost damage is not covered by the warranty! If the washing machine is in a room which is at risk from frost, an emergency emptying operation must be carried out when there is a frost risk (see the section "Carry Out Emergency Emptying").

Child Safety

- Packaging components (e.g. films, polystyrene) can be hazardous to children. Risk of suffocation! Keep packaging away from children.
- Children often cannot recognise the hazards associated with handling electrical appliances. Therefore, ensure the necessary supervision during operation and do not allow children to play with the washing machine – there is a risk that children can get trapped inside.
- Ensure that children or small animals cannot climb into the washing machine's drum.
- When disposing of the washing machine: Pull out the mains plug, destroy the door lock, cut off the electrical supply lead and throw away the plug and the left-over cable. This means that children at play cannot shut themselves inside and in so doing be in danger.

General Safety

- Repairs to the washing machine may only be carried out by skilled persons. Incorrect repairs can cause significant hazards. If repairs are necessary, consult our Customer Service or your specialist dealer.
- Never put the washing machine into operation if the mains cable is damaged or if the control panel, work top or base area are damaged in such a way that the inside of the unit is open and accessible.
- Switch off the washing machine before carrying out cleaning, care and maintenance work. Also pull the mains plug out of the socket or, – if it is permanently connected, – switch off the LS switch in the fuse box or completely unscrew the screw-in fuse.
- Never pull the cable to remove the plug from the socket. Always pull the plug itself.
- Multiple connectors, couplings and extension cables must not be used. **There is a fire risk with overheating!**
- Do not spray down the washing machine with a water jet. Electric shock risk!
- The glass in the filling door becomes hot in the case of washing programs with high temperatures. Do not touch!
- Allow the washing solution to cool down before emergency emptying of the unit, before cleaning or before emergency opening of the filling door.
- Small animals can chew the power cables and water hoses. Risk of electric shock and danger of water damage! Keep small animals away from the washing machine.



Disposal

Dispose the packing material!

Dispose of your washing machine's packaging correctly. All packaging materials are environmentally compatible and can be disposed of without risk or incinerated at a refuse combustion plant.

The plastics can also be reused:

- The outer sleeve and the bags are made of polyethylene (code >PE<).
- The cushioned parts are made of foamed, CFC-free polystyrene (code >PS<).

The card parts were made from recycled paper and should also be returned in the waste paper collection.

Dispose the old appliance!

When you finally put your appliance out of operation, please bring it to your nearest recycling centre or to your dealer.



Environment Tips

- The pre-wash cycle is not required for averagely dirty washing. This saves washing powder/liquid, water and time (and does not harm the environment).
- The washing machine is especially economical when you fully utilise the stated filling quantities.
- For small amounts of washing, use only half to two thirds the recommended amount of washing powder/liquid.
- Suitable pretreatment enables stains and small amounts of dirt to be removed. You can then wash at a lower temperature.
- Use the energy-saving program to wash garments which are lightly to moderately dirty.
- There is often no need for conditioner. Try it once! If you use a dryer, your washing will become soft and velvety even without conditioner.
- In the case of medium to high water hardness, (hardness range II or higher, see "Washing and Care Agents"), you should use water softener.
The washing powder/liquid can then always be metered for hardness range I (= soft).

Unit Description

Front View

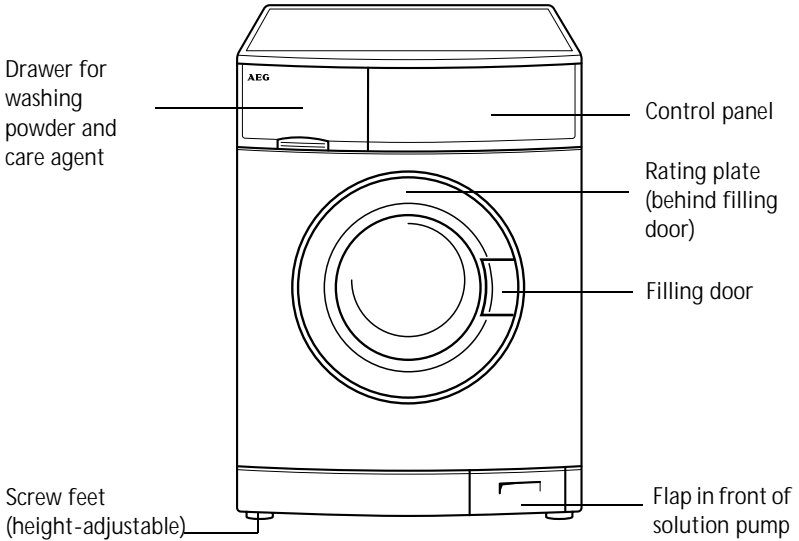

Drawer for Washing Powder and Care Agent

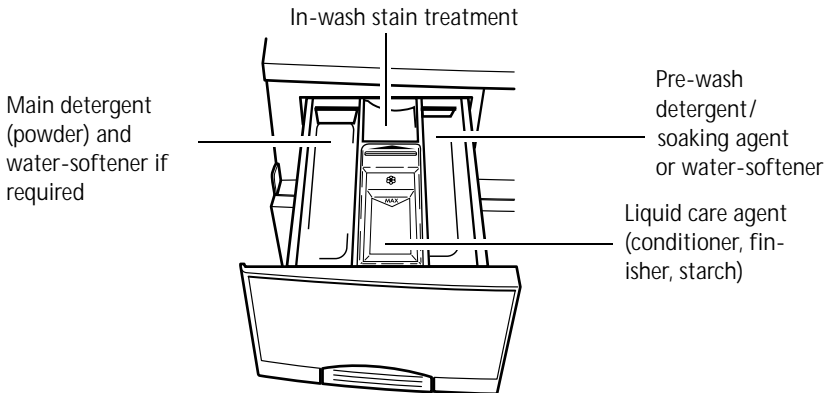

Control Panel

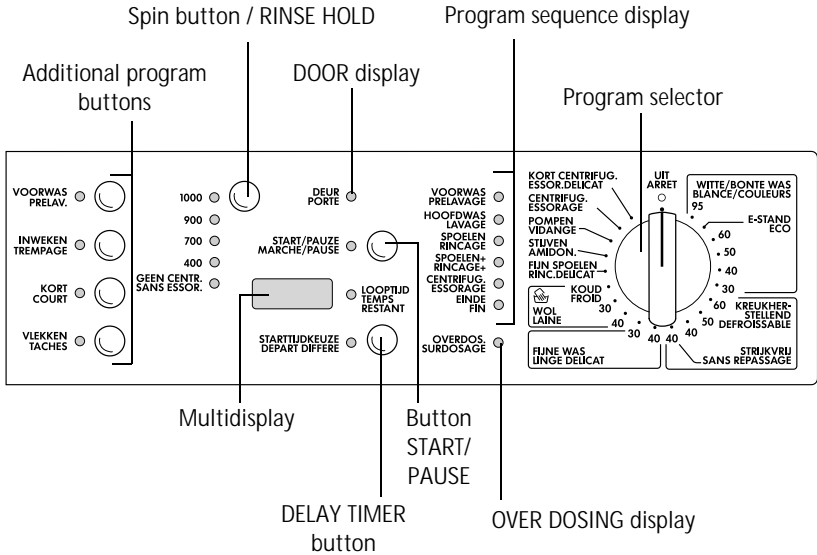

Program Selector

The program selector determines the type of washing cycle (e.g. water level, drum movement, number of rinses, spin speed) according to the type of garments being washed, and also the washing solution.

OFF (UIT, ARRET)

Switches off the washing machine. All other positions are "switched on".

COTTONS/LINEN

(WITTE/BONTE WAS, BLANC/COULEURS)

Main washing cycle Cottons/Linen at 30 °C to 95 °C.



ENERGY SAVING position (E-STAND, ECO): Energy-saving program at approx. 67 °C for slightly to normally dirty cottons, extended washing time (cannot be combined with QUICK WASH/KORT/COURT).

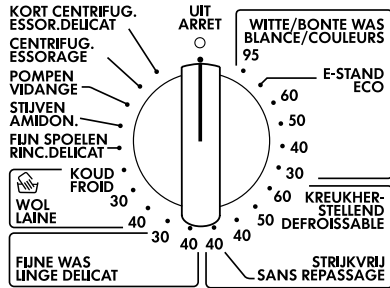

EASY-CARES (KREUKHERSTELLEND, DEFROISSABLE)

Main washing cycle for easy-care textiles (mixed fabrics) at 40 °C to 60 °C.

EASY IRON position (STRIJKVRIJ, SANS REPASSAGE): Main washing cycle at 40 °C for easy-care textiles which, with the aid of this program, only have to be either gently ironed or not ironed at all.

DELICATES (FIJNE WAS, LINGE DELICAT)

Main washing cycle for delicates at 30 °C or 40 °C.

WOOLLENS (WOL, LAINE)/ (Handwash)

Main washing cycle (cold up to 40 °C) for machine-washable woollens and for hand-washable wool textile and silk with the care symbol  (handwash).

GENTLE RINSE (FIJN SPOELEN, RINC. DELICAT)

Separate gentle rinse e.g. for rinsing hand-washed textiles (2 rinses, liquid care agent from rinsing compartment  is added, short spin).

STARCHING (STIJVEN, AMIDON.)

Separate starching, separate conditioner, separate impregnation of damp washing (1 rinse, liquid care agent from the rinsing compartment  is added, spin).

PUMP OUT (POMPEN, VIDANGE)

Pumping off the water after a rinse hold (without spin).



Rinse hold means: The washing remains lying in the last rinsing water. It is not spun.

SPIN (CENTRIFUG., ESSORAGE)

Pumping off the water after a rinse hold and spin, or separate spin of hand-washed cottons/linen.

SHORT SPIN (KORT CENTRIFUG., ESSOR. DELICAT)

Pumping off the water after a rinse hold and short spin or separate short spin of sensitive textiles (easy-care washing, delicates, woollens).

Additional Program Buttons

The additional program buttons are for adapting the washing program to the dirtiness of the washing. Additional programs are not required for washing which is not excessively dirty. Various functions can be combined with each other, depending on the program.

VOORWAS
PRELAV. 

INWEKEN
TREMPAGE 

KORT
COURT 

VLEKKEN
TACHES 

PRE WASH (VOORWAS, PRELAV.)

Warm pre wash before the main washing cycle which follows on automatically; with intermediate spin for COTTONS/LINEN (WITTE/BONTE WAS, BLANC/COULEURS), without intermediate spin for EASY-CARES (KRUEKHERSTELLEND, DEFROISSABLE) and DELICATES (FIJNE WAS, LINGE DELICAT).

SOAKING (INWEKEN, TREMPAGE)

Approximately 50 minutes at 30°C water temperature. Extendable with the button DELAY TIMER (STARTTIJDKEUZE, DEPART DIFFERE) to max. 10 hours and approx. 20 minutes. This is followed automatically by the main wash.

QUICK WASH (KORT, COURT)

Shorter washing cycle for slightly dirty washing.

STAIN (VLEKKEN, TACHES)

For treating very dirty washing or stained washing. (In-wash stain treatment is added during the program on a time-optimized basis).



With the WOOLLENS (WOL, LAINE) program/ (handwash), it is not possible to select the additional programs (any pressed buttons have no effect).

Consumption Values and Time Requirements

The values for selected programs in the following tables were determined under normal conditions. However, there is a helpful orientation aid for domestic operation.

Program Selector/ Temperature	Filling Quantity in kg	Water in Litres	Energy in kWh	Time in Minutes
COTTONS/LINEN 95 (WITTE/BONTE WAS, BLANC/COULEURS)	5	45	1.70	144
COTTONS/LINEN 60 ¹⁾ (WITTE/BONTE WAS, BLANC/COULEURS)	5	42	0.94	129
COTTONS/LINEN 40 (WITTE/BONTE WAS, BLANC/COULEURS)	5	49	0.60	128
EASY-CARES 40 (KREUKHERSTELLEND, DEFROISSABLE)	2.5	54	0.50	81
DELICATES 30 (FIJNE WAS, LINGE DELICAT)	2.5	50	0.30	54
WOOLLENS/  (Handwash) 30 (WOL, LAINE)	1	48	0.20	55

1) **Note:** Program setting for a test in accordance with EN 60 456. The consumption values can deviate from the stated values depending on the water pressure, hardness, inlet temperature, room temperature, type and quantity of washing, the washing powder/liquid used, fluctuations in the mains voltage and selected additional functions.

What Does "Update" Mean?

The washing programs of your washing machine are controlled by software.

New types of textiles or new washing powders/liquids could, in the future, require new washing programs. The software can be adapted to these in most cases.

When new washing programs are available, you can also use them in your washing machine by having the software updated.

For further information on the "Update", consult the Customer Service.

You can also ask the Customer Service about the costs of an "Update".

Water Protection Aqua Control

In the event of damage to the supply hose, the system blocks the further supply of water to the unit directly at the water tap.

If water escapes elsewhere, the drainage pump automatically pumps off – even if the unit is switched off. The washing machine merely has to be connected to the electricity mains.

Before the First Wash

-  Carry out a washing operation without washing (COTTONS/WITTE WAS, BLANC 95 °C, with half the quantity of washing powder/liquid). This removes residues left over from production on the drum and solution container.

Prepare the Washing Cycle

Sort and Prepare the Washing

- Sort the washing according to care codes and type (see "Washing Types and Care Codes").
- Empty pockets.
- Remove metal parts (paper clips, safety pins etc.).
- To prevent washing damage and washing snags: Close zip fasteners, button closed bed covers and pillow cases, and tie together ribbons, e.g. on aprons.
- Use clothing made of double-layer fabric (sleeping bag, anorak etc.).
- On knitted, coloured textiles and on wool and textiles with fitted decorations: Turn inside out.
- Wash small and sensitive items (baby socks, stockings, tights, bras etc.) in a washing net, a cushion with a zip fastener or in larger socks.
- Treat curtains with particular care. Remove small metal rollers or small, burred rollers or tie them in a net or in a bag. We cannot accept any liability for damage.
- Do not wash coloureds and whites together in one washing cycle. Otherwise, whites will discolour or turn grey.
- New coloureds often contain surplus dye. It is best to wash such items separately the first time.
- Mix small and large items of washing! This speeds up the effect of washing and the washing is more favourably distributed during spinning.
- Loosen up the washing before loading it into the washing machine.
- Put the washing into the drum folded out.
- Pay attention to the care instructions "Wash separately" and "Wash separately several times"!

Washing Types and Care Codes

The care codes help you choose the correct washing program. The washing should be sorted according to type and care code. The temperatures stated in the care codes are all maximum values.

Cottons

Textiles made of cotton and linen with this care code are insensitive to mechanical stress and high temperatures. The program COTTONS/LINEN (WITTE/BONTE WAS, BLANC/COULEURS) is suitable for this type of washing.

Linen

Textiles made of cotton and linen with this care code are insensitive to mechanical stresses. The program COTTONS/LINEN (WITTE/BONTE WAS, BLANC/COULEURS) is suitable for this type of washing.

Easy-Care Garments

Textiles such as finished cottons, cotton mixtures, viscose and synthetics with this care code require mechanically more mild treatment. The program EASY-CARES/EASY IRON (KREUKHERSTELLEND, DEFROISSABLE/STRIJKVRIJ, SANS REPASSAGE) is suitable for this type of washing.

Delicates

Textiles such as layered fibres, microfibres, viscose, synthetics and curtains with this care code require very gentle treatment. The program DELICATES (FIJNE WAS, LINGE DELICAT) is suitable for this type of washing.

Wool and Very Sensitive Washing

Textiles such as wool, wool mixtures and silk with this care code are especially sensitive to mechanical stresses. The program WOOLLENS (WOL, LAINE)  (handwash) is suitable for this type of textiles.

Attention! Textiles with the care code  (Do not wash!) must not be washed in the washing machine!

Washing Detergents and Care Agents

Which washing detergent and care agent?

Use only washing detergents and care agents which are suitable for use in washing machines. Always follow the manufacturer's instructions.

How much washing detergent and care agent?

The amount to be used depends on:

- the dirtiness of the washing
- the hardness category of the mains water supply
- the filling quantity



If the detergent manufacturer gives no details of the dosing quantities for minimum loads, add one third less for half loads and, in the case of very small loads and for EASY IRON (STRIJKVRIJ, SANS REPASSAGE), only half the amount of detergent recommended for a full load.

Refer to the detergent/care agent manufacturer's instructions on use and dosage.

Water Softener

For medium to high water hardness (hardness category II or higher) you should use water softener. Pay attention to the manufacturer's instructions. Always then meter detergent for hardness category I (= soft). The responsible water works can provide information on the local water hardness.



Since the water softener is added before the main washing detergent, (water pre-softening), eighty percent of the softener quantity stated on the package is sufficient.

Water Hardness Details

Hardness Category	Water Hardness °dH (degrees German hardness)	Water Hardness in mmol/l (millimol per litre)
I – soft	0 - 7	up to 1.3
II – medium hard	7 - 14	1.3 - 2.5
III – hard	14 - 21	2.5 - 3.8
IV – very hard	over 21	over 3.8

Run a Washing Cycle

Brief Instructions

A washing cycle is run in the following steps:

1. Set the correct washing program:
 - Set the program and temperature with the program selector
 - Set any additional program(s)
2. Change the spin speed if necessary / select RINSE HOLD (GEEN CENTR., SANS ESSOR.).
3. Set DELAY TIMER (STARTTIJDKEUZE, DEPART DIFFERE) if necessary.
4. Open the filling door and fill with washing.
5. Close the filling door.
6. Add washing detergent/care agent.
7. Start the washing program.

After the Washing Program Ends:

Attention! If the washing cycle ended with Rinse Hold, before opening the filling door carry out PUMP (POMPEN, VIDANGE), SPIN (CENTRIFUG., ESSORAGE) or SHORT SPIN (KORT CENTRIFUG., ESSOR. DELICAT).

8. Open the filling door and remove the washing.
9. Switch off the washing machine: Set the program selector to OFF (UIT, ARRET).

Set the Washing Program

i For a suitable program, the right temperature and possible additional programs for the relevant washing type, refer to the "Program Tables".

- 1.** Set the program selector to the required washing program with the required temperature.

The probable duration of the set program in minutes is shown in the multi-display.

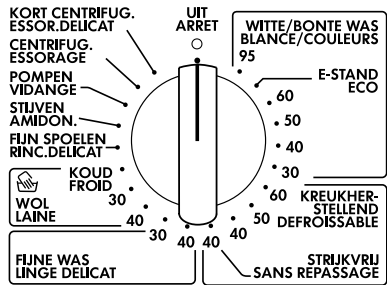

- 2.** Select any additional programs:

The indicator for the selected additional program lights up.

- Press another button to make different selection.
- Press the button again to deselect.

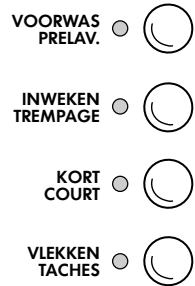

Change Spin Speed / Select Rinse Hold



If necessary, change the spin speed for the final spin / select RINSE HOLD (GEEN CENTR., SANS ESSOR.):
Press the button Spin speed/RINSE HOLD (GEEN CENTR., SANS ESSOR.) as often as necessary until the display for the required spin speed (or of RINSE HOLD/GEEN CENTR., SANS ESSOR.) lights up.

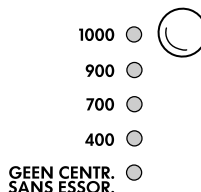

If RINSE HOLD (GEEN CENTR., SANS ESSOR.) is selected, the washing remains in the last rinsing water and is not spun.



If you do not change the spin speed, the final spin is automatically adapted depending on the washing program:

- COTTONS/LINEN (WITTE/BONTE WAS, BLANC/COULEURS) 1000 revolutions per minute
- EASY-CARES/EASY IRON (KREUKHERSTELLEND, DEFROISSABLE/STRIJKVRIJ, SANS REPASSAGE) 900 revolutions per minute
- DELICATES (FIJNE WAS, LINGE DELICAT) 700 revolutions per minute
- WOOLLENS (WOL, LAINE)/ (Handwash) 900 revolutions per minute

The speed of the intermediate spin depends on the selected program and cannot be changed.

Set the Delay Timer/Soaking Duration

Delay Timer

The button DELAY TIMER (STARTTIJDKEUZE, DEPART DIFFERE) allows the start of a washing program to be advanced by 1 to a maximum of 19 hours.



To do this, press the button DELAY TIMER (STARTTIJDKEUZE, DEPART DIFFERE) as often as necessary until the required start delay is shown in the multidisplay, e.g. 12h in the form for a program start delay of 12 hours. If 19h is shown and you press again, 0h and afterwards the run time of the set washing program appears (display in minutes, e.g. 129). In this state, the delay timer is not set.



Soaking Duration

With the SOAKING (INWEKEN, TREMPAGE) button pressed, you can extend the soaking duration with the button DELAY TIMER (STARTTIJDKEUZE, DEPART DIFFERE) (maximum 10 hours and approx. 20 min.).



Without delay timer, the soaking duration is approx. 30 minutes, plus a pre-wash time of approx. 20 minutes.



To set, press the button DELAY TIMER (STARTTIJDKEUZE, DEPART DIFFERE) as often as necessary until the required soaking duration is shown in the multidisplay, e.g. 1h (= 1 hour).

After approx. 2 seconds, the multidisplay shows the run time in minutes.



LOOPTIJD
TEMPS
RESTANT

STARTTIJDKEUZE
DEPART DIFFERE



This run time is comprised as follows:

selected soaking period	e.g.	1h = 60 minutes
+ heating up/prewash period	e.g.	approx. 20 minutes
+ run time of the selected washing program	e.g.	approx. 129 minutes
= displayed value	e.g.	approx. 209 minutes



While SOAKING (INWEKEN, TREMPAGE) is running, PRE WASH (VOORWAS, PRELAV.) lights up on the program sequence display.

Opening and Closing the Filling Door

 Open: Pull on the handle of the filling door.

DEUR
PORTE 

 Close: Press the filling door firmly closed.

The displays DOOR (DEUR/PORTE) and START/PAUSE (START/PAUZE, MARCHE/PAUSE) show whether the door can be opened while the appliance is switched on:

START/PAUZE
MARCHE/PAUSE  

Display DOOR (DEUR, PORTE)	Display START/PAUSE (START/PAUZE, MARCHE/PAUSE)	Opening door possible?
Glows green	Flashes red	Yes
Glows green	Glows red	Yes, after pressing button START/PAUSE (START/PAUZE, MARCHE/PAUSE)
Is off	Flashes or glows red	No ¹⁾

1) The main door is locked because of a high water level or a high temperature.



If

- the display DOOR (DEUR, PORTE) flashes red
- then the error code **E40** flashes in the multidisplay
- and the display MAIN WASH (HOOFDWAS, LAVAGE) flashes

you tried to start a washing program without first closing the main door properly. In this case push the door shut firmly and restart the washing program.

Add the Washing



For the maximum filling quantities, refer to the "Program Tables". For information on the correct preparation of the washing, see "Sort and Prepare the Washing".



1. Sort and prepare the washing according to type.
2. Open the filling door: Pull on the handle of the filling door.
3. Fill with washing.

Attention! When closing the door, make sure no items of washing get stuck! This could damage textiles and the unit.

4. Close the filling door securely.

Add Washing Detergent/Care Agent.

i Refer to the information on washing detergents and care agents, see section "Washing Detergents and Care Agents".

- 1.** Open the washing detergent drawer: grip inside the flap on the drawer at the bottom (1) and pull out the drawer as far as it will go (2).

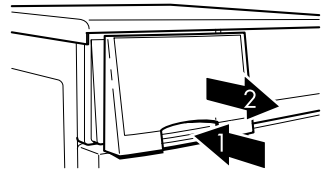

- 2.** Fill with washing detergent/ care agent

Compartment for in-wash stain treatment

Compartment for main washing powder

(If you use water softener and need the right compartment for the pre-wash / soaking agent, add the water softener to the main washing detergent in the left compartment.)

Compartment for liquid care agent
(Conditioner, finisher, starch)

Attention! Fill the compartment up to the MAX mark. If necessary, dilute viscous agent up to the MAX mark, and dissolve powder starch.

Compartment for pre-wash agent/soaking agent
(only for additional programs PRE WASH/VOORWAS, PRELAV. and SOAKING/INWEKEN, TREMPAGE)
or for water softener

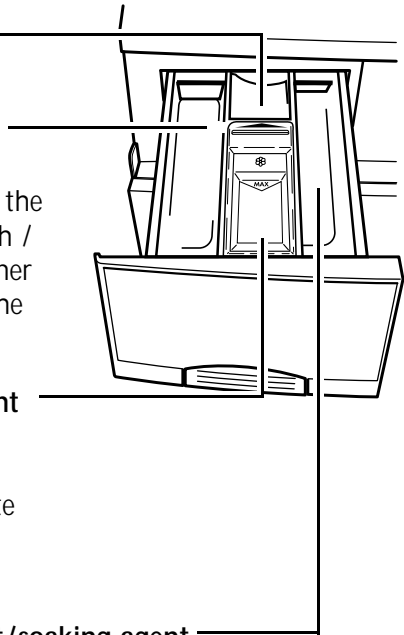

- 3.** Push the drawer fully in.

i **If using Liquid Detergent/Tabs:**

Add liquid detergent/tabs in the amount recommended by the washing detergent industry. Follow the instructions on the detergent package.

Start the Washing Program

1. Check that the water valve is open.
2. Start the washing program: Press the button START/PAUSE (START/PAUZE, MARCHE/PAUSE). The washing program is started or it starts after the set time expires.



- i** The filling door is not correctly closed if, when the button START/PAUSE (START/PAUSE, MARCHE/PAUSE) is pressed,
- the indicator DOOR (DEUR, PORTE) flashes red
 - the fault code **E40** in the multidisplay flashes
 - and the indicator MAIN WASH (HOOFDWAS, LAVAGE) flashes.
- In this case, press the filling door firmly closed and again press the button START/PAUSE (START/PAUZE, MARCHE/PAUSE).

If the time preselection is set:

A set time preselection runs and the remaining time until the program start is displayed (in each case in full hours, e.g. **5h**). During this time you can load washing or change/abort the time preselection.

- Load washing: Press the button START/PAUSE (START/PAUZE, MARCHE/ PAUSE). The filling door can be opened. Next, close the door and again press the button START/PAUSE (START/PAUZE, MARCHE/PAUSE).
- Change or abort time preselection: Press the button DELAY TIMER (STARTTIJDKEUZE, DEPART DIFFERE) as often as necessary until the required time is displayed; when the program run time is displayed (display in minutes, e.g. **129**), the washing program starts without delay.

Completion of the Washing Program

Program Sequence Display

Before the start, the program steps to be carried out are displayed by the program sequence display. The current program step is displayed during the washing program.

VOORWAS
PRELAVAGE ○
HOOFDWAS
LAVAGE ○
SPOELEN
RINCAGE ○
SPOELEN+
RINCAGE+ ○
CENTRIFUG
ESSORAGE ○
EINDE
FIN ○

Multi-Display

The expected remaining time (in minutes) is shown up to the program end in the multi-display.

129

LOOPTIJD
TEMPS
RESTANT ○



With automatic program adaptation by the controller of the washing machine (quantity of washing, type of washing, imbalance recognition, special rinse etc.), it is possible to stop or correct the counting of the remaining run time.

Changing a Washing Program

Changing or aborting a program

1. Press button START/PAUSE (START/PAUZE, MARCHE/PAUSE).
2. Turn programme knob to OFF (UIT, ARRET). The washing program is aborted.
3. If required, set a new washing program. Otherwise turn the programme knob to PUMP OUT (POMPEN, VIDANGE) and then press the button START/PAUSE (START/PAUZE, MARCHE/PAUSE).



The washing program can be interrupted at any time with the button START/PAUSE (START/PAUZE, MARCHE/PAUSE) and continued by pressing the button again. Changing the washing program is possible only after the programme knob was turned to OFF (UIT, ARRET).

Select the Additional Program

The additional programs QUICK WASH (KORT, COURT) or STAIN (VLEKKEN, TACHES) can also be selected after the program start.

1. Press the button START/PAUSE (START/PAUZE, MARCHE/PAUSE).
2. Press the button QUICK WASH (KORT, COURT) or the button STAIN (VLEKKEN, TACHES).
3. Press the button START/PAUSE (START/PAUZE, MARCHE/PAUSE) again.
The washing program is continued.

Change the Spin Speed

During the washing program, the spin speed can still be changed or RINSE HOLD (GEEN. CENTR., SANS ESSOR.) can be set.

1. Press the button START/PAUSE (START/PAUZE, MARCHE/PAUSE).
2. Change the speed with the button Spin/RINSE HOLD (GEEN CENTR., SANS ESSOR.).
3. Press the button START/PAUSE (START/PAUZE, MARCHE/PAUSE) again.
The washing program is continued.

Washing Cycle Ended/Remove Washing

After a washing program has ended, END (EINDE, FIN) lights up on the program sequence display.

If you selected RINSE HOLD (GEEN CENTR., SANS ESSOR.), the indicator next to the button START/PAUSE (START/PAUZE, MARCHE/PAUSE) flashes.

-  1. After a rinse hold, it is first necessary to pump off the water:
- Press either the button START/PAUSE (START/PAUZE, MARCHE/PAUSE) (water is pumped off and the washing is spun according to the program which has just run; after pressing the button START/PAUSE (START/PAUZE, MARCHE/PAUSE) again, the spin speed can also still be changed during spinning),
 - or
 - turn the program selector to PUMP (POMPEN, VINDAGE) and press the button START/PAUSE (START/PAUZE, MARCHE/PAUSE) (water is pumped off without spinning)
 - or
 - turn the program selector to SPIN (CENTRIFUG., ESSORAGE) or SHORT SPIN (KORT CENTRIFUG., ESSOR. DELICAT) and press the button START/PAUSE (START/PAUZE, MARCHE/PAUSE) (water is pumped off and the washing is spun or gently spun).

After the end of this program step, the indicator END (EINDE, FIN) lights up.

2. Open the filling door.
As soon as the indicator DOOR (DEUR, PORTE) lights up green, the filling door can be opened.
3. Remove the washing.
4. Turn the program selector to OFF (UIT, ARRET).
5. After washing, pull out the washing detergent drawer slightly so that it can dry out. Only lean the door against the washing machine so that the latter can air out.



If the display OVER DOSING (OVERDOS., SURDOSAGE) lights up, too much washing detergent was used in the washing program just ended. During the next wash, pay attention to the dosing information of the washing detergent manufacturer and pay attention to the filling quantity!





OVERDOS.
SURDOSAGE 







Attention! If the washing machine is not used for a long time: Close the water tap and disconnect the washing machine from the electricity mains. (The Aqua Control water protection does not function if the power supply is interrupted).

Program Tables

Washing

Not all possible settings are listed below - only the ones most commonly used in everyday operation and the most appropriate ones.

Type of Washing, Care Codes	Max. Filling Quantity (dry weight) ¹⁾	Program Selector Temperature	Possible Additional Programs
Cottons 	5 kg	COTTONS/LINEN (WITTE/BONTE WAS, BLANC/COULEURS) 95	PRE WASH (VOORWAS, PRELAV.) SOAKING (INWEKEN, TREMPAGE) QUICK WASH (KORT, COURT) STAIN (VLEKKEN, TACHES)
Energy-Saving Program: Cottons 	5 kg	COTTONS/LINEN (WITTE/BONTE WAS, BLANC/COULEURS) ENERGY SAVING (E-STAND, ECO)	PRE WASH (VOORWAS, PRELAV.) SOAKING (INWEKEN, TREMPAGE) STAIN (VLEKKEN, TACHES)
Linen  	5 kg	COTTONS/LINEN (WITTE/BONTE WAS, BLANC/COULEURS) 30 to 60	PRE WASH (VOORWAS, PRELAV.) SOAKING (INWEKEN, TREMPAGE) QUICK WASH (KORT, COURT) STAIN (VLEKKEN, TACHES)

Type of Washing, Care Codes	Max. Filling Quantity (dry weight) ¹⁾	Program Selector Temperature	Possible Additional Programs
Easy-Cares  	2.5kg	EASY-CARES (KREUKHERSTELLEND, DEFROISSABLE) 40 to 60	PRE WASH (VOORWAS, PRELAV.) SOAKING (INWEKEN, TREMPAGE)
	1kg	EASY IRON ²⁾ (STRIJKVRIJ, SANS REPASSAGE) 40	QUICK WASH (KORT, COURT) STAIN (VLEKKEN, TACHES)
Delicates 	2.5kg (or 15-20m ² curtains)	DELICATES (FIJNE WAS, LINGE DELICAT) 30, 40	PRE WASH (VOORWAS, PRELAV.) SOAKING (INWEKEN, TREMPAGE) QUICK WASH (KORT, COURT) STAIN (VLEKKEN, TACHES)
Woollens/ Handwash   	2kg	 WOOLLENS (WOL, LAINE), COLD (KOUD, FROID) to 40	

1) A 10-litre bucket holds approx. 2.5kg of dry washing (cottons).

2) Only if a filling quantity of 1kg is observed are creases in the washing largely avoided.

5 to 7 easy-care men's shirts are equivalent to about 1kg of dry washing.

Separate Conditioning/Starching/Impregnating

Type of Washing	Max. Filling Quantity (dry weight)	Program Selector
Cottons/Linen	5kg	STARCHING (STIJVEN, AMIDON.)

Separate Rinse

Type of Washing	Max. Filling Quantity (dry weight)	Program Selector
Cottons/Linen	5kg	GENTLE RINSE (FIJN SPOELEN, RINC. DELICAT)
Easy-Cares	2.5kg	
Delicates	2.5kg	
Woolens/Handwash	2kg	

Separate Spin

Type of Washing	Max. Filling Quantity (dry weight)	Program Selector
Cottons/Linen	5kg	SPIN (CENTRIFUG., ESSORAGE)
Easy-Cares	2.5kg	SHORT SPIN (KORT CENTRIFUG., ESSOR. DELICAT)
Delicates	2.5kg	
Woolens/Handwash	2kg	

Cleaning and Care

Control Panel

Attention! For cleaning panels and control parts, do not use furniture polish or any aggressive cleaning agents.

- ☞ Wipe off control panels with a damp cloth. Use warm water to do this.

Washing Detergent Drawer

The washing detergent drawer should be cleaned from time to time.

- ☞ 1. Pull out the washing detergent drawer as far as it will go.
- 2. Remove the washing detergent drawer with a firm pull.
- 3. Remove the softener insert from the middle compartment.

- 4. Clean the softener insert under running water.

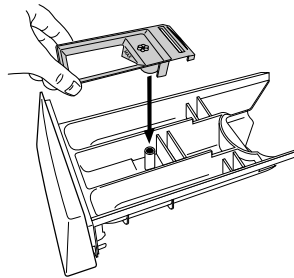

- 5. Clean the compartments from the rear with warm water. It is best to use a bottle brush.

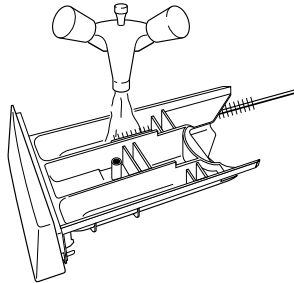

- 6. Push on the softener insert as far as it will go so that it is secure.

7. Use a brush to clean the entire rinsing-in part of the washing machine, especially the nozzles on the top side of the rinsing-in chamber.

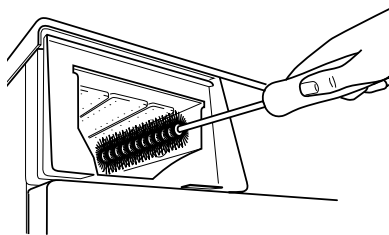

8. Insert the washing detergent drawer into the guide rails and push it in.

Washing Drum

The washing drum is made of high-quality stainless steel. Rust deposits on the drum can occur due to foreign bodies in the washing which can cause rust.

Attention! Do not clean the stainless steel drum with acidic antiliming agents, scouring agents containing chlorine or iron or steel wool. Our Customer Service Department has suitable agents available.

- ☞ Remove any rust deposits on the drum using a stainless steel cleaning agent.

Filling Door

- ☞ Check regularly whether there are deposits or foreign bodies in the rubber sleeve behind the filling door and, if so, remove them.

What to do if ...

Remedying Faults

In the event of a fault, try to solve the problem yourself with the aid of the information provided here. If you call Customer Service to deal with one of the faults listed here or to remedy an operating fault, the customer service technician's visit will not be free of charge, even during the warranty period.

- If the fault code **E 10**, **E20** or **E40** is shown in the multidisplay, you may be able to remedy the fault yourself (see Faults Table below).



After remedying the fault, press the button START/PAUSE (START/PAUZE, MARCHE/PAUSE). If the fault code is shown again, inform Customer Service.

- In the case of all other displayed faults (**E** and number or letter), please inform the Customer Service and state the fault code.

Problem	Possible Cause	Remedy
The washing machine does not work.	The mains plug is not plugged in.	Plug in the mains plug.
	The fuse of the building's wiring is not in order.	Replace the fuse.
	The filling door is not correctly closed.	Close the filling door; the lock must engage audibly.
	The button START/PAUSE (START/ PAUZE, MARCHE/ PAUSE) was not pressed for long enough.	Press the button START/ PAUSE (START/ PAUZE, MARCHE/PAUSE) until the program begins.
The filling door cannot be closed.	The child lock is set.	Cancel the child lock (see section „Child Safety Feature“).
Fault code E40 appears. The indicator MAIN WASH (HOOFD-WAS, LAVAGE) flashes.	The filling door is not correctly closed.	Close the filling door correctly. Restart the program.

Problem	Possible Cause	Remedy
No water runs in. Fault code E 10 appears. The indicator RINSE+ (SPOELEN+, RINCAGE+) flashes.	Water valve is closed.	Open the water valve.
	Filter in screw connection of the intake hose is blocked.	Close the water valve. Unscrew the hose from the water valve, remove the filter and clean it under running water.
The washing machine vibrates during operation or it is on an uneven surface.	The height-adjustable screw feet are not correctly set.	Adjust in accordance with the installation and connection instructions.
	There is not much washing in the drum (e.g. only one dressing gown).	This does not impair the function.
	The water could not be completely pumped off before spinning because the drainage hose is bent or the solution pump is blocked.	Check the laying of the drainage hose and eliminate the bend if necessary, or clean the solution pump and, if required, remove foreign bodies from the pump housing.
The washing solution of the main wash froths up a lot.	Too much detergent was probably used.	Meter the detergent exactly in accordance with the manufacturer's information.
Water runs out under the washing machine.	The screw connection on the intake hose is leaky.	Tighten the intake hose screw connection.
	The drainage hose is leaky.	Check the drainage hose and replace it if necessary.
	The washing solution pump cover is not correctly closed.	Close cover correctly.
	Washing stuck in the filling door.	Stop the program, remove washing from the filling door, start a new program.
	The emergency drain hose is not properly shut off or it is not water-tight.	Shut the emergency drain hose off properly (see section "Performing an Emergency Drain"). Call your after-sales service if the emergency drain hose is not water-tight.

Problem	Possible Cause	Remedy
Fault code EFO appears.	The anti-flood system Aqua Control has responded.	Close the water tap. Turn the programme knob to OFF (UIT, ARRET). Call your after-sales service.
Conditioner not added, compartment  for care agent full of water.	Softener insert in the compartment for care agent not correctly attached or is blocked.	Clean the detergent drawer and firmly attach the softener insert.
Washing heavily creased.	Too much washing probably put in.	Pay attention to the maximum filling quantity (see Program Tables). For easy-care textiles, select the program EASY IRON (STRIJKVRIJ, SANS REPASSAGE).
Washing not well spun. Residual water still visible in the drum. Fault code E20 appears. The indicator RINSE (SPOELEN, RINCEGE) flashes.	Drainage hose bent.	Remove the bend.
	Maximum pump head (outlet head 1 m from unit's floor surface) exceeded.	Consult Customer Service. They can supply a retrofit kit as a special accessory for delivery heads of more than 1 m.
	Solution pump blocked.	Switch off the unit and pull out the mains plug. Clean the solution pump.
	If a siphon is connected: Siphon blocked.	Clean the siphon.
The main door cannot be opened while the appliance is turned on.	The main door is locked because of a high water level or a high temperature. The display DOOR (DEUR, PORTE) is not lit.	Wait until the display DOOR (DEUR, PORTE) lights up green.
		Should it nevertheless be necessary to open the main door: Turn the programme knob to OFF (UIT, ARRET); turn the programme knob to PUMP OUT (POMPEN, VIDANGE). Press button START/PAUSE (START/PAUZE, MARCHE/ARRET). The main door can be opened after the water has been pumped out.

Problem	Possible Cause	Remedy
Washing detergent residues form in the washing detergent drawer.	Water valve not fully opened.	Open the water valve fully.
	Filter in the screw connection of the intake hose on the water valve or on the unit is blocked.	Close the water valve. Unscrew the intake hose from the water tap and from the unit. Clean the filter.
The rinsing water is murky.	The cause is probably a detergent with a high silicate content.	No negative influence on the rinsing result, use liquid detergent if necessary.
The corresponding display does not light up when one of the additional program buttons is pressed.	The selected additional program cannot be combined with the set program.	Make another selection.

If the washing result is not satisfactory

If the washing is grey and limescale forms in the drum

- Not enough washing detergent added.
- The right washing detergent was not used.
- Special types of stain were not pretreated.
- Program or temperature incorrectly set.
- If binary washing detergents were used, the individual components were not added in the correct ratio.

If there are still grey stains on the washing

- Washing contaminated with creams, grease or oils was washing with too little detergent.
- Washing at too low temperature.
- A frequent cause is that conditioner – particularly concentrated form, ended up on the washing. Wash out such stains as quickly as possible and carefully use the right conditioner.

If foam is still visible after the final rinse

- Modern washing detergents can still produce foam, even in the final rinse. The washing is still sufficiently rinsed.

If there are white residues on the washing

- These are the insoluble components of modern detergents. They are not the result of an insufficient rinsing effect. Shake or brush off the washing. Perhaps in future you should turn the washing before washing it. Check the choice of detergent and use a liquid detergent if necessary.

Carry Out an Emergency Emptying Operation

- When the washing machine no longer pumps off the washing solution, an emergency emptying operation must be carried out.
- When the washing machine is in a room where there is a frost risk, an emergency emptying operation must be carried out when there is a frost risk.

Also: Unscrew the intake hose from the water tap and lay it on the floor. Empty the drainage hose.



Warning! Switch off the washing machine before carrying out an emergency emptying operation and pull out the mains plug.

Caution! The washing solution running out of the emergency emptying hose can be hot. Risk of scalding! Allow the washing solution to cool down before carrying out emergency emptying.

 **1.** Provide a flat collecting vessel to catch the washing solution as it runs out.

2. Open the flap downwards in the right part of the base panel and pull it off.

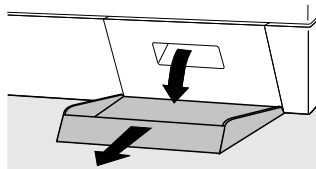

3. Remove the emergency emptying hose from the holder.

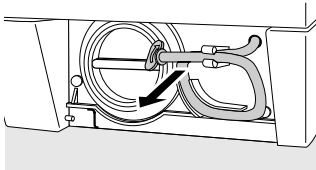

4. Place the collecting vessel underneath.

5. Release and pull out the plug of the emergency emptying hose by turning it anticlockwise.

The washing solution drains off. Depending on the amount of solution, it may be necessary to empty the collecting vessel several times. To do this, temporarily close the emergency emptying hose again with the plug.

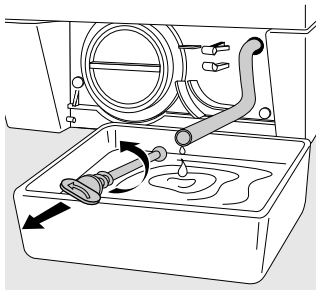

When all the washing solution has drained off:

6. Firmly push the plug into the emergency emptying hose and turn it tight clockwise.
7. Put the emergency emptying hose back into the holder.
8. Insert the flap into the base panel and close.

Clean the Solution Pump

Warning! Before cleaning the solution pump, switch off the washing machine and pull out the mains plug!



1. First carry out an emergency emptying (see the above section "Carry Out Emergency Emptying").
2. Place a wiping cloth on the floor in front of the cover of the solution pump. Residual water can run out.
3. Unscrew the solution pump cover anti-clockwise and pull it out.

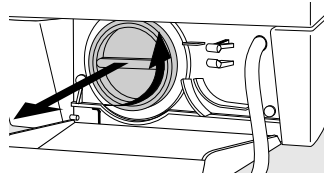

4. Remove any foreign bodies from the pump housing.

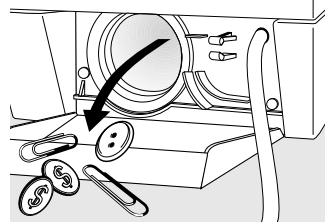

5. Replace the cover. Insert the webs on the cover laterally into the guide slots and screw the cover firmly into place clockwise.

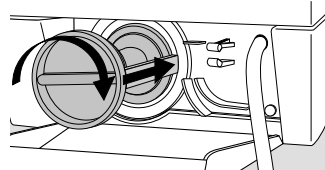

6. Close the emergency emptying hose and place it in the holder.
7. Close the flap.

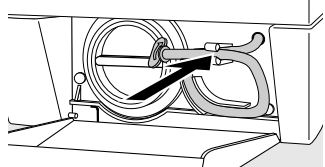

Emergency Unlocking of the Filling Door

When the filling door can no longer be opened, it can be opened with the aid of the emergency unlocking facility.

1. If you can see water in the viewing window of the filling door, first carry out an emergency emptying operation (see section "Emergency Emptying").
2. Open the flap downwards in the right part of the base panel.
3. Turn the rotary knob clockwise slightly with the aid of a coin. And hold it in this position.
4. Next, open the filling door by pulling on the door handle.

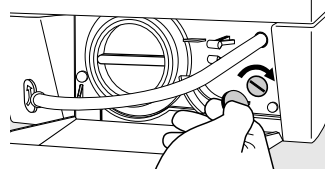

Additional Rinse (RINSE+/SPOELEN+/RINCAGE+)

The washing machine is set for extremely economical water consumption. However, for persons who suffer from allergies, it can be helpful to rinse with more water.



If RINSE+ (SPOELEN+, RINCAGE+) is set, an additional rinse is performed in the case of the programs COTTONS/LINEN (WITTE/BONTE WAS, BLANC/COULEURS), EASY-CARES (KREUKHERSTELLEND, DEFROISSABLE)/EASY IRON (STRIJKVRIJ, SANS REPASSAGE) and DELICATES (FIJNE WAS, LINGE DELICAT).

No additional rinse is set when the unit is delivered.

Set Additional Rinse:



1. Turn the program selector to COTTONS/LINEN (WITTE/BONTE WAS, BLANC/COULEURS), EASY-CARES/EASY IRON (KREUKHERSTELLEND, DEFROISSABLE/STRIJKVRIJ, SANS REPASSAGE) or DELICATES (FIJNE WAS, LINGE DELICAT) with any temperature.
2. Simultaneously keep the button PRE WASH (VOORWAS, PRELAV.) and the button QUICK WASH (KORT, COURT) pressed for at least 2 seconds. RINSE+ (SPOELEN+, RINCAGE+) lights up on the program run indicator. The additional rinse is set. It remains saved until you cancel it again.



The additional rinse increases water consumption and the program run time.

Cancel Additional Rinse:



1. Again turn the program selector to COTTONS/LINEN (WITTE/BONTE WAS, BLANC/COULEURS), EASY-CARES/EASY IRON (KREUKHERSTELLEND, DEFROISSABLE /STRIJKVRIJ, SANS REPASSAGE) or DELICATES (FIJNE WAS, LINGE DELICAT).
2. Simultaneously keep the button PRE WASH (VOORWAS, PRELAV.) and the button QUICK WASH (KORT, COURT) pressed for at least 2 seconds. RINSE+ (SPOELEN+, RINCAGE+) goes out in the program run indicator. The additional rinse is cancelled.

Child Safety Feature

When the child safety feature is used, the filling door can no longer be closed and no more washing programs can be started.

Setting the Child Safety Feature:

- ☞ Use a coin to turn the rotary knob (on the inside of the filling door) clockwise as far as it will go.

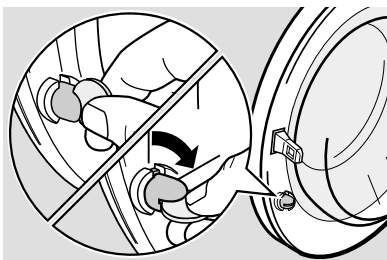

- ⚠ **Warning!** The rotary knob must not be pressed in following adjustment, otherwise the child safety feature is not active. The rotary knob must project as shown in the diagram.

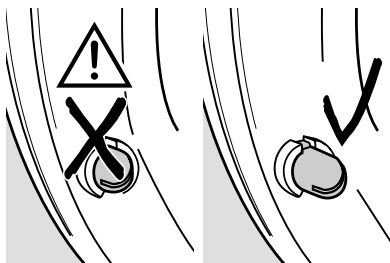

Cancelling the Child Safety Feature:

- ☞ Turn the rotary knob anticlockwise as far as it will go.

SETTING UP AND CONNECTION INSTRUCTIONS

Safety Instructions for Installation

- Do not tilt the washing machine onto its front or onto its right side (looking from the front). Electrical components could get wet!
- Check the washing machine for transport damage. Never connect a damaged unit. Consult your supplier in the event of damage.
- Ensure that all parts of the transport safeguard have been removed and that the splash guard is fitted to the unit, see "Removing the Transport Safeguard". Otherwise, damage to the unit or to adjacent furniture could occur during spinning.
- Always insert the plug into a correctly installed PE socket.
- In the case of permanent installation: A permanent installation may only be made by an authorised specialist.
- Before putting the unit into operation, ensure that the rated voltage and current type shown on the unit's rating plate are the same as the mains voltage and current type at the installation location. The required electrical fuse is also shown on the rating plate.
- The mains cable may only be replaced by the Customer Service or by an authorised specialist.

Setting Up the Unit

i Washing machines with curved panels are **not suitable for substructures**.

Transporting the Unit

- Do not place the washing machine on its front side or on its right side (looking from the front). Otherwise the electrical components can get wet.
- Never transport the unit without using the transport safeguard. Do not remove the transport safeguard until you reach the installation site. Transporting the unit without the transport safeguard can result in damage to the unit.
- Never lift the unit by the open filling door or by its base.

When transporting the unit with a sack trolley:

- Attach the sack trolley only at the side. The scoop of the sack trolley must not be longer than 24cm, otherwise the float switch can be destroyed.

Remove the Transport Safeguard

Attention! It is essential to remove the transport safeguard before putting the unit into operation! Keep all parts of the transport safeguard in a safe place for possible later transport (moving house).

- 1.** Open both hose holders on the rear of the unit and remove the hoses and the mains cable.

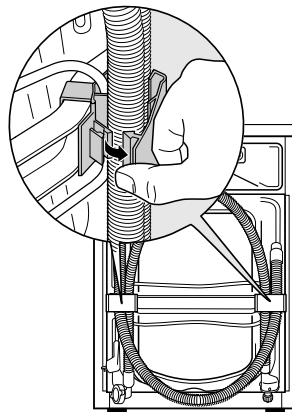

2. Firmly pull both hose holders off the unit.

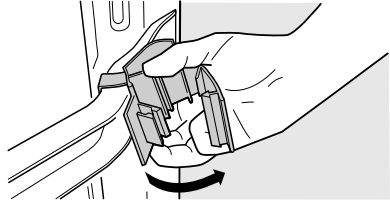

i The special button E and the plug caps D (2 ea.) and G (1 ea.) are supplied with the unit.

3. Unscrew the two screws A using the special button E.
4. Unscrew the four screws B using the special button E.
5. Remove the transport rail C.
6. Screw the four screws B back in.
7. Close off the two large holes with the plug caps D.

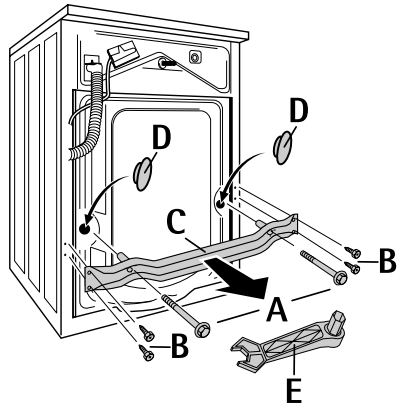

Attention! Push in the plug caps so firmly that they engage in the rear panel (this protects the inside of the unit against splash water).

8. Remove the screw F, including the sleeve, compression spring and washer, with the special button E.
9. Close off the hole with the plug cap G.

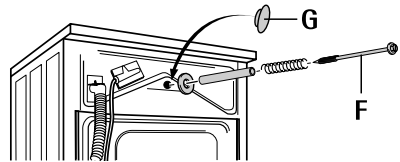

Attention! Push in the plug cap so firmly that it engages in the rear panel (this protects the inside of the unit against splash water).

Prepare the Installation Location

- The installation surface must be clean, dry and free of floor wax residue and other lubricating coatings so that the unit does not slide away. Do not use any lubricants as sliding aids.
- It is not recommended to set up the washing machine on deep-pile carpets or on floor coverings with soft foam underlays, as this would mean that the stability of the unit would not be guaranteed.
- Use ordinary rubber mats as underlays in locations with small-format tiles.
- Never use wood, card or similar underlays to compensate for minor floor unevenness. Always use the adjustable screw-type feet of the machine.
- If, for reasons of space, it is not possible to avoid setting up the unit next to a gas cooker or coal stove: Insert a thermally-insulating panel between the washing machine and the cooker (85 x 57 cm). This panel must have an aluminium foil on the side against the cooker.
- The washing machine must not be set up in a room where there is a danger of frost. Frost damage!
- The intake and drainage hoses must not be bent or pinched.

Setting Up on a Concrete Pedestal

When setting up the washing machine on a concrete pedestal, it is essential for safety reasons to fit stand plates in which the washing machine is then adjusted. The stand plates are available from the Customer Service under spare part number 645 425 058.

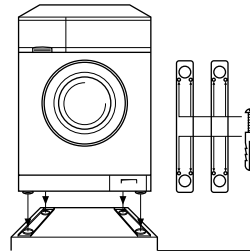

Setting Up on a Vibrating floor

In the case of vibrating floors, especially wooden beam floors with flexible boards, securely screw a water-resistant wooden panel at least 15mm thick onto at least 2 of the floor beams. If possible, set up the unit in a corner of the room where the wooden floor is best firmly installed and is therefore least likely to be susceptible to vibrations.

Compensate for Floor Unevenness

Floor unevenness can be compensated for and the height can be corrected with the four adjustable screw feet. The height can be adjusted in a range of +10 ... -5 mm.

To adjust the feet use the special spanner supplied for removing the transport braces.

1. Slide the special key firmly onto the hexagon head of the threaded foot as far as it will go.
2. Adjust the screw feet so that the unit is horizontal and stable. The unit must not wobble over when loaded.
3. If necessary, check the setting with a spirit level.

Attention! Never compensate for minor floor unevenness with underlays made of wood, card etc. Always adjust the adjustable feet.

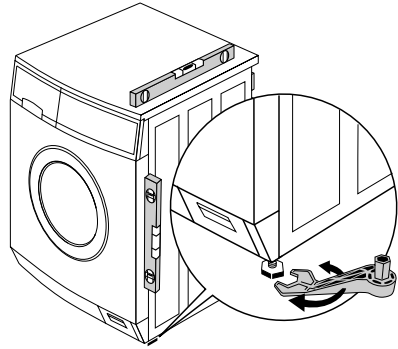

Electrical Connection

Refer to the rating plate for details of the mains voltage, current type and the necessary fuses. The rating plate is located at the top behind the filling door.

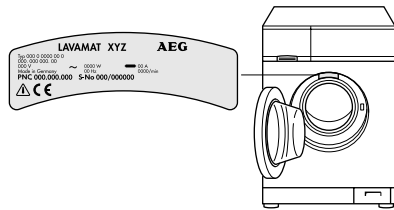

CE This unit conforms to the following EU directives:

- the "Low Voltage Directive" 73/23/EU with changes
- the "EMC Directive" 89/336/EEG with changes

Water Connection

i The washing machine has safety features which prevent contamination of the drinking water and which conform to the legal regulations of the water authorities (e.g. for Germany: DVGW regulations). Other protection measures in the installation are therefore not necessary.

Attention!

- Units for connection to cold water must not be connected to hot water!
- Use only new sets of hoses for connection!

Permissible Water Pressure

The water pressure must be at least 1 bar (= 10N/cm² = 0.1MPa), maximum 10bar (= 100N/cm² = 1MPa).

- In the case of more than 10bar: Connect a pressure-reducing valve upstream.
- In the case of less than 1 bar: Unscrew the intake hose on the unit side on the inlet solenoid valve and remove the flow regulator (to do this, remove the filter with pointed pliers and remove the rubber washer behind). Replace the filter.

Water Inflow

A pressure hose 1.5 m in length is supplied.

If a longer inflow hose is required, only a VDE-approved, complete set of hoses with fitted hose screw connections offered by our Customer Service is permissible.

- Sets of hoses in lengths of 2.2 m, 3.5 m and 5 m are available for washing machines without Aqua-Control.
- Sets of hoses in lengths of 2.0 m, 2.9 m and 3.9 m are available for washing machines with Aqua-Control.

Attention! Never cut into pieces in order to extend the hoses!



Sealing rings are supplied either in the plastic nuts of the hose screw connection or in the enclosed pack. Do not use other seals!

1. Connect the hose with the angled connection to the machine.

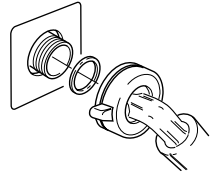

Attention!

- Do not lay the supply hose vertically downwards. Rather, turn it to the right or left as shown in the diagram.
- Only tighten the screw connection manually.

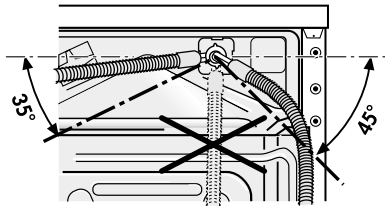

2. Connect the hose with the straight connection to a water tap with a screw thread of R 3/4 (inches).

Attention! Only tighten the screw connection manually.

3. By slowly opening the water tap before putting the washing machine into operation, check whether the connection is free of leaks.

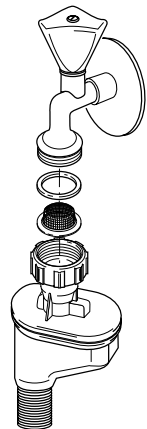

Water Drainage

The drainage hose can either be connected to a siphon or hung in a wash basin or bath tub.

Only original hoses may be used for extension purposes (max. 3m on the floor and then up to 80cm high). The Customer Service stocks hoses in lengths of 2.7 and 4m.

Attention! It is absolutely essential to install the drainage hose free of pinches.

Water Drainage into a Siphon

The grommet on the end of the hose fits all commonly used siphon types.



Secure the grommet/siphon connecting point with a hose clamp.

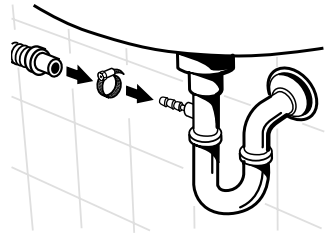

Draining the water into a basin

Attention!

– Small basins are not suitable for draining the water into them.

Water could overflow!

– It is not permitted to submerge the end of the drainage hose into the pumped-off water. Water could be sucked up into the hose!

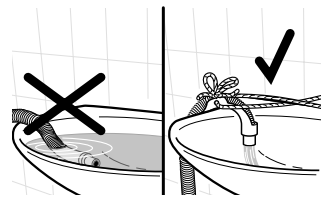

– When hooked into a wash-basin or a bath tub the drainage hose must be protected from slipping out of place by the supplied slip-on elbow. Otherwise the repelling power of the draining water can press the hose out of the sink.



Fix the elbow to the water tap or to the wall with string.

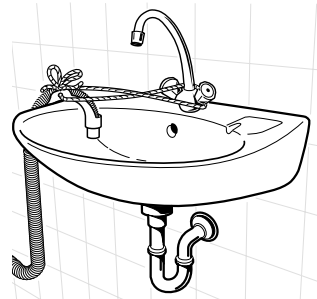

Delivery Heads over 1 m

To pump off the washing / rinsing agent, every washing machine has a pump which transports liquids via the drainage hose up to a height of 1 m, calculated from the machine's floor.

For delivery heads over 1 m, consult the Customer Service.

Technical Data

Height adjustment
Filling quantity
(program-dependent)
Use
Drum speed, spin
Water pressure

Approx. +10/-5 mm
max. 5 kg

Domestic
see rating plate
1-10 bar
(=10–100 N/cm² = 0.1–1.0 MPa)

Dimensions

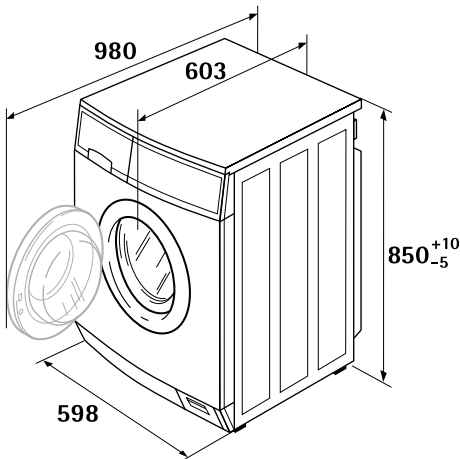

(Measurements in mm)

INDEX

A

Aqua Control14, 27

C

Care agent9, 17, 18, 23

Child safety feature33, 42

Conditioner 8, 9, 11, 23, 30

Cottons10, 16, 28, 30

Curtains15, 29

Customer service 14, 32, 33

D

Delay timer10, 12, 20, 24

Delicates 11, 16, 29

Detergent 9, 17, 23

Door opening22, 27, 35, 40

E

Easy iron11, 16, 29, 35

Easy-cares 11, 16, 29

Emergency emptying 38

Emergency unlocking 40

Energy saving10, 28

F

Filling quantity13, 28

Frost hazard6, 38

G

Gentle rinse11, 30

H

Handwash 11, 29, 30

I

In-wash stain treatment9, 23

L

Linen10, 16, 28, 30

M

Multidisplay10, 20, 24, 25, 33, 55

O

Over-dosed 27

P

Pre wash 12, 19, 23, 28, 29

Pre-wash detergent9, 23

Program aborting 25

Program changing 25

Program sequence display25

Pump off water 11, 27

Pump out 11, 27

Q

Quick wash12, 19, 25, 28, 29

R

Rating plate 9, 48, 55

Rinse hold11, 19, 27

Run time21

S

Silk 11, 16

Soaking 12, 19, 20, 23, 28, 29

Soaking agent 9, 23

Solution pump 9, 39

Spin 11, 19, 26, 30

Stain8, 12, 19, 25, 28, 29, 37

Starching 11, 30

U

Update14

W

Warranty 6, 33

Washing

averagely dirty8

coloured15

sensitive 15, 16

slightly dirty 8, 12

Washing powder 9, 17, 18, 23

Washing powder drawer 9, 23

Water hardness 8, 17

Water softener 8, 9, 17, 23

Woolens 11, 16, 29, 30

hand-washable 11, 29

SERVICE

In the section "What to do if ..." there is a list of some faults which you can remedy yourself. Look there first if a fault occurs. If you find no information there, please consult your Customer Service Centre.

Always prepare in advance for the discussion. By doing so you will simplify the diagnosis and the decision on whether customer service is necessary.

Note the PNC-number and the S-number. Both can be found on the rating plate on the inside of the door on your washing machine.

PNC

S-No.

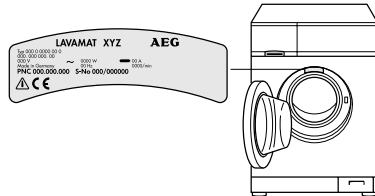

Answer as precisely as possible:

- What form does the fault take?
- Under what circumstances does the fault occur?
- Does the multidisplay show an error message?

When do you incur costs even during the warranty period?

- if you could have dealt with the fault yourself with the aid of the Faults Table (see the section "What to do if ...") ,
- if several trips by the customer service technician are necessary because he had not received all the necessary information before his visit and must now e.g. fetch spare parts. These multiple trips can be avoided if you prepare your phone call as described above.

AEG Hausgeräte GmbH
Postfach 1036
D-90327 Nürnberg

<http://www.aeg.hausgeraete.de>

© Copyright by AEG

822 942 355 -01- 1299-01

Free Manuals Download Website

<http://myh66.com>

<http://usermanuals.us>

<http://www.somanuals.com>

<http://www.4manuals.cc>

<http://www.manual-lib.com>

<http://www.404manual.com>

<http://www.luxmanual.com>

<http://aubethermostatmanual.com>

Golf course search by state

<http://golfingnear.com>

Email search by domain

<http://emailbydomain.com>

Auto manuals search

<http://auto.somanuals.com>

TV manuals search

<http://tv.somanuals.com>