

# AMERICAN AUDIO

## UCD-200

Professional Dual CD/USB Player

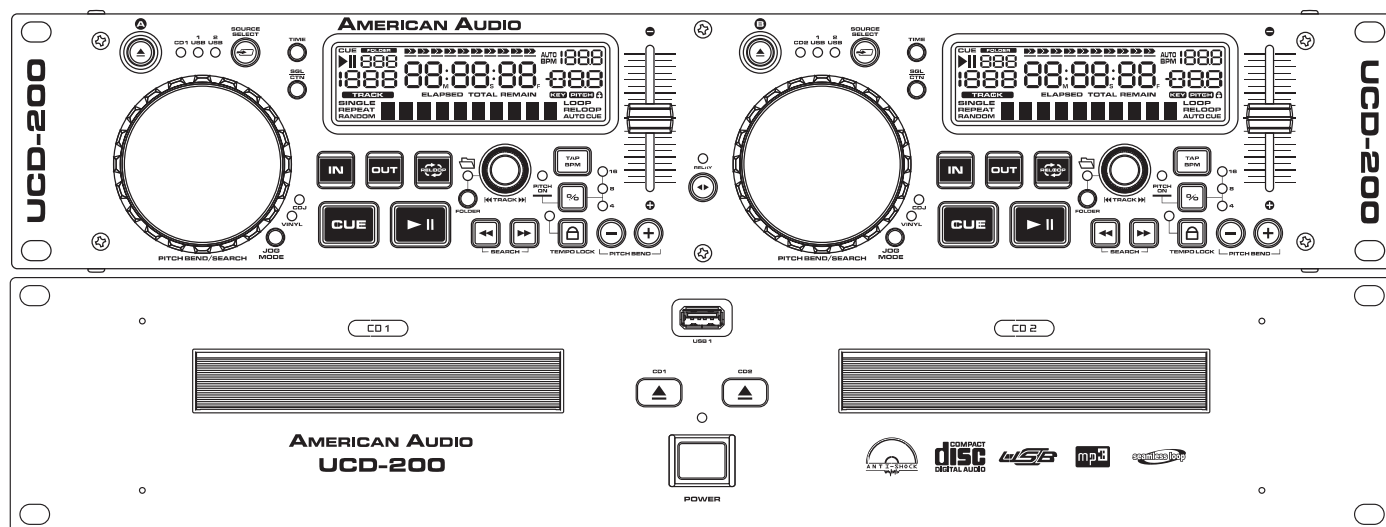

## Operating Instructions

**AMERICAN AUDIO**

6122 S. Eastern Ave.  
Los Angeles, Ca. 90040  
www.americandj.com  
9/10

## CONTENTS

CAUTIONS REGARDING HANDLING.....	3
PRODUCT INFORMATION.....	5
CUSTOMER SUPPORT .....	6
SET-UP.....	6
FEATURES.....	7
FUNCTIONS AND CONTROLS	
REMOTE UNIT.....	8
PLAYER UNIT.....	11
LIQUID CRYSTAL DISPLAY.....	13
INTERNAL MENU.....	15
BASIC OPERATION	
LOADING/EJECTING DISC.....	16
SELECTING TRACKS.....	16
STARTING/STOPPING PLAYBACK.....	16
ADJUSTING TIME DISPLAY.....	18
PITCH ADJUSTMENTS.....	18
PITCH BENDING.....	19
LOOPING.....	20
RELAY (FLIP-FLOP).....	21
DATABASE BUILDER.....	22
TYPICAL SET UP.....	25
TROUBLESHOOTING.....	26
SHUT DOWN PROCEDURES.....	27
HANDLING COMPACT DISC.....	27
WARRANTY.....	28
SPECIFICATIONS.....	29

### **FOR BEST CD-R DISC PLAYBACK RESULTS IN THIS CD PLAYER PLEASE FOLLOW THESE GUIDELINES:**

- 1. High quality CD-R Audio discs (should conform to the standards of the Orange Book 2).**
- 2. Use a high quality bit rate when recording discs. (At least 160kbps)**
- 3. Record discs in the slowest speed possible. (i.e. 2x or 4x speed)**

**Please Note:** All specifications and improvements to and in the design of this unit and this manuals are subject to change at any time without any prior written or published noticed.

**For service parts visit <http://parts.americandj.com>**

## ELECTRICAL SAFETY PRECAUTIONS

**NOTE:** This CD player uses a semiconductor laser. It is recommended for use in a room at the following temperature: 41°F - 95°F / 5°C - 35°C

### CAUTION:

1. Handle the power supply cord carefully. Do not damage or deform; it may cause electric shock or malfunction when used. Hold plug attachment when removing from wall outlet. Do not pull on the cord.

2. To avoid electric shock, do not open the top cover when the unit is plugged in. If problems occur with the unit, call your local American Audio® dealer.

3. Do not place metal objects or spill liquid inside the CD player. Electric shock or malfunction may occur.

The serial and model number for this unit is located on the rear panel. Please write down the numbers here and retain for future reference.

Model No. \_\_\_\_\_

Serial No. \_\_\_\_\_

**NOTE:** This product satisfies FCC regulations when shielded cables and connectors are used to connect the unit to other equipment. To prevent electromagnetic interference with electrical appliances such as radios and televisions, use shielded cables and connectors for connections.

### CAUTION:

USE OF CONTROLS OR ADJUSTMENTS OTHER THAN THOSE SPECIFIED HEREIN MAY RESULT IN HAZARDOUS RADIATION EXPOSURE

THE COMPACT DISC PLAYER SHOULD NOT BE ADJUSTED OR REPAIRED BY ANYONE EXCEPT PROPERLY QUALIFIED SERVICE PERSONNEL.

**CAUTION:** TO PREVENT ELECTRIC SHOCK DO NOT USE THIS (POLARIZED) PLUG WITH AN EXTENSION CORD, RECEPTACLE, OR OTHER OUTLET UNLESS THE BLADES CAN BE CAREFULLY INSERTED TO PREVENT BLADE EXPOSURE

**ATTENTION:** POUR PREVENIR LES CHOCS ELECTRIQUES NE PAS UTILISER CETTE FICHE POLARISEE AVEC UN PROLONGATEUR, UNE PRISE DE COURANT OU UNE AUTRE SORTIE DE COURANT, SAUF SI LES LAMES PEUVENT ETRE INSEREES A FOND SANS EN LAISSER AUCUNE PARTIE A DECOUVERT.

**WARNING:** TO PREVENT FIRE OR SHOCK HAZARD, DO NOT EXPOSE THIS UNIT TO WATER OR MOISTURE

This equipment has been tested and found to comply with the limits for a Class B digital device, pursuant to Part 15 of the FCC Rules. These limits are designed to provide reasonable protection against harmful interference in a residential installation. This equipment generates, uses, and can radiate radio frequency energy and, if not installed and used in accordance with the instructions, may cause harmful interference to radio communications. However, there is no guarantee that interference will not occur in a particular installation. If this equipment does cause harmful interference to radio or television reception, which can be determined by turning the equipment off and on, the user is encouraged to try to correct the interference by one or more of the following measures:

- Reorient or relocate the receiving antenna.
- Increase the separation between the equipment and receiver.
- Connect the unit into an electrical outlet on a circuit different from that to which the receiver is connected.
- Consult the dealer or an experienced radio/TV technician for help.

# ELECTRICAL SAFETY PRECAUTIONS

## ELECTRICAL PRECAUTIONS



The lightning flash with arrowhead symbol, within an equilateral triangle, is intended to alert the user to the presence of uninsulated "dangerous voltage" within the product's enclosure that may be of sufficient magnitude to constitute a risk of electric shock to persons.



**CAUTION: TO REDUCE THE RISK OF ELECTRIC SHOCK, DO NOT REMOVE THE COVER (OR BACK). THERE ARE NO USER SERVICEABLE PARTS INSIDE. REFER SERVICE TO YOUR AUTHORIZED AMERICAN AUDIO® SERVICE TECHNICIAN.**



The exclamation point within an equilateral triangle is intended to alert the user to the presence of important operating and maintenance (servicing) instructions in the literature accompanying the appliance.

## IMPORTANT SAFETY INSTRUCTIONS

**READ INSTRUCTIONS** — All the safety and operating instructions should be read before the product is operated.

**RETAIN INSTRUCTIONS** — The safety and operating instructions should be retained for future reference.

**HEED WARNINGS** — All warnings on the product and in the operating instructions should be adhered to.

**FOLLOW INSTRUCTIONS** — All operating and use instructions should be followed.

**CLEANING** — The product should be cleaned only with a polishing cloth or a soft dry cloth. Never clean with furniture wax, benzine, insecticides or other volatile liquids since they may corrode the cabinet.

**ATTACHMENTS** — Do not use attachments not recommended by the product manufacturer as they may cause hazards.

**WATER AND MOISTURE** — Do not use this product near water — for example, near a bathtub, wash bowl, kitchen sink, or laundry tub; in a wet basement; or near a swimming pool; and the like.

**ACCESSORIES** — Do not place this product on an unstable cart, stand, tripod, bracket, or table. The product may fall, causing serious injury to a child or adult, and serious damage to the product. Use only with a cart, stand, tripod, bracket, or table recommended by the manufacturer, or sold with the product. Any mounting of the product should follow the manufacturer's instructions, and should use a mounting accessory recommended by the manufacturer.

**CART** — A product and cart combination should be moved with care. Quick stops, excessive force, and uneven surfaces may cause the product and cart combination to overturn.



**VENTILATION** — Slots and openings in the cabinet are provided for ventilation and to ensure reliable operation of the product and to protect it from overheating, and these openings must not be blocked or covered. The openings should never be blocked by placing the product on a bed, sofa, rug, or other similar surface. This product should not be placed in a built-in installation such as a bookcase or rack unless proper ventilation is provided or the manufacturer's instructions have been adhered to.

**POWER SOURCES** — This product should be operated only from the type of power source indicated on the marking label. If you are not sure of the type of power supply to your home, consult your product dealer or local power company.

**LOCATION** — The appliance should be installed in a stable location.

**NONUSE PERIODS** — The power cord of the appliance should be unplugged from the outlet when left unused for a long period of time.

### GROUNDING OR POLARIZATION

- If this product is equipped with a polarized alternating current line plug (a plug having one blade wider than the other), it will fit into the outlet only one way. This is a safety feature. If you are unable to insert the plug fully into the outlet, try reversing the plug. If the plug should still fail to fit, contact your electrician to replace your obsolete outlet. Do not defeat the safety purpose of the polarized plug.

- If this product is equipped with a three-wire grounding type plug, a plug having a third (grounding) pin, it will only fit into a grounding type power outlet. This is a safety feature. If you are unable to insert the plug into the outlet, contact your electrician to replace your obsolete outlet. Do not defeat the safety purpose of the grounding type plug.

**POWER-CORD PROTECTION** - Power-supply cords should be routed so that they are not likely to be walked on or pinched by items placed upon or against them, paying particular attention to cords at plugs, convenience receptacles, and the point where they exit from the product.

**OUTDOOR ANTENNA GROUNDING** — If an outside antenna or cable system is connected to the product, be sure the antenna or cable system is grounded so as to provide some protection against voltage surges and built-up static charges. Article 810 of the National Electrical Code, ANSI/NFPA 70, provides information with regard to proper grounding of the mast and supporting structure, grounding of the lead-in wire to an antenna discharge unit, size of grounding conductors, location of antenna-discharge unit, connection to grounding electrodes, and requirements for the grounding electrode. See Figure A.

**LIGHTNING** — For added protection for this product during a lightning storm, or when it is left unattended and unused for long periods of time, unplug it from the wall outlet and disconnect the antenna or cable system. This will prevent damage to the product due to lightning and power-line surges.

**POWER LINES** — An outside antenna system should not be located in the vicinity of overhead power lines or other electric light or power circuits, or where it can fall into such power lines or circuits. When installing an outside antenna system, extreme care should be taken to keep from touching such power lines or circuits as contact with them might be fatal.

**OVERLOADING** — Do not overload wall outlets, extension cords, or integral convenience receptacles as this can result in a risk of fire or electric shock.

**OBJECT AND LIQUID ENTRY** - Never push objects of any kind into this product through openings as they may touch dangerous voltage points or short-out parts that could result in a fire or electric shock. Never spill liquid of any kind on the product.

**SERVICING** — Do not attempt to service this product yourself as opening or removing covers may expose you to dangerous voltage or other hazards. Refer all servicing to qualified service personnel.

**DAMAGE REQUIRING SERVICE** - Unplug this product from the wall outlet and refer servicing to qualified service personnel under the following conditions:

- When the power-supply cord or plug is damaged.
- If liquid has been spilled, or objects have fallen into the product.
- If the product has been exposed to rain or water.
- If the product does not operate normally by following the operating instructions. Adjust only those controls that are covered by the operating instructions as an improper adjustment of other controls may result in damage and will often require extensive work by a qualified technician to restore the product to its normal operation.
- If the product has been dropped or damaged in any way.
- When the product exhibits a distinct change in performance — this indicates a need for service.

**REPLACEMENT PARTS** — When replacement parts are required, be sure the service technician has used replacement parts specified by the manufacturer or have the same characteristics as the original part. Unauthorized substitutions may result in fire, electric shock, or other hazards.

**SAFETY CHECK** - Upon completion of any service or repairs to this product, ask the service technician to perform safety checks to determine that the product is in proper operating condition.

**WALL OR CEILING MOUNTING** — The product should not be mounted to a wall or ceiling.

**HEAT** — The product should be situated away from heat sources such as radiators, heat registers, stoves, or other products (including amplifiers) that produce heat.

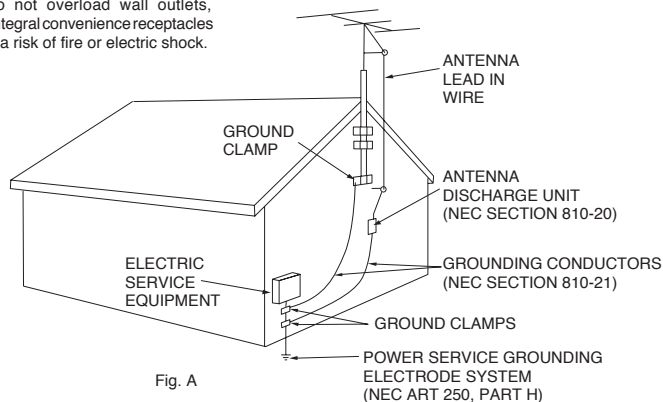

Fig. A

NEC — NATIONAL ELECTRICAL CODE

## PRODUCT INFORMATION

1. Heat - The CD player should be situated away from heat sources such as radiators, heat registers, stoves, or other appliances (including amplifiers) that produce heat.
2. Do not let insecticides, benzene, or thinner come in contact with the surface of the unit.
3. Never disassemble or modify your unit in any way, doing so will void your manufacturer's warranty.
4. Never plug this unit into a dimmer pack
5. Do not attempt to operate this unit if it becomes damaged in any way.
6. This unit is intended for indoor use only, use of this product outdoors voids all warranties.
7. Always mount this unit in safe and stable matter.
8. Disconnect from main power before making any type of connection.
9. Cleaning -
  - The CD Player should be cleaned only as recommended by the manufacturer. Use a soft cloth to wipe down the outside of the unit. For stubborn stains moisten a soft cloth with glass cleaner or other mild detergent to wipe away any stains. Use a soft cloth to wipe any residual cleaner. Never use volatile cleaners such as benzene, solvent, or thinner to clean your unit, these cleaners will damage the unit's surface.
  - Cleaning the pick-up lens - The pick-up lens should not become dirty under normal usage. If the lens does become dirty, contact American Audio Technical Support for further instructions. Third party lens cleaners are available but not highly recommended. Use of some of these cleaners may damage the pick-up lens, be sure to follow extreme caution when using these types of cleaners.

This unit has been thoroughly tested and has been shipped in perfect operating condition. Carefully check the shipping carton for damage that may have occurred during shipping. If the carton appears to be damaged, carefully inspect your unit for any damage. Be sure all accessories needed to operate the unit have arrived intact. In the event damage has been found or parts are missing, please contact our toll free customer support number for further instructions. Please do not return the unit to your dealer without first contacting customer support.

---

### WARRANTY INFORMATION

The UCD-200 carries a ONE year (365 days) limited warranty. This warranty covers parts and labor. **Please fill out the enclosed warranty card to validate your purchase and warranty.** All returned service items whether under warranty or not, must be freight prepaid and accompany a return authorization (R.A.) number. If the unit is under warranty, you must provide a copy of your proof of purchase invoice. Please contact American Audio® customer support at (800) 322-6337 for a R.A. number.

## CUSTOMER SUPPORT

**Customer Support:** American Audio® provides a toll free customer support line, to provide set up help and to answer any question should you encounter problems during your set up or initial operation. You may also visit us on the web at [www.americanaudio.us](http://www.americanaudio.us) for any comments or suggestions. For service related issue please contact American Audio®. Service Hours are Monday through Friday 9:00 a.m. to 5:00 p.m. Pacific Standard Time.

Voice: (800) 322-6337  
Fax: (323) 582-2941  
E-mail: [support@americanaudio.us](mailto:support@americanaudio.us)

**Warning!** To prevent or reduce the risk of electrical shock or fire, do not expose this unit to rain or moisture.

**Caution!** There are no user serviceable parts inside this unit. Do not attempt any repairs yourself, doing so will void your manufactures warranty. In the unlikely event your unit may require service please contact customer support. Please do not return to your dealer without first contacting customer support.

## SET-UP

### 1. Checking the Contents:

Be sure your UCD-200 was shipped with the following:

- |   |                                 |
|---|---------------------------------|
| 1) UCD-200 Dual CD/USB player unit.       | 1) UCD-200 Controller Head Unit |
| 2) Dual Male to Male RCA cable.           | 1) Warranty card.               |
| 1) Operating instructions (this booklet). |                                 |

### 2. Installing the Units

- 1) Place your unit on a flat surface or mount it in a secure rack mount case.
- 2) Be sure the player is mounted in a well ventilated area where it will not be exposed to direct sunlight, high temperatures, or high humidity.
- 3) Try to place the unit as far as possible from TVs and tuners, as the unit may cause undesirable interference.

### 3. Connections

- 1) Be sure main power is connected last to prevent any electrical damage.
- 2) AUDIO CONNECTIONS: Use the included RCA cable to connect the UCD-200 outputs to the line inputs of a mixer. Never connect a CD player's output to a mixers "phono" inputs.

**CAUTION:** Be sure to use the supplied control cables. Using a different type of cable may result in unit damage. To avoid severe unit damage, be sure main power is off when connecting the control cables.

#### CAUTION:

- The player will work normally when the main unit is mounted with the front panel within 15 degrees of the vertical plane. If the unit is tilted excessively, discs may not be loaded or unloaded properly. (Figure 1)

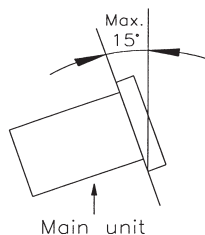

Figure 1

#### CAUTION:

- The LCD is designed to be clearly visible within the angles shown in Figure 2. Mount the control unit so that the visual angle is within this range.

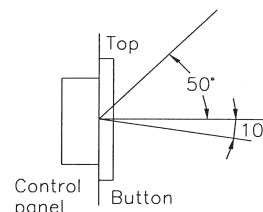

Figure 2



## MAIN FEATURES

- Jog Wheel Pitch Bend (b)
- Single or Continuous Play
- Selectable Time Display
- Auto Cue
- Flip Flop™ (Relay Playback) (c)
- Pitch Control and Bend  
(+/-4%, +/-8%, or +/-16%, & 100%\*)
- Dual USB Slots for MP3 Playback
- 8 Times Over Sampling 1 Bit D/A Converter
- 60 Second Transport Protection (a)
- Pitch Display
- Reads CD and CD-R Media
- Repeat in Single Mode
- 4 Speed Search
- Database Builder

\*100% Pitch Bend/Pitch Slider is for CDs only

(a) 60 SECOND TRANSPORT PROTECTION: The CD transport tray will automatically close if left open for more than 60 seconds. If a CD is left in the tray it will immediately cue.

(b) JOG WHEEL PITCH BEND: During normal playback, the jog wheel acts as a momentary pitch bend. Turning the wheel in a clockwise direction will increase the speed and turning the wheel in a counter-clockwise direction will decrease the speed.

(c) FLIP-FLOP™: For FLIP-FLOP™ results you must use both drives. Connect your UCD-200 as described in the set-up section of this manual. This feature will start the next player side once one player side has ended. For example, if drive one is playing and it ends, drive two will instantly begin to play. You may set FLIP-FLOP™ to play track to track or music source device to music source device. For more information on this feature, see FLIP-FLOP™ on page 21.

## IMPORTANT SD CARD INFORMATION & SET-UP

### **SD CARD INFORMATION:**

- **Make sure your SD Card only has MP3 files on it**
- **Do Not have any other file type on your SD Card; no photo files, etc...**
- **American Audio SD Players can read SD HC (High Capacity) Cards up to 32GB**

### **PLEASE NOTE:**

**For higher quality MP3 files (more than 128 kbps) American Audio recommends "High Speed" SD Cards. Using high speed cards will ensure the best performance with your American Audio SD Player.**

### **USB INFORMATION:**

- **Make sure your USB device has only MP3 files on it. There cannot be any other type of files on your USB device, NO photo files, etc...**
- **If you are using a SD Card via USB SD Card reader, you must remove the USB SD Card reader first to change SD Card's. Please do not remove the SD Card from the USB SD Card reader while the USB card reader is still connected to the unit.**
- **Only supports FAT/FAT32 formatted devices.**

## GENERAL FUNCTIONS AND CONTROLS - REMOTE UNIT

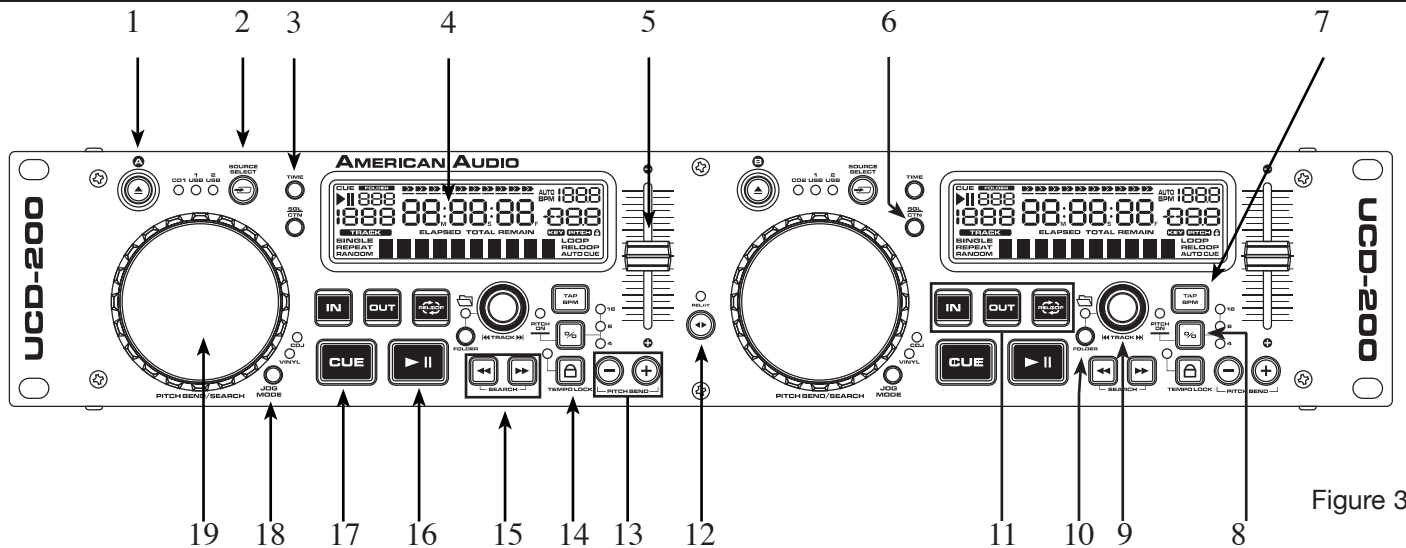

Figure 3

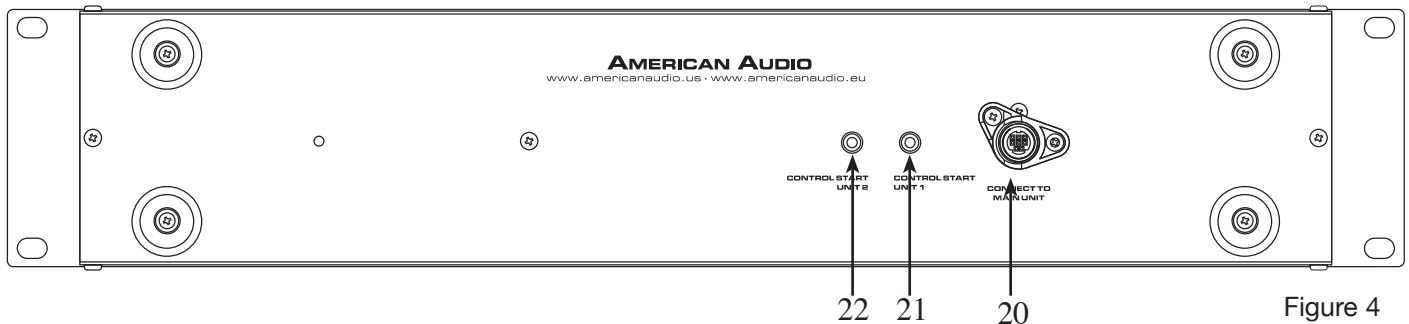

Figure 4

### REMOTE CONTROL - FACE (FIGURE 3)

- 1. OPEN/CLOSE (Disc Tray Open/Close)** - This button is used to open and close the disc transport tray door. NOTE: When a disc is loaded, the tray will not open unless the unit is in pause or cue mode.
- 2. SOURCE SELECTOR** - Press this button to select your desired playback source. Select either CD Player, USB 1, or USB 2. The source indicator LED will light when the selected source is activate.
- 3. TIME** - The TIME button is used to change the displayed time values. Time can be displayed as elapsed track time, remaining track time, and total disc remaining time. Total disc remaining time can only be displayed for standard CDs.
- 4. LIQUID CRYSTAL DISPLAY (LCD)** - This high quality LCD indicates all the functions (play, pause, cue, etc...), as they occur. This display is viewable at several comfortable angles as described on page 6. The LCD icons will be described in the next section.
- 5. PITCH SLIDER** - This slider is used to adjust the playback pitch percentage when the PITCH (8) function is activated. The slider is a set adjustment and will remain set until the pitch slider is moved or the PITCH (8) function has been turned off. The maximum pitch range of the slider is +/-100%. This adjustment can be made with or without a music source. The pitch adjustment will remain even if a music source has been removed, and will reflect on any other music source that is loaded into the unit. That is to say, if you set a +2% pitch on one music source, remove it and insert another, that music source will also have a +2% pitch. The amount of pitch being applied will be displayed in the LCD (4). Use this slider to match the BPM's of this unit to that of another music source. By changing the pitch of one music source with respect to the other in this way, the beats can be matched.
- 6. SGL/CTN** - This button allows the unit's play mode to change between Single and Continuous. In single mode the unit will play a single track and return to cue mode. In continuous mode the unit continues to play



## GENERAL FUNCTIONS AND CONTROLS - REMOTE UNIT (CONT)

track by track.

**7. TAP/BPM BUTTON** - Press this button to switch between manual BPM and Auto BPM. When in manual BPM mode, tap this button to the beat of the current track.

**8. PITCH BUTTON/ PITCH PERCENTAGE SELECTOR** - This button is used to turn the pitch function on and off and choose the pitch percentage. The pitch percentages to choose from are 4%, 8%, 16%, and 100%. To activate the pitch slider press the button for at least 3 seconds. The pitch functions of the PITCH SLIDER (5), will not function without this function being activated. See page 18 for more details. **The pitch slider and "+" and "-" pitch bend buttons have a maximum range of +/-100%.** (100% Pitch Bend/Pitch Slider works with CD only)

**9. TRACK/FOLDER SEARCH KNOB** - This knob is used to search/scroll through the tracks or folders on a active audio source. The search feature depends on the setting of the FOLDER BUTTON. If you press the knob in and turn it while in track mode, you can skip ahead 10 tracks. *Example: if you are at Track #1, pressing the knob and turning it clockwise will skip you to Track #11. If you press the knob and turn it clockwise again, it will skip to Track #21. If there are not that many tracks, it will go back to Track #1.*

**10. FOLDER/TRACK BUTTON** - This button is used to toggle between folders and tracks. When the LED of the FOLDER BUTTON is lit, the player is in FOLDER search mode. Hold the FOLDER BUTTON down for at least 2 seconds to activate and deactivate the REPEAT function.

Hold the button down for at least 2 seconds to activate and deactivate the REPEAT function.

**REPEAT ON:** All the track in the current folder will play track by track until the repeat function is deactivated.

**REPEAT OFF:** All the tracks in the device will play in the normal mode.

**SINGLE REPEAT:** The current playing track will play continuously.

### 11. IN, OUT, & RELOOP -

**IN BUTTON** - "CUE ON THE FLY" - This function allows you to set a CUE POINT (see CUE POINT page 17) without music interruption ("on the fly"). This button also sets the starting point of a loop (see LOOP).

**OUT BUTTON** - This button is used to set the ending point of a loop. A loop is started by pressing the IN BUTTON, pressing the OUT BUTTON set the loop ending point. The loop will continue to play until the OUT BUTTON is pressed once again.

**RELOOP BUTTON** - If a LOOP has been made (see setting a LOOP on page 20), but the Player is not actively in LOOP mode (a loop is not playing), pressing the RELOOP BUTTON will instantly reactivate the LOOP mode. To exit the loop, press the LOOP OUT BUTTON.

**12. RELAY BUTTON** - This button is acitvates Flip-Flop™ mode. See page 21 for more information.

### 13. PITCH BEND BUTTONS -

**(-) PITCH BEND** - The (-) pitch bend function creates a momentary "Slow Down" in the pitch speed (Beats per minute - BPM) when the PITCH (8) function is activated. This function allows the beats between two CD's or any other music source to match. This is a momentary function. When the button is depressed the pitch speed will automatically return to PITCH SLIDER'S (5) selected pitch. Holding down this button will give a maximum of -100% pitch. Be sure to remember that this function is a momentary pitch adjustment, for a more precise adjustment use the PITCH SLIDER'S (5) to match the BPM's with another playing music source.

**(+) PITCH BEND** - The (+) pitch bend function creates a momentary "BUMP" in the pitch speed (Beats per minute - BPM) when the PITCH (8) function is activated. This function allows the beats between two CD's or any other music source to match. This is a momentary function. When the button is depressed the pitch speed will automatically return to PITCH SLIDER'S (5) selected pitch. Holding down this button will give a maximum of +100% pitch. Be sure to remember that this function is a momentary pitch adjustment, for a more precise adjustment use the PITCH SLIDER'S (5) to match the BPM's with another playing music source.

**14. TEMPO LOCK FUNCTION** - This button activates the TEMPO LOCK function. This function allows you to

## GENERAL FUNCTIONS AND CONTROLS - REMOTE UNIT CONT.

use the PITCH SLIDER to speed up or slow down playback speed without altering the tonal pitch of the track. When this function is not engaged the original tonal pitch of the track will be altered giving you the "chipmunk" effect when a track is played at a high rate of speed, or the "James Earl Jones" effect when a track is slowed too much.

### 15. SEARCH BUTTONS -

◀◀ This search button allows you to quickly scan backwards through a track.

▶▶ This search button allows you to quickly scan forwards through a track.

**16. PLAY/PAUSE BUTTON** - Each press of the PLAY/PAUSE BUTTON causes the operation to change from play to pause or from pause to play. While in play mode the green play LED will glow, and while in pause mode the green play LED will flash.

**17. CUE** - Pressing the CUE button during playback immediately pauses playback and returns the track to the last set cue point. The red CUE BUTTON LED will glow when the unit is in cue mode The LED will also flash every time a new CUE POINT is set. The CUE button can also be held down to momentarily play music. When you release the CUE button it instantly returns to the last set CUE POINT.

### 18. JOG WHEEL MODE BUTTON -

**VINYL MODE** - In this mode the scratch effect is active. Use the jog wheel to simulate the scratch effect.

**CDJ MODE** - In this mode the scratch effect is deactivated the jog wheel can be used to pitch bend during playback and frame search in pause mode.

**19. JOG WHEEL** - The jog wheel serves three functions depending on the current operating mode:

- A. The jog wheel will act as a slow frame search control when the unit is in pause or cue mode allowing you to set a specific cue point or find a particular starting point.
- B. The jog wheel also works as a momentary pitch bend during playback. Turning the wheel clockwise will increase the pitch percentage up to 100%, and turning the wheel in the counter-clockwise direction will decrease the pitch percentage up to -100%. The pitch bend will be determined on how fast you turn the wheel.
- C. The jog wheel is also used to simulate the scratch effect. See JOG WHEEL MODE BUTTON (18).

### REMOTE CONTROL - REAR (FIGURE 4)

**20. REMOTE JACK** - Connect the supplied 8 pin din cable from this jack to the player's remote connector. This will allow you to control the player functions.

**21. UNIT 1 CONTROL START JACK** - Connect the supplied mini-plug from the control start jack on the rear of the unit to the control out jack of a compatible mixer. This will enable the "Q-Start" function.

**22. UNIT 2 CONTROL START JACK** - Connect the supplied mini-plug from the control start jack on the rear of the unit to the control out jack of a compatible mixer. This will enable the "Q-Start" function.

## GENERAL FUNCTIONS AND CONTROLS - PLAYER UNIT

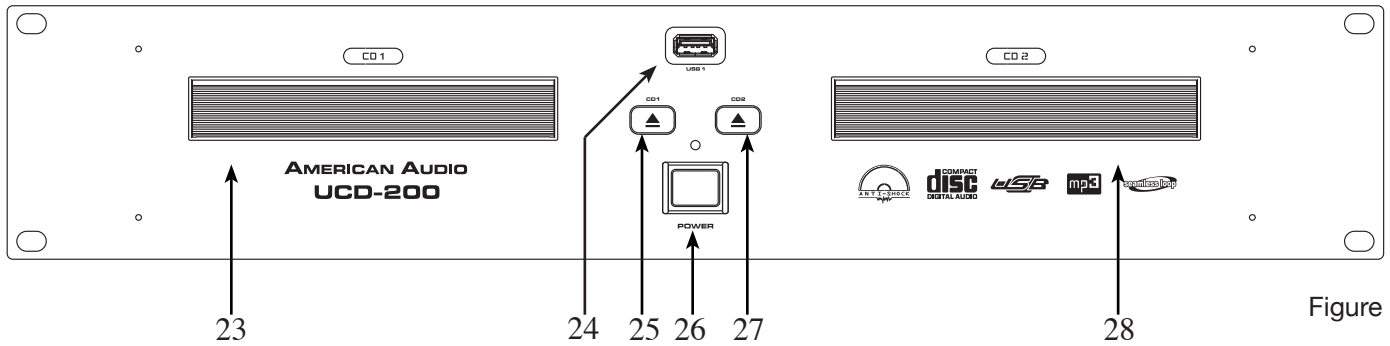

Figure 5

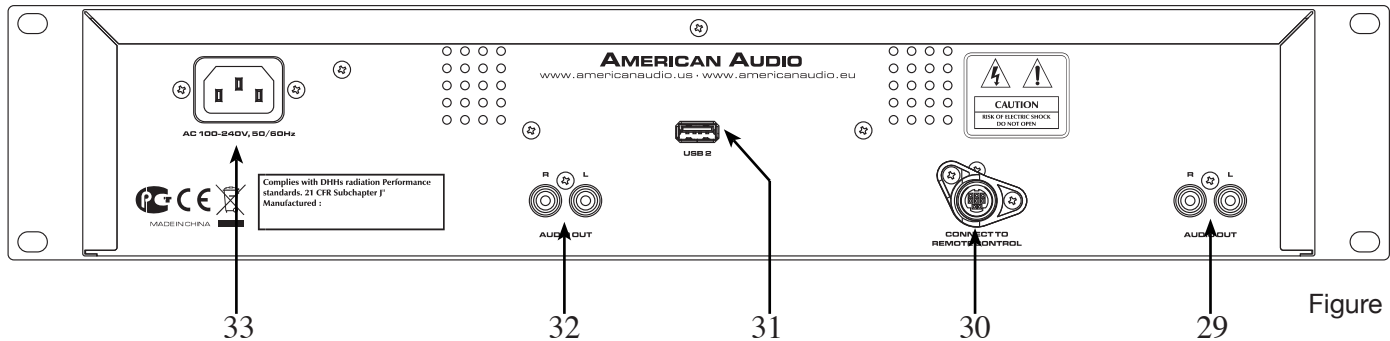

Figure 6

### PLAYER UNIT - FACE (FIGURE 5)

**23. DRIVE 1 TRANSPORT TRAY** - This tray is used to load and unload a compact disc into the drive 1 mechanism. The tray is opened and closed by pressing the DRIVE 1 OPEN/CLOSE BUTTON (25). Never attempt to force the transport tray open or close when the power is turned off.

**24. USB PORT** - This is the USB port where you can insert a USB stick, USB SD Card reader, or compatible external hard drive for playback. **VERY IMPORTANT: PLEASE SEE PAGE 7 FOR DETAILS REGARDING/USING USB DEVICES.**

**25. DRIVE 1 OPEN/CLOSE (Transport Tray Open/Close)** - This button is used to open and close the drive 1 transport tray. NOTE: When a disc is already loaded in the transport tray, the tray will not open unless the unit is in pause or cue mode.

**26. POWER SWITCH** - This switch is used to control the unit's main power. A red LED directly above the power switch will glow to indicate main power is active.

**27. DRIVE 2 OPEN/CLOSE (Transport Tray Open/Close)** - This button is used to open and close the drive 2 transport tray. NOTE: When a disc is already loaded in the transport tray, the tray will not open unless the unit is in pause or cue mode.

**28. DRIVE 2 TRANSPORT TRAY** - This tray is used to load and unload a compact disc into the drive 2 mechanism. The tray is opened and closed by pressing the DRIVE 2 OPEN/CLOSE BUTTON (27). Never attempt to force the transport tray open or close when the power is turned off.

### PLAYER UNIT - REAR (FIGURE 6)

**29. DRIVE 1 AUDIO OUT R & L** - These jacks send a left and right analog mono output signal. Use these jacks to send standard audio to a mixer or receiver. The red colored jack represents the right channel output and white jack represents the left channel's output.

## GENERAL FUNCTIONS AND CONTROLS - PLAYER UNIT

**30. REMOTE JACK** - Connect the supplied 8 pin cable from this jack to the remote control's connector. This will allow you to control the player functions with the remote unit.

**31. USB PORT** - This is the USB port where you can insert a USB stick, USB SD Card reader, or compatible external hard drive for playback

**32. DRIVE 2 AUDIO OUT R & L** - These jacks send a left and right analog mono output signal. Use these jacks to send standard audio to a mixer or receiver. The red colored jack represents the right channel output and white jack represents the left channels output.

**33. POWER CONNECTOR** - This is the main power connection. Only use the supplied polarized power cord. Use of any other power may result in severe damage to the unit. Be sure the local power matches the unit's required power.

## LIQUID CRYSTAL DISPLAY (LCD)

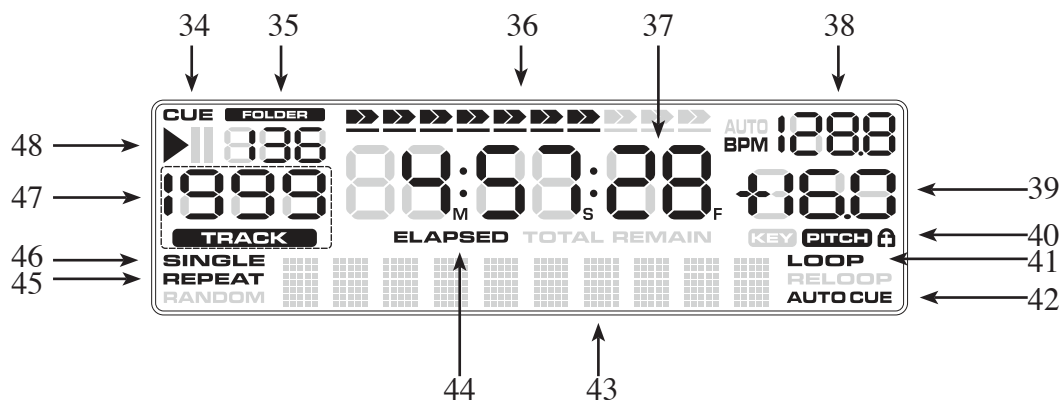

Figure 7

### LCD DISPLAY (FIGURE 7)

**34. CUE INDICATOR** - This indicator will glow when the unit is in CUE mode and will flash every time a new CUE POINT is set.

**35. FOLDER DISPLAY** - This indicates which folder you are in.

**36. TIME BAR INDICATOR** - This bar visually details the time defined in the TIME METER (37). As with the TIME METER (37), this bar is also dependent on the selected time function REMAIN, ELAPSED, or TOTAL REMAIN. This bar will begin to flash when 15 seconds of a track remain and will begin to rapidly flash when three seconds of a track remain. The flashing bar is a great visual reminder a track is about to end. The flashing bar will function regardless of which time mode the unit is in.

**37. TIME METER** - These indicators will detail the current Minutes, Seconds, and Frames. The meter will display either the elapse, remaining, or total remaining time of a track or the entire disc. The display time will depend on the selected time function. The selected time function will be displayed above the TIME METER as either *TOTAL REMAINING*, *REMAINING TRACK TIME*, OR *ELAPSED TRACK NAME*.

**38. BPM METER** - This meter will display the BPM of the current track.

**39. PITCH METER** - This meter displays the pitch percentage being applied to playback by the PITCH SLIDER (5). If the meter read zero regardless of the PITCH SLIDER'S (5) position, the PITCH (8) function is not activated.

**40.  TEMPO LOCK** - This will indicate the Tempo Lock function is active.

**41. LOOP/RELOOP INDICATOR** - The LOOP indicator will appear when a loop is ready to be engaged. The RELOOP indicator will flash when a loop is engaged.

**42. AUTO CUE** - This will indicate if the Auto Cue is on or off. Press and hold the SGL/CTN (12) for 1 sec. to turn the Auto Cue function on and off. The unit's Auto Cue function will automatically set the cue point at the beginning of each track.

**43. CHARACTER DISPLAY** - This will display the name of the track and/or folder when either a CD with text information or an Mp3 disc with compatible ID3 tags is loaded into the unit.

**44. TOTAL/REMAIN/ELAPSED INDICATOR** - When TOTAL REMAIN is indicated in the *LCD DISPLAY* (4) the time meter will show the total disc remaining time. When REMAIN is indicated the time meter will show the current track's remaining time. When ELAPSED is indicated the time meter will show the current track's elapsed time.

**45. REPEAT INDICATOR** - This indicates the unit is in repeat play mode, the unit will *CONTINUE* to

## LIQUID CRYSTAL DISPLAY (LCD)

play all tracks in a selected folder until the mode is deactivated. To activate REPEAT mode, press the FOLDER BUTTON (10 ) for at least 2 seconds to activate and deactivate.

**46. SINGLE INDICATOR** - This indicates the unit is in single play mode, the unit will play a single track and return to CUE mode. If the *SINGLE* indicator is not displayed the unit is in continuous mode.

**47. TRACK INDICATOR** - This double digit indicator details a current track. The number displayed in the track indicator is a direct reference to a track being selected for programming or a track in play, pause, or cue mode.

**48. PLAY INDICATOR** - The “PLAY” indicator will glow when the unit is in play mode.



## INTERNAL MENU

Hold TIME BUTTON for 3 seconds to enter the internal menu. Turn TRACK KNOB to scroll through the different menus and press the TRACK KNOB to enter the corresponding submenu. Turn TRACK KNOB to change the submenus and press TIME BUTTON to memorize your settings in any operating mode and exit the menu.

### 1. Playlist – Normal / Title/ Artist / Album/ Genre

Normally the unit will read your USB devices in order of folder name and file names in folders. Title, Artist, Album and Genre will use your last built database file when scrolling through the selected database in alphabetical order. When new files are added it is necessary to build a new database for the MP3 files to read in any mode described.

### 2. Sensitivity – Touch Wheel Sensitivity Adjustment (Adjustment range is -20~+20.)

Increase or decrease the sensitivity of the Jog wheels touch sensor.

### 3. Sleep Time – No sleep, 5~120 min

Set the time the player takes to enter sleep mode. When in sleep mode, the player will either read sleep or ZZZZZ on the LCD screen.

### 4. Line Setup – MODE= 1~3(Line mode)

Dis=0.5~12.0 sec. (LINE NAME start/stop time adjustment)

Run=50~2000 msec. (LINE NAME move time adjustment)

### 5. Bit rate – Display ON/OFF

Display the bit rate of MP3 files.

### 6. Version – CON:XX (Control version)

DSP:XX (DSP version)

SER:XX (Servo version)

Displays the firmware version.

### 7. Load Default – Press TRACK Knob to enter load defaults. (LCD displays “Load OK”.)

Will reset all settings to factory default except for Firmware version.

### 8. Exit & Save – Exit & Save setting to next power on (LCD displays “Saving”.)

This will save all changes if changes are not saved the unit will revert to last saved changes on power off. Press the TRACK knob to fast exit & save in any operating mode.

#### NOTE:

**SLEEP TIME:** The CD player automatically shuts off the transport and laser after about 15 minutes when in pause or cue mode). This extends the life of your motor drive and laser. During sleep mode the display shows the word “SLEEP”. To wake up the player, just press the cue or play button, the display turns to normal and is ready to receive instructions. You can enter the Sleep Time menu to adjust sleep time, range is 5~120 minutes.

**SAVE:** PITCH ON/OFF, PITCH RANGE, SGL/CTN, AUTO CUE, TIME MODE, KEY LOCK, SENSITIVITY, DISPLAY/SCROLL TIME/JOG MODE.

**DEFAULTS:** PITCH (ON), PITCH RANGE (8%), PLAY MODE(CTN), AUTO CUE(ON), TIME MODE (REMAIN), KEY LOCK(OFF), SENSITIVITY(0), BIT RATE(Disp. ON), REPEAT MODE (OFF), PLAYLIST (NORMAL), SLEEP TIME (15 min), LINE SETUP(model 1), DISPLAY(1 sec),RUN TIME(150msec)

## BASIC OPERATIONS

### 1. OPENING AND CLOSING THE DISC TRAY/LOADING DISCS

This is an electronic operation and can only work when the power is on. Press the OPEN/CLOSE BUTTON (1) to open or close the disc tray. Pressing the PLAY/PAUSE BUTTON (16), will also automatically close the tray if it is open and immediately cue any CD that is in it. If the transport tray is left open for more than 60 seconds it will close automatically to prevent accidental damage to the transport. Again if a CD is left in the transport tray it will immediately cue to the first song. The disc trays cannot be opened during playback to prevent playback from being interrupted if the OPEN/CLOSE BUTTON (1) is pressed accidentally. Stop playback, then press the OPEN/CLOSE BUTTON (1) to open the trays.

### 2. LOADING DISCS

The UCD-200 can play both 3 inch (8 cm) and 5 inch (12 cm) compact discs (CD's). Odd shaped and oval CD's are not compatible. When loading a CD into the unit always hold the disc by its' edges and place it in the disc tray. Never touch the signal surface (the glossy side). When using 5 inch/12 cm discs, place the disc in the outer tray guides (figure 8), and when using 3 inch/8 cm discs, place them securely in the inner guides (figure 9).

#### CAUTION:

- **NEVER** insert any foreign objects in the disc tray.
- **NEVER** attempt to insert more than one disc in the disc tray at a time. Doing so may result in severe damage to the unit.
- **NEVER** force the transport tray open or closed when the power is off, as this may result in malfunction and damage the transport system.

### 3. LOADING/EJECTING AN USB DEVICE

The UCD-200 can only read SDHC (High Capacity) Cards up to 32GB. **The file format is Mp3 only.** When connecting a USB stick, USB card reader, or external hard drive make sure you are correctly lined up with the USB port and gently insert the USB connection. To disconnect a USB drive, stop playback and "pull out" the USB connection. **Please see page 7 for USB information.**

#### CAUTION:

- **NEVER** remove a USB device while in PLAY mode.

### 4. SELECTING YOUR AUDIO SOURCE

Select your desired audio source using the SOURCE SELECTOR BUTTON (2). This button lets you toggle between either CD Player 1 or 2 depending on the side you are using, USB port 1 and USB port 2. This selector lets you choose which source will play on either side. The LED's will verify which source is active. The different sources can only be selected while in PAUSE mode.

### 5. SELECTING TRACKS

Select a desired track by using TRACK KNOB (9). Rotate the TRACK KNOB (9) clockwise to select the next track, or rotate the knob counter-clockwise to select the previous track. You may turn and hold the TRACK KNOB (9) to change tracks continuously at a higher speed. When you are using the TRACK KNOB (9) to select a new track during playback (a track already playing) the new track you selected will immediately begin playback as soon as the search operation is completed.

### 6. STARTING, PAUSING, & STOPPING PLAYBACK

Pressing the PLAY/PAUSE BUTTON (16) with a music source device activated will immediately start playback. The point at which playback starts (cue point) will automatically be stored in the memory as the cue point. The unit will return to this cue point (the point at which playback started) when the CUE BUTTON (17) is pressed.

Pausing temporarily stops playback. Pressing the PLAY/PAUSE BUTTON (16) changes the operating mode between play and pause.

Stopping playback will not stop the drive mechanism, but merely pause or cue the track. There are two ways

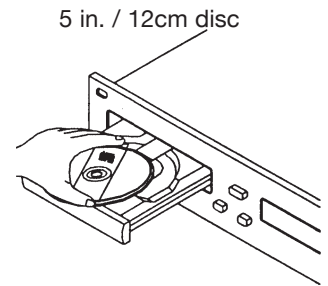

Figure 8

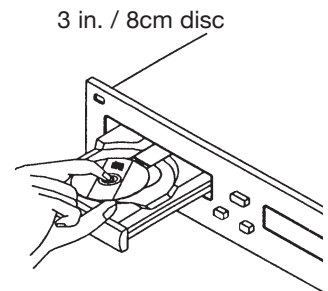

Figure 9

## BASIC OPERATIONS

to stop playback:

- 1) Press the PLAY/PAUSE BUTTON (16) during playback to pause at that point.
- 2) Press the CUE BUTTON (17) during playback to return the track to it's last cue point.

### **7. SETTING A CUE POINT**

"Cueing" is the action of preparing for playback. The unit is designed to automatically cue at the first audible signal on the first track of a disc when a disc is inserted. If a track is selected before a disc is inserted, the unit will automatically cue to the first audible signal for the selected track. You may press the IN BUTTON (11) on the fly (while the disc is playing). This will set a CUE Point without music interruption. Pressing the CUE BUTTON (17) will now return you to this exact point.

## BASIC OPERATIONS (CONT)

### 8. CHANGING THE TIME DISPLAY (37)/TIME BAR (36):

The time may be displayed in three different modes; Elapsed, Remain, and Total Remain. During normal playback, pressing the TIME BUTTON (3), will change the time display information (37) in the LCD (4). The following is a breakdown of the time settings and their definitions:

- 1) TOTAL REMAIN - This details the time in the LCD as the current CD's total remaining time.
- 2) REMAIN - This details the time in the LCD as the current track's remaining running time.
- 3) ELAPSED - This details the time in the LCD as the current track's elapsed running time.

**TIME BAR INDICATOR** - The time bar in the LCD (4) visually details the time defined in the TIME METER (37). This bar is also dependent on the selected time function REMAIN, ELAPSED, or TOTAL REMAIN. This bar will begin to flash when 15 seconds of a track remain and will begin to rapidly flash when three seconds of a track remain. The flashing bar is a great visual reminder a track is about to end. The flashing bar will function regardless of which time mode the unit is in.

### 9. PITCH ADJUSTMENTS:

This function will increase or decrease a tracks playback speed or "PITCH," this is not a momentary change as in "PITCH BENDING" (see page 19). The maximum pitch bend percentage of the PITCH SLIDER (5) is +/-100%. The PITCH SLIDER (5) is used to decrease or increase the playback pitch. If the slider is move up (towards the top of the unit) the pitch will decrease, if the slider is moved down (towards the bottom of the unit) the pitch will increase.

**Using the Pitch Slider Percentage Selector (8):** You may choose a pitch operating range at any time. To change the operating range be sure the pitch function is turned on, see figure 10. The pitch percentage can be changed between +/-4%, +/-8%, +/-16%, and 100%. 4% will allow the least amount of pitch manipulation and 100% will allow the most amount of pitch manipulation. To adjust the different values, press the **PITCH ON/OFF BUTTON (8)** and Tap on the **% BUTTON (8)** until your desired value is reached. The LED of the **% BUTTON (8)**; glowing red for 4%, glowing yellow for 8%, or glowing amber for 16%, and all LEDs glowing for 100%.

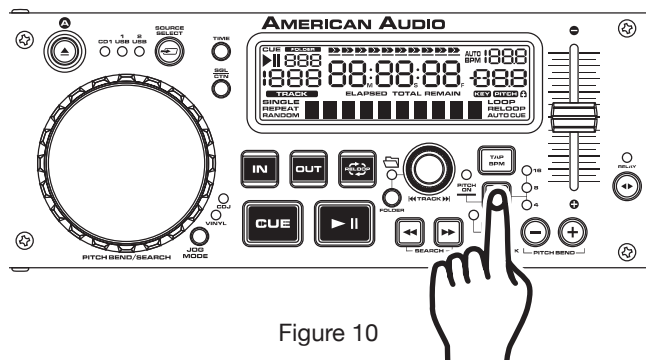

Figure 10

**Activating the Pitch Slider (5):** To activate the PITCH SLIDER (5), turn the pitch function on. Press the PITCH BUTTON (8) to turn on the pitch function, when the pitch function is activated a LED will begin to glow. If the pitch function is not activated the PITCH SLIDER (5) will not function.

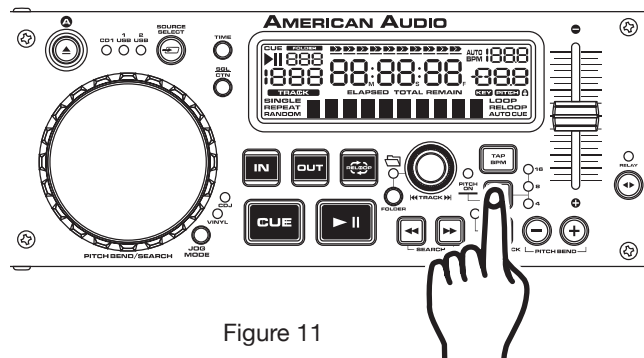

Figure 11

**Using the Pitch Slider (5):** To use the PITCH SLIDER (5) slide the slider up and down. Down will increase the pitch and up will decrease the pitch.

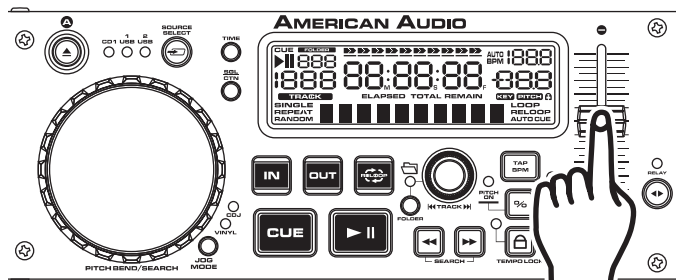

Figure 12

## BASIC OPERATIONS (CONT)

### 10. PITCH BEND:

This function will momentarily increase or decrease a tracks playback speed. There are two ways to operate this function with the (-) & (+) PITCH BEND BUTTONS (13) or with the JOG WHEEL (19). The maximum pitch bend percentage allowed is +/- 16%. The pitch bend function will work in conjunction with the PITCH SLIDER (5) pitch setting.

### PITCH BEND BUTTONS (14):

The (+) PITCH BEND BUTTON (13) will provide a speed bump and the (-) PITCH BEND BUTTON (13) will provide a slow down. The maximum range of the PITCH BEND BUTTONS is 100%. The extent to which the speed changes is proportionate to the amount of time the button is pressed. For example, if the (+) PITCH BEND BUTTON (13) is held down continuously, the speed will increase and will continue to increase until reaches a maximum of 16% speed gain. When you release the (+) PITCH BEND BUTTON (13) the speed will automatically return to it's previous speed.

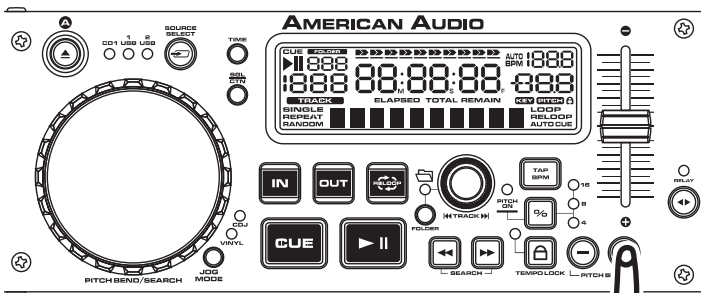

Figure 13

Holding down or tapping on the (-) PITCH BEND BUTTON (13) will provide a slow down in the playback pitch.

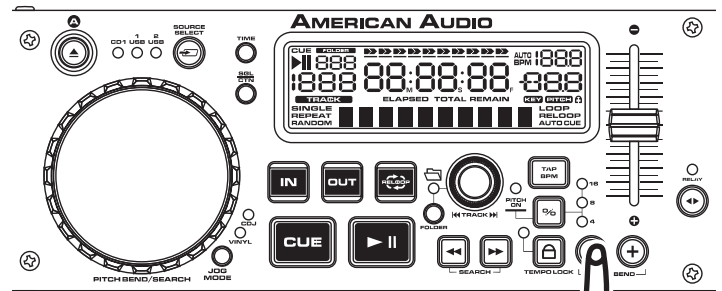

Figure 14

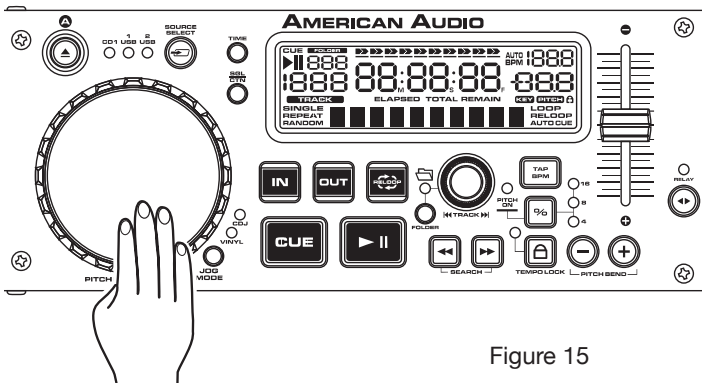

Figure 15

### JOG WHEEL (19):

The JOG WHEEL (19) will temporarily bend the pitch if a track is in play mode. Rotating the wheel in a clockwise direction will increase your track pitch and rotating the wheel in a counter-clockwise direction will slow your track pitch. The speed you rotate the JOG WHEEL (19) will determine pitch bend percentage (%).



## BASIC OPERATIONS (CONT)

### 13. CREATING AND PLAYING A LOOP

A loop is a sound loop that plays continuously. You can use this loop to create dramatic effect in your mixing. This loop has no time limit and you could actually loop the entire length of disc.

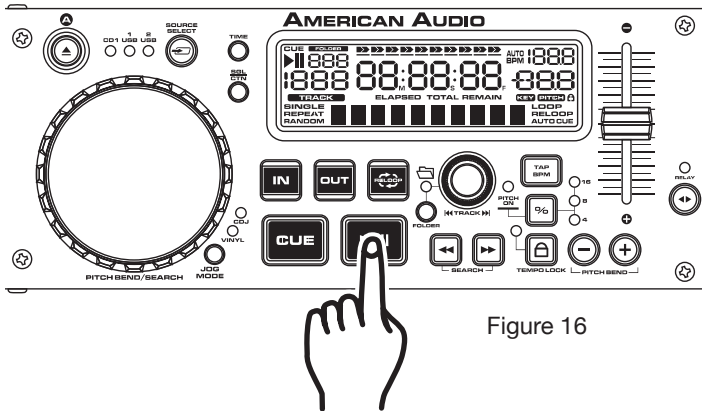

Figure 16

1) Press PLAY/PAUSE BUTTON (16) to activate playback mode.

2) Press the IN BUTTON (11). This will set the starting point of the SEAMLESS LOOP (figure 17). The IN BUTTON LED will blink.

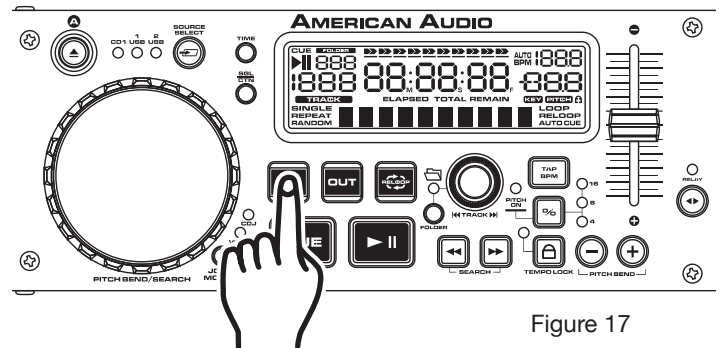

Figure 17

3) Press the OUT BUTTON (11) to set the ending point for your Loop (Figure 18). The LOOP IN AND OUT BUTTON LEDs will stay lit indicating a Loop is playing. Press the OUT BUTTON again to cancel the Loop.

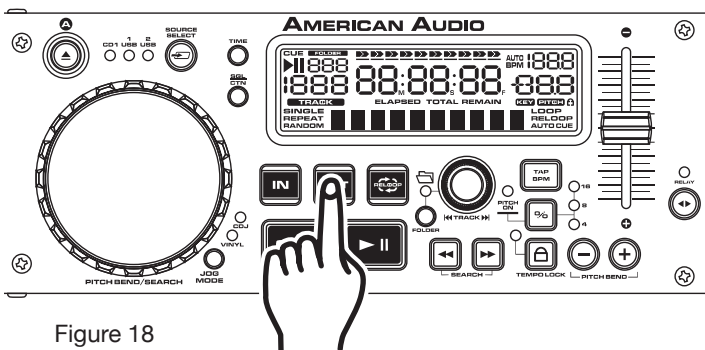

Figure 18

4) Press the RELOOP BUTTON (11) to reactivate the loop. Press the OUT BUTTON (11) to deactivate the loop.

- 5) Press the *OUT BUTTON (11)* again when you reach your new ending point (Figure 18).
- **FOR A SHORTER LOOP:** Press the *OUT BUTTON (11)* at sooner point in the track (Figure 18).
  - **FOR LONGER LOOP:** Press the *OUT BUTTON (11)* at later point in the track (Figure 18).

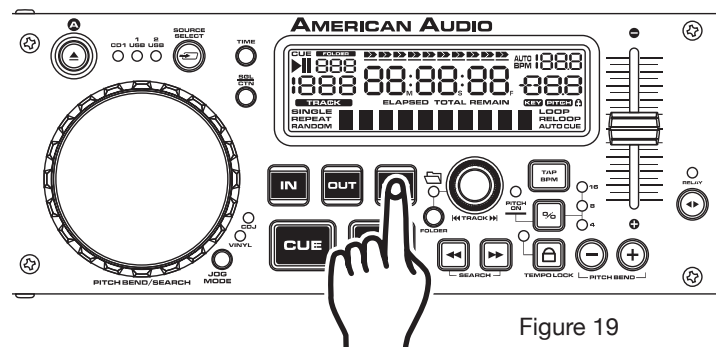

Figure 19



## BASIC OPERATIONS (CONT)

### 15. LOOP EDITING

The UCD-200 allows you to edit loops on the fly by pressing the IN and OUT BUTTONS. By pressing the IN BUTTON at your desired point you can move your loop "in" point forward. Pressing the OUT BUTTON will exit the loop.

You can also edit the loop by pressing the RELOOP BUTTON. Press this button for about 2 seconds, the LCD screen will display the time of your "out" point. You can now use the JOG WHEEL to fine tune your loop and "out" point. Turning the JOG WHEEL clockwise will move your "out" point forward, lengthening your loop. Turning the JOG WHEEL counter-clockwise will move your "out" point backwards, shorting your loop.

## "FLIP-FLOP' (RELAY) CONNECTION AND SET UP

### 16. RELAY (FLIP-FLOP™)

This feature is a kind of "auto pilot." "Flip-Flop™" mode can only function with the both drives of the UCD-200. With "Flip-Flop™" you can have one drive begin playback when the other ends. You can "Flip Flop™" single tracks, or entire music source device.

- 1) Load disc drives with audio discs or connect USB.
- 2) Press the RELAY BUTTON (12), the LED above the RELAY BUTTON will light up letting you know that Flip-Flop™ mode has been activated. Press the SGL/CTN BUTTON (6) to choose between SINGLE mode or CONTINUOUS mode.
- 3) After they have both cued, press the PLAY/PAUSE BUTTON (16) on one of your drives to begin playback.
- 4) If you have the player set to SINGLE mode, the first single track will play and after it has ended the second track will immediately begin playback. If the player is set to CONTINUOUS mode, the first music source will play all the way through, and then after it has ended the second music source will start.
- 5) FLIP FLOP™ will continue until you stop it or power is interrupted.
- 6) To deactivate Flip-Flop™ mode, press the RELAY BUTTON again.

# DATABASE BUILDER

## Minimum Hardware Requirements:

CPU: Intel Pentium 4 1GHz processor or above, Intel Centrino Mobile Technology 1.6GHz

RAM: 512MB RAM

DISC SPACE: 100MB of free disc space needed

OS: Microsoft Windows XP SP3, Vista SP2

The device includes a database DB management software that enables you to search for your files by Title, Artist, Album, and Genre.

## Installation:

Refer to the following figures for installing database management software on your computer.



Step 1: Click Next >

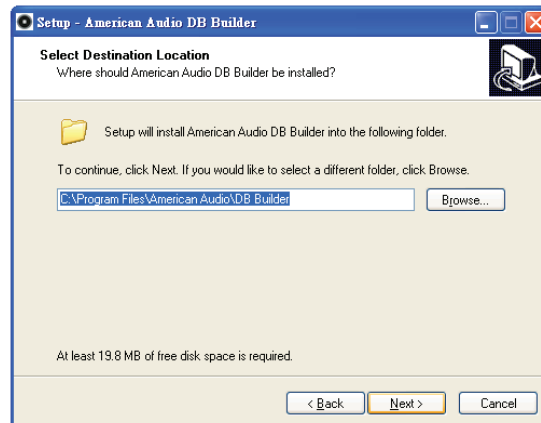

Step 2: Click Next >

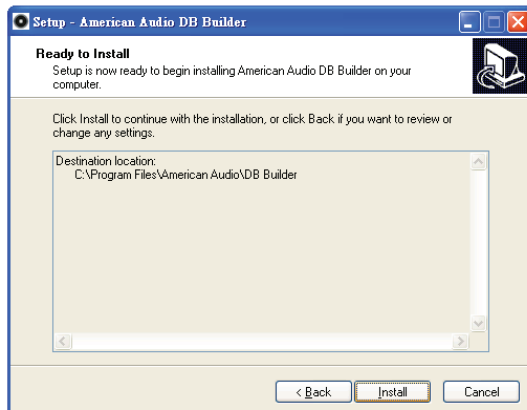

Step 3: Click Install

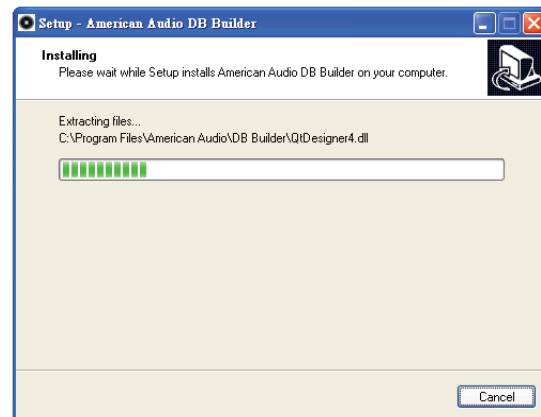

Step 4: Processing

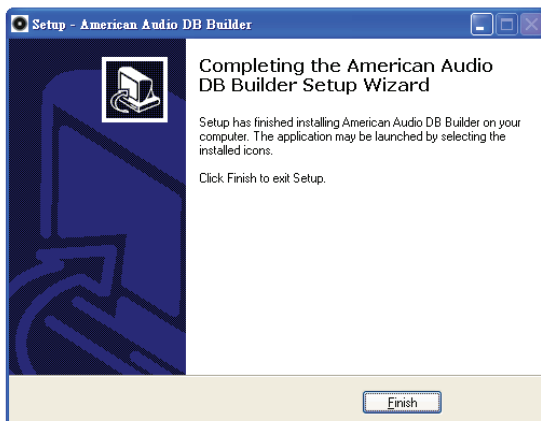

Step 4: Click Finish

The database builder will scan your USB hard drive and create database files so that you may locate the files in your music library to your liking.

## DATABASE BUILDER (PC ONLY)

To open the database builder, “click” on your start menu, then programs, then American Audio, Database Builder. To build a database your hard drive must FAT formatted.

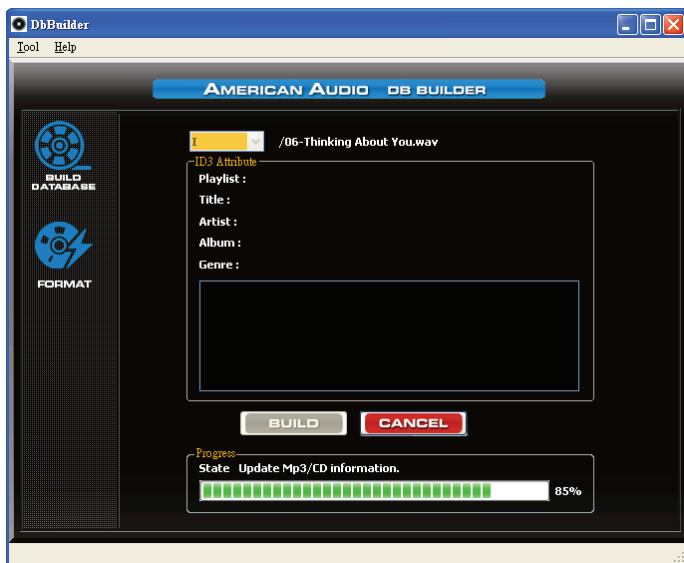
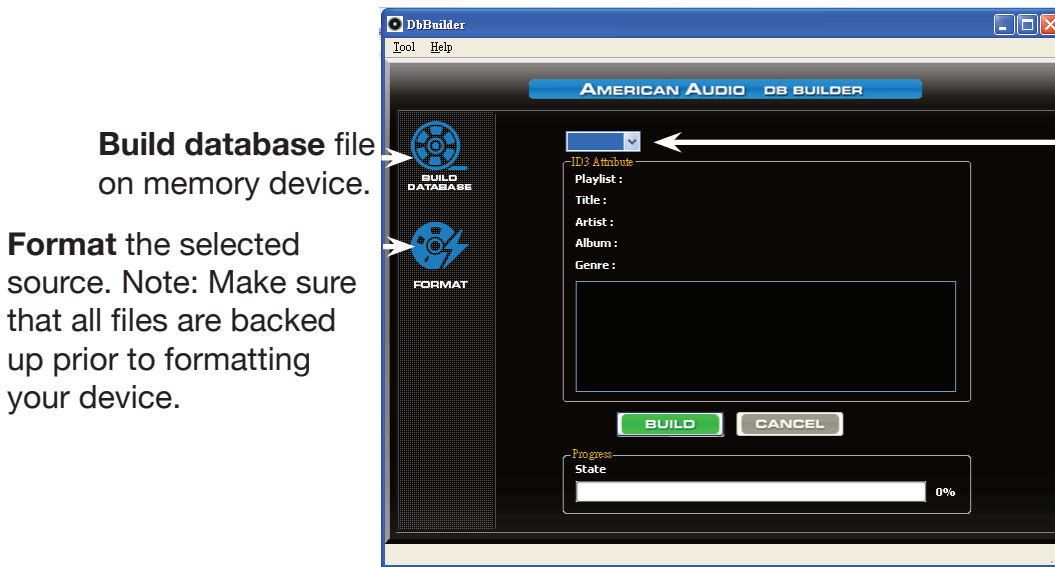

How to create a database file.

1. Select your desired device.
2. Select Build Database in the left column.
3. Click Build.

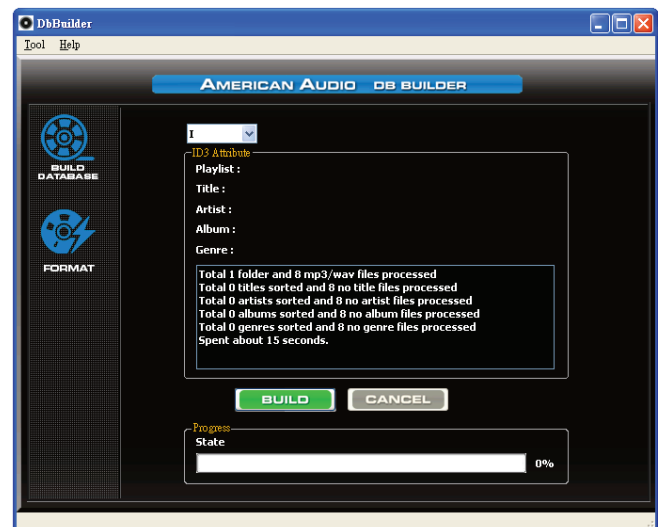

# DATABASE BUILDER

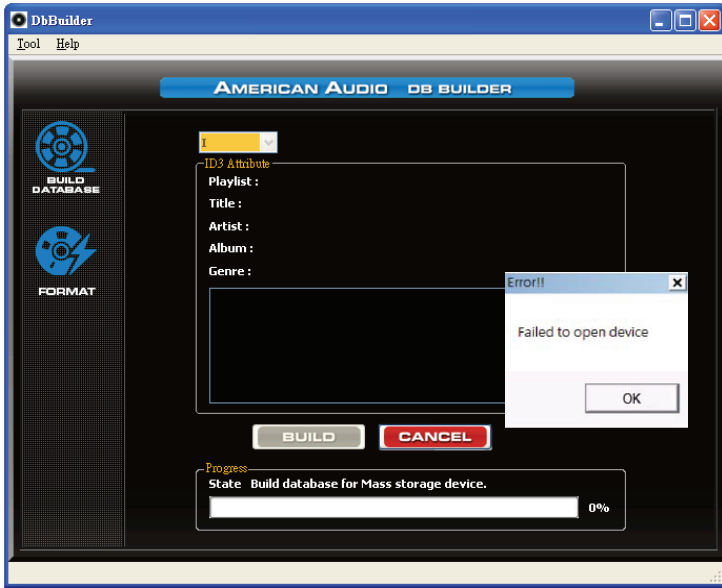

Errors:

1. Failed to Open Device: Your drive is a non supported format.
2. File Error: This is due to MP3 file not have a identified ID3 tag.

Windows 7/Vista may warn you according to your security settings. Select Allow if you wish to install the database builder program.

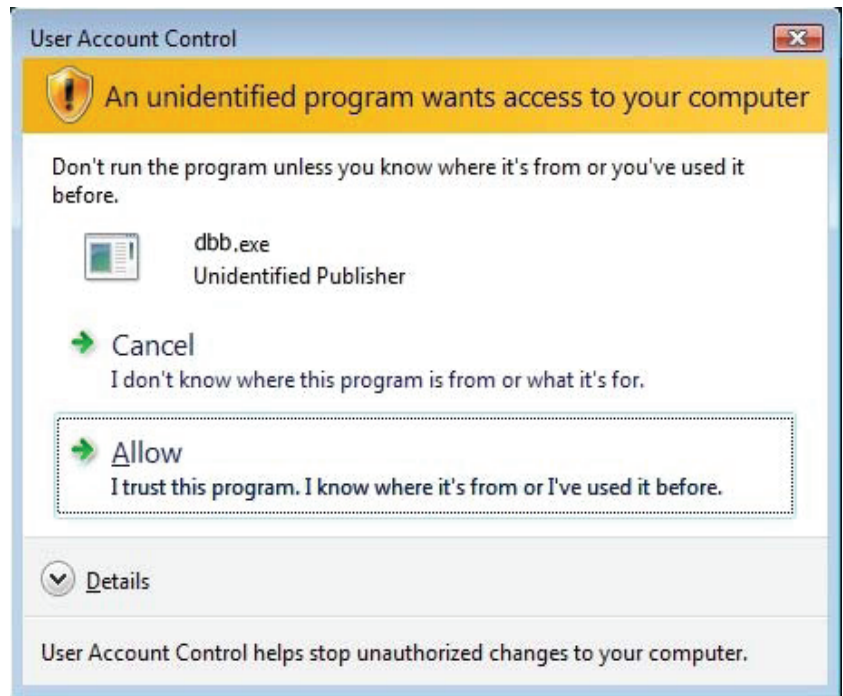

# SET UP

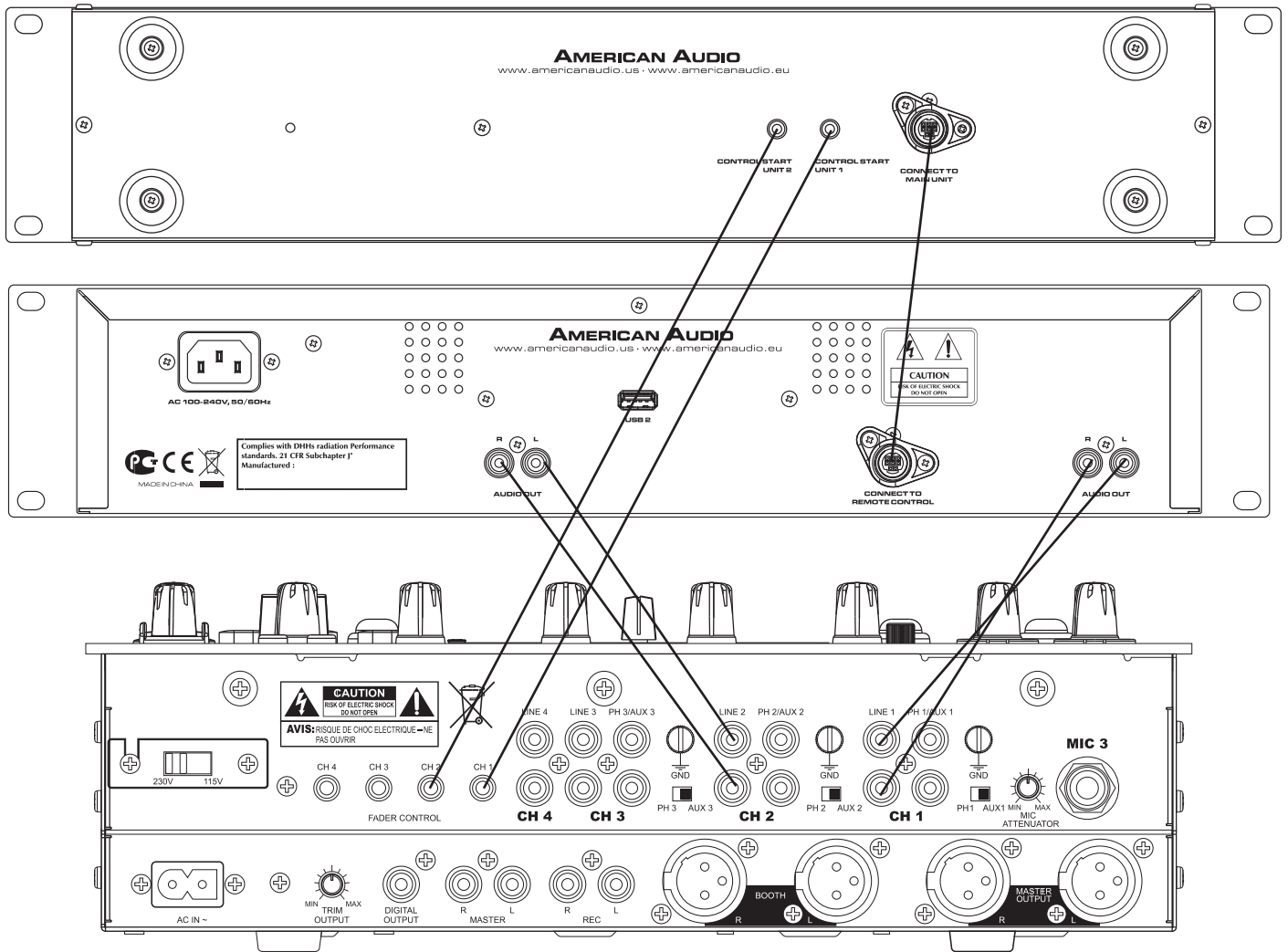

## TROUBLESHOOTING

Disc Read Error	<p>The disc is unable to read in the CD drive, make sure that the disc is clean and not scratched. If the problem continues try a different CD, make sure that the CD is CDA or MP3 format.</p> <p>If the disc takes over 20 seconds or more to read the CD lens will stop reading, this means the disc TOC was unreadable. Try another disk or clean the troubled disc.</p> <p>If problems continue with CD drives call American Dj service.</p>
USB device not reading	<p>When using Hard Drives it is recommended that you use a hard drive with an external power supply or one that does not exceed 5 volt power consumption. If your hard drive resets itself when plugged into the USB ports on the UCD-100/200 you may need an external power supply. Contact your device manufacturer for accessory information.</p> <p>If the drive doesn't read the device, make sure that your device is formatted to a compatible FAT format. <b>WARNING-DO NOT FORMAT YOUR DEVICE WITH OUT BACKING UP YOUR FILES.</b></p>
Music files not found in USB device or Data base	<ul style="list-style-type: none"> <li>-Make sure that the file is an MP3 file.</li> <li>- If it does not show up on the database modes ( album; artist; etc) use the database builder to update you library.</li> </ul>
File Error when building dB file	<p>Remove the file that cause the database builder to stop and try again, if problem continues remove the folder and try again.</p>



## BEFORE SWITCHING OFF THE POWER

- When you have finished using the CD unit, and before switching off the power, be sure that the disc holder has been closed with the OPEN/CLOSE button.
- TRAY PROTECTION: If tray is not closed after 60 seconds, it will close automatically and pause.

**CAUTION:** DO NOT forcibly close the disc holder when the power is off.

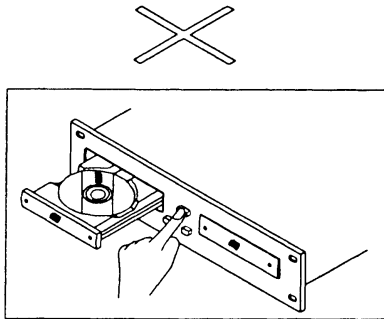

Do not switch off the power when the disc holder is open.

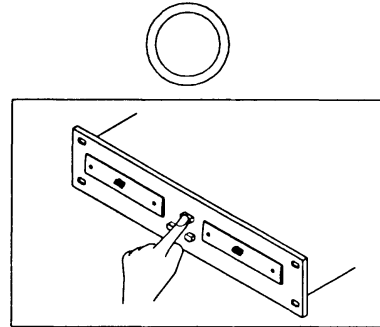

Switch off the power after the disc holder has been closed with the OPEN/CLOSE button.

DO NOT switch off the power when the disc holder is open. Switch off the power after the disc holder has been closed with the OPEN/CLOSE BUTTON.

## COMPACT DISCS

### 1. PRECAUTIONS ON HANDLING COMPACT DISCS

Compact disc are constructed of the same types of plastic record are. To avoid severe damage to you valuable disc please observe the following guide lines. Following the these guide lines will ensure long disc life.

- Do not allow fingerprints, oil or dust to get on the surface of the disc. If the disc is dirty, wipe it off with a soft dry cloth.
- Do not use benzene, thinner, water, record spray, electrostatic-proof chemicals, or silicone-treated cloths to clean discs.
- Always handle discs carefully to prevent damaging the surface; in particular when removing a disc from the jewel case.
- Do not bend the disc.
- Do not apply heat.
- Do not enlarge the hole in the center of the disc.
- Do not write on the label (printed side) with a hard tipped implement such as a pencil or ball point pen.
- Condensation will form if a disc is brought into a warm area from a colder one, such as outdoors in winter. Do not attempt to dry the disc with a hair dryer, etc.

### 2. PRECAUTION ON STORAGE

- After playing a disc, always unload it from the unit.
- Always store the compact disc in the jewel case, protecting from dirt or damage.
- Do not place discs in the following areas:
  - a) Areas exposed to direct sunlight for a considerable time.
  - b) Areas subject to accumulation of dust or high humidity.
  - c) Areas affected by heat from indoor heaters, etc.

## WARRANTY

### 1-YEAR LIMITED WARRANTY

- A. American Audio® hereby warrants, to the original purchaser, American Audio® products to be free of manufacturing defects in material and workmanship for a period of 1 Year (365 days) from the date of purchase. This warranty shall be valid only if the product is purchased within the United States of America, including possessions and territories. It is the owner's responsibility to establish the date and place of purchase by acceptable evidence, at the time service is sought.
- B. For warranty service, send the product only to the American Audio® factory. All shipping charges must be pre-paid. If the requested repairs or service (including parts replacement) are within the terms of this warranty, American Audio® will pay return shipping charges only to a designated point within the United States. If the entire instrument is sent, it must be shipped in its original package. No accessories should be shipped with the product. If any accessories are shipped with the product, American Audio® shall have no liability whatsoever for loss of or damage to any such accessories, nor for the safe return thereof.
- C. This warranty is void if the serial number has been altered or removed; if the product is modified in any manner which American Audio® concludes, after inspection, affects the reliability of the product; if the product has been repaired or serviced by anyone other than the American Audio® factory unless prior written authorization was issued to purchaser by American Audio®; if the product is damaged because not properly maintained as set forth in the instruction manual.
- D. This is not a service contract, and this warranty does not include maintenance, cleaning or periodic check-up. During the period specified above, American Audio® will replace defective parts at its expense, and will absorb all expenses for warranty service and repair labor by reason of defects in material or workmanship. The sole responsibility of American Audio® under this warranty shall be limited to the repair of the product, or replacement thereof, including parts, at the sole discretion of American Audio®. All products covered by this warranty were manufactured after January 1, 1990, and bear identifying marks to that effect.
- E. American Audio® reserves the right to make changes in design and/or improvements upon its products without any obligation to include these changes in any products theretofore manufactured.
- F. No warranty, whether expressed or implied, is given or made with respect to any accessory supplied with products described above. Except to the extent prohibited by applicable law, all implied warranties made by American Audio® in connection with this product, including warranties of merchantability or fitness, are limited in duration to the warranty period set forth above. And no warranties, whether expressed or implied, including warranties of merchantability or fitness, shall apply to this product after said period has expired. The consumer's and or Dealer's sole remedy shall be such repair or replacement as is expressly provided above; and under no circumstances shall American Audio® be liable for any loss or damage, direct or consequential, arising out of the use of, or inability to use, this product.
- G. This warranty is the only written warranty applicable to American Audio® Products and supersedes all prior warranties and written descriptions of warranty terms and conditions heretofore published.

# SPECIFICATIONS

<b>GENERAL</b>	Model: American Audio® UCD-200 - Professional Compact Disc/USB Player
System:	Dual, CD Tray Loading, Digital Compact Disc Audio Player.
Disc type:	Standard compact discs (5 in /12cm and 3in/8cm discs)
Dimensions:	Player unit: 19" (W) x 3.49" (H) x 10.5" (D) 482mm (W) x 88.8mm (H) x 267mm (D) (without feet) Control unit: 19"(W) x 3.7" (H) x 3.5" (D) 482mm (W) x 94mm (H) x 91.2mm (D) (without feet)
Installation:	Place on flat surface or mount in flat case
Weight:	Player unit: 10.14 Lbs. / 4.6kgs Control unit: 3.75 Lbs. / 1.7kgs
Power supply:	AC 100 - 240V, 50/60Hz
Power consumption:	16W
Pitch control range:	+/-4%, +/-8%, +/-16%, and 100% (100% only applies to Standard CD's)
Pitch bend:	+/-4%, +/-8%, +/-16%, and 100% (100% only applies to Standard CD's)
Pitch accuracy:	0.1%
Environmental conditions:	Operational temperature: 5 to 35°C (41 to 95°F) Operational humidity: 25 to 85% RH (non-condensation) Storage temperature: -20 to 60°C (4 to 140°F)
Accessories:	Dual RCA Cable (for left and right channels) Control 1/8" miniplug type (3 feet)

## AUDIO SECTION

Quantization:	16 bit linear per channel
Sampling rate:	44.1 kHz at normal pitch
Over sampling rate:	8 times over sampling 1 bit D/A converter
D/A conversion	16 bit
Frequency response:	20Hz to 20KHz +/-0.4dB (For CDDA)
Output level:	2.0Vrms +/-0.5dB
Load impedance:	47k ohm or more

## AUDIO CHARACTERISTICS (TEST DISC: TCD-782 & TCD-781; USB TEST FORMAT: MP3, 128KBPS; LOAD=100Kohm):

ITEM	NOMINAL	LIMIT	CONDITION
Output level (CD):	2Vrms +/-0.5dB	2Vrms+/-1dB	1KHz, 0dB
Output level (USB):	1.85Vrms +/-0.5dB	1.85Vrms+/-1dB	1KHz, 0dB
Channel balance:	Within 0.2dB	Within 1dB	1KHz, 0dB
Frequency response (CD)	17-20KHZ +/-0.4dB	17-20KHZ +/-1dB	0dB OUTPUT (TCD782, TRK2/3/7)
Frequency response (USB)	17-16KHZ +/-0.2dB	17-16FKHZ +/-1dB	0dB OUTPUT (TCD781, TRK1/4/16)
De-emphasis response (CD):	-20dB +/-0.2dB	-20dB +/-1dB	16KHz,-20dB
Channel separation*2:	93dB	85dB	1KHz, 0dB
T.H.D. + NOISE*1 (CD):	0.008%	0.015%	1KHz, 0dB
T.H.D. + NOISE*1 (USB):	0.007%	0.015%	1KHz, 0dB
S/N ratio (IHF-A)*2 (CD):	126dB	90dB	1KHz, 0dB
S/N ratio (IHF-A)*2 (USB):	85dB	80dB	1KHz, 0dB
Dynamic Range*2 (CD):	92dB	88dB	1KHz, -60dB

NOTE: \*1 With 20KHz low pass filter.

\*2 With 20KHz low pass filter, "IHF-A" Weighted

## CD SEARCHING TIME (TEST DISC: TCD-792)

ITEM	NOMINAL	LIMITS	CONDITION
Short access time	2 sec	4 sec	Play next track
Long access time	4 sec	6 sec	Track 1 ->Track 20 / Track 20 ->Track 1
CD recover time	1 sec	2 sec	CD play interrupted by mechanical shock

## PLAYABILITY

ITEM	NOMINAL	LIMIT	CONDITION
Interruption	1mm	0.7mm	TCD-725
Black dot	1mm	0.6mm	TCD-725
Finger prints	75um	65um	TCD-725
Eccentricity	140um	140um	TCD-712, W/O TRACK JUMP
Vertical deviation	1mm	0.5mm	TCD-731R
Scratch	2mm	1.2mm	TCD-721, W/O TRACK JUMP



# SPECIFICATIONS

## PICK-UP

System	Object lens drive system optical pick-up
Object lens drive system	2 dimensional parallel drive
Tracking detection	3 spot beam detection
Optical source	Semiconductor laser
Wave length	780nm

## MP3 FORMAT

Disc Format	Applicable file extensions	mp3. MP3. mP3. Mp3
	ISO9660	Max. 63 characters
	Joliet	Max. 63 characters
	CD-ROM sector format	mode-1 only
	Max. number of Folders	255
	Max. number of files	Max. 999 files (* note #1)
USB Format	File System	FAT 12/16/32
	Applicable file extensions	mp3. MP3. mP3. Mp3
	Max. number of Folders	999
	Max. number of files	Max. 999 files
MP3 Format	MPEG 1 Layer 3 standard (ISO/IEC 11172-3), which provides for single channel ('mono') and two-channel ('stereo') coding at sampling rates of 32, 44.1 and 48kHz.	32/40/48/56/80/96/112/128/160/192/224/256/320 kbps Xing/VBRI VBR
	MPEG 2 Layer 3 standard (ISO/IEC 13818-3), which provides for similar coding at sampling rates of 16, 22.05 and 24 kHz.	32/40/48/56/64/80/96/112/144/160 Kbps Xing/VBRI VBR
	MPEG 2.5 Layer 3 standard, which provides for similar coding at sampling rates of 8, 11.025 and 12 kHz.	32/40/48/56/64/80/96/112/144/160 Kbps Xing/VBRI VBR
Disc Writing Method	Disc at Once and Track at Once	
	Multi Session	If the 1 <sup>st</sup> session is CDDA, you can playback Only CDDA track, If the 1 <sup>st</sup> session is MP3, you can playback only MP3 file.

Note #1: max.255 files each folder



©American Audio®  
A Division of the American DJ® Group of Companies  
American Audio® World Headquarters:  
6122 S. Eastern Ave.  
Los Angeles, CA 90040 USA  
Tel: 323-582-2650 Fax: 323-582-2610  
Web: [www.americanaudio.us](http://www.americanaudio.us) E-mail: [info@AmericanAudio.us](mailto:info@AmericanAudio.us)

## Free Manuals Download Website

<http://myh66.com>

<http://usermanuals.us>

<http://www.somanuals.com>

<http://www.4manuals.cc>

<http://www.manual-lib.com>

<http://www.404manual.com>

<http://www.luxmanual.com>

<http://aubethermostatmanual.com>

Golf course search by state

<http://golfingnear.com>

Email search by domain

<http://emailbydomain.com>

Auto manuals search

<http://auto.somanuals.com>

TV manuals search

<http://tv.somanuals.com>