

# American DJ AUDIO

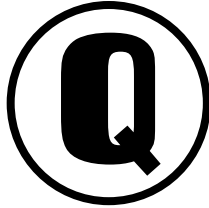

## Q-MX2 BPM

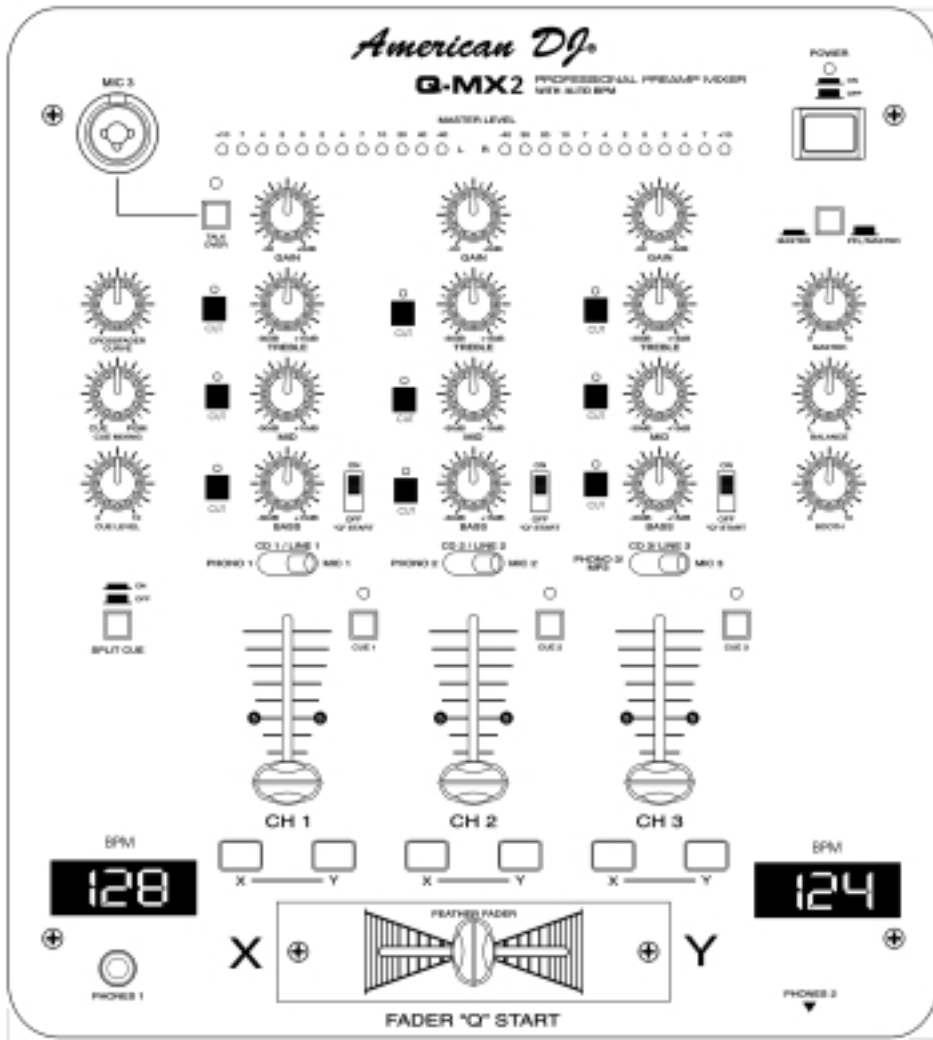

# USER INSTRUCTIONS

# Q-MX2 BPM

Featuring:

Fader "Q" Start

Professional products designed for  
the working DJ.

---

## Main Features

- Equipped with high quality Crossfader (Replaceable)
- VCA Fader for Q-Start Control
- Adjustable Crossfader Curve - changes from a normal curve to a quick curve (for crabbing)
- Multi-Channel Assignable Crossfader
- 2 Headphone Outputs
- Selectable Voltage 115v~230v
- 3 Channel Mixer
- 3 Phono, 3 Line, 3 Auxiliary Inputs
- 3 Microphone Input - (1) XLR/ 1/4" combo plug, (2) 1/4" Input Jacks
- Fader "Q" Start on all three channels
- On/Off Switch Controls Fader "Q" Start Function (for use with the American DJ CD Players with Fader "Q" Start)
- -30dB Rotary Kills for Treble, Bass & Mids on all three channels
- Separate gain control for each channel
- High output to headphones
- Soft-touch rubber knobs for better control
- Extremely clean signal to noise ratio
- Light Control Signal Output Jack
- Talk Over Button - Reduces channel output gain by 15dB +/- 2 dB
- Independent Booth Level Output
- Dual Function Stereo LED Level Indicator - Indicated Master and PFL (Pre Fader Level) Signal Levels
- Split Cue Monitoring
- Cue Mixing
- Balanced XLR Master Output
- 4 Signal Output Options - Master (RCA and Balanced XLR), Booth (RCA) and REC (RCA)
- Automatic BPM Counter
- 100% Push Button Kills (Bass, Mid, and Treble)

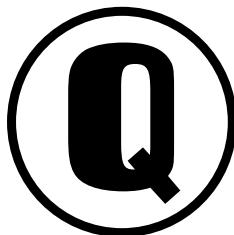

©American DJ® AUDIO Los Angeles, CA 90058 USA  
Specifications subject to change without notice.  
Q-MX2 BPM User Instructions page 2

## **Index**

- **Safety Precautions**.....p.4
- **Operating Introduction**.....p.4
- **Functions (Front Panel)**.....p.5
- **Inputs & Outputs (Rear Panel)**.....p.8
- **Set-Up**.....p.10
- **Replacing the Crossfader**.....p.13
- **Operating Determinations**.....p.13
- **Technical Specifications**.....p.14
- **Warranty & Service**.....p.14

## **Important Precautions**

1. Be sure to save the packing carton in case you may ever have to return the unit for service.
2. Read all documentation before attempting to operate your new mixer. Please save all your documentation for future reference.
3. Do not spill water or other liquids in to or on to your mixer.
4. Be sure that the local power outlet matches that of the required voltage for your mixer.
5. Do not attempt to operate this unit if the power cord has been frayed or broken. Please route your power cord out of the way of foot traffic.
6. Always have the front gain controls set to their lowest level during initial power-up to prevent speaker damage.
7. Disconnect from main power before making any type of connection.
8. Do not remove the top cover under any conditions. There are no user serviceable parts inside.
9. Disconnect the unit's main power when left unused for long periods of time.

## **Introduction**

### **Introduction:**

Congratulations and thank you for purchasing the American DJ® Q-MX2BPM™ mixer. This mixer is a representation of American DJ's continuing commitment to produce the best and highest quality products at an affordable price. This mixer includes several innovative features that pack a big punch! **The Q-MX2 BPM™ comes with a 2 year limited warranty!**

Please read and understand this manual completely before attempting to operate your new mixer. This booklet contains important information concerning the proper and safe operation of your new mixer.

### **Unpacking:**

Carefully open and unpack your mixer. Be sure to save the packaging in case you may ever need to return your unit to the factory. After unpacking, inspect the mixer for any type of damage that may have occurred during shipping or transit. If you notice any type of damage notify your dealer immediately for instructions.

### **Set-Up Precautions:**

Please make any connections before you plug the unit in. Be sure the Power switch is in the OFF position before connecting other devices to the mixer. All fader and volume controls should be set to 0 or minimum position, before the device is switched on. If the device has been exposed to drastic temperature fluctuation (e.g. after transportation), do not switch on the mixer immediately. The arising condensation of water might damage your device. Leave the device switched off until it has reached room temperature.

# FRONT PANEL - CONTROLS AND FUNCTIONS

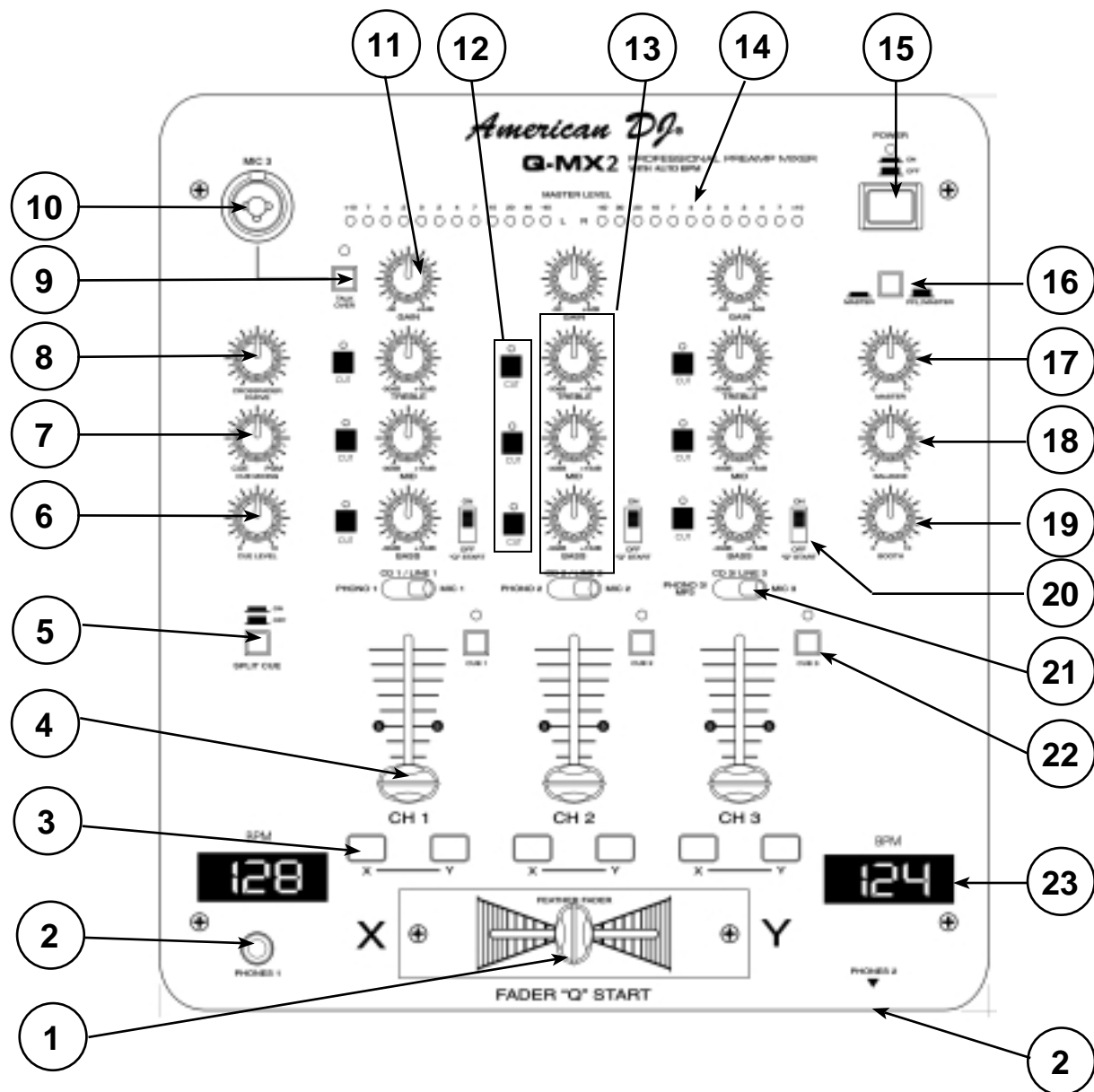

- 1. FEATHER FADER PLUS™ CROSSFADER** - Blends the output signals of any channels assigned to "X" or "Y." When the fader is in the full "X" position, the output signal of any channels assigned to "X" will be controlled by the master volume level. The same fundamentals will apply for "Y." Sliding the fader from one position to another will vary the output signals of the "X" and "Y" channels respectively. When the crossfader is set in the center position, the output signals of both the "X" and "Y" channels will be even.
- 2. HEADPHONES JACKS** - These jacks are used to connect your headphones to the mixer. Use headphones only rated at 8 ohms to 16 ohms. Most DJ headphones are rated at 16 ohm, these are highly recommended. Two different headphone jacks are conveniently located on the mixer, one on the face and one on the front side panel. Always be sure the **Cue Level Volume (6)** is set to minimum before you put the headphones on.
- 3. FADER ASSIGN BUTTONS** - These buttons are used to assign a channel to the crossfader. When a channel is assigned to "X," the left side (X-side) of the crossfader will control that channels output level. The "Y" assign works in the same fashion. When a channel is assigned to neither "X" nor "Y" the output volume will only be controlled by the channel's fader level. These button also function as a "TRANS EFFECT" A Trans Effect is an effect similar to cutting the output signal with your transformer switches.

## FRONT PANEL - CONTROLS AND FUNCTIONS CONT.

This is an effect used heavily by scratchers and performer DJ's. The mixer simulates this effect when you hold down the X and Y fader buttons. The speed of the transform is preset and will only effect any channel assigned to the fader assign button being depressed.

4. **CHANNEL FADER** - These faders are used to control the output signal of any source assigned to its particular channel.
5. **SPLIT CUE** - This button will activate the "Split Cue" function. When used with a set of stereo headphones, the Split Cue function assign the Cue signal the left channel of the headphones and assigns the Program (main output) signal to the right channel of the headphones. Essentially splitting the cue signal in half. Please note that this function will only work with a set of stereo headphones.
6. **CUE LEVEL VOLUME CONTROL** - This knob is used to adjusts the headphone output level.
7. **CUE MIXING CONTROL** - This functions allows you to monitor the Cue level as well as the Program (main output) level in your headphones. A channels Cue Level may only be monitored if the channels Cue function is selected. To selceted a channels cue function depress the **Cue Button (22)** that is directly associated with the specific channel you wish to monitor. You may use the mixing function to blend both the Cue level and the Program level together. You can vary the output level to either hear more or less of either of the two levels. Turning the Cue Mixing knob to the CUE position (counter-clockwise) will allow you to hear more of the Cue level. Turning the knob to the PGM (clockwise) position will allow you to hear more of the Program level (main output). You may also use the Cue Mixing Control to hear either the Cue level or the Program level exclusively. If the knob is in the full CUE position you will only hear the cue level, if the knob is in the full PGM position you will only hear the main output. This function will esspecially be useful for occasions when an external monitor is not available.
8. **CROSSFADER CURVE ADJUSTMENT** - This adjustment allows you to adjust the geometry or "shape" of the crossfader response curve. The response curve can be adjusted from smooth to harsh (Instant). The smooth adjustment - full counter clockwise - allows for a long running crossfade. This adjustment will usually be used for normal DJing. The harsh adjustment - full clockwise adjustment - allows for a short crossfade. This adjustment will usually be used for scratching and cut effects.
9. **TALKOVER BUTTON** - When this button is depressed, all signals except the microphone level are decreased by 15dB. A red indicator LED will glow when the talkover function is engaged. In the OFF position all signals remain at their standard levels.
10. **MIC 3 INPUT JACK** - Combination Microphone Plug. This jack will accept a standard 1/4 plug or XLR 3-pin balanced male plug. The volume output level will be controlled by the **Channel 3 Fader (4)**.
11. **CHANNEL GAIN CONTROL** - This adjustment is used to adjust an audio source signal input gain for a channel. Never use the gain control to adjust output volume. Setting the gain level properly will ensure a clean output signal. To properly set the gain level controls:
  1. Be sure the **Master Volume Control (16)** is set to minimum (zero output).
  2. Set the **Channel Fader (4)** to level 7.
  3. Begin play on an audio source connected to the channel you are adjusting.
  4. Be sure the **LED Level Indicator Function Switch (15)** is set to the PFL/MASTER position.
  5. Turn the **CUE (22)** function on for the channel you are adjusting.
  6. Use the **GAIN Control** to adjust an average output volume of +4 dB in the **LED Level Indicator (14)**.
12. **CUT BUTTONS** - These buttons are used cut out the Treble, Mid or Bass frequencies of the incoming audio signal. When these buttons are depressed the selected frequency level is cut by 100%. When a Cut Button is depressed a LED located directly above the specific button will glow indicating the cut function has been activated. Depressing the Cut Button once again will disengage Cut function.
13. **CHANNEL EQUALIZER "ROTARY KILLS" - BASS/MID/TREBLE CONTROL** - Each of the three channels come with a signal output EQ. These controls are used to increase or decrease the LOW's, MID's, and HI's of the output signal. The Q-MX2 features "Rotary Kills" with a -30dB to +20dB gain control.

## FRONT PANEL - CONTROLS AND FUNCTIONS CONT.

Turn the knob counter-clockwise to decrease a value or clockwise to increase a value.

**14. LED LEVEL INDICATORS** - The dual LED's indicators along the top of unit are used to detail either the master output level or a combination of the master output level and the cue PFL level. The position of the **LED Level Indicator Function Switch (15)** will determine the LED Level Indicator's display mode. In the "MASTER" (down) position the meter will detail the out level of the left and right channels. In the "PFL/ MASTER" (up) position one side of the meter will detail the master output volume level and the other section of the meter will detail the CUE level PFL (pre fader level).

**Please Note: PFL stands for Pre Fader Level. This is the input channel signal level you will hear in your headphones.**

**15. POWER SWITCH** - This is the main power ON/OFF button. A yellow LED above the power switch will glow to indicating power is ON. Before you turn the power on be sure you have made all connections to the mixer. Also be sure you amplifier are tuned off. Remember mixer on first and turned off last.

**16. LED LEVEL INDICATOR FUNCTION SWITCH** - The position of the **LED Level Indicator Function Switch (15)** will determine the LED Level Indicator's display mode. In the "MASTER" (down) position the meter will detail the out level of the left and right channels. In the "PFL/ MASTER" (up) position one side of the meter will detail the master output volume level and the other section of the meter will detail the CUE level PFL (pre fader level).

**17. MASTER VOLUME CONTROL** - This rotary knob is used to control the master output level (volume). To avoid distorted output try to maintain an average output signal level +4 dB.

**18. MASTER VOLUME BALANCE CONTROL** - This rotary knob is used to control the master output balance level. Turning the knob to the "L" (counter-clockwise) position will increase the left channel output level. Turning the knob to "R" (clockwise) position will increase the right channel output level, while decreasing the left. To maintain a true stereo sound, level the balance control knob set to the 12 O'clock, or center position.

**19. BOOTH LEVEL VOLUME CONTROL** - This rotary knob is used to control the booth level volume. The booth level is not PFL, it is essentially a second master output volume with separate output volume control.

**20. ON/OFF Q START**- This function works in conjunction with a compatible American DJ "Q" Start CD player. When used with a compatible CD player, you can use the crossfader to start and stop the CD Player with the slide of the fader. The ON/OFF "Q" START switch activates this FADER "Q" START feature. When in the ON position, the FADER "Q" START allows the fader to return automatically to preset digital CUE POINTS on your compatible American DJ CD Player.

For example, each time you slide the crossfader to far left the CD Player will be triggered to play the song from the beginning of the preset CUE POINT. Refer to your American DJ CD Player User Manual for setting CUE POINTS. Turn the ON/OFF SWITCH to the OFF position to disengage "Q" Start function and resume to a normal fader.

**21. SOURCE SELECTOR SWITCH** - These are 3-position switches. The switches are used to select the input source assigned to each channel. Each channel may only be assigned one input source at a time.

**22. CUE BUTTONS** - These buttons are used to activate a channels "CUE" mode. A red LED above the cue button will glow when cue mode is activated. Cue mode will send a channels incoming signal to the headphones. The cue level is adjusted by the **Cue Level Adjustment knob (6)**. Be sure the cue level is set to minimum before putting your headphones on. Be sure to turn the **Cue Mixing Knob (7)** to the cue position to hear the selected channel source.

**23. AUTOMATIC BPM (Beat Per a Minute) COUNTER BUTTONS** - This sophisticated counter automatically calculates the BPM of any audio source. The meter on the "X" side will display the average BPM's of any Channel (1, 2, or 3) assigned to "X" by the **Fader Assign Buttons (3)**. The meter on the "Y" side will display the average BPM's of any Channel (1, 2, or 3) assigned to "Y" by the **Fader Assign Buttons (3)**.

## REAR PANEL - CONTROLS AND FUNCTIONS CONT.

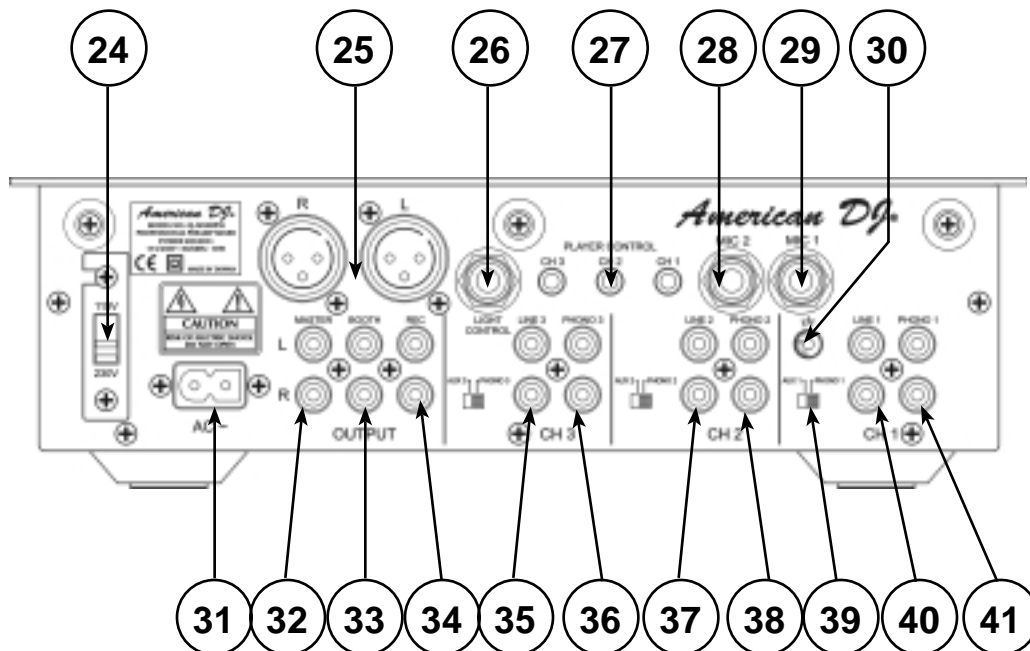

- 22. AC VOLTAGE SELECTOR** - Select between 115V/50Hz or 230V/60Hz. Make sure that the selector is set to the proper voltage you are using.
- 23. BALANCED XLR MAIN OUTPUTS** - The Master Output includes a pair **XLR Balanced Jacks** as well as a pair **RCA Unbalanced Jacks (30)**. The 3-pin XLR jacks send a high current balanced output signal. These jacks should be used when you will be driving an amp or other audio equipment with a balanced input, or whenever you will be running a signal line greater than 10 feet.
- 24. LIGHT CONTROL** - This jack provides a preset mono audio signal output. There is no way to adjust this level, however this level will directly reflect the output level of the **Channel Sliders (4)**. This buffered audio output should only be used for light controllers that can accept an external audio input. Great for Touch Panels and Chase Controllers.
- 25. PLAYER CONTROL** - Channel 1, 2, and 3 external **FADER "Q" START CONTROL**. These jacks are used to input 1/8" mono mini plugs from a compatible American DJ "Q" series CD players also featuring Fader "Q" Start. This feature is used to remote control a CD player. By moving the mixer fader from left to right you can start and pause a compact disc player. In other words, when the mixer crossfader is to the left (X position), and you move it at least 20% to the right (Y position), any player connected to the Y-channel will begin to play. When the crossfader is to the right (Y position), and you move it at least 20% to the left (X position), any player connected to the X-channel will begin to play. You can create great effects similar to scratching with this feature.
- 26. MIC 2 INPUT JACK** - This jack is used to a connect a microphone to the mixer. Connect you mic to **MIC 2** via 1/4 inch (6.3mm) jack. The signals will be controlled by **Channel 2 (4)**. BASS, MID, and TREBLE can be adjusted by the **Channel EQ (13)**.
- 27. MIC 1 INPUT JACK** - This jack is used to a connect a microphone to the mixer. Connect you mic to **MIC 1** via 1/4 inch (6.3mm) jack. The signals will be controlled by **Channel 1 (4)**. BASS, MID, and TREBLE can be adjusted by the **Channel EQ (13)**.
- 28. GND (GROUND TERMINAL)** - Connect each of your turntable ground leads to this terminal. This will reduce the humming and popping noises associated with magnetic phono cartridges.

## REAR PANEL - CONTROLS AND FUNCTIONS CONT.

29. **AC CONNECTION** - This connection is used for your detachable AC power cord. Be sure to only plug your unit in to the recommended power supply.
30. **RCA MAIN OUTPUTS** - The Master Output includes a pair **XLR Balanced Jacks (23)** as well as a pair **RCA Unbalanced Jacks**. The RCA jacks send a low current unbalanced output signal. These jacks should only be used for shorter cable runs to signal processors or looping to another mixer. For cable runs greater than 10 feet use the **XLR Balanced Jacks (23)**.
31. **RCA MAIN OUTPUTS** - The Master Output includes a pair **XLR Balanced Jacks (23)** as well as a pair **RCA Unbalanced Jacks**. The RCA jacks send a low current unbalanced output signal. These jacks should only be used for shorter cable runs to signal processors or looping to another mixer. For cable runs greater than 10 feet use the **XLR Balanced Jacks (23)**.
32. **REC OUT** - This is a low current unbalanced output source designed for various tape and CD recorders. The Record Out (REC OUT) level is dictated by the **Channel Fader Level (4)**, it is not influenced by the master volume control.
33. **CHANNEL 3/LINE 3 RCA INPUT JACKS** - Connect CD players or Tape Decks to LINE inputs. Line level musical instruments with stereo outputs such as Rhythm Machines or Samplers should also be connected to LINE inputs. Turntables should only be connected to "Phono" inputs. The red colored RCA jack represents the right channel input and the white represents the left channel input.
34. **CHANNEL 3/PHONO 3 INPUT JACKS** - The type of input must directly reflect the selected mode of the **Line Level Selector Switch (37)**. Connect turntables equipped with MM pickup cartridge to PHONO inputs (All DJ turntable use MM pick-up cartridges). CD players or Tape Decks and other line level instruments may be connected to these jacks as long as the **Line Level Selector Switch (37)** is in the "AUX 3" position should be connected to AUX LINE input. The red colored RCA jack represents the right channel input and the white represents the left channel input.
35. **CHANNEL 2/LINE 2 RCA INPUT JACKS** - Connect CD players or Tape Decks to LINE inputs. Line level musical instruments with stereo outputs such as Rhythm Machines or Samplers should also be connected to LINE inputs. Turntables should only be connected to "Phono" inputs. The red colored RCA jack represents the right channel input and the white represents the left channel input.
36. **CHANNEL 2/PHONO 2 INPUT JACKS** - The type of input must directly reflect the selected mode of the **Line Level Selector Switch (37)**. Connect turntables equipped with MM pickup cartridge to PHONO inputs (All DJ turntable use MM pick-up cartridges). CD players or Tape Decks and other line level instruments may be connected to these jacks as long as the **Line Level Selector Switch (37)** is in the "AUX 3" position should be connected to AUX LINE input. The red colored RCA jack represents the right channel input and the white represents the left channel input.
37. **LINE LEVEL SELECTOR SWITCH** - This switch is used to change the mode of **PHONO INPUT JACKS (24, 36, and 39)**. When connecting turntable to these jacks be sure the switch is in the PHONO position, and when using line level input devices select AUX. ***Always be sure main power is shut off before change the position of the Line Level Selector Switch.***
38. **CHANNEL 1/LINE 1 RCA INPUT JACKS** - Connect CD players or Tape Decks to LINE inputs. Line level musical instruments with stereo outputs such as Rhythm Machines or Samplers should also be connected to LINE inputs. Turntables should only be connected to "Phono" inputs. The red colored RCA jack represents the right channel input and the white represents the left channel input.
39. **CHANNEL 1/PHONO 1 INPUT JACKS** - The type of input must directly reflect the selected mode of the **Line Level Selector Switch (37)**. Connect turntables equipped with MM pickup cartridge to PHONO inputs (All DJ turntable use MM pick-up cartridges). CD players or Tape Decks and other line level instruments may be connected to these jacks as long as the **Line Level Selector Switch (37)** is in the "AUX 3" position should be connected to AUX LINE input. The red colored RCA jack represents the right channel input and the white represents the left channel input.



# SET-UP INSTRUCTIONS

## INPUTS/OUTPUTS

The MX-1 allows you two types of output connectors **Balanced XLR (25)** and **Unbalanced RCA (32, 33, and 34)**. Use these connection to connect the output signal from a mixer, cross-over or EQ to your MX-1 mixer. A balanced connection is recommended for cable runs longer than 10ft. When constructing your own XLR cables follow the pin configuration describe below for proper connections. For cable runs shorter than 10Ft. you may choose the RCA unbalanced output option. The unbalanced output option may be more convenient for most users due to the abundant supply of prefabricated cables on the market.

All the input options on the mixer are unbalanced RCA's. For best results do not use cable run longer than 10ft for any incoming audio source, longer cable runs will result in inferior sound quality.

### Male XLR Pin Configuration:

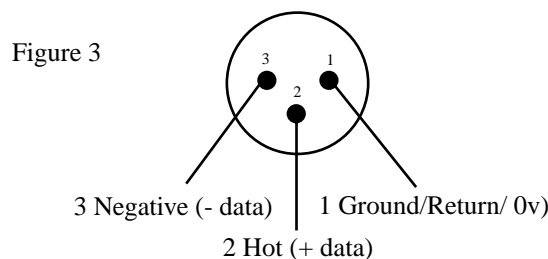

### Connections (Refer to diagrams on page 7, 11, & 12)

- Before you connect the unit's main power supply, be sure local voltage matches that of the required mixer voltage. Remember the mixer can be selected to operate with either 115v or 230v. Operational can be changed by the **Voltage Selector (24)** on the rear of the unit.
- Be sure the power switch is in the OFF position before making any type of connections to the mixer. Also be sure the power on all units being connected to the mixer have been switched off.
- Before switch the power on the mixer be sure **Main Volume (17)** is turned down and the power switch to all your amplifier are in the "OFF" position.
- Connect the mixers **Master Output Jacks (25 or 32)** to your audio system. Make sure that the channels are set properly. When using the **Balanced Output Jacks (25)** be sure your cable follow the above Pin Configuration (Figure 3).
- For recording, connect your tape recorder or cassette deck to the **REC OUT Jacks (34)**The Record Out level will not be influenced by the **Master Volume Control (17)**. The Record Out (REC OUT) level is dictated by the **Channel Fader Level (4)**.
- Connect a microphone to any of the three available **Mic Input Jacks (10, 28, & 29)**.
- You can connect up to 3 turntables using the **Phono 1 (41), Phono 2 (38), or Phono 3 (36)** RCA jacks on the rear panel. The mixer will only accept turntable level signal if **Line Level Switches (39)** are in the "PHONO" position.
- Connect your tape recorder, tuner, sound effects, CD player, and cassette decks etc. to the **RCA Line Level Input Jacks (35, 37, and 40)** on the rear panel. CD players, cassette decks and other line level instruments may also be connected to the "Phono RCA Jacks (34, 36, and 39) as long as the **Line Level Switches (39)** are in the "AUX" position.

## Typical Mixer Set-Up

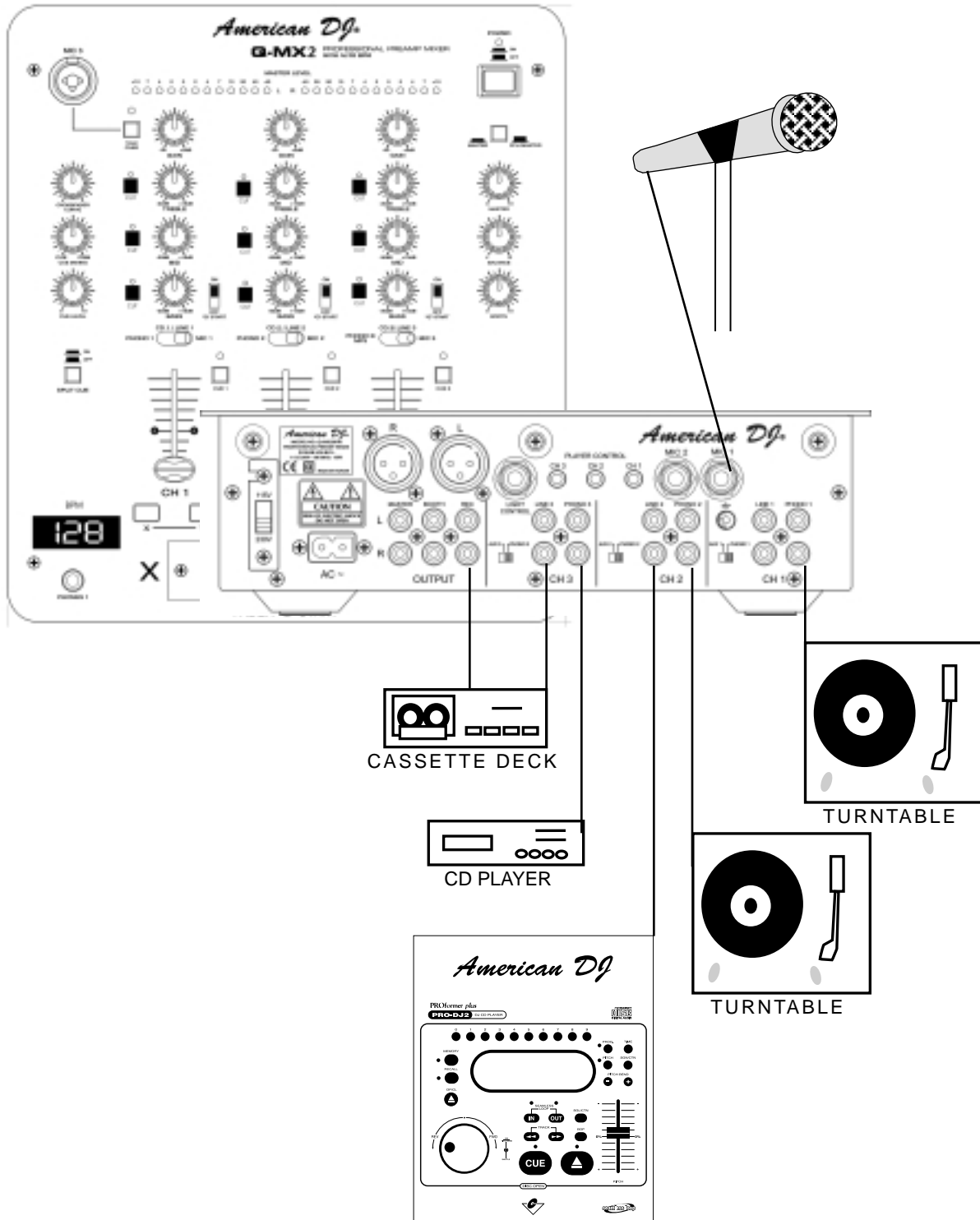

This image details a typical DJ Set Up consisting of a microphone, turntables, CD players, and a tape deck.

**Note:** Turntables can only be connected to the **Phono Line Level RCA Jacks (36, 38, and 41)**. Be sure the **Line Level Switches (39)** are in the "PHONO" position.

## Typical Stereo Set-Up

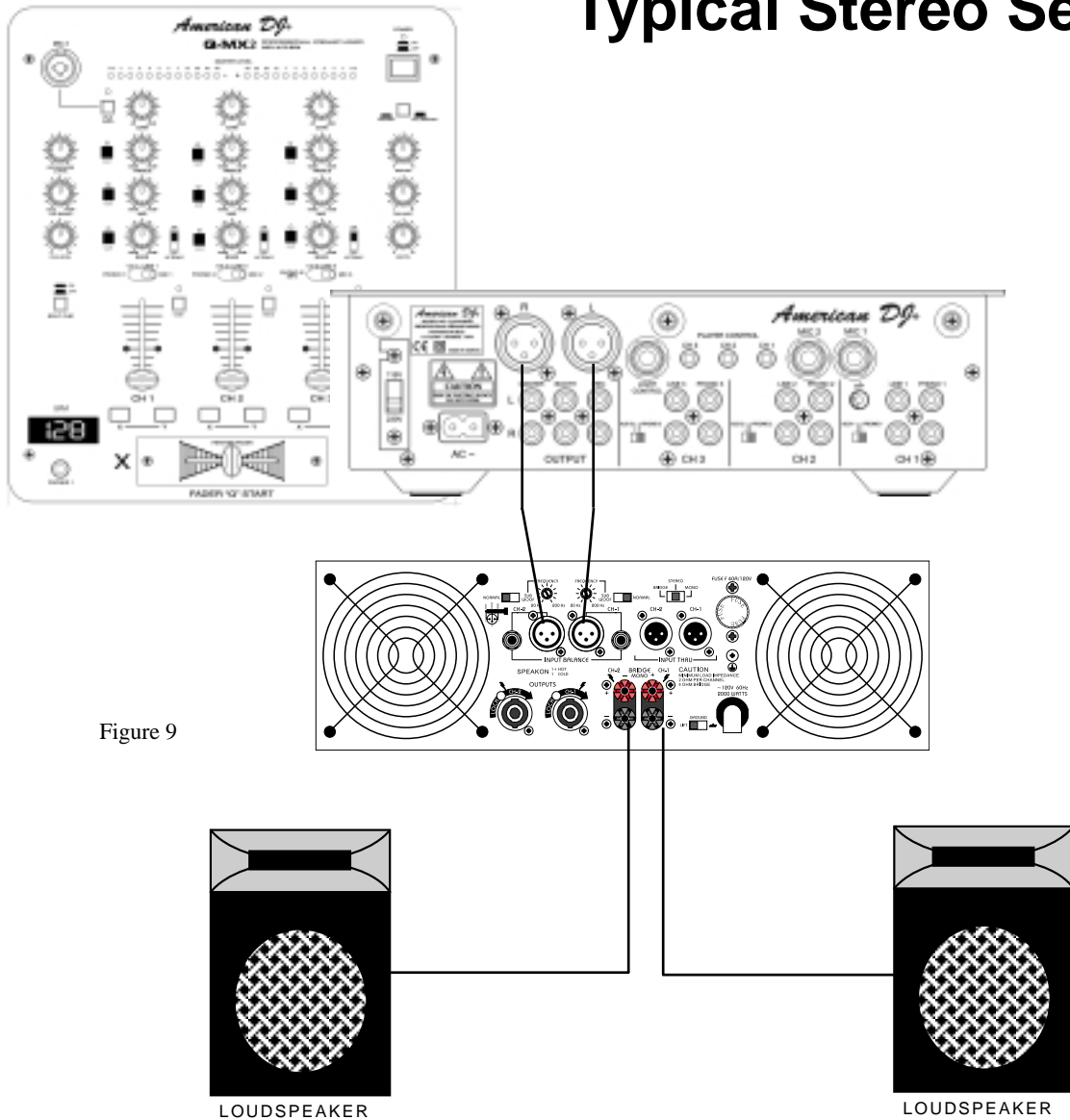

Figure 9

### Typical Balanced Output Set-up

This image details a typical stereo output layout. Note the use of the Balanced XLR Jacks on both the mixer and the amplifier. Always use the balanced output jacks whenever possible. The balanced output jacks should always be used for cable runs in excess of 10 feet.

Using the balanced jacks will ensure a clean signal through out the entire audio system.

# OPERATING INSTRUCTIONS

## Operating Determinations

When installing this mixer, please make sure that the device is not exposed to extreme heat, moisture or dust! There should not be any cables lying around. Doing so endangers you as well as others. Do not operate the mixer in extremely hot (more than 30° / 100°F) or extremely cold (less than 5°C / 40°F) surroundings. Keep away from direct sunlight and heaters.

Operate the mixer only after becoming familiar with its functions. Do not permit operation by persons not qualified for operating the mixer. Most damages are the result of unprofessional operation!

Never use spray cleaners to clean the faders! Never use solvents or abrasive detergents to clean the mixer! It is recommended that you use a soft damp cloth. Please consider that unauthorized modifications on the device are forbidden due to safety reasons!

## CROSSFADER REPLACEMENT INSTRUCTIONS

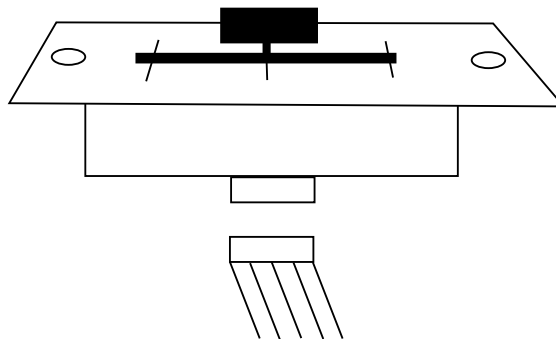

***The crossfader is "Hot Swappable" which means it may be replaced at any time, even when power is applied. Only replace with American Audio Part Feather Fader Plus. Replacing with any other model fader may seriously damage your unit.***

## Replacing the Crossfader

1. Disconnect the mixers main power supply
2. Using a number two Phillips screw driver, unscrew the each of the stainless steel retain screws that hold the crossfader in place.
3. Gently remove the crossfader from its seated position. You may need to wiggle the crossfader slightly to remove it.
4. After removing the crossfader, disconnect the ribbon cable that attaches the crossfader to the PC board. Grasp the crossfader by its base and pull the ribbon cable by its connector not the actual cables. The connector is desired to only fit one way, so don't worry about the connectors orientation.
5. Connect the new crossfader to the ribbon cable and replace in reverse order.

# TECHNICAL SPECIFICATIONS

## Technical Specifications - Model Q-MX2 BPM

<b>Model:</b>	Q-MX2 BPM, 3 Channel Mixer
<b>Power supply:</b>	AC 115/230V, 50/60Hz switchable
<b>Dimensions:</b>	11" W x 12.25" D x 3" H
<b>Weight:</b>	8 lbs. / 3.5 kg
<b>Crossfader:</b>	Optical detecting fader start control - Low grounding impedance crossfader
<b>Power Consumption:</b>	5W typical, 7W w/ full headphone output
<b>Headphone impedance:</b>	16 Ohms

### **Input Sensitivity (Level/Impedance):**

<b>Line:</b>	-14 dBV (200mV) / 12K Ohm +/- 3dB
<b>Microphone:</b>	-59 dBV (1.2mV) / 3K Ohms +/- 3dB
<b>Phono:</b>	-51 dBV (2.8mV) / 47K Ohms +/- 3dB
<b>Aux:</b>	-14 dBV (200mV) / 47K Ohms +/- 2dB

### **Output Sensitivity (Level/Impedance):** Note: 0dBV=1Vrms

<b>Rec Out (RCA):</b>	-10dBV (316mV) / 1K Ohms +/-3dB
<b>Master Out (RCA):</b>	0dBV (1V) / 560 Ohms +/- 3dB
<b>Master Out (XLR):</b>	0dBV (1V) / 470Ohms +/- 3dB
<b>Phones (Load=32 Ohms):</b>	-2dBV (0.4V) /33 Oms +/-32dB

### **Maximum Output (Load + 47K, THD = 5%)**

<b>Rec:</b>	< 18dBV (8V)
<b>Master (RCA):</b>	< 18dBV (8V)
<b>Master (XLR):</b>	< 18dBV (8V)
<b>PHONES (Load=32 ohms):</b>	< 6dBV (2V)

**Channel Balance:** Within 3dB

### **Frequency Response:**

<b>Line:</b>	20Hz - 20KHz, $\pm$ 1dB
<b>Phono:</b>	20Hz - 20KHz, $\pm$ 1.5dB (RIAA)
<b>Aux:</b>	20Hz - 20KHz, $\pm$ 1dB
<b>Microphone:</b>	20Hz - 20KHz, +1, -3dB

### **THD - Total Harmonic Distortion (1Khz, 0dBV Output):**

<b>Master Output (Load = 47K Ohms):</b>	Less than 0.3%
<b>Phono: (Load = 32K Ohms):</b>	Less than 0.3%

**Cross Talk:** < 40dB @ 1Khz between left and right channels

### **Channel Equalizer:**

<b>Bass =</b>	+12 $\pm$ 1dB, -22 $\pm$ 2 dB at 70KHz
<b>Mid =</b>	+12 $\pm$ 1dB, -17 $\pm$ 2 dB at 1KHz
<b>Treble =</b>	+13 $\pm$ 1dB, -27 $\pm$ 2 dB at 13KHz

## Warranty & Service:

The Q-MX2 BPM has a 2-year limited warranty. Please mail in warranty card as soon as possible to validate your warranty.

For any service related issues please contact American DJ customer support at (800) 322-6337, Monday through Friday 9:00 am to 5:00 pm Pacific Standard Time, or contact us on the web at support@americandj.com.

## Free Manuals Download Website

<http://myh66.com>

<http://usermanuals.us>

<http://www.somanuals.com>

<http://www.4manuals.cc>

<http://www.manual-lib.com>

<http://www.404manual.com>

<http://www.luxmanual.com>

<http://aubethermostatmanual.com>

Golf course search by state

<http://golfingnear.com>

Email search by domain

<http://emailbydomain.com>

Auto manuals search

<http://auto.somanuals.com>

TV manuals search

<http://tv.somanuals.com>