

APC Silcon 240-320kW400V UPS User Guide



APC
www.apcc.com

Copyright ©2001 APC Japan

Information in this document is subject to
change without notice and does not represent
a commitment on the part of the vendor



Thank You

Thank you for choosing APC Silcon. Please read this User Guide thoroughly prior to installing the system as it provides important information on safe and efficient installation and use.

The installation and use of this product must comply with national, federal, state, municipal and local codes.

Safety Symbols used in this manual



WARNING! Indicates a hazard which, if not avoided, could result in injury or death.



CAUTION! Indicates a hazard which, if not avoided, could result in damage to the product or other property.

NOTICE! Read and pay attention to this important information.



WARNING!

This UPS unit contains hazardous AC and DC voltages. Only qualified electricians should connect the UPS, AC line and external batteries, and must be familiar with batteries and battery installation. Before installing, maintaining or servicing the UPS, shut off the UPS and disconnect all sources of AC and DC power.

As the UPS has no built-in disconnection devices to switch off external AC and DC input power, ensure that disconnection devices are available as separate parts in connection with the installation!

The installer must provide each external disconnecting device for this UPS system with labels with the following text:

“Isolate the Uninterruptible Power Supply (UPS) as instructed in this guide before working on circuit”

AC and/or DC voltage will always involve a potential risk of AC voltage at UPS output generated from either batteries or utility. To avoid equipment damage or personal injury, always assume that there may be voltage at UPS output.

This system is equipped with an auto-start function. If activated, the system may start without warning. Refer to the “Programming” section for information on de-activation.

TEST BEFORE YOU TOUCH!

To reduce the risk of fire or electric shocks, install the UPS and external batteries in a temperature and humidity controlled indoor area, free of conductive contaminants.

UPS batteries are high-current sources. Shorting battery terminals, DC terminals or DC busbars can cause severe arcing, equipment damage and injury. A short circuit can cause a battery to explode. Always wear protective clothing and eye protection and use insulated tools when working on batteries.



CAUTION!

This unit contains components sensitive to electrostatic discharge (ESD). If you do not follow the ESD procedures, you may cause severe damage to electronic components.



PLEASE RECYCLE





The shipping materials are recyclable. Please save for later use or dispose of them appropriately.

1.0 Introduction

This UPS system is designed to offer reliable and problem-free power supply for several years. The system requires only a minimum of maintenance, but we recommend you follow the maintenance guidelines described in section 6.0 Maintenance & Testing.

1.1 Display Unit

The display unit (located on the front of the UPS) is the link between the user and the UPS and consists of a display, an alarm LED indicator and a keyboard. The display reads parameters, measured values and alarm messages. Alarms and the pressing of keys will activate a back light which is set to switch off automatically after 5 minutes of inactivity.

By pressing  and  simultaneously you increase the back light contrast. The pressing of  and  simultaneously decreases the contrast.

The LED alarm is linked to an acoustic signal indicating incorrect operation. Alarms will change the LED light from green to red. Use keyboard to program operating parameters and to display parameters / alarm messages.

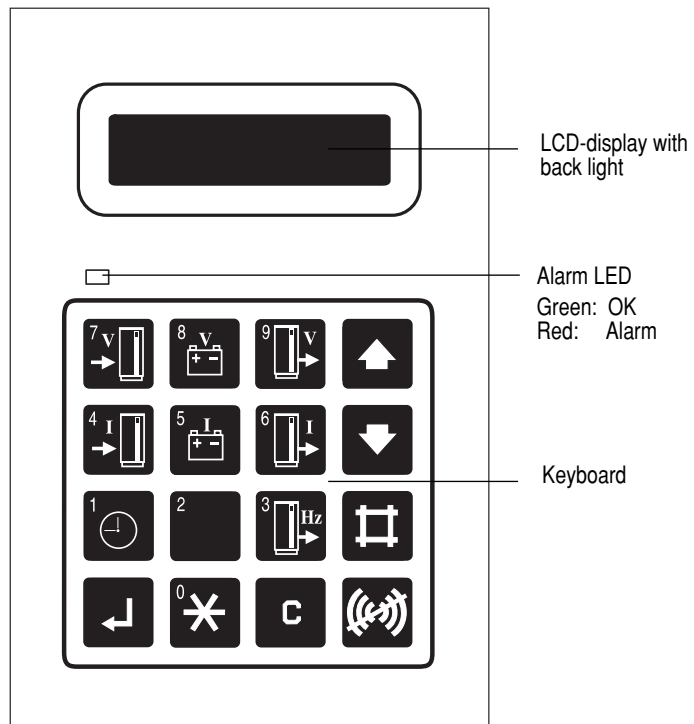

NOTICE!

Display accuracy is $\pm 2\%$, ± 1 digit.

Stop/Start UPS and Operating the External Service Bypass

2.0 Stop/Start UPS and Operating the External Service Bypass Panel



WARNING!

AC voltage generated either from batteries or mains may be present at UPS output.

Always disconnect AC input supply source, switch off UPS, AND switch off DC.

TEST BEFORE YOU TOUCH!

Some UPS systems have a factory-set autostart feature, automatically switching on UPS whenever mains supply is switched on (AC line). See section 4.0 Parameter settings for instructions on how to switch off this function.

Only qualified electricians should start up or shut down APC Silcon UPS systems and instructions in the Installation Guide should be followed. Prior to being serviced, the APC Silcon UPS must be left in shut-down mode for a minimum of 5 minutes.



CAUTION!

Refer to the Maintenance & Testing section in this guide if the UPS is to be taken out of operation for more than 48 hours.

Users without electrical qualifications may switch UPS to and from stand-by-mode/normal operation, following instructions below. (**In stand-by mode, the UPS has no output voltage**).

2.1 Stop UPS (for stand-by)



CAUTION!

If the UPS system is equipped with a service bypass panel, and if the load must remain energized by mains, refer to the Operating Service Bypass Panel sections in this guide before proceeding

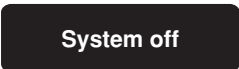
Action	Display shows	Description
Open the front door and activate the "ON" and "OFF" push-button simultaneously		Alarm LED lights. Acoustic alarm sounds for 30 seconds

2.2 Start UPS (from stand-by)

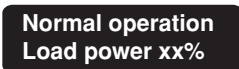
Action	Display shows
Open the front door and activate the green and "ON" push button	

Stop/Start UPS and Operating the External Service Bypass

2.3 Stop UPS (for complete power down)

2.3.1 Switching off the UPS

**CAUTION!**

If the UPS system is equipped with a Service Bypass Panel, and if the load must remain energized by mains, refer to the Operating Service Bypass Panel sections in this guide before proceeding

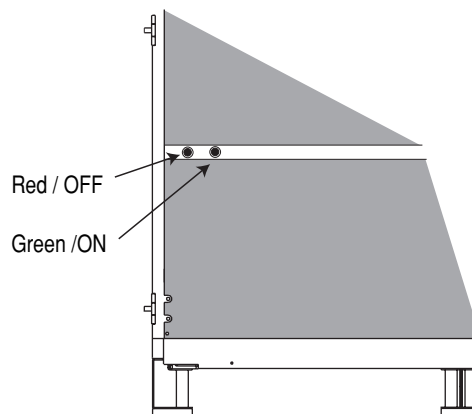
**WARNING!****TEST BEFORE YOU TOUCH!**

A special design feature switches the system into bypass operation in the event of internal power supply failure or controller circuit failure to ensure uninterrupted output voltage. Because of this special feature, the UPS may contain output voltage even when it is switched off.

Stop/Start UPS and Operating the External Service Bypass

1. Open front doors	
2. Note that step 3 will interrupt output voltage and activate the alarm! The red LED alarm below the display will light up The acoustic alarm will sound for 30 seconds*	
3. Press the green ON and the red OFF button simultaneously. The red LED alarm below the display will light up The acoustic alarm will sound for 30 seconds*	Display shows **System OFF**
4. On systems with no Service Bypass Panel, switch off the mains supply	**System OFF**
5. The red LED alarm below the display will light up The acoustic alarm will sound for 30 seconds	
6. Switch off battery breakers F001 and F002 in the Battery Breaker Box or battery cabinet Refer to LED indication and labelling in Battery Breaker Box or battery cabinet	
7. To switch off mains supply, open Q001 – on systems with Service Bypass Panel.	
8. The acoustic alarm sounds	Blank

*Reset the acoustic alarm by pressing .

The UPS is now isolated. Maintenance/repair, disconnection or removal can now be carried out.



CAUTION!
Recharge batteries out of service every 3 months to prevent damage.

WARNING!
Internal DC capacitor may contain energy even after the UPS has been switched off. Allow for automatic discharge by waiting at least 5 minutes after switching off UPS and battery breakers before working on the UPS.

Stop/Start UPS and Operating the External Service Bypass



2.4 Start UPS (from complete power down)

2.4.1 UPS start-up

**CAUTION!**

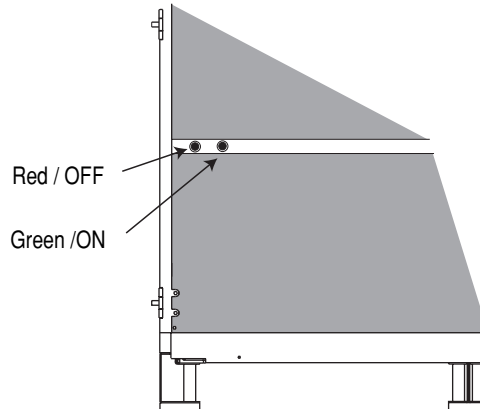
Make sure all cable connections are in place prior to first start-up.

**NOTICE!**

After first system start-up, check that battery temperature is displayable (press  and  simultaneously on the display – it reads NV (not valid) if incorrectly installed). A battery capacity test is recommended after the electric installation.

NOTICE!

If for any reason the start-up procedure is interrupted, wait for the display to show the step 4 message: “Stop charge DC capacitors : YES” and repeat procedure from there.



**CAUTION!**

Do not close the MCCBs in the Battery Breaker Box unless the display reads: “Insert fuse or close MCCB” – otherwise the UPS may be damaged. If the display reads “DC capacitor charge error”, do not close MCCB. Call for assistance.

**WARNING!**

If “Autostart” is active the UPS will start automatically after step 9 (with a 1-minute delay)

Stop/Start UPS and Operating the External Service Bypass

1. Check that the system has been in a stable environment for at least 12 hours enabling any condensation to evaporate prior to start-up.	
2. Open front door(s)	Display shows
3. Switch on mains power by closing Q001 See notice below.	System type XXX XXX kVA - XXX
4. Wait for approx. 10 seconds	Stop charge DC capacitors :YES
5. Press  on the keyboard	Start charge DC capacitors :YES
6. Press  on the keyboard	Data stored
7. Wait for approx. 1 second	Start charge DC capacitors :YES
8. Wait for approx. 1 minute	Insert fuse or close MCCB
9. Close MCCBs in Battery Breaker Box or Battery Cabinet	**System OFF**
10. Press the green ON button	Normal operation load power XX%
11. Close the front door(s)	

System start-up now completed.

NOTICE!

One of the following display messages will appear by UPS start-up:

- "STD": Standard (single system)
- "PAR": Parallel System
- "ECO": Economy mode (single or parallel systems)
(Last message has priority over the other two)

kVA size (XXX) and the voltage reads:





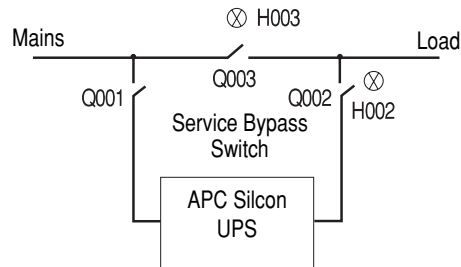

- XXXkVA - 400 (380 or 415 Volt)

Stop/Start UPS and Operating the External Service Bypass

2.5 Operating the External Service Bypass Switch (single systems)

2.5.1 Bypassing the Single System UPS



Action	Display shows
1. Press  on the keyboard	
2. Press  or  on the keyboard until	Bypass operation : NO
3. Press  on the keyboard	Bypass operation : YES
4. Press  on the keyboard	
5. Check light indication on the bypass panel	Lamp indication on Bypass Panel Green light (H003) above the bypass switch handle (Q003) lights up
6. Set the external bypass switch (Q003) to position 1	Green light (H002) above the output switch handle (Q002) lights up
7. Set the output switch (Q002) to position 0	Only the light (H002) above the output switch handle (Q002) is now on
8. Open the front door and press the green ON and the red OFF button simultaneously The acoustic alarm sounds for 30 seconds*	Display shows **System OFF**
9. Set the input switch (Q001) to position 0 The red alarm LED below the display lights up and the acoustic alarm sounds for 30 seconds*	
*Use the  key to reset the acoustic alarm	

Stop/Start UPS and Operating the External Service Bypass









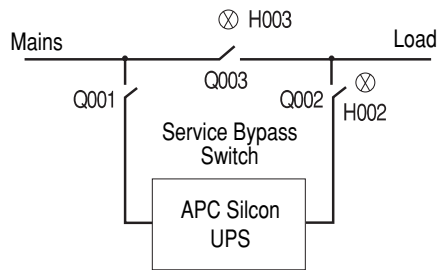





CAUTION!

Do not leave UPS out of service for more than 48 hours. Refer to section 2.3 Stop (for complete power down).

2.5.2 Switching the Single System UPS from External Bypass into Normal UPS Operation



Stop/Start UPS and Operating the External Service Bypass

Action	Display shows
1. Set the input switch (Q001) to position 1	**System OFF**
2. Wait 5 sec. Open the front door of the UPS and press the green ON key	Normal operation load power 0%
3. Press  on the keyboard	
4. Press  or  on the keyboard until	Bypass operation : NO
5. Press  on the keyboard	Bypass operation : YES
6. Press  on the keyboard	
7. Check light indication on the bypass panel	Lamp indication on Bypass Panel Green light (H002) above the output switch handle (Q002) lights up
8. Set the output switch (Q002) to position 1	Green light (H003) above the bypass switch handle (Q003) lights up
9. Set the bypass switch (Q003) to position 0	Only the light (H003) above the bypass switch handle (Q003) is now on
10. Press  on the keyboard	Display shows
11. Press  or  on the keyboard until	Bypass operation : YES
12. Press  on the keyboard	Bypass operation : NO
13. Press  on the keyboard	
14. Press  on the keyboard	Normal operation load power 0%
15. Press  on the keyboard	All lights on the bypass panel switched off

NOTICE!

If battery has been disconnected, please refer to section 2.4.1 UPS start-up.

Stop/Start UPS and Operating the External Service Bypass

2.6 Operating the External Service Bypass Switch (parallel systems)



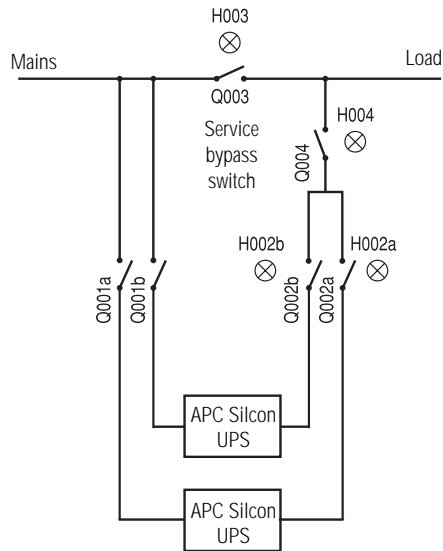



2.6.1 Bypassing the Parallel UPS System (All UPSs)



CAUTION!

Do not leave UPS out of service for more than 48 hours. Refer to section 2.3 Stop (for complete power down).

Stop/Start UPS and Operating the External Service Bypass

Action	
Steps 1-4 apply to all the parallel systems. Note that this will switch all systems into bypass operation	
1. Press  on the keyboard	Display shows
2. Press  or  on the keyboard until	Bypass operation : NO
3. Press  on the keyboard	Bypass operation : YES
4. Press  on the keyboard	
All systems switch to bypass operation	Bypass operation
Do not switch off any of the UPS systems until steps 5-8 have been completed	
5. Check light indication on the bypass panel	Lamp indication on Bypass Panel Green light (H003) above the bypass switch handle (Q003) lights up
6. Set the external bypass switch (Q003) to position 1	Green light (H004) above the output switch handle (Q004) and green lights (H002) above the output switch handles (Q002) light up
7. Set the output switch (Q004) to position 0	H003 switches off H002 and H004 still on
8. Set all output switches (Q002) to position 0	H002 and H004 still on
9. Open the front door of any one system and press the green ON and the red OFF button simultaneously The acoustic alarm sounds for 30 secs* Repeat for (all) other system(s)	Display shows **System OFF**
10. Set all input switches (Q001) to position 0	
The red alarm LED below the display lights up and the acoustic alarm sounds for 30 secs*	
*Reset the acoustic alarm by pressing the  key.	

Stop/Start UPS and Operating the External Service Bypass



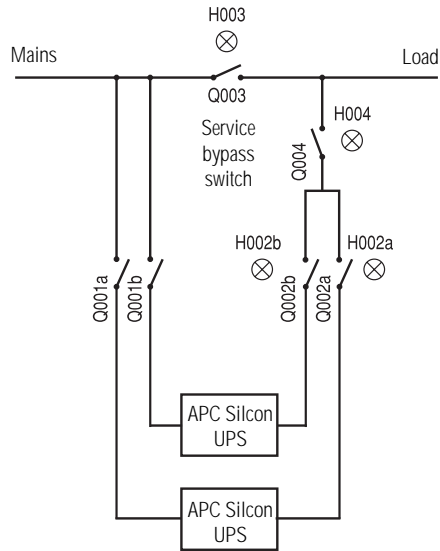







2.6.2 Switching the Parallel System from External Bypass into Normal UPS Operation



NOTICE!

If battery has been disconnected, please refer to section 2.4.1 UPS start-up.

Stop/Start UPS and Operating the External Service Bypass

Action	Display shows
1. Check that the output switch (Q004) is set to position 0	
2. Check that all output switches (Q002) are set to position 1	
3. Set input switches (Q001) to position 1	**System OFF**
4. Wait 10 secs. Open the UPS front door and press the green ON button on all systems	Normal operation load power 0%
5. Press  on the keyboard	
6. Press  or  on the keyboard until	Bypass operation : NO
7. Press  on the keyboard	Bypass operation : YES
8. Press  on the keyboard	
All systems switch to bypass operation	Bypass operation
Note! If Q002s are in position 0 off, only programmed systems will switch to bypass	Lamp indication on Bypass Panel H002 and H004 light up
9. Set the output switch (Q004) to position 1	Green light (H003) above bypass switch lights up
10. Turn the bypass switch (Q003) to position 0	The green lamps (H002) and (H004) are switched off, but (H003) is lit until normal operation.
The following can be carried out on any UPS	
11. Press  on the keyboard	Display shows
12. Press  or  on the keyboard until	Bypass operation : YES
13. Press  on the keyboard	Bypass operation : NO
14. Press  on the keyboard	
All the systems will transfer to normal operation	Normal operation load power 0%
	No lamps on the bypass panel are lit

Stop/Start UPS and Operating the External Service Bypass

2.7 Isolating one UPS in a Parallel Configuration for Service/Maintenance

2.7.1 Isolating one UPS in a Parallel/Redundant System

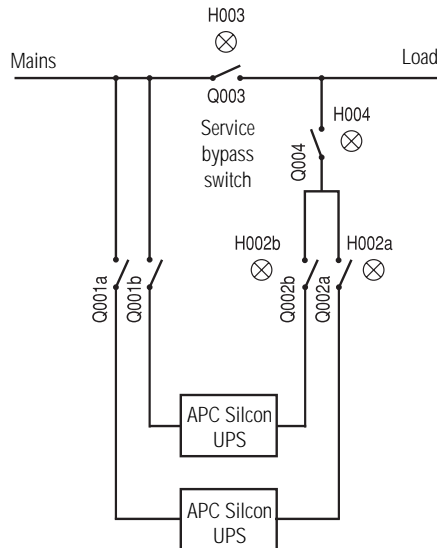

In a redundant system one UPS may be isolated for service/maintenance without affecting other parallel UPS(s).

Action

1. Check that the remaining UPS(s) will be able to carry the load when one UPS is isolated.
2. Switch off the system to be isolated for maintenance by pushing the green ON and the red OFF button simultaneously.
3. Disconnect output and mains by setting output switches (Q002) to position 0 and input switch (Q001) to position 0. Disconnect battery by opening battery breaker.

2.7.2 Switching Back the UPS to Normal Parallel/Redundant Operation

Action

1. Set the input switch (Q001) and the output switch (Q002) to position 1.
2. Charge capacitors, connect battery, and start up the UPS as described in 2.4.1. Start UPS (from complete power down).

The UPS will automatically switch to normal operation and start load-sharing with the other paralleled UPS(s).



WARNING!

The system will discharge built-in capacitors. ALWAYS check with a multimeter that the terminals contain no dangerous voltage before touching the system!

Stop/Start UPS and Operating the External Service Bypass

NOTICE!

With Q002 in position 0, the UPS can be operated and tested as a single system without affecting the other parallel UPS(s) if correct monitoring device has been installed. Applicable to all bypass panels.

Operation

3.0 Operation

The display unit will read parameters, alarms/messages and measured values. LED alarm incorporates audible alarm, indicating unusual operating situations. The keyboard is used to program and control parameters and to display alarm messages and measured values.

3.1 Keyboard

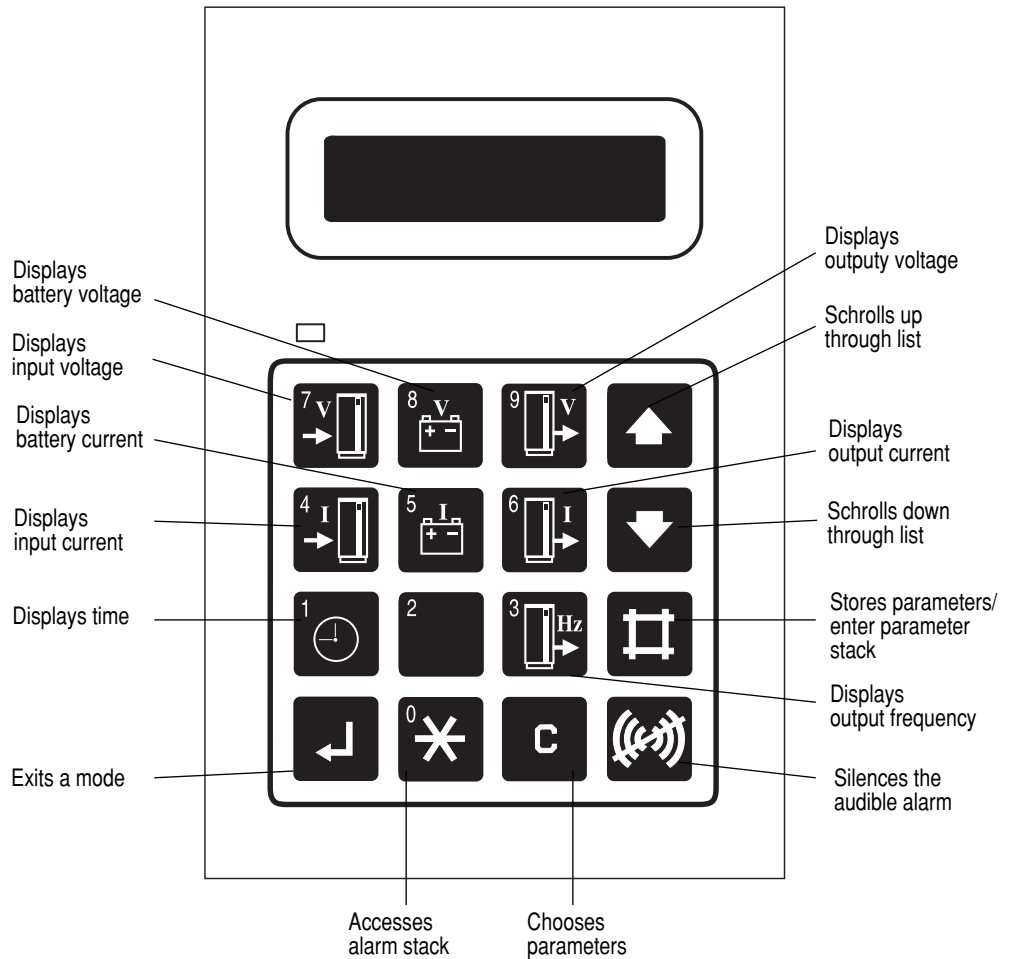

NOTICE!

By pressing **2** and **Up Arrow** simultaneously you increase back light contrast. The pressing of **2** and **Down Arrow** simultaneously decreases the contrast.

3.2 Display of Measured Values

To read measurements, press one or two keys simultaneously as shown below. (Illustrated values are examples only).

Action	Display shows	Description
	98.01.16 10.22,13	Year, month, day Hour, minute, second
	Mains 1 voltage 385 385 385Vac	Mains 1 voltage is 3 x 385V
	Mains 1 current 16 16 16Aac	Mains 1 current is 3 x 16A
	Battery voltage 438 437Vdc	Battery voltage is 438Vdc on battery 1 437Vdc on battery 2
	Battery current + 2Aac	Charging current is (+) 2Aac (Discharging current (-))
	Output voltage 400 400 400 Vac	Output voltage is 3 x 400V
	Output current 15 15 15Aac	Output current is 3 x 15A
	Output frequency 50Hz	Output frequency is 50/60Hz
	Battery temperature 25°C	Battery temperature is 25°C
	Output peak current 22 22 22A	Output peak current is 3 x 22A (only of interest for service engineers).
	Normal operation load power xx%	Returns to normal status indication. If not pressed, automatic switch back will be performed after 20 seconds.
	Batt. load : 0 Batt. tank: 100	Battery load in percent. Left battery capacity in percent.

3.3 Using the Remote Display

The remote display is an inactive unit that is unable to influence the operation of the APC Silcon UPS. It is impossible to adjust or otherwise influence the function of the UPS. The alarms available on the remote display are at subset of the alarms, which can be read on the internal display.

- Operation of Remote Display is described in section 3.0 above.
- Alarms available are described in section 5.0 Alarms.
- Readout of measurements as described in section 3.2 above.

NOTICE!

Time cannot be displayed from the Remote Display.

Operation

3.4 Economy Mode

When the UPS is running in Economy Mode, the load will be supplied directly from mains and output voltages are UPS monitored. In the event of a mains disruption, the UPS will switch to battery mode without affecting the load.

Prior to switching to bypass mode, leave the system running in normal mode for 8-10 hours to charge batteries to full capacity.

To keep batteries fully charged, UPS is pre-programmed to switch back to normal operation whenever necessary.

Economy Mode not available for parallel configurations.

At start-up, the system will at first go into normal operation to ensure a fully charged battery, and it will then switch into bypass after the programmed time (8-10 hours).

NOTICE!

Check cable dimensions as input power factor is not corrected with UPS running in Economy Mode.

Parameter Settings

4.0 Parameter Settings

Below tables show operating parameters programmable from keyboard. Only qualified users should alter programming parameters. See below examples.

Parameter Settings

Parameter	Setting*	Comments
Bypass operation	YES, NO	YES will switch the system into bypass mode***
Language	GB, D, F, DK, S, SF, NL, PL, CZ, E, P, SK, H	Languages of text in display
Autostart	YES, NO	Automatic restart by mains return (1 min. delay). Ensures quick battery recharge.
Remote shutdown active	YES, NO	Shutdown of UPS by remote signal when in battery operation. Saves battery energy.
Remote shutdown	HIGH , LOW	Nature of remote shutdown signal level
Remote shutdown time	0, 1, 2 , 3, 4, 5, 6, 7, 8, 9, 10 min.	Time delay on remote shutdown of UPS
Battery capacity test	–	Initiates back-up time check. Time measured from start until it reaches low DC warning level (See User Guide, section 6).
Battery monitor test **	–	Initiates checks of battery condition by 25% discharging.
Automatic battery test**	OFF , 3,6 months	Activates the battery monitor test in cyclic intervals.
Battery monitor reset**	–	Press the C and ⏏ key to reset alarm (flashing light).
Boost charge	YES, NO	YES results in boost charge (10 hours)
Autoboost charge	YES, NO	YES results in boost charge after battery operation (10 hours).
Enter new date	YYMMDD	Set to local date
Enter new time	HHMMSS	Set to local time (24 hour clock)

* Factory settings in bold

** For systems with active Battery Monitor only

*** Do not leave system running in bypass mode (Static bypass) for extended periods of time, as batteries are not recharged in bypass mode.





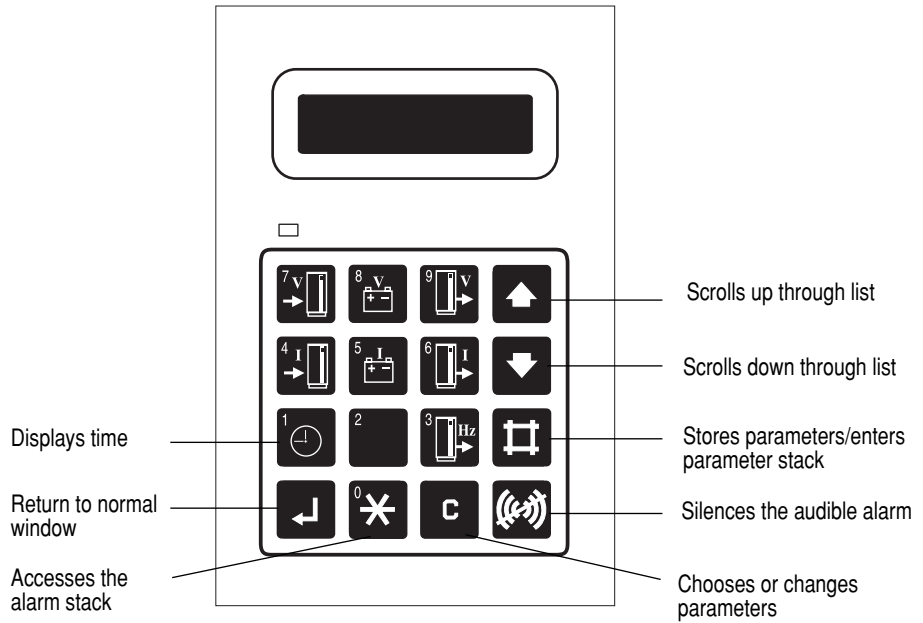

Parameter Settings

4.1 Programming Keys









4.2 Switching to Bypass Operation

Programming Example

Action	Display shows
1. Press  to enter parameter stack	
2. Press  or  until	Bypass operation : NO
3. Press  until	Bypass operation : YES
4. Press  to store	
5. Press  to exit	Bypass operation

Parameter Settings

To return to normal operation

Action	Display shows
6. Press  to enter parameter stack	
7. Press  or  until	Bypass operation :YES
8. Press  until	Bypass operation :NO
9. Press  to store	
10. Press  to exit	Normal operation load power xx%

Follow same procedure to program other parameters.

Alarms and Events

5.0 Alarms and Events

Alarms are indicated by the red lamp (above the left hand corner of the keyboard) and a 30 seconds acoustic signal. An alarm is registered in the alarm stack as long as it is present, and if more in the same order as they arise.





Certain alarms, such as battery alarms, need resetting. See section 4.0 Parameter Settings.

All alarms are also registered in an event logger and remains there in a stack with room for 250 events. The events are stored in the same order as they arose - showing the latest first.







Besides the alarms the following operational modes are also stored in the event logger.

Mode	Comments
MPU is reset	UPS has been completely switched off
Stand-by	UPS has been in stand-by mode by parallel system
Normal operation	UPS has been in normal operation
Battery operation	UPS has been in battery operation
Bypass operation	UPS has been in bypass operation
System off	UPS has been off

5.1 Displaying the Alarm Stack

Action	Description
1. Press 	Access to the alarm stack.
2. Press  or 	Scroll up or down through the alarm stack messages. Last message is "No (further) alarm".
3. Press 	Exits the alarm stack. If not operated the system will exit the alarm stack automatically after 30 seconds.

5.2 Displaying the Event Stack

Action	Description
1. Press  and 	Press the two keys simultaneously to get access to the events stack
2. Press  or 	Scroll up or down through the event stack (last message is "No (further) event").
3. Press 	Displays the time where the event happened.
4. Press 	Exits the event stack. If not operated the system will exit the event stack automatically after 30 seconds.

5.3 Possible Alarms

Alarms	Description	Action
1. Peak current limiter active	Peak current limiter activated and UPS switched to bypass operation. System overload	Check for blown fuses in installation
2. Bypass power supply fault	Fault in redundant PSU for bypass. UPS still 100% able to operate in all modes.	Call for assistance
3. Delta current limiter active	Input current limiter activated and UPS switched to bypass operation	Check for overload. If message is repetitive - call for assistance
4. Faulty fan	Blocked or faulty fan	Remove blocking or replace fan
5. High DC warning	Switching off big output load	If alarm is repeated, reduce load change
6. High DC shutdown	UPS fault	Call for assistance
7. Off-button activated	Off button or emergency power shut down activated	–
8. Synchronization error	UPS unable to synchronize with input frequency	Check if phase rotation of mains input voltage is correct. If OK, call for assistance
9. Inverter voltage error	Inverter average voltage outside limits (normal message during system start-up/switch-off)	–
10. Parallel synchronization error	Parallel UPS unable to synchronize	Check external parallel cables - call for assistance
11. Inverter current limiter active	Inverter overload	Reduce UPS output load
12. Overload. Load exceeding 100%	UPS overload	Reduce UPS output load
13. Second power supply fault	UPS fault (only systems > 160kW)	Call for assistance
14. Internal power supply fault	UPS fault. Only bypass operation possible	Call for assistance
15. Battery MCCB is off	Battery MCCB/fuse not closed or released	Close MCCB / insert new fuse. If released again - call for assistance.
16. **Q004 off**	Output switch position for UPS in parallel	–
17. **Q003 off**	External bypass switch position	–
18. **Q002 off**	UPS output switch position	–
19. **Q001 off**	UPS input switch position	–
20. High temperature of isolation transformer	Temperature of isolation input/output transformer, too high	Check fan, check for airflow obstructions, check for overload
21. High temperature of main static switch	Temperature of static input switch, too high	Check fan, check for airflow obstructions, check for overload
22. High temperature of bypass static switch	Temperature of static bypass switch, too high	Check fan, check for airflow obstructions, check for overload

Alarms and Events

Alarms	Description	Action
23. Main inverter failure	Temperature of main inverter, too high or inverter fuse blown	Check fan, check for airflow obstructions, check for overload, check fuse
24. High temperature of delta inverter	Temperature of delta inverter, too high	Check fan, check for airflow obstructions, check for overload
25. Low DC shutdown	Battery discharged to minimum permissible level	Ensure battery recharging
26. Low DC warning	Battery nearly discharged	Save your data now
27. Mains momentarily outside tolerance	Short disturbances on mains supply (1 ms transients)	–
28. Mains outside tolerance	Mains input voltage R.M.S. value outside tolerance	–
29. Mains frequency outside tolerance	Mains input frequency outside tolerance	–
30. Bypass momentarily outside tolerance	Short disturbances on bypass voltage	–
31. Bypass outside tolerance	Bypass input voltage outside tolerance	–
32. Bypass frequency outside tolerance	Bypass input frequency outside tolerance	–
33. Output momentarily outside tolerance	Short disturbance on output voltage (inrush current)	If message reappears - call for assistance
34. Output outside tolerance	Output voltage outside tolerance	Call for assistance
35. Output frequency outside tolerance	Output frequency outside tolerance	Call for assistance
36. High battery temperature	Battery ambient temperature too high	Check system ambient temperature, check fan, check for airflow obstructions
37. Battery weak	Battery capacity below 75% or battery MCCB/fuse switched off	Test battery capacity
38. Battery defective	Insufficient battery capacity or battery MCCB/fuse switched off	Call for assistance
39. System locked in operation mode	UPS has made 10 attempts within 1 minute to switch from bypass to battery operation, or “High DC warning” has appeared 10-20 times within 1 minute	Unlock. If message reappears - call for assistance
40. RAM1 memory write error	UPS fault	Call for assistance
41. Memory write error	UPS fault	Call for assistance
42. Communication to VQ bypass lost	UPS fault	Call for assistance
43. Communication to VQ output lost	UPS fault	Call for assistance
44. Communication to DMU lost	UPS fault	Call for assistance
45. Communication to controller lost	UPS fault. Display will show invalid UPS data	Call for assistance

Alarms	Description	Action
46. Communication to parallel IF lost	UPS fault	Call for assistance
47. External shutdown accepted	Remote signal for switching off UPS accepted. UPS switches off automatically	–
48. Communication to VQ mains lost	UPS fault	Call for assistance
49. Bypass synchronization error	The UPS cannot synchronize with bypass mains	Check if phase rotation of bypass voltage is correct – if OK, call for assistance
50. Battery charge error	Transferred to battery operation because of battery charge error	Check RFI input fuse and feedback relay

5.4 Rectifying Alarm Messages

Following actions may rectify alarm:

- Check local mains supply. Fuses may be blown or supply switched off accidentally
 - Check if UPS cooling air intake is blocked
 - Check if load exceeds maximum output capacity
 - If, with mains power switched on, there is no UPS output voltage - and an attempt to restart the UPS is in vain - use the external service bypass switch to bypass UPS
1. “Battery weak” message appears: Reset “battery weak” signal according to section 4.0 Parameter Settings and initiate battery capacity test according to Section 6.3. Battery Capacity Test. Make a record of obtained back-up time and use battery monitor to reset alarm. Leave the UPS to recharge battery for at least 16 hours. Start up second battery test without changing the load. If the test result shows improved back-up time, continue the test series until no or just insignificant improvements are obtainable. If battery is still weak - call for assistance.
 2. “Battery Defective” message appears: Call for assistance. See section 8.0 “How to contact APC”.

5.5 Parallel Operation Alarms

The parallel operation alarm message is: **Communication to parallel IF lost**

In the event of a parallel operation alarm, all parallel operation functions controlled by Advanced Power Management will be inactive. In such situations only simple hardware control such as load-sharing, operation mode etc. is possible.

Correction of false alarm situations during service:

When one system is isolated for service, the above alarm message will appear if two systems still operating. To delete this alarm message re-program the station addresses on all systems in the following sequence:

1 to max_number_system

Maintenance & Testing

6.0 Maintenance & Testing

UPS maintenance should be carried out by trained service engineers only. Service and maintenance contract is recommended.

6.1 Fan

It is recommended to replace fans every 3 years.

6.2 Battery Monitoring Test

Systems with built-in batteries have a standard battery monitoring feature (optional in other systems).

Battery Test Results:

1. Battery OK. Back-up time normal.
2. Reduced battery capacity - "Battery weak" message appears.
3. Battery capacity too low - "Battery defective" message appears.











Carry out battery monitoring test by discharging max. 25% of battery energy. For systems with no battery monitor/no excess back-up time, a battery capacity test is recommended every 6 months.

Carry out battery tests when load is least affected.

6.3 Battery Capacity Test

**CAUTION!**

Allow 16 hours to restore full back-up time after battery capacity tests.

Action	Display shows	Description
1. Press 		
2. Press  or  until	Battery capacity test : xxx	"xxx" is back-up time from last test – if no previous test has been performed or if the test has been aborted the display will read"???"! A battery monitor test can be performed in the same way by selecting "Battery monitor test" in the display. However, this test will not start, unless the battery is fully charged
3. Press 	Battery capacity test : ON	The next step starts up the test! To abort press 
4. Press 	Data stored	Starts the battery test. (To interrupt a running test – perform point 1-2 and then press key  and )
5. Wait about 1 sec.	Battery operation time : xxx min.	
6. Wait until backup times expires and a short alarm sounds. (No alarm in battery monitor test if battery is OK)	Normal operation load power xx%	
7. Press 	Battery capacity test : xxx	"xxx" is obtained back-up time in minutes. (Battery capacity test only)
8. Press 	Normal operation load power xx%	Exits the parameter stack If not operated the system will automatically exit after 30 seconds.



CAUTION!

To avoid battery damage, allow a minimum of 16 hours of UPS operation over a 3-month period for batteries to charge to a sufficient level.

If the UPS is to be taken out of operation for an extended period, disconnect the battery in order to prevent discharging. For details, refer to Installation Guide.

Warranty

7.0 Warranty

7.1 APC Silcon UPS Limited Factory Warranty

APC warrants that the unit, when properly installed and commissioned by APC or APC authorized service personnel, shall be free from defects in materials and workmanship for a period of (1) year from the date of installation or maximum 18 months after manufacturing. In the event that the unit fails to meet the foregoing warranty, APC shall for a period of one (1) year repair or replace any defective parts, without charge for on-site labor and travel if trained & authorized APC personnel has conducted start-up of the unit.

An APC Start-Up Service must be performed/completed by APC or APC authorized service personnel or the on-site factory warranty will be voided and replacement of defective parts only will be covered. APC shall have no liability and no obligation to repair the installed unit if non-authorized APC personnel performed the start-up and such start-up caused the unit to be defective.

APC SHALL NOT BE LIABLE UNDER THE WARRANTY IF ITS TESTING AND EXAMINATION DISCLOSE THAT THE ALLEGED DEFECT IN THE PRODUCT DOES NOT EXIST OR WAS CAUSED BY PURCHASER'S OR ANY THIRD PERSON'S MISUSE, NEGLIGENCE, IMPROPER INSTALLATION OR TESTING, UNAUTHORIZED ATTEMPTS TO REPAIR OR MODIFY, OR ANY OTHER CAUSE BEYOND THE RANGE OF THE INTENDED USE, OR BY ACCIDENT, FIRE, LIGHTNING OR OTHER HAZARD.

THERE ARE NO WARRANTIES, EXPRESSED OR IMPLIED, BY OPERATION OF LAW OR OTHERWISE, OF PRODUCTS SOLD, SERVICED OR FURNISHED UNDER THIS AGREEMENT OR IN CONNECTION HEREWITHIN. APC DISCLAIMS ALL IMPLIED WARRANTIES OF MERCHANTABILITY, SATISFACTION AND FITNESS FOR A PARTICULAR PURPOSE. APC'S EXPRESS WARRANTIES WILL NOT BE ENLARGED, DIMINISHED, OR AFFECTED BY AND NO OBLIGATION OR LIABILITY WILL ARISE OUT OF, APC'S RENDERING OF TECHNICAL OR OTHER ADVICE OR SERVICE IN CONNECTION WITH THE PRODUCTS. THE FOREGOING WARRANTIES AND REMEDIES ARE EXCLUSIVE AND IN LIEU OF ALL OTHER WARRANTIES AND REMEDIES. THE WARRANTIES SET FORTH ABOVE, CONSTITUTE APC'S SOLE LIABILITY AND PURCHASER'S EXCLUSIVE REMEDY FOR ANY BREACH OF SUCH WARRANTIES. APC'S WARRANTIES RUN ONLY TO PURCHASER AND ARE NOT EXTENDED TO ANY THIRD PARTIES.

IN NO EVENT SHALL APC, ITS OFFICERS, DIRECTORS, AFFILIATES OR EMPLOYEES BE LIABLE FOR ANY FORM OF INDIRECT, SPECIAL, CONSEQUENTIAL OR PUNITIVE DAMAGES, ARISING OUT OF THE USE, SERVICE OR INSTALLATION, OF THE PRODUCTS, WHETHER SUCH DAMAGES ARISE IN CONTRACT OR TORT, IRRESPECTIVE OF FAULT, NEGLIGENCE OR STRICT LIABILITY OR WHETHER APC HAS BEEN ADVISED IN ADVANCE OF THE POSSIBILITY OF SUCH DAMAGES.

8.0 How to Contact APC



APC Corporate
132 Fairgrounds Road
West Kingston, RI 02892
USA

Telephone: 401 789-5735
Fax: 401 789-3710

PowerFax™: 800 347-FAXX

Pre-sales Technical Support
877-474-5266 (1-877-4Silcon)

Post-sales Technical Support
877-287-7835 (1-877-2UPS-TEK)

E-mail: apcinfo@apc.com
Web: www.apc.com/support/contact/contact_support.cfm

APC Denmark
Silcon Allé
DK-6000 Kolding
Denmark

Telephone: + 45 75 54 22 55
Fax: + 45 72 19 03 50

Pre-sales Technical Support
+ 45 72 19 04 90

Post-sales Technical Support
+ 353 91 70 2000

APC Japan Inc.
BR Gotanda Building, 7F
2-30-4 Nishi-Gotanda, Shinagawa-ku
Tokyo 141-0031
Japan

Telephone: (03) 5434-2021
Fax: (03) 5434-2122

How to Contact APC

Free Manuals Download Website

<http://myh66.com>

<http://usermanuals.us>

<http://www.somanuals.com>

<http://www.4manuals.cc>

<http://www.manual-lib.com>

<http://www.404manual.com>

<http://www.luxmanual.com>

<http://aubethermostatmanual.com>

Golf course search by state

<http://golfingnear.com>

Email search by domain

<http://emailbydomain.com>

Auto manuals search

<http://auto.somanuals.com>

TV manuals search

<http://tv.somanuals.com>