

ASHLY

GQX-3102 GQX-3101 GQX-1502 Graphic Equalizer

Operating Manual

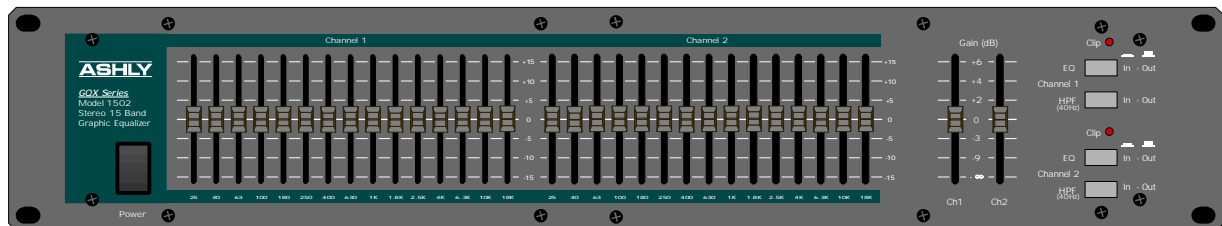
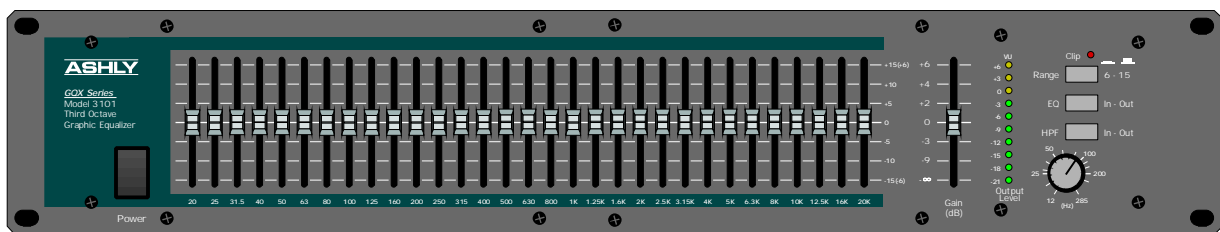
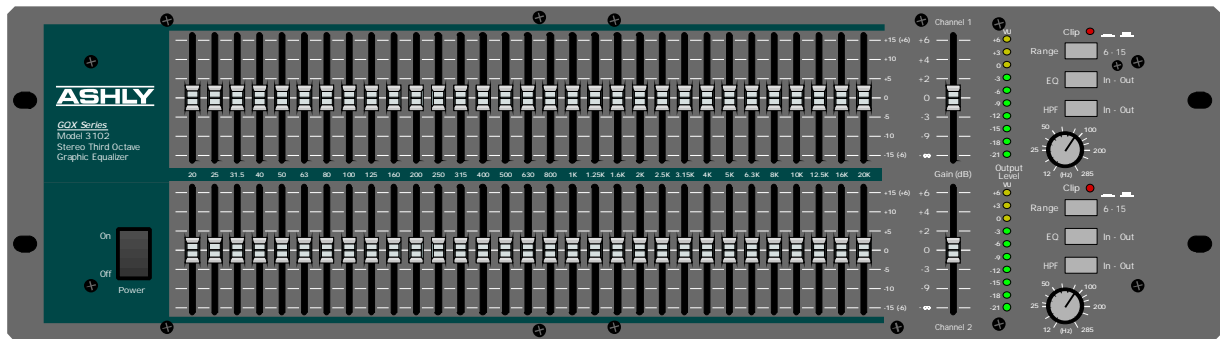

ASHLY AUDIO INC.

847 Holt Road Webster, NY 14580-9103 Phone: (716) 872-0010
Toll-Free: (800) 828-6308 Fax: (716) 872-0739 Internet: <http://www.ashly.com/>

Table Of Contents

1 INTRODUCTION	3
2 UNPACKING	3
3 AUDIO CONNECTORS AND CABLES	4
3.1 Inputs	4
3.2 Servo-Balanced Output	4
3.2 Grounding	5
4 AC POWER	5
5 CONTROLS	6
5.1 Gain	6
5.2 High-Pass Filter	6
5.3 Equalization	6
5.4 EQ Bypass Switch	6
5.5 Range Switch	6
5.6 Level Meters	6
6 TYPICAL APPLICATIONS	6
6.1 General Tone Control	6
6.2 Feedback Control	7
6.3 Console Channel Equalization	7
6.4 Large Room Equalization	7
7 DESIGN THEORY	8
8 TROUBLESHOOTING TIPS	10
9 DIMENSIONS	10
10 SPECIFICATIONS	11
11 WARRANTY INFORMATION	11
12 SCHEMATICS	12

1. INTRODUCTION

Congratulations on your purchase of an Ashly GQX series graphic equalizer. The GQX series equalizers are a second generation design including many refinements on our original GQ models. Lower noise and distortion, greater accuracy, and additional output options are the result. We continue using “Q” enhanced Wein bridge filters and interleaved summing for constant “Q”, low ripple, and minimum filter interaction. A servo-balanced output stage simulates a true transformer output to allow interfacing with virtually any type of load.

2. UNPACKING

As a part of our system of quality control, every Ashly product is carefully inspected before leaving the factory to ensure flawless appearance. After unpacking, please inspect for any physical damage. Save the shipping carton and all packing materials, as they were carefully designed to reduce to minimum the possibility of transportation damage should the unit again require packing and shipping. In the event that damage has occurred, immediately notify your dealer so that a written claim to cover the damages can be initiated.

The right to any claim against a public carrier can be forfeited if the carrier is not notified promptly and if the shipping carton and packing materials are not available for inspection by the carrier. Save all packing materials until the claim has been settled.

**- WARNING -
THIS APPARATUS MUST BE EARTHED**

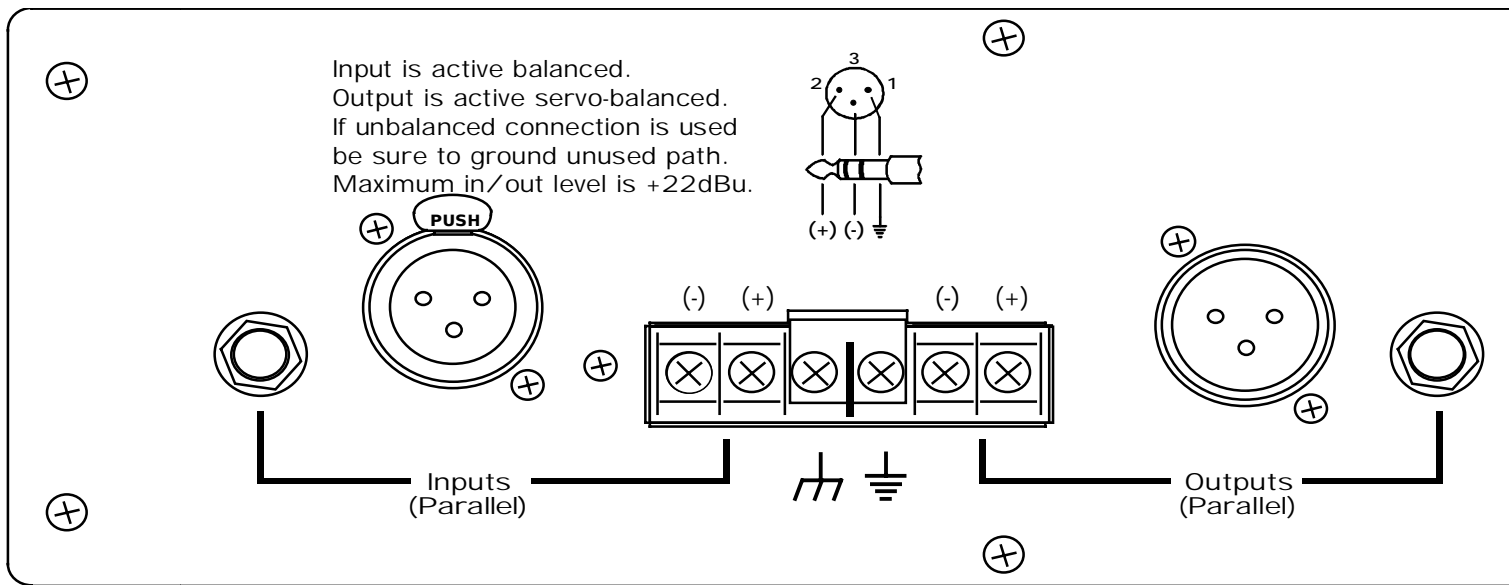

3. AUDIO CONNECTORS AND CABLES

Your GQX series equalizer is provided with three different connector types. 1/4 inch stereo phone jacks, three pin XLR type connectors, and a terminal strip will allow interfacing to most professional audio products. Inputs as well as servo-balanced outputs can be used balanced or unbalanced. When possible, we recommend balanced connections between all components in your system, as this eliminates ground-loop induced hum and noise.

3.1 Inputs

If inputs are used unbalanced, the signal should be on the (+) connection and the (-) connection must be tied to ground. A mono phone plug used as an unbalanced connection will automatically ground the ring of the jack which is the (-) connection. When using a stereo plug,

XLR connector, or terminal strip for an unbalanced signal, the (-) input connection **MUST** be tied to ground, or loss of signal level may result.

3.2 Servo-Balanced Output

The Ashly servo-balanced output circuit is an active balanced output. This circuit maintains a constant output level (or difference voltage) between the (+) and (-) output terminals, regardless of either terminal being connected to ground as in an unbalanced output connection.

This servo-balanced output has an advantage over conventional active balanced outputs in that the signal level is unchanged when either the (+) or the (-) output terminals are connected to ground. A conventional active balanced output would suffer a signal loss of 1/2 the output voltage (or -6dB) if one of the output terminals were grounded in an unbalanced connection.

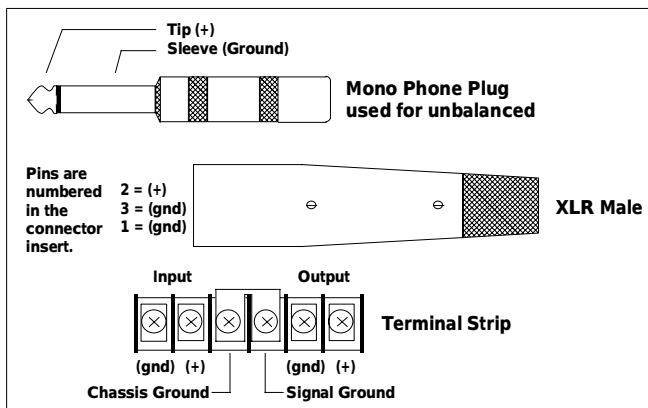

Unbalanced Audio Connectors

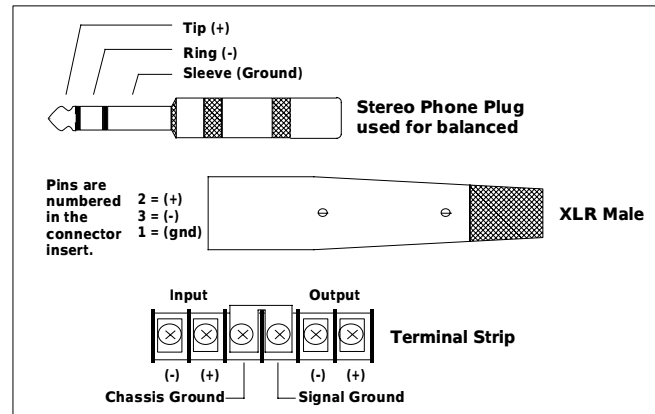

Balanced Audio Connectors

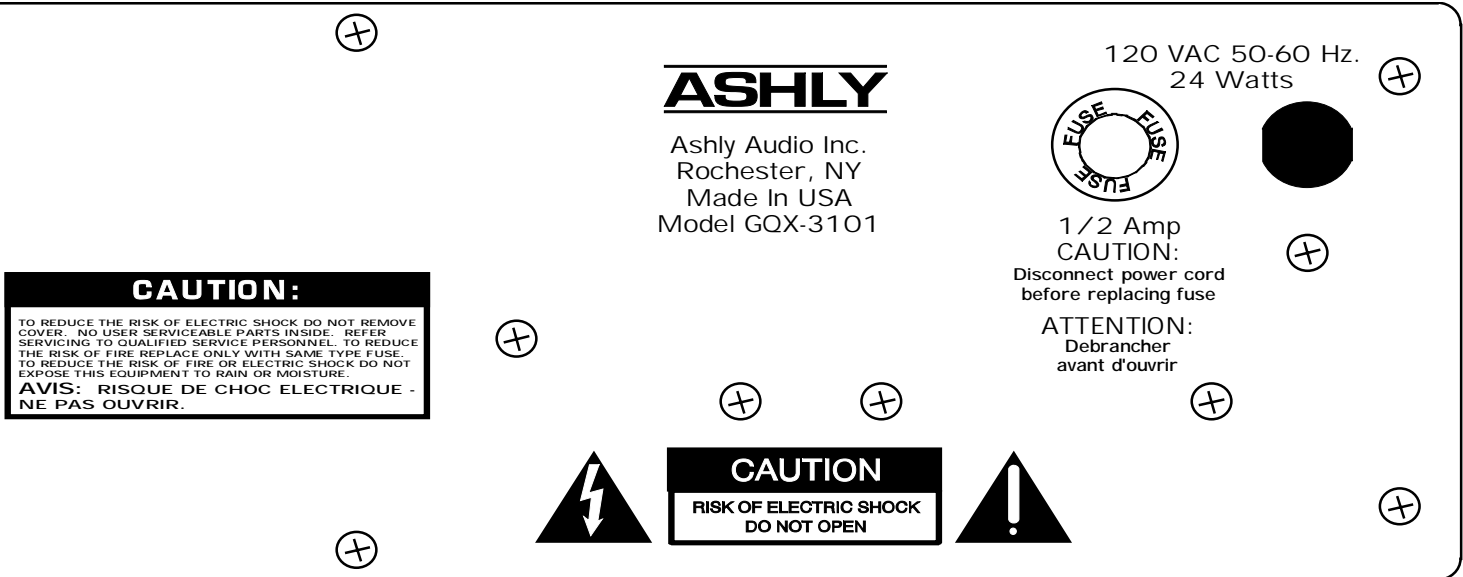

Furthermore, if common-mode voltage (such as 60Hz noise voltage) gets induced on the output signal lines, the resulting 60Hz noise current into the servo-balanced circuit would be insignificant because the common-mode output impedance is high. A conventional active balanced output would cause significant noise current resulting in more noise.

Essentially, the servo-balanced output circuit behaves like a transformer balanced output because it maintains a constant level into balanced and unbalanced lines with a low differential impedance and a high common-mode impedance. The servo-balanced output also does not suffer from problems associated with output transformers such as low-frequency distortion, susceptibility to magnetic fields and poor frequency response.

3.3 Grounding

The terminal strip has two ground connections, one for input ground and one for chassis ground. The equalizer is shipped with a jumper strap connecting these two grounds. Normally, this strap should be left in place so the chassis and input grounds are connected. In a rack-mount installation where the equalizer is connected to other equipment with unbalanced inputs or outputs and the rack itself provides a good electrical connection between the

equalizer chassis and the other equipment, it may be desirable to remove this strap to isolate the input ground from chassis ground and avoid a ground loop.

Unless you have such an installation and have a hum problem you can't solve by other means (ie: using balanced input and output connections), leave the ground jumper strap in place.

4. AC POWER

Your GQX equalizer should be connected to a standard 3-wire grounded electrical outlet supplying 120 Volts, 50-60 Hz (some export models are wired for 240 Volts, and are labeled as such). To reduce the risk of ground loop hum, connect all audio equipment to the same electrical power source. *Removal of the ground pin is both unlawful and dangerous, as a potential shock hazard could result.*

This unit will perform normally within an AC voltage range of 93 to 130 volts. Voltages less than this, as found in "brown-out" conditions, will reduce headroom and decrease power supply regulation. While this may affect performance, the equalizer will continue to function during a brown-out. In the event of a blown fuse, replace only with same type fuse. No user serviceable parts are inside the chassis. Overall power consumption is less than 25 watts.

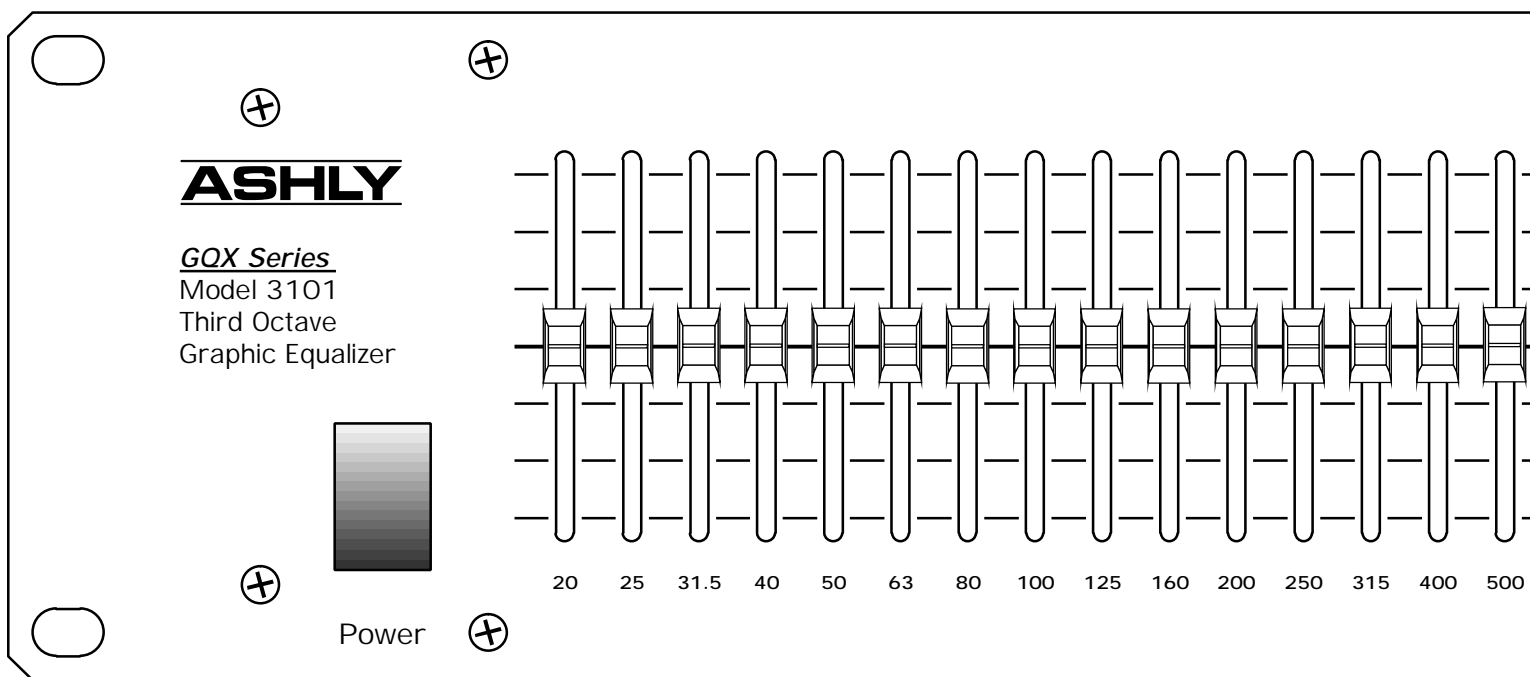

5. CONTROLS

5.1 Gain

The gain control adjusts the overall gain of the equalizer when the EQ switch is “in”. It is generally used to compensate for level changes due to the equalization process, but can also allow the equalizer to adjust overall system level and gain structure. Overall gain with this control is from +6dB to $-\infty$.

5.2 High-Pass Filter

The high-pass filter can be used to supplement the frequency response achieved by the bandpass filters. It’s function is to “roll off” the response below a given frequency to eliminate subsonic interference like wind noise, floor rumble, and microphone “pops”. The rolloff frequency is adjustable between 14Hz and 280Hz on the 31-band models, and is fixed at 40Hz on the 15-band model.

5.3 Equalization

The individual equalization faders adjust the gain or loss at each filter frequency. There are 31 of these faders per channel on the GQX-3101 and GQX-3102 third octave models, and 15 faders per channel on the GQX-1502 two-thirds octave model. By adjusting a combination of faders, an overall frequency response can be developed and the physical position of the faders will give an approximate visual indication of this response.

5.4 EQ Bypass Switch

This switches the Graphic Equalization and gain adjustments. This way, the effect of any equalization can be compared to a “flat” response. This switch does not defeat the High-pass filter.

5.5 Range Switch

This switch selects the operating range of the individual equalization faders between 15dB and 6dB on the two 31 band models. The 15dB settings should be used when this much equalization is needed. The 6dB setting allows finer resolution on the fader settings.

5.6 Level Meters

On the GQX-3101 and GQX-3102 31 band models, a 10-segment, two color LED level meter indicates the output level of the equalizer. A Clip indicator LED on all models illuminates when any point in the equalizer signal path reaches a level within 3dB of clipping.

6. TYPICAL APPLICATIONS

6.1 General Tone Control

The graphic equalizer is a very useful device for general tone shaping because it is intuitive and easy to adjust. The visual reference provided by the slider position gives an approximate idea of the frequency response generated, with the lower frequencies on the left and higher frequencies on the right. To use the power of an equalizer effectively, you need to translate your idea of the tone you want to produce into a range of numerical frequencies. This is simple after a little practise. Here are a few references which are useful for starting points:

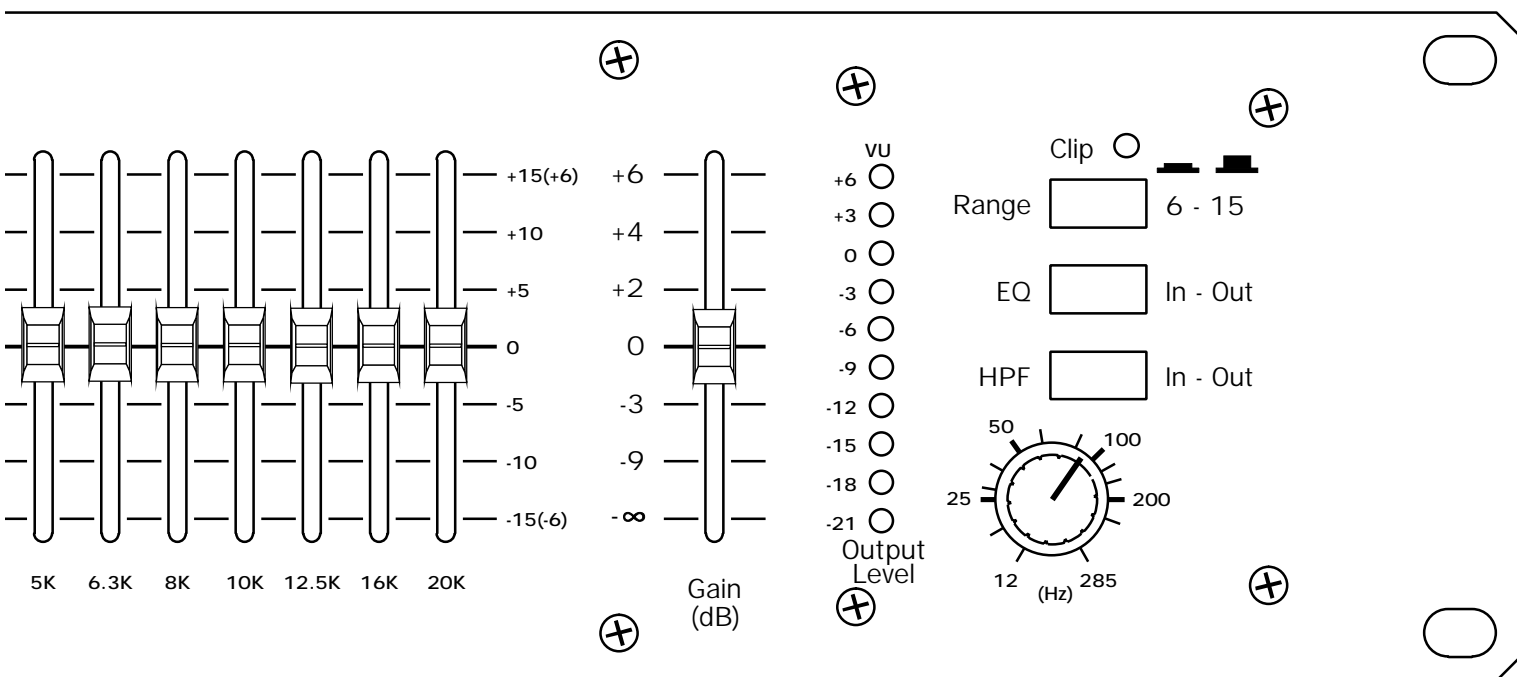

Very low bass (the “wind” in a kick drum, almost felt as much as heard -40Hz-80Hz.

The low register of a male voice - 200Hz

The low register of a female voice - 350Hz

Lower midrange (“warmth” frequencies) - 400Hz-1KHz

Upper midrange (“harshness”, snare drum “bite”, “hot” sound) -2.5KHz-4KHz.

Sibilance (“sss” sounds, cymbal “sizzle”) - 8KHz-15KHz.

Try using these starting points as a guide when you want more or less of these types of sounds. Adjust by ear from there. It is always a good idea to remember that a little equalization usually works out much better than a lot, and that there are many audio problems which can not be solved with equalization alone.

6.2 Feedback Control

A graphic equalizer can be used to provide some control over moderate feedback problems, but does not have enough flexibility or resolution to handle severe situations. You will achieve the best results when you can eliminate one or two feedback points by setting one or two sliders for no more than a 6dB cut. Often you can find a feedback point by boosting sliders in succession to determine which frequency ranges contain the feedback modes, and then cutting those ranges. Be very careful in

this process to avoid explosive feedback and possible system and hearing damage! If you find feedback points with many equalizer bands, remember that cutting every band may not help (all you will do is reduce system gain). The combination of a graphic equalizer for tone control and a parametric equalizer (such as the Ashly PQX-571 or PQX-572) for feedback control is highly recommended.

6.3 Console Channel Equalization

Many mixing consoles provide only simple equalization for individual channels. If your console has channel inserts, you can patch your graphic equalizer into a channel that’s being used for something important (like your lead singer) and use it to tailor the sound of this channel exactly the way you want.

6.4 Large Room Equalization

Large rooms tend to suffer from multiple reflections with long time delays, long reverberation times, and “ring-modes”, all of which lead to reduced intelligibility and a generally “muddy” sound. As sound travels long distances through the air, high frequencies are attenuated more than low frequencies. In general, large rooms benefit from some low frequency roll-off, high frequency boost, and attenuation of ring mode frequencies. As in the case of feedback control, a graphic equalizer can help reduce an isolated ring-mode or two, but a tunable narrow-band equalizer such as a parametric is more effective here.

7. DESIGN THEORY

While most graphic equalizers look very much the same, there are several important differences in the circuitry used to implement various designs.

Perhaps the major differences are in the filters. Some equalizers use a filter made of a capacitor, an inductor, and a resistor, or “RLC” filter. The advantage here is simplicity, but the real disadvantage is the inductor itself. An inductor is a coil of wire with a core of some sort. Inductors are susceptible to hum fields and they are large and expensive.

Other equalizers use the same basic approach, but replace the inductor with a “simulated inductor”, which is actually a circuit comprised of an amplifier, a capacitor, and a couple of resistors. This adds parts but is less expensive than a real inductor. The problem with this approach is that simulation is less than ideal; it produces an inductor with high resistive loss resulting in poor curve shape when used in a filter.

Another problem with all these “RLC” designs is that large capacitors must be used for the lower frequency filters, limiting the choice to large, expensive non-polar types or electrolytic capacitors with poor audio performance. Also, when this filter type is combined with a potentiometer to adjust the equalization, the resistance of this pot affects the “Q” of the filter so that a little equalization produces a much broader curve than a lot of equalization.

The other filter approach is a true bandpass filter. This can be made with no inductors and more practical sized capacitors; the “Q” is easily set and remains constant, and the parts count is reasonable. there are several types of bandpass filters suitable for this job. Ashly uses a “Q” enhanced Wein-bridge filter. Because it is a “symmetrical” design using matched tuning components, the “Q” is easily set and is very stable.

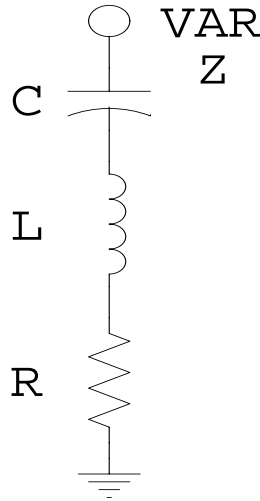

Figure 7.1: Passive RLC Filter Design

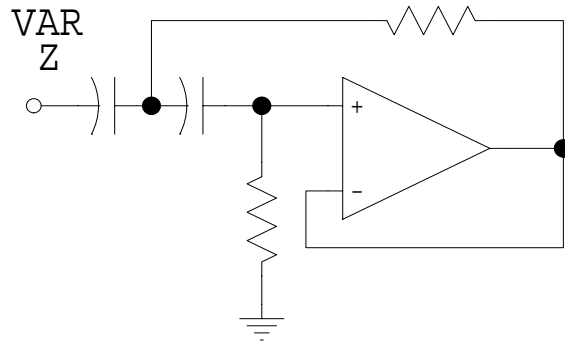

Figure 7.2: Simulated Inductor Filter Design

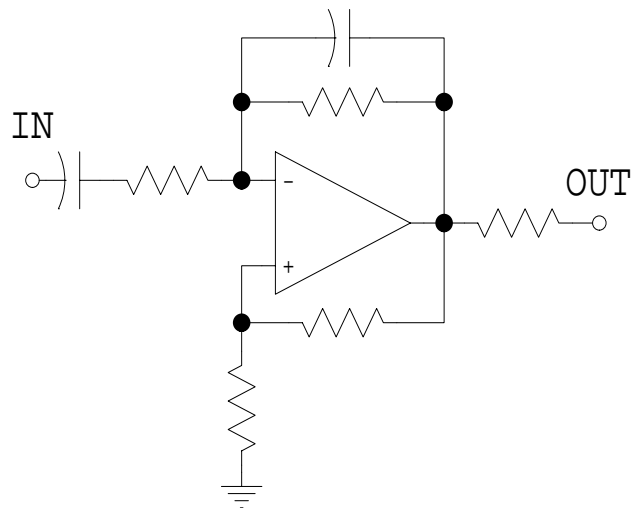
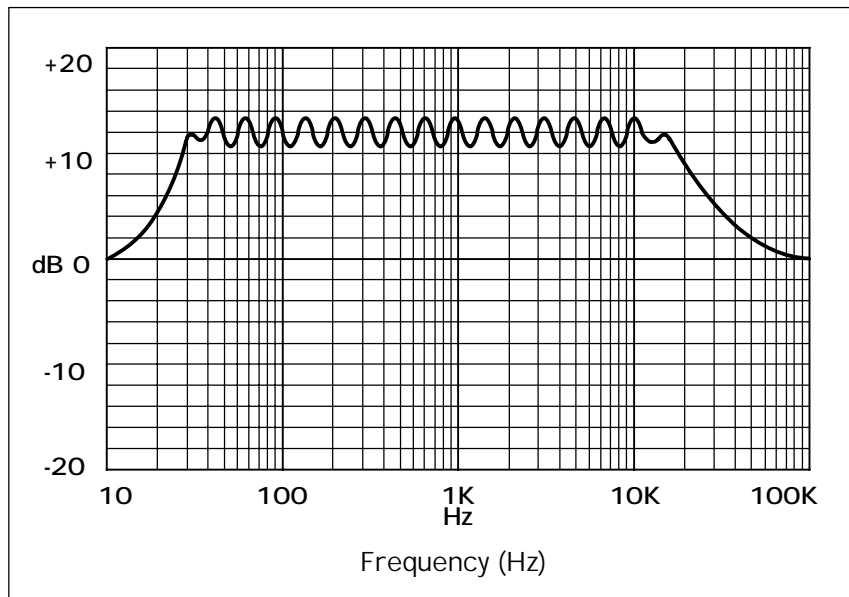

Figure 7.3: Wein-Bridge Filter Design

In designing a graphic equalizer, a selection of filter sharpness must be made. More sharpness (higher Q) produces less filter overlap and tighter control over an individual band, but also causes "ripple" in the frequency response when many filters are boost or cut together to produce a flat response. We feel that the graphic equalizer's primary use is for "voicing" and tone control, and have set our filter sharpness to produce a maximum of 1dB ripple.

The summing system in a graphic equalizer is also important. Since there are a number of filters which combine to produce the overall response, it is important that the filters not interact (they WILL overlap, but the response of one filter should not modify the response of another). Ashly uses an "interleaved" summing system where every other filter uses the same summing amplifier so that adjacent filters never share the same drive and feedback signals. This allows the filters to maintain their natural response.



On most graphic equalizers, frequency response ripple is produced by overly sharp filters. (15-band equalizer, all bands boosted 15dB)

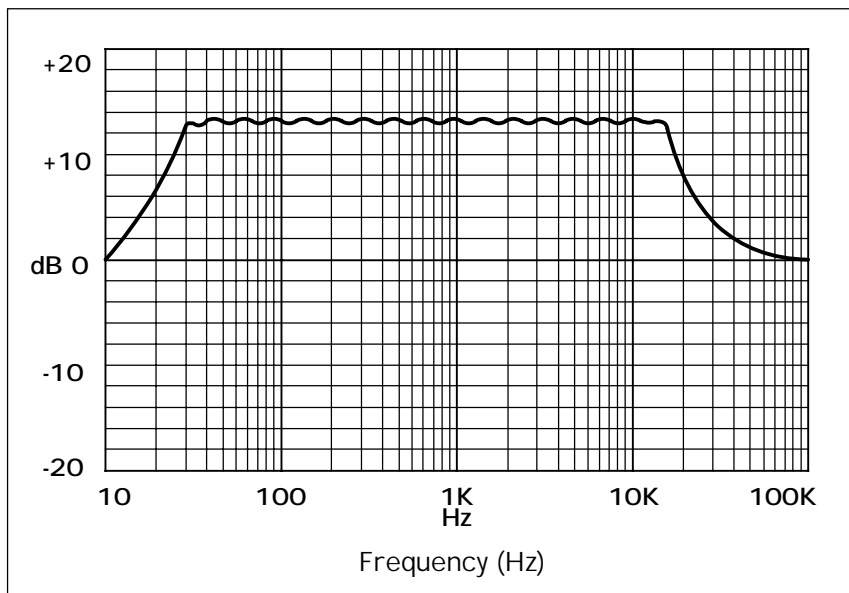

Ashly's GQX graphic equalizers use slightly broader filters producing less ripple.

8. TROUBLESHOOTING TIPS

8.1 No Audio Output

Check AC power - is the pilot light on?
 Check in/out connections - are they reversed?
 Are you sure you have an input signal?

8.2 EQ Controls Do Nothing

Is the master EQ switch in?
 The lowest and highest frequency sliders may be beyond the range of the program material or speakers and may produce little or no audible effect.

8.3 Peak Light Flashes or Stays On All the Time

If the peak light flashes, the signal level to the equalizer is too high. Turn down the gain. If it is on all the time, disconnect the input and output cables. If it is still on, the unit must be returned for service.

8.4 Distorted Sound

This will only be caused by too much signal which will show on the Clip LED. If the LED is not flashing, there is an overload somewhere else in the signal path. Adjust the relative gain of each component in your chain to keep everything at a comfortable level.

8.5 Excessive Hum or Noise

Hum will usually be caused by a ground loop between components. Try using the suggested balanced input and output hook-ups if the other pieces of equipment used in conjunction with your equalizer have balanced inputs and outputs.

Noise (excessive hiss) can be caused by insufficient drive signal. Make sure you are sending a nominal 0 dBu line level signal to the equalizer. Most noise problems occur because gain is applied to audio signals too late in the chain. For best performance, apply gain to individual source signals as early as possible, like at the mixer input section. As gain increases, it also boosts the noise content of that signal. Any cumulative noise built up in a mixed signal will only be increased by using an equalizer as a gain device, so make every attempt to operate the equalizer with as little gain as possible.

Note: Unshielded cables, improperly wired connections, and cable with broken strands (shorts, etc.) are the most common problems. Make sure you use good quality cable with connectors soldered firmly on the correct pin. When in doubt, get in touch with your Ashly dealer, or call the Ashly service department at 800-828-6308.

9. DIMENSIONS

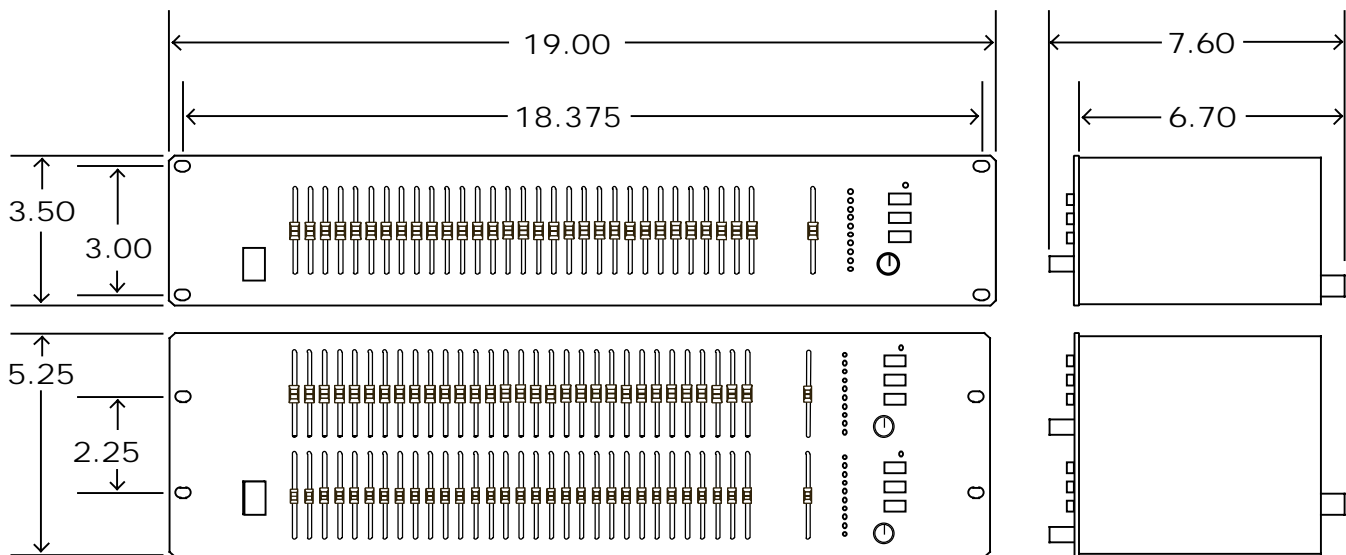

10. SPECIFICATIONS

Model **GQX1502** **GQX3101/3102**

Input

Type Active Balanced..... Active Balanced
 Impedance..... 20KΩ 20KΩ
 Max. Level +23dBu +23dBu
 Connectors 1/4" Phone Jack, XLR & Barrier Strip

Output

Type Servo-Balanced Servo-Balanced
 Source Impedance 200Ω 200Ω
 Min. Load Impedance 600Ω 600Ω
 Max Level..... +23dBu +23dBu
 Connectors 1/4" Phone Jack, XLR & Barrier Strip

Overall

Frequency Response..... ±.25dB ±.25dB
 Total Harmonic Distortion <.01% @+20dBu <.01% @+20dBu
 IM Distortion (SMPTE)..... <.01% @+20dBu <.01% @+20dBu
 Output Hum and Noise (unweighted) -96dBu..... <-92dBu
 Channel Separation >85dB @ 1KHz >95dB @ 1KHz
 Gain Control -∞ to +6dB -∞ to +6dB
 (EQ in, all faders flat, 20Hz-20KHz unless otherwise noted)

Filters

Type Constant Q/Wein Bridge
 Number 2×15 1×31 / 2×31
 Bandwidth 2/3 octave 1/3 octave
 Tolerance..... ±3% ±3%
 Range ±15dB ±6 or ±15 dB
 Subsonic Filter 18dB/octave @40Hz 12dB/oct.14-280Hz

Power Requirements

Nominal Voltage..... 120VAC, 50-60Hz (240VAC available)
 Minimal Voltage..... 93VAC
 Power 24W 24W

Shipping Weight 10lbs 10lbs/15lbs

Dimensions 19"Lx3.5"(5.25)"Hx6"D

11.WARRANTY INFORMATION

Thank you for your expression of confidence in Ashly products. The unit you have just purchased is protected by a five-year warranty. To establish the warranty, be sure to fill out and mail the warranty card attached to your product. Fill out the information below for your records.

Model Number _____ **Serial Number** _____
Dealer _____ **Date of Purchase** _____
Dealer's Address _____
Dealer's Phone _____ **Salesperson** _____

12. SCHEMATICS

Figure 12.2: GQX 1502 Block Diagram

Figure 12.2: GQX 1502 Schematic Diagram

Figure 12.1: GQX 3102, GQX 3101 Block Diagram

Figure 12.1: GQX 3102, GQX 3101 Schematic Diagram

ASHLY

ASHLY AUDIO INC. 847 Holt Road Webster, NY 14580-9103

Phone: (716) 872-0010 Fax: (716) 872-0739

Toll Free (800) 828-6308 Internet: <http://www.ashly.com/>

© 1997 by Ashly Audio Corporation. All rights reserved worldwide.

Free Manuals Download Website

<http://myh66.com>

<http://usermanuals.us>

<http://www.somanuals.com>

<http://www.4manuals.cc>

<http://www.manual-lib.com>

<http://www.404manual.com>

<http://www.luxmanual.com>

<http://aubethermostatmanual.com>

Golf course search by state

<http://golfingnear.com>

Email search by domain

<http://emailbydomain.com>

Auto manuals search

<http://auto.somanuals.com>

TV manuals search

<http://tv.somanuals.com>