



A7N8X-X

User Guide

Motherboard

E1461

Revised Edition V2

October 2003

Copyright © 2003 ASUSTeK COMPUTER INC. All Rights Reserved.

No part of this manual, including the products and software described in it, may be reproduced, transmitted, transcribed, stored in a retrieval system, or translated into any language in any form or by any means, except documentation kept by the purchaser for backup purposes, without the express written permission of ASUSTeK COMPUTER INC. ("ASUS").

Product warranty or service will not be extended if: (1) the product is repaired, modified or altered, unless such repair, modification or alteration is authorized in writing by ASUS; or (2) the serial number of the product is defaced or missing.

ASUS PROVIDES THIS MANUAL "AS IS" WITHOUT WARRANTY OF ANY KIND, EITHER EXPRESS OR IMPLIED, INCLUDING BUT NOT LIMITED TO THE IMPLIED WARRANTIES OR CONDITIONS OF MERCHANTABILITY OR FITNESS FOR A PARTICULAR PURPOSE. IN NO EVENT SHALL ASUS, ITS DIRECTORS, OFFICERS, EMPLOYEES OR AGENTS BE LIABLE FOR ANY INDIRECT, SPECIAL, INCIDENTAL, OR CONSEQUENTIAL DAMAGES (INCLUDING DAMAGES FOR LOSS OF PROFITS, LOSS OF BUSINESS, LOSS OF USE OR DATA, INTERRUPTION OF BUSINESS AND THE LIKE), EVEN IF ASUS HAS BEEN ADVISED OF THE POSSIBILITY OF SUCH DAMAGES ARISING FROM ANY DEFECT OR ERROR IN THIS MANUAL OR PRODUCT.

SPECIFICATIONS AND INFORMATION CONTAINED IN THIS MANUAL ARE FURNISHED FOR INFORMATIONAL USE ONLY, AND ARE SUBJECT TO CHANGE AT ANY TIME WITHOUT NOTICE, AND SHOULD NOT BE CONSTRUED AS A COMMITMENT BY ASUS. ASUS ASSUMES NO RESPONSIBILITY OR LIABILITY FOR ANY ERRORS OR INACCURACIES THAT MAY APPEAR IN THIS MANUAL, INCLUDING THE PRODUCTS AND SOFTWARE DESCRIBED IN IT.

Products and corporate names appearing in this manual may or may not be registered trademarks or copyrights of their respective companies, and are used only for identification or explanation and to the owners' benefit, without intent to infringe.

Contents

Notices	v
Safety information	vi
ASUS contact information	viii
A7N8X-X specifications summary	ix

Chapter 1: Motherboard Info

1.1 Welcome!	1-2
1.2 Package contents	1-2
1.3 Motherboard components	1-3
1.4 Motherboard layout	1-6
1.5 Before you proceed	1-7
1.6 Central Processing Unit (CPU)	1-7
1.7 System memory	1-8
1.7.1 Installing a DIMM	1-8
1.8 Expansion slots	1-8
1.8.1 Configuring an expansion card	1-8
1.8.2 Standard Interrupt Assignments	1-9
1.8.3 AGP slot	1-9
1.9 Jumpers	1-10
1.10 Connectors	1-12

Chapter 2: BIOS Information

2.1 Managing and updating your BIOS	2-2
2.1.1 Using the computer system for the first time	2-2
2.1.2 Updating BIOS procedures	2-3
2.2 BIOS Setup program	2-6
2.2.1 BIOS menu bar	2-7
2.2.2 Legend bar	2-7
2.3 Main Menu	2-9
2.3.1 Primary Master/Slave	2-10
2.3.2 Secondary Master/Slave	2-12
2.4 Advanced Menu	2-13
2.4.1 Advanced BIOS Features	2-14
2.4.2 Advanced Chipset Features	2-15

Contents

2.4.3	Integrated Peripherals	2-18
2.4.4	Power Management Setup	2-20
2.4.5	PnP / PCI Configurations	2-22
2.5	Security Menu	2-23
2.6	Hardware Monitor Menu	2-24
2.7	Exit Menu	2-26

Chapter 3: Starting Up

3.1	Install an operating system	3-2
3.2	Support CD information	3-2
3.2.1	Running the support CD	3-2
3.2.2	Drivers menu	3-3
3.2.3	Utilities menu	3-3
3.2.4	ASUS Contact Information	3-4

Notices

Federal Communications Commission Statement

This device complies with Part 15 of the FCC Rules. Operation is subject to the following two conditions:

- This device may not cause harmful interference, and
- This device must accept any interference received including interference that may cause undesired operation.

This equipment has been tested and found to comply with the limits for a Class B digital device, pursuant to Part 15 of the FCC Rules. These limits are designed to provide reasonable protection against harmful interference in a residential installation. This equipment generates, uses and can radiate radio frequency energy and, if not installed and used in accordance with manufacturer's instructions, may cause harmful interference to radio communications. However, there is no guarantee that interference will not occur in a particular installation. If this equipment does cause harmful interference to radio or television reception, which can be determined by turning the equipment off and on, the user is encouraged to try to correct the interference by one or more of the following measures:

- Reorient or relocate the receiving antenna.
- Increase the separation between the equipment and receiver.
- Connect the equipment to an outlet on a circuit different from that to which the receiver is connected.
- Consult the dealer or an experienced radio/TV technician for help.



The use of shielded cables for connection of the monitor to the graphics card is required to assure compliance with FCC regulations. Changes or modifications to this unit not expressly approved by the party responsible for compliance could void the user's authority to operate this equipment.

Canadian Department of Communications Statement

This digital apparatus does not exceed the Class B limits for radio noise emissions from digital apparatus set out in the Radio Interference Regulations of the Canadian Department of Communications.

This class B digital apparatus complies with Canadian ICES-003.

Safety information

Electrical safety

- To prevent electrical shock hazard, disconnect the power cable from the electrical outlet before relocating the system.
- When adding or removing devices to or from the system, ensure that the power cables for the devices are unplugged before the signal cables are connected. If possible, disconnect all power cables from the existing system before you add a device.
- Before connecting or removing signal cables from the motherboard, ensure that all power cables are unplugged.
- Seek professional assistance before using an adapter or extension cord. These devices could interrupt the grounding circuit.
- Make sure that your power supply is set to the correct voltage in your area. If you are not sure about the voltage of the electrical outlet you are using, contact your local power company.
- If the power supply is broken, do not try to fix it by yourself. Contact a qualified service technician or your retailer.

Operation safety

- Before installing the motherboard and adding devices on it, carefully read all the manuals that came with the package.
- Before using the product, make sure all cables are correctly connected and the power cables are not damaged. If you detect any damage, contact your dealer immediately.
- To avoid short circuits, keep paper clips, screws, and staples away from connectors, slots, sockets and circuitry.
- Avoid dust, humidity, and temperature extremes. Do not place the product in any area where it may become wet.
- Place the product on a stable surface.
- If you encounter technical problems with the product, contact a qualified service technician or your retailer.

Conventions used in this guide

To make sure that you perform certain tasks properly, take note of the following symbols used throughout this manual.



WARNING/DANGER: Information to prevent injury to yourself when trying to complete a task.



CAUTION: Information to prevent damage to the components when trying to complete a task.

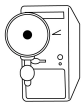

IMPORTANT: Information that you **MUST** follow to complete a task.



NOTE: Tips and additional information to aid in completing a task.

Where to find more information

Refer to the following sources for additional information and for product and software updates.

1. ASUS Websites

The ASUS websites worldwide provide updated information on ASUS hardware and software products. The ASUS websites are listed in the ASUS Contact Information on page viii.

2. Optional Documentation

Your product package may include optional documentation, such as warranty flyers, that may have been added by your dealer. These documents are not part of the standard package.

ASUS contact information

ASUSTeK COMPUTER INC. (Asia-Pacific)

Address: 150 Li-Te Road, Peitou, Taipei, Taiwan 112
General Tel: +886-2-2894-3447
General Fax: +886-2-2894-3449
Web Site: www.asus.com.tw

Technical Support

MB/Others (Tel): +886-2-2890-7121 (English)
Notebook (Tel): +886-2-2890-7122 (English)
Desktop/Server (Tel): +886-2-2890-7123 (English)
Support Fax: +886-2-2890-7698

ASUS COMPUTER INTERNATIONAL (America)

Address: 44370 Nobel Drive, Fremont, CA 94538, USA
General Fax: +1-502-933-8713
General Email: tmd1@asus.com
Web Site: usa.asus.com

Technical Support

Support Fax: +1-502-933-8713
General Support: +1-502-995-0883
Notebook Support: +1-510-739-3777 x5110
Support Email: tsd@asus.com

ASUS COMPUTER GmbH (Germany and Austria)

Address: Harkortstr. 25, 40880 Ratingen, BRD, Germany
General Email: sales@asuscom.de (for marketing requests only)
General Fax: +49-2102-9599-31
Web Site: www.asuscom.de

Technical Support

Components: +49-2102-9599-0
Notebook PC: +49-2102-9599-10
Support Fax: +49-2102-9599-11
Support Email: www.asuscom.de/support (for online support)

ASUSTeK COMPUTER (Middle East and North Africa)

Address: P.O. Box 64133, Dubai, U.A.E.
General Tel: +9714-283-1774
General Fax: +9714-283-1775
Web Site: www.ASUSarabia.com

A7N8X-X specifications summary

CPU	Socket A for AMD Duron™/Athlon™/Athlon™ XP 3200+ or higher 400/333 MHz FSB Support
Chipset	Northbridge: NVIDIA® nForce2 400 Southbridge: NVIDIA® nForce2 MCP
Front Side Bus (FSB)	400/333/266/200Mhz
Memory	3 x 184-pin DDR DIMM Sockets Max. 3 GB unbuffered PC3200/2700/2100/1600 non-ECC DDR RAM memory. (Visit ASUS website for latest qualified DDR400 module list.)
Expansion slots	5 x PCI 1 x AGP 8X (1.5V only)
IDE	2 x UltraDMA 133/100/66/33
Audio	Realtek ALC650 6CH with built-in HP amplifier
LAN	1 Port MCP integrated NVIDIA MAC + Realtek 8201BL PHY
Special Features	ASUS Q-Fan Technology ASUS C.O.P. (CPU Overheating Protection) Power Loss Restart CPU Throttle Support S/PDIF in/out (optional)
Back Panel I/O Ports	1 x Parallel 1 x Serial 1 x PS/2 Keyboard 1 x PS/2 Mouse 1 x RJ45 port 1 x Audio I/O 4 x USB 2.0
Internal I/O Connectors	1 x USB 2.0 connector supports additional 2 USB 2.0 ports (optional) Game connector (optional) CPU/Power/Chassis FAN connectors 20-pin ATX Power connector IDE LED connector, Power LED connector Chassis Intrusion, SIR Headphone (optional) Front MIC (optional) CD / AUX / Modem audio in Front Panel Audio connector (optional)

(continued on the next page)

A7N8X-X specifications summary

BIOS features	2Mb Flash ROM, Award BIOS, TCAV, PnP, DMI2.0, DMI, Green
Industry standard	PCI 2.2, USB 1.1/2.0.
Manageability	DMI 2.0, WOL, WOR, Chassis Intrusion, SM Bus
Support CD contents	Device drivers ASUS PC Probe Trend Micro™ PC-cillin 2002 anti-virus software ASUS LiveUpdate Utility
Accessories	User's manual Support CD 1 x UltraDMA 133/100/66 cable FDD cable 9-pin COM cable (optional) 2-port USB/Game port bracket (<i>optional</i>) I/O shield
Form Factor	ATX form factor: 12 in x 9.6 in

* Specifications are subject to change without notice.

Chapter 1

This chapter gives information about the ASUS A7N8X-X motherboard that came with the system. This chapter includes the motherboard layout, jumper settings, and connector locations.

Motherboard Info

1.1 Welcome!

Thank you for buying the ASUS® A7N8X-X motherboard!

The ASUS A7N8X-X motherboard is loaded with the most advanced technologies to deliver the maximum performance for socket A processors. This motherboard is loaded with value-added features for guaranteed consumer satisfaction. Unique ASUS features such as ASUS C.O.P., ASUS Q-Fan Technology and more are included to ensure the best user experience and value in a motherboard. For future upgrades or system reconfiguration, this chapter provides technical information about the motherboard.

Before you start installing the motherboard and hardware devices on it, check the items in your package with the list below.

1.2 Package contents

Check your ASUS A7N8X-X package for the following items.

- ✓ ASUS A7N8X-X motherboard
ATX form factor: 12 in x 9.6 in
- ✓ ASUS A7N8X-X series support CD
- ✓ 40-pin 80-conductor ribbon cable for UltraDMA/66/100/133 IDE drives
- ✓ Ribbon cable for a 3.5-inch floppy drive
- ✓ Bag of extra jumper caps
- ✓ I/O shield
- ✓ User's Manual

1.3 Motherboard components

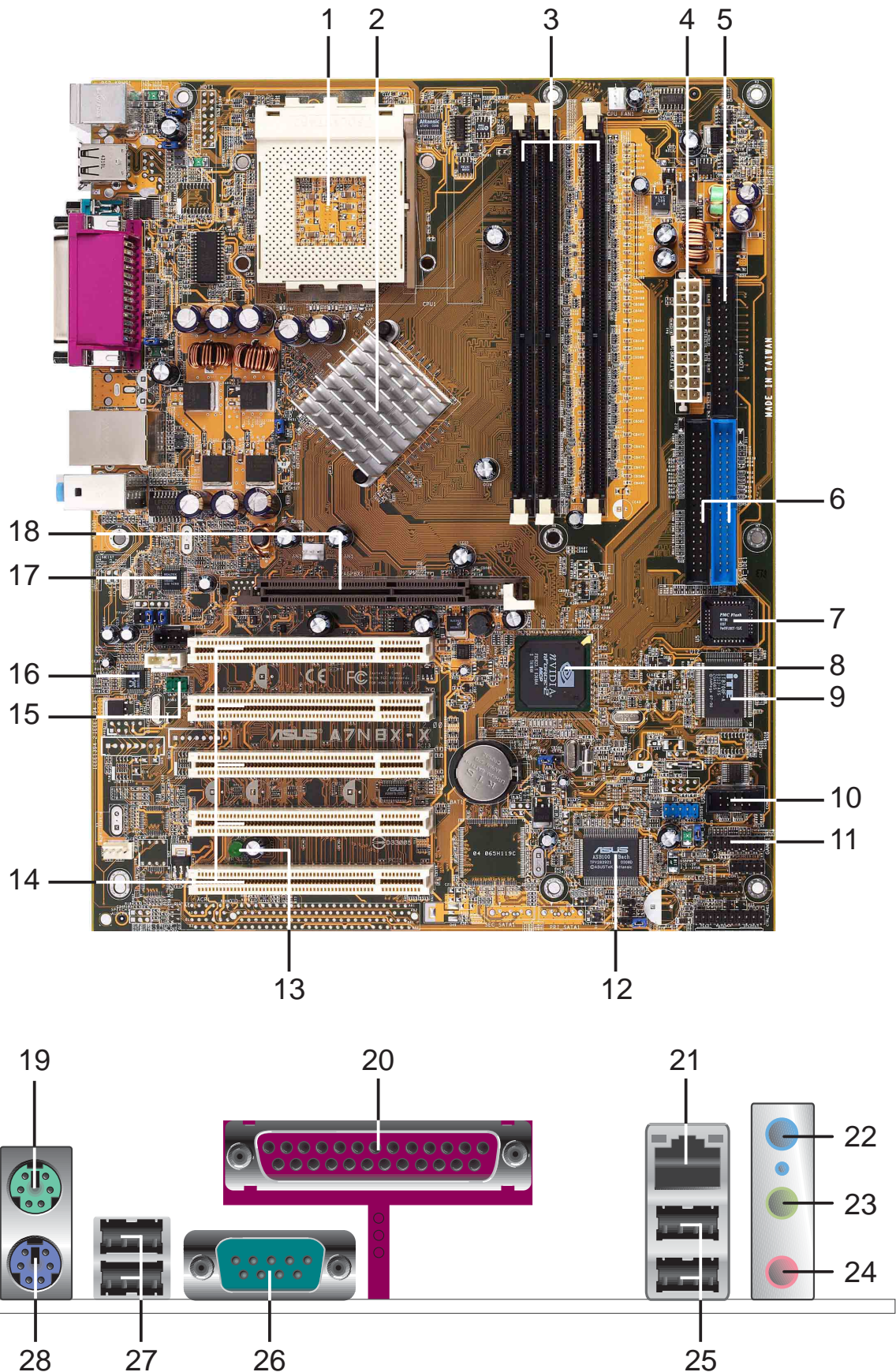

- 1 CPU Sockets.** Socket 462 (Socket A) Zero Insertion Force (ZIF) socket for the AMD Duron™/Athlon™/Athlon XP™ 3000+ processors.
- 2 NorthBridge Controller.** The NVIDIA® nForce2™ 400 North Bridge controller chipset. The controller supports a 64-bit DDR memory controller and up to 3 GB of 400/333/266/200MHz DDR memory.
- 3 DDR DIMM Sockets.** Equipped with three Double Data Rate Dual Inline Memory Module (DDR DIMM) sockets to support up to 3GB of DDR DRAM, the newest memory standard with the highest bandwidth and lowest latency currently available. This memory technology supplies data transfer rates up to 3.2 GB/s for 400MHz DDR SDRAM and 2.7GB/s for 333MHz DDR SDRAM.
- 4 ATX power connector.** This standard 20-pin connector connects to an ATX 12V power supply. The power supply must have at least 1A on the +5V standby lead (+5VSB).
- 5 Floppy Disk connector.** This connector connects the provided ribbon cable for the floppy disk drive. One side of the connector is slotted to prevent incorrect insertion of the floppy disk cable.
- 6 IDE Connectors.** These dual-channel bus master IDE connectors support up to four Ultra DMA133/100/66, PIO Modes 3 & 4 IDE devices. Both the primary(blue) and secondary(black) connectors are slotted to prevent incorrect insertion of the IDE ribbon cable.
- 7 Flash ROM.** This 2Mb firmware contains the programmable BIOS program. (Refer to section “2.1 Managing and updating your BIOS” on page 2-2 for more information)
- 8 South bridge controller.** Features the brand new nVidia® nForce2™ MCP integrated peripheral South Bridge controller operates at 800MB/sec to communicate with the North Bridge for maximum bandwidth required for PCI, USB and support for Fast Ethernet devices. The controller supports standard UltraDMA133/100/66/33 and separate data paths for each IDE channel are built-in for up to two IDE devices. The controller supports six USB ports, one LAN port and is PCI rev2.2 compliant.
- 9 Super I/O chipset.** ITE IT8708 offers support for a variety of I/O functions. Provides two high-speed UART compatible serial ports and one parallel port with EPP and ECP capabilities. UART2 can also be directed from COM2 to the Infrared Module for wireless connections. The Super I/O controller supports a floppy disk drive, PS/2 keyboard, and PS/2 mouse.
- 10 COM2 Header.** This 9-pin connects to a COM2 port.
- 11 GAME port header.** This header connects to a GAME port module.
- 12 ASUS ASIC.** This chip performs multiple system functions that include hardware and system voltage monitoring among others.

- 13 Onboard LED.** This onboard LED lights up if there is a standby power on the motherboard. This LED acts as a reminder to turn off the system power before plugging or unplugging devices.
- 14 PCI slots.** These 32-bit PCI 2.2 expansion slots support bus master PCI cards like SCSI or LAN cards with 133MB/s maximum output.
- 15 S/PDIF connector.** This header connects to the S/PDIF bracket. (optional)
- 16 Audio CODEC.** The Realtek 6-channel CODEC is an AC'97 compliant audio CODEC designed for PC multimedia systems.
- 17 LAN chip.** The MCP integrated NVIDIA® MAC + Realtek 8201BL PHY Fast Ethernet controller allows connection to a Local Area Network (LAN) through a network hub.
- 18 AGP Slot.** This Accelerated Graphics Port (AGP) slot only supports 1.5V AGP 8X mode graphics cards for 3D graphical applications.
- 19 PS/2 mouse port.** This green 6-pin connector is for a PS/2 mouse.
- 20 Parallel port.** This 25-pin port connects a parallel printer, a scanner, or other devices.
- 21 RJ-45 port.** Using the NVIDIA® LAN 10/100 Mbps fast ethernet controller, this port allows connection to a Local Area Network (LAN) through a network hub.
- 22 Line In jack.** This Line In (light blue) jack connects a tape player or other audio sources.
- 23 Line Out jack.** This Line Out (lime) jack connects a headphone or a speaker.
- 24 Microphone jack.** This Mic (pink) jack connects a microphone.
- 25 USB 2.0 ports.** These two 4-pin Universal Serial Bus 2.0 (USB 2.0) ports are available for connecting USB devices such as a mouse and PDA.
- 26 Serial ports.** This port connects to your serial mouse and other serial devices.
- 27 USB 2.0 ports.** These two 4-pin Universal Serial Bus 2.0 (USB 2.0) ports are available for connecting USB devices such as a mouse and PDA.
- 28 PS/2 keyboard port.** This purple 6-pin connector is for a PS/2 keyboard.

1.4 Motherboard layout

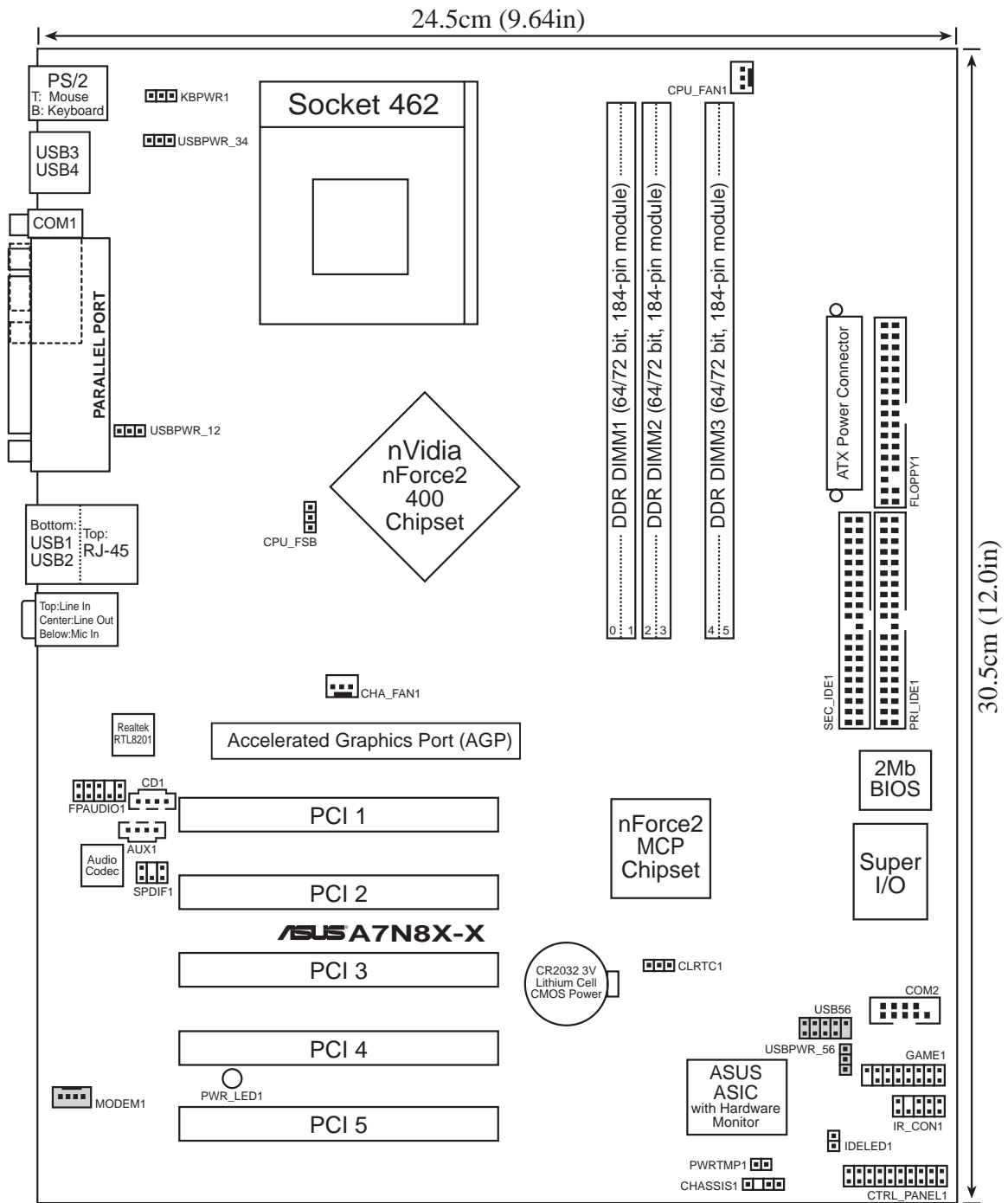

1.5 Before you proceed

Take note of the following precautions before you install motherboard components or change any motherboard settings.



1. Unplug the power cord from the wall socket before touching any component.
2. Use a grounded wrist strap or touch a safely grounded object or to a metal object, such as the power supply case, before handling components to avoid damaging them due to static electricity.
3. Hold components by the edges to avoid touching the ICs on them.
4. Whenever you uninstall any component, place it on a grounded antistatic pad or in the bag that came with the component.
5. **Before you install or remove any component, ensure that the ATX power supply is switched off or the power cord is detached from the power supply.** Failure to do so may cause severe damage to the motherboard, peripherals, and/or components.

1.6 Central Processing Unit (CPU)

The motherboard provides a Socket A (462) for CPU installation. AMD processors offer gigahertz speeds to support all the latest computing platforms and applications. The A7N8X-X supports Athlon™ XP processors with “QuantiSpeed” data processing, large data caches, 3D enhancements and 400/333/266Mhz bus speeds.



Do not use processors with core speeds of less than 1GHz on this motherboard.

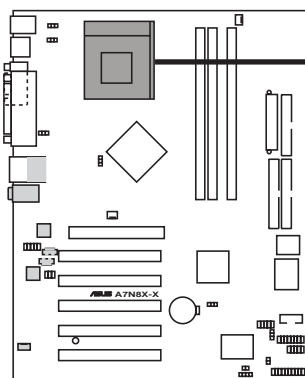

A7N8X-X Socket 462

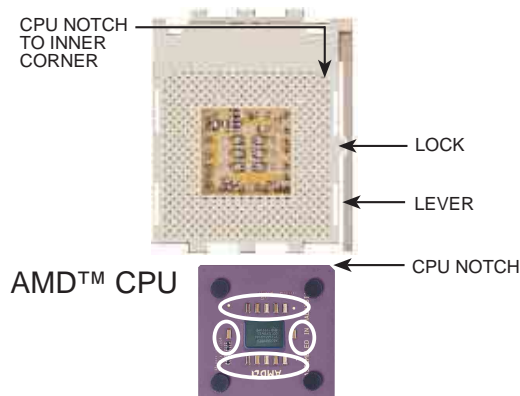

Each AMD CPU has a “marked” corner. This corner is usually indicated with a notch, and/or a golden square or triangle. Refer to this indicator while orienting the CPU.

1.7 System memory

The motherboard has three Double Data Rate (DDR) DIMM sockets that supports up to 3GB non-ECC PC3200/2700/2100/1600 DDR..

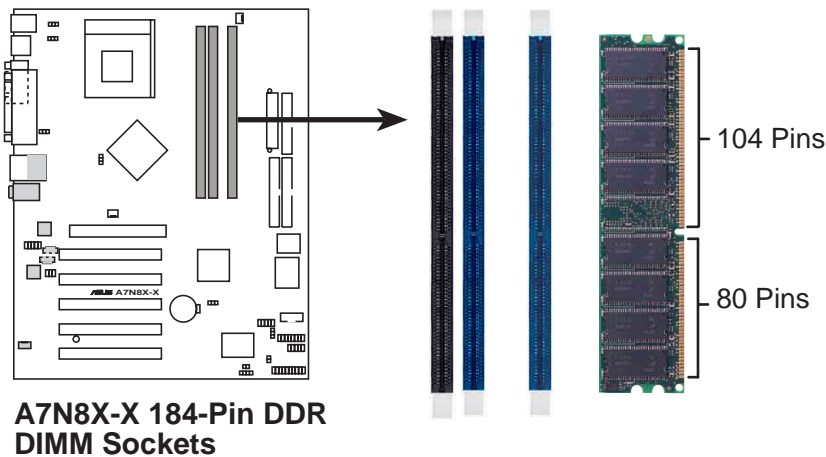

1. DIMMs with more than 8 devices on each side of the module are not supported.
2. Make sure the memory frequency and bus frequency setting in the BIOS are the same or set to [Auto] ensure system stability.
3. A DDR DIMM is keyed with a notch so that it fits in only one direction. DO NOT force a DIMM into a socket to avoid damaging the DIMM.
4. Visit ASUS website (www.asus.com) for latest DDR400 Qualified Vendor List.

1.7.1 Installing a DIMM

1. Unlock a DIMM socket by pressing the retaining clips outward.
2. Align a DIMM on the socket. Make sure the notches on the DIMM exactly match the notches in the socket.
3. Firmly insert the DIMM into the socket until the retaining clips lock into place.

1.8 Expansion slots

The A7N8X-X motherboard has six (6) expansion slots. The following sub-sections describe the slots and the expansion cards that they support.

1.8.1 Configuring an expansion card

Some expansion cards need an IRQ to operate. Generally, an IRQ must be exclusively assigned to one function at a time. In a standard design configuration, 16 IRQs are available but most are already in use.

Normally, 6 IRQs are free for expansion cards. Sometimes IRQs are “shared” by more than one function; in this case, IRQ assignments are swapped automatically or adjusted through the BIOS firmware.

1.8.2 Standard Interrupt Assignments

IRQ	Standard Function
0	System Timer
1	Keyboard Controller
2	Programmable Interrupt Controller
3*	USB Universal Host Controller
4*	Communications Port (COM1)
5*	Onboard Audio
6	Standard Floppy Disk Controller
7*	Printer Port (LPT1)
8	System CMOS/Real Time Clock
9*	Onboard LAN
10*	USB Universal Host Controller
11*	External AGP card
12*	PS/2 Compatible Mouse Port
13	Numeric Data Processor
14*	Primary Ultra ATA Controller
15*	Secondary Ultra ATA Controller

*These IRQs are usually available for ISA or PCI devices.

IRQ assignments for this motherboard

	A	B	C	D
PCI slot 1	shared	—	—	—
PCI slot 2	—	—	—	used
PCI slot 3	—	—	used	—
PCI slot 4	—	used	—	—
PCI slot 5	shared	—	—	—

1.8.3 AGP slot

This motherboard has an Accelerated Graphics Port (AGP) slot that supports +1.5V AGP 8X cards. Note the notches on the card golden fingers to ensure that they fit the AGP slot on your motherboard.

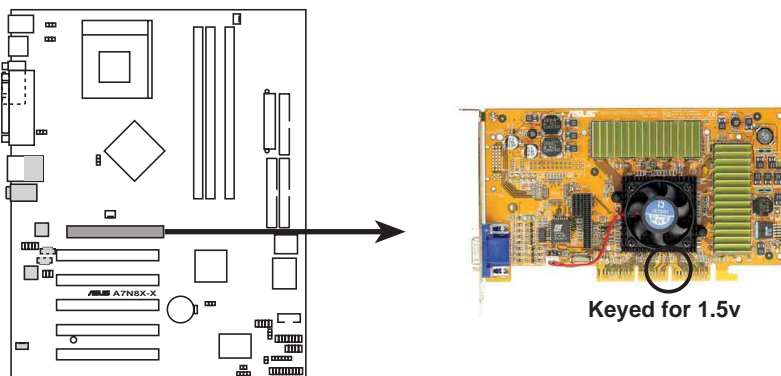

A7N8X-X Accelerated Graphics Port (AGP)

1.9 Jumpers

This section describes and illustrates the jumpers on the motherboard.

1. USB device wake-up (3-pin USBPWR_12,USBPWR_34,USBPWR_56)

Set these jumpers to +5V to wake up the computer from S1 sleep mode (CPU stopped, DRAM refreshed, system running in low power mode) using the connected USB devices. Set to +5VSB to wake up from S3 sleep mode (no power to CPU, DRAM in slow refresh, power supply in reduced power mode). Both jumpers are set to pins 1-2 (+5V) by default because not all computers have the appropriate power supply to support this feature.

The USBPWR_12 and USBPWR_34 jumpers are for the rear USB port. USBPWR_56 is for the internal USB header that you can connect to the front USB ports.



This feature requires a power supply that can provide at least 2A on the +5VSB lead when these jumpers are set to +5VSB. Otherwise, the system does not power up.

The total current consumed must NOT exceed the power supply capability (+5VSB) whether under normal condition or in sleep mode.

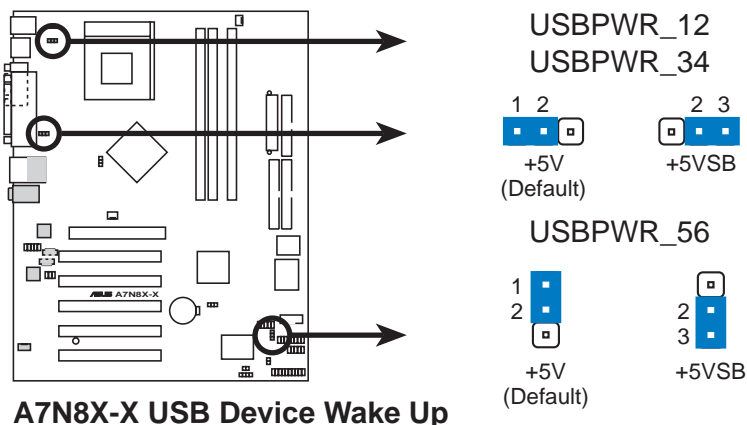

A7N8X-X USB Device Wake Up

2. Central Processing Unit FSB (CPU_FSB)

This jumper when set to 1-2 pins (default), enable support for Front Side Bus 400/333/266. When set to pins 2-3, it sets support for FSB 200 only.

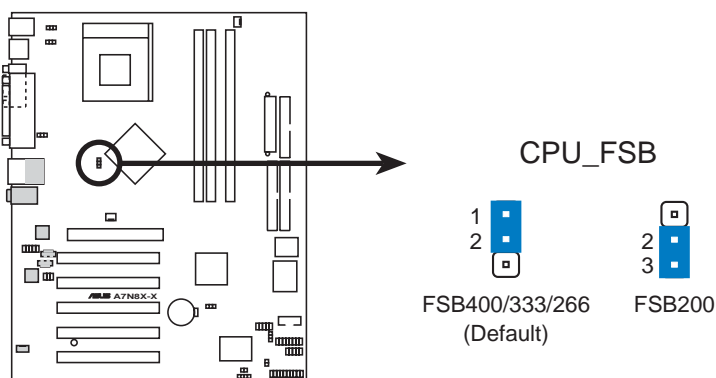

A7N8X-X CPU FSB Jumper Setting

3. Clear RTC RAM (CLRTC1) (optional)

This jumper clears the Real Time Clock (RTC) RAM of date, time and system setup parameters in CMOS. The RAM data in CMOS is powered by the onboard button cell battery.

To erase the RTC RAM:

1. Turn OFF the computer and unplug the power cord.
2. Remove the battery.
3. Move the jumper caps from [1-2] to [2-3] momentarily. Replace the jumper cap to the original position, [1-2].
4. Re-install the battery.
5. Plug the power cord and turn ON the computer.
6. Hold down the key during the boot process and enter BIOS setup to re-enter data.

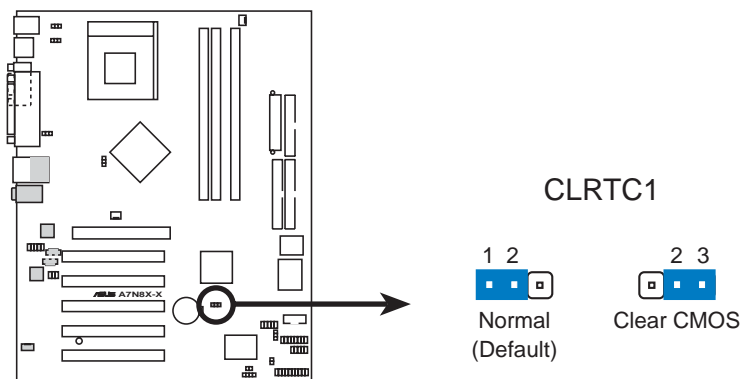

A7N8X-X Clear RTC RAM

4. Keyboard power (3-pin KBPWR1)

This jumper allows you to enable or disable the keyboard wake-up feature. Set this jumper to pins 2-3 (+5VSB) if you wish to wake up the computer when you press a key on the keyboard (the default value is [Disabled]). This feature requires an ATX power supply that can supply at least 1A on the +5VSB lead, and a corresponding setting in the BIOS (see section 2.5.1 Power Up Control).

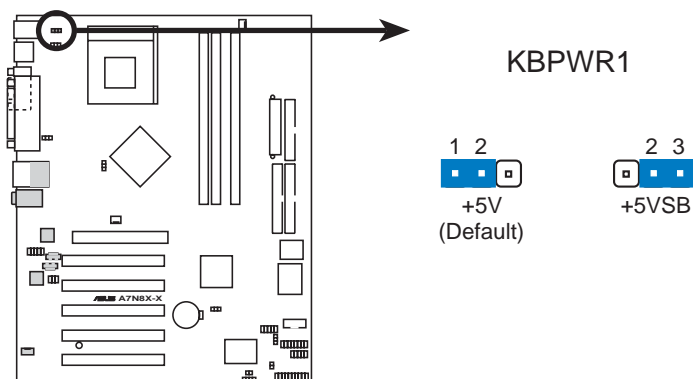

A7N8X-X Keyboard Power Setting

1.10 Connectors

This section describes and illustrates the connectors on the motherboard.

1. IDE connectors (40-1 pin PRI_IDE1, SEC_IDE1)

This connector supports the provided UltraDMA/133/100/66 IDE hard disk ribbon cable. Connect the cable's blue connector to the primary (recommended) or secondary IDE connector, then connect the gray connector to the UltraDMA/133/100/66 slave device (hard disk drive) and the black connector to the UltraDMA/133/100/66 master device. It is recommended that you connect non-UltraDMA/133/100/66 devices to the secondary IDE connector. If you install two hard disks, you must configure the second drive as a slave device by setting its jumper accordingly. Refer to the hard disk documentation for the jumper settings. BIOS supports specific device bootup. If you have more than two UltraDMA/133/100/66 devices, purchase another UltraDMA/133/100/66 cable. You may configure two hard disks to be both master devices with two ribbon cables – one for the primary IDE connector and another for the secondary IDE connector.



Pin 20 on each IDE connector is removed to match the covered hole on the UltraDMA cable connector. This prevents incorrect orientation when you connect the cables.

For UltraDMA/133/100/66 IDE devices, use an 80-conductor IDE cable.

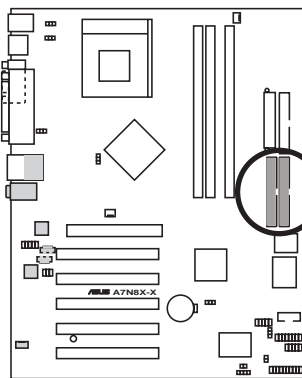

A7N8X-X IDE Connectors

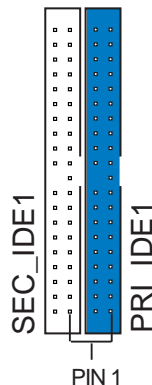

NOTE: Orient the red markings (usually zigzag) on the IDE ribbon cable to PIN 1.

2. Floppy disk drive connector (34-1 pin FLOPPY1)

This connector supports the provided floppy drive ribbon cable. After connecting one end to the motherboard, connect the other end to the floppy drive. (Pin 5 is removed to prevent incorrect insertion when using ribbon cables with pin 5 plug).

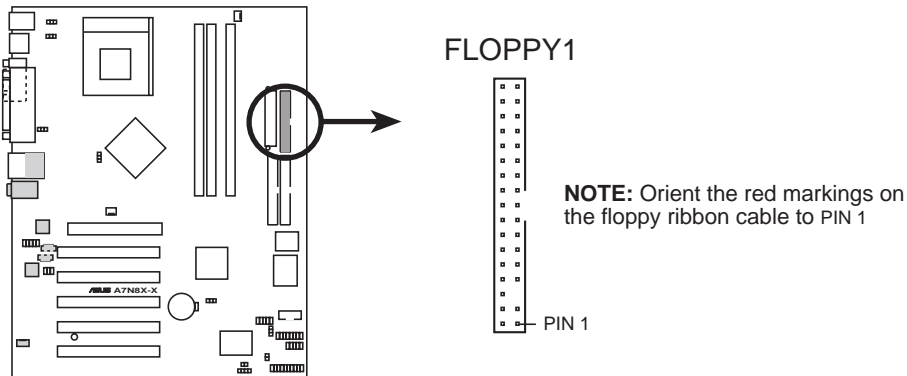

A7N8X-X Floppy Disk Drive Connector

3. ATX power connectors (20-pin ATXPWR1)

These connectors connect to an ATX 12V power supply. The plugs from the power supply are designed to fit these connectors in only one orientation. Find the proper orientation and push down firmly until the connectors completely fit.

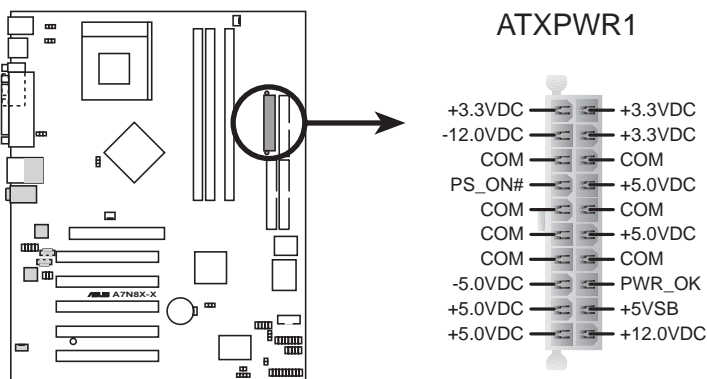

A7N8X-X ATX Power Connector



If you will need to replace the power supply in the future, make sure that your new ATX 12V power supply can provide 8A on the +12V lead and at least 1A on the +5-volt standby lead (+5VSB). The minimum recommended wattage is 230W, or 300W for a fully configured system. The system may become unstable and may experience difficulty powering up if the power supply is inadequate.

4. USB header (10-1 pin USB56) (optional)

If the USB 2.0 port connectors on the back panel are inadequate, one USB header is available for four additional USB port connectors. Connect a 2-port USB connector set to a USB header and mount the USB bracket to an open slot in the chassis.

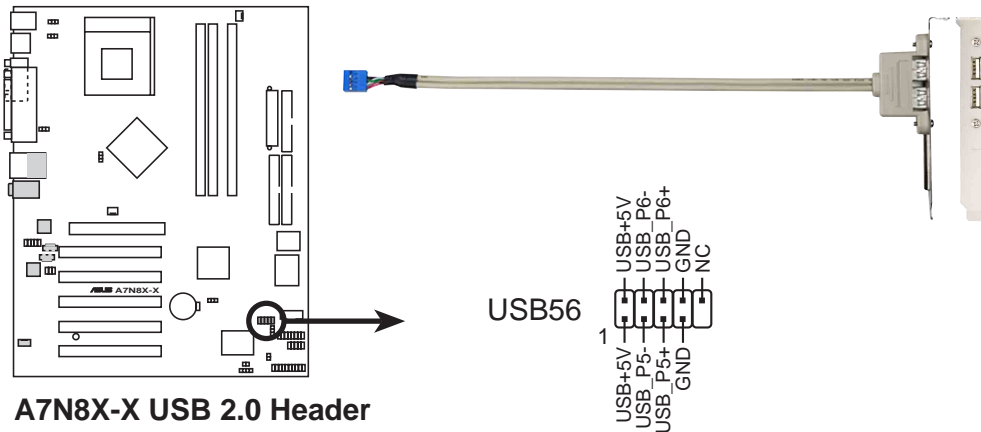

5. GAME/MIDI connector (16-1 pin GAME1) (optional)

This connector supports a GAME/MIDI module. If your package came with the optional USB 2.0/GAME module, connect the GAME/MIDI cable to this connector. The GAME/MIDI port on the module connects a joystick or a game pad for playing games, and MIDI devices for playing or editing audio files.

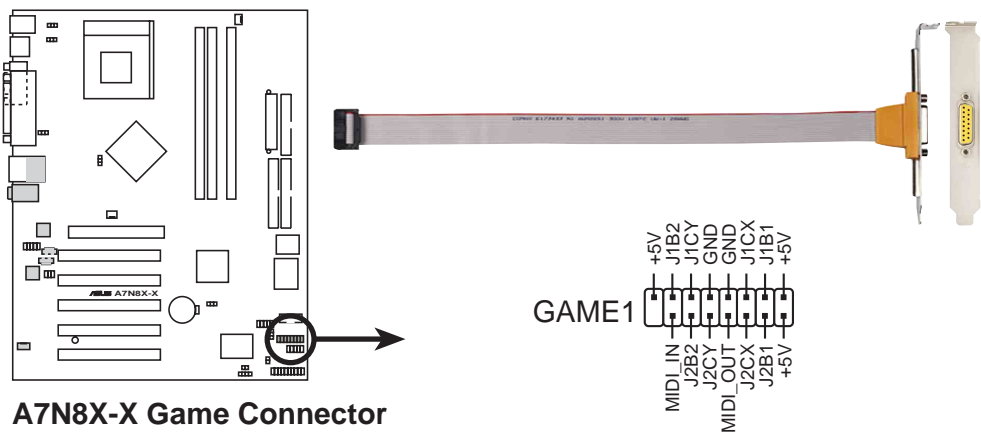

6. CPU and Chassis Fan Connectors (3-pin CPU_FAN1, CHA_FAN1)

The fan connectors support cooling fans of 350mA~740mA (8.88W max.) or a total of 1A~2.22A (26.64W max.) at +12V. Connect the fan cables to the fan connectors on the motherboard, making sure that the black wire of each cable matches the ground pin of the connector.

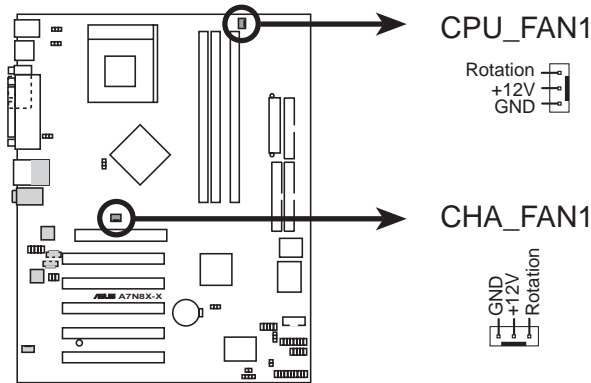

A7N8X-X 12-Volt Cooling Fan Power



Do not forget to connect the fan cables to the fan connectors. Lack of sufficient air flow within the system may damage the motherboard components. These are not jumpers! **DO NOT** place jumper caps on the fan connectors!

7. Chassis intrusion connector (4-1 pin CHASSIS1)

This lead is for a chassis designed with intrusion detection feature. This requires an external detection mechanism such as a chassis intrusion sensor or microswitch. When you remove any chassis component, the sensor triggers and sends a high-level signal to this lead to record a chassis intrusion event.

By default, the pins labeled “Chassis Signal” and “Ground” are shorted with a jumper cap. If you wish to use the chassis intrusion detection feature, remove the jumper cap from the pins.

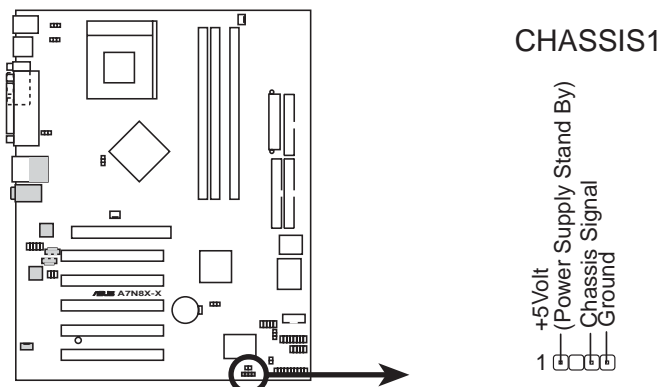

A7N8X-X Chassis Open Alarm Lead

8. Front panel audio connectors (10-1 pin FP_AUDIO1)

This is an interface for the Intel front panel audio cable that allow convenient connection and control of audio devices.

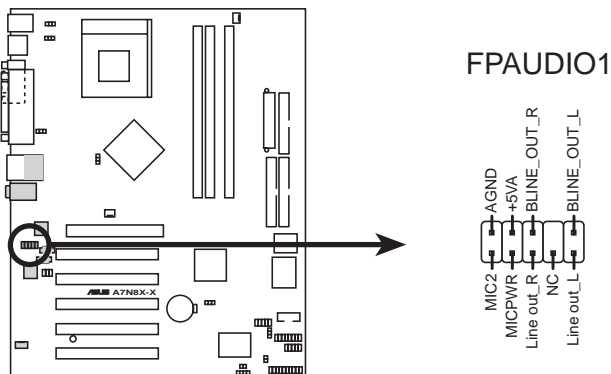

A7N8X-X Front Panel Audio Connector

9. Hard disk connector (2-pin IDELED1)

This 2-pin connector connects to the front panel HD LED and lights up on every read/write activity of any of the disc drives connected to the primary or secondary IDE slots.

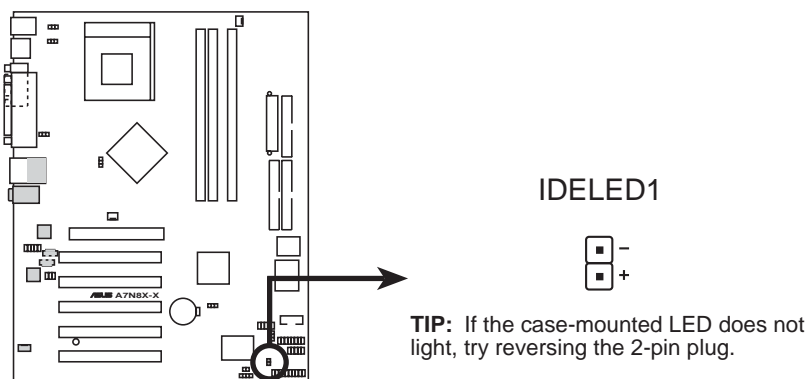

A7N8X-X IDE Activity LED

10. OnBoard LED

The green Light Emitting Diode (LED) lights-ON if there is standby power and lights-OFF when the power is turned off.

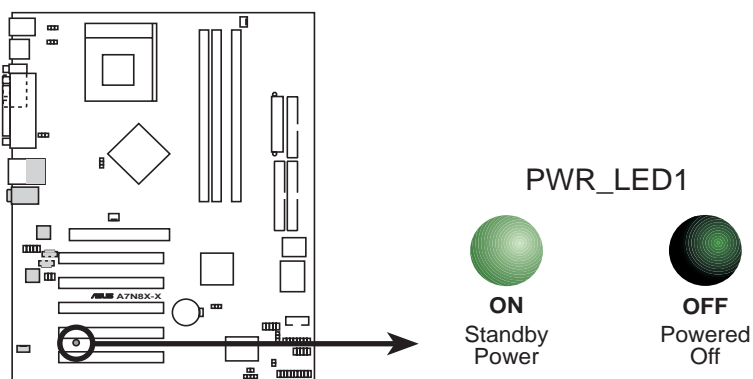

A7N8X-X Onboard LED

11. Internal audio connectors (4-pin CD1, AUX1, MODEM1)

These connectors allow you to receive stereo audio input from sound sources such as a CD-ROM, TV tuner, MPEG card or modem.

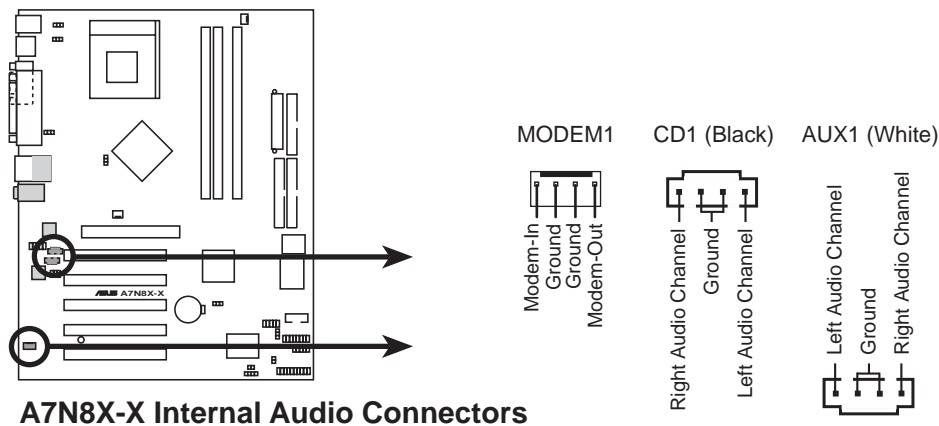

12. Power Supply Thermal Sensor (2-pin PWRTMP1)

This header supports a thermal sensor for the power supply.

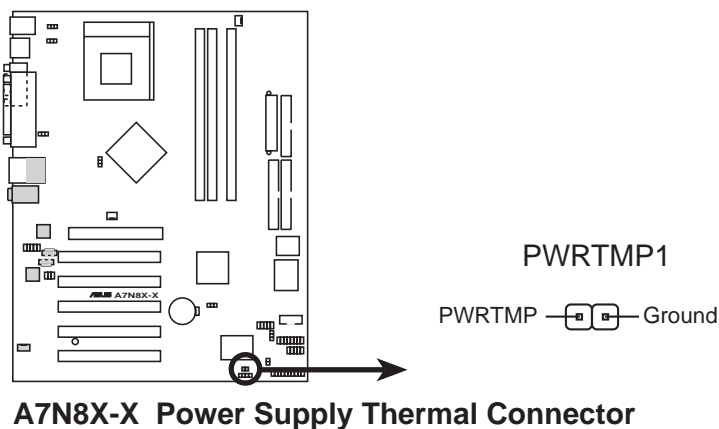

13. Serial Port 2 connector (10-1 pin COM2) (optional)

This connector accommodates a second serial port using an optional serial port bracket. Connect the bracket cable to this connector then install the bracket into a slot opening at the back of the system chassis.

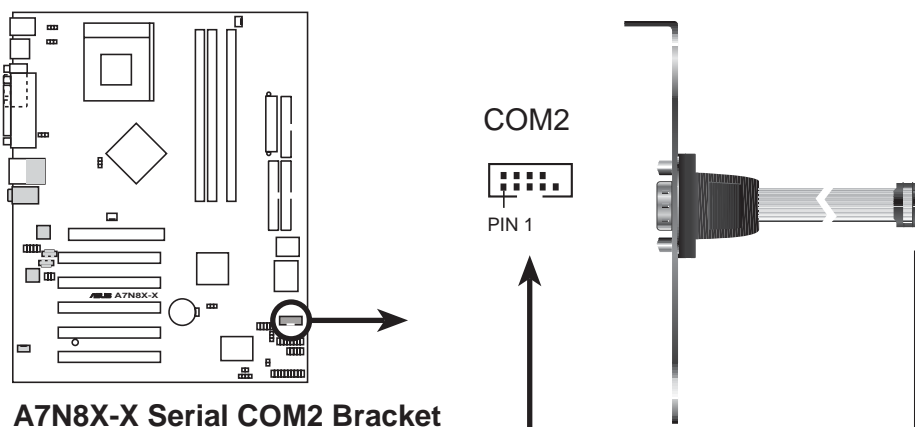

14. Digital Audio Connector (6 pin SPDIF1) (optional)

This connector is for optional S/PDIF audio module that allows digital instead of analog sound input and output.

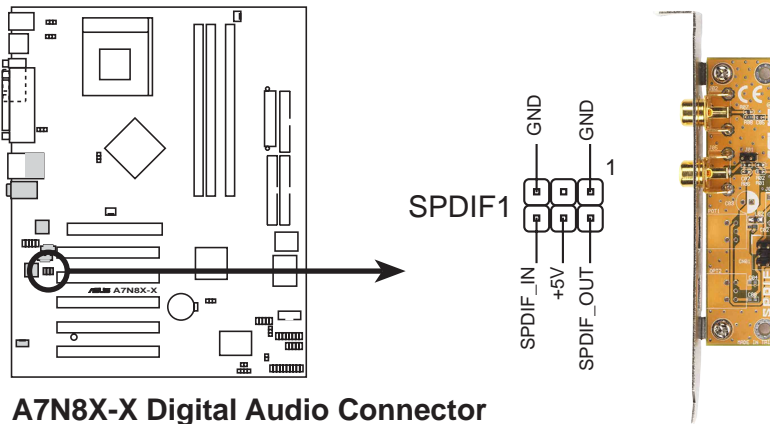

A7N8X-X Digital Audio Connector



When you input sound for S/PDIF IN, the LINE_OUT will output the sound. Mute LINE_OUT to impede sound output from S/PDIF IN.

15. Infrared Module connector (10-1 or 10-2 pin IR_CON1) (optional)

These connectors support an optional wireless transmitting and receiving infrared module. The module mounts to a small opening on the system chassis that support this feature. You must also configure the UART2 Use As parameter in BIOS to set UART2 for use with IR.

Use the ten pins as shown in Back View and connect a ribbon cable from the module to the motherboard SIR connector according to the pin definitions.

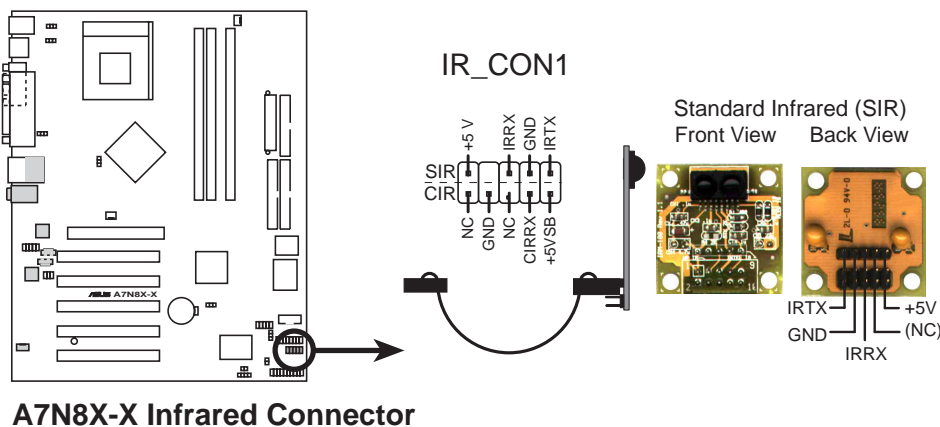

A7N8X-X Infrared Connector

16. System panel connector (20-pin PANEL1)

This connector accommodates several system front panel functions.

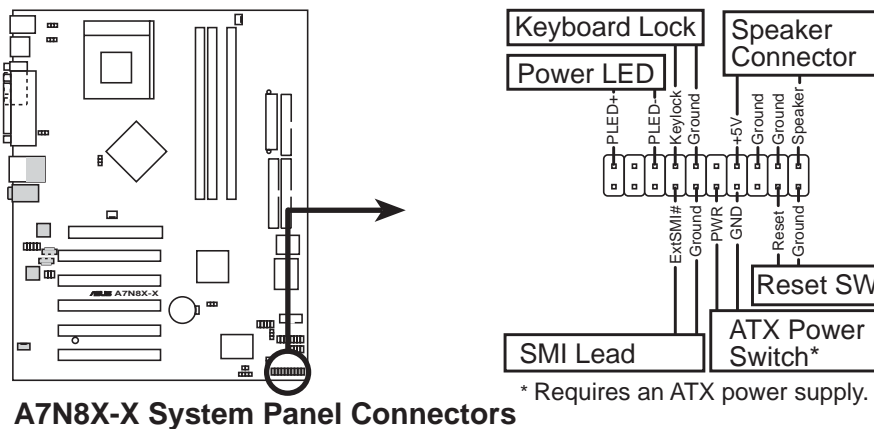

- **System Power LED Lead (3-1 pin PLED)**

This 3-1 pin connector connects to the system power LED. The LED lights up when you turn on the system power.

- **Keyboard Lock Lead (2-1 pin KEYLOCK)**

This 2-1 pin connector connects to the case-mounted switch to allow the use of the keyboard lock feature.

- **System Warning Speaker Lead (4-pin SPEAKER)**

This 4-pin connector connects to the case-mounted speaker and allows you to hear system beeps and warnings.

- **System Management Interrupt Lead (2-pin SMI)**

This 2-pin connector permits switching to suspend mode, or “Green” mode, in which system activity is instantly decreased to save power and to expand the life of certain system components.

- **Reset Switch (2-pin RESET)**

This 2-pin connector connects to the case-mounted reset switch for rebooting the system without turning off the power switch.

- **ATX Power Switch / Soft-Off Switch Lead (2-pin PWR)**

This connector connects a switch that controls the system power. Pressing the power switch turns the system between ON and SLEEP, or ON and SOFT OFF, depending on the BIOS or OS settings. Pressing the power switch while in the ON mode for more than 4 seconds turns the system OFF.

Chapter 2

This chapter gives information about the ASUS A7N8X-X Basic Input/Output System (BIOS). This chapter includes updating the BIOS using the ASUS AFLASH BIOS that is bundled with the support CD.

BIOS Information

2.1 Managing and updating your BIOS

2.1.1 Using the computer system for the first time

It is recommended that you save a copy of the original motherboard BIOS along with a Flash Memory Writer utility (AWDFLASH.EXE) to a bootable floppy disk in case you need to reinstall the BIOS later. AWDFLASH.EXE is a Flash Memory Writer utility that updates the BIOS by uploading a new BIOS file to the programmable flash ROM on the motherboard. This file works only in DOS mode. To determine the BIOS version of your motherboard, check the last four numbers of the code displayed on the upper left-hand corner of your screen during bootup. Larger numbers represent a newer BIOS file.

1. Type `FORMAT A:/S` at the DOS prompt to create a bootable system disk. **DO NOT** copy `AUTOEXEC.BAT` and `CONFIG.SYS` to the disk.
2. Type `COPY D:\SOFTWARE\AWDFLASH\AWDFLASH.EXE A:\` (assuming D is your CD-ROM drive) to copy `AWDFLASH.EXE` to the boot disk you created.



AWDFLASH works only in DOS mode. It does not work in the DOS prompt within Windows, and does not work with certain memory drivers that may be loaded when you boot from the hard drive. It is recommended that you reboot using a floppy disk in order to open DOS mode.

3. Reboot the computer from the floppy disk. To use `AWDFLASH.EXE` must be operated from the `ROOT` directory. Therefore, copy the `AWDFLASH.EXE` program and the `NEW BIOS` file to the root directory on the hard disk drive; for example: type, `"COPY A:\AWDFLASH.EXE C:\"` and `"COPY A:\BIOSNAME.BIN C:\"`.



If you encounter problems while updating the new BIOS, **DO NOT** turn off the system because this may cause boot problems. Just repeat the process, and if the problem persists, load the original BIOS file you saved to the boot disk, or try to clear the CMOS memory (see section 1.7, *Jumpers*). If the Flash Memory Writer utility is not able to successfully update a complete BIOS file, the system may not boot. If this happens, call the ASUS service center for support.

2.1.2 Updating BIOS procedures



Update the BIOS only if you have problems with the motherboard and you are sure that the new BIOS revision will solve your problems. Careless updating may create more problems !

The Binary Input/Output System (BIOS) can be updated using the built-in Flash Memory Writer utility or using a bootable floppy disk with the executable Flash Memory Writer Utility (AWDFLASH.EXE). The following sub-sections explain the steps in flashing your BIOS.

Updating BIOS via Built-in AwardBIOS Flash Utility

1. Download the latest BIOS file from the ASUS website (see ASUS contact info on Page viii). Save the copy to a floppy disk.



Write down the BIOS file name on a piece of paper. You need to type the exact BIOS file name at the Award BIOS Flash Utility.

2. Reboot the computer.
3. To use AwardBIOS Flash Utility, press <Alt> + <F2> during POST to display the following screen.

```
AwardBIOS Flash Utility V8.20A
(C)Phoenix Technologies Ltd. All Rights Reserved

For nVidia-nForce-A7N8X-X    DATE: 08/13/2002
Flash Type - PMC Pm49FL004T LPC/FWH

File Name to Program : aw0702.bin

MacAddr: Safe=0000000000000000

Message: Do You Want To Save Bios (Y/N)
```



The BIOS information in the above screen is for reference only. what you see on your screen may not be exactly the same as shown.

4. Insert the disk that contains the new BIOS file into the floppy drive. You will receive the error message, "WARNING! Device not ready!" if you proceed to step 5 without the disk in the drive.
5. Type the name of the new BIOS file, for example: "AW0702.BIN" then press <Enter>. The program asks if you want to save the previous BIOS. Select <Y> since it is advisable to back-up the original BIOS in case you need to reprogram it.

- The program asks to save the previous BIOS to a separate file. Type a file name for the old bios and then press <Y>. The AWDFLASH program backs-up the file.

```
AwardBIOS Flash Utility V8.20A
(C)Phoenix Technologies Ltd. All Rights Reserved

For nVidia-nForce-A7N8X-X    DATE: 08/13/2002
Flash Type - PMC Pm49FL004T LPC/FWH

File Name to Program : aw0702.bin
Save current BIOS as : old.bin

Message: Press 'Y' to Program or 'N' to Exit
```

- AWDFLASH proceeds to check the new BIOS file and asks the user to program (flash) the new BIOS file to the motherboard.

```
AwardBIOS Flash Utility V8.20A
(C)Phoenix Technologies Ltd. All Rights Reserved

For nVidia-nForce-A7N8X-X    DATE: 08/13/2002
Flash Type - PMC Pm49FL004T LPC/FWH

File Name to Program : aw0702.bin
Checksum : DAD6H
Save current BIOS as : old.bin

Message: Press 'Y' to Program or 'N' to Exit
```

- Type <Y> and Press <Enter> to flash the new Bios file. NOTE: Do not shut off system power or unplug the supply during the flash process.

```
AwardBIOS Flash Utility V8.20A
(C)Phoenix Technologies Ltd. All Rights Reserved

For nVidia-nForce-A7N8X-X    DATE: 08/13/2002
Flash Type - PMC Pm49FL004T LPC/FWH

File Name to Program : aw0702.bin
Program Flashing Memory

█ Write OK █ No Update █ Write Fail

Warning: Don't Turn Off Power Or Reset System!
```

- The BIOS flashes and displays the results. Press <F1> to restart.



Updating BIOS via Bootable Floppy Disk

- Boot from the floppy disk.
- At the "A:\>" prompt, type "C:\>" and then press <Enter>.
- At the "C:\>" prompt, type "AWDFLASH /e BIOSFILE" and then <Enter>. For example: "AWDFLASH /e aw0702.bin" The AWDFLASH screen appears, and the BIOS file appears in the space, "File Name to Program".
- Type the name of the new BIOS file, for example: "AW0702.BIN" then press <Enter>. The program asks if you want to save the previous BIOS. Select <Y> since it is advisable to back-up the original BIOS in case you need to reprogram it.
- Follow steps 6 to 9 in "2.1.2.1 Updating BIOS via Built-in Award BIOS Flash Utility."

2.2 BIOS Setup program

This motherboard supports a programmable FLASH ROM that you can update using the provided utility described in section “2.1 Managing and updating your BIOS.”

Use the BIOS Setup program when you are installing a motherboard, reconfiguring your system, or prompted to “Run Setup”. This section explains how to configure your system using this utility.

Even if you are not prompted to use the Setup program, you may want to change the configuration of your computer in the future. For example, you may want to enable the security password feature or make changes to the power management settings. This requires you to reconfigure your system using the BIOS Setup program so that the computer can recognize these changes and record them in the CMOS RAM of the FLASH ROM.

The FLASH ROM on the motherboard stores the Setup utility. When you start up the computer, the system provides you with the opportunity to run this program. Press <Delete> during the Power-On Self Test (POST) to enter the Setup utility, otherwise, POST continues with its test routines.

If you wish to enter Setup after POST, restart the system by pressing <Ctrl> + <Alt> + <Delete>, or by pressing the reset button on the system chassis. You can also restart by turning the system off and then back on. Do this last option only if the first two failed.

The Setup program is designed to make it as easy to use as possible. It is a menu-driven program, which means you can scroll through the various sub-menus and make your selections among the predetermined choices.



Because the BIOS software is constantly being updated, the following BIOS setup screens and descriptions are for reference purposes only, and may not exactly match what you see on your screen.

2.2.1 BIOS menu bar

The top of the screen has a menu bar with the following selections:

- MAIN** Use this menu to make changes to the basic system configuration.
- ADVANCED** Use this menu to enable and make changes to the advanced features, including BIOS, Chipset, Peripheral, Power and PnP/ PCI configurations.
- SECURITY** Use this menu to set the Supervisor and User passwords.
- HARDWARE** Monitor the status of vital components, including voltages and fan speeds.
- EXIT** Use this menu to exit the current menu or to exit the Setup program.
- MONITOR**

To access the menu bar items, press the right or left arrow key on the keyboard until the desired item is highlighted.

2.2.2 Legend bar

At the bottom of the Setup screen is a legend bar. The keys in the legend bar allow you to navigate through the various setup menus. The following table lists the keys found in the legend bar with their corresponding functions.

Navigation Key(s)	Function Description
<F1>	Displays the General Help screen
<Esc>	Jumps to the Exit menu or returns to the main menu from a sub-menu
Left or Right arrow	Selects the menu item to the left or right
Up or Down arrow	Moves the highlight up or down between fields
Page Down and – (minus)	Scrolls backward through the values for the highlighted field
Page Up and + (plus)	Scrolls forward through the values for the highlighted field
<Enter>	Brings up a selection menu for the highlighted field
<F10>	Saves changes and Exit

General help

In addition to the Item Specific Help window, the BIOS setup program also provides a General Help screen. You may launch this screen from any menu by simply pressing <F1> or the <Alt> + <H> combination. The General Help screen lists the legend keys and their corresponding functions.

Saving changes and exiting the Setup program

See “4.7 Exit Menu” for detailed information on saving changes and exiting the setup program.

Scroll bar

When a scroll bar appears to the right of a help window, it indicates that there is more information to be displayed that will not fit in the window. Use <PgUp> and <PgDn> or the up and down arrow keys to scroll through the entire help document. Press <Home> to display the first page, press <End> to go to the last page. To exit the help window, press <Enter> or <Esc>.

Sub-menu

Note that a right pointer symbol (as shown on the left) appears to the left of certain fields. This pointer indicates that you can display a sub-menu from this field. A sub-menu contains additional options for a field parameter. To display a sub-menu, move the highlight to the field and press <Enter>. The sub-menu appears. Use the legend keys to navigate and enter values within each sub-menu as you would within a menu. Use the <Esc> key to return to the main menu. Take some time to familiarize yourself with the legend keys and their corresponding functions. Practice navigating through the various menus and sub-menus. While moving around through the Setup program, note that explanations appear in the Item Specific Help window located to the right of each menu. This window displays the help text for the currently highlighted field.

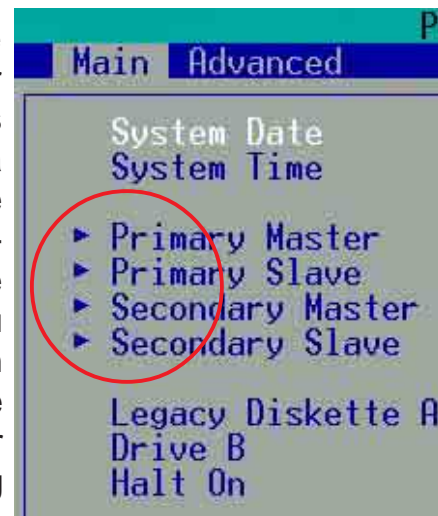

2.3 Main Menu

When you enter the Setup program, the following screen appears.

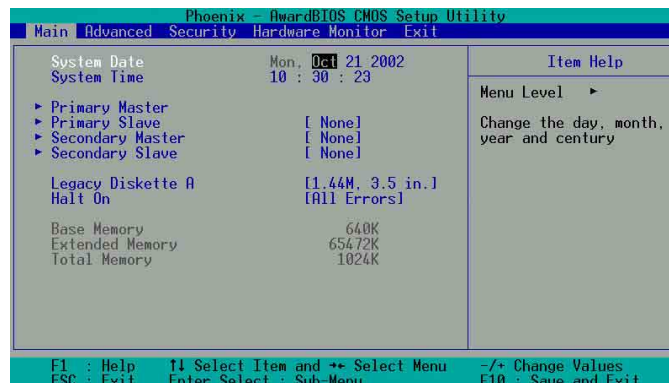

System Date [mm/dd/yy]

Sets the system to the date that you specify (usually the current date). The format is month, day, year. Valid values for month, day, and year are Month: (1 to 12), Day: (1 to 31), Year: (up to 2084). Use the <Tab> or <Shift> + <Tab> keys to move between the month, day, and year fields.

System Time [hh:mm:ss]

Sets the system to the time that you specify (usually the current time). The format is hour, minute, second. Valid values for hour, minute and second are Hour: (00 to 23), Minute: (00 to 59), Second: (00 to 59). Use the <Tab> or <Shift> + <Tab> keys to move between the hour, minute, and second fields.

Legacy Diskette A [1.44M, 3.5 in.]

Sets the type of floppy drive installed. Configuration options: [None] [360K, 5.25 in.] [1.2M , 5.25 in.] [720K , 3.5 in.] [1.44M, 3.5 in.] [2.88M, 3.5 in.]

Halt On [All Errors]

This field sets the system to halt on errors according to the system functions specified in each option. Configuration options: [All Errors] [No Errors] [All, But Keyboard] [All , But Diskette] [All, But Disk/Key]

2.3.1 Primary Master/Slave

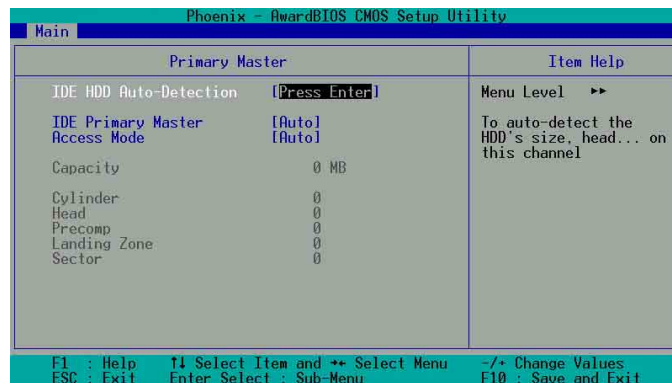

IDE HDD Auto-Detection [Press Enter]

Press enter to automatically detect an IDE hard disk drive, if the hard drive is not already detected. In cases of undetected HDDs, pressing enter will detect the HDD and then open access to both the IDE Primary Master and Access Mode fields.

IDE Primary Master/Slave [Auto]

Select [Auto] to automatically detect an IDE hard disk drive. If automatic detection is successful, the setup BIOS automatically fills in the correct values for the remaining fields on this sub-menu. If automatic detection fails, this may be because the hard disk drive is too old or too new. If the hard disk was already formatted on a previous system, the setup BIOS may detect incorrect parameters. In these cases, select [Manual] to manually enter the IDE hard disk drive parameters. See *Access Mode* below and refer to the next page for more details. If no drive is installed or if you are removing a drive and not replacing it, select [None]. Configuration options: [None] [Auto] [Manual]

Access Mode [Auto]

The default [Auto] automatically detects an IDE hard disk drive. Select [CHS] in coordination with the [Manual] setting of the *IDE Primary Master* in order to enter the Hard Disk Drive values manually.

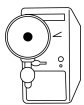

Before attempting to configure a hard disk drive, make sure you have the correct configuration information supplied by the drive manufacturer. Incorrect settings may cause the system to fail to recognize the installed hard disk.

[Manual] & [CHS] Settings

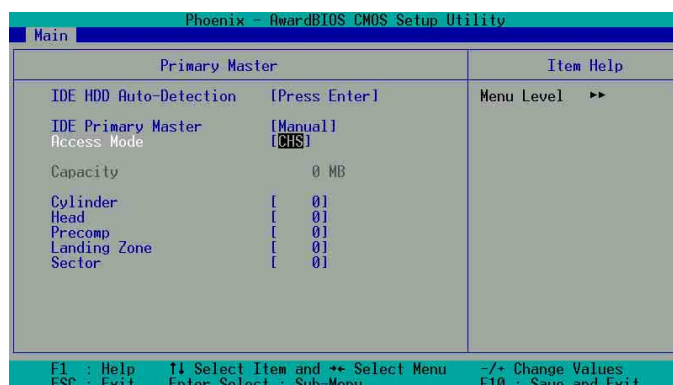

Manually enter the number of cylinders, heads and sectors per track for the drive. Refer to the drive documentation or on the drive label for this information.



After entering the IDE hard disk drive information into BIOS, use a disk utility, such as FDISK, to partition and format new IDE hard disk drives. This is necessary so that you can write or read data from the hard disk. Make sure to set the partition of the Primary IDE hard disk drives to active.

After making your selections on this sub-menu, press the <Esc> key to return to the Main menu. When the Main menu appears, the hard disk drive field displays the size for the hard disk drive that you configured.

Access Mode [Auto]

Select the hard disk drive type in this field. When Logical Block Addressing (LBA) is enabled, the 28-bit addressing of the hard drive is used without regard for cylinders, heads, or sectors. Note that LBA Mode is necessary for drives with more than 504MB storage capacity. Select [CHS] to make manual entries for configuring the fields below. Configuration options: [CHS] [LBA] [Large] [Auto]

Cylinders

This field configures the number of cylinders. Refer to the drive documentation to determine the correct value. To make changes to this field, set the *IDE Primary Master* field to [Manual] and the *Access Mode* to [CHS].

Head

This field configures the number of read/write heads. Refer to the drive documentation to determine the correct value. To make changes to this field, set the *IDE Primary Master* field to [Manual] and the *Access Mode* to [CHS].

Precomp

This field displays the precompressed volumes on the hard disk, if any, in MB.

Landing Zone

This field displays the drive's maximum useable capacity as calculated by the BIOS based on the drive information you entered.

Sector

This field configures the number of sectors per track. Refer to the drive documentation to determine the correct value. To make changes to this field, set the Type field to [User Type HDD] and the *Translation Method* field to [Manual].

2.3.2 Secondary Master/Slave

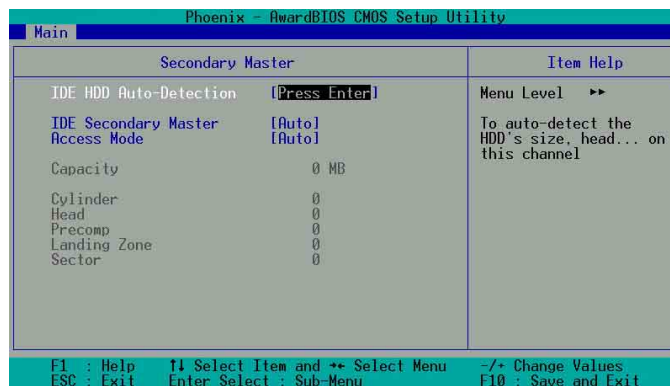

IDE HDD Auto-Detection [Press Enter]

Press enter to automatically detect an IDE hard disk drive, if the hard drive is not already detected. In cases of undetected HDDs, pressing enter will detect the HDD and then open access to both the IDE Primary Master and Access Mode fields.

IDE Secondary Master/Slave [Auto]

Select [Auto] to automatically detect an IDE hard disk drive. If automatic detection is successful, the setup BIOS automatically fills in the correct values for the remaining fields on this sub-menu. If automatic detection fails, this may be because the hard disk drive is too old or too new. If the hard disk was already formatted on a previous system, the setup BIOS may detect incorrect parameters. In these cases, select [Manual] to manually enter the IDE hard disk drive parameters. See *Access Mode* below and refer to the next page for more details. If no drive is installed or if you are removing a drive and not replacing it, select [None]. Configuration options: [None] [Auto] [Manual]

Access Mode [Auto]

The default [Auto] automatically detects an IDE hard disk drive. Select [CHS] in coordination with the [Manual] setting of the *IDE Primary Master* in order to enter the Hard Disk Drive values manually.



Before attempting to configure a hard disk drive, make sure you have the correct configuration information supplied by the drive manufacturer. Incorrect settings may cause the system to fail to recognize the installed hard disk.

2.4 Advanced Menu

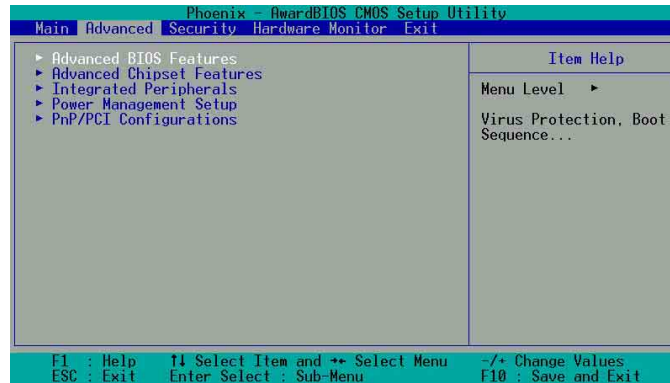

Advanced menu items

The Advanced menu accesses five important sub-menus:

Advanced BIOS Features

These fields set the functional properties of CPU caches, as well as boot devices, security and operational modes.

Advanced Chipset Features

These fields set chipset and CPU functions, including system and AGP caches, boot devices, memory settings, voltages and frequencies.

Integrated Peripherals

These fields set the functional properties of the IDE channels, Master/Slave PIOs, USB, IEEE 1394, audio, network and modem support, as well as serial, game, midi and parallel addresses.

Power Management Setup

These fields set the functional properties of the ACPI, system power management, HDD power, network "wake-up" and "power-on" options.

PnP/PCI Configuration

These fields set the capacity of the BIOS to reset data configurations and to automatically configure the system along with PCI/VGA properties. IRQ resources are accessed from this menu.

To access the menu bar items, press the up and down arrow keys and then press <enter> to view the desired menu.

2.4.1 Advanced BIOS Features

The screenshot shows the 'Advanced BIOS Features' screen in the Phoenix - AwardBIOS CMOS Setup Utility. The screen is divided into two columns: 'Advanced BIOS Features' and 'Item Help'. The 'Advanced BIOS Features' column lists various settings with their current values in brackets. The 'Item Help' column provides a detailed description for the selected 'Menu Level' setting.

Advanced BIOS Features	Item Help
Boot Virus Detection [Enabled]	Menu Level >> Allows you to choose the VIRUS warning feature for IDE Hard Disk boot sector protection. If this function is enabled and someone attempt to write data into this area , BIOS will show a warning message on screen and alarm beep
CPU Level 1 Cache [Enabled]	
CPU Level 2 Cache [Enabled]	
Quick Power On Self Test [Enabled]	
First Boot Device [Floppy]	
Second Boot Device [HDD-0]	
Third Boot Device [CDROM]	
Boot Other Device [Enabled]	
Boot Up Floppy Seek [Enabled]	
Boot Up NumLock Status [On]	
Gate A20 Option [Fast]	
Typematic Rate Setting [Disabled]	
x Typematic Rate (Chars/Sec) 6	
x Typematic Delay (Msec) 250	
APIC Mode [Enabled]	
OS/2 Onboard Memory > 64M [Disabled]	

At the bottom of the screen, there is a legend for navigation keys: F1 : Help, ↑ Select Item and ↓ Select Menu, -/+ Change Values, ESC : Exit, Enter Select : Sub-Menu, and F10 : Save and Exit.

Boot Virus Detection [Disabled]

This field disables boot virus protection by default. Configuration options: [Enabled] [Disabled]

CPU Level 1, Level 2 Cache [Enabled]

These fields enables the CPU levels 1 and 2 cache by default. Configuration options: [Enabled] [Disabled]

Quick Power On Self Test [Enabled]

This field enables the power on test. Configuration options: [Enabled] [Disabled]

First Boot Device [Floppy]

This field sets the priority of the first boot device; by default, the system boots up on the floppy diskette drive. Configuration options: [Floppy] [LS120] [HDD-0] [HDD-1] [HDD-2] [HDD-3] [SCSI] [CDROM] [ZIP100] [LAN] [Disabled]

Second Boot Device [HDD-0]

This field sets the priority of the second boot device; by default, the system boots up on the hard disk driver if the floppy drive is not present. Configuration options: [Floppy] [LS120] [HDD-0] [HDD-1] [HDD-2] [HDD-3] [SCSI] [CDROM] [ZIP100] [LAN] [Disabled]

Third Boot Device [LS120]

This field sets the priority of the third boot device; by default, the system boots up on the LS120 if the floppy and hard disk drive are not present. Configuration options: [Floppy] [LS120] [HDD-0] [HDD-1] [HDD-2] [HDD-3] [SCSI] [CDROM] [ZIP100] [LAN] [Disabled]

Boot Other Device [Enabled]

By default, this field enables the detection of other devices, aside from the first three priority devices. Configuration options: [Enabled] [Disabled]

Boot-up Floppy Seek [Enabled]

If enabled, this field speeds up the Power On Self Test (POST) routine by skipping and retesting several times. Configuration options: [Enabled] [Disabled]

Boot-up NumLock Status [On]

This field sets the capability of the NumLock light/key to display/activate the system. Configuration options: [On] [Off]

Gate A20 Option [Fast]

This field sets the gate A20 rate. The default is [Fast]. Configuration options: [Normal] [Fast]

Typematic Rate Setting [Disabled]

This field enables or disable permission to change the rate of keystroke registration and display. By default, the rate cannot be changed. Change to [Enabled] to make settings in the next field. Configuration options: [Enabled] [Disabled]

APIC Mode [Enabled]

This field enables or disables the APIC mode. Configuration options: [Enabled] [Disabled]

OS/2 Onboard Memory > 64MB [Disabled]

This field enables or disables the 64MB onboard memory set for OS/2. Configuration options: [Disabled] [Enabled]

2.4.2 Advanced Chipset Features

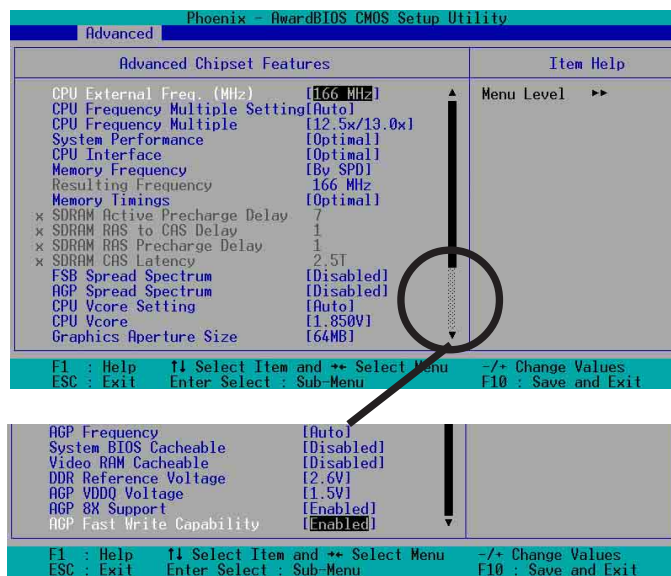

(Scroll down to view all items on the menu.)

CPU External Frequency (MHz) [100MHz]

This field sets the external frequency ratio of the CPU. The system normally auto-detects the frequency capability based on the type of CPU installed. The Front Side Bus (FSB) is equal to 2 times this field value. Frequency ranges are adjustable in increments of 1, 2, 3 and/or 5 MHz. Configuration options: [100 MHz]... [200 MHz] [204 MHz] [207 MHz] [211 MHz] [300 MHz]

CPU Frequency Multiple Setting [Auto]

This field sets the frequency multiple between the CPU's internal frequency (CPU speed) and external frequency. Set this field in conjunction with CPU Frequency (MHz) to match the speed of the CPU.

CPU Frequency Multiple [5.0x]

This field is available to unlocked processors only. For unlocked processors, this field sets the frequency multiple between the CPU's *internal* frequency (CPU speed) and the *external* frequency.

Configuration options: [5.0x] [5.5x]... ..[11.5] [12.0] [12.5x/13.0x]

System Performance [Optimal]

This field permits change of mode for system performance. When set to [Optimal], the system uses the most stable settings. When you want to use overclocked settings for higher performance but with higher risk of instability, set to [Aggressive] and to allow full customization of performance options set to [User Defined]. Configuration options: [Optimal] [Aggressive] [User Defined]

CPU Interface [Optimal]

This field sets the mode for CPU/FSB parameters usage. Select [Aggressive] if you want to use overclocked CPU/FSB parameters. Otherwise, the default value is [Optimal] where it uses the most stable CPU/FSB parameters. Configuration options: [Optimal] [Aggressive]

Memory Frequency [By SPD]

This field sets the type of memory frequency based on the type of DDR (Double Date Rate) memory module installed. Resulting frequency can vary depending on percentage setting which is multiplied by the FSB frrequency. Normally, the default, by SPD, permits autodetection. Configuration options: [By SPD] [50%] [60%] [66%] [75%] [80%] [83%] [Sync] [120%] [125%] [133%] [150%] [166%] [200%]

Resulting Frequency

This field displays the resulting memory frequency.

Memory Timing [Optimal]

This field permits change of memory timing mode for system performance. When set to [User Defined], the next four fields can be set manually. Set to [Aggressive] for higher performance. Use default [Optimal] to use most stable settings. Configuration options: [Optimal] [Aggressive] [User Defined]

SDRAM Active Precharge Delay [7]

Row-active delay.

SDRAM RAS to CAS Delay [1]

RAS-to-CAS. This item controls the latency between the SDRAM Active command to the SDRAM.

SDRAM RAS Precharge Delay [1]

Row-precharge delay.

SDRAM CAS Latency [2.5T]

This field sets the override clock cycle for the latency time between the SDRAM read command and the moment that the data actually becomes available. Normally, the system determines the rate automatically by default.

FSB Spread Spectrum [Disabled]

Configuration options: [Disabled] [0.50%] [1.00%]

AGP Spread Spectrum [Disabled]

Configuration options: [Disabled] [0.50%] [1.00%]

CPU Vcore Setting [Auto]

This field determines if the CPU Vcore is automatically scaled or set manually by the user. The default value is [Auto], therefore, the CPU vcore voltage is set for maximum performance without stressing the CPU. Configuration options: [Auto] [Menu]

CPU Vcore [1.850V]

When the CPU VCore Setting parameter is set to [Manual], this field permits selection of specific CPU core voltages. This field is not accessible if the above *CPU VCore Setting* parameter is set to [Auto].

Configuration options: [1.100V] [1.125V] ... [1.825] [1.850V]



The configuration option range varies from CPU's with different clock speed.

Graphics Aperture Size [64M]

This field sets the size of mapped memory (in megabytes) for AGP graphic data.

Configuration options: [32M] [64M] [128M] [256M] [512M]

AGP Frequency [Auto]

This field sets the frequency of the AGP controller. The default, [Auto], permits automatic selection of optimal AGP frequencies. Configuration options: [50, 66, 67, 68, 69, 70, 71, 72, 73, 74, 75, 76, 77, 78, 79, 80, 81, 82, 83, 84, 85, 86, 87, 90, 93, 95, 97, 100MHz]

System BIOS Cacheable [Disabled]

This field establishes whether or not the BIOS is cacheable. Disabled by default.

Configuration options: [Enabled] [Disabled]

Video RAM Cacheable [Disabled]

This field establishes whether or not the video RAM is cacheable. Disabled by default.
Configuration options: [Enabled] [Disabled]

DDR Reference Voltage [2.6V]

This field sets the voltage limits for the voltage supplied to the DDR memory. Note that increasing voltage to the DDR can cause premature failure of system components.
Configuration options: [2.6V] [2.7V] [2.8V]

AGP VDDQ Voltage [1.5V]

This field sets the voltage limits for the voltage supplied to the AGP controller. Note that increasing voltage to the AGP controller can cause premature failure of system components.
Configuration options: [1.5V] [1.6V] [1.7V]

AGP 8X Support [Enabled]

This field enables or disables the AGP 8X support.
Configuration options: [Disable] [Enable]

AGP Fast Write Capability [Enabled]

This field enables or disables the AGP Fastwrite function.
Configuration options: [Disable] [Enable]

2.4.3 Integrated Peripherals

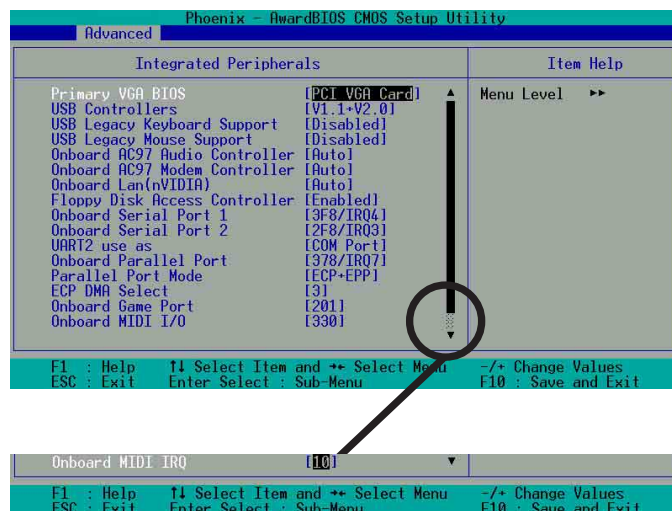

(Scroll down to view all items on the menu.)

Primary VGA BIOS [PCI VGA Card]

This field sets the priority for the display of VGA signals. Change from the PCI VGA Cardt default to AGP VGA Card if using an AGP card.
Configuration options: [PCI VGA Card] [AGP VGA Card]

USB Controllers [V1.1+V2.0]

This field sets the protocols for OnChip processing of USB outputs. The default accomodates USB protocols 1.0 and 2.0.

Configuration options: [Disabled] [V1.1 +V2.0] [V1.1]

USB Legacy Keyboard Support [Disabled]

This field sets support for USB keyboards. The USB keyboard is disabled by default. Enable this field to use a USB keyboard. Configuration options: [Enabled] [Disabled]

USB Legacy Mouse Support [Disabled]

This field sets support for USB keyboards. The USB keyboard is disabled by default. Enable this field to use a USB keyboard. Configuration options: [Enabled] [Disabled]

Onboard AC97 Audio Controller [Auto]

This field permits auto selection of AC97 audio codec processing by default. Configuration options: [Auto] [Disabled]

Onboard AC97 Modem Controller [Auto]

This field permits auto selection of AC97 modem support by default. Configuration options: [Auto] [Disabled]

Onboard Lan (nVIDIA) [Auto]

This field permits auto selection of MAC Lan (nVidia) support by default. Configuration options: [Auto] [Disabled]

Floppy Disk Access Controller [Enabled]

This field enables the FDA Controller by default. Configuration options: [Enabled] [Disabled]

Onboard Serial Port 1 [3F8/IRQ4]

These fields set the addresses for onboard serial port 1. Serial Port 1 and Serial Port 2 must have different addresses. Configuration options: [Disabled] [3F8/IRQ4] [2F8/IRQ3] [3E8/IRQ4] [2E8/IRQ3] [Auto]

Onboard Serial Port 2 [2F8/IRQ3]

These fields set the addresses for onboard serial port 2. Serial Port 1 and Serial Port 2 must have different addresses. Configuration options: [Disabled] [3F8/IRQ4] [2F8/IRQ3] [3E8/IRQ4] [2E8/IRQ3] [Auto]

UART use as [COM Port]

This field selects the device assignment for UART2 mode. The default is [COM Port]. Select [IR] to activate the next field, "UR2 Duplex Mode".

Configuration options: [IR] [COM Port]

Onboard Parallel Port [378/IRQ7]

This field sets the address of the onboard parallel port connector to 378/IRQ7 by default. Disabling the port makes the parallel port unavailable. Configuration options: [Disabled] [378/IRQ7] [278/IRQ5] [3BC/IRQ7]

Parallel Port Mode [SPP]

This field sets the operation mode of the parallel port. The default, SPP, enables normal-speed operation but in one direction only; EPP enables bidirectional parallel port operation; ECP enables the parallel port to operate in bidirectional DMA mode; ECP+EPP enables normal speed operation in a both ECP and EPP modes. Select [ECP] to access the next field, "ECP Mode Use DMA". Configuration options: [SPP] [EPP] [ECP] [ECP +EPP]

ECP DMA Select [3]

This field sets the parallel port DMA channel for the selected ECP mode. The default setting is 3. This selection is available only if you select [ECP] or [ECP+EPP] in Parallel Port Mode above. Configuration options: [1] [3]

Onboard Game Port [201]

This field sets the address of the game port to 201 by default. Disabling the game port makes the port unavailable. Configuration options: [Disabled] [201] [209]

Onboard MIDI I/O [330]

This field sets the address of the MIDI I/O port to 330 by default. Configuration options: [Disabled] [330] [300]

Onboard MIDI IRQ [5]

This field sets the address of the MIDI IRQ. Configuration options: [5] [10]

2.4.4 Power Management Setup

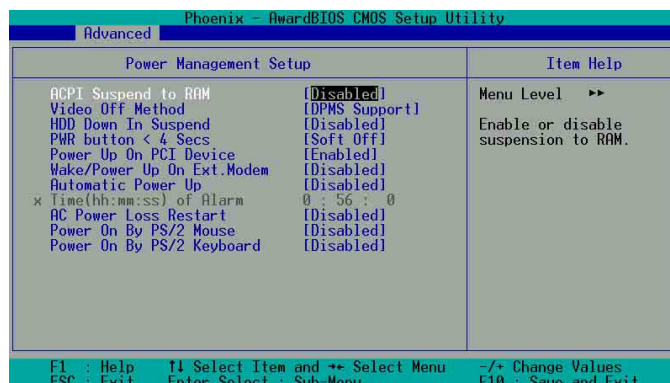

ACPI Suspend to RAM [Disabled]

This field enables or disables suspension to RAM. Configuration options: [Enabled] [Disabled]

Video Off Method [DPMS Support]

This field defines “video off” features. The DPMS support option (Display Power Management System) permits the BIOS to control the video display card if it supports the DPMS feature. Blank Screen option blanks the screen; use blank screen for monitors without power management or “green” features. [V/H SYNC+Blank] blanks the screen and turns off vertical and horizontal scanning. Configuration options: [Blank Screen] [V/H SYNC+Blank] [DPMS Support]

HDD Down In Suspend [Disabled]

This field sets whether or not the HDD is automatically shut down in suspend mode. The default disables power to the HDD in suspend mode. Configuration options: [Enabled] [Disabled]

PWR button < 4 Secs [Suspend]

This field sets the delay after which the system powers off after depressing the external case-mounted power button. The default setting powers off the system instantly. Configuration options: [Soft-Off] [Suspend]

Power Up on PCI Device [Enabled]

This field enables Wake-On-LAN from soft-off mode. The default disables this option. Configuration options: [Enabled] [Disabled]

Wake-Power Up On Ext. Modem [Disabled]

This field allows either settings of [Enabled] or [Disabled] for powering up the computer when the external modem receives a call while the computer is in Soft-off mode. Configuration options: [Enabled] [Disabled]

Automatic Power Up [Disabled]

This field sets to enable or disable the automatic power up. When [Enabled] the **Time (hh:mm:ss) of Alarm** field is enabled for input. Configuration options: [Enabled] [Disabled]

Time (hh:mm:ss) of Alarm 0:00:00

This field sets the time for automatic power up. Enter the hour, minute and second based on the 24 hour clock. The Automatic Power Up field must be enabled to use this feature.

AC Power Loss Restart [Disabled]

This allows you to set whether or not to reboot the system after power interruptions. [Disabled] leaves your system off while [Enabled] reboots the system. [Previous State] sets the system back to the state it was before the power interruption. Configuration options: [Disabled] [Enabled] [Previous State]

Power On By PS/2 Mouse [Disabled]

When set to [Enabled], this parameter allows you to use the PS/2 mouse to turn on the system. This feature requires an ATX power supply that provides at least 1A on the +5VSB lead. Configuration options: [Disabled] [Enabled]

Power On By PS/2 Keyboard [Disabled]

This parameter allows you to use specific keys on the keyboard to turn on the system. This feature requires an ATX power supply that provides at least 1A on the +5VSB lead. Configuration options: [Disabled] [Any KEY] [Power Key]

2.4.5 PnP / PCI Configurations

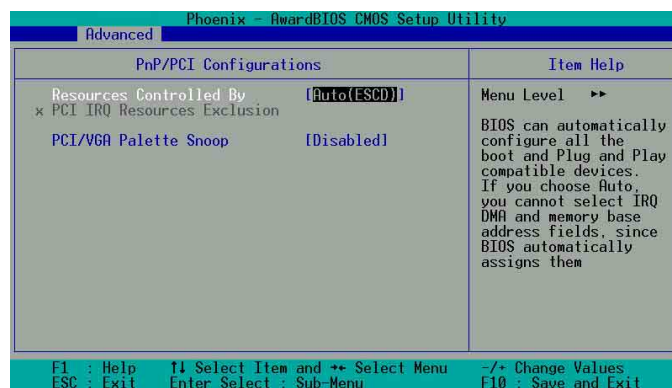

Resources Controlled By [Auto(ESCD)]

This field sets control over the IRQ resources by the automatic (ESCD) system or manual assignment of IRQ channels. The default enables automatic (ESCD) control. Configuration options: [Auto(ESCD)] [Manual].

PCI/VGA Palette Snoop [Disabled]

This field enables the PCI/VGA palette snoop. This feature is disabled by default. Configuration options: [Enabled] [Disabled]

2.5 Security Menu

The BIOS Setup program permits two different passwords to control access to the BIOS during system startup: a Supervisor password and a User password. Passwords are not case sensitive, meaning, passwords can be typed in either uppercase or lowercase letters. The table below describes the authority level when setting Supervisor or User Password.

TABLE 2.5.1 Supervisor/User Set Password

Security Option	Supervisor Password	User Password
System	A password is required for booting and entering into the CMOS setup and all items can be modified.	A password is required for booting and entering into the CMOS setup and only "Date" and "Time" could be modified. All other items in the CMOS are displayed only.
Setup	A password is required to enter into the CMOS and items can be modified.	A password is required to enter into the CMOS and only "Date" and "Time" could be modified. All other items in the CMOS are displayed only.

TABLE 4.5.2 User Set Password only

Security Option	Supervisor Password	User Password
System	None	A password is required for booting and entering into the CMOS setup and all items can be modified.
Setup	None	A password is required to enter into the CMOS setup and all items can be modified.

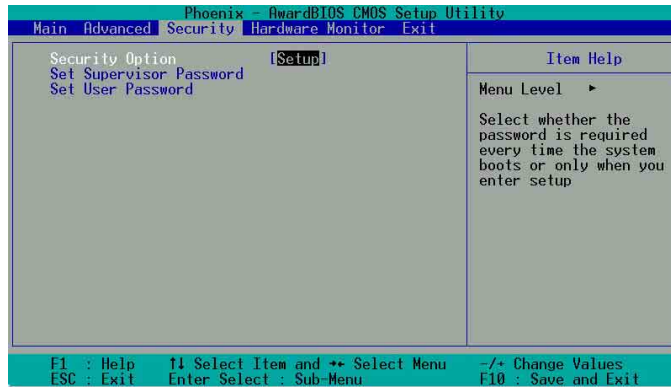

Security Option [Setup]

This field sets the security options. The default enables the setup option for security. Configuration options: [Setup] [System]

Set Supervisor Password / Set User Password

To set a password, highlight the appropriate field and press <Enter>. Type in a password then press <Enter>. You can type up to eight alphanumeric characters; symbols and other characters are not useable. To confirm the password, type the password again and press <Enter>. The password is now set to [Enabled]. This password permits full access to the BIOS Setup menus. To clear the password, highlight this field and press <Enter>. The same dialog box as above appears. Press <Enter>. The password is set to [Disabled].

Forgot the password?

If you forget a password, you can clear it by erasing the CMOS Real Time Clock (RTC) RAM. The RAM data containing the password information is powered by the onboard button cell battery.

NOTE: See section “1.9 Jumpers” for more information about how to erase the RTC RAM.

2.6 Hardware Monitor Menu

The Hardware Monitor menu displays all vital system statistics.

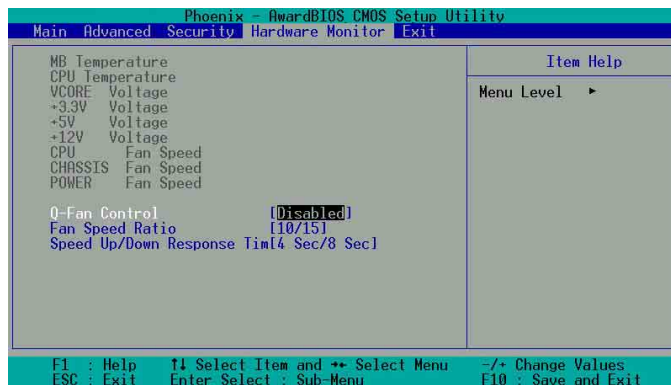

MB, CPU Temperature [xx C / xx F]

The onboard hardware monitor automatically detects the MB (motherboard) and CPU temperatures.

VCORE Voltage, +3.3V Voltage, +5V Voltage, +12V Voltage

The onboard hardware monitor automatically detects the voltage output through the voltage regulators.

CPU Fan Speed xxxx RPM or 0 RPM

CHASSIS Fan Speed xxxx RPM or 0 RPM

POWER Fan Speed xxxx RPM or 0 RPM

The onboard hardware monitor automatically detects the CPU, power and chassis fan speeds and displays the fan speeds in revolutions per minute (RPM). If any of the fans is not connected to the fan connectors on the motherboard, the specific field will show N/A.

Q-Fan Control [Disabled]

This field allows you to enable or disable the ASUS Q-Fan feature that smartly adjusts the fan speeds for more efficient system operation. When this field is set to [Enabled], set the appropriate **Fan Speed Ratio** and **Speed Up/Down Response Time**. Configuration options: [Disabled] [Enabled]

Fan Speed Ratio [10/15]

This item allows you to select the appropriate fan speed ratio for the system. The default [10/15] is the minimum fan speed ratio. Select a higher ratio if you installed additional devices and the system requires more ventilation. This item is required to be set when the Q-Fan Control field is [Enabled]. Configuration options: [10/15] [11/15] [12/15] [13/15] [14/15] [Full Speed].

Speed Up/Down Response Time [4 Sec/8 Sec]

This item indicates the time period before the fan speeds adjust to the value set in the **Fan Speed Ratio** field. This item is required to be set when the Q-Fan Control field is [Enabled]. Configuration options: [1 Sec/2 Sec] [2 Sec/4 Sec] [3 Sec/6 Sec] [4 Sec/8 Sec]

2.7 Exit Menu

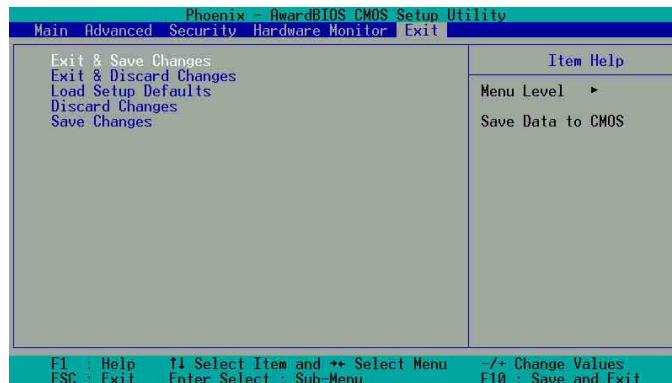

Exit & Save Changes

Choose this option from the Exit menu to ensure the selected values are saved to the CMOS RAM. When selecting this option, a confirmation window appears. Select [Yes] to save changes and exit. The CMOS RAM is sustained by an onboard backup battery and stays on even when the PC is turned off.



If attempting to exit the Setup program without saving changes, the program prompts with a message asking if you want to save your changes before exiting. Pressing <Enter> saves the changes while exiting.

Exit & Discard Changes

Select this option only if you do not want to save the changes that you made to the Setup program. If you made changes to fields other than system date, system time, and password, the BIOS asks for a confirmation before exiting.

Load Setup Defaults

This option allows you to load the default values for each of the parameters on the Setup menus. When you select this option, a confirmation window appears. Select [Yes] to load default values. Select Exit Saving Changes or make other changes before saving the values to the non-volatile RAM.

Discard Changes

This option allows you to discard the selections you made and restore the previously saved values. After selecting this option, a confirmation appears. Select [Yes] to discard any changes and load the previously saved values.

Save Changes

This option saves your selections without exiting the Setup program. You can then return to other menus and make further changes. After you select this option, a confirmation window appears. Select [Yes] to save any changes to the non-volatile RAM.

Chapter 3

This chapter helps you power up your system and install drivers and utilities that came with the support CD.

Starting Up

3.1 Install an operating system

This motherboard supports Windows 98SE/ME/NT/2000/XP operating system (OS). Always install the latest OS version and corresponding updates so you can maximize the features of your hardware.

Because motherboard settings and hardware options vary, use the setup procedures presented in this chapter for general reference only. Refer to your OS documentation for more information.

3.2 Support CD information

The support CD that came with the motherboard contains useful software and several utility drivers that enhance the motherboard features.



The contents of the support CD are subject to change at any time without notice. Visit the ASUS website for updates.

3.2.1 Running the support CD

To begin using the support CD, simply insert the CD into your CD-ROM drive. The CD automatically displays the **Drivers** menu if Autorun is enabled in your computer.

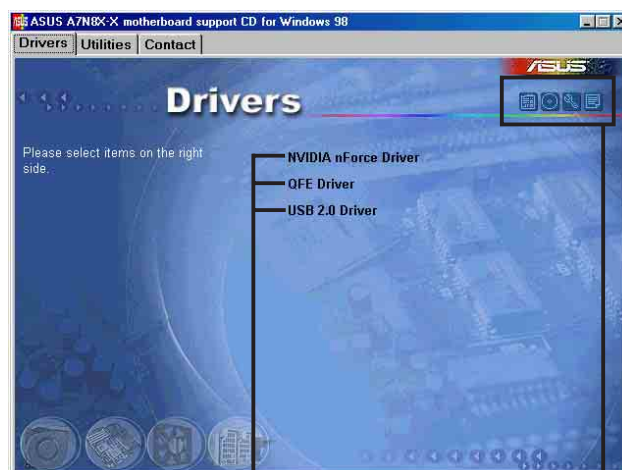

Click an item to install

Click an icon to display more information



If **Autorun** is NOT enabled in your computer, browse the contents of the support CD to locate the file **ASSETUP.EXE** from the BIN folder. Double-click the **ASSETUP.EXE** to run the CD.

3.2.2 Drivers menu

The drivers menu shows the available device drivers if the system detects installed devices. Install the necessary drivers to activate the devices.

NVIDIA nForce Driver

This item installs the NVIDIA nForce set of drivers.

QFE Drivers

Click this item to load the installation wizard and install the Win98 QFE drivers.

USB 2.0 Driver

This item installs the Universal Serial Bus 2.0 (USB 2.0) driver.



Some menu items appear only to specific operating system versions.

3.2.3 Utilities menu

The Utilities menu shows the applications and other software that the motherboard supports.

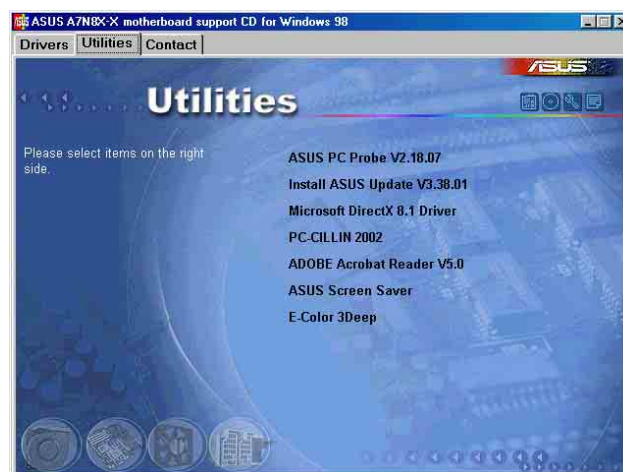

ASUS PC Probe

Install utility that can monitor Fan, Speed, Voltage, and CPU temperature.

ASUS Update

Installs utility to download and update motherboard BIOS & drivers.

Microsoft DirectX 8.1 Driver

This item installs the Microsoft V8.1 driver.

PC-CILLIN 2002

This item installs the PC-cillin 2002 anti-virus software.

ADOBE Acrobat Reader V5.0

This installs software for viewing files in Portable Document Format (PDF).

ASUS Screen Saver

This item installs the ASUS screen saver.

E-Color 3Deep

This item installs application to optimize 3D graphics output.

3.2.4 ASUS Contact Information

Clicking the ASUS Contact Information tab displays as stated. You may also find this information on page viii of this user guide.

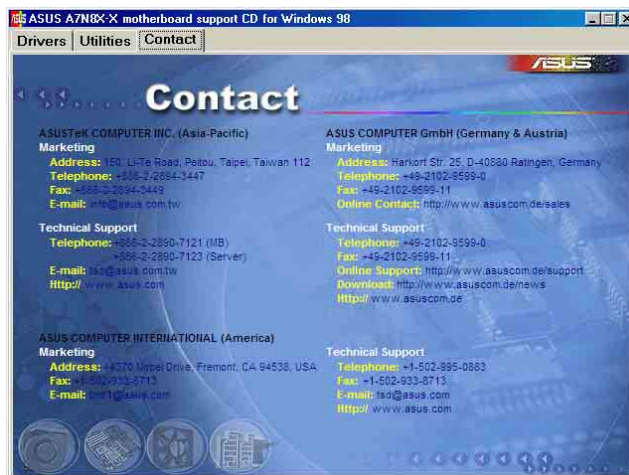

Free Manuals Download Website

<http://myh66.com>

<http://usermanuals.us>

<http://www.somanuals.com>

<http://www.4manuals.cc>

<http://www.manual-lib.com>

<http://www.404manual.com>

<http://www.luxmanual.com>

<http://aubethermostatmanual.com>

Golf course search by state

<http://golfingnear.com>

Email search by domain

<http://emailbydomain.com>

Auto manuals search

<http://auto.somanuals.com>

TV manuals search

<http://tv.somanuals.com>