

M2A-MVP



Motherboard

E2910

First Edition V1
November 2006

Copyright © 2006 ASUSTeK COMPUTER INC. All Rights Reserved.

No part of this manual, including the products and software described in it, may be reproduced, transmitted, transcribed, stored in a retrieval system, or translated into any language in any form or by any means, except documentation kept by the purchaser for backup purposes, without the express written permission of ASUSTeK COMPUTER INC. ("ASUS").

Product warranty or service will not be extended if: (1) the product is repaired, modified or altered, unless such repair, modification of alteration is authorized in writing by ASUS; or (2) the serial number of the product is defaced or missing.

ASUS PROVIDES THIS MANUAL "AS IS" WITHOUT WARRANTY OF ANY KIND, EITHER EXPRESS OR IMPLIED, INCLUDING BUT NOT LIMITED TO THE IMPLIED WARRANTIES OR CONDITIONS OF MERCHANTABILITY OR FITNESS FOR A PARTICULAR PURPOSE. IN NO EVENT SHALL ASUS, ITS DIRECTORS, OFFICERS, EMPLOYEES OR AGENTS BE LIABLE FOR ANY INDIRECT, SPECIAL, INCIDENTAL, OR CONSEQUENTIAL DAMAGES (INCLUDING DAMAGES FOR LOSS OF PROFITS, LOSS OF BUSINESS, LOSS OF USE OR DATA, INTERRUPTION OF BUSINESS AND THE LIKE), EVEN IF ASUS HAS BEEN ADVISED OF THE POSSIBILITY OF SUCH DAMAGES ARISING FROM ANY DEFECT OR ERROR IN THIS MANUAL OR PRODUCT.

SPECIFICATIONS AND INFORMATION CONTAINED IN THIS MANUAL ARE FURNISHED FOR INFORMATIONAL USE ONLY, AND ARE SUBJECT TO CHANGE AT ANY TIME WITHOUT NOTICE, AND SHOULD NOT BE CONSTRUED AS A COMMITMENT BY ASUS. ASUS ASSUMES NO RESPONSIBILITY OR LIABILITY FOR ANY ERRORS OR INACCURACIES THAT MAY APPEAR IN THIS MANUAL, INCLUDING THE PRODUCTS AND SOFTWARE DESCRIBED IN IT.

Products and corporate names appearing in this manual may or may not be registered trademarks or copyrights of their respective companies, and are used only for identification or explanation and to the owners' benefit, without intent to infringe.

Contents

Notices.....	vi
Safety information	vii
M2A-MVP specifications summary	x

Chapter 1: Product introduction

1.1	Welcome!	1-2
1.2	Package contents	1-2
1.3	Special features	1-2
	1.3.1 Product highlights	1-2
	1.3.2 ASUS features	1-5
1.4	Before you proceed	1-6
1.5	Motherboard overview	1-7
	1.5.1 Placement direction	1-7
	1.5.2 Screw holes	1-7
	1.5.3 Motherboard layout.....	1-8
1.6	Central Processing Unit (CPU)	1-9
	1.6.1 Installing the CPU	1-9
	1.6.2 Installing the CPU heatsink and fan.....	1-11
1.7	System memory	1-14
	1.7.1 Overview	1-14
	1.7.2 Memory configurations.....	1-15
	1.7.3 Installing a DIMM	1-19
	1.7.4 Removing a DIMM	1-19
1.8	Expansion slots	1-20
	1.8.1 Installing an expansion card	1-20
	1.8.2 Configuring an expansion card	1-20
	1.8.3 Interrupt assignments	1-21
	1.8.4 Two PCI slots	1-22
	1.8.5 Two PCI Express x1 slot.....	1-22
	1.8.6 Two PCI Express x16 slot.....	1-22
1.9	Jumpers	1-24
1.10	Connectors	1-26
	1.10.1 Rear panel connectors.....	1-26
	1.10.2 Internal connectors	1-28

Contents

Chapter 2: BIOS setup

2.1	Managing and updating your BIOS	2-2
2.1.1	Creating a bootable floppy disk.....	2-2
2.1.2	ASUS EZ Flash 2 utility.....	2-3
2.1.3	AFUDOS utility.....	2-4
2.1.4	ASUS CrashFree BIOS 3 utility	2-6
2.1.5	ASUS Update utility	2-8
2.2	BIOS setup program	2-11
2.2.1	BIOS menu screen.....	2-12
2.2.2	Menu bar.....	2-12
2.2.3	Navigation keys.....	2-12
2.2.4	Menu items	2-13
2.2.5	Sub-menu items.....	2-13
2.2.6	Configuration fields	2-13
2.2.7	Pop-up window	2-13
2.2.8	Scroll bar.....	2-13
2.2.9	General help	2-13
2.3	Main menu	2-14
2.3.1	System Time	2-14
2.3.2	System Date	2-14
2.3.3	Legacy Diskette A	2-14
2.3.4	Primary IDE Master/Slave; SATA1-4.....	2-15
2.3.5	Storage Configuration.....	2-16
2.3.6	System Information	2-17
2.4	Advanced menu	2-18
2.4.1	Jumperfree Configuration	2-18
2.4.2	CPU Configuration	2-20
2.4.3	Chipset.....	2-23
2.4.4	Onboard Devices Configuration.....	2-25
2.4.5	PCI PnP	2-26
2.4.6	USB Configuration	2-27
2.5	Power menu.....	2-29
2.5.1	Suspend Mode [Auto]	2-29
2.5.2	Repost Video on S3 Resume [No].....	2-29

Contents

2.5.3	ACPI Version Features [ACPI v1.0]	2-29
2.5.4	ACPI APIC support [Enabled]	2-29
2.5.5	APM Configuraiton	2-30
2.5.6	Hardware Monitor	2-31
2.6	Boot menu	2-33
2.6.1	Boot Device Priority	2-33
2.6.2	Boot Settings Configuration	2-33
2.6.3	Security	2-34
2.7	Tools menu	2-36
2.7.1	ASUS EZ Flash 2	2-37
2.7.2	ASUS O.C. Profile	2-37
2.8	Exit menu	2-39
2.9	RAID configurations	2-40
2.9.1	Installing hard disks	2-41
2.9.2	ULI® RAID configurations	2-41
2.10	Creating a RAID driver disk	2-49

Chapter 3: Software support

3.1	Installing an operating system	3-2
3.2	Support CD information	3-2
3.2.1	Running the support CD	3-2
3.2.2	Drivers menu	3-3
3.2.3	Utilities menu	3-4
3.2.4	Make disk menu	3-5
3.2.5	Manuals menu	3-6
3.2.6	ASUS Contact information	3-6
3.2.7	Other information	3-7

Notices

Federal Communications Commission Statement

This device complies with Part 15 of the FCC Rules. Operation is subject to the following two conditions:

- This device may not cause harmful interference, and
- This device must accept any interference received including interference that may cause undesired operation.

This equipment has been tested and found to comply with the limits for a Class B digital device, pursuant to Part 15 of the FCC Rules. These limits are designed to provide reasonable protection against harmful interference in a residential installation. This equipment generates, uses and can radiate radio frequency energy and, if not installed and used in accordance with manufacturer's instructions, may cause harmful interference to radio communications. However, there is no guarantee that interference will not occur in a particular installation. If this equipment does cause harmful interference to radio or television reception, which can be determined by turning the equipment off and on, the user is encouraged to try to correct the interference by one or more of the following measures:

- Reorient or relocate the receiving antenna.
- Increase the separation between the equipment and receiver.
- Connect the equipment to an outlet on a circuit different from that to which the receiver is connected.
- Consult the dealer or an experienced radio/TV technician for help.



The use of shielded cables for connection of the monitor to the graphics card is required to assure compliance with FCC regulations. Changes or modifications to this unit not expressly approved by the party responsible for compliance could void the user's authority to operate this equipment.

Canadian Department of Communications Statement

This digital apparatus does not exceed the Class B limits for radio noise emissions from digital apparatus set out in the Radio Interference Regulations of the Canadian Department of Communications.

This class B digital apparatus complies with Canadian ICES-003.

Safety information

Electrical safety

- To prevent electrical shock hazard, disconnect the power cable from the electrical outlet before relocating the system.
- When adding or removing devices to or from the system, ensure that the power cables for the devices are unplugged before the signal cables are connected. If possible, disconnect all power cables from the existing system before you add a device.
- Before connecting or removing signal cables from the motherboard, ensure that all power cables are unplugged.
- Seek professional assistance before using an adapter or extension cord. These devices could interrupt the grounding circuit.
- Make sure that your power supply is set to the correct voltage in your area. If you are not sure about the voltage of the electrical outlet you are using, contact your local power company.
- If the power supply is broken, do not try to fix it by yourself. Contact a qualified service technician or your retailer.

Operation safety

- Before installing the motherboard and adding devices on it, carefully read all the manuals that came with the package.
- Before using the product, make sure all cables are correctly connected and the power cables are not damaged. If you detect any damage, contact your dealer immediately.
- To avoid short circuits, keep paper clips, screws, and staples away from connectors, slots, sockets and circuitry.
- Avoid dust, humidity, and temperature extremes. Do not place the product in any area where it may become wet.
- Place the product on a stable surface.
- If you encounter technical problems with the product, contact a qualified service technician or your retailer.



This symbol of the crossed out wheeled bin indicates that the product (electrical and electronic equipment) should not be placed in municipal waste. Check local regulations for disposal of electronic products.

About this guide

This user guide contains the information you need when installing and configuring the motherboard.

How this guide is organized

This manual contains the following parts:

- **Chapter 1: Product introduction**
This chapter describes the features of the motherboard and the new technology it supports. It also lists the hardware setup procedures that you have to perform when installing system components. It includes description of the jumpers and connectors on the motherboard.
- **Chapter 2: BIOS setup**
This chapter tells how to change system settings through the BIOS Setup menus. Detailed descriptions of the BIOS parameters are also provided.
- **Chapter 3: Software support**
This chapter describes the contents of the support CD that comes with the motherboard package.

Where to find more information

Refer to the following sources for additional information and for product and software updates.

1. **ASUS websites**
The ASUS website provides updated information on ASUS hardware and software products. Refer to the ASUS contact information.
2. **Optional documentation**
Your product package may include optional documentation, such as warranty flyers, that may have been added by your dealer. These documents are not part of the standard package.

Conventions used in this guide

To make sure that you perform certain tasks properly, take note of the following symbols used throughout this manual.



DANGER/WARNING: Information to prevent injury to yourself when trying to complete a task.



CAUTION: Information to prevent damage to the components when trying to complete a task.



IMPORTANT: Instructions that you **MUST** follow to complete a task.



NOTE: Tips and additional information to help you complete a task.

Typography

Bold text

Indicates a menu or an item to select.

Italics

Used to emphasize a word or a phrase.

<Key>

Keys enclosed in the less-than and greater-than sign means that you must press the enclosed key.

Example: <Enter> means that you must press the Enter or Return key.

<Key1>+<Key2>+<Key3> If you must press two or more keys simultaneously, the key names are linked with a plus sign (+).

Example: <Ctrl+Alt+D>

Command

Means that you must type the command exactly as shown, then supply the required item or value enclosed in brackets.

Example: At the DOS prompt, type the command line:

```
afudos /i [filename]
```

```
afudos /iM2A-MVP.ROM
```

M2A-MVP specifications summary

CPU	Socket AM2 for AMD® Athlon™ 64 X2 / Athlon™ 64 FX Athlon™ 64 / Sempron™ processor AMD64 architecture enables simultaneous 32- and 64-bit computing AMD Cool 'n' Quiet™ Technology AMD Live!™ Ready
Chipset	AMD 480X CrossFire™ Chipset/ SB600
System bus	2000/1600 MT/s
Memory	Dual-channel memory architecture 4 x 240-pin DIMM sockets support up to 8 GB unbuffered ECC/non-ECC 800/667/533 MHz DDR2 memory modules
Expansion slots	2 x PCI Express™ x16 slots for discrete graphics card 2 x PCI Express™ x1 slots 2 x PCI slots
CrossFire	Supports ATI™ CrossFire™ graphics cards (both @ x8 mode)
Storage/RAID	AMD™ SB600 Southbridge supports: <ul style="list-style-type: none"> - 1 x IDE connector for two Ultra DMA 133/100/66/33 hard disks - 4 x Serial ATA 3.0 Gb/s hard disks with RAID 0,1, and 0+1 configuration
Audio	Realtek® High Definition Audio with 6-channel CODEC Coaxial S/PDIF Out port on the rear panel
LAN	Marvell® 88E8001 Gigabit PCI LAN controller
IEEE 1394	VIA 6308P 1394a controller supports: <ul style="list-style-type: none"> - 1 x IEEE 1394a connector at mid-board - 1 x IEEE 1394a connector at rear-board
USB 2.0	Supports up to 10 USB 2.0/1.1 ports
ASUS special features	ASUS CrashFree BIOS 3 ASUS EZ Flash 2 ASUS O.C. Profile ASUS MyLogo ASUS Q-Fan2 ASUS C.P.R.

(continued on the next page)

M2A-MVP specifications summary

Back panel I/O ports	<ul style="list-style-type: none"> 1 x PS/2 mouse port 1 x PS/2 keyboard port 1 x LAN (RJ-45) port 4 x USB 2.0/1.1 ports 1 x IEEE1394a port 1 x Coaxial S/PDIF Out port 1 x Parallel port 1 x Serial (COM) port 6-Channel High Definition audio I/O
Internal I/O connectors	<ul style="list-style-type: none"> 3 x USB 2.0 connectors support additional 6 USB ports 1 x Floppy disk drive connector 1 x IDE connector 4 x Serial ATA 3.0 Gb/s connectors 1 x CPU fan connector 1 x Chassis fan connector 1 x Power fan connector 1 x IEEE1394a connector 1 x S/PDIF Out connector Front panel High Definition audio connector Chassis intrusion connector CD audio in connector 24-pin ATX Power connector 4-pin ATX 12 V Power connector System panel connector
BIOS features	8 Mb Flash ROM, AMI BIOS, PnP, DMI2.0, WfM2.0
Manageability	WfM 2.0, DMI 2.0, WOL by PME, WOR by PME, and PXE Chassis Intrusion
Support CD	<ul style="list-style-type: none"> Drivers ASUS PC Probe II ASUS Live Update Utility Anti-virus software (OEM version)
Form factor	ATX form factor: 12 in x 8.6 in (30.5 cm x 21.8 cm)

*Specifications are subject to change without notice.

This chapter describes the motherboard features and the new technologies it supports.

1 Product introduction

1.1 Welcome!

Thank you for buying an ASUS® M2A-MVP motherboard!

The motherboard delivers a host of new features and latest technologies, making it another standout in the long line of ASUS quality motherboards!

Before you start installing the motherboard, and hardware devices on it, check the items in your package with the list below.

1.2 Package contents

Check your motherboard package for the following items.

Motherboard	ASUS M2A-MVP
Cables	1 x Serial ATA cable 1 x 2-port Serial ATA power cable 1 x Ultra DMA 133/100/66 cable 1 x Floppy disk drive signal cable
Accessories	I/O shield 1 x MVP-Switch card
Application CD	ASUS motherboard support CD
Documentation	User guide



If any of the above items is damaged or missing, contact your retailer.

1.3 Special features

1.3.1 Product highlights



Latest processor technology

The motherboard supports AMD socket AM2 single-core Athlon 64/ Sempron and dual-core Athlon 64 X2/Athlon 64 FX processors with 2MB/1MB/512KB L2 cache, which is based on 64-bit architecture. It features 2000/1600 MT/s HyperTransport Bus, dual-channel un-buffered DDR2 800 memory support and AMD Cool 'n' Quiet Technology. See page 1-9 for details.

AMD Cool 'n' Quiet Technology

The motherboard supports the AMD Cool 'n' Quiet Technology, which monitors system operation and automatically adjusts CPU voltage and frequency for a cool and quiet operating environment. See page 2-20 for details.

Dual-Core CPU



Enjoy the extraordinary CPU power from the latest dual-core CPU. The advanced processing technology contains two physical CPU cores with individually dedicated L2 cache to satisfy the rising demand for more powerful processing capability.

Dual Channel DDR2 800



DDR2 is the next generation memory technology to replace the current DDR. With the highest speed up to 800 MHz, DDR2 memory provides great performance for 3D graphics and other memory demanding applications. See page 1-14 for details.

PCI Express™ Architecture



PCI Express is the latest I/O interconnect technology that will replace the existing PCI. With a bus bandwidth 4 times higher than that of AGP 8X interface, PCI Express x16 bus performs much better than AGP 8X in applications such as 3D gaming. PCI Express x1 also outperforms PCI interface with its exceptional high bandwidth. See page 1-21 for details.

Serial ATA 3.0 Gb/s technology



This motherboard supports the next-generation hard drives based on the Serial ATA (SATA) 3Gb/s storage specification. The onboard NVIDIA® nForce 430 MCP southbridge allows RAID 0, RAID 1, RAID 0+1, RAID 5, and JBOD configurations for four SATA connectors. See page 1-28 for details.

6-channel High Definition Audio



The onboard 6-channel High Definition audio CODEC enables high-quality Realtek® audio CODEC, which automatically detects and identifies what types of peripherals are plugged into the audio I/O jacks and notifies users of inappropriate connection, meaning there will be no more confusion of Line-in, Line-out, and Mic jacks. See page 1-32 for details.

Gigabit LAN solution



Marvell® Gigabit LAN controller delivers transfer speed up to ten times faster than conventional 10/100 Ethernet connections. Gigabit LAN is the networking standard for the early future and is ideal for handling large amount of data such as video, audio, and voice. See page 1-25 for details.

IEEE 1394a support



The IEEE 1394a interface provides high speed digital interface for audio/video appliances such as digital television, digital video camcorders, storage peripherals & other PC portable devices. See pages 1-25 and 1-31 for details.

S/PDIF digital sound ready



This motherboard provides convenient connectivity to external home theater audio systems via coaxial and optical S/PDIF-out (SONY-PHILIPS Digital Interface) jacks. It allows to transfer digital audio without converting to analog format and keeps the best signal quality. See page 1-30 for details.

USB 2.0 technology



The motherboard implements the Universal Serial Bus (USB) 2.0 specification, dramatically increasing the connection speed from the 12 Mbps bandwidth on USB 1.1 to a fast 480 Mbps on USB 2.0. USB 2.0 is backward compatible with USB 1.1. See page 1-26 and 1-31 for details.

Green ASUS



This motherboard and its packaging comply with the European Union's Restriction on the use of Hazardous Substances (RoHS). This is in line with the ASUS vision of creating environment-friendly and recyclable products/packaging to safeguard consumers' health while minimizing the impact on the environment.

1.3.2 ASUS features

ASUS CrashFree BIOS 3



The ASUS CrashFree BIOS 3 allows users to restore corrupted BIOS data from a USB flash disk containing the BIOS file. This utility saves users the cost and hassle of buying a replacement BIOS chip. See page 2-6 for details.

ASUS EZ Flash 2



EZ Flash 2 is a user-friendly BIOS update utility. Simply press the predefined hotkey to launch the utility and update the BIOS without entering the OS. Update your BIOS easily without preparing a bootable diskette or using an OS-based flash utility. See page 2-3 for details.

ASUS O.C. Profile



The motherboard features the ASUS BIOS Profile that allows users to conveniently store or load multiple BIOS settings. The BIOS settings can be stored in the CMOS or a separate file, giving users freedom to share and distribute their favorite settings. See page 2-37 for details.

ASUS Q-Fan2



The ASUS Q-Fan 2 technology intelligently adjusts both CPU fan and chassis fan speed according to system loading to ensure quiet, cool, and efficient operation. See page 2-32 for details

ASUS MyLogo™



ASUS My Logo™ is the new feature present in the motherboard that allows you to personalize and add style to your system with customizable and animated boot logos.

C.P.R. (CPU Parameter Recall)



The C.P.R. feature of the motherboard BIOS allows automatic re-setting to the BIOS default settings in case the system hangs due to overclocking. When the system hangs due to overclocking, C.P.R. eliminates the need to open the system chassis and clear the RTC data. Simply shut down and reboot the system, and the BIOS automatically restores the CPU default setting for each parameter.

1.4 Before you proceed

Take note of the following precautions before you install motherboard components or change any motherboard settings.



- Unplug the power cord from the wall socket before touching any component.
- Use a grounded wrist strap or touch a safely grounded object or a metal object, such as the power supply case, before handling components to avoid damaging them due to static electricity.
- Hold components by the edges to avoid touching the ICs on them.
- Whenever you uninstall any component, place it on a grounded antistatic pad or in the bag that came with the component.
- Before you install or remove any component, ensure that the ATX power supply is switched off or the power cord is detached from the power supply. Failure to do so may cause severe damage to the motherboard, peripherals, and/or components.

Onboard LED

The motherboard comes with a standby power LED that lights up to indicate that the system is ON, in sleep mode, or in soft-off mode. This is a reminder that you should shut down the system and unplug the power cable before removing or plugging in any motherboard component. The illustration below shows the location of the onboard LED.

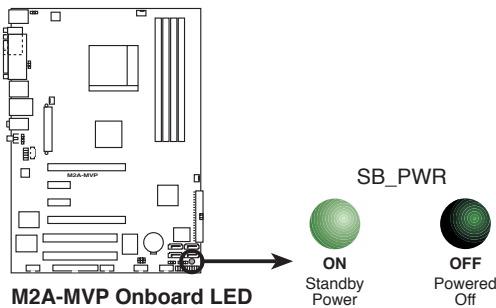

1.5 Motherboard overview

Before you install the motherboard, study the configuration of your chassis to ensure that the motherboard fits into it.



Make sure to unplug the power cord before installing or removing the motherboard. Failure to do so can cause you physical injury and damage motherboard components.

1.5.1 Placement direction

When installing the motherboard, make sure that you place it into the chassis in the correct orientation. The edge with external ports goes to the rear part of the chassis as indicated in the image below.

1.5.2 Screw holes

Place eight (6) screws into the holes indicated by circles to secure the motherboard to the chassis.



Do not overtighten the screws! Doing so can damage the motherboard.

Place this side towards the rear of the chassis

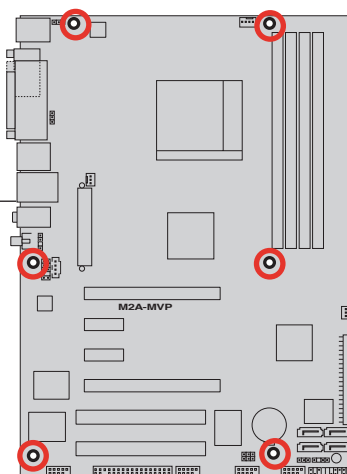

1.5.3 Motherboard layout

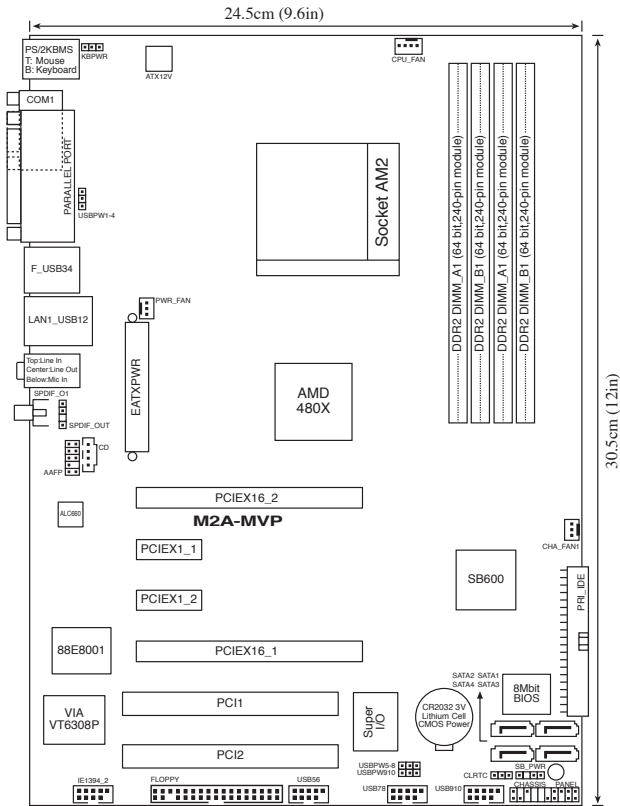

Refer to **1.10 Connectors** for more information about rear panel connectors and internal connectors.

1.6 Central Processing Unit (CPU)

The motherboard comes with a 940-pin AM2 socket designed for the AMD Athlon™ 64 X2/Athlon™ 64/Athlon™ 64FX/Sempron™ processor.



The AM2 socket has a different pinout from the 940-pin socket designed for the AMD Opteron processor. Make sure you use a CPU designed for the AM2 socket. The CPU fits in only one correct orientation. DO NOT force the CPU into the socket to prevent bending the connectors on the socket and damaging the CPU!

1.6.1 Installing the CPU

To install a CPU:

1. Locate the CPU socket on the motherboard.

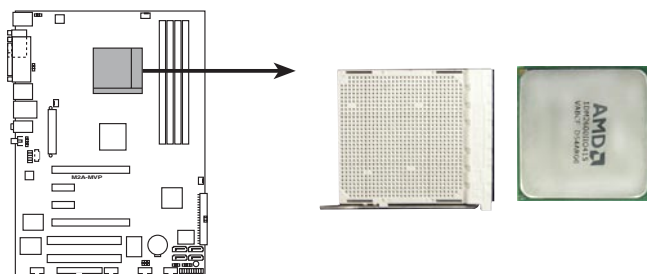

M2A-MVP CPU Socket AM2

2. Unlock the socket by pressing the lever sideways, then lift it up to a 90° angle.

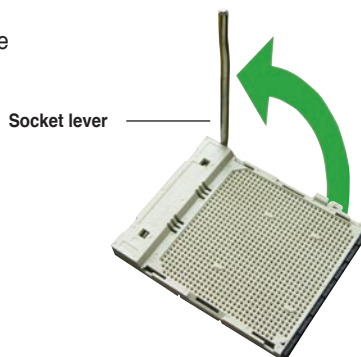

Make sure that the socket lever is lifted up to a 90° angle; otherwise, the CPU will not fit in completely.

3. Position the CPU above the socket such that the CPU corner with the gold triangle matches the socket corner with a small triangle.
4. Carefully insert the CPU into the socket until it fits in place.

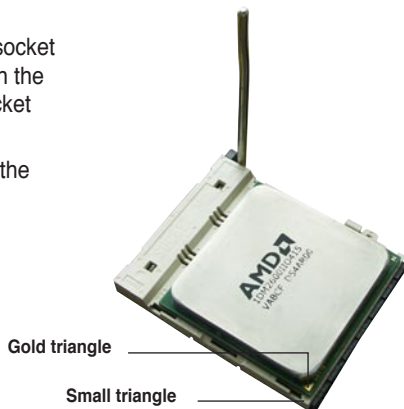

5. When the CPU is in place, push down the socket lever to secure the CPU. The lever clicks on the side tab to indicate that it is locked.
6. Install a CPU heatsink and fan following the instructions that came with the heatsink package.



1.6.2 Installing the heatsink and fan

The AMD Athlon™ 64FX/Athlon™ 64/Athlon™ 64 X2/Sempron™ processor requires a specially designed heatsink and fan assembly to ensure optimum thermal condition and performance.



Make sure that you use only AMD-certified heatsink and fan assembly.

To install the CPU heatsink and fan:

1. Place the heatsink on top of the installed CPU, making sure that the heatsink fits properly on the retention module base.



- The retention module base is already installed on the motherboard upon purchase.
 - You do not have to remove the retention module base when installing the CPU or installing other motherboard components.
 - If you purchased a separate CPU heatsink and fan assembly, make sure that a Thermal Interface Material is properly applied to the CPU heatsink or CPU before you install the heatsink and fan assembly.
-

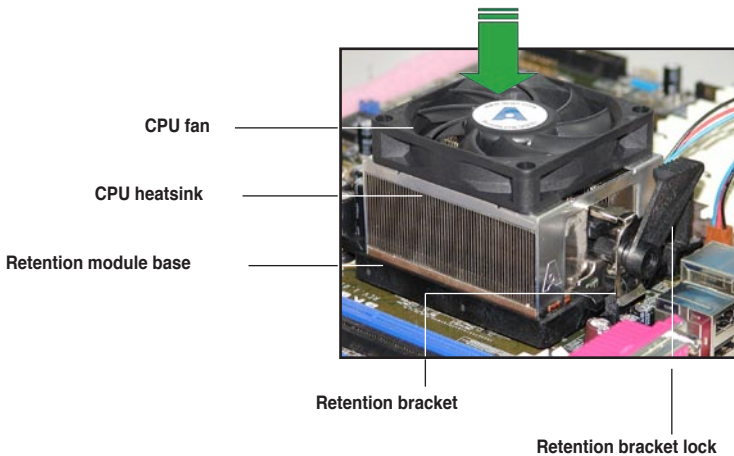

Your boxed CPU heatsink and fan assembly should come with installation instructions for the CPU, heatsink, and the retention mechanism. If the instructions in this section do not match the CPU documentation, follow the latter.

2. Attach one end of the retention bracket to the retention module base.

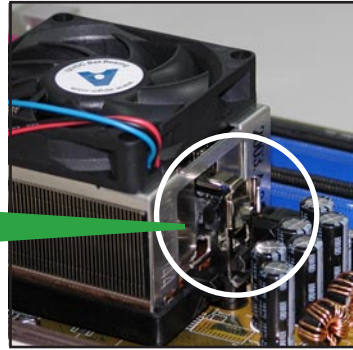
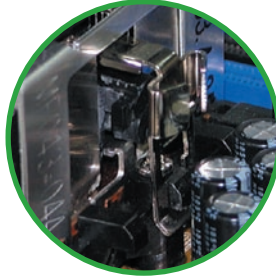

3. Align the other end of the retention bracket (near the retention bracket lock) to the retention module base. A clicking sound denotes that the retention bracket is in place.



Make sure that the fan and heatsink assembly perfectly fits the retention mechanism module base, otherwise you cannot snap the retention bracket in place.



4. Push down the retention bracket lock on the retention mechanism to secure the heatsink and fan to the module base.

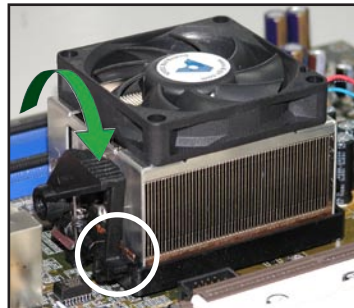

- When the fan and heatsink assembly is in place, connect the CPU fan cable to the connector on the motherboard labeled CPU_FAN.

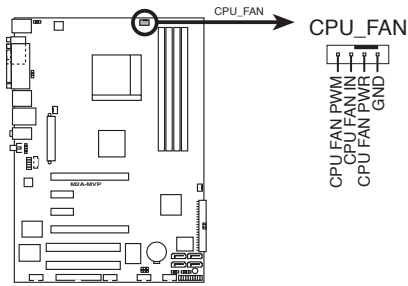

M2A-MVP CPU fan connector



-
- Do not forget to connect the CPU fan connector! Hardware monitoring errors can occur if you fail to plug this connector.
 - This connector is backward compatible with the legacy 3-pin CPU fan.
-

1.7 System memory

1.7.1 Overview

The motherboard comes with four Double Data Rate 2 (DDR2) Dual Inline Memory Modules (DIMM) sockets.

A DDR2 module has the same physical dimensions as a DDR DIMM but has a 240-pin footprint compared to the 184-pin DDR DIMM. DDR2 DIMMs are notched differently to prevent installation on a DDR DIMM socket.

The figure illustrates the location of the DDR2 DIMM sockets:

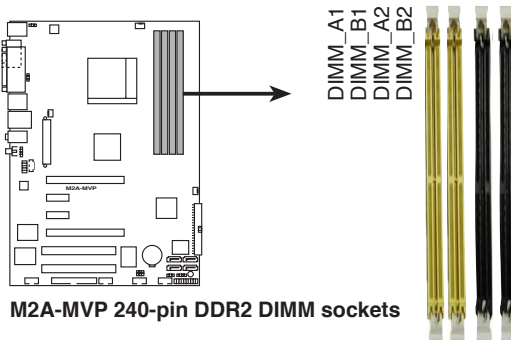

M2A-MVP 240-pin DDR2 DIMM sockets

Channel	Sockets
Channel A	DIMM_A1 and DIMM_A2
Channel B	DIMM_B1 and DIMM_B2



In dual-channel configurations, installing **identical** (the same type and size) DDR2 DIMM pairs for each channel provides optimum performance.

1.7.2 Memory configurations

You may install 256 MB, 512 MB, 1 GB, and 2 GB unbuffered ECC/non-ECC DDR2 DIMMs into the DIMM sockets.



- For dual-channel configuration, the total size of memory module(s) installed per channel must be the same (DIMM_A1+ DIMM_B1 = DIMM_A2+ DIMM_B2)
- Always install DIMMs with the same CAS latency. For optimum compatibility, we recommend that you obtain memory modules from the same vendor. Refer to the DDR2 Qualified Vendors List below for details.
- Due to chipset resource allocation, the system may detect less than 8 GB system memory when you installed four 2 GB DDR2 memory modules.

Recommended memory configurations

Mode	Sockets			
	DIMM_A1	DIMM_B1	DIMM_A2	DIMM_B2
Single-Channel	—	Populated	—	—
	Populated	—	—	—
Dual-channel (1)*	Populated	Populated	—	—
Dual-channel (2)**	Populated	Populated	Populated	Populated

* Use only identical DDR2 DIMM pairs.

** For dual-channel configuration (2), you may:

- install identical DIMMs in all four sockets
OR
- install identical DIMM pair in DIMM_A1 and DIMM_B1 (yellow sockets) and another identical DIMM pair in DIMM_A2 and DIMM_B2 (black sockets)

M2A-MVP Motherboard Qualified Vendors Lists (QVL)

DDR2-800MHz capability

Size	Vendor	Chip No.	SS/ DS	Part No.	DIMM support		
					A	B	C
512MB	KINGSTON	K4T51083QC	SS	KVR800D2N5/512	*	*	*
1024MB	KINGSTON	Heat-Sink Package	DS	KHX6400D2LL/1G	*		
1024MB	KINGSTON	Heat-Sink Package	SS	KHX6400D2LLK2/1GN	*	*	*
512MB	Qimonda	HYB18T256800AF25F	DS	HYS64T64020HU-25F-A	*	*	*
256MB	Qimonda	HYB18T512160BF-25F	SS	HYS64T32000HU-25F-B	*	*	*
512MB	Qimonda	HYB18T512800BF25F	SS	HYS64T64000HU-25F-B	*	*	*
1024MB	Qimonda	HYB18T512800BF25F	DS	HYS64T128020HU-25F-B	*	*	
512MB	SAMSUNG	EDD339XX	SS	M378T6553CZ3-CE7	*	*	*
256MB	SAMSUNG	K4T51163QC-ZCE7	SS	M378T3354CZ3-CE7	*	*	*
512MB	SAMSUNG	ZCE7K4T51083QC	SS	M378T6553CZ3-CE7	*	*	*
1024MB	SAMSUNG	ZCE7K4T51083QC	DS	M378T2953CZ3-CE7	*	*	
512MB	Hynix	HY5PS12821BFP-S5	SS	HYMP564U64BP8-S5	*	*	*
1024MB	Hynix	HY5PS12821BFP-S5	DS	HYMP512U64BP8-S5	*	*	
512MB	MICRON	5JAII29DQQ	SS	MT8HTF6464AY-80EA3	*	*	*
1024MB	MICRON	5JAII29DQQ	DS	MT16HTF12864AY-80EA3	*	*	
512MB	MICRON	5ZD22D9GKX	SS	MT8HTF6464AY-80ED4	*	*	*
1024MB	MICRON	5ZD22D9GKX	DS	MT16HTF12864AY-80ED4	*	*	
512MB	MICRON	6CD22D9GKX	SS	MT8HTF6464AY-80ED4	*	*	*
1024MB	MICRON	6CD22D9GKX	DS	MT16HTF12864AY-80ED4	*	*	
1024MB	CORSAIR	Heat-Sink Package	DS	CM2X1024-6400C4	*	*	
1024MB	ELPIDA	E1108AB-8E-E(ECC)	SS	EBE10EE8ABFA-8E-E	*	*	
2048MB	ELPIDA	E1108AB-8E-E(ECC)	DS	EBE21EE8ABFA-8E-E	*	*	
512MB	A-DATA	N/A	SS	M20AD6G3H3160J1E52	*	*	*
512MB	Crucial	Heat-Sink Package	SS	BL6464AA804.8FD	*	*	*
1024MB	Crucial	Heat-Sink Package	DS	BL12864AA804.16FD	*	*	
512MB	Apacer	Heat-Sink Package	SS	AHU512E800C5K1C	*	*	*
1024MB	Apacer	Heat-Sink Package	DS	AHU01GE800C5K1C	*	*	
512MB	Transcend	K4T51083QC	SS	TS64MLQ64V8J	*	*	*
1024MB	Transcend	K4T51083QC	DS	TS128MLQ64V8J	*	*	

M2A-MVP Motherboard Qualified Vendors Lists (QVL)

DDR2-667MHz capability

Size	Vendor	Chip No.	SS/ DS	Part No.	DIMM support		
					A	B	C
256MB	KINGSTON	HYB18T256800AF3	SS	KVR667D2N5/256	*	*	*
512MB	KINGSTON	D6408TEBGL3U	SS	KVR667D2N5/512	*	*	*
1024MB	KINGSTON	D6408TEBGL3U	DS	KVR667D2N5/1G	*	*	
256MB	KINGSTON	HYB18T256800AF3S	SS	KVR667D2N5/256	*	*	*
256MB	Qimonda	HYB18T512160AF-3S	SS	HYS64T32000HU-3S-A	*	*	*
512MB	Qimonda	HYB18T512800AF3S	SS	HYS64T64000HU-3S-A	*	*	*
256MB	Qimonda	HYB18T256800AF3S(ECC)	SS	HYS72T32000HU-3S-A	*	*	*
512MB	Qimonda	HYB18T512800AF3S(ECC)	SS	HYS72T64000HU-3S-A	*	*	*
1024MB	Qimonda	HYB18T512800AF3S(ECC)	DS	HYS72T128020HU-3S-A	*	*	
1024MB	Qimonda	HYB18T512800BF3S(ECC)	DS	HYS72T128020HU-3S-B	*	*	
256MB	Qimonda	HYB18T512160BF-3S	SS	HYS64T32000HU-3S-B	*	*	*
512MB	Qimonda	HYB18T512800BF3S	SS	HYS64T64000HU-3S-B	*	*	*
1024MB	Qimonda	HYB18T512800BF3S	DS	HYS64T128020HU-3S-B	*	*	
512MB	SAMSUNG	ZCE6K4T51083QC	SS	M378T6553CZ0-CE6	*	*	*
1024MB	SAMSUNG	ZCE6K4T51083QC	DS	M378T2953CZ3-CE6	*	*	
512MB	Hynix	HY5PS12821AFP-Y5	SS	HYMP564U64AP8-Y5	*	*	*
1024MB	Hynix	HY5PS1G831FP-Y5(ECC)	SS	HYMP112U72P8-Y5	*	*	*
512MB	Hynix	HY5PS12821AFP-Y5(ECC)	SS	HYMP564U72AP8-Y5	*	*	*
1024MB	Hynix	HY5PS12821AFP-Y5(ECC)	DS	HYMP512U72AP8-Y5	*	*	
512MB	Hynix	HY5PS12821AFP-Y4	SS	HYMP564U64AP8-Y4	*	*	*
512MB	Hynix	HY5PS12821AFP-Y4(ECC)	SS	HYMP564U72AP8-Y4	*	*	*
256MB	CORSAIR	MIII00605	SS	VS256MB667D2	*	*	*
512MB	CORSAIR	64M8CFEG	SS	VS512MB667D2	*	*	*
1024MB	CORSAIR	64M8CFEG	DS	VS1GB667D2	*	*	
256MB	ELPIDA	E2508AB-6E-E	SS	EBE25UC8ABFA-6E-E	*	*	*
512MB	ELPIDA	E5108AE-6E-E	SS	EBE51UD8AEFA-6E-E	*	*	*
512MB	A-DATA	AD29608A8A-3EG	SS	M2OAD5G3H31661C52	*	*	*
1024MB	A-DATA	AD29608A8A-3EG	DS	M2OAD5G3I41761C52	*	*	
512MB	crucial	Heat-Sink Package	SS	BL6464AA663.8FD	*	*	
1024MB	crucial	Heat-Sink Package	DS	BL12864AA663.16FD	*	*	*
1024MB	crucial	Heat-Sink Package	DS	BL12864AL664.16FD	*	*	*
512MB	Apacer	AM4B5708GQJS7E	SS	AU512E667C5KBGC	*	*	*
1024MB	Apacer	AM4B5708GQJS7E	DS	AU01GE667C5KBGC	*	*	
512MB	Kingmax	KKEA88B4LAUG-29DX	SS	KLCC28F-A8KB5	*	*	*
1024MB	Kingmax	KKEA88B4LAUG-29DX	DS	KLCD48F-A8KB5	*	*	*
512MB	Transcend	E5108AE-6E-E	SS	TS64MLQ64V6J	*	*	*
1024MB	Transcend	E5108AE-6E-E	DS	TS128MLQ64V6J	*	*	*
512MB	Transcend	J12Q3AB-6	SS	JM367Q643A-6	*	*	*
1024MB	Transcend	J12Q3AB-6	DS	JM389Q643A-6	*	*	*

M2A-MVP Motherboard Qualified Vendors Lists (QVL)

DDR2-553 MHz capability

Size	Vendor	Chip No.	SS/ DS	Part No.	DIMM support		
					A	B	C
256MB	KINGSTON	E5116AF-5C-E	SS	KVR533D2N4/256	*	*	*
512MB	KINGSTON	HYB18T512800AF37	SS	KVR533D2N4/512	*	*	*
1024MB	KINGSTON	5YDII9GCT	DS	KVR533D2N4/1G	*	*	
256MB	Qimonda	HYB18T512160AF-3.7	SS	HYS64T32000HU-3.7-A	*	*	*
512MB	Qimonda	HYB18T512800AF37	SS	HYS64T64000HU-3.7-A	*	*	*
1024MB	Qimonda	HYB18T512800AF37	DS	HYS64T128020HU-3.7-A	*	*	
256MB	Qimonda	HYB18T5121608BF-3.7	SS	HYS64T32000HU-3.7-B	*	*	*
512MB	Qimonda	HYB18T512800BF37	SS	HYS64T64000HU-3.7-B	*	*	*
1024MB	Qimonda	HYB18T512800BF37	DS	HYS64T128020HU-3.7-B	*	*	
256MB	Qimonda	HYB18T256800AF37(ECC)	SS	HYS72T32000HU-3.7-A	*	*	*
1024MB	Qimonda	HYB18T512800AF37(ECC)	DS	HYS72T128020HU-3.7-A	*	*	
512MB	SAMSUNG	ZCD5K4T51083QC	SS	M378T6553CZ3-CD5	*	*	*
1024MB	SAMSUNG	ZCD5K4T51083QC	DS	M378T2953CZ3-CD5	*	*	
512MB	Hynix	HY5PS12821F-C4	SS	HYMP564U648-C4	*	*	*
1024MB	Hynix	HY5PS12821F-C4	DS	HYMP512U648-C4	*	*	
1024MB	Hynix	HY5PS12821F-C4(ECC)	DS	HYMP512U728-C4	*	*	
512MB	Hynix	HY5PS12821FP-C4(ECC)	SS	HYMP564U728-C4	*	*	*
512MB	Hynix	HY5PS12821AFP-C3	SS	HYMP564U64AP8-C3	*	*	*
1024MB	Hynix	HY5PS12821AFP-C3	DS	HYMP512U64AP8-C3	*	*	
1024MB	CORSAIR	64M8CEDG	DS	VS1GB533D2	*	*	
512MB	ELPIDA	E5108AB-5C-E	SS	EBE51UD8ABFA-5C-E	*	*	*
512MB	KINGMAX	E5108AE-5C-E	SS	KLBC28F-A8EB4	*	*	*
1024MB	KINGMAX	E5108AE-5C-E	DS	KLBD48F-A8EB4	*	*	
512MB	KINGMAX	KKEA88E4AAK-37	SS	KLBC28F-A8KE4	*	*	*
1024MB	KINGMAX	5MB22D9DCN	DS	KLBD48F-A8ME4	*	*	

SS - Single-sided DS - Double-sided

DIMM support:

- A - Supports one module inserted into either slot in Single-channel memory configuration.
- B - Supports one pair of modules inserted into either the yellow slots or the black slots as one pair of Dual-channel memory configuration.
- C - Supports four modules inserted into both the yellow and black slots as two pairs of Dual-channel memory configuration.



Visit the ASUS website for the latest DDR2-800/667/533 MHz QVL.

1.7.3 Installing a DIMM



Unplug the power supply before adding or removing DIMMs or other system components. Failure to do so can cause severe damage to both the motherboard and the components.

To install a DIMM:

1. Unlock a DIMM socket by pressing the retaining clips outward.
2. Align a DIMM on the socket such that the notch on the DIMM matches the break on the socket.
3. Firmly insert the DIMM into the socket until the retaining clips snap back in place and the DIMM is properly seated.

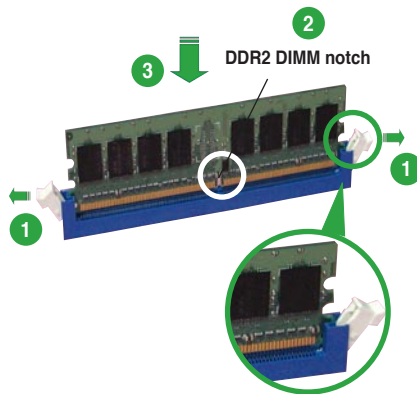

Unlocked retaining clip



- A DDR2 DIMM is keyed with a notch so that it fits in only one direction. Do not force a DIMM into a socket to avoid damaging the DIMM.
- The DDR2 DIMM sockets do not support DDR DIMMs. Do not install DDR DIMMs to the DDR2 DIMM sockets.

1.7.4 Removing a DIMM

To remove a DIMM:

1. Simultaneously press the retaining clips outward to unlock the DIMM.



Support the DIMM lightly with your fingers when pressing the retaining clips. The DIMM might get damaged when it flips out with extra force.

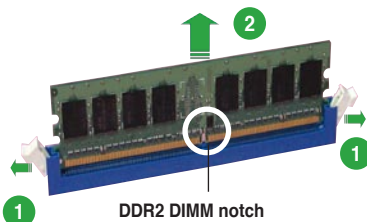

2. Remove the DIMM from the socket.

1.8 Expansion slots

In the future, you may need to install expansion cards. The following sub-sections describe the slots and the expansion cards that they support.



Make sure to unplug the power cord before adding or removing expansion cards. Failure to do so may cause you physical injury and damage motherboard components.

1.8.1 Installing an expansion card

To install an expansion card:

1. Before installing the expansion card, read the documentation that came with it and make the necessary hardware settings for the card.
2. Remove the system unit cover (if your motherboard is already installed in a chassis).
3. Remove the bracket opposite the slot that you intend to use. Keep the screw for later use.
4. Align the card connector with the slot and press firmly until the card is completely seated on the slot.
5. Secure the card to the chassis with the screw you removed earlier.
6. Replace the system cover.

1.8.2 Configuring an expansion card

After installing the expansion card, configure it by adjusting the software settings.

1. Turn on the system and change the necessary BIOS settings, if any. See Chapter 2 for information on BIOS setup.
2. Assign an IRQ to the card. Refer to the tables on the next page.
3. Install the software drivers for the expansion card.



When using PCI cards on shared slots, ensure that the drivers support “Share IRQ” or that the cards do not need IRQ assignments. Otherwise, conflicts will arise between the two PCI groups, making the system unstable and the card inoperable. Refer to the table on the next page for details.

1.8.3 Interrupt assignments

Standard interrupt assignments

IRQ	Priority	Standard function
0	1	System Timer
1	2	Keyboard Controller
2	–	Redirect to IRQ#9
3	11	Reserved
4	12	Communications Port (COM1)*
5	13	IRQ holder for PCI steering*
6	14	Floppy Disk Controller
7	15	Printer Port (LPT1)*
8	3	System CMOS/Real Time Clock
9	4	IRQ holder for PCI steering*
10	5	IRQ holder for PCI steering*
11	6	IRQ holder for PCI steering*
12	7	PS/2 Compatible Mouse Port*
13	8	Numeric Data Processor
14	9	Primary IDE/SATA Channel
15	10	Secondary IDE/SATA Channel

* These IRQs are usually available for ISA or PCI devices.

IRQ assignments for this motherboard

	A	B	C	D	E	F	G	H
PCI Slot 1	–	–	–	–	shared	shared	shared	shared
PCI Slot 2	–	–	–	–	shared	shared	shared	shared
IEEE 1394a	–	–	–	–	–	–	shared	–
LAN (88E8001)	–	–	–	–	–	shared	–	–
PCI-E x1_1	shared	shared	shared	shared	–	–	–	–
PCI-E x1_2	shared	shared	shared	shared	–	–	–	–
PCI-E x16_1	shared	shared	shared	shared	–	–	–	–
PCI-E x16_2	shared	shared	shared	shared	–	–	–	–
USB1.0 controller1	–	–	–	shared	–	–	–	–
USB1.0 controller2	–	–	–	shared	–	–	–	–
USB1.0 controller3	–	–	–	shared	–	–	–	–
USB1.0 controller4	–	–	–	shared	–	–	–	–
USB2.0 controller	–	–	–	shared	–	–	–	–
HD audio	shared	–	–	–	–	–	–	–
Onboard SATA	–	–	–	–	–	shared	–	–

1.8.4 Two PCI slots

The PCI slots support cards such as a LAN card, SCSI card, USB card, and other cards that comply with PCI specifications. The figure shows a LAN card installed on a PCI slot.

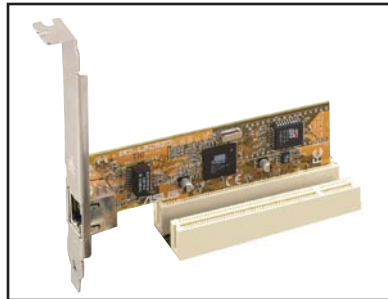

1.8.5 Two PCI Express x1 slot

This motherboard supports two PCI Express x1 network cards, SCSI cards and other cards that comply with the PCI Express specifications. The following figure shows a network card installed on the PCI Express x1 slot.

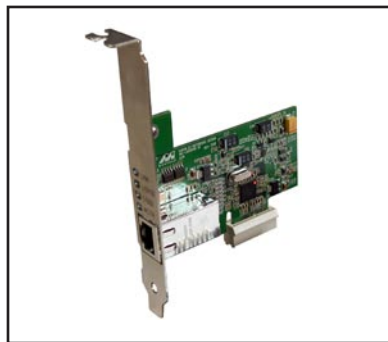

1.8.6 Two PCI Express x16 slot

This motherboard supports two ATI CrossFire™ PCI Express x16 graphics cards that comply with the PCI Express specifications. The figure shows two graphics cards installed on the PCI Express x16 slots.

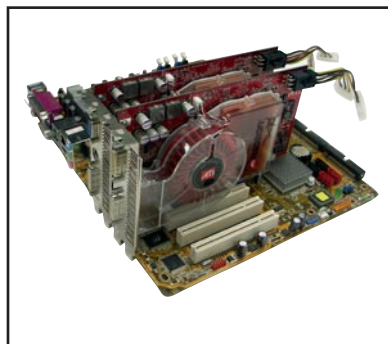



- In single card mode, we recommend that you install a VGA card on the blue PCI Express slot and install any other PCI Express device on the black PCI Express slot.
- In CrossFire™ mode, each PCI Express x16 slot works at x8 bandwidth.
- **In CrossFire™ mode, install the ATI CrossFire™ Edition (Master) graphics card on the blue PCI Express slot; otherwise, the system will not boot.**
- If you do not configure the PCI Express device(s) according to the table below, the system may have a failed or delayed power-on self test (POST).
- Refer to the table below for possible PCI Express Card configurations.

PCI Express x16 slot configurations

	PCIe x 16_1 (blue) slot		PCIe x 16_2 (black) slot	
	Card Type	Speed	Card	Speed
Single graphics card*	PCIe x16 graphics card	x16	MVP Switch Card	NA
	PCIe x16 graphics card	x8	PCIe devices (non-VGA)	x8, x4, x1
Dual graphics cards in CrossFire™ mode**	ATI CrossFire™ Edition graphics card	x8	ATI graphics card	x8



- * Install the MVP Switch Card on the black PCI Express slot. Remove it only when you want to install other devices.
- ** Install two ATI graphics cards from the same GPU family.

1.9 Jumper

1. Clear RTC RAM (CLRRTC)

This jumper allows you to clear the Real Time Clock (RTC) RAM in CMOS. You can clear the CMOS memory of date, time, and system setup parameters by erasing the CMOS RTC RAM data. The onboard button cell battery powers the RAM data in CMOS, which include system setup information such as system passwords.

To erase the RTC RAM:

1. Turn OFF the computer and unplug the power cord.
2. Remove the onboard battery.
3. Move the jumper cap from pins 1-2 (default) to pins 2-3. Keep the cap on pins 2-3 for about 5~10 seconds, then move the cap back to pins 1-2.
4. Reinstall the battery.
5. Plug the power cord and turn ON the computer.
6. Hold down the key during the boot process and enter BIOS setup to re-enter data.



Except when clearing the RTC RAM, never remove the cap on CLRRTC jumper default position. Removing the cap will cause system boot failure!

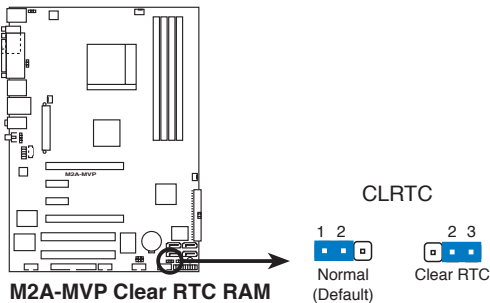

- You do not need to clear the RTC when the system hangs due to overclocking. For system failure due to overclocking, use the C.P.R. (CPU Parameter Recall) feature. Shut down and reboot the system so the BIOS can automatically reset parameter settings to default values.
- Due to the chipset limitation, AC power off is required prior using C.P.R. function. You must turn off and on the power supply or unplug and plug the power cord before reboot the system.

2. Keyboard power (3-pin KBPWR)

This jumper allows you to enable or disable the keyboard wake-up feature. Set this jumper to pins 2-3 (+5VSB) to wake up the computer when you press a key on the keyboard (the default is the Space Bar). This feature requires an ATX power supply that can supply at least 1A on the +5VSB lead, and a corresponding setting in the BIOS.

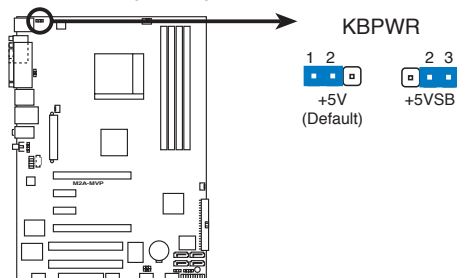

M2A-MVP Keyboard power setting

3. USB device wake-up (3-pin USBPW1-4, USBPW5-8, USBPW910)

Set these jumpers to +5V to wake up the computer from S1 sleep mode (CPU stopped, DRAM refreshed, system running in low power mode) using the connected USB devices. Set to +5VSB to wake up from S3 and S4 sleep modes.

The USBPW1-4 jumpers are for the rear USB ports. The USBPW5-8 and USBPW910 jumpers are for the internal USB connectors that you can connect to additional USB ports.

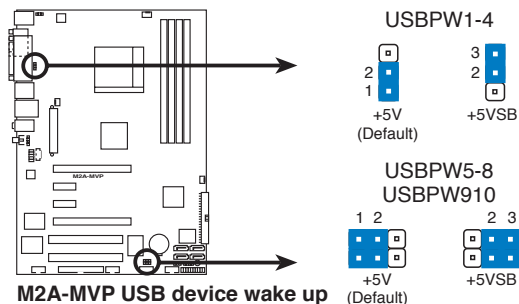

M2A-MVP USB device wake up



- The USB device wake-up feature requires a power supply that can provide 500mA on the +5VSB lead for each USB port; otherwise, the system will not power up.
- The total current consumed must NOT exceed the power supply capability (+5VSB) whether under normal condition or in sleep mode.

1.10 Connectors

1.10.1 Rear panel connectors

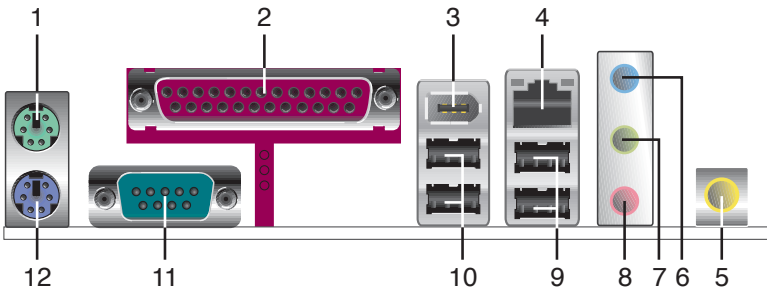

1. **PS/2 mouse port (green).** This port is for a PS/2 mouse.
2. **Parallel port.** This 25-pin port connects a parallel printer, a scanner, or other devices.
3. **IEEE 1394a port.** This 6-pin IEEE 1394a port provides high-speed connectivity for audio/video devices, storage peripherals, PCs, or portable devices.
4. **LAN (RJ-45) port.** Supported by Realtek® Gigabit LAN controller, this port allows Gigabit connection to a Local Area Network (LAN) through a network hub. Refer to the table below for the LAN port LED indications.

LAN port LED indications

Activity/Link Speed LED			
Status	Description	Status	Description
OFF	No link	OFF	10 Mbps connection
ORANGE	Linked	ORANGE	100 Mbps connection
BLINKING	Data activity	GREEN	1 Gbps connection

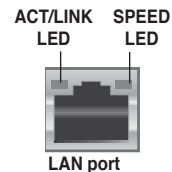

5. **Coaxial S/PDIF Out port.** This port connects an external audio output device via a coaxial S/PDIF cable.
6. **Line In port (light blue).** This port connects the tape, CD, DVD player, or other audio sources.
7. **Line Out port (lime).** This port connects a headphone or a speaker. In 4-channel, 6-channel, and 8-channel configuration, the function of this port becomes Front Speaker Out.
8. **Microphone port (pink).** This port connects a microphone.



Refer to the audio configuration table below for the function of the audio ports in 2, 4, or 6-channel configuration.

Audio 2, 4, or 6-channel configuration

Port	Headset 2-channel	4-channel	6-channel
Light Blue	Line In	Rear Speaker Out	Rear Speaker Out
Lime	Line Out	Front Speaker Out	Front Speaker Out
Pink	Mic In	Mic In	Bass/Center

- 9. USB 2.0 ports 1 and 2.** These two 4-pin Universal Serial Bus (USB) ports are available for connecting USB 2.0 devices.
- 10. USB 2.0 ports 3 and 4.** These two 4-pin Universal Serial Bus (USB) ports are available for connecting USB 2.0 devices.
- 11. Serial port.** This 9-pin COM1 port is for pointing devices or other serial devices.
- 12. PS/2 keyboard port (purple).** This port is for a PS/2 keyboard.

1.10.2 Internal connectors

1. Floppy disk drive connector (34-1 pin FLOPPY)

This connector is for the provided floppy disk drive (FDD) signal cable. Insert one end of the cable to this connector, then connect the other end to the signal connector at the back of the floppy disk drive.



Pin 5 on the connector is removed to prevent incorrect cable connection when using a FDD cable with a covered Pin 5.

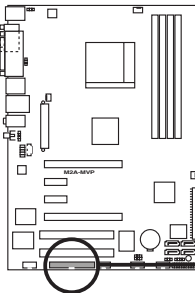

M2A-MVP Floppy disk drive connector

FLOPPY

NOTE: Orient the red markings on the floppy ribbon cable to PIN 1.



PIN 1

2. IDE connector (40-1 pin PRI_IDE)

The onboard IDE connector is for the Ultra DMA 133/100/66 signal cable. There are three connectors on each Ultra DMA 133/100/66 signal cable: blue, black, and gray. Connect the blue connector to the motherboard's IDE connector, then select one of the following modes to configure your device.

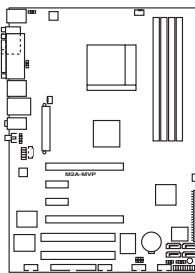

M2A-MVP IDE connector



PRI_IDE

NOTE: Orient the red markings (usually zigzag) on the IDE ribbon cable to PIN 1.



- Pin 20 on the IDE connector is removed to match the covered hole on the Ultra DMA cable connector. This prevents incorrect insertion when you connect the IDE cable.
- Use the 80-conductor IDE cable for Ultra DMA 133/100/66 IDE devices.

	Drive jumper setting	Mode of device(s)	Cable connector
Single device	Cable-Select or Master	—	Black
Two devices	Cable-Select	Master	Black
		Slave	Gray
	Master	Master	Black or gray
	Slave	Slave	



If any device jumper is set as “Cable-Select,” make sure all other device jumpers have the same setting.

3. Serial ATA connectors (7-pin SATA1 [red], SATA2 [red], SATA3 [black], SATA4 [black])

These connectors are for the Serial ATA signal cables for Serial ATA hard disk drives.

If you installed Serial ATA hard disk drives, you can create a RAID 0, RAID 1, and RAID 0+1 configuration. Refer to Chapter 3 for information on creating a RAID configuration.



Enable the Serial ATA Controller and Onboard SATA Boot ROM items in the BIOS if you want to use the Serial ATA RAID feature. See section 2.3.5 Storage Configuration for details.

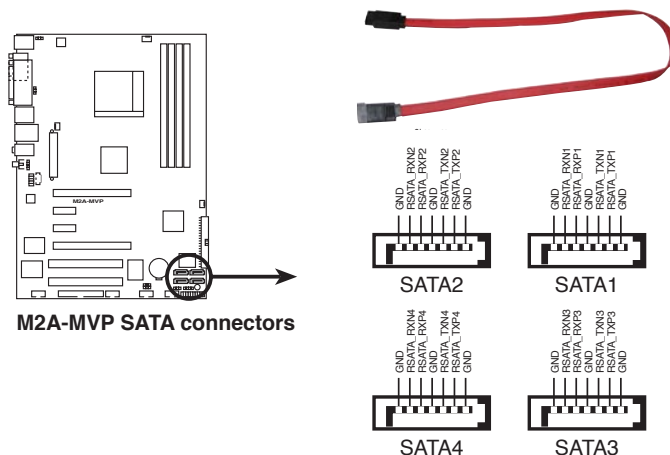



- Plug your Serial ATA boot disk on the master port (SATA1/2 to support S3 function).
- Install the Windows® 2000 Service Pack 4 or the Windows® XP Service Pack1 or later when using Serial ATA.

Serial ATA hard disk drive connection

Connector	Color	Setting	Use
SATA1/SATA2	Red	Master	Boot disk
SATA3/SATA4	Black	Slave	Data disk

4. Chassis intrusion connector (4-1 pin CHASSIS)

This connector is for a chassis-mounted intrusion detection sensor or switch. Connect one end of the chassis intrusion sensor or switch cable to this connector. The chassis intrusion sensor or switch sends a high-level signal to this connector when a chassis component is removed or replaced. The signal is then generated as a chassis intrusion event.

By default, the pins labeled “Chassis Signal” and “Ground” are shorted with a jumper cap. Remove the jumper caps only when you intend to use the chassis intrusion detection feature.

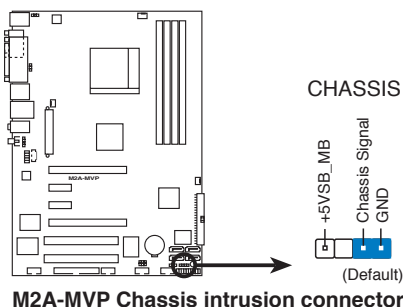

5. CPU, chassis, and power fan connectors (4-pin CPU_FAN, 3-pin PWR_FAN, 3-pin CHA_FAN1)

The fan connectors support cooling fans of 350 mA ~ 2000 mA (24 W max.) or a total of 1 A ~ 7 A (84 W max.) at +12V. Connect the fan cables to the fan connectors on the motherboard, making sure that the black wire of each cable matches the ground pin of the connector.



Do not forget to connect the fan cables to the fan connectors. Insufficient air flow inside the system may damage the motherboard components. These are not jumpers! Do not place jumper caps on the fan connectors!

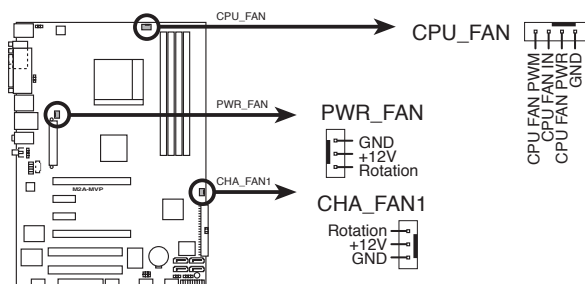

M2A-MVP Fan connectors



Only the CPU-FAN and CHA-FAN1 connectors support the ASUS Q-Fan 2 feature.

6. Digital Audio connector (4-1 pin SPDIF_OUT)

This connector is for the S/PDIF audio module to allow digital sound output. Connect one end of the S/PDIF audio cable to this connector and the other end to the S/PDIF module.

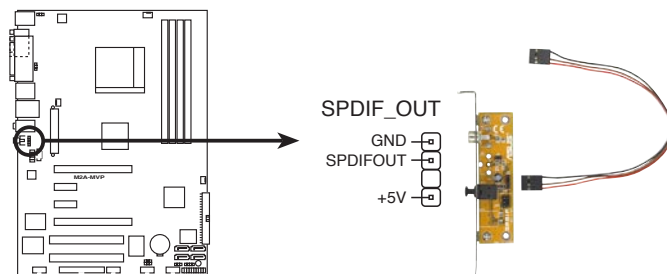

M2A-MVP COM port connector



The S/PDIF out module is purchased separately.

7. USB connectors (10-1 pin USB56, USB 78, USB910)

These connectors are for USB 2.0 ports. Connect the USB module cable to any of these connectors, then install the module to a slot opening at the back of the system chassis. These USB connectors comply with USB 2.0 specification that supports up to 480 Mbps connection speed.

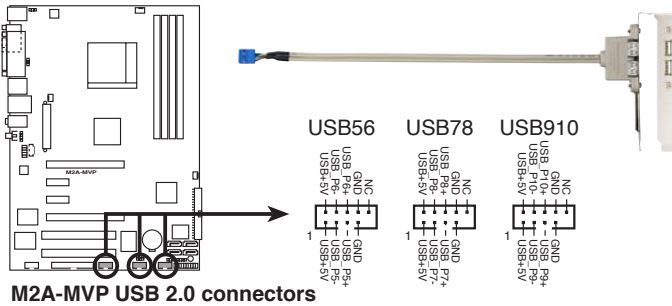

Never connect a 1394 cable to the USB connectors. Doing so will damage the motherboard!



The USB 2.0 module is purchased separately.

8. IEEE 1394a port connector (10-1 pin IE1394_2)

This connector is for a IEEE 1394a port. Connect the IEEE 1394a module cable to this connector, then install the module to a slot opening at the back of the system chassis.

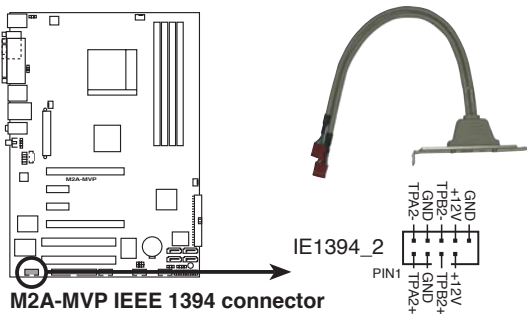

Never connect a USB cable to the IEEE 1394a connector. Doing so will damage the motherboard!



The IEEE 1394a module is purchased separately.

9. Front panel audio connector (10-1 pin AAFP)

This connector is for a chassis-mounted front panel audio I/O module that supports either HD Audio or legacy AC'97 audio standard. Connect one end of the front panel audio I/O module cable to this connector.

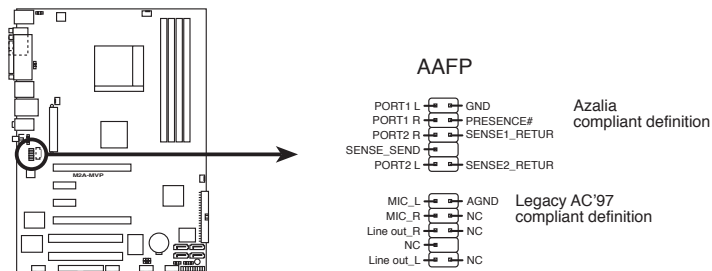

M2A-MVP Analog front panel connector



- We recommend that you connect a high-definition front panel audio module to this connector to avail of the motherboard's high-definition audio capability.
- By default, this connector is set to [HD Audio]. If you want to connect a AC'97 front panel audio module to this connector, set the **Front Panel Support Type** item in the BIOS setup to [AC97]. See section 2.4.4 Onboard Device Configuration for details.

10. Optical drive audio in connector (4-pin CD [black])

This connector allows you to receive stereo audio input from sound sources such as a CD-ROM, TV-tuner, or MPEG card.

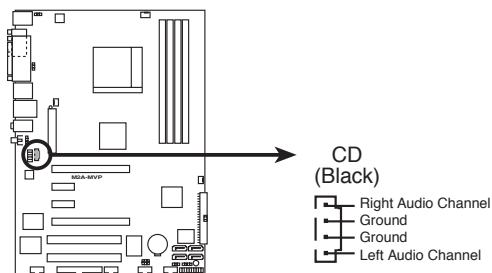

M2A-MVP Internal audio connector

11. ATX power connectors (24-pin EATXPWR, 4-pin ATX12V)

These connectors are for ATX power supply plugs. The power supply plugs are designed to fit these connectors in only one orientation. Find the proper orientation and push down firmly until the connectors completely fit.

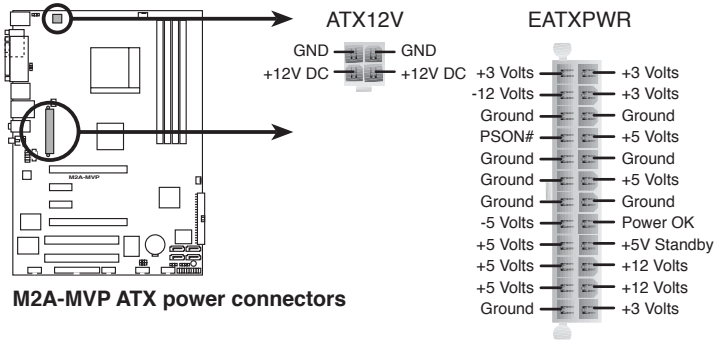

M2A-MVP ATX power connectors



- For a fully-configured system, we recommend that you use a power supply unit (PSU) that complies with ATX 12 V Specification 2.0 (or later version) and provides a minimum power of 400 W.
- Do not forget to connect the 4-pin ATX +12 V power plug; otherwise, the system will not boot up.
- Use of a PSU with a higher power output is recommended when configuring a system with more power-consuming devices. The system may become unstable or may not boot up if the power is inadequate.
- If you want to use the ATI CrossFire™ Graphics solution, use a PSU with 500 ~ 600 W power to ensure system stability.

12. System panel connector (20-8 pin PANEL)

This connector supports several chassis-mounted functions.

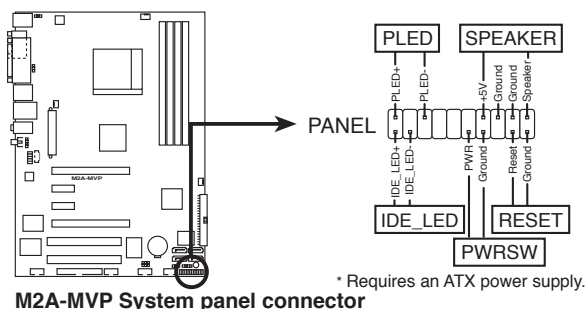

- **System power LED (2-pin PLED)**

This 2-pin connector is for the system power LED. Connect the chassis power LED cable to this connector. The system power LED lights up when you turn on the system power, and blinks when the system is in sleep mode.

- **Hard disk drive activity LED (2-pin IDE_LED)**

This 2-pin connector is for the HDD Activity LED. Connect the HDD Activity LED cable to this connector. The IDE LED lights up or flashes when data is read from or written to the HDD.

- **System warning speaker (4-pin SPEAKER)**

This 4-pin connector is for the chassis-mounted system warning speaker. The speaker allows you to hear system beeps and warnings.

- **ATX power button/soft-off button (2-pin PWRSW)**

This connector is for the system power button. Pressing the power button turns the system on or puts the system in sleep or soft-off mode depending on the BIOS settings. Pressing the power switch for more than four seconds while the system is ON turns the system OFF.

- **Reset button (2-pin RESET)**

This 2-pin connector is for the chassis-mounted reset button for system reboot without turning off the system power.

This chapter tells how to change the system settings through the BIOS Setup menus. Detailed descriptions of the BIOS parameters are also provided.

BIOS setup **2**

2.1 Managing and updating your BIOS

The following utilities allow you to manage and update the motherboard Basic Input/Output System (BIOS) setup.

1. **ASUS EZ Flash 2** (Updates the BIOS using a floppy disk or USB flash disk.)
2. **ASUS AFUDOS** (Updates the BIOS in DOS mode using a bootable floppy disk.)
3. **ASUS CrashFree BIOS 3** (Updates the BIOS using a bootable floppy, USB Flash disk, or the motherboard support CD when the BIOS file fails or gets corrupted.)
4. **ASUS Update** (Updates the BIOS in Windows® environment.)

Refer to the corresponding sections for details on these utilities.



Save a copy of the original motherboard BIOS file to a bootable floppy disk or a USB flash disk in case you need to restore the BIOS in the future. Copy the original motherboard BIOS using the ASUS Update or AFUDOS utilities.

2.1.1 Creating a bootable floppy disk

1. Do either one of the following to create a bootable floppy disk.

DOS environment

- a. Insert a 1.44MB floppy disk into the drive.
- b. At the DOS prompt, type `format a: /s` then press <Enter>.

Windows® XP environment

- a. Insert a 1.44 MB floppy disk to the floppy disk drive.
- b. Click **Start** from the Windows® desktop, then select **My Computer**.
- c. Select the 3 1/2 Floppy Drive icon.
- d. Click **File** from the menu, then select **Format. A Format 3 1/2 Floppy Disk** window appears.
- e. Select **Create an MS-DOS startup disk** from the format options field, then click **Start**.

Windows® 2000 environment

To create a set of boot disks for Windows® 2000:

- a. Insert a formatted, high density 1.44 MB floppy disk into the drive.
- b. Insert the Windows® 2000 CD to the optical drive.
- c. Click **Start**, then select **Run**.
- d. From the Open field, type
`D:\bootdisk\makeboot a:`
assuming that D: is your optical drive.
- e. Press <Enter>, then follow screen instructions to continue.

2. Copy the original or the latest motherboard BIOS file to the bootable floppy disk.

2.1.2 ASUS EZ Flash 2 utility

The ASUS EZ Flash 2 feature allows you to update the BIOS without having to go through the long process of booting from a floppy disk and using a DOS-based utility. The EZ Flash 2 utility is built-in the BIOS chip so it is accessible by pressing <Alt> + <F2> during the Power-On Self-Test (POST).

To update the BIOS using EZ Flash 2:

1. Visit the ASUS website (www.asus.com) to download the latest BIOS file for the motherboard.
2. Save the BIOS file to a floppy disk or a USB flash disk, then restart the system.
3. You can launch the EZ Flash 2 by two methods.
 - (1) Insert the floppy disk / USB flash disk that contains the BIOS file to the floppy disk drive or the USB port.

Press <Alt> + <F2> during POST to display the following.

```
ASUSTek EZ Flash 2 BIOS ROM Utility v3.00
FLASH TYPE: Winbond W39V080A/BP
Current ROM
BOARD: M2A-MVP
VER: 0204
DATE: 10/25/06
Update ROM
BOARD: Unknown
VER: Unknown
DATE: Unknown
PATH: A:\
A:
Note
[Enter] Select or Load      [B] Backup  [ESC] Exit
[Tab] Switch                [Up/Down/Home/End] Move
```

- (2) Enter BIOS setup program. Go to the **Tools** menu to select **EZ Flash2** and press <Enter> to enable it.
You can switch between drives by pressing <Tab> before the correct file is found. Then press <Enter>.
4. When the correct BIOS file is found, EZ Flash 2 performs the BIOS update process and automatically reboots the system when done.



- This function can support devices such as USB flash disk, or floppy disk with **FAT 32/16** format only.
- Do not shut down or reset the system while updating the BIOS to prevent system boot failure!



- This function can support devices such as USB flash disk, or floppy disk with **FAT 32/16** format only.
- Do not shut down or reset the system while updating the BIOS to prevent system boot failure!

2.1.3 AFUDOS utility

The AFUDOS utility allows you to update the BIOS file in DOS environment using a bootable floppy disk with the updated BIOS file. This utility also allows you to copy the current BIOS file that you can use as backup when the BIOS fails or gets corrupted during the updating process.

Copying the current BIOS

To copy the current BIOS file using the AFUDOS utility:



- Make sure that the floppy disk is not write-protected and has at least 1024KB free space to save the file.
- The succeeding BIOS screens are for reference only. The actual BIOS screen displays may not be same as shown.

1. Copy the AFUDOS utility (afudos.exe) from the motherboard support CD to the bootable floppy disk you created earlier.
2. Boot the system in DOS mode, then at the prompt type:

```
afudos /o[filename]
```

where the [filename] is any user-assigned filename not more than eight alphanumeric characters for the main filename and three alphanumeric characters for the extension name.

```
A:\>afudos /oOLDBIOS1.rom
```

Main filename Extension name

3. Press <Enter>. The utility copies the current BIOS file to the floppy disk.

```
A:\>afudos /oOLDBIOS1.rom
AMI Firmware Update Utility - Version 1.19 (ASUS V2.07 (03.11.24BB))
Copyright (C) 2002 American Megatrends, Inc. All rights reserved.
Reading flash ..... done
Write to file..... ok
A:\>
```

The utility returns to the DOS prompt after copying the current BIOS file.

Updating the BIOS file

To update the BIOS file using the AFUDOS utility:

1. Visit the ASUS website (www.asus.com) and download the latest BIOS file for the motherboard. Save the BIOS file to a bootable floppy disk.



Write the BIOS filename on a piece of paper. You need to type the exact BIOS filename at the DOS prompt.

2. Copy the AFUDOS utility (`afudos.exe`) from the motherboard support CD to the bootable floppy disk you created earlier.
3. Boot the system in DOS mode, then at the prompt type:
afudos /i [filename]

where [filename] is the latest or the original BIOS file on the bootable floppy disk.

```
A:\>afudos /iM2AMVP.ROM
```

4. The utility verifies the file and starts updating the BIOS.

```
A:\>afudos /iM2AMVP.ROM
AMI Firmware Update Utility - Version 1.19 (ASUS V2.07(03.11.24BB))
Copyright (C) 2002 American Megatrends, Inc. All rights reserved.

WARNING!! Do not turn off power during flash BIOS
Reading file ..... done
Reading flash ..... done

Advance Check .....
Erasing flash ..... done
Writing flash ..... 0x0008CC00 (9%)
```



Do not shut down or reset the system while updating the BIOS to prevent system boot failure!

5. The utility returns to the DOS prompt after the BIOS update process is completed. Reboot the system from the hard disk drive.

```
A:\>afudos /iM2AMVP.ROM
AMI Firmware Update Utility - Version 1.19 (ASUS V2.07(03.11.24BB))
Copyright (C) 2002 American Megatrends, Inc. All rights reserved.

WARNING!! Do not turn off power during flash BIOS
Reading file ..... done
Reading flash ..... done

Advance Check .....
Erasing flash ..... done
Writing flash ..... done
Verifying flash .... done

Please restart your computer

A:\>
```

2.1.4 ASUS CrashFree BIOS 3 utility

The ASUS CrashFree BIOS 3 is an auto recovery tool that allows you to restore the BIOS file when it fails or gets corrupted during the updating process. You can update a corrupted BIOS file using the motherboard support CD, the USB flash disk, or the floppy disk that contains the updated BIOS file.



- Prepare the motherboard support CD, the USB flash disk, or the floppy disk containing the updated motherboard BIOS before using this utility.
- Make sure that you rename the original or updated BIOS file in the floppy disk or the USB flash disk to **M2AMVP.ROM**.

If your display monitor is connected to the onboard VGA connector, the display monitor will turn-off and the system will beep once while CrashFree BIOS 3 starts updating your system. The system will beep once again while the process is finished, and the display will return after the system restarts.

Recovering the BIOS from a floppy disk

To recover the BIOS from a floppy disk:

1. Turn on the system.
2. Insert the floppy disk with the original or updated BIOS file to the floppy disk drive.
3. The utility displays the following message and automatically checks the floppy disk for the original or updated BIOS file.

```
Bad BIOS checksum. Starting BIOS recovery...  
Checking for floppy...
```

When found, the utility reads the BIOS file and starts flashing the corrupted BIOS file.

```
Bad BIOS checksum. Starting BIOS recovery...  
Checking for floppy...  
Floppy found!  
Reading file "M2AMVP.ROM". Completed.  
Start flashing...
```

4. Restart the system after the utility completes the updating process.

Recovering the BIOS from the support CD

To recover the BIOS from the support CD:

1. Remove any floppy disk from the floppy disk drive, then turn on the system.
2. Insert the support CD to the optical drive.
3. The utility displays the following message and automatically checks the floppy disk for the original or updated BIOS file.

```
Bad BIOS checksum. Starting BIOS recovery...
Checking for floppy...
```

When no floppy disk is found, the utility automatically checks the optical drive for the original or updated BIOS file. The utility then updates the corrupted BIOS file.

```
Bad BIOS checksum. Starting BIOS recovery...
Checking for floppy...
Floppy not found!
Checking for CD-ROM...
CD-ROM found!
Reading file "M2AMVP.ROM". Completed.
Start flashing...
```

4. Restart the system after the utility completes the updating process.

Recovering the BIOS from the USB flash disk

To recover the BIOS from the USB flash disk:

1. Insert the USB flash disk that contains BIOS file to the USB port.
2. Turn on the system.
3. The utility will automatically checks the devices for the BIOS file when found, the utility reads the BIOS file and starts flashing the corrupted BIOS file.
4. Restart the system after the utility completes the updating process.



The recovered BIOS may not be the latest BIOS version for this motherboard. Visit the ASUS website (www.asus.com) to download the latest BIOS file.



-
- Only the USB flash disk with FAT 32/16 format and single partition can support ASUS CrashFree BIOS 3. The device size should be smaller than 8GB.
 - DO NOT shut down or reset the system while updating the BIOS! Doing so can cause system boot failure!
-

2.1.5 ASUS Update utility

The ASUS Update is a utility that allows you to manage, save, and update the motherboard BIOS in Windows® environment. The ASUS Update utility allows you to:

- Save the current BIOS file
- Download the latest BIOS file from the Internet
- Update the BIOS from an updated BIOS file
- Update the BIOS directly from the Internet, and
- View the BIOS version information.

This utility is available in the support CD that comes with the motherboard package.



ASUS Update requires an Internet connection either through a network or an Internet Service Provider (ISP).

Installing ASUS Update

To install ASUS Update:

1. Place the support CD in the optical drive. The **Drivers** menu appears.
2. Click the **Utilities** tab, then click **Install ASUS Update**. See page 3-4 for the **Utilities** screen menu.
3. The ASUS Update utility is copied to your system.



Quit all Windows® applications before you update the BIOS using this utility.

Updating the BIOS through the Internet

To update the BIOS through the Internet:

1. Launch the ASUS Update utility from the Windows® desktop by clicking **Start > Programs > ASUS > ASUSUpdate > ASUSUpdate**. The ASUS Update main window appears.

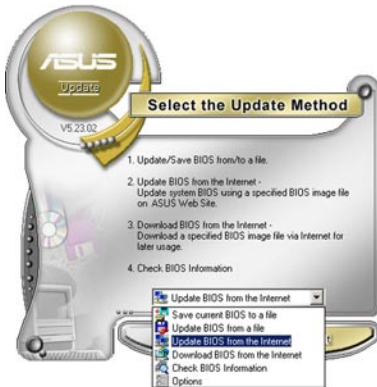
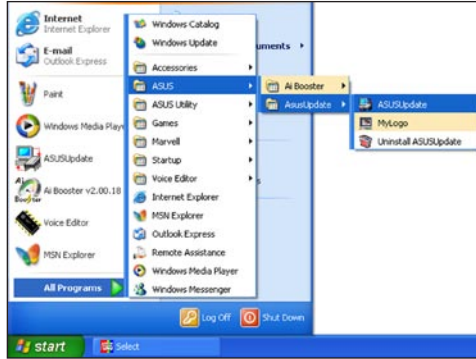

2. Select **Update BIOS from the Internet** option from the drop-down menu, then click **Next**.



3. Select the ASUS FTP site nearest you to avoid network traffic, or click **Auto Select**. Click **Next**.

- From the FTP site, select the BIOS version that you wish to download. Click **Next**.
- Follow the screen instructions to complete the update process.



The ASUS Update utility is capable of updating itself through the Internet. Always update the utility to avail all its features.



Updating the BIOS through a BIOS file

To update the BIOS through a BIOS file:

- Launch the ASUS Update utility from the Windows® desktop by clicking **Start > Programs > ASUS > ASUSUpdate > ASUSUpdate**. The ASUS Update main window appears.
- Select **Update BIOS from a file** option from the drop-down menu, then click **Next**.



- Locate the BIOS file from the **Open** window, then click **Open**.
- Follow the screen instructions to complete the update process.

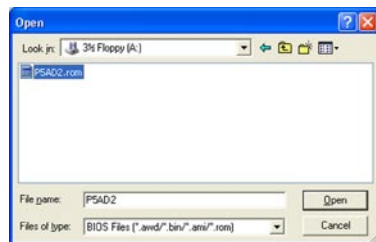

2.2 BIOS setup program

This motherboard supports a programmable firmware chip that you can update using the provided utility described in section “2.1 Managing and updating your BIOS.”

Use the BIOS Setup program when you are installing a motherboard, reconfiguring your system, or prompted to “Run Setup.” This section explains how to configure your system using this utility.

Even if you are not prompted to use the Setup program, you can change the configuration of your computer in the future. For example, you can enable the security password feature or change the power management settings. This requires you to reconfigure your system using the BIOS Setup program so that the computer can recognize these changes and record them in the CMOS RAM of the SPI chip.

The firmware chip on the motherboard stores the Setup utility. When you start up the computer, the system provides you with the opportunity to run this program. Press during the Power-On Self-Test (POST) to enter the Setup utility; otherwise, POST continues with its test routines.

If you wish to enter Setup after POST, reboot the system by doing any of the following procedures:

- Restart using the OS standard shut-down procedure.
- Press <Ctrl>+<Alt>+ simultaneously.
- Press the reset button on the system chassis.
- Press the power button to turn the system off then back on.



Using the **power button**, **reset button**, or the <Ctrl>+<Alt>+ keys to force reset from a running operating system can cause damage to your data or system. We recommend to always shut-down the system properly from the operating system.

The Setup program is designed to make it as easy to use as possible. Being a menu-driven program, it lets you scroll through the various sub-menus and make your selections from the available options using the navigation keys.



-
- The default BIOS settings for this motherboard apply for most conditions to ensure optimum performance. If the system becomes unstable after changing any BIOS settings, load the default settings to ensure system compatibility and stability. Select the **Load Setup Defaults** item under the Exit Menu. See section “2.8 Exit Menu.”
 - The BIOS setup screens shown in this section are for reference purposes only, and may not exactly match what you see on your screen.
 - Visit the ASUS website (www.asus.com) to download the latest BIOS file for this motherboard.
-

2.2.1 BIOS menu screen

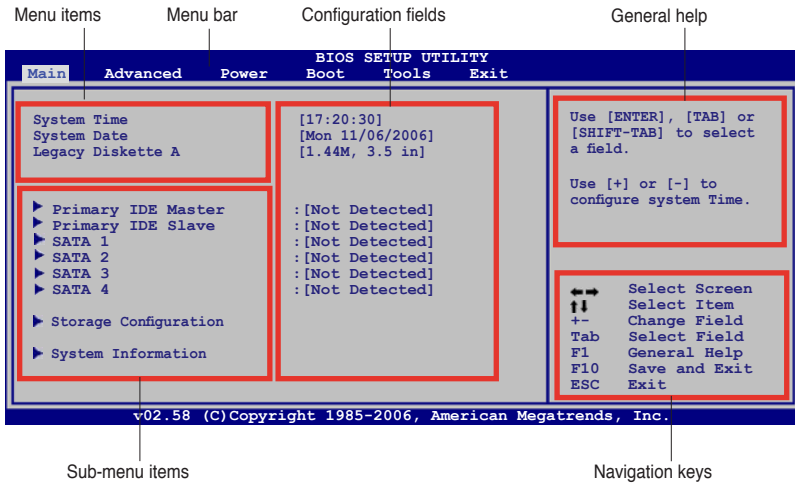

2.2.2 Menu bar

The menu bar on top of the screen has the following main items:

Main	For changing the basic system configuration
Advanced	For changing the advanced system settings
Power	For changing the advanced power management (APM) configuration
Boot	For changing the system boot configuration
Tools	For configuring options for special functions
Exit	For selecting the exit options and loading default settings

To select an item on the menu bar, press the right or left arrow key on the keyboard until the desired item is highlighted.

2.2.3 Navigation keys

At the bottom right corner of a menu screen are the navigation keys for that particular menu. Use the navigation keys to select items in the menu and change the settings.



Some of the navigation keys differ from one screen to another.

2.2.4 Menu items

The highlighted item on the menu bar displays the specific items for that menu. For example, selecting Main shows the Main menu items.

The other items (Advanced, Power, Boot, Tool, and Exit) on the menu bar have their respective menu items.

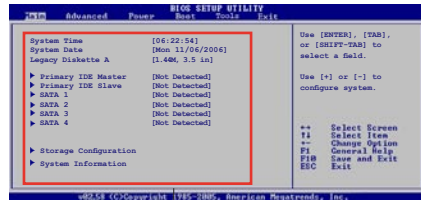

Main menu items

2.2.5 Sub-menu items

A solid triangle before each item on any menu screen means that the item has a sub-menu. To display the sub-menu, select the item and press <Enter>.

2.2.6 Configuration fields

These fields show the values for the menu items. If an item is user-configurable, you can change the value of the field opposite the item. You cannot select an item that is not user-configurable.

A configurable field is enclosed in brackets, and is highlighted when selected. To change the value of a field, select it then press <Enter> to display a list of options. Refer to "2.2.7 Pop-up window."

2.2.7 Pop-up window

Select a menu item then press <Enter> to display a pop-up window with the configuration options for that item.

2.2.8 Scroll bar

A scroll bar appears on the right side of a menu screen when there are items that do not fit on the screen. Press the Up/Down arrow keys or <Page Up> / <Page Down> keys to display the other items on the screen.

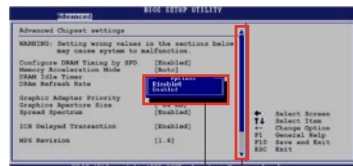

Pop-up window

Scroll bar

2.2.9 General help

At the top right corner of the menu screen is a brief description of the selected item.

2.3 Main menu

When you enter the BIOS Setup program, the Main menu screen appears, giving you an overview of the basic system information.



Refer to section "2.2.1 BIOS menu screen" for information on the menu screen items and how to navigate through them.

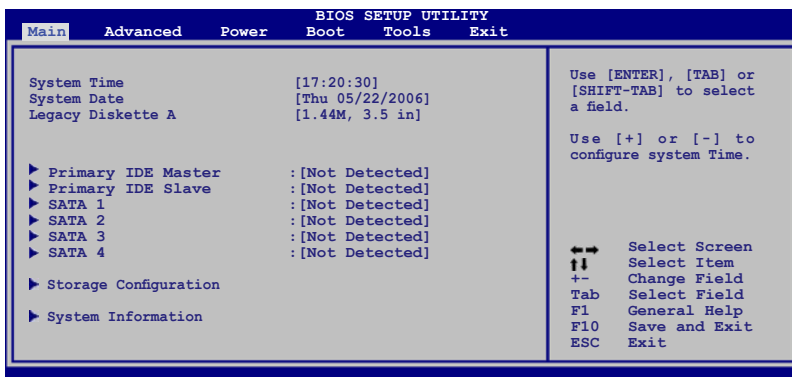

2.3.1 System Time [xx:xx:xx]

Allows you to set the system time.

2.3.2 System Date [Day xx/xx/xxxx]

Allows you to set the system date.

2.3.3 Legacy Diskette A [1.44M, 3.5 in.]

Sets the type of floppy drive installed.

Configuration options: [Disabled] [720K , 3.5 in.] [1.44M, 3.5 in.]

2.3.4 Primary IDE Master/Slave; SATA1-4

While entering Setup, the BIOS automatically detects the presence of IDE devices. There is a separate sub-menu for each IDE device. Select a device item then press <Enter> to display the IDE device information.

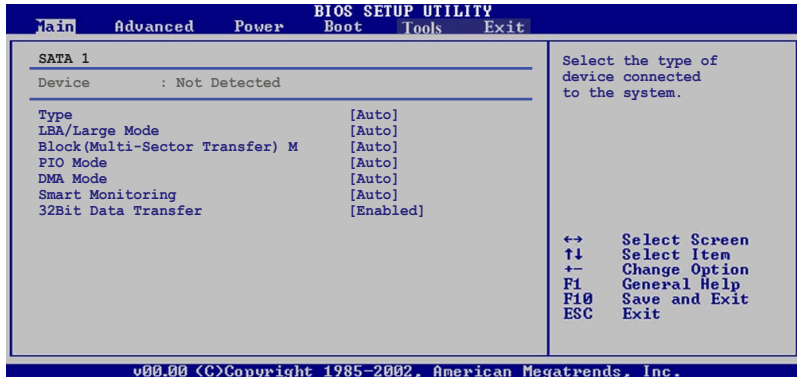

The BIOS automatically detects the values opposite the dimmed items (Device, Vendor, Size, LBA Mode, Block Mode, PIO Mode, Async DMA, Ultra DMA, and SMART monitoring). These values are not user-configurable. These items show N/A if no IDE device is installed in the system.

Type [Auto]

Selects the type of IDE drive. Setting to Auto allows automatic selection of the appropriate IDE device type. Select CDROM if you are specifically configuring a CD-ROM drive. Select ARMD (ATAPI Removable Media Device) if your device is either a ZIP, LS-120, or MO drive.

Configuration options: [Not Installed] [Auto] [CDROM] [ARMD]

LBA/Large Mode [Auto]

Enables or disables the LBA mode. Setting to Auto enables the LBA mode if the device supports this mode, and if the device was not previously formatted with LBA mode disabled. Configuration options: [Disabled] [Auto]

Block (Multi-Sector Transfer) M [Auto]

Enables or disables data multi-sectors transfers. When set to Auto, the data transfer from and to the device occurs multiple sectors at a time if the device supports multi-sector transfer feature. When set to [Disabled], the data transfer from and to the device occurs one sector at a time.

Configuration options: [Disabled] [Auto]

PIO Mode [Auto]

Selects the PIO mode. Configuration options: [Auto] [0] [1] [2] [3] [4]

DMA Mode [Auto]

Selects the DMA mode. Configuration options: [Auto] [SWDMA0] [SWDMA1] [SWDMA2] [MWDMA0] [MWDMA1] [MWDMA2] [UDMA0] [UDMA1] [UDMA2] [UDMA3] [UDMA4] [UDMA5]

SMART Monitoring [Auto]

Sets the Smart Monitoring, Analysis, and Reporting Technology.
Configuration options: [Auto] [Disabled] [Enabled]

32Bit Data Transfer [Disabled]

Enables or disables 32-bit data transfer.
Configuration options: [Disabled] [Enabled]

2.3.5 Storage Configuration

The items in this menu allow you to set or change the configurations for the IDE devices installed in the system. Select an item then press <Enter> if you wish to configure the item.

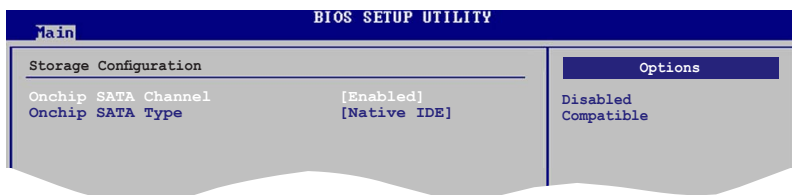

Onchip SATA Channel [Enabled]

Allows you to enable or disable the onchip SATA channel.
Configuration options: [Disabled] [Enabled]



The succeeding item appears only if the **OnChip SATA Channel** item is set to [Enabled].

Onchip SATA Type [Native IDE]

Allows you to select the onchip SATA type.
Configuration options: [Native IDE] [RAID] [AHCI] [Legacy IDE]

2.3.6 System Information

This menu gives you an overview of the general system specifications. The BIOS automatically detects the items in this menu.

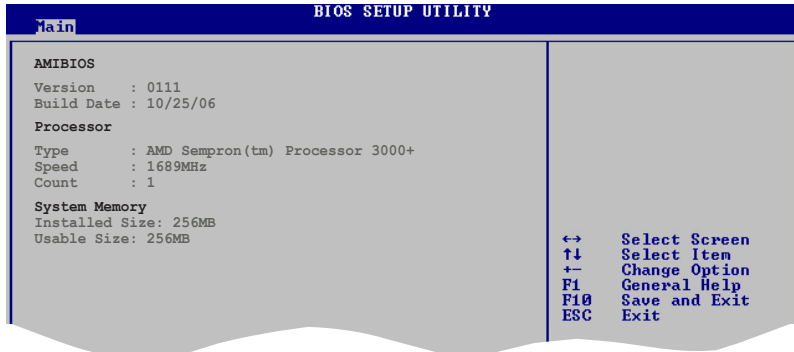

AMI BIOS

Displays the auto-detected BIOS information

Processor

Displays the auto-detected CPU specification

System Memory

Displays the auto-detected system memory

2.4 Advanced menu

The Advanced menu items allow you to change the settings for the CPU and other system devices.



Take caution when changing the settings of the Advanced menu items. Incorrect field values can cause the system to malfunction.

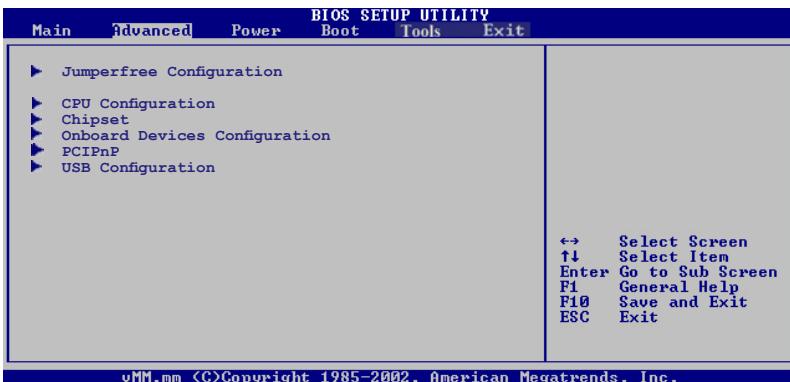

2.4.1 Jumperfree Configuration

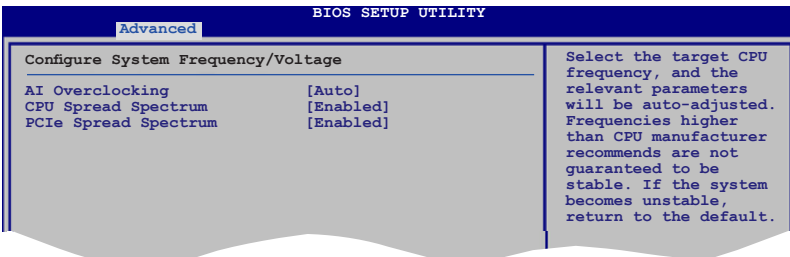

AI Overclocking [Auto]

Allows selection of CPU overclocking options to achieve desired CPU internal frequency. Select either one of the preset overclocking configuration options:

Manual Allows you to individually set overclocking parameters.

Auto Loads the optimal settings for the system.

Standard Loads the standard settings for the system.

EPP Memory The ASUS Non-delay Overclocking System feature intelligently determines the system load and automatically boosts the performance for the most demanding tasks.



The following items appear only when the **AI Overclocking** item is set to [Manual].

FSB Frequency [200]

Allows you to adjust the FSB frequency. The value of this item is auto-detected by the BIOS. Use the <+> and <-> keys to adjust the FSB frequency. You can also type the desired FSB frequency using the numeric keypad. The values range from 200 to 400.

Processor Frequency (FID) [Auto]

This item is not configurable.

Processor Voltage (VID) [Auto]

This item is not configurable.

CPU:ATI-NB HT Link Speed [Auto]

Configuration options: [Auto] [x1 200 MHz] [x2 400 MHz] [x3 600 MHz] [x4 800 MHz] [x5 1 GHz]

DDR Voltage [Auto]

Allows you to set the DDR memory voltage.

Configuration options: [Auto] [1.80 V] [1.90 V] [2.00V] [2.10 V]



Setting a very high voltage may damage the component permanently. Setting a very low voltage may cause the system to become unstable.

NB and SB Voltage [Auto]

Configuration options: [Auto] [1.20 V] [1.30 V] [1.40 V] [1.50 V]

HyperTransport Voltage [Auto]

Configuration options: [Auto] [1.20V] [1.30V] [1.40V] [1.50V]

CPU Spread Spectrum [Enabled]

Configuration options: [Disabled] [Enabled]

PCIe Spread Spectrum [Enabled]

Configuration options: [Disabled] [Enabled]

2.4.2 CPU Configuration

The items in this menu show the CPU-related information that the BIOS automatically detects.

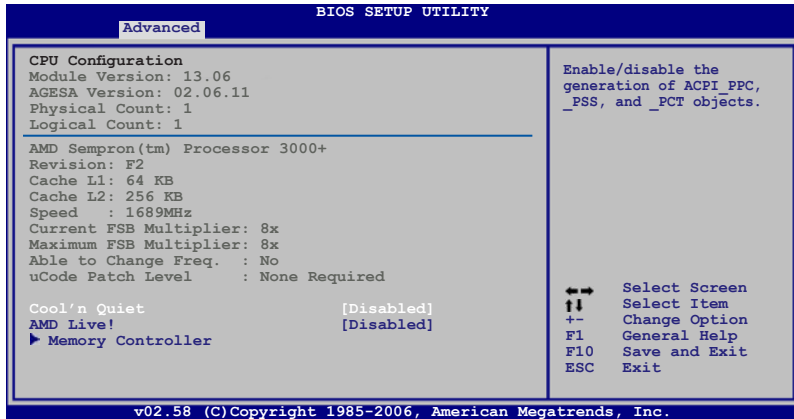

Cool 'n' Quiet [Disabled]

Enables or disables the Cool 'n' Quiet™ technology feature.

Configuration options: [Disabled] [Enabled]

AMD Live! [Disabled]

Enables or disables the AMD Live!™ technology feature.

Configuration options: [Disabled] [Enabled]

Memory Controller

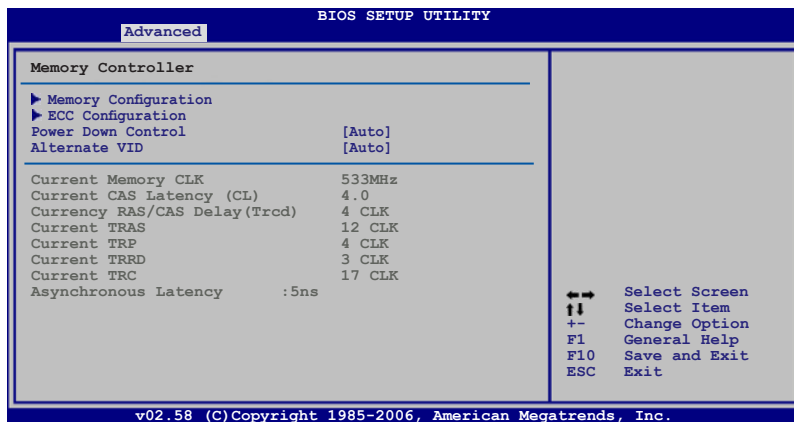

Memory Configuraiton

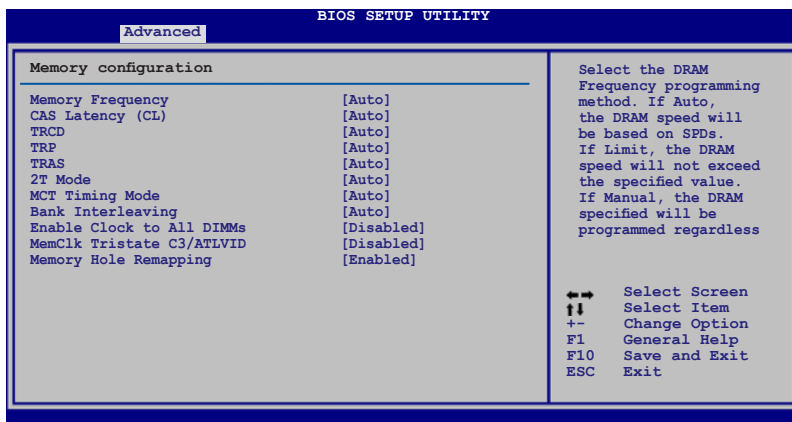

Memory Frequency [Auto]

Allows you to select the DRAM Frequency programming method.

Configuration options: [Auto] [Limit] [Manual]



The following item appears when the **Memory Frequency** item is set to [Limit] and [Manual].

Frequency [200 MHz]

Allows you to set the memory frequency.

Configuration options: [200 MHz] [266 MHz] [333 MHz] [400 MHz]

CAS Latency (CL) [Auto]

Configuration options: [Auto] [3.0] [4.0] [5.0] [6.0]

TRCD [Auto]

Configuration options: [Auto] [3 CLK] [4 CLK] [5 CLK] [6 CLK]

TRP [Auto]

Configuration options: [Auto] [3 CLK] [4 CLK] [5 CLK] [6 CLK]

TRAS [Auto]

Configuration options: [Auto] [5 CLK] [6 CLK] [7 CLK]~[18 CLK]

2T Mode [Auto]

Configuration options: [Auto] [Disabled] [Enable]

MCT Timing Mode [Auto]

Configuration options: [Auto] [Manual]



The following items appear when the **MCT Timing Mode** item is set to [Manual].

TRRD [Auto]

Configuration options: [Auto] [2T] [3T] [4T] [5T]

TRC [Auto]

Configuration options: [Auto] [11T] [12T] [13T]~[26T]

Bank Interleaving [Auto]

Sets to [Auto] or disables the Bank Memory Interleaving.

Configuration options: [Disabled] [Auto]

Enable Clock to All DIMMs [Disabled]

Enables or disables the unused clocks to DIMMs.

Configuration options: [Disabled] [Enabled]

MemClk Tristate C3/ATLVID [Disabled]

Enables or disables the MemClk Tri-Stating during C3 and Alt VID.

Configuration options: [Disabled] [Enabled]

Memory Hole Remapping [Enabled]

Enables or disables the Memory Remapping around Memory Hole.

Configuration options: [Disabled] [Enabled]

ECC Configuraiton

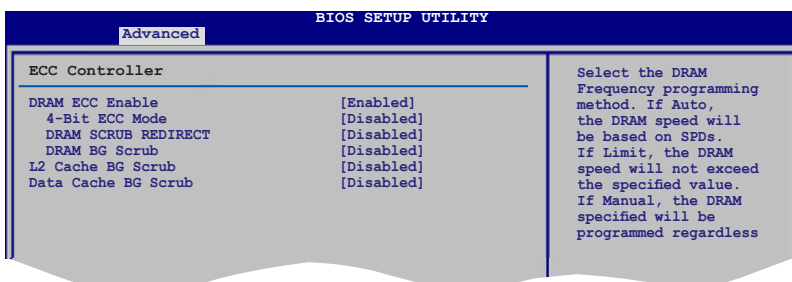

DRAM ECC Enable [Enabled]

Allows you to enable or disable DRAM ECC, which allows the hardware to report and correct memory errors automatically to maintain system integrity.

Configuration options: [Disabled] [Enabled]

4-Bit ECC Mode [Disabled]

Enables or disables the 4-bit ECC mode.

Configuration options: [Disabled] [Enabled]

DRAM SCRUB REDIRECT [Disabled]

Allows you to enable or disable DRAM scrub redirect, which allows the system to correct DRAM ECC errors immediately when they occur, even if background scrubbing is on. Configuration options: [Disabled] [Enabled]

DRAM BG Scrub [Disabled]

Allows DRAM scrubbing to correct memory errors so later reads are correct. Doing this while memory is not being used improves performance. Configuration options: [Disabled] [40ns] [80ns] [160ns] [320ns] [640ns] [1.28us] [2.56us] [5.12us] [10.2us] [20.5 us] [41.0us] [81.9us] [163.8us] [327.7us] [655.4us] [1.31ms] [2.62ms] [5.24ms] [10.49ms] [20.97ms] [42.00ms] [84.00ms]

L2 Cache BG Scrub [Disabled]

Allows the L2 Data Cache RAM to be corrected while idle. Configuration options: [Disabled] [40ns] [80ns] [160ns] [320ns] [640ns] [1.28us] [2.56us] [5.12us] [10.2us] [20.5 us] [41.0us] [81.9us] [163.8us] [327.7us] [655.4us] [1.31ms] [2.62ms] [5.24ms] [10.49ms] [20.97ms] [42.00ms] [84.00ms]

Data Cache BG Scrub [Disabled]

Allows the L1 Data Cache RAM to be corrected while idle. Configuration options: [Disabled] [40ns] [80ns] [160ns] [320ns] [640ns] [1.28us] [2.56us] [5.12us] [10.2us] [20.5 us] [41.0us] [81.9us] [163.8us] [327.7us] [655.4us] [1.31ms] [2.62ms] [5.24ms] [10.49ms] [20.97ms] [42.00ms] [84.00ms]

Power Down Control [Auto]

Allows DIMMs to enter power down mode by deasserting the clock enable signal when DIMMs are not in use. Configuration options: [Auto] [Disabled]

Alternate VID [Auto]

Specifies the alternate VID while in low power state.

Configuration options: [1.550 V] [1.525 V] [1.500 V] [1.475 V] [1.450]~[0.825 V] [0.800 V] [Auto]

2.4.3 Chipset

The Chipset menu allows you to change the advanced chipset settings. Select an item then press <Enter> to display the sub-menu.

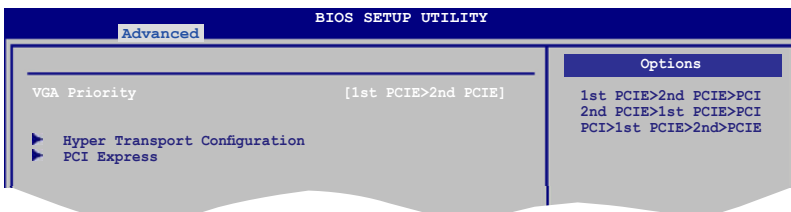

VGA Priority [1st PCIE->2nd PCIE->PCI]

Allows you to select the priority of the VGA cards you use.

Configuration options: [1st PCIE>2nd PCIE>PCI] [2nd PCIE>1st PCIE>PCI] [PCI>1st PCIE>2nd PCIE]

Hyper Transport Configuration

Allows you to configure the HT links.

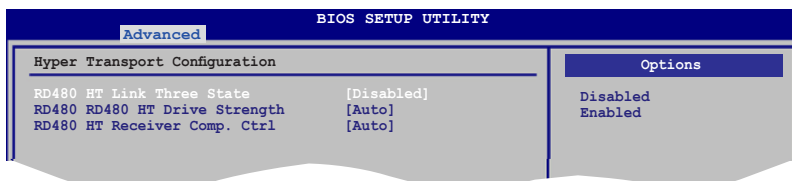

RD480 HT Link Three State [Disabled]

Configuration options: [Disabled] [Enabled]

RD480 RD480 HT Drive Strength [Auto]

Configuration options: [Auto] [Optimal]

RD480 HT Receiver Comp. Ctrl [Auto]

Configuration options: [Auto] [Optimal]

PCI Express Configuration

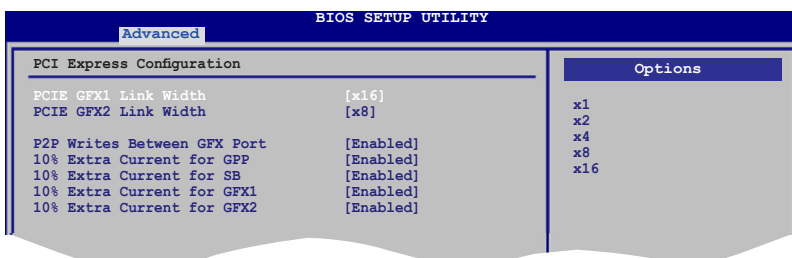

PCIE GFX1 Link Width [x16]

Configuration options: [x1] [x2] [x4] [x8] [x16]

PCIE GFX2 Link Width [x8]

Configuration options: [x1] [x2] [x4] [x8]

P2P Writes Between GFX Ports [Enabled]

Configuration options: [Disabled] [Enabled]

10% Extra Current for GPP [Enabled]

Configuration options: [Disabled] [Enabled]

10% Extra Current for SB [Enabled]

Configuration options: [Disabled] [Enabled]

10% Extra Current for GFX1 [Enabled]

Configuration options: [Disabled] [Enabled]

10% Extra Current for GFX2 [Enabled]

Configuration options: [Disabled] [Enabled]

2.4.4 Onboard Devices Configuration

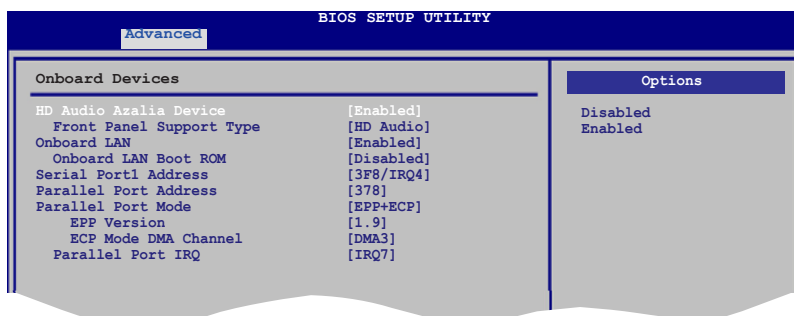

HD Audio Azalia Device [Enabled]

Allows you to enable or disable the HD Audio Azalia Device.

Configuration options: [Disabled] [Enabled]



The following item appears only when the **HD Audio Azalia Device** item is set to [Enabled].

Front Panel Support Type [HD Audio]

Allows you to select the front panel support type. When the High Definition Audio Front Panel is used, set the mode to [HD Audio].

Configuration options: [AC97] [HD Audio]

Onboard LAN [Enabled]

Allows you to enable or disable the onchip MAC LAN.

Configuration options: [Disabled] [Enabled]

Onboard LAN Boot ROM [Disabled]

This item allows you to enable or disable the MAC boot ROM. This item appears only when the Onboard LAN item is set to [Enabled].

Configuration options: [Disabled] [Enabled]

Serial Port1 Address [3F8/IRQ4]

Allows you to select the Serial Port1 base address.

Configuration options: [Disabled] [3F8/IRQ4] [2F8/IRQ3] [3E8/IRQ4] [2E8/IRQ3]

Parallel Port Address [378]

Allows you to select the Parallel Port base addresses.

Configuration options: [Disabled] [378] [278]

Parallel Port Mode [EPP+ECP]

Allows you to select the Parallel Port mode.

Configuration options: [Normal] [EPP] [ECP] [EPP+ECP]

EPP Version [1.9]

Appears only when the Parallel Port Mode is set to [EPP] or [EPP+ECP]. This item allows you to select the Parallel Port EPP version.

Configuration options: [1.9] [1.7]

ECP Mode DMA Channel [DMA3]

Appears only when the Parallel Port Mode is set to [ECP] or [EPP+ECP]. This item allows you to select the Parallel Port ECP DMA.

Configuration options: [DMA0] [DMA1] [DMA3]

Parallel Port IRQ [IRQ7]

Configuration options: [IRQ5] [IRQ7]

2.4.5 PCI PnP

The PCI PnP menu items allow you to change the advanced settings for PCI/PnP devices. The menu includes setting IRQ and DMA channel resources for either PCI/PnP or legacy ISA devices, and setting the memory size block for legacy ISA devices.



Take caution when changing the settings of the PCI PnP menu items. Incorrect field values can cause the system to malfunction.

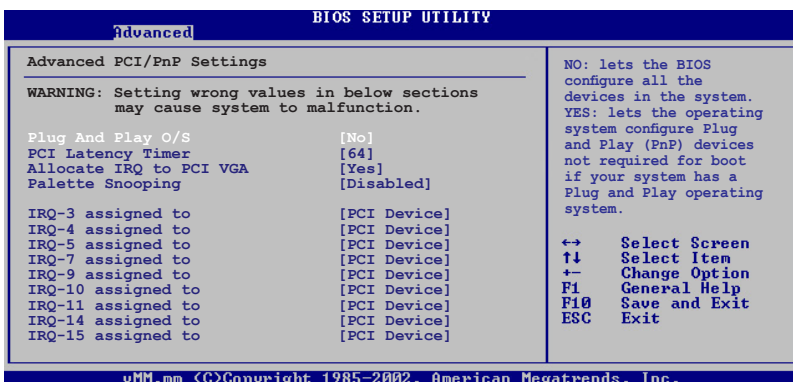

Plug and Play O/S [No]

When set to [No], BIOS configures all the devices in the system. When set to [Yes] and if you install a Plug and Play operating system, the operating system configures the Plug and Play devices not required for boot.

Configuration options: [No] [Yes]

PCI Latency Timer [64]

Allows you to select the value in units of PCI clocks for the PCI device latency timer register. Configuration options: [32] [64] [96] [128] [160] [192] [224] [248]

Allocate IRQ to PCI VGA [Yes]

When set to [Yes], BIOS assigns an IRQ to PCI VGA card if the card requests for an IRQ. When set to [No], BIOS does not assign an IRQ to the PCI VGA card even if requested. Configuration options: [Yes] [No]

Palette Snooping [Disabled]

When set to [Enabled], the palette snooping feature informs the PCI devices that an ISA graphics device is installed in the system so that the latter can function correctly. Configuration options: [Disabled] [Enabled]

IRQ-xx assigned to [PCI Device]

When set to [PCI Device], the specific IRQ is free for use of PCI/PnP devices. When set to [Reserved], the IRQ is reserved for legacy ISA devices. Configuration options: [PCI Device] [Reserved]

2.4.6 USB Configuration

The items in this menu allows you to change the USB-related features. Select an item then press <Enter> to display the configuration options.

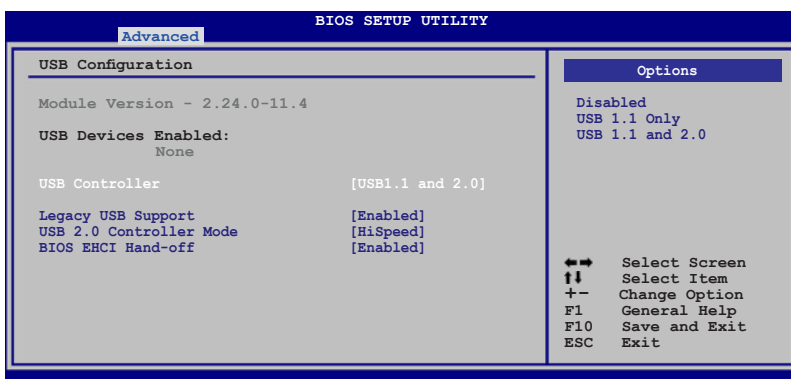

The Module Version and USB Devices Enabled items show the auto-detected values. If no USB device is detected, the item shows None.

USB Controller [USB 1.1 and 2.0]

Allows you to select or disable the USB controller.

Configuration options: [Disabled] [USB 1.1 Only] [USB 1.1 and 2.0]

Legacy USB Support [Auto]

Allows you to enable or disable support for USB devices on legacy operating systems (OS). Setting to [Auto] allows the system to detect the presence of USB devices at startup. If detected, the USB controller legacy mode is enabled. If no USB device is detected, the legacy USB support is disabled.

Configuration options: [Disabled] [Enabled] [Auto]

USB 2.0 Controller Mode [HiSpeed]

Allows you to configure the USB 2.0 controller in HiSpeed (480 Mbps) or Full Speed (12 Mbps). Configuration options: [FullSpeed] [HiSpeed]

BIOS EHCI Hand-Off [Enabled]

Allows you to enable support for operating systems without an EHCI hand-off feature. Configuration options: [Disabled] [Enabled]

2.5 Power menu

The Power menu items allow you to change the settings for the Advanced Power Management (APM). Select an item then press <Enter> to display the configuration options.

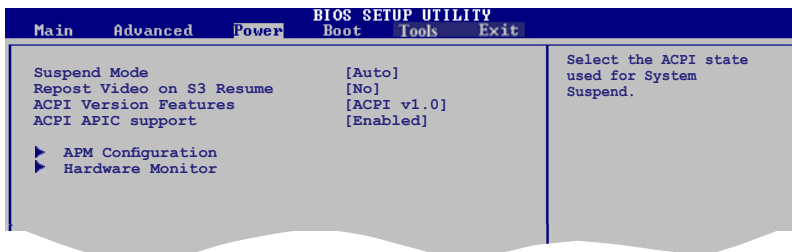

2.5.1 Suspend Mode [Auto]

Allows you to select the Advanced Configuration and Power Interface (ACPI) state to be used for system suspend.

Configuration options: [S1(POS) Only] [S3 Only] [Auto]

2.5.2 Repost Video on S3 Resume [No]

Allows you to determine whether to invoke VGA BIOS POST on S3/STR resume.

Configuration options: [No] [Yes]

2.5.3 ACPI Version Features [ACPI v1.0]

Allows you to add more tables for Advanced Configuration and Power Interface (ACPI) 2.0 specifications.

Configuration options: [ACPI v1.0] [ACPI v2.0] [ACPI v3.0]

2.5.4 ACPI APIC support [Enabled]

Allows you to enable or disable the Advanced Configuration and Power Interface (ACPI) support in the Application-Specific Integrated Circuit (ASIC). When set to Enabled, the ACPI APIC table pointer is included in the RSDT pointer list.

Configuration options: [Disabled] [Enabled]

2.5.5 APM Configuration

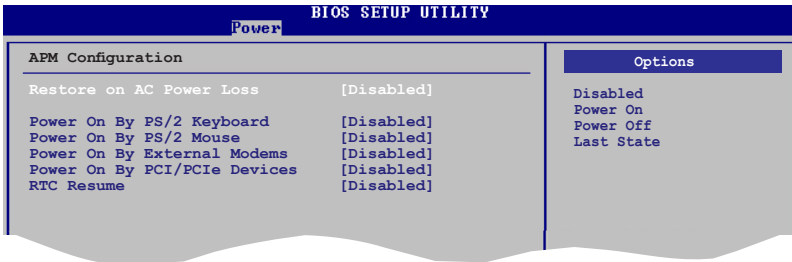

Restore on AC Power Loss [Disabled]

When set to [Power Off], the system goes into off state after an AC power loss. When set to [Power On], the system goes on after an AC power loss. When set to [Last State], the system goes into either off or on state, whatever the system state was before the AC power loss.

Configuration options: [Disabled] [Power Off] [Power On] [Last State]

Power On By PS/2 Keyboard [Disabled]

Allows you to use specific keys on the keyboard to turn on the system. This feature requires an ATX power supply that provides at least 1A on the +5VSB lead. Configuration options: [Disabled] [Enabled]

Power On By PS/2 Mouse [Disabled]

When set to [Enabled], this parameter allows you to use the PS/2 mouse to turn on the system. This feature requires an ATX power supply that provides at least 1A on the +5VSB lead. Configuration options: [Disabled] [Enabled]

Power On By External Modems [Disabled]

This allows either settings of [Enabled] or [Disabled] for powering up the computer when the external modem receives a call while the computer is in Soft-off mode. Configuration options: [Disabled] [Enabled]



The computer cannot receive or transmit data until the computer and applications are fully running. Thus, connection cannot be made on the first try. Turning an external modem off and then back on while the computer is off causes an initialization string that turns the system power on.

Power On By PCI/PCIe Devices [Disabled]

When set to [Enabled], this parameter allows you to turn on the system through a PCI LAN or modem card. This feature requires an ATX power supply that provides at least 1A on the +5VSB lead.

Configuration options: [Disabled] [Enabled]

RTC Resume [Disabled]

Enables or disables the RTC function.

Configuration options: [Disabled] [Enabled]



The succeeding items appear when the RTC Resume item is set to [Enabled].

RTC Alarm Date (Days) [15]

To set the alarm date, highlight this item and press the <+> or <-> key to make the selection.

RTC Alarm Time (HH:MM:SS) [12:30:30]

To set the alarm time, use the <Enter>, <Tab>, or <Shift> to select a field, and press the <+> or <-> key to make the selection.

2.5.6 Hardware Monitor

BIOS SETUP UTILITY	
Power	
Hardware Monitor	CPU Temperature
CPU Temperature [27°C/80°F]	
MB Temperature [32°C/89.5°F]	
CPU Fan Speed [2812RPM]	
Chasis Fan Speed [N/A]	
Power Fan Speed [N/A]	
VCORE Voltage [1.344V]	
3.3V Voltage [2.784V]	
5V Voltage [4.327V]	
12V Voltage [10.761V]	
Smart Q-Fan Function [Disabled]	
	↔ Select Screen
	↑↓ Select Item
	+ - Change Option
	F1 General Help
	F10 Save and Exit
	ESC Exit

vMM.mm (C)Copyright 1985-2002, American Megatrends, Inc.

CPU Temperature [xxx°C/xxx°F]

MB Temperature [xxx°C/xxx°F]

The onboard hardware monitor automatically detects and displays the motherboard and CPU temperatures. Select [Ignored] if you do not wish to display the detected temperatures.

CPU Fan Speed [xxxxRPM] or [Ignored] / [N/A]

The onboard hardware monitor automatically detects and displays the CPU fan speed in rotations per minute (RPM). If the fan is not connected to the motherboard, the field shows N/A.

Chasis Fan Speed [xxxxRPM] or [Ignored] / [N/A]

The onboard hardware monitor automatically detects and displays the chasis fan speed in rotations per minute (RPM). If the fan is not connected to the motherboard, the field shows N/A.

Power Fan Speed [xxxxRPM] or [Ignored] / [N/A]

The onboard hardware monitor automatically detects and displays the chassis fan speed in rotations per minute (RPM). If the fan is not connected to the motherboard, the field shows N/A.

VCORE Voltage; 3.3V Voltage; 5V Voltage; 12V Voltage

The onboard hardware monitor automatically detects the voltage output through the onboard voltage regulators. Select [Ignored] if you do not wish to display these items.

Smart Q-FAN Function [Disabled]

Allows you to enable or disable the ASUS Q-Fan feature that smartly adjusts the fan speeds for more efficient system operation.

Configuration options: [Disabled] [Enabled]



The following items appear when the **Smart Q-FAN Function** item is set to [Enabled].

CPU Fan type [DC]

Allows you to set the CPU fan type. Configuration options: [DC] [PWM]

Smart Fan Mode [Optimal]

Allows you to set the Smart Fan mode.

Configuration options: [Performance] [Optimal] [Silent]

2.6 Boot menu

The Boot menu items allow you to change the system boot options. Select an item then press <Enter> to display the sub-menu.

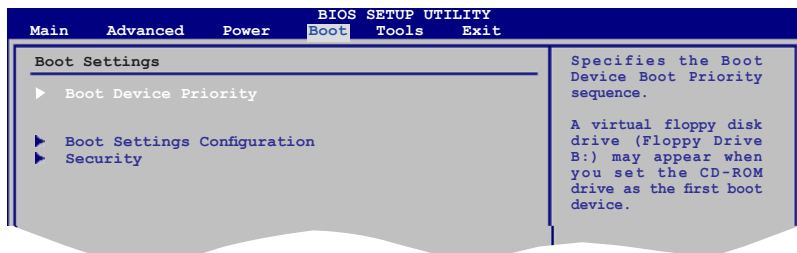

2.6.1 Boot Device Priority

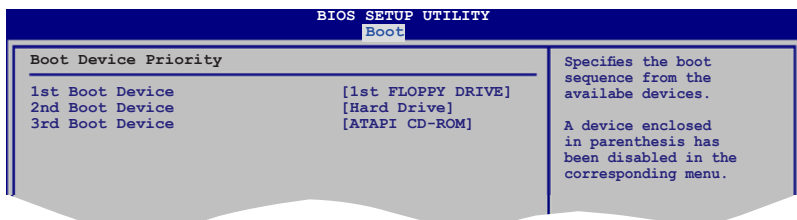

1st ~ xxth Boot Device [xxx Drive]

These items specify the boot device priority sequence from the available devices. The number of device items that appears on the screen depends on the number of devices installed in the system. Configuration options: [xxx Drive] [Disabled]

2.6.2 Boot Settings Configuration

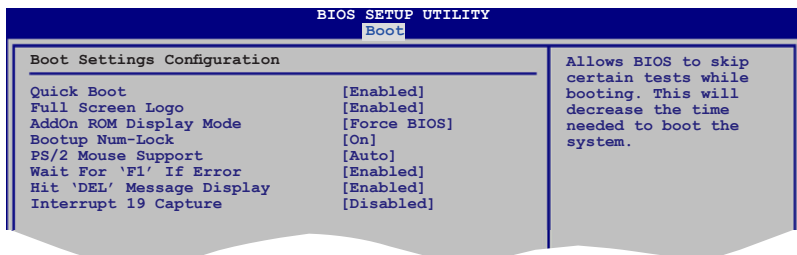

Quick Boot [Enabled]

Enabling this item allows the BIOS to skip some power on self tests (POST) while booting to decrease the time needed to boot the system. When set to [Disabled], BIOS performs all the POST items. Configuration options: [Disabled] [Enabled]

Full Screen Logo [Enabled]

This allows you to enable or disable the full screen logo display feature.

Configuration options: [Disabled] [Enabled]



Set this item to [Enabled] to use the ASUS MyLogo™ feature.

Add On ROM Display Mode [Force BIOS]

Sets the display mode for option ROM.

Configuration options: [Force BIOS] [Keep Current]

Bootup Num-Lock [On]

Allows you to select the power-on state for the NumLock.

Configuration options: [Off] [On]

PS/2 Mouse Support [Auto]

Allows you to enable or disable support for PS/2 mouse.

Configuration options: [Disabled] [Enabled] [Auto]

Wait for 'F1' If Error [Enabled]

When set to Enabled, the system waits for the F1 key to be pressed when error occurs. Configuration options: [Disabled] [Enabled]

Hit 'DEL' Message Display [Enabled]

When set to Enabled, the system displays the message "Press DEL to run Setup" during POST. Configuration options: [Disabled] [Enabled]

Interrupt 19 Capture [Disabled]

When set to [Enabled], this function allows the option ROMs to trap Interrupt 19.

Configuration options: [Disabled] [Enabled]

2.6.3 Security

The Security menu items allow you to change the system security settings. Select an item then press <Enter> to display the configuration options.

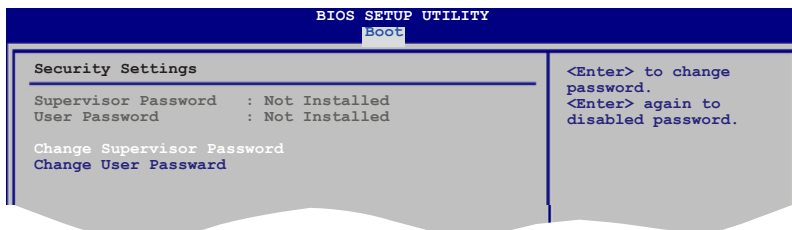

Change Supervisor Password

Select this item to set or change the supervisor password. The Supervisor Password item on top of the screen shows the default Not Installed. After you set a password, this item shows Installed.

To set a Supervisor Password:

1. Select the Change Supervisor Password item and press <Enter>.
2. From the password box, type a password composed of at least six letters and/or numbers, then press <Enter>.
3. Confirm the password when prompted.

The message “Password Installed” appears after you successfully set your password.

To change the supervisor password, follow the same steps as in setting a user password.

To clear the supervisor password, select the Change Supervisor Password then press <Enter>. The message “Password Uninstalled” appears.



If you forget your BIOS password, you can clear it by erasing the CMOS Real Time Clock (RTC) RAM. See section “1.9 Jumpers” for information on how to erase the RTC RAM.

After you have set a supervisor password, the other items appear to allow you to change other security settings.

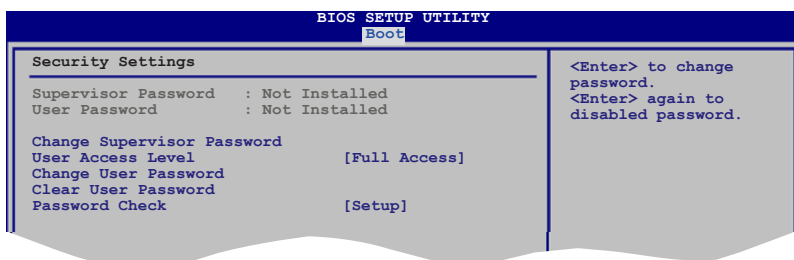

User Access Level [Full Access]

This item allows you to select the access restriction to the Setup items. Configuration options: [No Access] [View Only] [Limited] [Full Access]

No Access prevents user access to the Setup utility.

View Only allows access but does not allow change to any field.

Limited allows changes only to selected fields, such as Date and Time.

Full Access allows viewing and changing all the fields in the Setup utility.

Change User Password

Select this item to set or change the user password. The User Password item on top of the screen shows the default Not Installed. After you set a password, this item shows Installed.

To set a User Password:

1. Select the Change User Password item and press <Enter>.
2. On the password box that appears, type a password composed of at least six letters and/or numbers, then press <Enter>.
3. Confirm the password when prompted.

The message "Password Installed" appears after you set your password successfully.

To change the user password, follow the same steps as in setting a user password.

Clear User Password

Select this item to clear the user password.

Password Check [Setup]

When set to [Setup], BIOS checks for user password when accessing the Setup utility. When set to [Always], BIOS checks for user password both when accessing Setup and booting the system. Configuration options: [Setup] [Always]

2.7 Tools menu

The Tools menu items allow you to configure options for special functions. Select an item then press <Enter> to display the sub-menu.

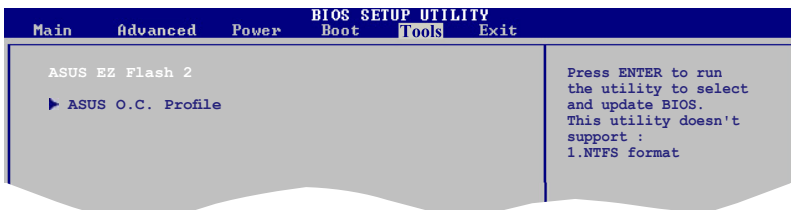

2.7.1 ASUS EZ Flash 2

Allows you to run ASUS EZ Flash 2. When you press <Enter>, a confirmation message appears. Use the left/right arrow key to select between [Yes] or [No], then press <Enter> to confirm your choice. Please see page 2-3, section 2.1.2 for details.

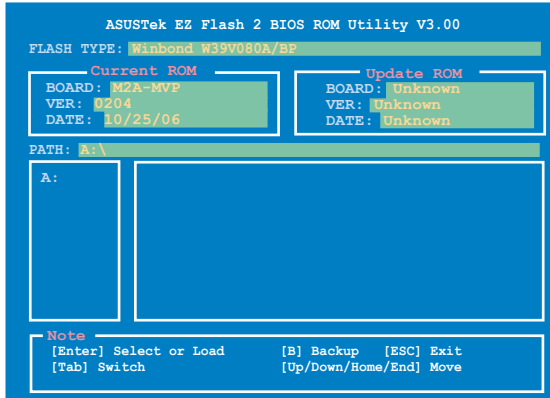

2.7.2 ASUS O.C. Profile

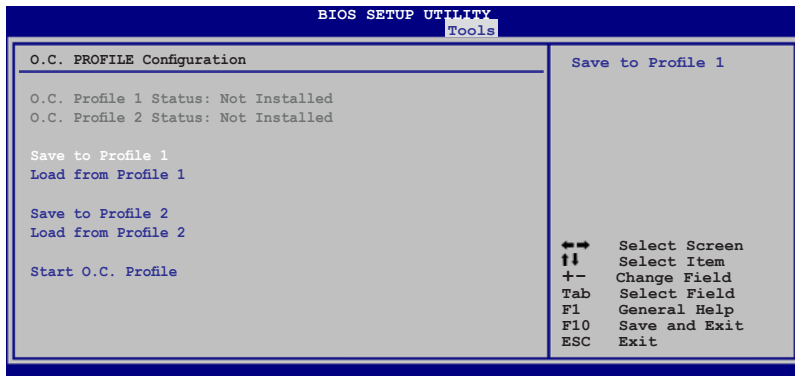

Save to Profile 1/2

Allows you to save the current BIOS file to the BIOS Flash. Press <Enter> to save the file.

Load from Profile 1/2

Allows you to load the previous BIOS settings saved in the BIOS Flash. Press <Enter> to load the file.

Start O.C. Profile

Allows you to run the utility to save and load CMOS. Press <Enter> to run the utility.

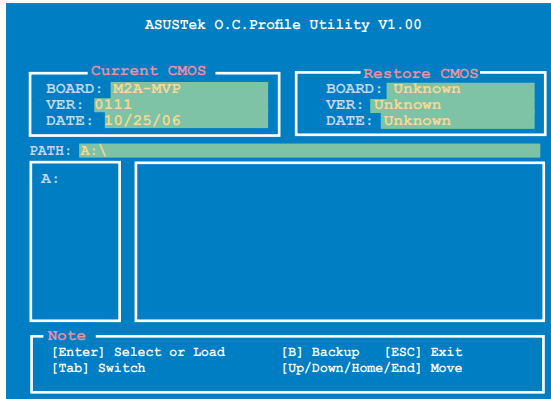

- This function can support devices such as USB flash disk, or floppy disk with FAT 32/16 format and single partition only.
- DO NOT shutdown or reset the system while updating the BIOS to prevent system boot failure!

2.8 Exit menu

The Exit menu items allow you to load the optimal or failsafe default values for the BIOS items, and save or discard your changes to the BIOS items.

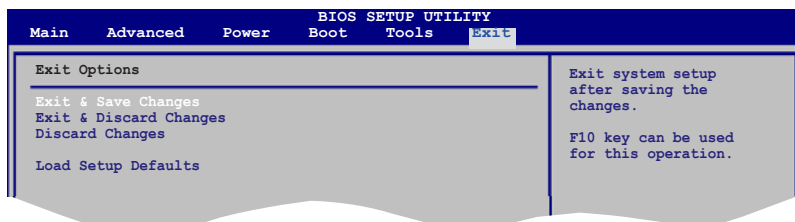

Pressing <Esc> does not immediately exit this menu. Select one of the options from this menu or <F10> from the legend bar to exit.

Exit & Save Changes

Once you are finished making your selections, choose this option from the Exit menu to ensure the values you selected are saved to the CMOS RAM. An onboard backup battery sustains the CMOS RAM so it stays on even when the PC is turned off. When you select this option, a confirmation window appears. Select **OK** to save changes and exit.



If you attempt to exit the Setup program without saving your changes, the program prompts you with a message asking if you want to save your changes before exiting. Press <Enter> to save the changes while exiting.

Exit & Discard Changes

Select this option only if you do not want to save the changes that you made to the Setup program. If you made changes to fields other than System Date, System Time, and Password, the BIOS asks for a confirmation before exiting.

Discard Changes

This option allows you to discard the selections you made and restore the previously saved values. After selecting this option, a confirmation appears. Select **OK** to discard any changes and load the previously saved values.

Load Setup Defaults

This option allows you to load the default values for each of the parameters on the Setup menus. When you select this option or if you press <F5>, a confirmation window appears. Select **OK** to load default values. Select **Exit & Save Changes** or make other changes before saving the values to the non-volatile RAM.

2.9 RAID configurations

The motherboard comes with a RAID controller integrated in the ULI M1575 Southbridge that allows you to configure Serial ATA hard disk drives as RAID sets. The motherboard supports the following RAID configurations.

RAID 0 (Data striping) optimizes two identical hard disk drives to read and write data in parallel, interleaved stacks. Two hard disks perform the same work as a single drive but at a sustained data transfer rate, double that of a single disk alone, thus improving data access and storage. Use of two new identical hard disk drives is required for this setup.

RAID 1 (Data mirroring) copies and maintains an identical image of data from one drive to a second drive. If one drive fails, the disk array management software directs all applications to the surviving drive as it contains a complete copy of the data in the other drive. This RAID configuration provides data protection and increases fault tolerance to the entire system. Use two new drives or use an existing drive and a new drive for this setup. The new drive must be of the same size or larger than the existing drive.

RAID 0+1 is data striping and data mirroring combined without parity (redundancy data) having to be calculated and written. With the RAID 0+1 configuration you get all the benefits of both RAID 0 and RAID 1 configurations. Use four new hard disk drives or use an existing drive and three new drives for this setup.

RAID 5 stripes both data and parity information across three or more hard disk drives. Among the advantages of RAID 5 configuration include better HDD performance, fault tolerance, and higher storage capacity. The RAID 5 configuration is best suited for transaction processing, relational database applications, enterprise resource planning, and other business systems. Use a minimum of three identical hard disk drives for this setup.

JBOD (Spanning) stands for Just a Bunch of Disks and refers to hard disk drives that are not yet configured as a RAID set. This configuration stores the same data redundantly on multiple disks that appear as a single disk on the operating system. Spanning does not deliver any advantage over using separate disks independently and does not provide fault tolerance or other RAID performance benefits.



If you want to boot the system from a hard disk drive included in a created RAID set, copy first the RAID driver from the support CD to a floppy disk before you install an operating system to the selected hard disk drive. Refer to section **2.10 Creating a RAID driver disk** for details.

2.9.1 Installing hard disks

The motherboard supports Ultra DMA 133/100/66 and Serial ATA hard disk drives. For optimal performance, install identical drives of the same model and capacity when creating a disk array.

Installing Serial ATA (SATA) hard disks

To install the SATA hard disks for a RAID configuration:

1. Install the SATA hard disks into the drive bays.
2. Connect the SATA signal cables.
3. Connect a SATA power cable to the power connector on each drive.

2.9.2 ULI® RAID configurations

The ULI® RAID controller supports RAID 0, RAID 1, RAID 0+1, RAID 5, and JBOD configurations. Use the ULI® RAID BIOS Setup utility to configure a disk array.



You may also set the RAID configurations in Windows® OS after you have installed the Serial ATA RAID driver. See section **3.2.4 Make Disk menu** for details.

Entering the ULI® RAID BIOS Setup Utility

To enter the ULI® RAID BIOS setup utility:

1. Boot up your computer, and press during POST to enter the BIOS setup.
2. In the Main Menu, go to Storage Configuration, and set the Onboard SATA Boot ROM item to [Enabled].
3. Press <F10> to save the changes and exit.
4. Reboot your computer.
5. During POST, press <Ctrl+A>



The RAID BIOS setup screens shown in this section are for reference only, and may not exactly match the items on your screen.

```

RAID BIOS Setup Utility (c) 2005 ULI Electronics Inc. www.uli.com.tw

Create RAID 0 Striping x2 for Performance
Create RAID 1 Mirroring for Reliability

Create RAID 0+1 Striping, Mirroring
Create JBOD for integrated Capacity
Stripe Size 6K
Delete RAID Settings & Partition
Delete All RAID Settings & Partition
Rebuild RAID Array
Create RAID 5 for Reliability

SPACE: Select
↑ ↓ : Moving Cursor
Enter: Select & Finish
ESC: Exit

-----Drive Model-----Mode-----Capacity---RAID Array/Type---
Channel 0 Master: XXXXXXXXXXXX SATA 2 XXXXX MB
Channel 1 Master: XXXXXXXXXXXX SATA 2 XXXXX MB
Channel 2 Master: XXXXXXXXXXXX SATA 2 XXXXX MB
Channel 3 Master: XXXXXXXXXXXX SATA 2 XXXXX MB

-----Capacity-----RAID Type-----Stripe Size---RAID Name
RAID Array A :
RAID Array B :
RAID Array C :

```

The Main Menu on the upper left side allows you to select an operation to perform. The Main Menu options include:

Create RAID 0 Striping x2 for Performance - creates a new legacy RAID set or allocates spare drives.

Create RAID 0+1 for Striping, Mirroring - creates a RAID setup with all the benefits of both RAID 0 and RAID 1 configuration.

Create JBOD for integrated capacity - creates a JBOD configuration.

Stripe Size - sets the stripe size.

Delete RAID Settings & Partition - deletes a selected RAID set and partition.

Delete All RAID Settings & Partition - deletes all current RAID set(s) and partition(s).

Rebuild RAID array - rebuilds mirror drive(s).

Create RAID 5 for Reliability - creates a RAID 5 configuration

On the upper right side of the screen is the legend box. The keys on the legend box allow you to navigate through the setup menu options. The following lists the keys in the legend box and their corresponding functions.

- SPACE** : Select an item
- ↑, ↓** : Move cursor to the next item
- Enter** : Confirms a selected item
- ESC** : Exit

Creating a RAID 0 configuration

To create a RAID 0 set:

1. From the ULI RAID BIOS Setup utility menu, move the cursor to **Create RAID 0 Striping for Performance** then press <Enter>.
2. Use the up or down arrow keys to select a drive then press <Space> or <Enter>. The striped mark “S” appears before a selected drive.
3. Repeat step 2 to select the second drive.
4. The utility prompts the following warning message:

```
Data on RAID drives will be deleted (Y/N)?
```

Press <Y> to continue or press <N> to return to the menu.

5. Key in a RAID name with a maximum of eight (8) alphanumeric characters then press <Enter>. Do not use special characters or symbols.
6. The utility displays the RAID Array settings at the bottom of the screen.

	Drive	Model	Mode	Capacity	RAID Array/Type
Channel 0	Master:	XXXXXXXXXX	SATA 2	XXXXX MB	RAID A/0x2
Channel 1	Master:	XXXXXXXXXX	SATA 2	XXXXX MB	
Channel 2	Master:	XXXXXXXXXX	SATA 2	XXXXX MB	RAID A/0x2
Channel 3	Master:	XXXXXXXXXX	SATA 2	XXXXX MB	

	Capacity	RAID Type	Stripe Size	RAID Name
RAID Array A :	XXXXX GB	0X2	16K	RAID0
RAID Array B :				
RAID Array C :				

Creating a RAID 1 configuration

To create a RAID 1 set:

1. From the ULI RAID BIOS Setup utility menu, move the cursor to **Create RAID 1 Mirroring for Reliability** then press <Enter>.
2. Use the up or down arrow keys to select a drive then press <Space> or <Enter>. The striped mark “M” appears before a selected drive.
3. Repeat step 2 to select the second drive.
4. The utility prompts the following warning message:

```
Create RAID 1 (Y/N)?
```

Press <Y> to continue or press <N> to return to the menu.

5. Key in a RAID name with a maximum of eight (8) alphanumeric characters then press <Enter>. Do not use special characters or symbols.
6. The utility prompts the following confirmation message:

```
Duplicate Data from M to m (Y/N)?
```

Press <Y> to duplicate data from the source disk “M” to the target disk “m” or press <N> to create a RAID 1 set without duplicating the data.

7. If you selected <Y>, the utility will duplicate your data. The following progress bar appears.

```
██████████ ██████████ 50% completed.
```

8. The utility displays the RAID Array settings at the bottom of the screen.

```

      Drive Model      Mode      Capacity RAID Array/Type
Channel 0 Master: XXXXXXXXXXXX SATA 2   XXXXX MB  RAID A/1
Channel 1 Master: XXXXXXXXXXXX SATA 2   XXXXX MB
Channel 2 Master: XXXXXXXXXXXX SATA 2   XXXXX MB  RAID A/1
Channel 3 Master: XXXXXXXXXXXX SATA 2   XXXXX MB

      Capacity      RAID Type  Stripe Size RAID Name
RAID Array A   :   XXXXX MB           1           RAID1
RAID Array B   :
RAID Array C   :
```

Creating a RAID 0+1 configuration

To create a RAID 0+1 set:

1. From the ULI RAID BIOS Setup utility menu, move the cursor to **Create RAID 0+1 Striping, Mirroring** then press <Enter>.
2. The utility prompts the following warning message:

```
Data on first 4 drives will be deleted (Y/N)?
```

Press <Y> to continue or press <N> to return to the menu.

3. Key in a RAID name with a maximum of eight (8) alphanumeric characters then press <Enter>. Do not use special characters or symbols.
4. The utility displays the RAID Array settings at the bottom of the screen.

	Drive Model	Mode	Capacity	RAID Array/Type
Channel 0 Master:	XXXXXXXXXX	SATA 2	XXXXX MB	RAID A/RAID0+1
Channel 1 Master:	XXXXXXXXXX	SATA 2	XXXXX MB	RAID A/RAID0+1
Channel 2 Master:	XXXXXXXXXX	SATA 2	XXXXX MB	RAID A/RAID0+1
Channel 3 Master:	XXXXXXXXXX	SATA 2	XXXXX MB	RAID A/RAID0+1

	Capacity	RAID Type	Stripe Size	RAID Name
RAID Array A :	XXXXX MB	0+1 X4		RAID01
RAID Array B :				
RAID Array C :				

Creating a JBOD configuration

To create a JBOD set:

1. From the ULI RAID BIOS Setup utility menu, move the cursor to **Create JBOD for integrated capacity** then press <Enter>.
2. Use the up or down arrow keys to select a drive then press <Space> or <Enter>. The striped mark “J” appears before a selected drive.
3. Repeat step 2 to select the second drive.
4. The utility prompts the following warning message:

```
Data on RAID drives will be deleted (Y/N)?
```

Press <Y> to continue or press <N> to return to the menu.

5. Key in a RAID name with a maximum of eight (8) alphanumeric characters then press <Enter>. Do not use special characters or symbols.
6. The utility displays the RAID Array settings at the bottom of the screen.

	Drive Model	Mode	Capacity	RAID Array/Type
Channel 0 Master:	XXXXXXXXXX	SATA 2	XXXX MB	RAID A/JBOD
Channel 1 Master:	XXXXXXXXXX		XXXX MB	
Channel 2 Master:	XXXXXXXXXX	SATA 2	XXXX MB	RAID A/JBOD
Channel 3 Master:	XXXXXXXXXX	SATA 2	XXXX MB	

	Capacity	RAID Type	Stripe Size	RAID Name
RAID Array A :	XXXX MB	JBOD		RAIDJ
RAID Array B :				
RAID Array C :				

Setting the Stripe Size

To set the stripe size:

1. From the ULI RAID BIOS Setup utility menu, move the cursor to **Stripe Size** then press <Enter>.
2. Use the up or down arrow keys to select a stripe size then press <Enter>.
3. The stripe size is displayed beside the Stripe Size menu item.



TIP: For server systems, we recommend using a lower array block size. For multimedia computer systems used mainly for audio and video editing, we recommend a higher array block size for optimum performance.

Deleting a RAID configuration

To delete a RAID set:

1. From the ULI RAID BIOS Setup utility menu, move the cursor to **Delete RAID Settings & Partition** then press <Enter>.
2. Use the up or down arrow keys to select a RAID set then press <Space> or <Enter>. The striped mark “E” appears before a selected drive.
3. The utility prompts the following warning message:

```
Data on RAID drives will be deleted (Y/N)?
```

Press <Y> to continue or press <N> to return to the menu.

Pressing <Y> removes the deleted RAID Array item from the list at the bottom of the screen.

Deleting All RAID configurations

To delete all RAID sets:

1. From the ULI RAID BIOS Setup utility menu, move the cursor to **Delete All RAID Settings & Partition** then press <Enter>.
2. The utility prompts the following warning message:

```
Data on RAID drives will be deleted (Y/N)?
```

Press <Y> to continue or press <N> to return to menu.

Pressing <Y> removes all the RAID Array items from the list at the bottom of the screen.

Rebuilding a RAID array

This option allows you to rebuild an existing RAID array.

To rebuild a RAID array:

1. From the ULI RAID BIOS Setup utility menu, move the cursor to **Rebuild RAID Array** then press <Enter>.
2. Use the up or down arrow keys to select the source drive from which to rebuild then press <Enter>. The striped mark "R" appears before a selected drive.
3. The utility prompts if you want to proceed with rebuilding the array. Press <Y> to continue or press <N> to return to the menu.

Creating a RAID 5 configuration

To create a RAID 5 set:

1. From the ULI RAID BIOS Setup utility menu, move the cursor to **Create RAID 5 for Reliability** then press <Enter>.
2. Use the up or down arrow keys to select a drive then press <Space> or <Enter>. The striped mark "5" appears before a selected drive.
3. Repeat step 2 to select the second and third drives.
4. The utility prompts the following warning message:

```
Data on RAID drives will be deleted (Y/N)?
```

Press <Y> to continue or press <N> to return to the menu.

5. Key in a RAID name with a maximum of eight (8) alphanumeric characters then press <Enter>. Do not use special characters or symbols.
6. The utility displays the RAID Array settings at the bottom of the screen.

	Drive Model	Mode	Capacity	RAID Array/Type
Channel 0 Master:	XXXXXXXXXXXX	SATA 2	XXXXX MB	RAID A/5
Channel 1 Master:	XXXXXXXXXXXX		XXXXX MB	
Channel 2 Master:	XXXXXXXXXXXX	SATA 2	XXXXX MB	RAID A/5
Channel 3 Master:	XXXXXXXXXXXX	SATA 2	XXXXX MB	RAID A/5

	Capacity	RAID Type	Stripe Size	RAID Name
RAID Array A :	160 GB	5	16K	RAID5
RAID Array B :				
RAID Array C :				

2.10 Creating a RAID driver disk

A floppy disk with the RAID driver is required when installing Windows® 2000/XP operating system on a hard disk drive that is included in a RAID set.

To create a RAID driver disk:

1. Boot your computer.
2. Press during POST to enter the BIOS setup utility.
3. Set the optical drive as the primary boot device.
4. Save changes and exit BIOS.
5. Insert the support CD into the optical drive.
6. Press the any key when the system prompts "Press any key to boot from the optical drive." The following menu appears:

```
1) Make ULI RAID Driver Disk
2) Format Floppy Disk
3) FreeDOS command prompt
Please choose 1 ~ 3: _
```

7. Press <1> to create a RAID driver disk.
8. Insert a formatted floppy disk into the floppy drive then press <Enter>.
9. Follow succeeding screen instructions to complete the process.

- OR -

1. Start Windows® .
2. Place the motherboard support CD into the optical drive.
3. When the **Drivers** menu appears, click **Make ULI Chipset Driver Disk** to create a ULI RAID driver disk.
4. Insert a floppy disk into the floppy disk drive.
5. Follow succeeding screen instructions to complete the process.



Write-protect the floppy disk to avoid computer virus infection.

To install the RAID driver:

1. During the OS installation, the system prompts you to press the F6 key to install third-party SCSI or RAID driver.
2. Press <F6> then insert the floppy disk with RAID driver into the floppy disk drive.
3. Follow the succeeding screen instructions to complete the installation.

This chapter describes the contents of the support CD that comes with the motherboard package.

3 Software support

3.1 Installing an operating system

This motherboard supports Windows® 2000/XP/64-bit XP operating systems (OS). Always install the latest OS version and corresponding updates to maximize the features of your hardware.



- Motherboard settings and hardware options vary. Use the setup procedures presented in this chapter for reference only. Refer to your OS documentation for detailed information.
- Make sure that you install Windows® 2000 Service Pack 4 or the Windows® XP Service Pack 2 or later versions before installing the drivers for better compatibility and system stability.

3.2 Support CD information

The support CD that came with the motherboard package contains the drivers, software applications, and utilities that you can install to avail all motherboard features.



The contents of the support CD are subject to change at any time without notice. Visit the ASUS website (www.asus.com) for updates.

3.2.1 Running the support CD

Place the support CD to the optical drive. The CD automatically displays the Drivers menu if Autorun is enabled in your computer.

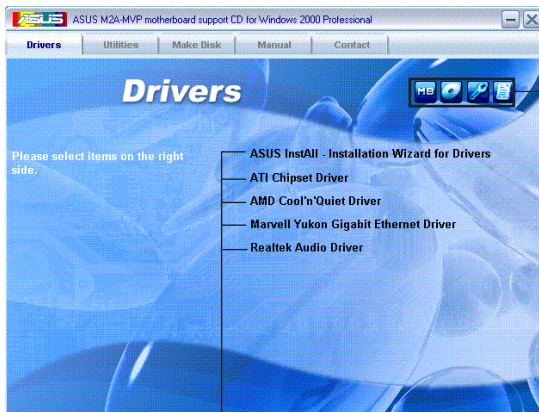

Click an icon to display support CD/motherboard information

Click an item to install



If Autorun is NOT enabled in your computer, browse the contents of the support CD to locate the file ASSETUP.EXE from the BIN folder. Double-click the ASSETUP.EXE to run the CD.

3.2.2 Drivers menu

The drivers menu shows the available device drivers if the system detects installed devices. Install the necessary drivers to activate the devices.



ASUS InstAll-Drivers Installation Wizard

Installs the ASUS InstAll-Drivers installation wizard.

ATI Chipset Driver

Installs the ATI® chipset driver.

AMD Cool 'n' Quiet Driver

Installs the AMD Cool 'n' Quiet™ driver.

Marvell Yukon Gigabit Ethernet Driver

Installs the Marvell® Yukon Gigabit Ethernet driver.

Realtek Audio Driver

Installs the Realtek® audio driver.

3.2.3 Utilities menu

The Utilities menu shows the applications and other software that the motherboard supports.



ASUS InstAll-Installation Wizard for Utilities

Install the ASUS InstAll-Installation Wizard.

ASUS Cool 'n' Quiet Utility

Installs the AMD Cool 'n' Quiet™ software.

ASUS PC Probe II

This smart utility monitors the fan speed, CPU temperature, and system voltages, and alerts you of any detected problems. This utility helps you keep your computer in healthy operating condition.

ASUS Update

The ASUS Update utility allows you to update the motherboard BIOS in Windows® environment. This utility requires an Internet connection either through a network or an Internet Service Provider (ISP)

Adobe Reader V7.0

Installs the Adobe® Acrobat® Reader that allows you to open, view, and print documents in Portable Document Format (PDF).

Microsoft DirectX 9.0c

Installs the Microsoft® DirectX 9.0c driver. The Microsoft DirectX® 9.0c is a multimedia technology that enhances computer graphics and sound. DirectX® improves the multimedia features of your computer so you can enjoy watching TV and movies, capturing videos, or playing games in your computer. Visit the Microsoft website (www.microsoft.com) for updates.

Anti-Virus Utility

The anti-virus application scans, identifies, and removes computer viruses. View the online help for detailed information.

3.2.4 Make Disk menu

The Make Disk menu contains the item needed to create the ATI® RAID driver disk.



Make ATI RAID Driver

Allows you to create the ATI® driver disk.

3.2.5 Manuals menu

The Manuals menu contains a list of supplementary user manuals. Click an item to open the folder of the user manual.



Most user manual files are in Portable Document Format (PDF). Download the Adobe® Acrobat® Reader from www.adobe.com if you do not have one.

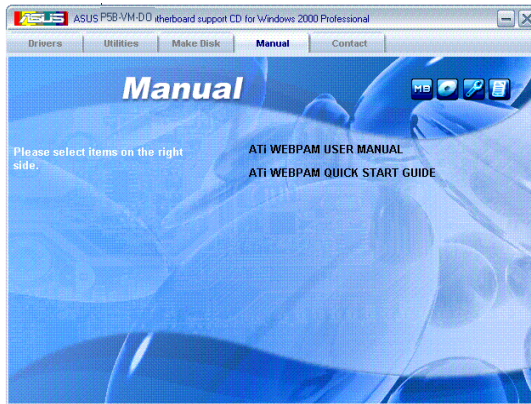

3.2.6 ASUS Contact information

Click the Contact tab to display the ASUS contact information. You can also find this information on the inside front cover of this user guide.

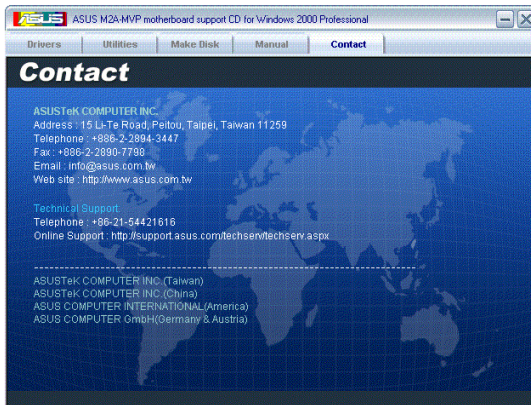

3.2.7 Other information

The icons on the top right corner of the screen give additional information on the motherboard and the contents of the support CD. Click an icon to display the specified information.

Motherboard Info

Displays the general specifications of the motherboard.

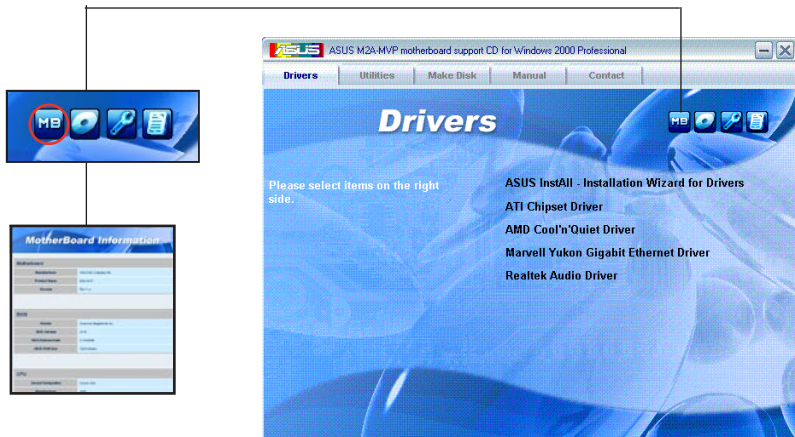

Browse this CD

Displays the support CD contents in graphical format.

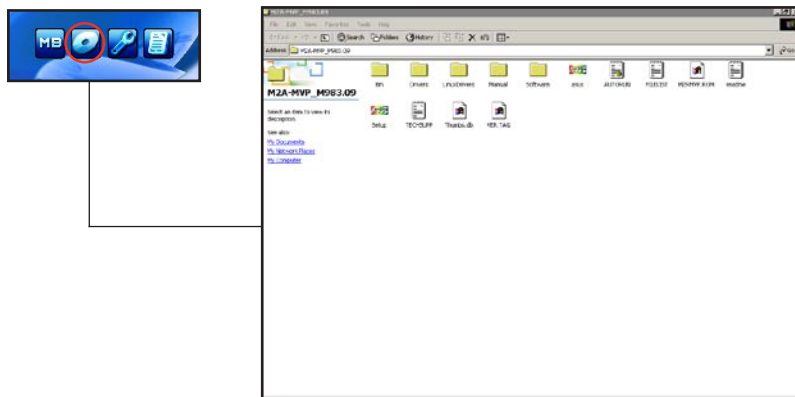

Free Manuals Download Website

<http://myh66.com>

<http://usermanuals.us>

<http://www.somanuals.com>

<http://www.4manuals.cc>

<http://www.manual-lib.com>

<http://www.404manual.com>

<http://www.luxmanual.com>

<http://aubethermostatmanual.com>

Golf course search by state

<http://golfingnear.com>

Email search by domain

<http://emailbydomain.com>

Auto manuals search

<http://auto.somanuals.com>

TV manuals search

<http://tv.somanuals.com>