

ASUS[®]

PG191 LCD Monitor

User Guide

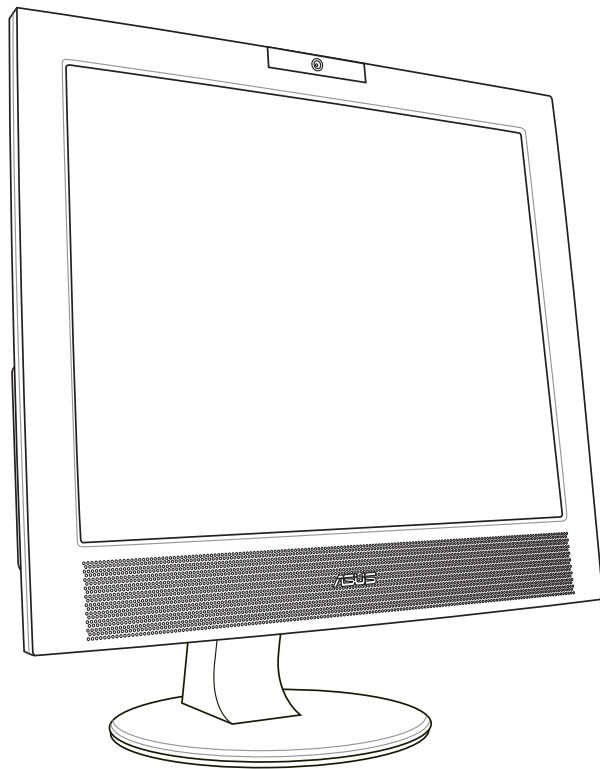

E2480

**First Edition V1
March 2006**

Copyright © 2006 ASUSTeK COMPUTER INC. All Rights Reserved.

No part of this manual, including the products and software described in it, may be reproduced, transmitted, transcribed, stored in a retrieval system, or translated into any language in any form or by any means, except documentation kept by the purchaser for backup purposes, without the express written permission of ASUSTeK COMPUTER INC. ("ASUS").

Product warranty or service will not be extended if: (1) the product is repaired, modified or altered, unless such repair, modification or alteration is authorized in writing by ASUS; or (2) the serial number of the product is defaced or missing.

ASUS PROVIDES THIS MANUAL "AS IS" WITHOUT WARRANTY OF ANY KIND, EITHER EXPRESS OR IMPLIED, INCLUDING BUT NOT LIMITED TO THE IMPLIED WARRANTIES OR CONDITIONS OF MERCHANTABILITY OR FITNESS FOR A PARTICULAR PURPOSE. IN NO EVENT SHALL ASUS, ITS DIRECTORS, OFFICERS, EMPLOYEES OR AGENTS BE LIABLE FOR ANY INDIRECT, SPECIAL, INCIDENTAL, OR CONSEQUENTIAL DAMAGES (INCLUDING DAMAGES FOR LOSS OF PROFITS, LOSS OF BUSINESS, LOSS OF USE OR DATA, INTERRUPTION OF BUSINESS AND THE LIKE), EVEN IF ASUS HAS BEEN ADVISED OF THE POSSIBILITY OF SUCH DAMAGES ARISING FROM ANY DEFECT OR ERROR IN THIS MANUAL OR PRODUCT.

SPECIFICATIONS AND INFORMATION CONTAINED IN THIS MANUAL ARE FURNISHED FOR INFORMATIONAL USE ONLY, AND ARE SUBJECT TO CHANGE AT ANY TIME WITHOUT NOTICE, AND SHOULD NOT BE CONSTRUED AS A COMMITMENT BY ASUS. ASUS ASSUMES NO RESPONSIBILITY OR LIABILITY FOR ANY ERRORS OR INACCURACIES THAT MAY APPEAR IN THIS MANUAL, INCLUDING THE PRODUCTS AND SOFTWARE DESCRIBED IN IT.

Products and corporate names appearing in this manual may or may not be registered trademarks or copyrights of their respective companies, and are used only for identification or explanation and to the owners' benefit, without intent to infringe.

Table of contents

Notices	v
Safety information	vi
Care and cleaning	vii
Package contents	ix

Chapter 1: Product introduction

1.1 Welcome!	1-2
1.2 Features	1-2
1.3 Monitor introduction	1-3

Chapter 2: Setup

2.1 Connecting the cables	2-2
2.2 Turning on the monitor	2-3
2.3 Adjusting the tilt	2-3

Chapter 3: General Instruction

3.1 OSD (On-Screen Display) menu	3-2
3.1.1 How to reconfigure	3-2
3.1.2 OSD function introduction	3-2
3.2 Using the built-in webcam	3-4
3.2.1 Hardware	3-4
3.2.2 Software	3-4
3.3 LifeFrame software	3-5
3.3.1 Introduction and installation instructions	3-5
3.3.2 Main screen	3-6
3.3.3 Preview mode	3-7
3.3.4 Status bar	3-7
3.3.5 Operating area	3-8
3.3.6 Enhance	3-9
3.3.7 Effects	3-10
3.3.8 Setup - basic setup	3-11
3.3.9 Setup - capture format	3-12
3.3.10 Setup - capture mode	3-13

Chapter 4: Appendix

Appendix I	SRS TruSurround XT™	4-2
Appendix II	Troubleshooting (FAQ)	4-3
Appendix III	PG191 specification summary	4-4
Appendix IV	Supported operating modes	4-6

Notices

Federal Communications Commission Statement

This device complies with Part 15 of the FCC Rules. Operation is subject to the following two conditions:

- This device may not cause harmful interference, and
- This device must accept any interference received including interference that may cause undesired operation.

This equipment has been tested and found to comply with the limits for a Class B digital device, pursuant to Part 15 of the FCC Rules. These limits are designed to provide reasonable protection against harmful interference in a residential installation. This equipment generates, uses and can radiate radio frequency energy and, if not installed and used in accordance with manufacturer's instructions, may cause harmful interference to radio communications. However, there is no guarantee that interference will not occur in a particular installation. If this equipment does cause harmful interference to radio or television reception, which can be determined by turning the equipment off and on, the user is encouraged to try to correct the interference by one or more of the following measures:

- Reorient or relocate the receiving antenna.
- Increase the separation between the equipment and receiver.
- Connect the equipment to an outlet on a circuit different from that to which the receiver is connected.
- Consult the dealer or an experienced radio/TV technician for help.

As an Energy Star® Partner, our company has determined that this product meets the Energy Star® guidelines for energy efficiency.

Canadian Department of Communications Statement

This digital apparatus does not exceed the Class B limits for radio noise emissions from digital apparatus set out in the Radio Interference Regulations of the Canadian Department of Communications.

This class B digital apparatus complies with Canadian ICES-003.

Safety information

- Before setting up the monitor, carefully read all the documentation that came with the package.
- To prevent fire or shock hazard, never expose the monitor to rain or moisture.
- Never try to open the monitor cabinet. The dangerous high voltages inside the monitor may result in serious physical injury.
- If the power supply is broken, do not try to fix it by yourself. Contact a qualified service technician or your retailer.
- Before using the product, make sure all cables are correctly connected and the power cables are not damaged. If you detect any damage, contact your dealer immediately.
- Slots and openings on the back or top of the cabinet are provided for ventilation. Do not block these slots. Never place this product near or over a radiator or heat source unless proper ventilation is provided.
- The monitor should be operated only from the type of power source indicated on the label. If you are not sure of the type of power supply to your home, consult your dealer or local power company.
- Use the appropriate power plug which complies with your local power standard.
- Do not overload power strips and extension cords. Overloading can result in fire or electric shock.
- Avoid dust, humidity, and temperature extremes. Do not place the monitor in any area where it may become wet. Place the monitor on a stable surface.
- Unplug the unit during a lightning storm or if it will not be used for a long period of time. This will protect the monitor from damage due to power surges.
- Never push objects or spill liquid of any kind into the slots on the monitor cabinet.
- To ensure satisfactory operation, use the monitor only with UL listed computers which have appropriate configured receptacles marked between 100-240V AC.
- If you encounter technical problems with the monitor, contact a qualified service technician or your retailer.

Care and cleaning

- Before you lift or reposition your monitor, it is better to disconnect the cables and power cord. Follow the correct lifting techniques when positioning the monitor. When lifting or carrying the monitor, grasp the edges of the monitor. Do not lift the display by the stand or the cord.
- Cleaning. Turn your monitor off and unplug the power cord. Clean the monitor surface with a lint-free, non-abrasive cloth. Stubborn stains may be removed with a cloth dampened with mild cleaner.
- Avoid using a cleaner containing alcohol or acetone. Use a cleaner intended for use with the LCD. Never spray cleaner directly on the screen, as it may drip inside the monitor and cause an electric shock.

The following symptoms are normal with the monitor:

- The screen may flicker during the initial use due to the nature of the fluorescent light. Turn off the Power Switch and turn it on again to make sure that the flicker disappears.
- You may find slightly uneven brightness on the screen depending on the desktop pattern you use.
- When the same image is displayed for hours, an afterimage of the previous screen may remain after switching the image. The screen will recover slowly or you can turn off the Power Switch for hours.
- When the screen becomes black or flashes, or cannot work anymore, contact your dealer or service center to fix it. Do not repair the screen by yourself!

Conventions used in this guide



WARNING: Information to prevent injury to yourself when trying to complete a task.



CAUTION: Information to prevent damage to the components when trying to complete a task.



IMPORTANT: Information that you **MUST** follow to complete a task.



NOTE: Tips and additional information to aid in completing a task.

Where to find more information

Refer to the following sources for additional information and for product and software updates.

1. ASUS websites

The ASUS websites worldwide provide updated information on ASUS hardware and software products. Refer to <http://www.asus.com>

2. Optional documentation

Your product package may include optional documentation, such as warranty card, that may have been added by your dealer. These documents are not part of the standard package.

Package contents

Check your PG191 LCD package for the following items:

- ✓ LCD monitor
- ✓ Quick Start Guide
- ✓ Support CD
- ✓ 1 x Power cord
- ✓ 1 x VGA-Audio-Microphone-USB 4-in-1 cable
- ✓ 1 x DVI cable



If any of the above items is damaged or missing, contact your retailer immediately.

Chapter 1

This chapter gives a general description of the ASUS PG191 LCD monitor. The chapter lists the monitor features including introduction on the front/rear panels as well as the side view.

Product introduction

1.1 Welcome!

Thank you for purchasing the ASUS® PG191 LCD monitor!

The LCD monitor features high-quality audio technology, including a detachable 15W ASUS Power Bass System and the most advanced SRS TruSurround XT™ sound effect which help provide vivid melody, enhancing your audio enjoyment while you watch movies, play games, or listen to music! The built-in 1.3 megapixel webcam on top of the LCD panel has both video recording and snapshot functions, allowing you to capture images, create videos, or hold a video conference! Besides, a host of user-friendly functions such as the rotating swivel, adjustable tilt, and smart touch sensor buttons facilitate the usage of the monitor, upgrading your work efficiency.

With these features, you enjoy the convenience and delightful audio-visual experience that the PG191 brings you!

1.2 Features

- 19" TFT LCD Monitor
- True resolution: 1280 X 1024 (SXGA)
- 2ms (gray-to-gray) quick response time
- 5W x2 stereo speakers
- 15W Power Bass System (detachable)
- SRS TruSurround XT™ sound effect (See Appendix I)
- 3 USB 2.0 ports
- Built-in 1.3 megapixel webcam
- SPLENDID™ Video Intelligence Technology
- 5 SPLENDID™ video preset modes switched by hotkey
- 3 skin-tone selections
- 5 sound preset modes switched by hotkey
- Touch sensor controls
- Both VGA and DVI-D Inputs
- Headphone output & microphone input
- Microsoft® Windows® 2000/XP compliance
- VESA Display Data Channel DDC2B compliance
- VESA wall mount compliance (100 x 100 mm)
- EPA ENERGY STAR® and ergonomic design
- RoHS compliance

1.3 Monitor introduction

Front view

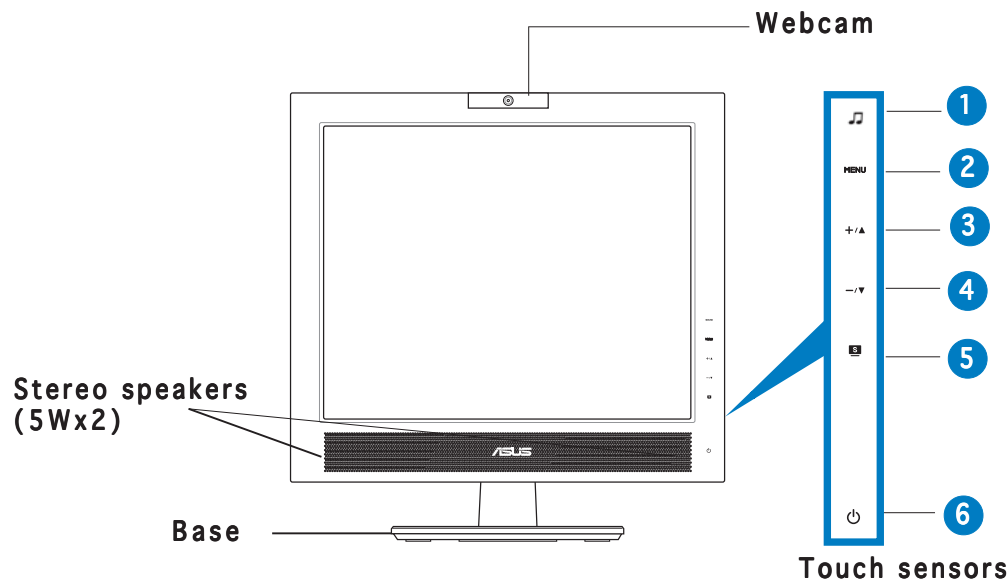

The touch sensors are sensitive. Slightly touch the item you want to enable. Do not press the front panel too hard to prevent damage to the panel and the sensors.

1. **Sensor:**

- Use this hotkey to switch to any of the five sound preset modes (Standard Mode, Fighting Game Mode, Strategic Game Mode, Theater Mode, Music Mode).

2. **Sensor:**

- Touch this sensor to activate the OSD (On-Screen Display) main menu.
- Touch this sensor to enter/select the item (function) highlighted while the OSD menu is activated.

3. **Sensor:**

- Touch this sensor to increase the value of the function selected or move to the next function.
- This is also a hotkey for Brightness adjustment.

4. **Sensor:**

- Touch this sensor to decrease the value of the function selected or move to the previous function.
- This is also a hotkey for Volume adjustment.

5. **Sensor:**

- Use this hotkey to switch to any of the five video preset modes (Standard Mode, Theater Mode, Game Mode, Night View Mode, Scenery Mode) with SILENT™ Video Intelligence Technology.
- Exit the OSD menu or go back to the previous menu as the OSD menu is active.
- Automatically adjust the image to its optimized position, clock, and phase by touching the sensor for 2-3 seconds.

6. **Power sensor/LED indicator**

- Touch this sensor to turn the monitor on/off

LED Status	Description
Blue	Power ON
Amber	Standby mode
OFF	Power OFF

Side view

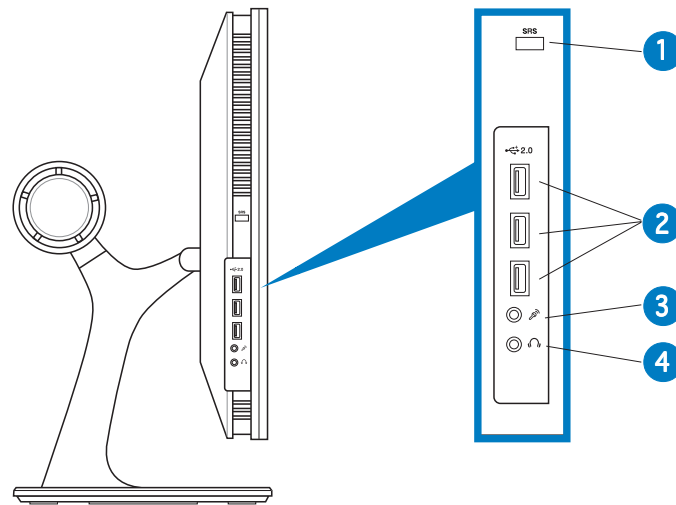

1. **SRS On/Off button.** Press this button to turn on/off the SRS sound effect.
2. **USB 2.0 ports.** These three Universal Serial Bus (USB) ports are available for connecting USB 2.0 devices.
3. **Microphone port.** This port connects a microphone with a mini-plug (3.5mm).
4. **Headphone port.** This port connects a headphone with a stereo mini-plug (3.5 mm).



The headphone and the microphone are purchased separately.

Rear view

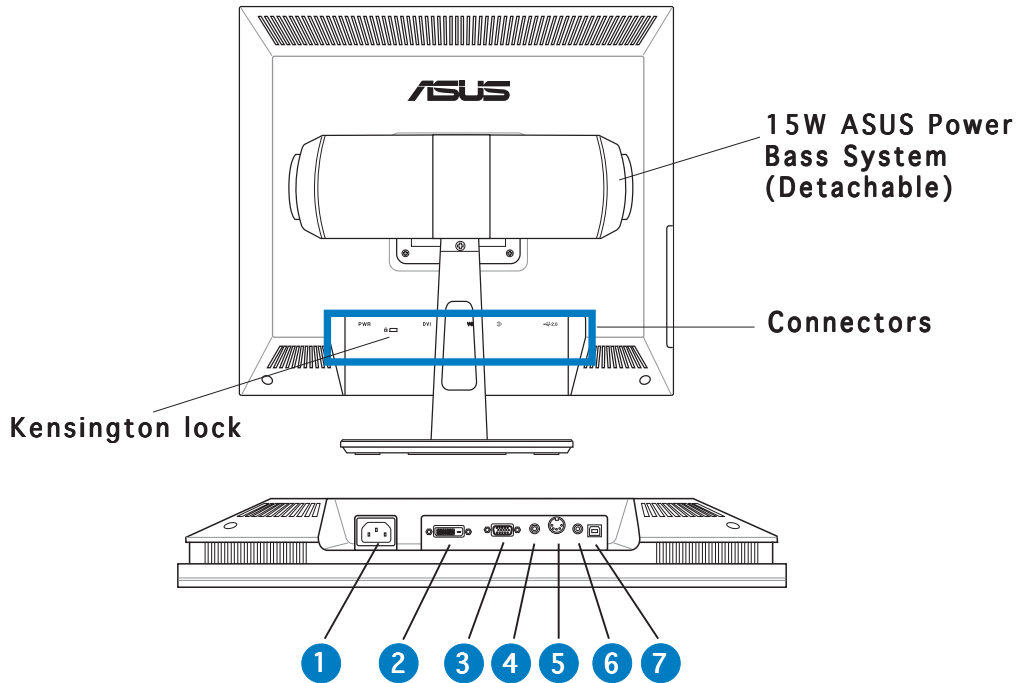

1. AC-in port
2. DVI port
3. VGA port
4. Audio-input port
5. Woofer port
6. Microphone-output port
7. USB port (Upstream)

Chapter 2

This chapter provides setup instruction on how to correctly connect cables and properly adjust the monitor to a comfortable viewing angle via tilt and swivel functions.

Setup instruction

2.1 Connecting the cables

Connect the cables as shown:

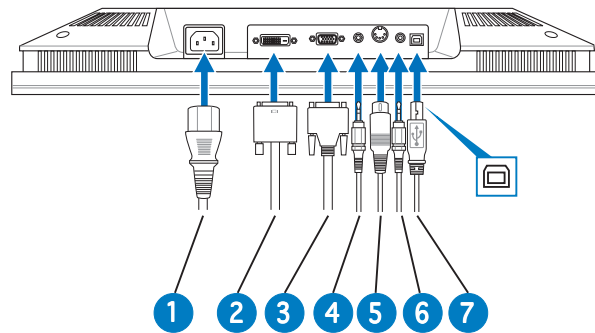



1. Power cord
2. DVI cable
3. VGA cable
4. Audio cable (gray)
5. Woofer cable
6. Microphone cable (red)
7. USB cable

- **To connect the USB cable:** connect one end of the USB cable to the monitor's USB port (as the above drawing shows), the other end to the computer's.
- **To connect the microphone/audio cables:** connect one end (red/gray) of the microphone/audio cables to the monitor's microphone-out/audio-in ports, the other end (red/green) to the computer's microphone-in/audio-out ports.
- **To connect the VGA/DVI cables:**
 - a. Plug the VGA/DVI connectors to the monitor's VGA/DVI ports.
 - b. Connect the other end of the VGA/DVI cables to your computer's VGA/DVI ports.
 - c. Tighten the two screws to secure the VGA/DVI connectors.
- **To connect the power cord:** connect one end of the power cord securely to the monitor's AC input port, the other end to a power outlet.
- **To connect the woofer cable:** connect the woofer cable to the monitor's woofer port.



The supplied VGA-audio-microphone-USB 4-in-1 cable combines the VGA cable, audio cable, microphone cable, and USB cable.

2.2 Turning the monitor on

Gently touch the power sensor . See page 1-3 for the location of the power sensor. The power indicator  lights up in blue to show that the monitor is ON.

2.3 Adjusting the monitor

This monitor can be adjusted within the angles as shown:



We recommend that you adjust the viewing angle of the monitor based on the height of your desk and chair to prevent the light from reflecting to your eyes.

1. Grasp the top of the monitor and adjust the tilt within -5° to 25° .

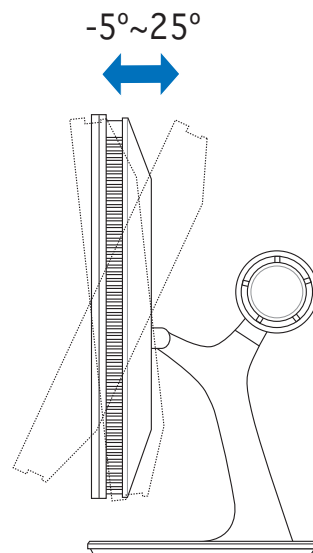

2. The swivel base allows you to turn the monitor left/right up to 120° .

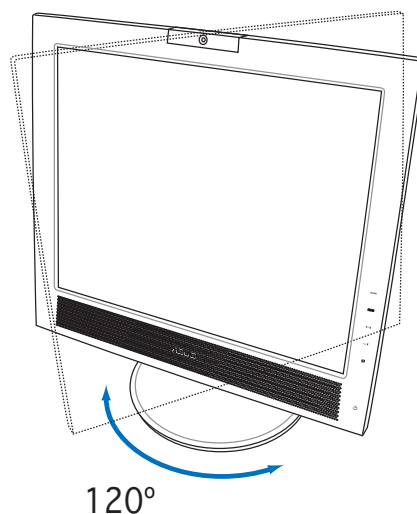

Chapter 3

This chapter introduces the general instruction, including how to use the OSD (On-Screen Display) menu and activate the LifeFrame utility.

General Instruction

3.1 OSD (On-Screen Display) menu

3.1.1 How to reconfigure

1. Touch the **MENU** sensor to activate the OSD menu.
2. Touch **+ / ▲** and **- / ▼** to navigate through the functions. Highlight and activate the desired function by touching the **MENU** sensor. If the function selected has a sub-menu, touch **+ / ▲** and **- / ▼** again to navigate through the sub-menu functions. Highlight and activate the desired sub-menu function by touching the **MENU** sensor.
3. Touch **+ / ▲** and **- / ▼** to change the settings of the selected function.
4. To exit the OSD menu, touch the **S** sensor. Repeat step 2 and step 3 to adjust any other function.

3.1.2 OSD function introduction

See the table on the next page for details.



-
- Phase adjusts the phase of the pixel clock signal. With a wrong phase adjustment, the screen shows horizontal disturbances.
 - Clock (pixel frequency) controls the number of pixels scanned by one horizontal sweep. If the frequency is not correct, the screen shows vertical stripes and the image is not proportional.
-

OSD menu table:

Main	Sub-menu 1	Sub-menu 2	Description	
SPLENDID	Scenery Mode		Video preset mode for viewing scenery	
	Standard Mode		Video preset mode for generic windows use	
	Theater Mode		Video preset mode for watching movies	
	Game Mode		Video preset mode for playing games	
	Night View Mode		Video preset mode for displaying night views	
Image	Brightness		Adjusts brightness of the image	
	Contrast		Adjusts contrast of the image	
	Sharpness		Adjusts sharpness of the image	
	Saturation		Adjusts saturation of the image	
	Position (For VGA only)	H-Position		Adjusts horizontal position of the image
		V-Position		Adjusts vertical position of the image
	Focus (For VGA only)	Phase		Reduces the horizontal-line noise of the image
Clock			Reduces the vertical-line noise of the image	
Color	Color Temp.	Cool	The image appears bluer. (9300°K)	
		Normal	Normal image color. (7500°K)	
		Warm	The image appears redder. (6500°K)	
		sRGB	The image appears sRGB standard color for multimedia designers	
	Skin Tone	User Mode		Adjusts Red/Green/Blue levels of the image
		Reddish		Selects reddish skin stone
		Natural		Selects natural skin stone
		Yellowish		Selects yellowish skin stone
Sound	Preset Mode	Standard Mode	Sound preset mode for generic windows use	
		Fighting Game Mode	Sound preset mode for playing fighting games	
		Strategic Game Mode	Sound preset mode for playing strategic games	
		Theater Mode	Sound preset mode for watching movies	
		Music Mode		Sound preset mode for listen to music
	SRS TSXT	On/Off		Turns on/off the SRS TSXT sound effect
	True Bass			Adjusts the TruBass bass level while SRS TSXT is on
	Balance			Adjusts the balance between right and left channel sounds
	Equalizer			Adjusts 5 bands (100Hz, 300Hz, 1KHz, 3KHz, 10KHz)
		Melody	On/Off	
Power key				Selects a power on/off melody
Function key			Selects a function key melody	
Input Select	VGA/DVI		Selects a preferred input source	
System Setup	OSD Setup	H-Position		Adjusts horizontal position of the OSD
		V-Position		Adjusts vertical position of the OSD
		OSD Timeout		Adjusts OSD timeout
	Language			Selects a preferred language
	Information			Shows the resolution,H/V frequency and input port of current inputting
Reset	No/Yes		Recalls default setting	

3.2 Using the built-in webcam

This built-in webcam allows you to take photos and make videos; while talking to friends via Internet-based communication tools, you can use the webcam to show your vivid image.

3.2.1 Hardware

- The 1.3 megapixel webcam transmits images to your PC through the USB ports. Therefore, make sure that you have connected the USB plugs of the supplied 4-in-1 cable before you use the webcam.
- The webcam is adjustable upward and downward as shown.

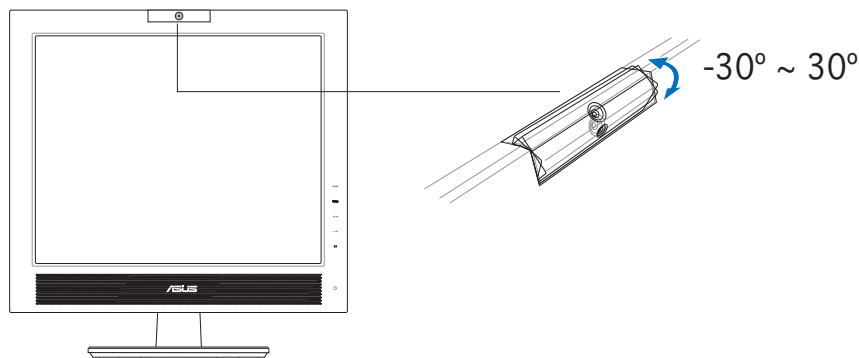

Warning: Do not turn the webcam upward or downward over 30°; doing so might damage the webcam.

3.2.2 Software

To install the webcam driver:

1. Close all other applications first.
2. Insert the support CD into the optical drive and run the **ASUS USB2.0 Webcam** program.

The default webcam resolution is 640 x 480. If you want to change the default resolution to meet different kinds of application programs, go to **C:\WINDOWS\ASUS USB2.0 Webcam** and activate the program named LifeCam to modify the settings based on your needs.



-
- The default webcam captured video format is VGA (640 x 480) mode in order to increase the transmission efficiency via all kinds of Internet communication tools.
 - Before using the webcam, you need to install the webcam driver into your PC.
 - The webcam driver only supports Microsoft® Windows 2000/XP operating system with Microsoft® Direct X.
-

3.3 LifeFrame software

3.3.1 Introduction and installation instructions

To capture snapshots or video clips, ASUS PG191 provides an easy-to-use LifeFrame that can work with the built-in webcam, allowing users to create their own photos or video clips.



-
- LifeFrame only supports Microsoft® Windows® 2000/XP operating systems.
 - Before starting to use this software, install LifeFrame into your PC.
 - The LifeFrame software is bundled in the PG191 support CD.
-

System requirements are as follows:

1. A personal computer with Pentium® III 800 MHz or higher processor
2. Microsoft® Windows® 2000/XP operating systems
3. Minimum 200 MB free hard disk space to run the program
4. 128 MB of RAM or above
5. A display card supporting 16-bit high color mode

Installation instructions:

1. Close all other applications.
2. Insert the support CD into the optical drive and run the LifeFrame program.
3. Follow the on-screen instructions to complete the installation



Make sure that you connect the USB plug of the supplied 4-in-1 cable to the USB port at the back of the LCD monitor; otherwise, the built-in webcam and LifeFrame will not be activated.

3.3.2 Main screen

The main screen shows the following function areas:



Click the top minimize/maximize button to switch modes between 320x240 and 480x360.

1. **Preview window.** Previews a snapshot or video clips. See section 3.4.3 for details.
2. **Status bar.** Shows the status and information of capture/preview mode. See section 3.4.4 for details.
3. **Operation area.** Provides the operation functions:
 - **Side section:** enhance, effects, setup
 - **Bottom section:** voice switch, video mode, record/stop, snapshot mode, continue capture, interval capture, auto motion detective capture
4. **Image display area.** Displays a snapshot and video clips, saved as thumbnails listed in descending order according to image creation time.
5. **Application area.** Allows you to perform the following functions on your saved images: mode switch, email, save, and delete. Refer to the next page for details.



Switch mode- click to switch between playback/capture modes.



Email- open a new mail, add the image or video file you would like to send as an attachment.



Save as- save thumbnails to a folder.



Trash- click the thumbnail you wish to delete, then click “Trash”
You can select multiple files to delete.

3.3.3 Preview mode

For snapshot

Click the thumbnail you wish to preview.

Viewing video clips

1. Click the movie recorder icon on the lower right corner.
2. Click the thumbnail to preview.
3. Buttons will appear. Use these buttons to play the video.

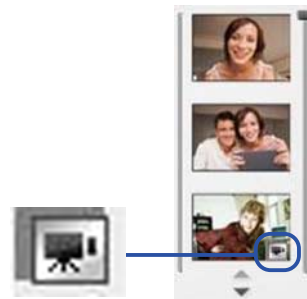

3.3.4 Status bar

The status shows the following information.

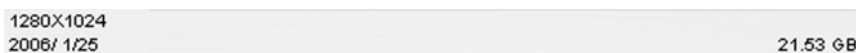

Capture mode/preview mode

Video: resolution, date, capture (playing) time/size,
HD space/file size

Snapshot: resolution, date, HD space/file size

3.3.5 Operating area

Side section

Enhance	- Enhance
Effects	- Effects
Setup	- Setup

Bottom section

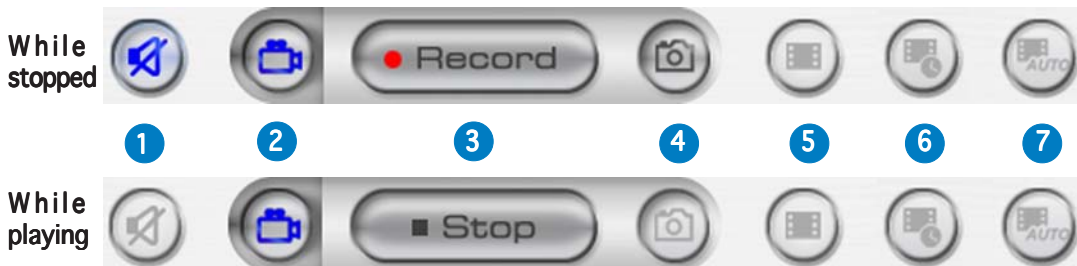

1. **Mute.** Disables voice recording
2. **Video mode.** Switches the mode to recording
3. **Record.** Starts recording/capturing
- Stop.** Stops recording/capturing
4. **Snapshot mode.** Switches from Video Mode to Snapshot Mode
5. **Continue capture.** Click “Record” when ready
6. **Interval capture:** Click “Record” to start, “Stop” to end
7. **Auto motion detection capture.** Click “Record” to start, “Stop” to end



- To add sound to your video clips, ensure that you connect a microphone to the monitor.
- The microphone is purchased separately.

3.3.6 Enhance

There are several options to enhance the quality of your captures.

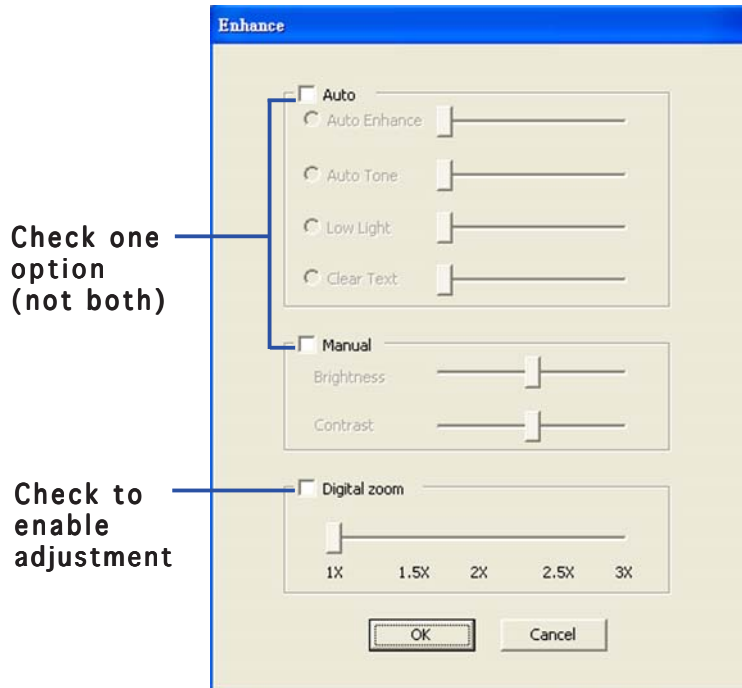
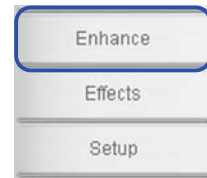

Auto. Auto Enhance, Low Light, Auto Tone, Clear text (white board)

Manual. Allows you to adjust the Brightness and Contrast manually.

Digital Zoom. 1x to 3x, in 0.5 increments

Click OK to save settings.

3.3.7 Effects

Enrich your images with special effects.



No Effect. Click “No Effect” to cancel the chosen effects.
Click OK to save settings.

3.3.8 Setup - basic setup

There are three pages: Basic Setup, Capture Format, and Capture Mode.

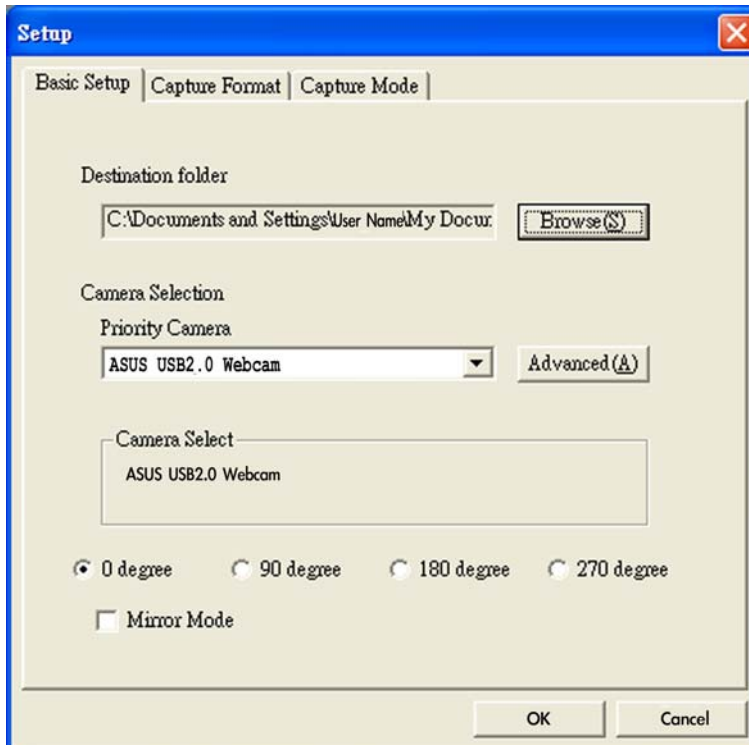
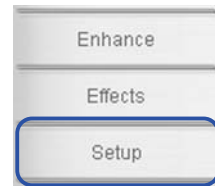

Destination Folder. Click “Browse” to choose the folder for saving files.

Camera Selection. The priority camera is set as ASUS USB2.0 webcam.

Advanced. Click “Advanced” for further information of webcam setting.

Picture change mode. This function provides mirror mode and four kinds of picture rotating angles.

Click OK to save settings.

3.3.9 Setup - capture format

Many options for output size, image format/quality, and video format/quality.

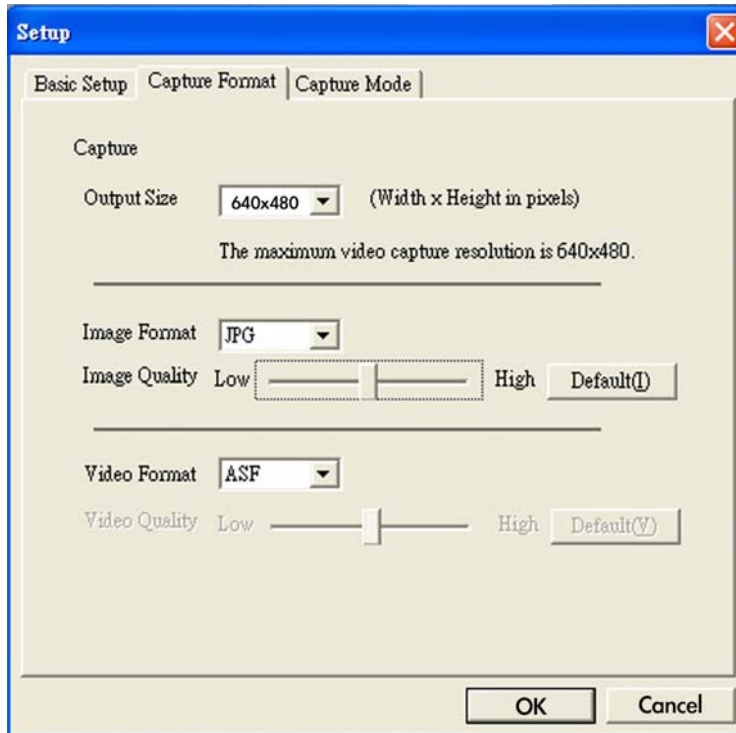

Output Size. Allows you to choose the resolution you need: 160x120, 176x144, 320x240, 352x288, 640x480, 1280x1024

Image Format. Allows you to choose the image format: BMP, JPG

Image Quality. Use the scroll bar to adjust the image quality.

Video Format. Allows you to choose the video format: AVI, ASF, WMV

Video Quality. Use the scroll bar to adjust the video quality.

Click OK to save settings.

3.3.10 Setup - capture mode

You can adjust the capture mode with the following three items: recording time limited, auto capture sensitivity, and capture interval setting.

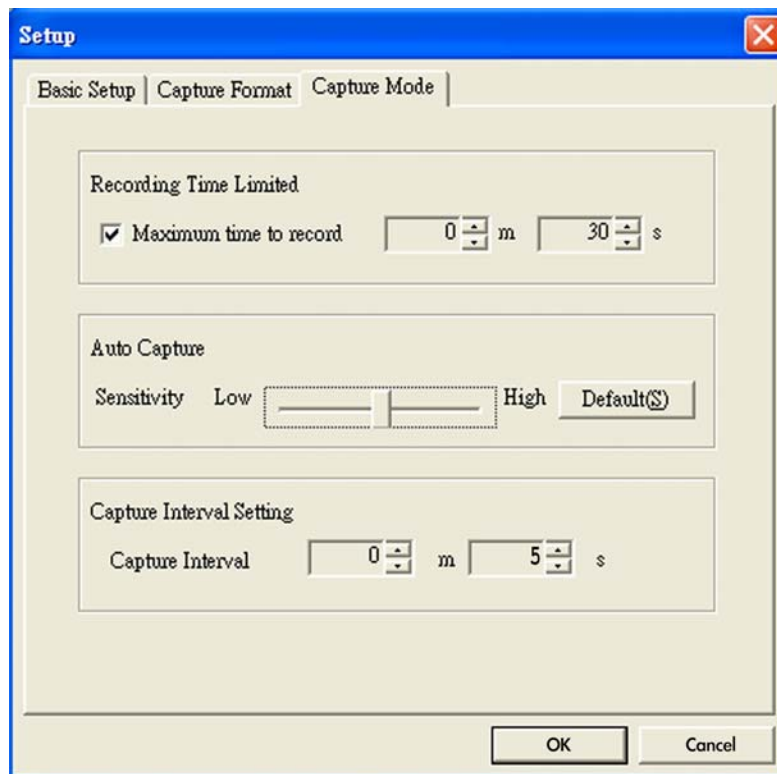
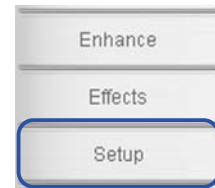

Recording Time Limited. Check the box for setting the recording time, the maximum will be 120 minutes; default maximum time limit is 30 seconds. One single file size should not be bigger than 2 GB.

Auto Capture. Use the scroll bar to adjust the sensitivity of motion detect.

Capture Interval Setting. Allows you to adjust the capture interval; the default value is 5 seconds.

Click OK to save settings.

Chapter 4

This appendix provides the introduction of SRS TruSurround XT™, troubleshooting (FAQ), specification summary, and supported operating modes.

Appendix

Appendix I. SRS TruSurround XT™

SRS TruSurround XT is a novel audio technology which provides an enhanced listening experience. Utilizing proprietary algorithms from SRS Labs, TruSurround is intended to regenerate a realistic audio environment, where users feel like being surrounded by sound.



TruSurround XT is a combination of four distinct and patented processing techniques from SRS Labs:

- **Dialog Clarity™:** the special SRS algorithms solves the signal disturbance derived from multichannel and improves the dialog clarity of movies, PC games, on-line chats, etc.
- **TruSurround™:** this core technology is compatible with all multichannel formats, allowing you to enjoy virtual surrounding sound experience.
- **TruBass™:** Developed with the proprietary psychoacoustic techniques, the TruBass technology restores low-frequency tones by augmenting harmonics.
- **WOW™:** WOW is a stereo enhancement technology that extends the sound space in both the horizontal and vertical planes, trully providing a 3D stereo experience.

TruSurround XT™ sound effect



Appendix II. Troubleshooting (FAQ)

Problem	Possible Solution
Power LED is not ON	<ul style="list-style-type: none"> • Touch the  sensor to check if the monitor is in the ON mode. • Check if the power cord is properly connected to the monitor and the power outlet.
The Power LED lights amber and there is no screen image	<ul style="list-style-type: none"> • Check if the monitor and the computer are in the ON mode. • Make sure the signal cable is properly connected the monitor and the computer. • Inspect the signal cable and make sure none of the pins are bent. • Connect the computer with another available monitor to check if the computer is properly working.
Screen image is too light or dark	<ul style="list-style-type: none"> • Adjust the Contrast and Brightness settings via OSD.
Screen image is not centered or sized properly	<ul style="list-style-type: none"> • Touch the  sensor for two seconds to automatically adjust the image. • Adjust the H-Position or V-Position settings via OSD.
Screen image bounces or a wave pattern is present in the image	<ul style="list-style-type: none"> • Make sure the signal cable is properly connected to the monitor and the computer. • Move electrical devices that may cause electrical interference.
Screen image has color defects (white does not look white)	<ul style="list-style-type: none"> • Inspect the signal cable and make sure that none of the pins are bent. • Perform Reset via OSD. • Adjust the R/G/B color settings or select the Color Temperature via OSD.
Screen image is blurry or fuzzy	<ul style="list-style-type: none"> • Touch the  sensor for two to three seconds to automatically adjust the image. • Adjust the Phase and Clock settings via OSD.
No sound or sound is low	<ul style="list-style-type: none"> • Ensure that the audio cable is properly connected to the monitor and the computer • Adjust the volume settings of both your monitor and computer. • Ensure that the computer sound card driver is properly installed and activated.
Webcam is not working	<ul style="list-style-type: none"> • Ensure that you install the webcam driver which is in the support CD. • Make sure that you connect the USB plugs of the supplied 4-in-1 cable to both the LCD monitor and your computer.
USB devices work abnormally	<ul style="list-style-type: none"> • Make sure that you connect the USB plugs of the supplied 4-in-1 cable to both the LCD monitor and your computer. • Check with your PC manufacturer whether your PC supports USB2.0 or USB1.1. • If your PC only supports USB1.1, the image transmission is much slower.
ASUS Power Bass System is not working	<ul style="list-style-type: none"> • Make sure that the woofer cable is securely connected to the monitor.

Appendix III. PG191 specification summary

Panel type	TFT LCD
Panel size	19.0"
True resolution	SXGA + 1280 x 1024
Pixel pitch	0.294 mm
Brightness (typ.)	300cd/m ²
Contrast ratio (typ.)	800:1
Viewing angle(H/V)	160°/160°
Display colors	16.2M
Response time	2ms (GTG)
SPLENDID™ Video Intelligence Technology	Yes
SPLENDID™ Video preset mode	5 Modes (by hotkey)
Skin-tone selection	3 Skin-tones
Sound preset mode	5 Modes (by hotkey)
Auto adjustment	Yes (by hotkey)
Color temperature selection	Cool/Normal/Warm/sRGB/User Mode
Video signal inputs	24-Pin DVI-D & 15-Pin D-Sub
Audio-in port	3.5mm Mini-jack
Headphone port	3.5mm Mini-jack
Microphone port	3.5mm Mini-jack
Chassis colors	Black + Silver
Speaker (built-in)	5W x 2 (Stereo) + 15W Power Bass System
Power LED	Blue (ON)/ Amber (Standby)
Tilt	+25° ~ -5°
Swivel	+60° ~ -60°

(continued on the next page)

VESA wall mount	100 x 100 mm
Kensington lock	Yes
Power source	AC: 100-240V~, 50Hz-60Hz
Power consumption	Power On: < 90W, Standby: < 2W,
Net weight	10.5 Kg (approx.)
Dimension	444.9 mm (W) x 463.4 mm (H) x 240.0 mm (D)
Accessories	VGA-Audio-Microphone-USB 4-in-1 cable, DVI cable, Power cord, Support CD (LifeFrame bundled), Quick Start Guide
Regulation approvals	Energy Star®, UL/cUL, CB, CE, FCC, CCC, BSMI, Gost-R, C-Tick, VCCI, RoHS, MIC

* Specifications are subject to change without notice.

Appendix IV. Supported operating modes

Standard	Resolution	Horizontal Frequency	Vertical Frequency	Pixel Frequency
DOS	720 x 400	31.47KHz	70Hz	28.32MHz
VGA	640 x 480	31.47KHz	60Hz	25.18MHz
	640 x 480	37.90KHz	72Hz	31.50MHz
	640 x 480	37.50KHz	75Hz	31.50MHz
SVGA	800 x 600	35.16KHz	56Hz	36.00MHz
	800 x 600	37.90KHz	60Hz	40.00MHz
	800 x 600	48.10KHz	72Hz	50.00MHz
	800 x 600	46.90KHz	75Hz	49.50MHz
XGA	1024 x 768	48.40KHz	60Hz	65.00MHz
	1024 x 768	56.50KHz	70Hz	75.00MHz
	1024 x 768	60.02KHz	75Hz	78.75MHz
SXGA	1280 x 1024	64.00KHz	60Hz	108.00MHz
	1280 x 1024	78.00KHz	75Hz	135.00MHz
VESA	1152 x 864	67.50KHz	75Hz	108.00MHz

* Modes not listed in the table may not be supported. For optimal resolution, we recommend that you choose a mode listed in the table above.

Free Manuals Download Website

<http://myh66.com>

<http://usermanuals.us>

<http://www.somanuals.com>

<http://www.4manuals.cc>

<http://www.manual-lib.com>

<http://www.404manual.com>

<http://www.luxmanual.com>

<http://aubethermostatmanual.com>

Golf course search by state

<http://golfingnear.com>

Email search by domain

<http://emailbydomain.com>

Auto manuals search

<http://auto.somanuals.com>

TV manuals search

<http://tv.somanuals.com>