

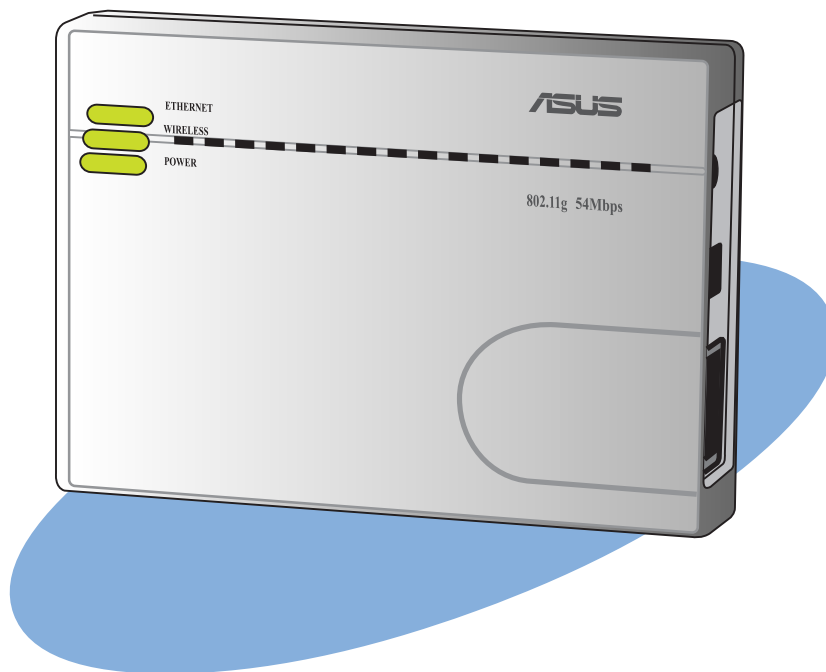

54Mbps Pocket Wireless Access Point (WL-330g)



User Guide

E1539

First Edition V1

May 2004

Copyright © 2004 ASUSTeK COMPUTER INC. All Rights Reserved.

No part of this manual, including the products and software described in it, may be reproduced, transmitted, transcribed, stored in a retrieval system, or translated into any language in any form or by any means, except documentation kept by the purchaser for backup purposes, without the express written permission of ASUSTeK COMPUTER INC. ("ASUS").

Product warranty or service will not be extended if: (1) the product is repaired, modified or altered, unless such repair, modification or alteration is authorized in writing by ASUS; or (2) the serial number of the product is defaced or missing.

ASUS PROVIDES THIS MANUAL "AS IS" WITHOUT WARRANTY OF ANY KIND, EITHER EXPRESS OR IMPLIED, INCLUDING BUT NOT LIMITED TO THE IMPLIED WARRANTIES OR CONDITIONS OF MERCHANTABILITY OR FITNESS FOR A PARTICULAR PURPOSE. IN NO EVENT SHALL ASUS, ITS DIRECTORS, OFFICERS, EMPLOYEES OR AGENTS BE LIABLE FOR ANY INDIRECT, SPECIAL, INCIDENTAL, OR CONSEQUENTIAL DAMAGES (INCLUDING DAMAGES FOR LOSS OF PROFITS, LOSS OF BUSINESS, LOSS OF USE OR DATA, INTERRUPTION OF BUSINESS AND THE LIKE), EVEN IF ASUS HAS BEEN ADVISED OF THE POSSIBILITY OF SUCH DAMAGES ARISING FROM ANY DEFECT OR ERROR IN THIS MANUAL OR PRODUCT.

SPECIFICATIONS AND INFORMATION CONTAINED IN THIS MANUAL ARE FURNISHED FOR INFORMATIONAL USE ONLY, AND ARE SUBJECT TO CHANGE AT ANY TIME WITHOUT NOTICE, AND SHOULD NOT BE CONSTRUED AS A COMMITMENT BY ASUS. ASUS ASSUMES NO RESPONSIBILITY OR LIABILITY FOR ANY ERRORS OR INACCURACIES THAT MAY APPEAR IN THIS MANUAL, INCLUDING THE PRODUCTS AND SOFTWARE DESCRIBED IN IT.

Products and corporate names appearing in this manual may or may not be registered trademarks or copyrights of their respective companies, and are used only for identification or explanation and to the owners' benefit, without intent to infringe.

Contents

Notices	v
Safety statements	vi
About this guide	viii
ASUS contact information	ix
WL-330g specification summary	x

Chapter 1: Product introduction

1.1 Welcome!	1-2
1.2 Package contents	1-2
1.3 Features	1-3
1.3.1 Top view	1-3
1.3.2 Bottom view	1-4
1.3.3 Rear view	1-4
1.4 LED indicators	1-5
1.5 Recommended network settings	1-6
1.5.1 Access Point mode	1-6
1.5.2 Ethernet adapter mode	1-7

Chapter 2: Hardware installation

2.1 System requirements	2-2
2.2 Device installation	2-2
2.2.1 Before you proceed	2-2
2.2.2 Using DC power	2-3
2.2.3 Using USB bus power	2-4
2.3 Placement	2-5
Wall mounting	2-5
2.4 Operating range	2-5
2.4.1 Range	2-5
2.4.2 Site survey	2-6
2.5 Roaming information	2-6

Contents

Chapter 3: Configuration

3.1	Installing the utilities	3-2
3.2	Wireless Setting Utility	3-3
3.2.1	Launching the Wireless Setting Utility	3-3
3.2.2	Using the Wireless Setting Utility	3-4
3.3	Web Configuration utility	3-10
3.3.1	Adjusting the TCP/IP settings	3-10
3.3.2	Launching the Web Configuration utility	3-12
3.3.3	Changing the access point (AP) configuration	3-13
3.3.4	Changing the Ethernet adapter configuration	3-23
3.4	Firmware Restoration	3-36

Chapter 4: Using the device

4.1	Using the device in a local network	4-2
4.2	Replacing the computer Ethernet cables	4-2
4.3	Replacing the cable connections of other devices	4-3
4.4	Sharing Internet connection with other computers	4-3

Appendix: Troubleshooting

Notices

Federal Communications Commission Statement

This device complies with FCC Rules Part 15. Operation is subject to the following two conditions:

- This device may not cause harmful interference, and
- This device must accept any interference received, including interference that may cause undesired operation.

This equipment has been tested and found to comply with the limits for a class B digital device, pursuant to Part 15 of the Federal Communications Commission (FCC) rules. These limits are designed to provide reasonable protection against harmful interference in a residential installation. This equipment generates, uses, and can radiate radio frequency energy and, if not installed and used in accordance with the instructions, may cause harmful interference to radio communications. However, there is no guarantee that interference will not occur in a particular installation. If this equipment does cause harmful interference to radio or television reception, which can be determined by turning the equipment off and on, the user is encouraged to try to correct the interference by one or more of the following measures:

- Reorient or relocate the receiving antenna.
- Increase the separation between the equipment and receiver.
- Connect the equipment into an outlet on a circuit different from that to which the receiver is connected.
- Consult the dealer or an experienced radio/TV technician for help.



CAUTION! You are cautioned that changes or modifications not expressly approved by the party responsible for compliance could void your authority to operate the equipment.

Reprinted from the Code of Federal Regulations #47, part 15.193, 1993.
Washington DC: Office of the Federal Register, National Archives and
Records Administration, U.S. Government Printing Office.

Safety statements

Regulatory Information/Disclaimers

Installation and use of this Wireless LAN device must be in strict accordance with the instructions included in the user documentation provided with the product. Any changes or modifications (including the antennas) made to this device that are not expressly approved by the manufacturer may void the user's authority to operate the equipment. The manufacturer is not responsible for any radio or television interference caused by unauthorized modification of this device, or the substitution of the connecting cables and equipment other than manufacturer specified. It is the responsibility of the user to correct any interference caused by such unauthorized modification, substitution or attachment. Manufacturer and its authorized resellers or distributors will assume no liability for any damage or violation of government regulations arising from failing to comply with these guidelines.



CAUTION! To maintain compliance with FCC's RF exposure guidelines, this equipment should be installed and operated with minimum distance [20cm] between the radiator and your body. Use on the supplied antenna. Unauthorized antenna, modification, or attachments could damage the transmitter and may violate FCC regulations.

Safety Information

In order to maintain compliance with the FCC RF exposure guidelines, this equipment should be installed and operated with minimum distance **[20cm]** between the radiator and your body. Use only with supplied antenna.

Unauthorized antenna, modification, or attachments could damage the transmitter and may violate FCC regulations.



CAUTION! Any changes or modifications not expressly approved in this manual could void your authorization to use this device.

MPE Statement

Your device contains a low power transmitter. When device is transmitted it sends out Radio Frequency (RF) signal.

Safety statements

Caution Statement of the FCC Radio Frequency Exposure

This Wireless LAN radio device has been evaluated under FCC Bulletin OET 65C and found compliant to the requirements as set forth in CFR 47 Sections 2.1091, 2.1093, and 15.247(b)(4) addressing RF Exposure from radio frequency devices. The radiation output power of this Wireless LAN device is far below the FCC radio frequency exposure limits. Nevertheless, this device shall be used in such a manner that the potential for human contact during normal operation – as a mobile or portable device but use in a body-worn way is strictly prohibit. When using this device, a certain separation distance between antenna and nearby persons has to be kept to ensure RF exposure compliance. In order to comply with the RF exposure limits established in the ANSI C95.1 standards, the distance between the antennas and the user should not be less than [20cm].

RF Exposure

The antenna(s) used for this transmitter must not be co-located or operating in conjunction with any other antenna or transmitter.

About this guide

This user guide contains the information you need to install and configure your ASUS Pocket Wireless AP.

How this guide is organized

This guide contains the following parts:

- **Chapter 1: Product introduction**

This chapter describes the physical features of the ASUS Pocket Wireless AP. This part also presents the package contents, LED indicators, and recommended network settings.

- **Chapter 2: Hardware installation**

This chapter provides information on how to install the ASUS Pocket Wireless AP.

- **Chapter 3: Configuration**

This chapter provides information on how to configure the ASUS Pocket Wireless AP using the utilities available from the support CD.

- **Chapter 4: Using the device**

This chapter provides instructions on how to use the ASUS Pocket Wireless AP on various network setups.

- **Appendix: Troubleshooting**

The Appendix features a troubleshooting guide for solving common problems you may encounter when using the ASUS Pocket Wireless AP.

Conventions used in this guide

To make sure that you perform certain tasks properly, take note of the following symbols used throughout this guide.



WARNING: Information to prevent injury to yourself when trying to complete a task.



CAUTION: Information to prevent damage to the components when trying to complete a task.



IMPORTANT: Information that you **MUST** follow to complete a task.



NOTE: Tips and additional information to aid in completing a task.

ASUS contact information

ASUSTeK COMPUTER INC. (Asia-Pacific)

Address 150 Li-Te Road, Peitou, Taipei, Taiwan 112
Telephone +886-2-2894-3447
Web site www.asus.com.tw

Technical Support

Telephone
MB/Component +886-2-2890-7121 (English)
Notebook +886-2-2890-7122 (English)
Server/PC +886-2-2890-7123 (English)
Networking +886-2-2890-7902 (English)
Support fax +886-2-2890-7698

ASUS COMPUTER INTERNATIONAL (America)

Address 44370 Nobel Drive, Fremont, CA 94538, USA
Fax +1-510-608-4555
E-mail tmd1@asus.com
Web site usa.asus.com

Technical Support

Telephone
General +1-502-995-0883
Notebook +1-510-739-3777
Support fax +1-502-933-8713
Support e-mail tsd@asus.com

ASUS COMPUTER GmbH (Germany and Austria)

Address Harkort Str. 25, D-40880 Ratingen, Germany
Telephone +49-2102-95990
Fax +49-2102-959911
Online contact www.asuscom.de/sales

Technical Support

Telephone +49-2102-95990
Fax +49-2102-959911
Online support www.asuscom.de/support
Web site www.asuscom.de/news

ASUS COMPUTER (Middle East and North Africa)

Address P.O. Box 64133, Dubai, U.A.E.
Telephone +9714-283-1774
Fax +9714-283-1775
Web site www.ASUSarabia.com

WL-330g specifications summary

Standard	IEEE 802.11g
Technology	Octogonal Frequency Division Multiplexing (OFDM) Direct Sequence Spread Spectrum (DSSS)
Data transfer rate	802.11g: 54Mbps with auto-fallback to 48, 36, 24, 18, 12, 9, and 6Mbps 802.11b: 11Mbps with auto-fallback to 5.5, 2, and 1Mbps
Operation modes	Access Point (AP) Ethernet adapter
Frequency band	2.4 GHz ~ 2.5 GHz
Security	64-bit/128-bit configurable WEP encryption Wi-Fi Protected Access (WPA)
Operating distance	Indoors @ 11Mbps : 130 ft (40 m) Indoors @ 54Mbps : 80 ft (25 m) Outdoors @ 11Mbps LOS** : 1000 ft (310 m) Outdoors @ 54Mbps LOS** : 200 ft (60 m)
Compatibility	Compatible with IEEE 802.11b and 802.11g devices
Power requirement	DC power using the supplied power cable and plug or USB bus-powered
Dimensions	86mm x 62mm x 17mm
Supported OS	Windows® 98SE/Me/2000 (SP4)/XP (SP1)
Antenna	Two internal 3D Inverted-F antennas
Mounting options	Desktop or wall-mount installation
Software support	Wireless Setting Utility Firmware Restoration

* *Specifications are subject to change without notice.*

** *Line-of-Sight*



- The ASUS Pocket Wireless AP operating distance may be shorter if there are walls, barriers, or interferences in the home layout or operating environment.
- Specifications are subject to change without notice.

Chapter 1

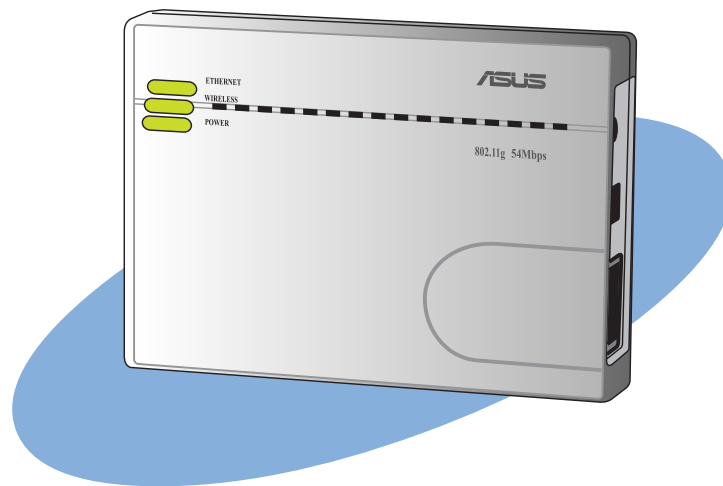

This chapter describes the physical features of the ASUS Pocket Wireless AP. This part presents the package contents, LED indicators, and recommended network settings.

Product introduction

1.1 Welcome!

Thank you for choosing the ASUS ASUS Pocket Wireless AP!

The ASUS Pocket Wireless AP is a compact easy-to-install and use access point (AP) and Ethernet adapter in one. Implementing the IEEE 802.11g standard for wireless LAN (WLAN), the ASUS ASUS Pocket Wireless AP is capable of up to 54Mbps data transmission rate using the Direct Sequence Spread Spectrum (DSSS) and the Octogonal Frequency Division Multiplexing (OFDM) technologies. This AP is backward compatible with the earlier IEEE 802.11b standard allowing seamless interfacing of both wireless LAN standards.

The ASUS Pocket Wireless AP also supports several wireless network configuration including AP, Infrastructure, and Ad-hoc modes giving you flexibility on your existing or future wireless network configurations.

To provide efficient security to your wireless communication, ASUS Pocket Wireless AP comes with a 64-bit/128-bit Wired Equivalent Privacy (WEP) encryption and Wi-Fi Protected Access (WPA) features.

With these and many more, ASUS ASUS Pocket Wireless AP is sure to keep you ahead in the world of wireless computing.

1.2 Package contents

Check the following items in your ASUS Pocket Wireless AP package. Contact your retailer if any item is damaged or missing.

- ASUS Pocket Wireless AP (WL-330g)
- Universal power adapter and plug (100V ~ 240V)
- USB adapter and plug
- RJ-45 connector and cable
- Support CD
- Quick Start Guide
- Soft case



Unless otherwise specified, the term “device” in this User Guide refers to the ASUS Pocket Wireless AP.

1.3 Features

The ASUS Pocket Wireless AP employs the DSSS and OFDM technologies to transmit and receive signals through radio waves on the 2.4 GHz band.

Here are other ASUS Pocket Wireless AP features:

- Reliable data transfer rates of up to 54Mbps
- Secure data transmission via Wired Equivalent Privacy (WEP) and WiFi Protected Access (WPA) encryptions
- Operating distance of up to 130ft (40m) indoors and 1000 ft (310m) outdoors
- Dual power mode (DC or USB bus-powered)
- Equipped with a mounting hook for wall installation
- Supports Infrastructure and Ad-hoc network types in Ethernet adapter mode
- Windows® 98SE/Me/2000/XP compatible

1.3.1 Top view

LEDs. The ASUS Pocket Wireless AP comes with three LED indicators (Ethernet, Wireless, and Power). Refer to section 1.4 “LED indicators” for details.

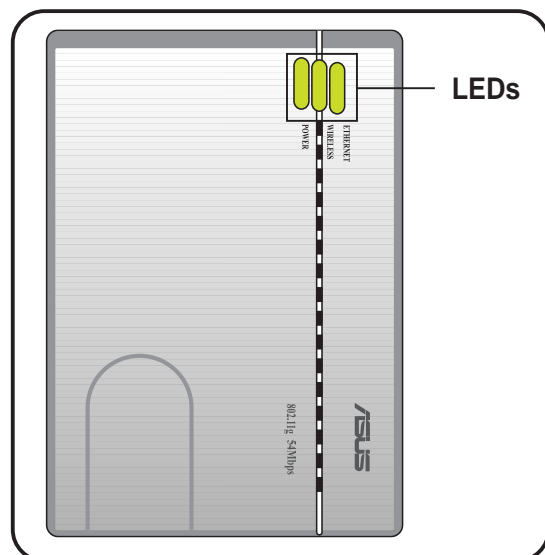

1.3.2 Bottom view

Mounting hook. Use the mounting hook to install the device on concrete or wooden surfaces using a roundhead screw.

Air vents. These vents provide ventilation to the device.

Mode switch. Allows you to switch the device from AP mode to Ethernet adapter mode, or vice versa.

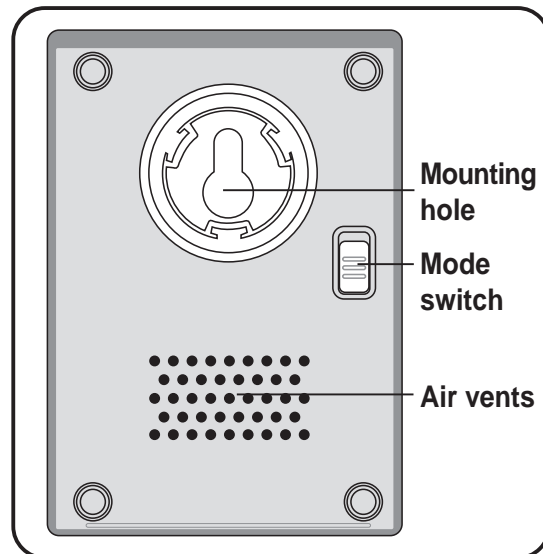
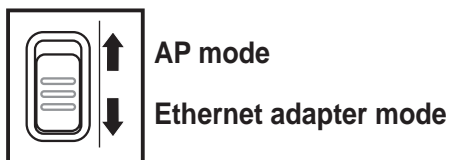

1.3.3 Rear view

Ethernet port. This port connects the supplied RJ-45 plug and cable.

DC IN socket. This socket connects the power adapter plug.

Reset button. Press this button for more than five seconds (in AP or Ethernet mode) to load the default values. In Ethernet adapter mode, press this button for less than five seconds to connect to the first saved wireless connection in the profile table. See page 3-15 for the reset button function in Ethernet mode.

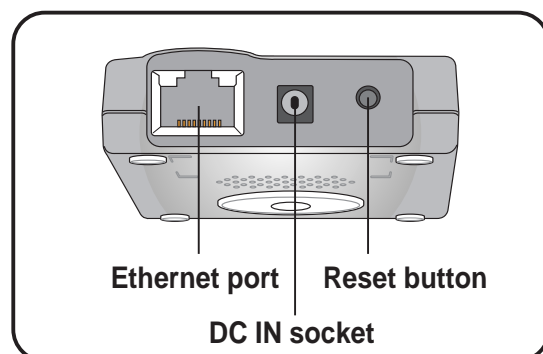

1.4 LED indicators

The ASUS Pocket Wireless AP comes with a Ethernet, Wireless, and Power LED indicators. Refer to the table below for LED indications.

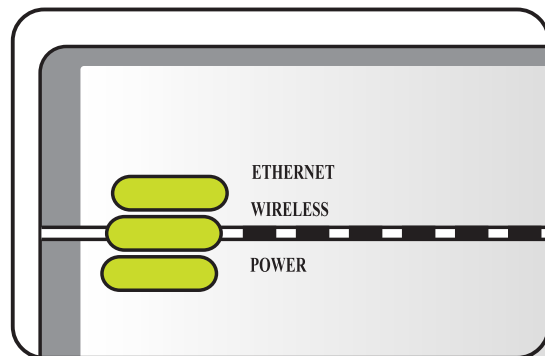

LED	Status	Mode*	Indication
Ethernet	On	AP/EA	The device is connected to an Ethernet network.
	Off	AP/EA	The device is off or not connected to an Ethernet network.
Wireless	On	AP	The device is on and ready.
	On	EA	The device is associated with an AP or other wireless device.
	Off	AP	The device is off.
	Off	EA	The device is not associated with an AP or other wireless device.
	Blinking	AP/EA	The device is transmitting or receiving data.
Power	On	AP/EA	The device in on and ready.
	Off	AP/EA	The device is off or performing boot sequence.
	Blinking	AP/EA	Firmware upgrade failed.

*Modes: **AP** – Access Point mode **EA** – Ethernet adapter mode

1.5 Recommended network settings

The ASUS Pocket Wireless AP can be configured as an Access Point (AP) or wireless Ethernet adapter. In AP mode, the device acts as the central link between computers in a wireless network. In Ethernet adapter mode, the device connects to:

1. A wireless device(s) (Ad-hoc mode), or
2. An access point (Infrastructure network type)

Determine your network settings before installing the ASUS Pocket Wireless AP to avail all its features. The following network settings are recommended.

1.5.1 Access Point mode

When in access point (AP) mode the ASUS Pocket Wireless AP connects WLAN-enabled computers and/or devices to a wired or wireless LAN.

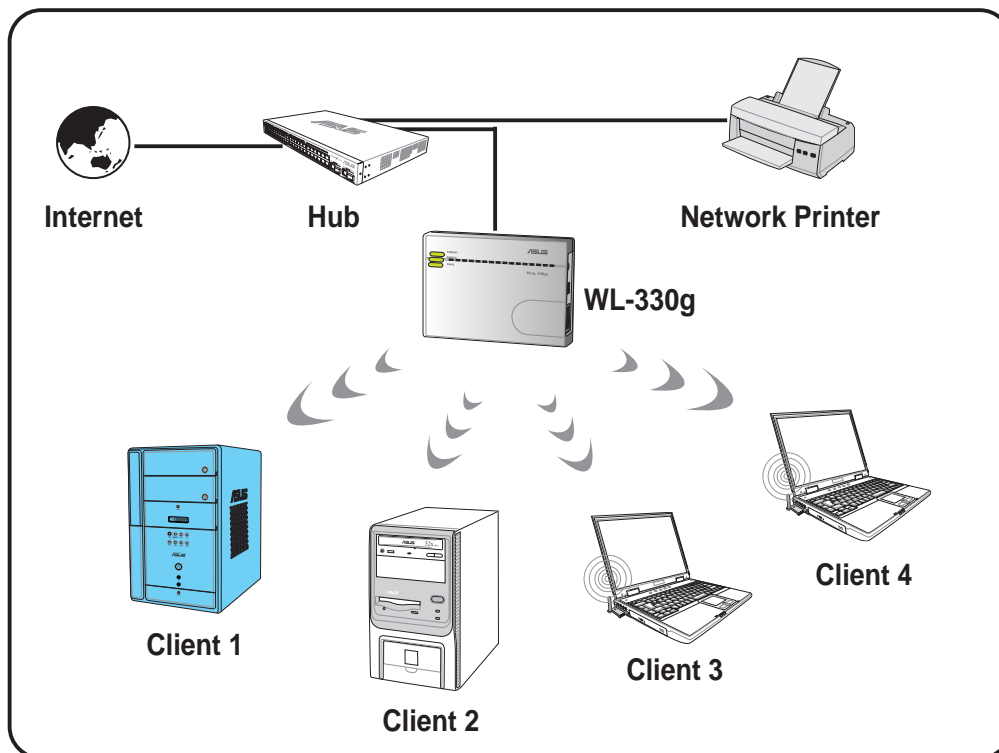

1.5.2 Ethernet adapter mode

Ad-hoc network

When in Ad-hoc network, the ASUS Pocket Wireless AP connects to another wireless device. No access point (AP) is present in this wireless environment.

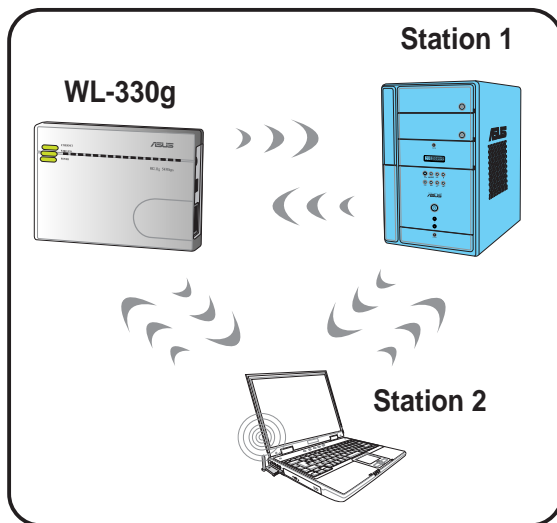

Infrastructure mode

When in Infrastructure mode, the wireless network is centered on an access point (AP) that provides a central link for wireless clients to communicate with each other or with a wired network.

In this setup, the ASUS Pocket Wireless AP connects to an AP using a single or multiple IP to establish connection to a wired or wireless LAN.

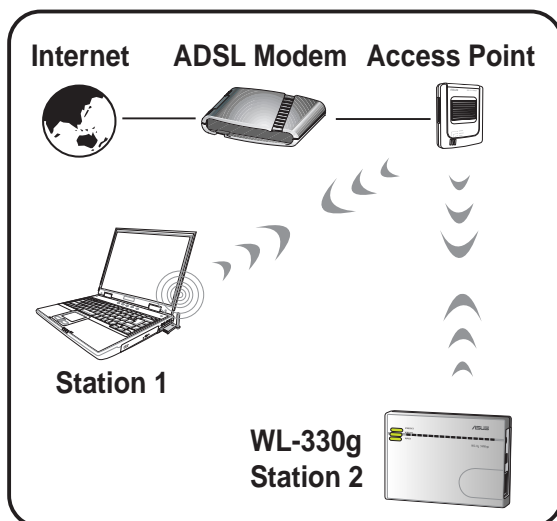

Single IP bridge environment

In a single IP bridge environment, the ASUS Pocket Wireless AP connects to an access point using a single IP address.

In this setup, the MAC cloning feature may be enabled to support certain applications and devices, such as Xbox and PlayStation® game consoles, that use the MAC address to communicate with other devices. MAC cloning allows the ASUS Pocket Wireless AP to communicate with other devices in a wireless network using the MAC address of the host computer instead of its own. Multiple IP bridge environment

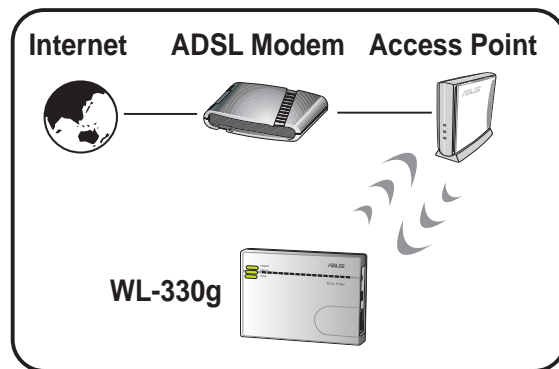

Multiple IP bridge environment

In a multiple IP bridge environment, the ASUS Pocket Wireless AP connects two or more wired devices to a wireless network from a hub or a switch.

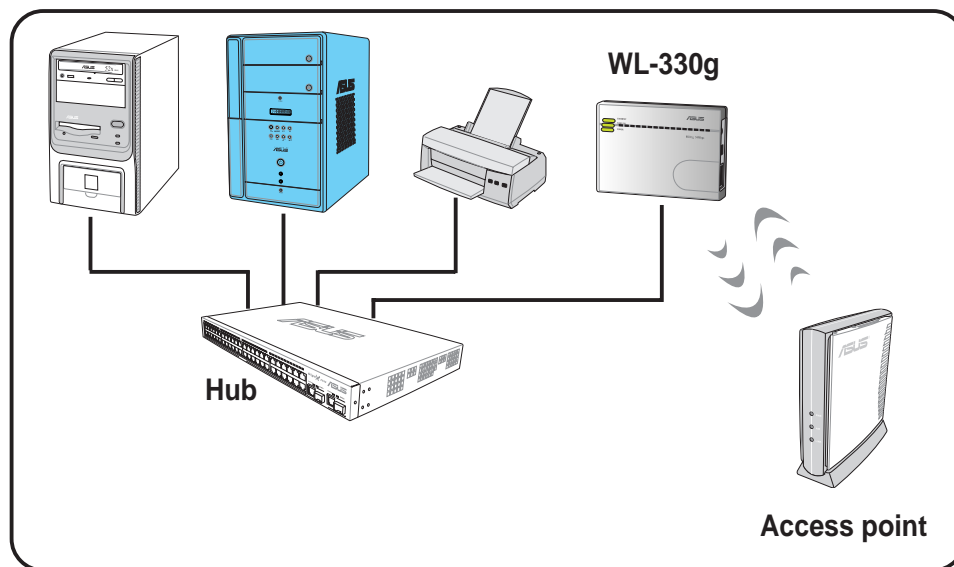

You must disable the MAC cloning feature when you set the device in Ethernet adapter mode under this environment. Enabling MAC cloning under this environment results to undefined and incorrect bridge behavior.

Chapter 2

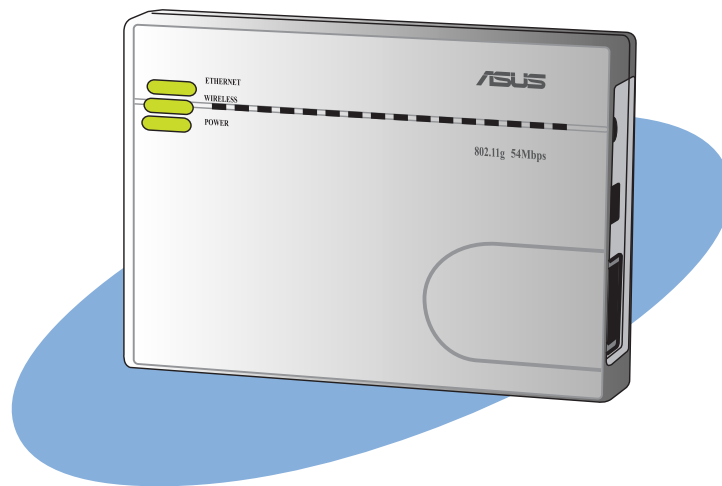

This chapter provides information on how to install the ASUS Pocket Wireless AP.

Hardware installation

2.1 System requirements

Before installing the ASUS Pocket Wireless AP, make sure that your system/network meets the following requirements:

- An Ethernet RJ-45 port (10Base-T/100Base-TX)
- At least one IEEE 802.11b/g device with wireless capability
- An installed TCP/IP and Internet browser

2.2 Device installation

Follow these instructions to install the ASUS Pocket Wireless AP.

1. Install the device utilities from the support CD.
2. Connect the device to your computer, network hub, switch, or router.

2.2.1 Before you proceed

Take note of the following guidelines before installing the ASUS Pocket Wireless AP.

- The length of the Ethernet cable that connects the device to the network (hub, ADSL/cable modem, router, wall patch) must not exceed 100 meters.
- Place the device on a flat, stable surface as far from the ground as possible
- Keep the device clear from metal obstructions and away from direct sunlight.
- Keep the device away from transformers, heavy-duty motors, fluorescent lights, microwave ovens, refrigerators, and other industrial equipment to prevent signal loss.
- Install the device in a central area to provide ideal coverage for all wireless mobile devices.
- Install the device at least 20cms from a person to insure that the product is operated in accordance with the RF Guidelines for Human Exposure adopted by the Federal Communications Commission.

2.2.2 Using DC power

1. Insert one end of the supplied RJ-45 cable to the WL-330g Ethernet port.
2. Insert the other end of the RJ-45 cable to a network hub, switch, router, or wall patch Ethernet port.
3. Connect the power adapter plug to the WL-330g DC-IN socket.
4. Connect the WL-330g power adapter to a wall socket.
5. Connect the network hub, switch, or router power adapter plug to the DC-IN socket of the device.
6. Connect the network hub, switch, or router power adapter to a wall socket.

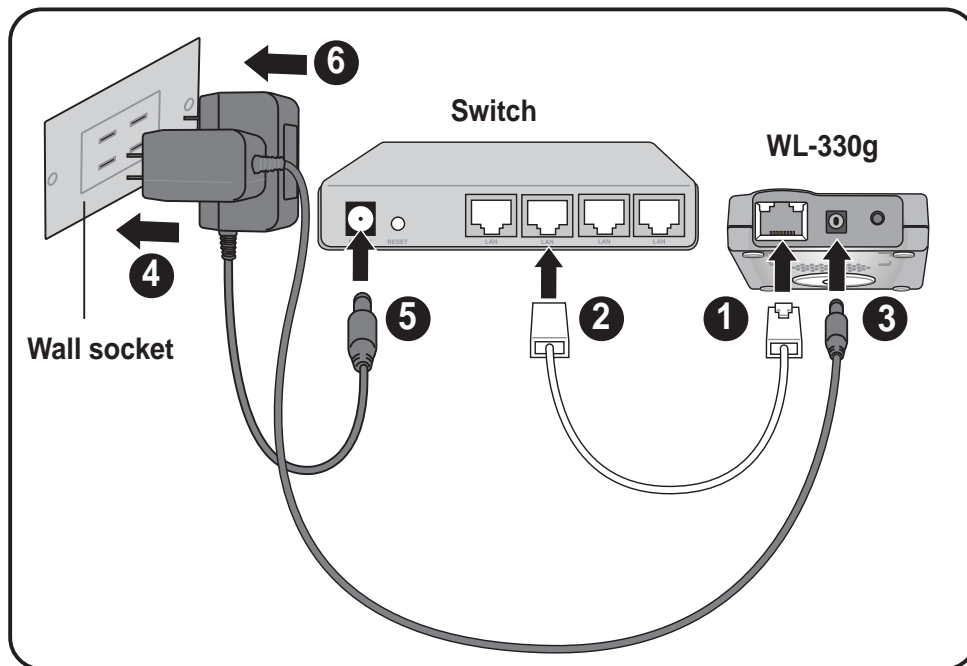

2.2.3 Using USB bus power

1. Insert one end of the supplied RJ-45 cable to the WL-330g Ethernet port.
2. Insert the other end of the RJ-45 cable to the Ethernet port on your computer, notebook, network hub, switch, router, or wall patch panel.
3. Insert one end of the supplied USB cable to the DC-IN socket of the device.
4. Insert the other end of the USB cable to any available USB port on your computer, notebook, network hub, switch, or router.
5. Turn on your computer/notebook, or connect the network hub, switch, or router power adapter to a wall socket.
6. Connect the power adapter of the network hub, switch, or router to a wall socket.

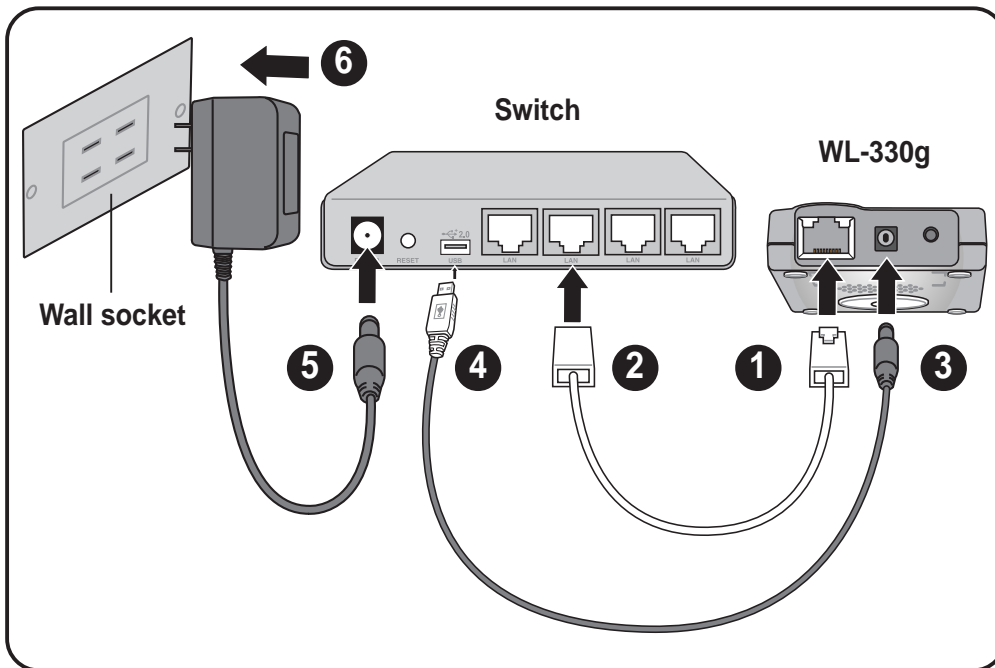

2.3 Placement

Wall mounting

Aside from desktop placement, you can install the ASUS Pocket Wireless AP vertically on a concrete or wooden wall using the mounting hook at the bottom side of the device.

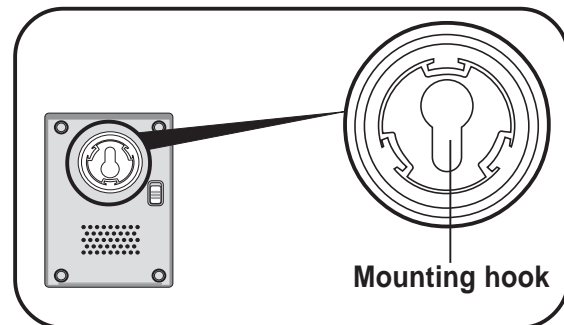

To mount the device on a concrete or wooden wall:

1. Locate the mounting hook at the bottom of the device.
2. Select an ideal location for the device.
3. Tighten a round head screw on the concrete or wooden wall until only 1/4 inch is showing.
4. Latch the device into the screw until the device is in place.



Adjust the screw if you cannot latch the device or if the screw is too loose.

2.4 Operating range

2.4.1 Range

The ASUS Pocket Wireless AP range is dependent on the operating environment. Every home or office layout varies in obstacles, barriers, or wall types which may reflect or absorb radio signals. For example, two 802.11b devices in an open space may achieve an operating distance of up to 1000 meters, while the same devices may only achieve up to 300 meters of range when used indoors.

The device automatically adjusts the data rate to maintain an operational wireless connection. A wireless device that is close to an AP may operate at higher speeds than a device far from the AP. You can configure the data rates that a device uses. If you limit the range of data rates available to the ASUS Pocket AP, you may reduce the effective range of the wireless LAN coverage.

2.4.2 Site survey

A site survey (utility provided with the ASUS Pocket Wireless AP) analyzes the installation environment and provides users with recommendations for equipment and its placement. The optimum placement differ depending on the device design and specifications.

2.5 Roaming information

If there are several ASUS Pocket Wireless APs operating on a network, then a wireless client (such as Centrino notebooks or wireless PDAs) may seamlessly roam from one ASUS Pocket Wireless AP to another. Each ASUS Pocket Wireless AP creates its own wireless cell or coverage area known as a Basic Service Set (BSS). Any wireless client can communicate with a particular ASUS AP if it is within that AP's coverage area.

If the cells of multiple ASUS Pocket APs overlap, then the wireless client may switch from one ASUS Pocket Wireless AP to another. During the transfer from one ASUS AP to another, the wireless mobile client maintains an uninterrupted connection to the network. This is called **roaming**.

Multiple ASUS Pocket APs connected to a common Ethernet network form an Extended Service Set (ESS). All members of an Extended Service Set are configured with an ID, known as the SSID or ESSID. Wireless clients must be configured with the same SSID as that of the ASUS Pocket APs on the network since it can only roam between ASUS Pocket APs sharing the same SSID.

Important notes on roaming

- An ASUS WLAN card can only roam between APs of the same type.
- All ASUS Pocket Wireless APs must have the same SSID.
- All computers with ASUS WLAN cards must have the same SSID as the access points to enable roaming.
- If encryption is enabled, all ASUS APs and wireless clients must use the same encryption to establish connection.
- ASUS Pocket Wireless APs' cells must overlap to provide an uninterrupted connection for a roaming client.
- ASUS Pocket Wireless APs using the same channel should be installed away from each other to reduce potential interference.
- We strongly recommended that you perform a site survey using the ASUS Pocket Wireless AP utility to determine the best location for each wireless device.

Chapter 3

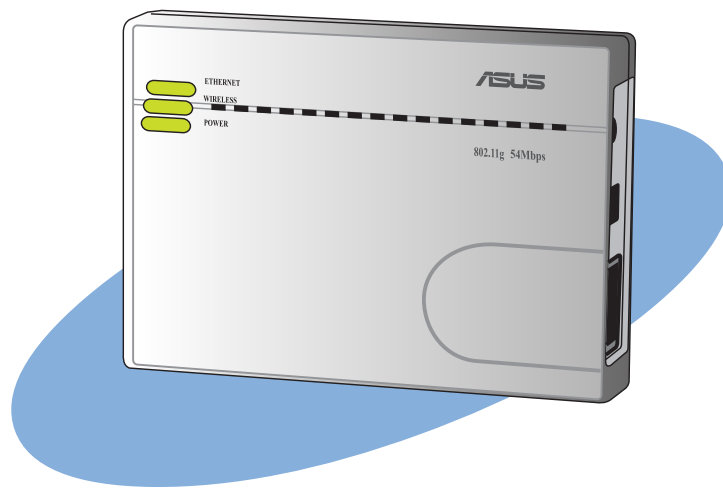

This chapter provides information on how to configure the ASUS Pocket Wireless AP using the utilities available from the support CD.

Configuration

3.1 Installing the utilities

The support CD contains the utilities for configuring the ASUS Pocket Wireless AP.

To install the device utilities in your computer:

1. Insert the support CD to the optical drive.
2. Click **Install ASUS WLAN AP Utilities** when the ASUS Wireless Access Point WL-330g installation window appears.
3. The device utilities are copied to your computer.



If Autorun is NOT enabled in your computer, browse the contents of the support CD and double click the Setup.exe file to run the CD.

Other support CD options

Uninstall ASUS WLAN AP Utilities. Click this option to uninstall the ASUS Pocket Wireless AP utilities from your system.

Run Wireless Setting Utility. Click this option to run the Wireless Setting Utility.

Read/Install Quick Start Guide and User's Manual. Click to view the installation and quick setup guides in PDF format.

Explore this CD. Click this option to explore the support CD contents.

Browse our Web Site. Click this option to visit the ASUS website.

Installation Language. Click the arrow down button to select the installation language.

Click **EXIT** to close the installation window.

3.2 Wireless Setting Utility

The Wireless Setting Utility allows easy configuration of the ASUS Pocket Wireless AP in both access point and Ethernet adapter modes. You can launch the Wireless Setting Utility directly from the support CD or from the Windows® desktop.

3.2.1 Launching the Wireless Setting Utility

From the support CD

To launch the Wireless Setting Utility from the support CD:

1. Insert the support CD to the optical drive.
2. Click the **Run Wireless Setting Utility** option when the installation window appears. Refer to the illustration on the previous page.
3. The Wireless Setting Utility window appears.



From the Windows® desktop

1. Install the device utilities following the steps in section 3.1.
2. From the Windows® desktop, click **Start > All Programs > ASUS Utility > Wireless AP > Wireless Setting**.
or
Double-click the **ASUS Wireless Setting** icon.
3. The Wireless Setting Utility window appears.

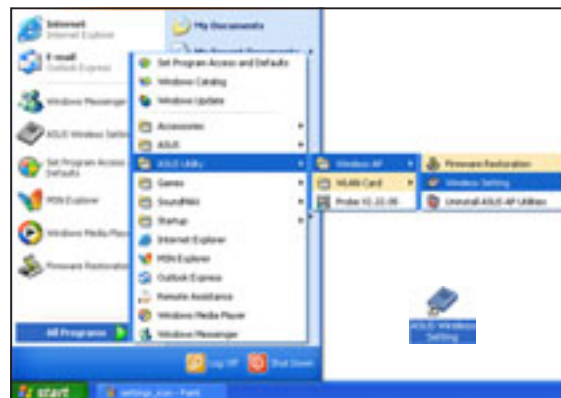

3.2.2 Using the Wireless Setting Utility

To set the device as an access point (AP)



Make sure that you switched the WL-330g to AP mode before launching the Wireless Setting Utility. Use the mode switch to change the device operating mode.

1. The utility auto-detects and displays the WL-330g SSID, channel, encryption, MAC, and IP address. Click **Configure** to change these settings.



2. Log on to the configuration window using the password (**admin**), check the **Remember my password** option, then click **OK**.

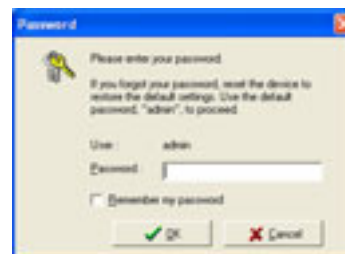

Checking the **Remember my password** option allows the utility to auto-fill the password everytime you enter the Wireless Setting configuration. Refer to page 3-20 for details on changing the log-on password.

3. Enter the Network Name (SSID) and channel you wish. Click the **Encryption** link or tab to set the encryption settings. Otherwise, click **OK** to finish setting up the AP.



To establish connection, a wireless client must have the same SSID, channel, and encryption settings as that of the WL-330g.

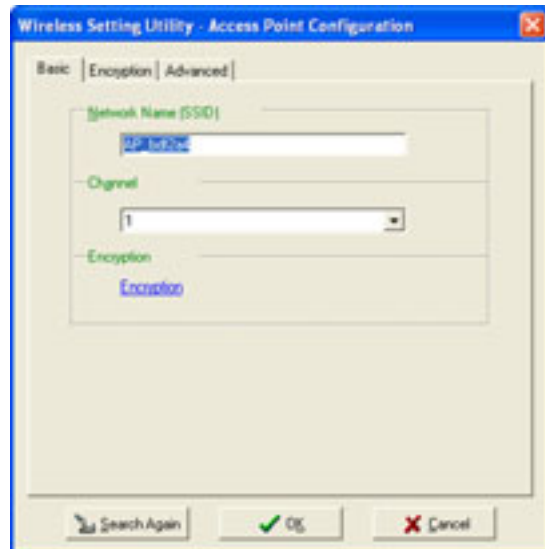

4. Set the WL-330g encryption settings. Click the **Advanced** tab to adjust the WL-330g network settings. Otherwise, click **OK** to finish setting up the AP.

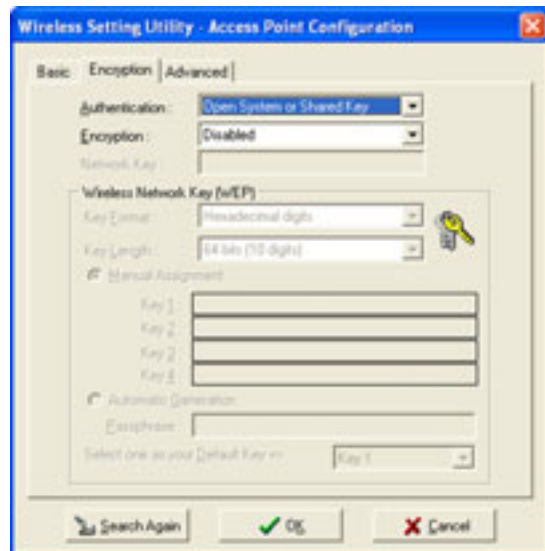

5. If necessary, adjust the WL-330g network settings, then click **OK** to finish the setup. Otherwise, click the **Web Configuration Utility** button to launch the web-based configuration utility.



Check the **Obtain an IP address automatically** if your network has an enabled DHCP server. Inquire with your network administrator for details.



6. The specified settings are applied to the device.



7. After applying the settings, the utility displays the WL-330g access point information. Click **Finish** to close the utility.



To set the device as an Ethernet adapter



Make sure that you switched the WL-330g to Ethernet adapter mode before launching the Wireless Setting Utility. Use the mode switch to change the device operating mode.

1. The utility auto-detects and displays the WL-330g Ethernet adapter settings. Click **Configure** to continue.



2. Log on to the configuration window using the password (**admin**), check the **Remember my password** option, then click **OK**.



3. Select a wireless network from the **Available Networks** field, then click **Configure**.



- Each wireless network is preceded by an icon for easy identification. Refer to the table on the next page for icon indications.
- Click **Add** to connect to another wireless network not listed in the field.

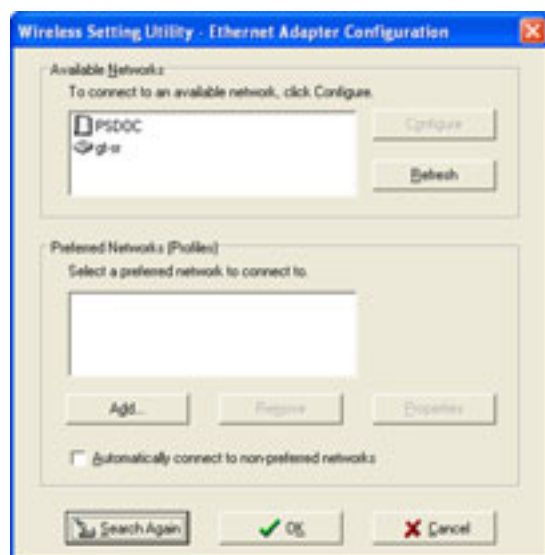







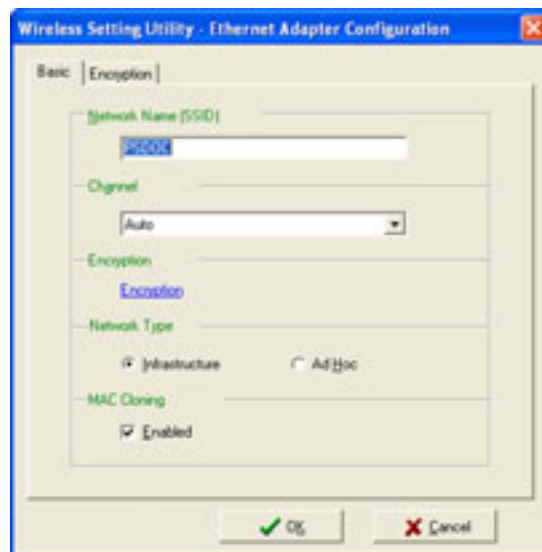

Table 3-1: Wireless network icon indications

Icon	Indicates that
	the wireless network is an access point with no encryption
	the wireless network is an access point with enabled encryption
	the WL-330g is connected to this access point with no encryption
	the WL-330g is connected to this access point with enabled encryption
	the wireless network is a wireless device with no encryption
	the wireless network is a wireless device with enabled encryption
	the WL-330g is connected to this wireless device with no encryption
	the WL-330g is connected to this wireless device with enabled encryption

- The WL-330g automatically adjusts to the SSID and channel settings of the selected wireless network. Click **OK**.



- The selected wireless network appears in the **Preferred Networks** field. Select the network, then click **OK**.

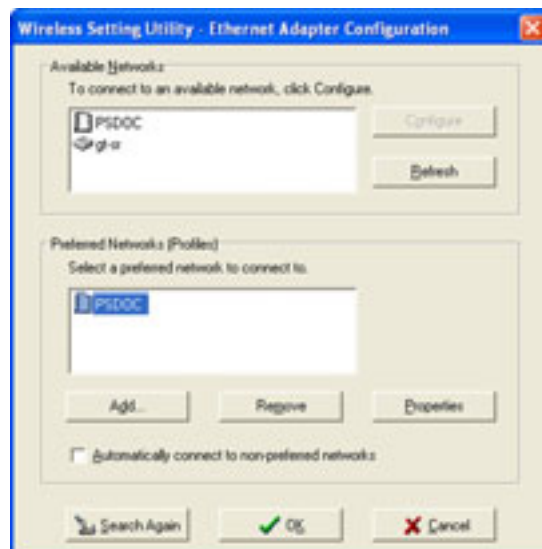



If the selected network has enabled encryption, use the **Encryption** tab to set the WL-330g encryption settings the same with the selected network. The encryption settings of the network and the WL-330g must be the same to establish connection.

6. The WL-330g connects to the selected wireless network.



7. The utility displays the WL-330g status when connection is established. Click **Finish** to close the utility.



3.3 Web Configuration utility

The Web Configuration utility allows you to configure the ASUS Pocket Wireless AP using a web browser on your computer. The following sections provide information on how to launch and use this utility.

3.3.1 Adjusting the TCP/IP settings

By default, the IP address of the ASUS Pocket Wireless AP is 192.168.1.1, and the Subnet Mask is 255.255.255.0. To access the configuration utility, assign a different IP address to the network adapter where the ASUS Pocket Wireless AP is connected.

To adjust the TCP/IP settings of the network adapter:

1. Right-click the **My Network Places** icon in the Windows® desktop, then select **Properties** from the pop-up menu. The **Network and Dial-up Connections** window appears.

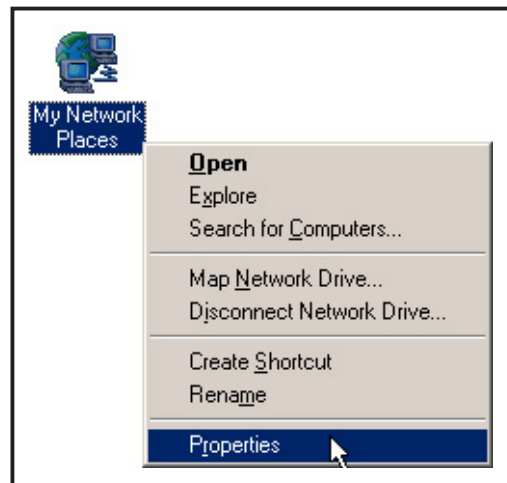

2. Right-click the network adapter used by the the ASUS Pocket Wireless AP, then select **Properties** from the pop-up menu. The **Local Area Connection Properties** window appears.

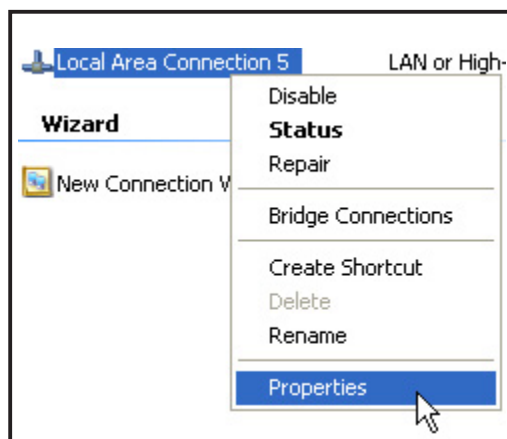

3. Double-click the **Internet Protocol (TCP/IP)** item to display the **Internet Protocol (TCP/IP) Properties** window.

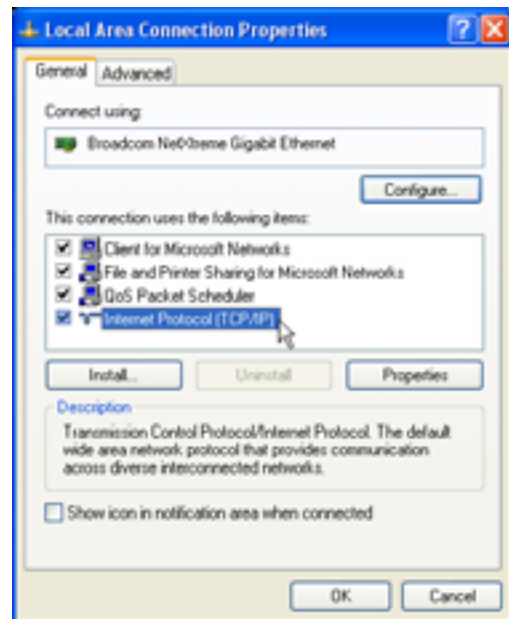

4. Check the **Use the following IP address** option, then enter the IP address for the network adapter. The **IP address** must be **192.168.1.X**. (X can be any number between 2 and 254 that is not used by another device.)



5. Set the **Subnet Mask** to **255.255.255.0**. Click **OK** when finished.



Changing the TCP/IP settings may require system restart. Switch on the WL-330g immediately after rebooting.

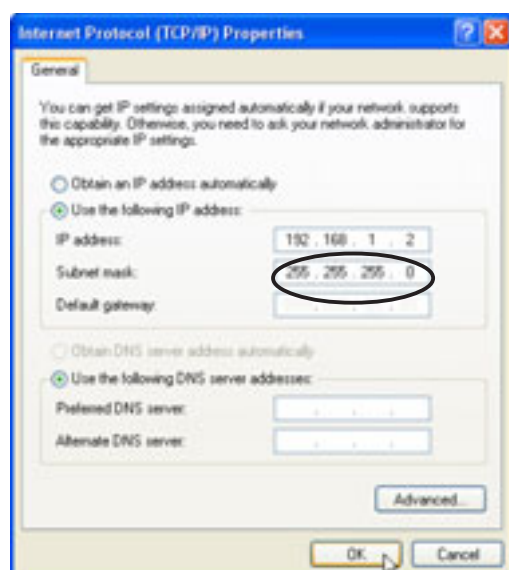

3.3.2 Launching the Web Configuration utility

Using the Wireless Setting Utility



You can only launch the Web Configuration utility from the Wireless Setting Utility when the device is in AP mode. Switch the device to AP mode using the mode switch before launching the Wireless Setting Utility.

To launch the Web Configuration utility using the Wireless Setting Utility:

1. Click **Start > All Programs > ASUS Utility > Wireless AP > Wireless Setting**.
2. Click **Configure** when the Wireless Setting Utility window appears.
3. Log on to the configuration window using the password (**admin**), then click **OK**.
4. Disable your proxy settings, if any.
5. Click the **Advanced** tab, then click the **Web Configuration Utility** button.

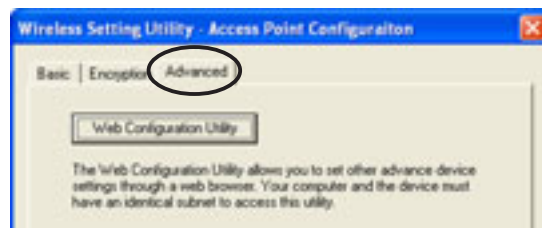

6. A web browser appears. When prompted, enter the default password (**admin**), check the **Remember my password option**, then click **OK**. The Web Configuration utility page appears.

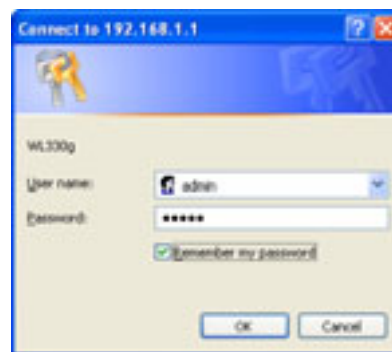

Using an Internet browser

To launch the Web Configuration utility using an Internet web browser:

1. Open a web browser.
2. Disable your proxy settings, if any.
3. Type **http://192.168.1.1** on the address bar of the browser, then press <Enter>.



This option requires you to change the IP address of the LAN adapter where the WL-330g is connected. Make sure the IP address of the WL-330g and your computer is on the same subnet.

3.3.3. Changing the access point (AP) configuration

Simple Setup page

The Simple Setup page displays the default AP settings of the WL-330g. Use this page to set the AP channel, operation mode, and security.

Clicking the  button displays available options for that field. If you wish to load the default settings, press the device reset button for more than five seconds, then refresh your browser to display the default values.

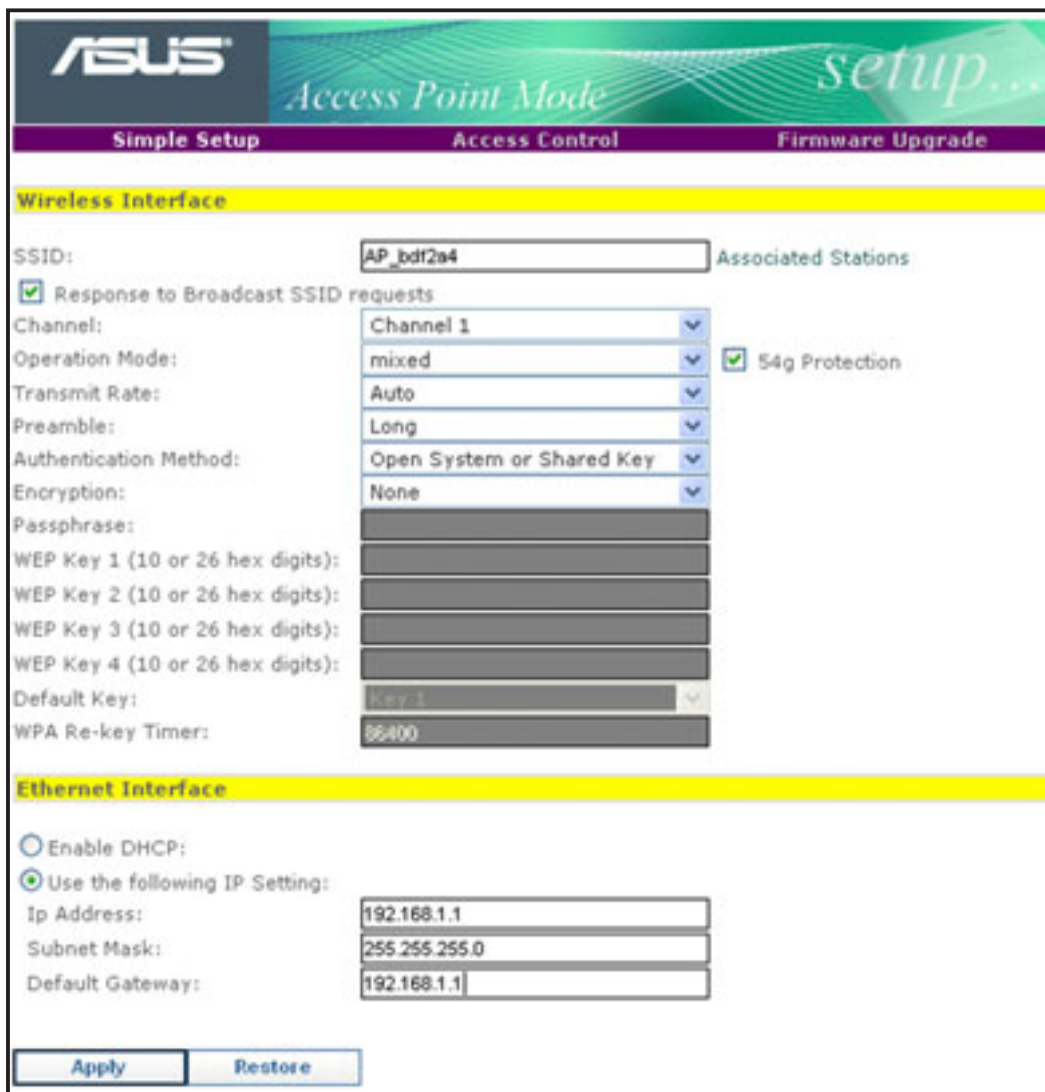

The screenshot shows the ASUS Access Point Mode Simple Setup page. The page is titled "ASUS Access Point Mode setup..." and has three tabs: "Simple Setup", "Access Control", and "Firmware Upgrade". The "Simple Setup" tab is active. The "Wireless Interface" section includes the following fields and options:

- SSID: AP_bdf2a4
- Response to Broadcast SSID requests:
- Channel: Channel 1
- Operation Mode: mixed
- Transmit Rate: Auto
- Preamble: Long
- Authentication Method: Open System or Shared Key
- Encryption: None
- Passphrase: [Redacted]
- WEP Key 1 (10 or 26 hex digits): [Redacted]
- WEP Key 2 (10 or 26 hex digits): [Redacted]
- WEP Key 3 (10 or 26 hex digits): [Redacted]
- WEP Key 4 (10 or 26 hex digits): [Redacted]
- Default Key: Key 1
- WPA Re-key Timer: 86400

The "Ethernet Interface" section includes the following options and fields:

- Enable DHCP:
- Use the following IP Setting:
- Ip Address: 192.168.1.1
- Subnet Mask: 255.255.255.0
- Default Gateway: 192.168.1.1

At the bottom of the page are "Apply" and "Restore" buttons.

SSID (Service Set Identifier). This field displays the SSID of the device. Enabling the **Response to Broadcast SSID requests** option allows the device to broadcast its SSID in a wireless network. This allows other wireless devices to scan and establish communication with the device. Unchecking this option hides the SSID to prevent other wireless devices from recognizing and connecting to the device.

Click the **Associated Stations** link (beside the SSID) to displays the list of wireless device(s) associated with the ASUS Pocket Wireless AP. The list includes the wireless device(s) MAC address and connection status.

Channel. Allows you to specify the channel the device uses to communicate with other wireless device(s) in the network.

The 802.11g specification supports up to 13 overlapping channels for radio communication. If several ASUS Pocket Wireless APs are operating in the same area, assign a non-overlapping channel to each device to avoid interference. Refer to page 3-21 for channel information.

Operation Mode. You can adjust the WL-330g operating mode to support wireless devices using IEEE 802.11b or IEEE 802.11g standards. Setting the operating mode to **mixed** allows the WL-330g to support both wireless standards.

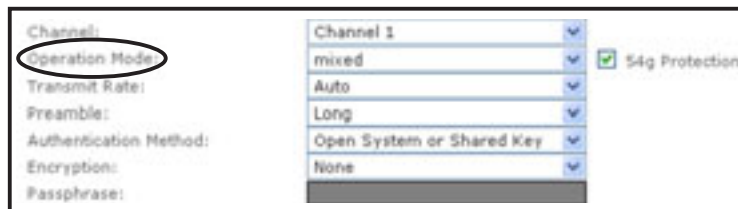

Table 3-2: WL-330g operating modes

Operation mode	Supported wireless client(s)
B only	IEEE 802.11b client(s) only
G only	IEEE 802.11g client(s) only
Mixed	IEEE 802.11b and IEEE 802.11g clients

Transmit Rate. This option allows you to specify the data transmission rate for both IEEE 802.11b and IEEE 802.11g devices. Select from 54, 48, 36, 24, 18, 12, 11, 9, 6, 5.5, 2 and 1Mbps data transfer rate.

Preamble. Allows you to set the preamble mode for a 2.4GHz/11Mb network to Long, Short, or Auto. The default preamble mode is **Long**.

The following fields allow you to configure the ASUS Pocket Wireless AP security settings.

Authentication Method. This option allows you to select the encryption method for securing your wireless communication. Refer to the table below for details.

Table 3-3: Authentication methods

Method	Description
Open system or shared key	This method allows the device to accept connection requests from any wireless device within its operating range.
Shared Key	Only wireless device(s) with the same encryption are allowed to connect to the AP.
WPA-PSK	Only wireless device(s) with the same TKIP encryption settings are allowed to connect to the AP.

Encryption. The encryption field allows you to set the encryption for your selected authentication method. Refer to the table below for a comparison of the encryption settings. specify a 64-bit or a 128-bit WEP key. A 64-bit encryption contains 10 hexadecimal digits or 5 ASCII characters. A 128-bit encryption contains 26 hexadecimal digits or 13 ASCII characters.

Table 3-4: Encryption settings

Method	Encryption	Description
Open system	None	No encryption
Shared Key	64-bit WEP*	Contains 10 hexadecimal digits or 5 ASCII characters
	128-bit WEP	Contains 26 hexadecimal digits or 13 ASCII characters
WPA-PSK	TKIP**	Contains 8 to 63 alpha-numeric characters

* Wired Equivalent Privacy

** Temporal Key Integrity Protocol

Securing your wireless communication using WEP encryption

To secure your wireless communication using the WEP encryption:

1. Assign the WEP encryption keys by manual or automatic generation.

Manual Assignment. For a 64-bit encryption, enter 10 hexadecimal digits (0~9, a~f, A~F) or 5 ASCII characters in each of the four WEP keys. For 128-bit encryption enter 26 hexadecimal digits (0~9, a~f, A~F) or 13 ASCII characters in each of the four WEP keys.

Automatic Generation. Type a combination of up to 64 letters, numbers, or symbols in the **Passphrase** field. The Web Configuration utility uses an algorithm to generate four WEP keys based on the typed combination.

2. Specify the default WEP encryption key in the **Default Key** field.
3. Click the **Apply** button when finished.



- 64-bit and 40-bit WEP keys use the same encryption method and can interoperate on wireless networks. This lower level of WEP encryption uses a 40-bit (10 hexadecimal digits assigned by the user) secret key and a 24-bit Initialization Vector assigned by the device. 104-bit and 128-bit WEP keys use the same encryption method.
- Keep a record of the WEP encryption keys
- All wireless clients in a network must have identical WEP keys with the access point to establish connection.

Securing your wireless communication using TKIP (WPA) encryption

The WL-330g implements the Wi-Fi Protected Access (WPA)-PSK authentication method to secure communication to and from wireless devices. This method uses the Temporal Key Integrity Protocol (TKIP) encryption.

To secure your wireless communication using the TKIP:

1. Select **WPA-PSK** as the **Authentication Method**.
2. Type 8 ~ 63 alpha-numeric characters in the **Passphrase** field.

The screenshot shows a configuration window with the following fields and values:

Preamble:	Long
Authentication Method:	WPA-PSK
Encryption:	TKIP
Passphrase:	
WEP Key 1 (10 or 26 hex digits):	
WEP Key 2 (10 or 26 hex digits):	
WEP Key 3 (10 or 26 hex digits):	
WEP Key 4 (10 or 26 hex digits):	
Default Key:	Key 1
WPA Re-key Timer:	300

3. Set the **WPA Re-key Timer** (1 ~ 2147483647 seconds). The re-key timer allows you to set the time interval before the WPA group key is changed.

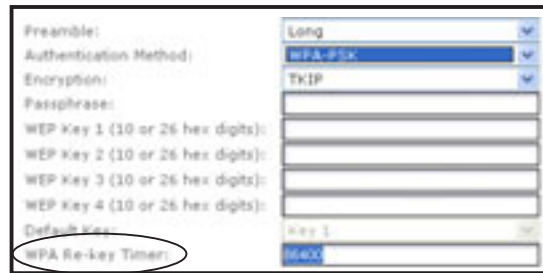

The screenshot shows a configuration window for WPA settings. The fields are: Presmile (dropdown), Authentication Method (dropdown, set to WPA-PSK), Encryption (dropdown, set to TKIP), Passphrase (text field), WEP Key 1 (10 or 26 hex digits) (text field), WEP Key 2 (10 or 26 hex digits) (text field), WEP Key 3 (10 or 26 hex digits) (text field), WEP Key 4 (10 or 26 hex digits) (text field), Default Key (dropdown, set to Key 1), and WPA Re-key Timer (text field, circled in red).



A shorter re-key interval provides a more secure wireless network.

Changing the network settings

The **Ethernet Interface** fields allow you to configure the ASUS Pocket Wireless AP.



Inquire the correct network settings with your network administrator before changing any Ethernet interface settings.

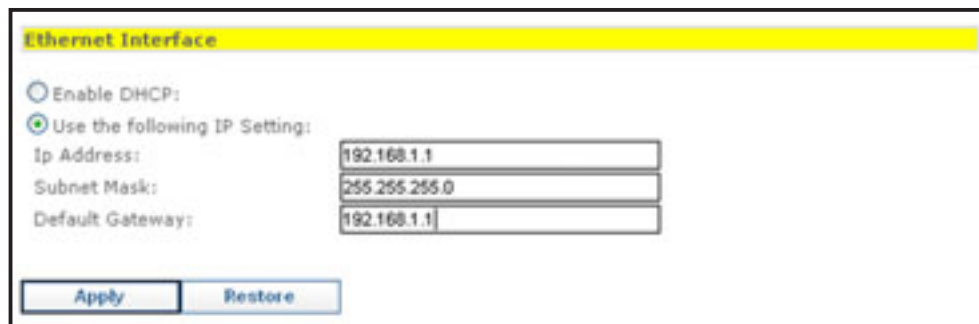

The screenshot shows the 'Ethernet Interface' configuration window. It has a yellow header. Below the header, there are two radio buttons: 'Enable DHCP' (unselected) and 'Use the following IP Setting:' (selected). Under 'Use the following IP Setting:', there are three text fields: 'Ip Address' (192.168.1.1), 'Subnet Mask' (255.255.255.0), and 'Default Gateway' (192.168.1.1). At the bottom, there are two buttons: 'Apply' and 'Restore'.

Enable DHCP. When enabled, the Dynamic Host Configuration Protocol (DHCP) server automatically assigns the IP address, Subnet Mask, and Default Gateway of the ASUS Pocket Wireless AP.

Use the following IP setting. Select this option to manually assign the IP address, Subnet Mask, and Default Gateway the ASUS Pocket Wireless AP.

Click **Apply** after configuring the network settings. Otherwise, click **Restore** to load the default values.

Access Control page

The MAC Access Control page allows you to control the wireless network traffic by specifying the MAC addresses of wireless clients allowed to establish connection to the WL-330g.

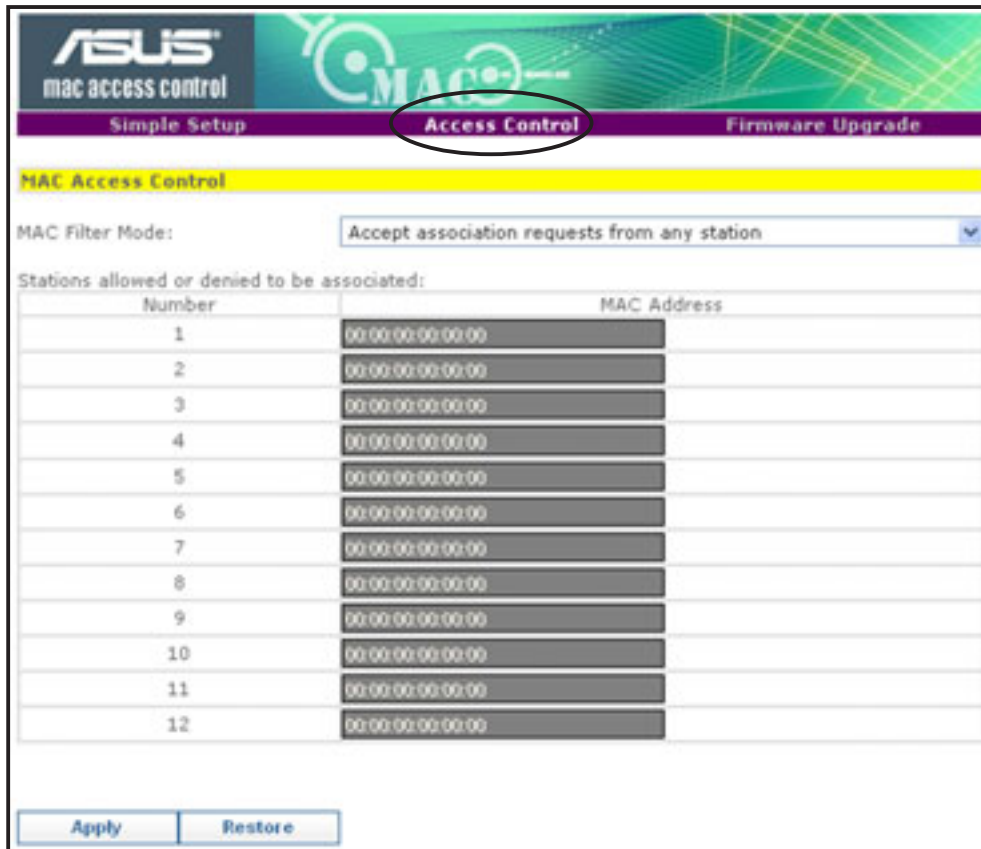

ASUS mac access control

Simple Setup **Access Control** Firmware Upgrade

MAC Access Control

MAC Filter Mode:

Stations allowed or denied to be associated:

Number	MAC Address
1	00:00:00:00:00:00
2	00:00:00:00:00:00
3	00:00:00:00:00:00
4	00:00:00:00:00:00
5	00:00:00:00:00:00
6	00:00:00:00:00:00
7	00:00:00:00:00:00
8	00:00:00:00:00:00
9	00:00:00:00:00:00
10	00:00:00:00:00:00
11	00:00:00:00:00:00
12	00:00:00:00:00:00

To specify the wireless clients allowed to establish connection to the WL-330g:

1. Click , then select the **Only allow Stations with MAC listed below to access this device** option. The MAC address fields are activated



MAC Access Control

MAC Filter Mode:

2. Type the MAC address(es) of the wireless clients allowed to establish connection to the WL-330g, then click **Apply**.



Selecting the **Accept association requests from any station** option allows all wireless clients operating within the WL-330g range to establish connection.

Firmware Upgrade page

The **Firmware Upgrade** page displays the product ID, firmware version, and regulation domain. This page allows you to:

1. upgrade the firmware when it becomes outdated or corrupted, and
2. change the log on password.

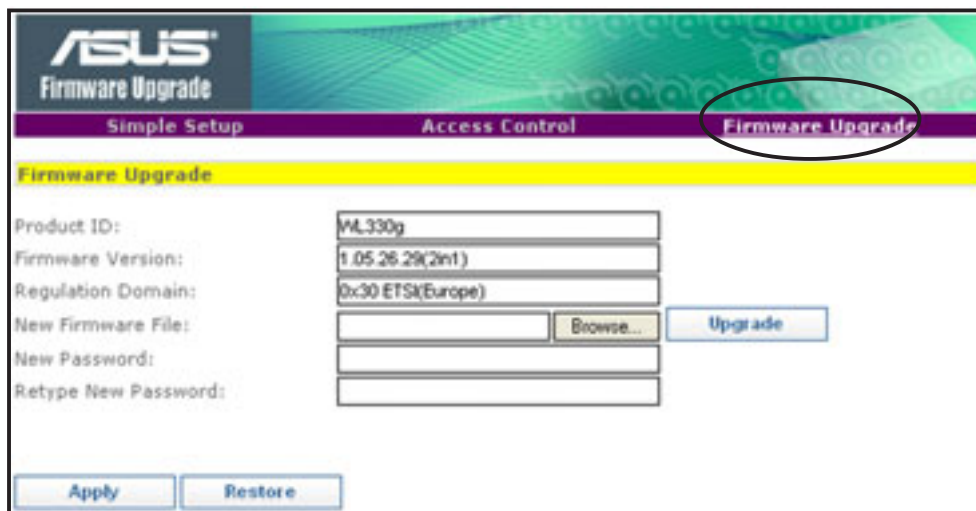

To upgrade the firmware:



The Power LED blinks continuously when the firmware is corrupted or when the firmware upgrade fails.

1. Download and save the latest firmware from the ASUS website.
2. Launch the Web Configuration Utility, then go to the **Firmware Upgrade** page.
3. Click the **Browse** button to locate the new firmware file.
4. Click **Upgrade**. A **Firmware Upgrading!** message appears. The browser refreshes after the firmware upgrade process is completed.



To change the log on password:

1. Type the new password in the **New Password** and **Retype New Password** fields, then click **Apply**.

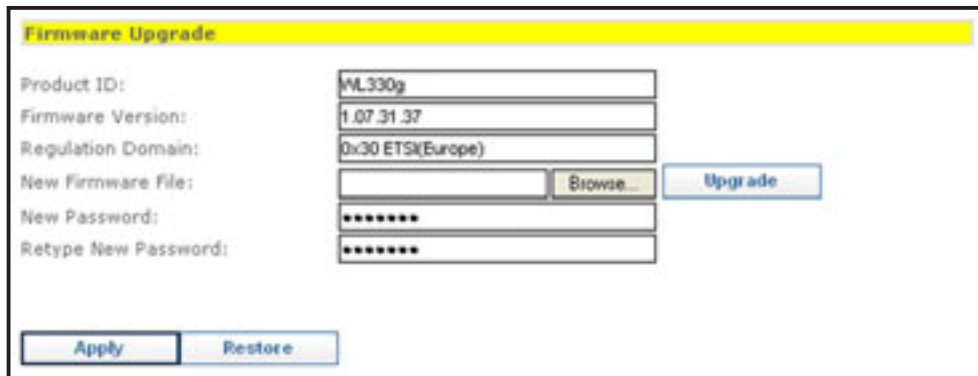

2. A message appears indicating that you have successfully changed the log on password. The browser refreshes with the new password.



Use your new password when launching both the Wireless Setting configuration window and Web Configuration utilities.

Regulation Domain

IEEE 802.11b/g networks are regulated worldwide since these networks use the 2.4GHz ~ 2.5GHz ISM (Instrumentation, Scientific, and Medical) Band. The ASUS Pocket Wireless AP is shipped with a default regulation domain allowed in your country/location.

The FCC (US) and ETSI (Europe) specify operation from 2.4 GHz to 2.4835 GHz. For Japan, operation is specified as 2.4 GHz to 2.497 GHz. For each supported regulatory domain, all channels marked with "Yes" are supported. The channel center frequencies and CH ID numbers are shown on the next page.

Table 3-5: DSSS PHY frequency channel plan

CH ID	Frequency	Regulatory Domain		
		X'10' FCC	X'30' ETSI	X'40' MKK
1	2412 MHz	Yes	Yes	Yes
2	2417 MHz	Yes	Yes	Yes
3	2422 MHz	Yes	Yes	Yes
4	2427 MHz	Yes	Yes	Yes
5	2432 MHz	Yes	Yes	Yes
6	2437 MHz	Yes	Yes	Yes
7	2442 MHz	Yes	Yes	Yes
8	2447 MHz	Yes	Yes	Yes
9	2452 MHz	Yes	Yes	Yes
10	2457 MHz	Yes	Yes	Yes
11	2462 MHz	Yes	Yes	Yes
12	2467 MHz	–	Yes	Yes
13	2472 MHz	–	Yes	Yes
14	2484 MHz	–	–	Yes

In a multiple cell network topology, overlapping and/or adjacent cells using different channels can operate simultaneously without interference if the distance between the center frequencies is at least 30 MHz. Channel 14 is specifically for operation in Japan.

Table 3-6: Regulating bodies and allowed channels

Country	Regulating body	Allowed channels
Unites States	FCC	1-11
Europe	ETSI	1-13
Japan	MKK	1-14



Use only the allowed channels when you set the ASUS Pocket Wireless AP in access point mode.

Restoring the default values

The following are the default values of the ASUS Pocket Wireless AP (in AP mode). You can restore the default values by pressing the reset button for more than five seconds.

Parameter	Default value
<i>Wireless Interface</i>	
SSID	AP_XXXXXX
Response to broadcast SSID requests	Enabled
Channel	Channel 1
Operation mode	mixed
Transmit Rate	Auto
Preamble	Long
Authentication Method	Open System or Shared Key
Encryption	None
<i>Ethernet Interface</i>	
Enable DHCP	No (Disabled)
IP Address	192.168.1.1
Subnet Mask	255.255.255.0
Default Gateway	Blank
<i>Access Control</i>	
Accept association requests from any station	Enabled

3.3.4 Changing the Ethernet adapter configuration



You must switch the device to Ethernet adapter mode using the mode switch before changing any Ethernet adapter settings.

Simple Setup page

The Simple Setup page allows you to change the basic Ethernet adapter settings. You can use this page when setting the WL-330g SSID, station mode, transmission rate, security, and when enabling the MAC cloning and button scan mode features.

The screenshot shows the ASUS Ethernet Adapter Mode Simple Setup page. The page is titled "Ethernet Adapter Mode setup..." and has three tabs: "Simple Setup", "Site Survey", and "Firmware Upgrade". The "Simple Setup" tab is selected. The page is divided into sections: "Wireless Interface" (highlighted in yellow), "Button Scan Mode" (highlighted in grey), and "Apply" and "Restore" buttons at the bottom. The "Wireless Interface" section includes fields for SSID (ANY), Operating Mode (Infrastructure Mode selected), Channel (Automatic), Station Mode (802.11b/g), Transmission Rate (Automatic), Preamble (Long), Authentication Method (Open System), Encryption (None), Pass Phrase, WEP Key 1-4, and Default Key. The "Button Scan Mode" section includes "Enable Button Scanning" (checked), Scan Mode (Find the connection with the strongest link quality), and Specified Profile (No Saved Profile).

SSID (Service Set Identifier). This field allows you to specify the SSID of the ASUS Pocket Wireless AP in Ethernet adapter mode.

Operating Mode. This field allows you to select the operating mode for the Ethernet adapter. In an **Infrastructure** mode, the ASUS Pocket Wireless AP connects to an available AP. In **Ad-hoc** mode, the ASUS Pocket Wireless AP connects to other wireless devices in the wireless network. Select Ad-hoc mode when there is no available AP in your location.

Channel. Select the channel used by the AP (Infrastructure) or the wireless device (Ad-hoc) to establish connection.

Station Mode. This field allows you to select the device wireless standard while in Ethernet adapter mode. Selecting 802.11b/g allows the device to connect to both wireless standards.

Transmission Rate. This field allows you to adjust the data transmission rate between the WL-330g and the AP/wireless device.

Preamble. See page 3-14.

Authentication Method. See page 3-15.

Encryption. See page 3-15.

Pass Phrase. See page 3-16.

Default Key. See page 3-16.

MAC cloning. MAC cloning allows the ASUS Pocket Wireless AP to use the MAC address of the host computer in communicating with other wireless devices. MAC cloning supports certain software applications and devices such as Xbox and PlayStation® 2 game consoles.

Using the Button Scan Mode feature

The **Button Scan Mode** allows you to use the reset button to connect to an access point (Infrastructure mode) or wireless device (Ad-hoc mode) saved in the **Profile Table** of the configuration utility or in your location.

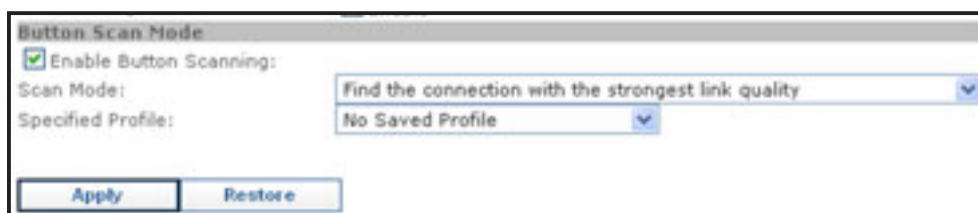

Save the profile of the wireless connection using the **Site Survey** window. See the next section for details.



You must save at least one wireless connection profile before using the Button Scan Mode.

Scan Mode. This field allows you to select the scan mode for button scanning. Click  to display available options.

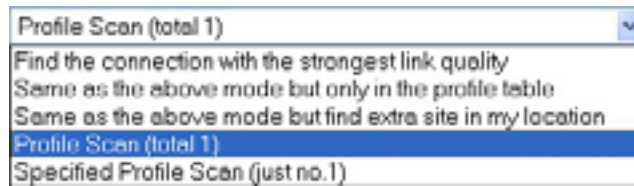

Find the connection with the strongest link quality- When the reset button is pressed for less than 5 seconds, the ASUS Pocket Wireless AP connects to an AP or wireless device with the strongest link quality.

Same as the above mode but only in the profile table - When the reset button is pressed for less than 5 seconds, the ASUS Pocket Wireless AP searches for an AP or wireless device in the Profile Table, then connects to the one with the strongest link quality.

Same as the above mode but find extra site in my location- When the reset button is pressed for less than 5 seconds, the ASUS Pocket Wireless AP searches for an AP or wireless device in the Profile Table and in your location, then connects to the one with the strongest link quality.

Profile Scan (total x)- This mode allows you to connect to a saved wireless network by their sequence in the Profile Table. Press the reset button once to connect to the first wireless connection in the Profile Table. Press again to connect to the second wireless connection, and so on.

For example, if you have three saved profiles in the profile table, the ASUS Pocket Wireless AP automatically connects to the first profile. Press the reset button to connect to the second saved profile. Press the reset button again to connect to the third saved profile.

Specified profile scan (just no. x)- When the reset button is pressed for less than 5 seconds, the ASUS Pocket Wireless AP automatically connects to the specified profile. The saved profiles are numbered from 1 ~ x. You must select the profile number using the Specified Profile field.



When using the Alphabet Scan, the AP or wireless device you wish to connect to must have a disabled WEP encryption and available SSID.

Specified Profile. This field allows you to select a saved wireless network in the Profile Table. The ASUS Pocket Wireless AP automatically connects to the selected profile when **Scan Mode** is set to **Specified profile scan**.

Click **Apply** when done. Otherwise, click **Restore** to load the default values.

Site Survey page

The Site Survey page displays the **Station Status**, and allows you to scan and connect to available wireless networks within the WL-330g range. This page also allows you to save a wireless connection in the **Profile Table** for the **Button Scan Mode** feature.

No	BSSID	SSID	CH	RSSI	Type
1	02:00:20:10:78:88	gt-if	10	1	STA

Station Status

The **Station Status** fields displays the device wireless network connection SSID, operating mode, and encryption settings. You can use these information when you connect to an available wireless connection in the Site Survey table.

Site Survey

The **Site Survey** table lists the available wireless networks within the device range. The table displays the following wireless network information.

BSSID. The Basic Service Set Identifier (BSSID) is the IEEE MAC address of the wireless network.

SSID. SSID refers to the service set identifier of the wireless network.

CH. The direct sequence channel used by the wireless network.

RSSI. Received Signal Strength Indicator (RSSI) is a measurement of connection strength in dBm.

Type. Tells whether a wireless network is in access point (AP) or station (STA) mode.

To scan available wireless network(s) in your location:

1. Click the **Survey** button on the bottom of the page. A **Site Scanning** window appears.
2. The utility displays the available wireless network(s) in the **Site Survey** table.



To connect to an available wireless network with known SSID and disabled encryption:

1. From the Site Survey table, select the wireless network you intend to join.



Take note of the icon preceding the wireless network for easy identification. Refer to page 3-8 for details on wireless network icons.

2. Click to select the number of the wireless network you intend to join, then click the **Join** button.



A message appears in the browser indicating that you have successfully joined the wireless network.



To connect to an available wireless network with a hidden SSID and disabled encryption:

1. From the Site Survey table, select the wireless network (with a hidden SSID and disabled encryption) you intend to join.
2. Click  to select the number of the wireless network you intend to join, then click the **Join** button.



3. Click **OK** when this window appears.



Inquire the wireless network SSID with the network administrator.



4. Enter the SSID of the wireless network in the SSID field, then click **Apply**.

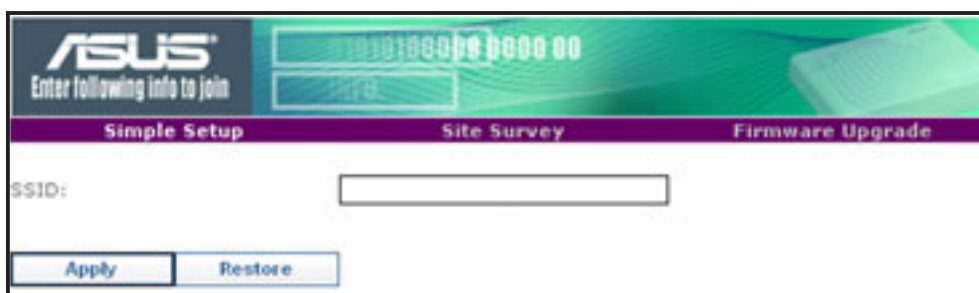

A message appears in the browser indicating that you have successfully joined the wireless network.



To connect to an available wireless network with a hidden SSID and enabled encryption:

1. From the Site Survey table, select the wireless network (with a hidden SSID and enabled encryption) you intend to join.
2. Click  to select the number of the wireless network you intend to join, then click the **Join** button.



3. Click **OK** when this window appears.



Inquire the wireless network SSID and encryption settings with the network administrator.



4. Enter the **SSID** of the wireless network, then select the **Authentication Method** and **Encryption**. When done, enter the encryption keys in the key fields, then click **Apply**.

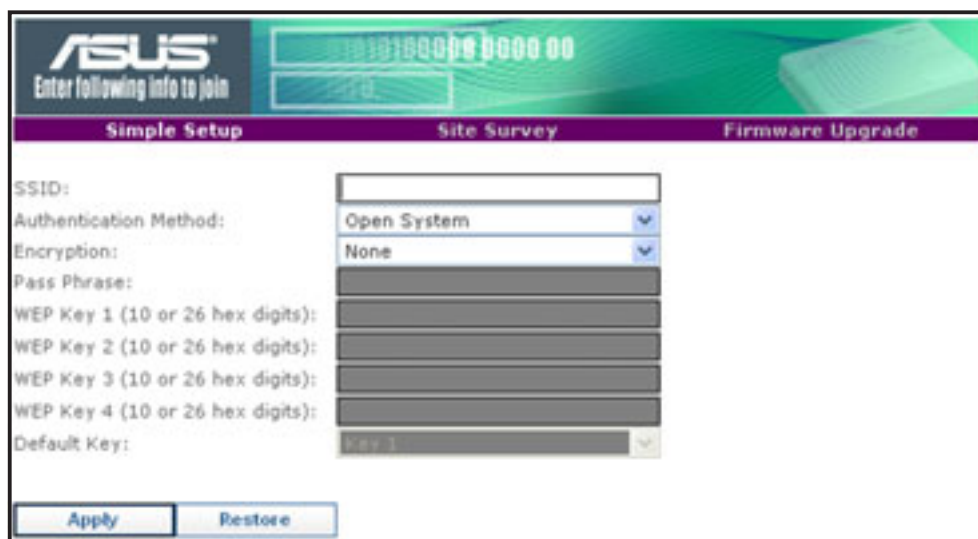

A message appears in the browser indicating that you have successfully joined the wireless network.

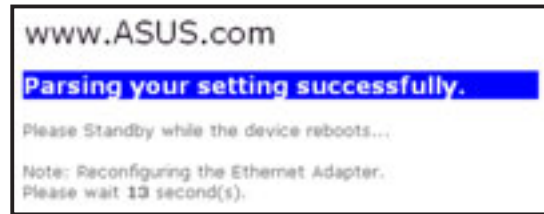

To connect to an available wireless network with a known SSID and enabled encryption:

1. From the Site Survey table, select the wireless network (with a known SSID and enabled encryption) you intend to join.
2. Click  to select the number of the wireless network you intend to join, then click the **Join** button.

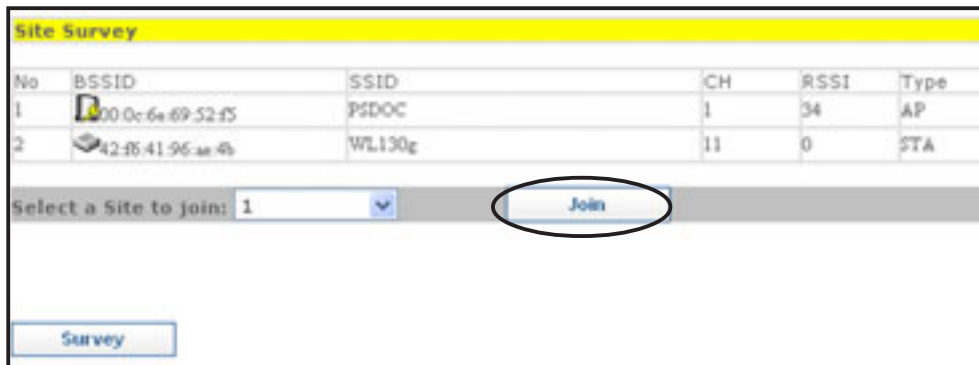

3. Click **OK** when this window appears.



Inquire the wireless network encryption settings with the network administrator.



4. Select the **Authentication Method** and **Encryption** of the wireless network you intend to join, then enter the encryption keys in the key fields. Click **Apply** when finished.

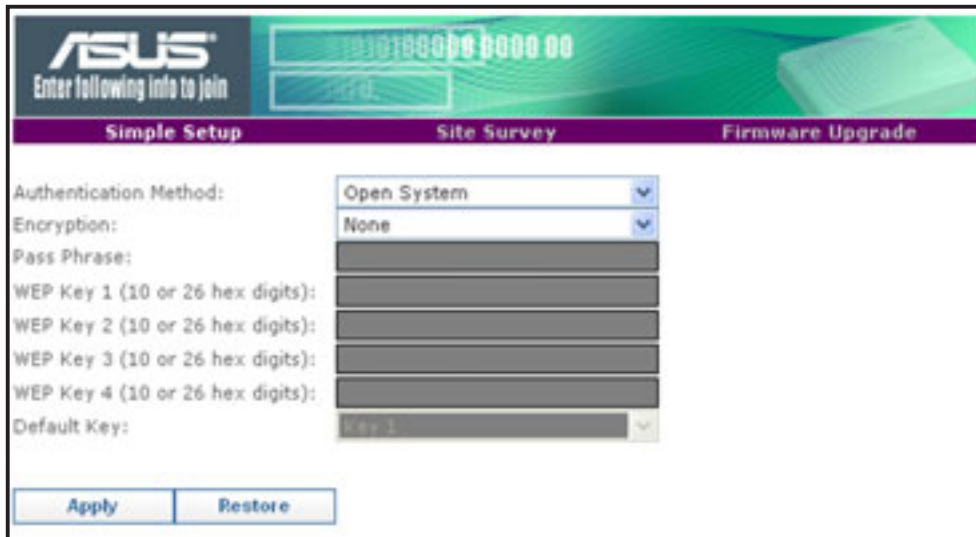

The image shows the ASUS wireless setup interface. At the top, there is a header with the ASUS logo and the text "Enter following info to join". Below this, there are three tabs: "Simple Setup", "Site Survey", and "Firmware Upgrade". The "Simple Setup" tab is selected. The main area contains the following fields:

- Authentication Method: Open System (dropdown menu)
- Encryption: None (dropdown menu)
- Pass Phrase: (text input field)
- WEP Key 1 (10 or 26 hex digits): (text input field)
- WEP Key 2 (10 or 26 hex digits): (text input field)
- WEP Key 3 (10 or 26 hex digits): (text input field)
- WEP Key 4 (10 or 26 hex digits): (text input field)
- Default Key: Key 1 (dropdown menu)

At the bottom, there are two buttons: "Apply" and "Restore".

A message appears in the browser indicating that you have successfully joined the wireless network.



Profile Table

The **Profile Table** allows you to view or delete saved wireless networks. The table displays the saved wireless network SSID, channel, security settings, and network type. Click the Profile Table link to view the Profile Table.



Save to Profile: Profile Table

Site Survey

No	BSSID	SSID	CH	RSSI	Type
1	02:4D:20:10:78:88	gt-rt	10	1	STA

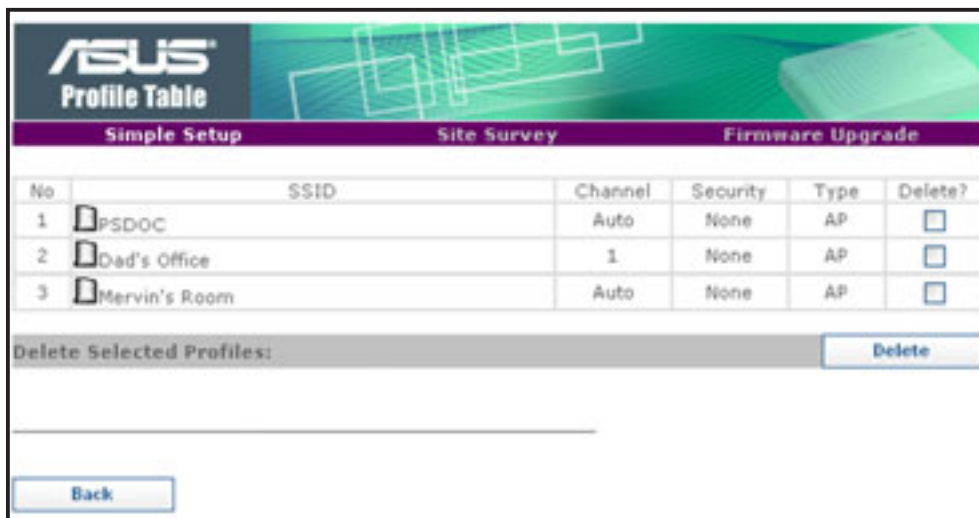

Select a Site to join: 1

Saved wireless networks are preceded by an icon for easy identification. Refer to page 3-8 for wireless network icon indications.



ASUS Profile Table

Simple Setup **Site Survey** Firmware Upgrade

No	SSID	Channel	Security	Type	Delete?
1	 PSDOC	Auto	None	AP	<input type="checkbox"/>
2	 Dad's Office	1	None	AP	<input type="checkbox"/>
3	 Mervin's Room	Auto	None	AP	<input type="checkbox"/>

Delete Selected Profiles:

To save a wireless network in the Profile Table:

1. From the **Site Survey** page, select the wireless network you intend to join.
2. Click to select the number of the selected wireless network, then click the **Join** button.
3. When the ASUS Pocket Wireless AP is associated with the wireless network, click the **Save** button.



4. The Profile Table appears with the saved wireless network. Click **Back** to return to the previous page.

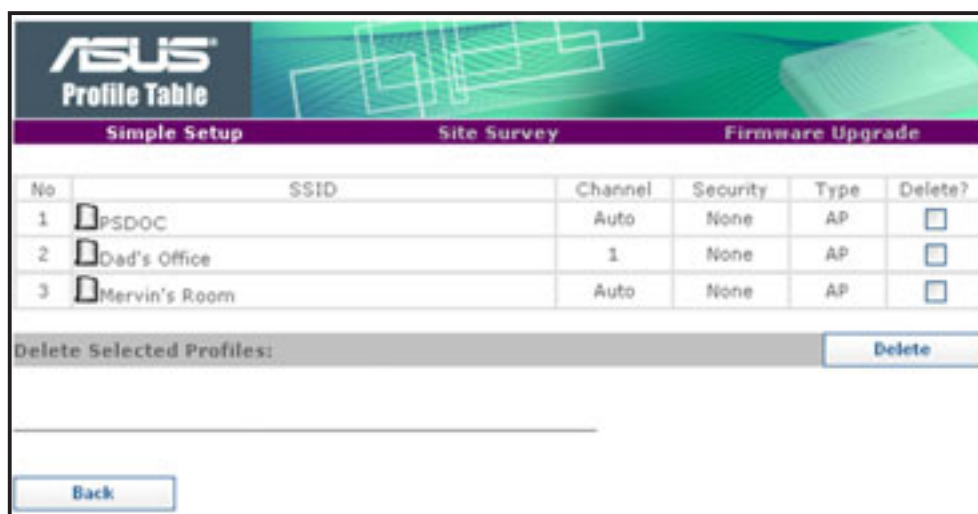

The saved wireless networks in the Profile Table corresponds to the number of profiles available for the Button Scan Mode feature.

For example, if you saved three wireless networks in the Profile Table,



ASUS Profile Table						
Simple Setup		Site Survey		Firmware Upgrade		
No	SSID	Channel	Security	Type	Delete?	
1	DPSDOC	Auto	None	AP	<input type="checkbox"/>	
2	Dad's Office	1	None	AP	<input type="checkbox"/>	
3	Mervin's Room	Auto	None	AP	<input type="checkbox"/>	

then three profiles are available for button scanning

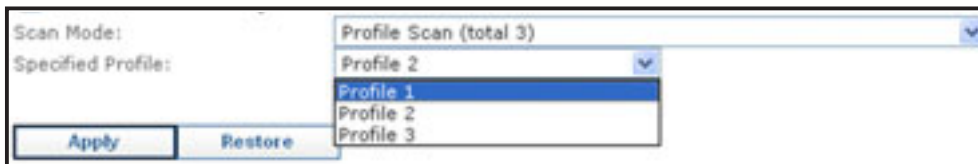

Scan Mode: Profile Scan (total 3)
Specified Profile: Profile 2
Apply Restore

- Profile 1
- Profile 2
- Profile 3



- The profile number represents the sequence of the saved wireless networks in the profile table.
- Refer to page 3-24 to 3-25 for details on the Button Scan Mode feature.

To delete a wireless network from the Profile Table:

1. Open the Profile Table by clicking the **Profile Table** link.
2. Select the wireless network you intend to delete, then check the **Delete?** box opposite it.

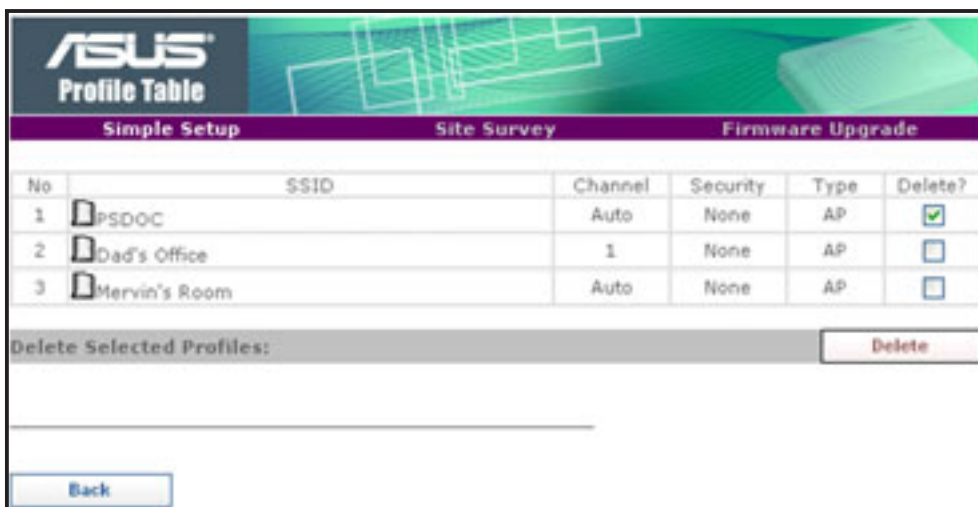

ASUS Profile Table						
Simple Setup		Site Survey		Firmware Upgrade		
No	SSID	Channel	Security	Type	Delete?	
1	DPSDOC	Auto	None	AP	<input checked="" type="checkbox"/>	
2	Dad's Office	1	None	AP	<input type="checkbox"/>	
3	Mervin's Room	Auto	None	AP	<input type="checkbox"/>	

Delete Selected Profiles:

3. Click the **Delete** button. The browser displays the Profile Table after the wireless network is deleted.
4. Click the **Back** button to return to the previous window.

Firmware Upgrade page

Refer to page 3-19 for details.

Restoring the default values

The following are the default values of the ASUS Pocket Wireless AP (Ethernet adapter mode). You may restore these values by pressing the reset button for more than five seconds.

Parameter	Default value
<i>Wireless Interface</i>	
SSID	ANY
Operating Mode	Infrastructure Mode
Channel	Auto
Station Mode	802.11b/g
Transmission Rate	Automatic
Preamble	Long
Authentication Method	Open System
Encryption	None
MAC Cloning	Disabled
<i>Button Scan Mode</i>	
Enable Buttong Scanning	Enabled
Scan Mode	Find the connection with the strongest link quality
Specified Profile	No Saved profile

3.4 Firmware Restoration

The **Firmware Restoration** utility is a rescue tool for an ASUS Pocket Wireless AP that failed during a previous firmware upload. This utility is available in the support CD that came with the ASUS Pocket Wireless AP package.

A failed firmware upgrade causes the ASUS Pocket Wireless AP to enter a failure mode. Use the Firmware Restoration utility to find and upload a new firmware for the ASUS Pocket Wireless AP.

To restore the firmware:

1. Visit the ASUS website to download the latest firmware for the device.
2. Launch the Firmware Restoration utility from the Windows® desktop by clicking **Start > All Programs > ASUS Utility > Wireless AP > Firmware Restoration**.
3. The **Firmware Restoration** window appears.

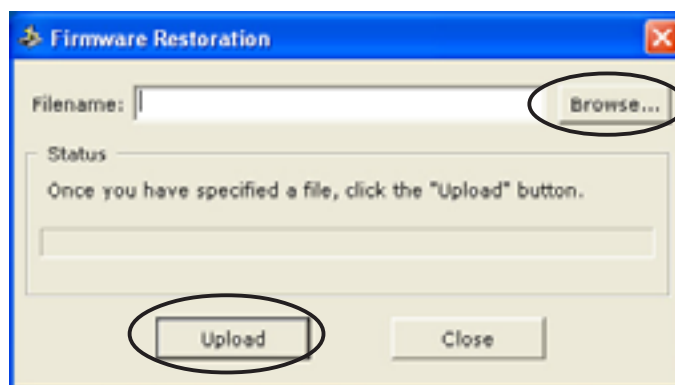

4. Click the **Browse** button to locate the firmware file.
5. After selecting the firmware file, click the **Upload** button to begin the firmware restoration.

The restoration process takes about 3 to 4 minutes to finish. During restoration, the Power, and Wireless LEDs remain lit, while the Ethernet LED flashes slowly.



If you have problems uploading a firmware while using a network hub, try connecting your computer directly to the LAN port.

Chapter 4

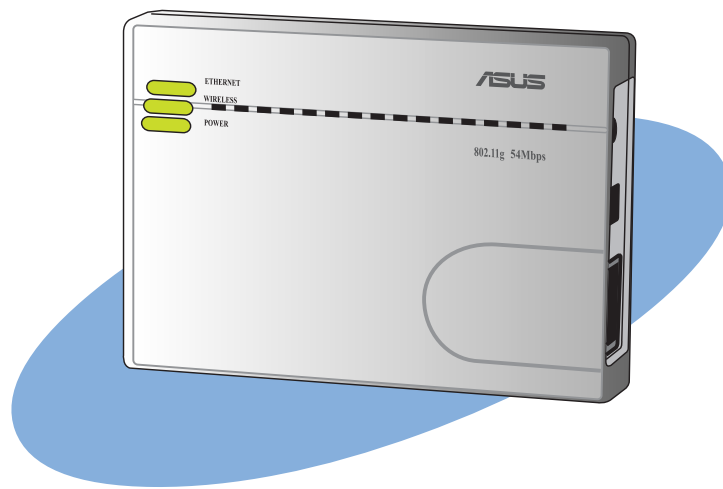

This chapter provides instructions on how to use the ASUS Pocket Wireless AP on various network setups.

Using the device

4.1 Using the device in a local network

You can use the WL-330g to connect a wireless LAN-enabled computer to a local network with or without a DHCP server.

To connect a wireless LAN-enabled computer to a local network:

1. Switch the WL-330g to AP mode. (Default SSID: AP_XXXXXX), then turn on the device.
2. Connect one end of the supplied RJ-45 cable to the Ethernet port of the device and the other end to the Ethernet port of the local network.
3. Use the wireless LAN adapter software in the wireless LAN-enabled computer to perform a **Site Survey**. Make sure the computer's wireless LAN adapter is set to **Infrastructure mode**.
4. Establish connection with the WL-330g.
5. Set the IP configuration of the computer to establish connection to the local network. Verify your connection.



Use the Wireless Setting Utility to change the WL-330g SSID or encryption settings.

4.2 Replacing the computer Ethernet cables

You can use the WL-330g to replace your wireless LAN-enabled computer cable connection to an ADSL or cable modem.

To do this:

1. Switch the WL-330g to AP mode. (Default SSID: AP_XXXXXX), then turn on the device.
2. Connect one end of the supplied RJ-45 cable to the Ethernet port of the device and the other end to the Ethernet port of the ADSL or cable modem.
3. Use the wireless LAN adapter software in the wireless LAN-enabled computer to perform a **Site Survey**. Make sure the computer's wireless LAN adapter is set to **Infrastructure mode**.
4. Establish connection with the WL-330g.
5. Set the IP configuration of the computer to establish connection to the local network. Verify your connection.

4.3 Replacing the cable connections of other devices

You can also use the WL-330g to replace your Xbox, PlayStation® 2, or set-top box network cable connection.

To do this:

1. Switch the WL-330g to Ethernet adapter mode using the mode switch. (Default SSID: ANY)
2. Place the WL-330g nearest the AP you wish to connect, then turn on the device.
3. Connect one end of the supplied RJ-45 cable to the Ethernet port of the device and the other end to the Xbox, PlayStation® 2, or set-top box Ethernet port.
4. Set the IP address of the Xbox, PlayStation® 2, or set-top box to establish connection to the local network. Verify your connection.



Make sure the WL-330g MAC cloning feature is enabled when using the device in this setup. Use the Wireless Setting Utility to enable MAC cloning. See page 3-24 for details on MAC cloning.

4.4 Sharing Internet connection with other computers

Refer to the typical network configuration below and a table on the next page for information on Internet connection sharing with other computers in your office or home network.



Use the mode switch to set the WL-330g to AP mode before sharing an Internet connection with other computers in your network.

Table 4-1: Internet connection sharing matrix

If your Internet connection is	Then set the IP of other computer(s)	Number of allowed Internet connections
xDSL ¹ with dynamic IP (PPPoE ² account)	ISP automatically assigns the IP (using PPPoE dial-up)	Depends on the Internet Service Provider (ISP)
xDSL with static IP	to the provided static IP	Depends on the Internet Service Provider (ISP)
xDSL/Cable with a router and enable DHCP ³ server	The DHCP server automatically assigns the IP	Depends on the DHCP server, usually about 253

¹xDSL – ADSL (**A**symmetric **D**igital **S**ubscriber **L**ine) or DSL (**D**igital **S**ubscriber **L**ine)

²PPPoE – **P**oint-**t**o-**P**oint over **E**thernet

³DHCP – **D**ynamic **H**ost **C**onfiguration **P**rotocol

Appendix

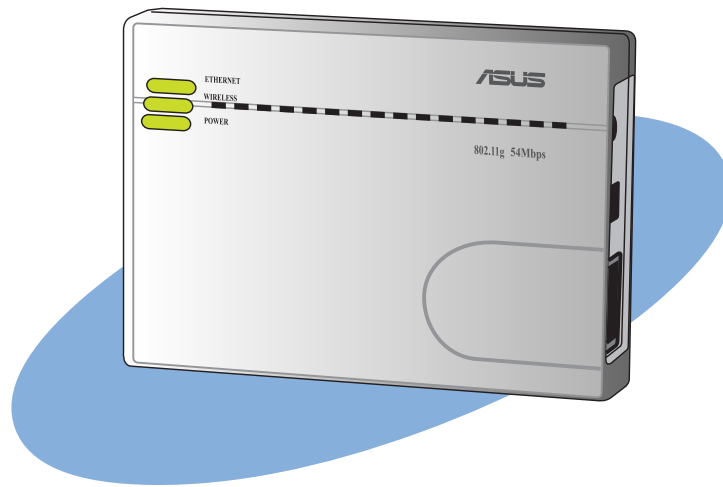

The Appendix features a troubleshooting guide for solving common problems you may encounter when using the ASUS Pocket Wireless AP.

Troubleshooting



This troubleshooting guide provides solutions to some common problems that you may encounter while installing and/or using ASUS Pocket Wireless AP. These problems require simple troubleshooting that you can perform by yourself. Contact the ASUS Technical Support if you encounter problems not mentioned in this section.

Problem	Action
The ASUS Pocket Wireless AP does not power up.	<ul style="list-style-type: none">• Use a test meter to measure the voltage output of the power source through the power plug.• Check if the power plug is properly connected to the device.
Other devices cannot communicate with the ASUS Pocket Wireless AP through a wired network connection.	<ul style="list-style-type: none">• Verify your network configuration to ensure that there is no IP address duplication. Turn off the device in question, then ping the assigned IP address of the device. Make sure no other device responds to that address.• Check if the cables have the proper pin outs and connectors. You may also use another LAN cable.• Make sure the hub, switch, or computer connected to the ASUS Pocket Wireless AP supports 10Mbps or 100Mbps speed. Do this by check the ASUS Pocket Wireless AP and the Hub LEDs. When you connect the ASUS Pocket Wireless AP to a 10/100 Mbps hub, both the Hub LED and the ASUS Pocket Wireless AP Ethernet LEDs should light up.

Problem	Action
<p>My ASUS WLAN card can not associate with the ASUS Pocket Wireless AP.</p>	<p>Observe the hub LED if you are not sure what speed the hub supports.</p> <ul style="list-style-type: none"> • Make sure your WLAN card has the same specifications as the ASUS Pocket Wireless AP (IEEE 802.11b/g). • Minimize the distance between the devices. The ASUS WLAN card may be out of range of the ASUS Pocket Wireless AP. • Check if the ASUS Pocket Wireless AP and the ASUS WLAN card have the same SSID. • When encryption is enabled, check if the ASUS Pocket Wireless AP and the ASUS WLAN card have the same encryption settings. • Check if the Wireless LED of the ASUS Pocket Wireless AP is on. • When the Access Control table is enabled, check if the MAC address of the ASUS WLAN card is included in the Access Control table. • Check if the ASUS Pocket Wireless AP is in "Access Point" mode.

Problem	Action
<p>The throughput seems slow.</p>	<p>Avoid placing the device behind a metal object. Clear obstacles between the AP and the device. Try moving the client closer to the ASUS Pocket Wireless AP and check if the throughput increases. Consider adding a second ASUS Pocket Wireless AP to implement roaming.</p>
<p>I can not access the ASUS Pocket Wireless AP web configuration page.</p>	<p>To access the ASUS Pocket Wireless AP web configuration page, your computer must have the same subnet as that of the ASUS Pocket Wireless AP.</p> <p>Adjust your network if your computer's subnet does not match that of the ASUS Pocket Wireless AP.</p> <p>The default IP address of the ASUS Pocket Wireless AP is "192.168.1.1". In special cases, when the ASUS Pocket Wireless AP in Ethernet adapter mode joins an AP network with the same IP address, reset the ASUS Pocket Wireless AP to access the Web Configuration utility again.</p>
<p>Where can I get a firmware file to upgrade the ASUS Pocket Wireless AP?</p>	<p>You may download the latest firmware file from the ASUS website (www.asus.com).</p> <p>Use the Firmware Upgrade page in the Web Configuration utility to update the ASUS Pocket Wireless AP firmware.</p>

Problem	Action
<p>The ASUS Pocket Wireless AP Power LED continuously blinks for more than a minute.</p>	<p>Turn off the ASUS Pocket Wireless AP. Turn the device again and observe if the Power LED stops blinking.</p> <p>If the blinking continues, you need to restore the ASUS Pocket Wireless AP firmware. Use the Firmware Restoration utility to restore or update the ASUS Pocket Wireless AP firmware.</p>
<p>A wireless client wants to connect to the ASUS Pocket Wireless AP but can not get the correct IP from the DHCP server. (The ASUS Pocket Wireless AP has an enabled DHCP.)</p>	<p>Make sure the DHCP server is working properly. Some DHCP servers can only assign one IP address at a time. In this case, assign a fixed IP address to your ASUS Pocket Wireless AP.</p>

Lined area for writing or drawing.

Free Manuals Download Website

<http://myh66.com>

<http://usermanuals.us>

<http://www.somanuals.com>

<http://www.4manuals.cc>

<http://www.manual-lib.com>

<http://www.404manual.com>

<http://www.luxmanual.com>

<http://aubethermostatmanual.com>

Golf course search by state

<http://golfingnear.com>

Email search by domain

<http://emailbydomain.com>

Auto manuals search

<http://auto.somanuals.com>

TV manuals search

<http://tv.somanuals.com>