

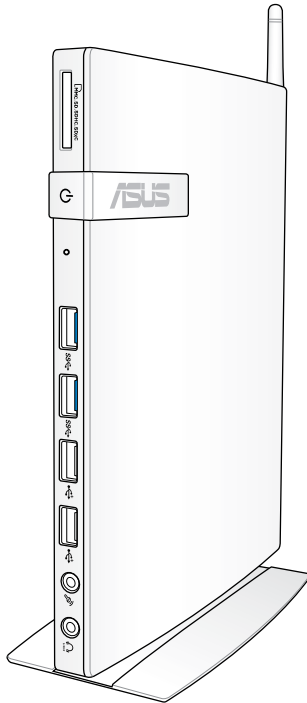

EB1035

User Manual



E7723**First Edition / September 2012****COPYRIGHT INFORMATION**

No part of this manual, including the products and software described in it, may be reproduced, transmitted, transcribed, stored in a retrieval system, or translated into any language in any form or by any means, except documentation kept by the purchaser for backup purposes, without the express written permission of ASUSTeK COMPUTER INC. ("ASUS").

ASUS PROVIDES THIS MANUAL "AS IS" WITHOUT WARRANTY OF ANY KIND, EITHER EXPRESS OR IMPLIED, INCLUDING BUT NOT LIMITED TO THE IMPLIED WARRANTIES OR CONDITIONS OF MERCHANTABILITY OR FITNESS FOR A PARTICULAR PURPOSE. IN NO EVENT SHALL ASUS, ITS DIRECTORS, OFFICERS, EMPLOYEES OR AGENTS BE LIABLE FOR ANY INDIRECT, SPECIAL, INCIDENTAL, OR CONSEQUENTIAL DAMAGES (INCLUDING DAMAGES FOR LOSS OF PROFITS, LOSS OF BUSINESS, LOSS OF USE OR DATA, INTERRUPTION OF BUSINESS AND THE LIKE), EVEN IF ASUS HAS BEEN ADVISED OF THE POSSIBILITY OF SUCH DAMAGES ARISING FROM ANY DEFECT OR ERROR IN THIS MANUAL OR PRODUCT.

Products and corporate names appearing in this manual may or may not be registered trademarks or copyrights of their respective companies, and are used only for identification or explanation and to the owners' benefit, without intent to infringe.

SPECIFICATIONS AND INFORMATION CONTAINED IN THIS MANUAL ARE FURNISHED FOR INFORMATIONAL USE ONLY, AND ARE SUBJECT TO CHANGE AT ANY TIME WITHOUT NOTICE, AND SHOULD NOT BE CONSTRUED AS A COMMITMENT BY ASUS. ASUS ASSUMES NO RESPONSIBILITY OR LIABILITY FOR ANY ERRORS OR INACCURACIES THAT MAY APPEAR IN THIS MANUAL, INCLUDING THE PRODUCTS AND SOFTWARE DESCRIBED IN IT.

Copyright © 2012 ASUSTeK COMPUTER INC. All Rights Reserved.

LIMITATION OF LIABILITY

Circumstances may arise where because of a default on ASUS' part or other liability, you are entitled to recover damages from ASUS. In each such instance, regardless of the basis on which you are entitled to claim damages from ASUS, ASUS is liable for no more than damages for bodily injury (including death) and damage to real property and tangible personal property; or any other actual and direct damages resulted from omission or failure of performing legal duties under this Warranty Statement, up to the listed contract price of each product.

ASUS will only be responsible for or indemnify you for loss, damages or claims based in contract, tort or infringement under this Warranty Statement.

This limit also applies to ASUS' suppliers and its reseller. It is the maximum for which ASUS, its suppliers, and your reseller are collectively responsible.

UNDER NO CIRCUMSTANCES IS ASUS LIABLE FOR ANY OF THE FOLLOWING: (1) THIRD-PARTY CLAIMS AGAINST YOU FOR DAMAGES; (2) LOSS OF, OR DAMAGE TO, YOUR RECORDS OR DATA; OR (3) SPECIAL, INCIDENTAL, OR INDIRECT DAMAGES OR FOR ANY ECONOMIC CONSEQUENTIAL DAMAGES (INCLUDING LOST PROFITS OR SAVINGS), EVEN IF ASUS, ITS SUPPLIERS OR YOUR RESELLER IS INFORMED OF THEIR POSSIBILITY.

SERVICE AND SUPPORT

Visit our multi-language web site at <http://support.asus.com>

Contents

About this manual	5
Conventions used in this manual	6
Typography	6
Safety information	7
Setting up your system.....	7
Care during use	7
Package contents	9

Chapter 1: Hardware Setup

Getting to know your PC	10
Front view	10
Rear view	12

Chapter 2: Using your PC

Positioning your PC	14
Mounting your PC on the stand	14
Installing your PC to a monitor	15
Using your PC	18
Connecting to an external display	18
Connecting to a USB device	18
Connecting the wireless antenna	19
Turning your PC on	20
Configuring the audio output via an HDMI device	21

Chapter 3: Working with Windows® 8

System requirements.....	23
Starting for the first time	24
Windows® 8 lock screen.....	24
Windows® UI.....	25
Start Screen.....	25
Windows® apps.....	26
Working with Windows® apps.....	29
Launching apps.....	29
Customizing apps from the Start screen.....	29

Contents

Closing apps	30
Accessing the Apps screen.....	30
Charm bar.....	31
Snap feature	33
Other keyboard shortcuts.....	34
Turning your PC off.....	36
Putting your PC to sleep	36
Entering the BIOS Setup	36
Quickly enter the BIOS.....	37
Chapter 4: Connecting to the Internet	
Connecting on Windows® 7	38
Wireless connection	38
Wired connection	39
Connecting on Windows® 8.....	45
Wi-Fi connection.....	45
Wired connection	47
Chapter 5: Recovering your system	48
Recovery options on Windows®7.....	48
Using the Recovery Partition	48
Recovery options on Windows®8.....	50
Resetting your PC	50
Recovering from a system image file	51
Removing everything and reinstalling Windows.....	53
Appendices	
Notices	54
ASUS contact information	61

About this manual

This manual provides information about the hardware and software features of your PC , organized through the following chapters:

Chapter 1: Hardware Setup

This chapter details the hardware components of your PC .

Chapter 2: Using your PC

This chapter provides you with information on using your PC .

Chapter 3: Working with Windows® 8

This chapter provides an overview of using Windows® 8 in your PC .

Chapter 4: Connecting to the Internet

This chapter provides information on connecting your PC to a wired or Wi-Fi network.

Chapter 5: Recovering your system

This chapter provides recovery options for your PC .

Appendices

This section includes notices and safety statements for your PC .

NOTE:

The user manual is located in the following folder in your PC:

- **For 64-bit Windows® 8 OS:** Program Files(X86)/ASUS/eManual
-

Conventions used in this manual

To highlight key information in this manual, some text are presented as follows:

IMPORTANT! This message contains vital information that must be followed to complete a task.

NOTE: This message contains additional information and tips that can help complete tasks.

WARNING! This message contains important information that must be followed to keep you safe while performing certain tasks and prevent damage to your PC's data and components.

Typography

Bold text

Indicates a menu or an item to select.

Italic

This indicates sections that you can refer to in this manual.

Safety information

Your EeeBox PC is designed and tested to meet the latest standards of safety for information technology equipment. However, to ensure your safety, it is important that you read the following safety instructions.

Setting up your system

- Read and follow all instructions in the documentation before you operate your system.
- Do not use this product near water or a heated source such as a radiator.
- Set up the system on a stable surface with the provided stand. Never use the system alone without the stand.
- Openings on the chassis are for ventilation. Do not block or cover these openings. Make sure you leave plenty of space around the system for ventilation. Never insert objects of any kind into the ventilation openings.
- Use this product in environments with ambient temperatures between 0°C and 35°C.
- If you use an extension cord, make sure that the total ampere rating of the devices plugged into the extension cord does not exceed its ampere rating.

Care during use

- Do not walk on the power cord or allow anything to rest on it.
- Do not spill water or any other liquids on your system.
- When the system is turned off, a small amount of electrical current still flows. Always unplug all power, modem, and network cables from the power outlets before cleaning the system.
- If you encounter the following technical problems with the product, unplug the power cord and contact a qualified service technician or your retailer.
 - The power cord or plug is damaged.

- Liquid has been spilled into the system.
- The system does not function properly even if you follow the operating instructions.
- The system was dropped or the cabinet is damaged.
- The system performance changes.

Lithium-Ion Battery Warning

CAUTION: Danger of explosion if battery is incorrectly replaced. Replace only with the same or equivalent type recommended by the manufacturer. Dispose of used batteries according to the manufacturer's instructions.

LASER PRODUCT WARNING

CLASS 1 LASER PRODUCT







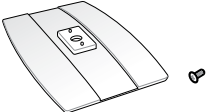
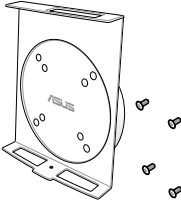

NO DISASSEMBLY

The warranty does not apply to the products that have been disassembled by users

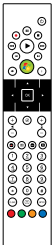
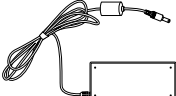

DO NOT throw the PC in municipal waste. This product has been designed to enable proper reuse of parts and recycling. This symbol of the crossed out wheeled bin indicates that the product (electrical, electronic equipment, and mercury-containing button cell battery) should not be placed in municipal waste. Check local technical support services for product recycling.

Package contents

		
<p>EB1035</p>	<p>Stand (optional)</p>	<p>VESA mount and Screw pack (optional)</p>
		
<p>Remote receiver (optional)</p>	<p>Antenna</p>	<p>Mini jack to S/PDIF adapter</p>
		
	<p>AC adapter</p>	<p>Power cord</p>
<p>Remote control (optional)</p>	 <p>Warranty card</p>	 <p>Quick Installation Guide (QIG)</p>

NOTES:

- Actual product specifications may vary with territories.
- If the device or its components fail or malfunction during normal and proper use within the warranty period, bring the warranty card to the ASUS Service Center for replacement of the defective components.

Chapter 1: Hardware Setup

Getting to know your PC

Front view

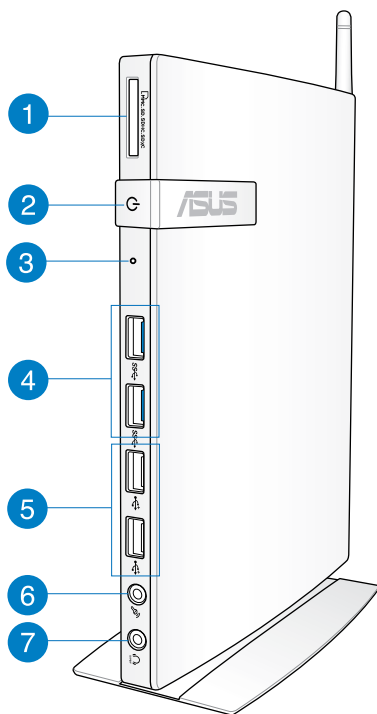





Memory card slot

The built-in memory card reader enables your PC to read and write data to and from MMC/SD/SDHC/SDXC cards.



Power switch

The power switch allows powering ON and OFF the system.

- 3** **BIOS Reset key**
Before booting up the system, insert a straightened paper clip into this hole to enter the BIOS.
- 4**  **USB 3.0 ports**
These USB (Universal Serial Bus) ports provide a transfer rate of up to 5Gbit/s and are backward compatible with USB2.0.
- 5**  **USB 2.0 ports**
The USB (Universal Serial Bus) 2.0 ports are compatible with USB 2.0/1.1 devices such as keyboards, mouse devices, cameras, and hard disk drives. USB allows many devices to run simultaneously on a single computer, with some peripheral acting as additional plug-in sites or hubs.
- 6**  **Microphone jack**
The microphone jack is designed to connect the microphone used for video conferencing, voice narrations, or simple audio recordings.
- 7**  **Headphone/Audio (S/PDIF) Out jack**
The stereo headphone jack (3.5mm) is used to connect the system's audio out signal to amplified speakers or headphones.



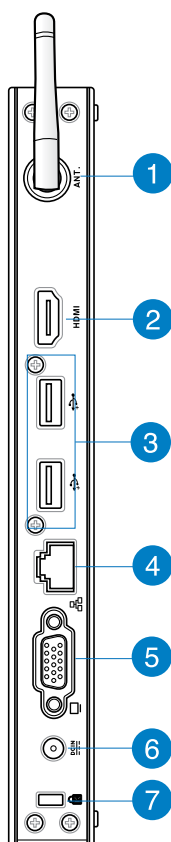

NOTE: For S/PDIF Out function, use the optional mini jack to S/PDIF adapter to connect to your amplifier.

Rear view



1 **Wireless antenna jack**

The jack is used to connect the supplied wireless antenna to enhance wireless signal reception.

- 2**  **HDMI port**
The HDMI (High Definition Multimedia Interface) port supports a Full-HD device such as an LCD TV or monitor to allow viewing on a larger external display.
- 3**  **USB 2.0 ports**
The USB (Universal Serial Bus) 2.0 ports are compatible with USB 2.0/1.1 devices such as keyboards, mouse devices, cameras, and hard disk drives. USB allows many devices to run simultaneously on a single computer, with some peripheral acting as additional plug-in sites or hubs.
- 4**  **LAN port**
The eight-pin RJ-45 LAN port supports a standard Ethernet cable for connection to a local network.
- 5**  **Display (Monitor) Output**
The 15-pin D-sub monitor port supports a standard VGA-compatible device such as a monitor or projector to allow viewing on a larger external display.
- 6**  **Power input (DC 19V)**
The supplied power adapter converts AC power to DC power for use with this jack. Power supplied through this jack supplies power to the PC. To prevent damage to the PC, always use the supplied power adapter.

WARNING! The power adapter may become warm to hot when in use. Do not cover the adapter and keep it away from your body.

- 7**  **Kensington® lock port**
The Kensington® lock port allows you to secure your PC using Kensington® compatible PC security products.

Chapter 2: Using your PC

Positioning your PC

Mounting your PC on the stand

To mount your PC on the stand:

1. Locate the mounting hole at the bottom of your PC.
2. Align the stand's mounting hole with the mounting hole on your PC, then secure it in place with the stand screw.

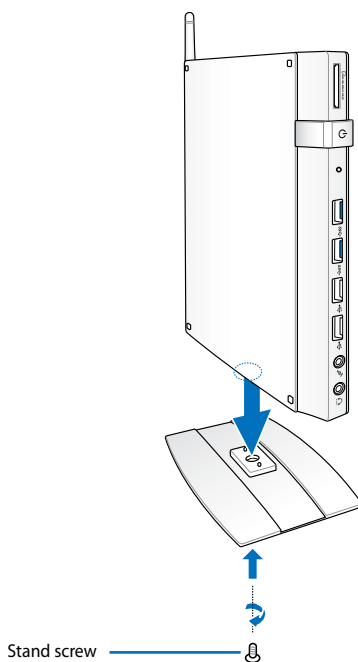

IMPORTANT! Ensure that your PC is mounted on its stand before placing it on a stable and flat surface.

Installing your PC to a monitor

To install your PC to a monitor:

1. Secure the VESA mount to your monitor with four screws bundled with your VESA mount kit.

NOTE: Your monitor must comply with VESA75 or VESA100 standard.

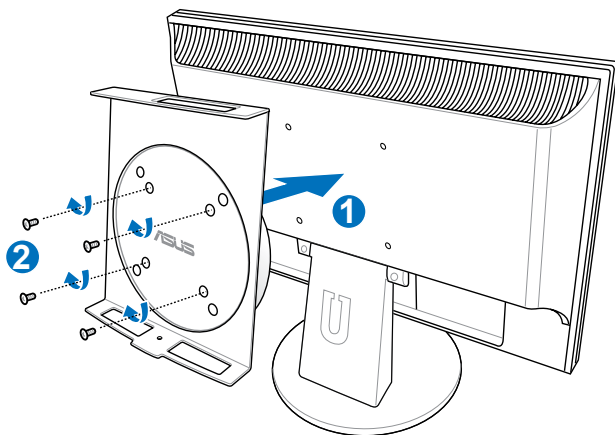

- Place your PC onto the VESA mount noting the correct alignment, and secure the PC to the VESA mount from below with the stand screw.

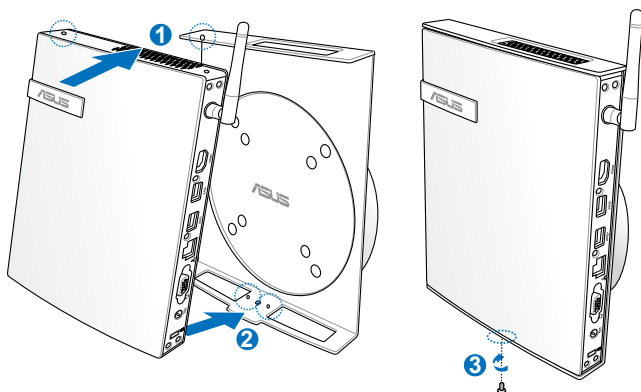

NOTE: Make sure that the ASUS trademark on the rotation wheel of the VESA mount is set to its customary position when putting in the PC so that the machine can rotate properly.

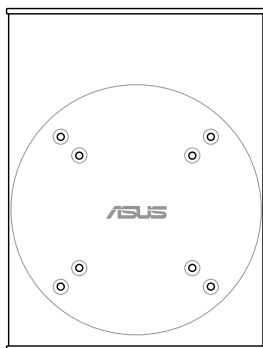

- The VESA mount is designed for you to rotate the PC so to use the front and rear I/O ports at convenient angles. To turn the PC secured in the VESA mount, press the lever switch at the bottom of the VESA mount to unlock the wheel. Then turn according to preference.

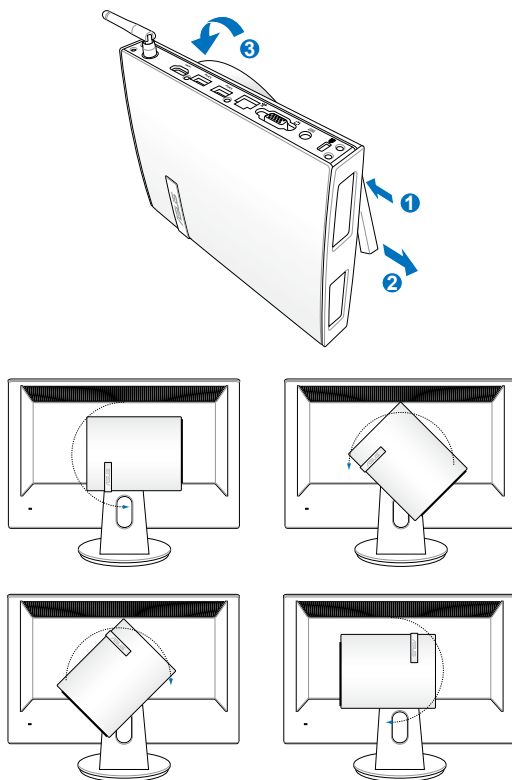

IMPORTANT!

- Set the rotation wheel upright when the system is in use.
 - Please take note of the cables connected to the PC while operating the rotation wheel. To prevent hazards from loosened cables, the wheel is designed to rotate no more than 90° clock/ counterclock-wise.
-

Using your PC

Connecting to an external display

Connect one end of an HDMI or a VGA cable to an external display, and the other end of the cable to your PC's HDMI or VGA port.

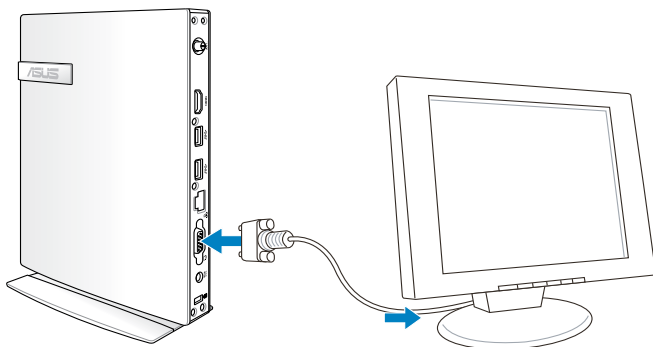

Connecting to a USB device

Connect USB devices like wired/wireless keyboards, mouse devices, and printers to the USB ports on your PC.

NOTE: The keyboard varies with country or region.

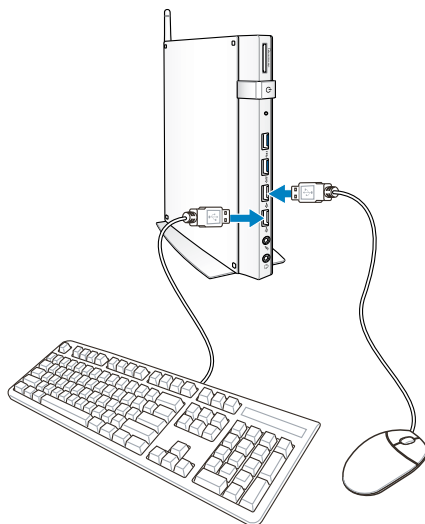

Connecting the wireless antenna

Connect the wireless antenna to your PC to enhance the wireless signal. Ensure that the wireless antenna is in an upright position (90° angle) to get the best wireless reception.

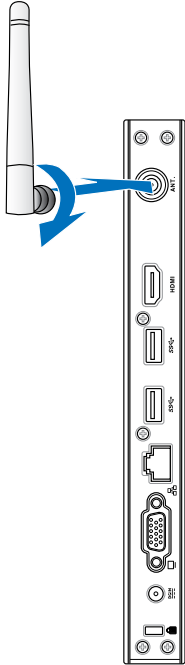

Turning your PC on

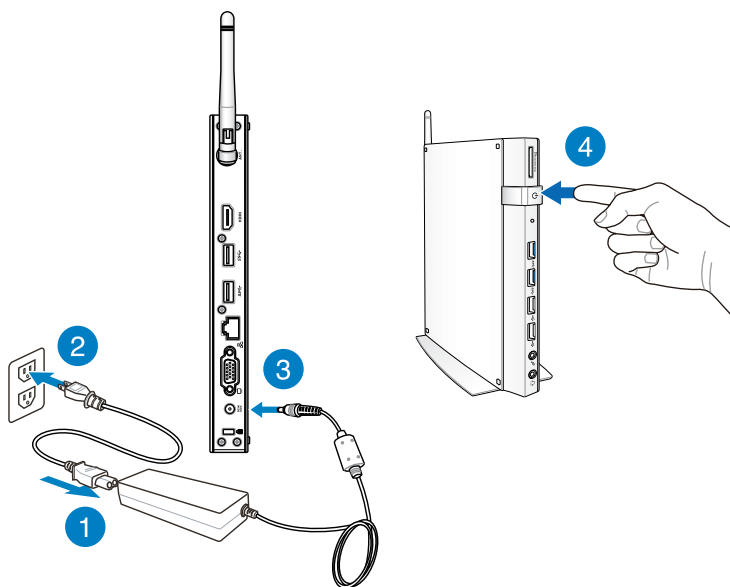

NOTES:

- When your PC is not in use, unplug the power adapter or switch off the power button to save on power consumption.
 - Adjust the power management settings in the Window® Control Panel. This is to ensure that your PC is set to a low power consumption mode and is fully operational at the same time.
-

Configuring the audio output via an HDMI device

If you want to use a high-definition TV as an audio output device, connect it to the Home Theater PC and follow the steps below to configure the audio settings.

To configure the audio output via an HDMI device:

1. Do any of the following based on your PC's operating system.

On Windows® 7

Right-click the **Volume Mixer** icon on the Windows® notification area and click **Playback devices**.



On Windows® 8

- a) From the Start screen, click **Desktop** to launch the Desktop Mode.

NOTE: For more details, refer to the section *Start screen* under *Using Windows® 8*.

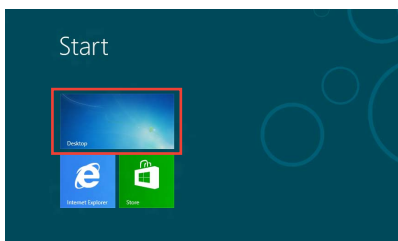

- b) Right-click the Volume Mixer icon on the Windows® taskbar and click **Playback devices**.



- From the Playback screen, select **Digital Audio (HDMI)**.
- Click **Configure** and the Speaker Setup window pops up.

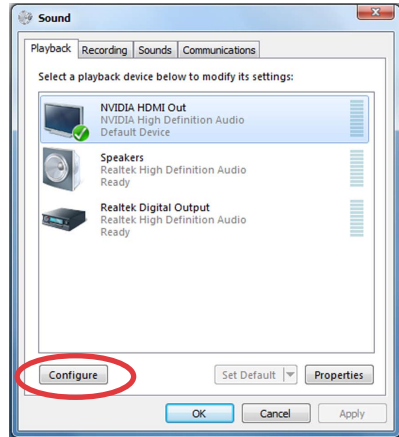

- Select **Stereo** and click **Next**.

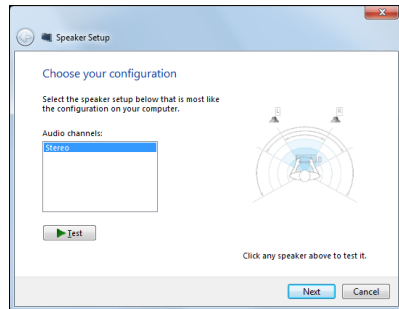

- Tick the **Front left and right** option, and click **Next**.
- Click **Finish** to exit the speaker setup.

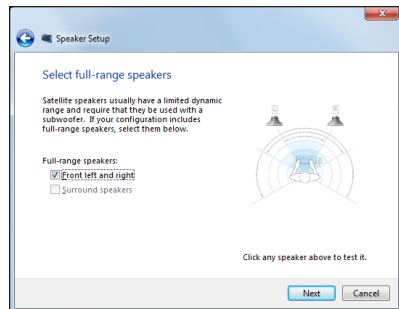

Chapter 3: Working with Windows® 8

NOTE: The operating system varies with country or region.

System requirements

To facilitate a smoother transition from your previous operating system, read the system requirements below before upgrading to Windows® 8:

Processor	1GHz or faster
RAM	1GB (32-bit) or 2 GB (64-bit)
Hard disk space	16 GB (32-bit) or 20 GB (64-bit)
Graphics card	Microsoft DirectX9 graphics device with WDDM driver
Screen resolution	1024 x 768 for Windows® apps
	1366 x 768 for Snap feature

NOTE: For updates on these system requirements, visit <http://www.windows.microsoft.com/en-us/windows-8/faq>

Starting for the first time

When you start your computer for the first time, a series of screens appear to guide you in configuring the basic settings of your Windows® 8 operating system.

To start for the first time:

1. Turn your computer on. Wait for a few minutes until the setup screen appears.
2. Carefully read the license terms. Tick **I accept the license terms for using Windows** and click **Accept**.
3. Follow the next onscreen instructions to configure the following basic items:
 - Personalize
 - Settings
4. Once you are done configuring the basic items, the Windows® 8 video tutorial appears. Watch this tutorial to learn more about Windows® 8 functionalities.
5. The Start screen appears after successfully signing in to your user account.

Windows® 8 lock screen

The Windows®8 lock screen may appear when your PC enters the Windows®8 operating system. To proceed, tap on the lock screen or press any key on your PC's keyboard.

Windows® UI

The Windows® User interface (UI) is the tile-based display used in Windows® 8. It includes the following features you can use while working on your PC.

Start Screen

The Start Screen appears after successfully signing in to your user account. It helps organize all the programs and applications you need in just one place.

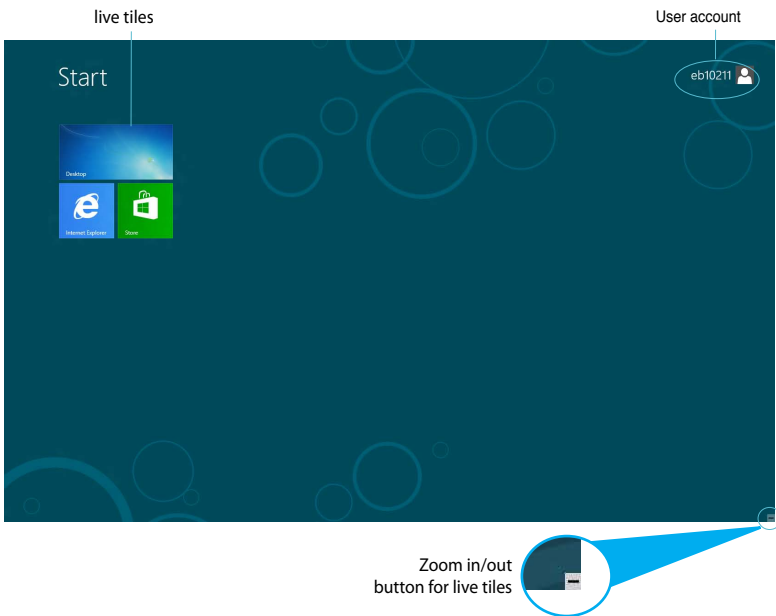

Windows® apps

These are apps pinned on the Start screen and displayed on tiled-format for easy access.

IMPORTANT! A screen resolution of 1024 x 768 pixels or higher is required to run Windows® apps.

NOTE: Some apps require signing in to your Microsoft account before they are fully launched.

Hotspots

Onscreen hotspots allow you to launch programs and access the settings of your PC. The functions in these hotspots can be activated using your mouse.

Hotspots on a running app

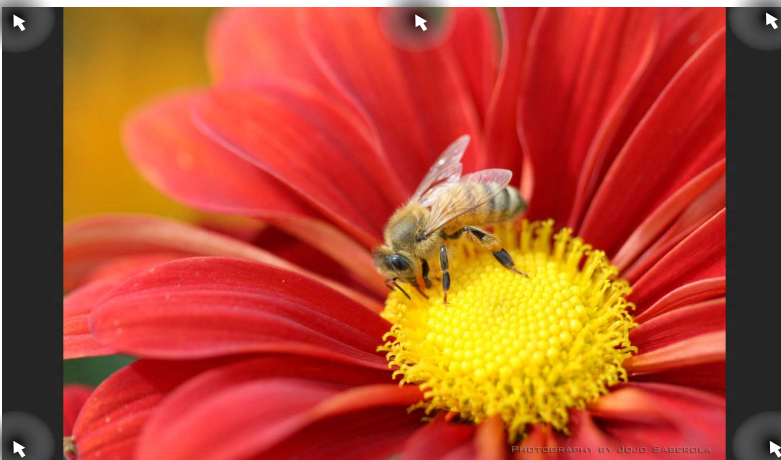

Hotspots on the Start screen





NOTE: Refer to the next page for the Hotspots' functions.

Hotspot	Action
upper left corner	<p>Hover your mouse pointer then tap on the recent app's thumbnail to revert back to that running app.</p> <hr/> <p>If you launched more than one app, slide down to show all running apps.</p>
lower left corner	<p>From a running app screen:</p> <p>Hover your mouse pointer then tap on the Start screen's thumbnail to go back to the Start screen.</p> <hr/> <p>NOTE: You can also press the Windows key  on your keyboard to go back to the Start screen.</p> <hr/> <p>From the Start screen:</p> <p>Hover your mouse pointer then tap on the running app's thumbnail to go back to that app.</p> <p>Hover your mouse pointer then click on the recent app's thumbnail to go back to that app.</p>
top	<p>Hover your mouse pointer until it changes to a hand icon. Drag then drop the app to a new location.</p> <hr/> <p>NOTE: This hotspot function only works on a running app or when you want to use the Snap feature. For more details, refer to <i>Snap feature</i> under <i>Working with Windows® apps</i>.</p>
upper and lower right corner	<p>Hover your mouse pointer to launch the Charm bar.</p>

Working with Windows® apps

Use your PC's keyboard or mouse to launch and customize your apps.

Launching apps

- Position your mouse pointer on an app then left-click once to launch it.
- Press  twice then use the arrow keys to browse through the apps. Press  to launch your selected app.

Customizing apps from the Start screen

You can move, resize, or unpin apps from the Start screen using the following steps.

Moving apps

To move an app, point and drag it to a new location.

Resizing apps

Right-click the app to activate its settings bar then tap



Unpinning apps

To unpin an app from the Start screen, right-click on the app to activate its settings bar then tap



Closing apps

From the running app's screen, press $\boxed{\text{alt}}$ + $\boxed{\text{F4}}$.

Accessing the Apps screen

Aside from the apps already pinned on your Start screen, you can also open other applications through the Apps screen.

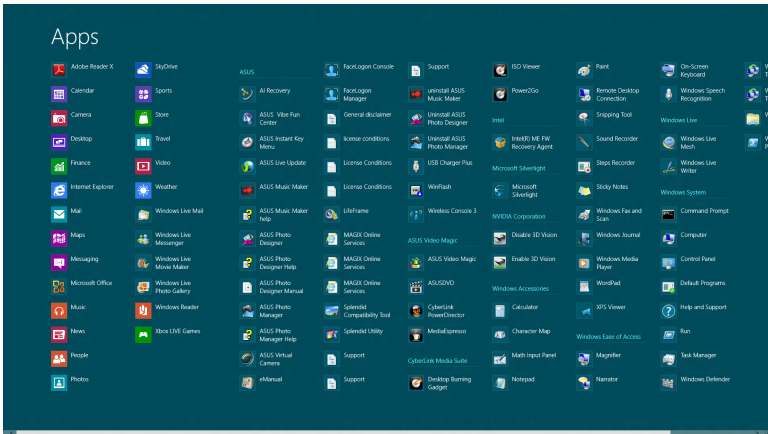

Horizontal scroll bar

Launching the Apps screen

Right-click on the Start screen or press $\boxed{\text{Windows Key}}$ + $\boxed{\text{Z}}$, and click the All Apps icon.

Pinning more apps on the Start screen

1. Position the mouse pointer over the app you want to pin on the Start screen.
2. Right-click on the app to activate its settings.
3. Click on the  icon.

Charm bar

The Charm bar is a toolbar that can be triggered on the right side of your screen. It consists of several tools that allow you to share applications and provide quick access for customizing the settings of your PC.



Charm Bar

Launching the Charm bar

NOTE: When called out, the Charm bar initially appears as a set of white icons. The image above shows how the Charm bar looks like once activated.

Use your PC's mouse or keyboard to launch the Charm bar:

- Move your mouse pointer on the upper or lower right corner of the screen.

- Press  + .

Inside the Charm bar



Search

This tool allows you to look for files, applications, or programs in your PC.



Share

This tool allows you to share applications via social networking sites or email.



Start

This tool reverts the display back to the Start screen. From the Start screen, you can also use this to revert back to a recently opened app.



Devices

This tool allows you to access and share files with the devices attached to your PC such as an external display or printer.



Settings

This tool allows you to access the PC settings of your PC.

Snap feature

The Snap feature displays two apps side-by-side, allowing you to work or switch between apps.

IMPORTANT! Ensure that your PC's screen resolution is set to 1366 x 768 pixels or higher before using the Snap feature.



Snap bar





Using Snap

Perform the following steps to activate Snap using your PC's mouse or keyboard.

Using your mouse

1. Launch the app you wish to snap.
2. Hover the mouse point on the top side of your screen.
3. Once the pointer changes to a hand icon, drag then drop the app to the left or right side of the display panel.
4. Launch another app.

Using your keyboard

1. Launch the app you wish to snap.
2. Press  + .
3. To switch between apps, press  + .

Other keyboard shortcuts

Using the keyboard, you can also use the following shortcuts to help you launch applications and navigate Windows®8.



Switches between the Start screen and the last running app

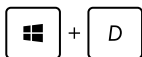

Launches the desktop

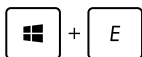

Launches the Computer window on Desktop mode

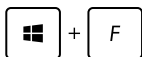



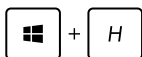



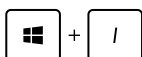















Opens the File search pane



Opens the Share pane



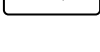

Opens the Settings pane

-  +  Activates the Lock screen
-  +  Minimizes the Internet Explorer window
-  +  Opens the Second screen pane
-  +  Opens the Apps search pane
-  +  Opens the Run window
-  +  Opens Ease of Access Center
-  +  Opens the Settings search pane
-  +  Opens a menu box of Windows tools
-  +  Launches the magnifier icon and zooms in your screen
-  +  Zooms out your screen
-  +  Opens the Narrator Settings
-  +  Enables the print screen function

Turning your PC off

You can shut down your PC in the following scenarios:

- Tap  from the Charm bar then tap  > **Shut down** to do a normal shutdown.
- From the log-in screen, tap  > **Shut down**.
- If your PC is unresponsive, press and hold the power button for at least four (4) seconds until your PC turns off.

Putting your PC to sleep

To put your PC on Sleep mode, press the Power button once.

Entering the BIOS Setup

BIOS (Basic Input and Output System) stores system hardware settings that are needed for system startup in the PC.

In normal circumstances, the default BIOS settings apply to most conditions to ensure optimal performance. Do not change the default BIOS settings except in the following circumstances:

- An error message appears on the screen during the system bootup and requests you to run the BIOS Setup.
- You have installed a new system component that requires further BIOS settings or update.

WARNING! Inappropriate BIOS settings may result to instability or boot failure. We strongly recommend that you change the BIOS settings only with the help of a trained service personnel.

Quickly enter the BIOS

Windows® 8 boot time is quite fast, so we developed the following three ways for you to quickly access the BIOS:

- Before booting up the system, insert a straightened paper clip into the BIOS Reset key.

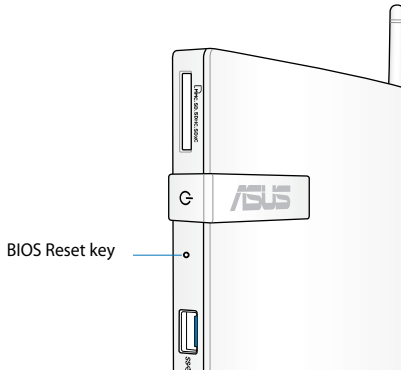

- Press the power button for at least four seconds to shut down your PC, then press the power button again to turn your PC back on, and press <F2> during POST.
- When your PC is off, disconnect the power cord from your PC's power connector. Reconnect the power cord and press the power button to turn on your PC. Press <F2> during POST.

NOTE: POST (Power-On Self Test) is a series of software controlled diagnostic tests that run when you turn on your PC.

Chapter 4: Connecting to the Internet

Access emails, surf the Internet, and share applications via social networking sites on or from your PC using wireless/Wi-Fi or wired connection.

Connecting on Windows® 7

Wireless connection

1. Click the wireless network icon  in the Windows® notification area.

WARNING! For security concerns, DO NOT connect to an unsecured network.

2. Select the wireless access point you want to connect to from the list and click **Connect** to build the connection.

NOTES: If you cannot find the desired access point, click the **Refresh** icon  on the upper right corner to refresh and search in the list again.



4. When connecting, you may have to enter a password.
5. After a connection has been established, the connection is shown on the list.
6. You can see the wireless network icon  in the Notification area.

Wired connection

1. Use a network (RJ-45) cable to connect your PC to a DSL/cable modem or a local area network (LAN).

DSL/Cable Modem

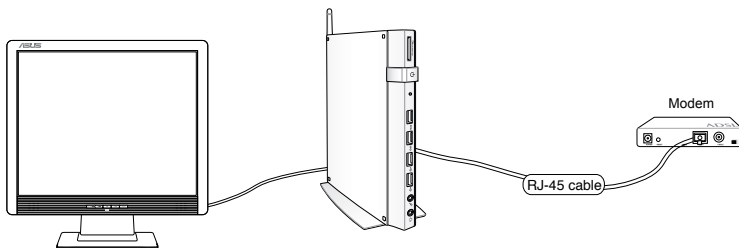

LAN

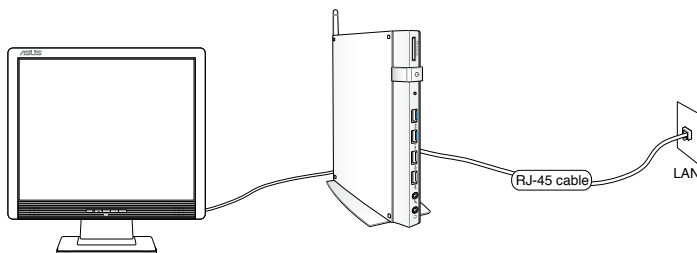

2. Configure a dynamic IP/PPPoE or static IP network connection.

NOTE: For more details, refer to the next sections.

Configuring a dynamic IP / PPPoE network connection

To configure a dynamic IP/PPPoE network connection:

1. Click the network icon  in the Windows® Notification area and select **Open Network and Sharing Center**.

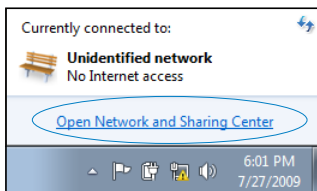

2. Click **Change adapter settings** in the left blue pane.

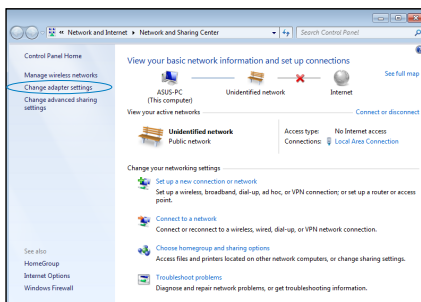

3. Right-click **Local Area Connection** and select **Properties**.

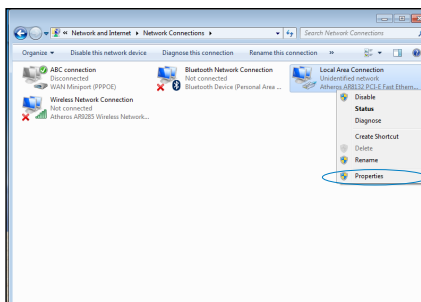

4. Click **Internet Protocol Version 4(TCP/IPv4)** and click **Properties**.

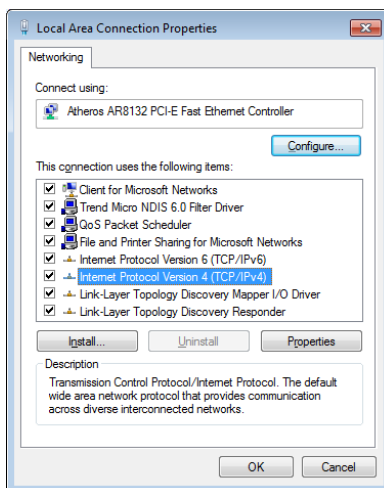

5. Click **Obtain an IP address automatically** and click **OK**.

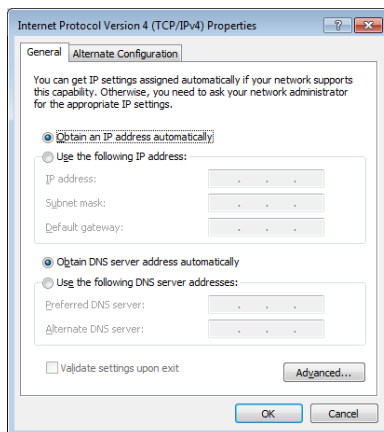

NOTE: Continue to the next steps if you are using PPPoE connection.

6. Return to the **Network and Sharing Center** and then click **Set up a new connection or network**.

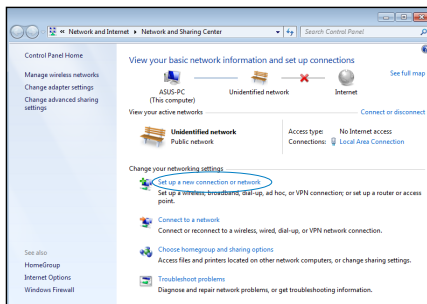

7. Select **Connect to the Internet** and click **Next**.

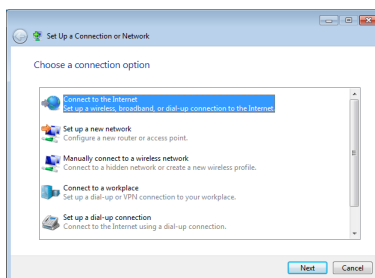

8. Select **Broadband (PPPoE)** and click **Next**.

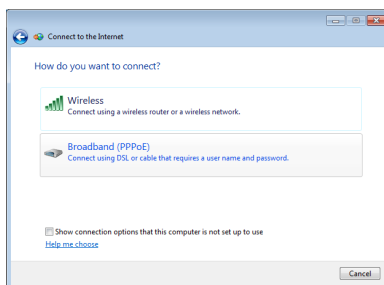

9. Enter your User name and, Password, and Connection name. Click **Connect**.

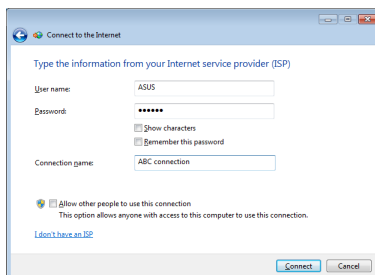

10. Click **Close** to finish the configuration.

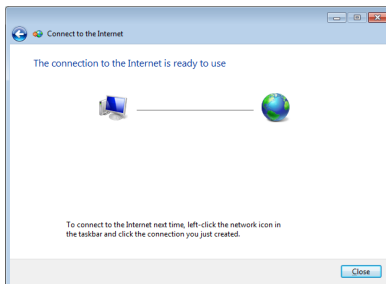

11. Click the network icon in the taskbar and click the connection you just created.

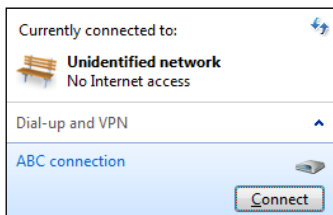

12. Enter your user name and password. Click **Connect** to connect to the Internet.

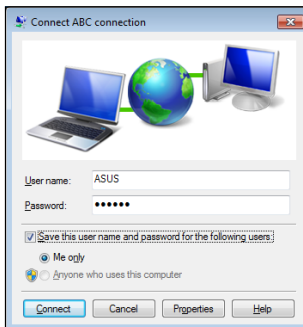

Configuring a static IP network connection

To configure a static IP network connection:

1. Repeat steps 1 to 4 of the previous section **Configuring a dynamic IP/PPPoE network connection**.
2. Click **Use the following IP address**.
3. Enter the IP address, Subnet mask and Gateway from your service provider.
4. If needed, enter the preferred DNS Server address and alternative address.
5. When done, click **OK**.

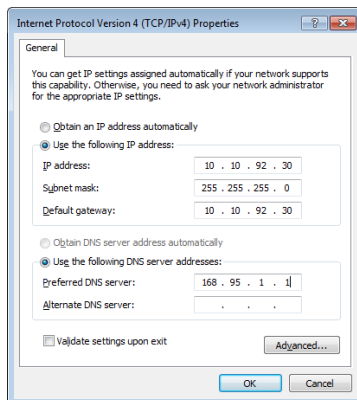

Connecting on Windows® 8

Wi-Fi connection

1. Launch the Charm bar from the Start screen or from any application mode.

NOTE: For details, refer to the section *Charm bar* under *Working with Windows® apps*.

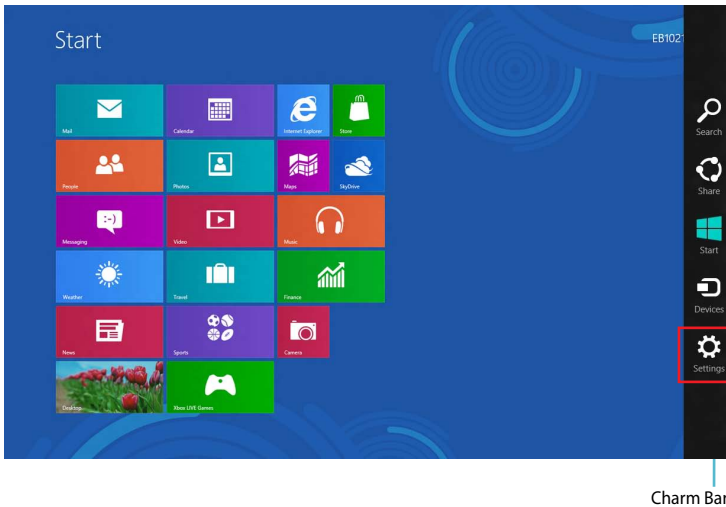

2. From the Charm bar, select **Settings** and click the network icon



3. Select the wireless network that you want to connect to from the list.
4. Click **Connect**.

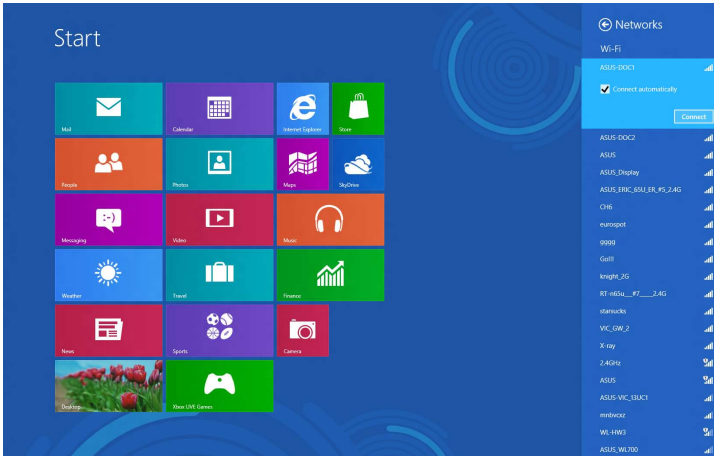

NOTE: You may be prompted to enter a security key to connect to a secured wireless network.

Wired connection

1. Use a network (RJ-45) cable to connect your PC to a DSL/cable modem or a local area network (LAN).

DSL/Cable Modem

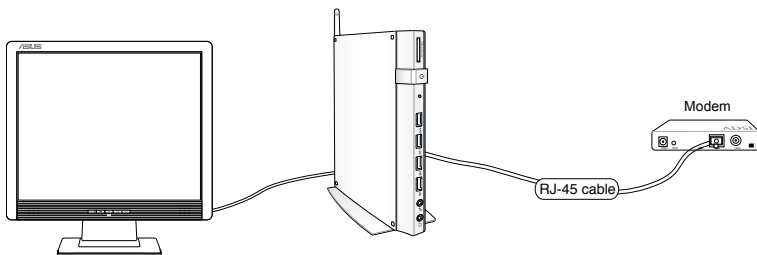

LAN

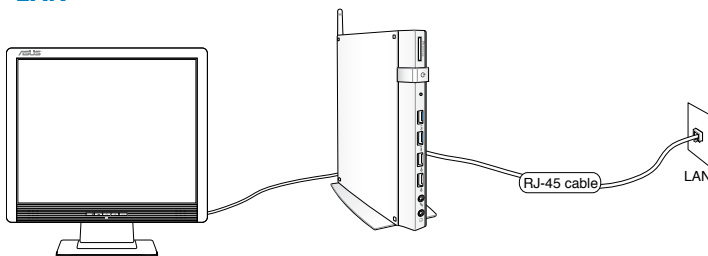

2. Configure a dynamic IP/PPPoE or static IP network connection. To do this, follow these steps:
 - a) From the Start screen, click **Desktop** to launch the Desktop Mode.
 - b) From the Windows® taskbar, right-click the network icon  and click **Open Network and Sharing Center**.
3. From the Open Network and Sharing Center screen, click **Change Adapter settings**.
4. Right-click on your LAN and select **Properties**.
5. Follow steps 4 to 12 on the section *Configuring a dynamic IP/PPPoE network connection* or *Configuring a static IP network connection* under *Connecting on Windows 7*.

Chapter 5: Recovering your system

Recovery options on Windows® 7

Using the Recovery Partition

The Recovery Partition quickly restores your PC's software to its original working state. Before using the Recovery Partition, copy your data files (such as Outlook PST files) to USB storage devices or to a network drive and make note of any customized configuration settings (such as network settings).

The Recovery Partition is a reserved space on your hard disk drive used to restore the operating system, drivers, and utilities installed on your PC at the factory.

Recovering the OS to the factory default partition (F9 Recovery)

WARNING! DO NOT delete the partition named "RECOVERY." The recovery partition is created at the factory and cannot be restored by the user if deleted. Take your system to an authorized ASUS service center if you have problems with the recovery process.

To recover the OS to the factory default partition (F9 Recovery):

1. Press <**F9**> during bootup.
2. Select Windows setup [**EMS Enabled**] when this item appears and press [Enter].
3. Select the language and click **Next**.
4. Select **Recover the OS to the Default Partition** and click **Next**.
5. The factory default partition will be displayed. Click **Next**.

6. Data on the default partition will be cleared. Click **Recover** to start the system recovery.

NOTE: You will lose all your data on the selected partition. Ensure that you back up your important data.

7. When the recovery is completed successfully, click **Reboot** to restart the system.

Backing up the factory default environment data to a USB drive (F9 Backup)

To back up the factory default environment data to a USB drive (F9 Backup):

1. Repeat steps 1–4 from the previous section.
2. Select **Backup the Factory Environment to a USB Drive** and click **Next**.
3. Connect a USB storage device to your PC to start the Factory Default Environment backup.

NOTE: The required size of the connected USB storage device should be larger than 15GB. The actual size may vary with your PC model.

4. Select a desired USB storage device if more than one USB storage device is connected to your EeeTop PC/EeeBox PC and click **Next**.

NOTE: If there is already a partition with proper size in the selected USB storage device (for example, a partition that has been used as the backup partition), the system will show this partition automatically and reuse it for backup.

5. Based on the different situations in the previous step, data on the selected USB storage device or on the selected partition will be cleared. Click **Backup** to start backup.

You will lose all your data on the selected USB storage device or on the selected partition. Ensure that you back up your important data.

6. When backing up the factory default environment is completed successfully, click **Reboot** to restart the system.

Recovery options on Windows® 8

Resetting your PC

This option restores your PC to its factory default settings.

IMPORTANT! Back up all your data before using this option.

To reset your PC:

1. Press <F9> during POST.

IMPORTANT! To go through POST, follow any of the two ways described in the section *Quickly enter the BIOS* in Chapter 3.

2. From the screen, click **Troubleshoot**.
3. Select **Reset your PC**.
4. Click **Next**.
5. Select **Only the drive where the Windows is installed**.
6. Select **Just remove my files**.
7. Click **Reset**.

Recovering from a system image file

You can create a USB recovery drive and use this to recover your PC's settings.

Creating a USB recovery drive

IMPORTANT! Your USB storage device must have at least 8GB available space or as stated on your setup screen.

WARNING! All files on your USB storage device will be permanently deleted during the process. Before you proceed, ensure that you back up all your important data.

To create a USB recovery drive:

1. Launch the Control Panel from the All Apps screen.

NOTE: For details, refer to *Launching the All Apps screen under Working with Windows® apps.*

2. From the Control Panel's System and Security, click **Find and fix problems**.
3. Click **Recovery > Create a recovery drive**.
4. Click **Next**.

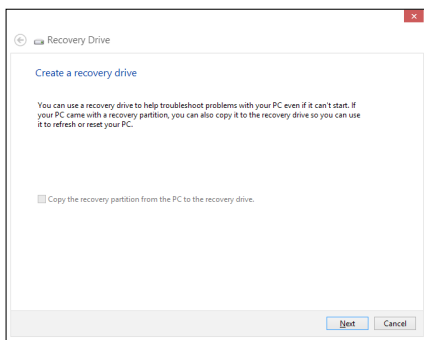

5. Select the USB storage device where you want to copy the recovery files.
6. Click **Next**.

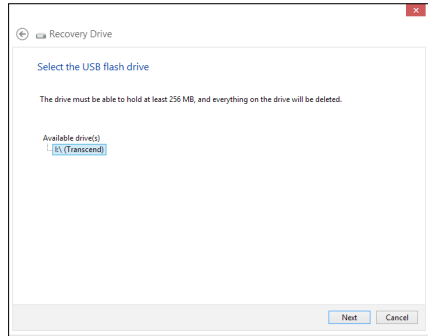

7. Click **Create**. Wait for a while for the process to complete.
8. When the process is completed, click **Finish**.

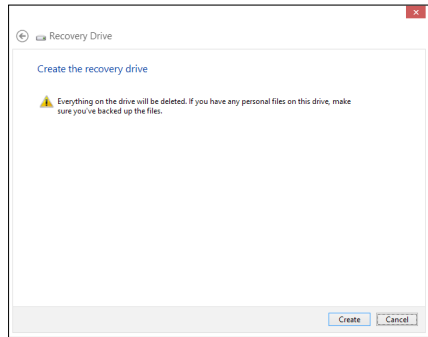

Removing everything and reinstalling Windows

Restoring your PC to its original factory settings can be done using the **Remove everything and reinstall** option in PC Settings. Refer to the steps below to use this option.

IMPORTANT! Back up all your data before using this option.

NOTE: This process may take a while to complete.

1. Launch the **Charm bar**.
2. Click **Settings > Change PC Settings > General**.
3. Scroll down to view the **Remove everything and reinstall Windows** option. Under this option, click **Get Started**.

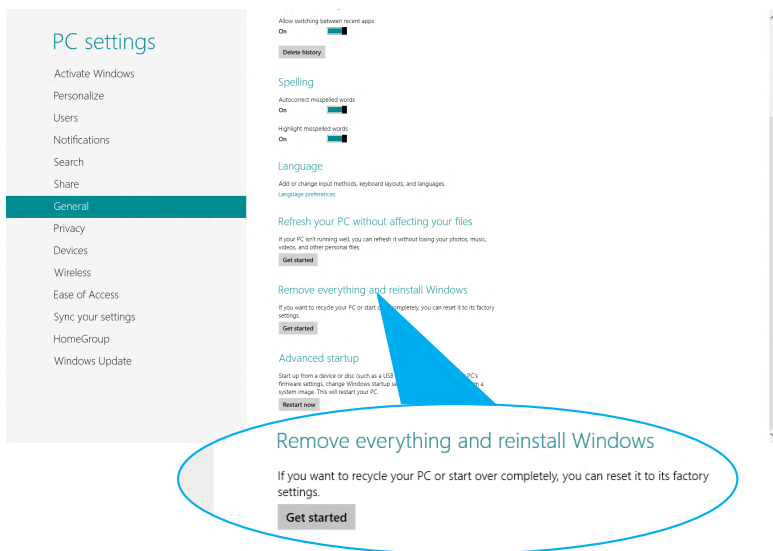

4. Follow the onscreen instructions to complete the reinstallation and reset process.

Appendices

Notices

REACH

Complying with the REACH (Registration, Evaluation, Authorization, and Restriction of Chemicals) regulatory framework, we publish the chemical substances in our products at ASUS REACH website at <http://csr.asus.com/english/REACH.htm>

ASUS Recycling/Takeback Services

ASUS recycling and takeback programs come from our commitment to the highest standards for protecting our environment. We believe in providing solutions for you to be able to responsibly recycle our products, batteries, other components, as well as the packaging materials. Please go to <http://csr.asus.com/english/Takeback.htm> for the detailed recycling information in different regions.

COATING NOTICE

IMPORTANT! To provide electrical insulation and maintain electrical safety, a coating is applied to insulate the device except on the areas where the I/O ports are located.

Federal Communications Commission Statement

This device complies with Part 15 of the FCC Rules. Operation is subject to the following two conditions:

- This device may not cause harmful interference, and
- This device must accept any interference received including interference that may cause undesired operation.

This equipment has been tested and found to comply with the limits for a Class B digital device, pursuant to Part 15 of the FCC Rules. These limits are designed to provide reasonable protection against harmful interference in a residential installation. This equipment generates, uses and can radiate radio frequency energy and, if not installed and used in accordance with manufacturer's instructions, may cause harmful interference to radio communications. However, there is no guarantee that interference will not occur in a particular installation. If this equipment does cause harmful interference to

radio or television reception, which can be determined by turning the equipment off and on, the user is encouraged to try to correct the interference by one or more of the following measures:

- Reorient or relocate the receiving antenna.
- Increase the separation between the equipment and receiver.
- Connect the equipment to an outlet on a circuit different from that to which the receiver is connected.
- Consult the dealer or an experienced radio/TV technician for help.

CAUTION: Any changes or modifications not expressly approved by the grantee of this device could void the user's authority to operate the equipment.

RF exposure warning

This equipment must be installed and operated in accordance with provided instructions and the antenna(s) used for this transmitter must be installed to provide a separation distance of at least 20 cm from all persons and must not be co-located or operating in conjunction with any other antenna or transmitter. End-users and installers must be provide with antenna installation instructions and transmitter operating conditions for satisfying RF exposure compliance.

Declaration of Conformity (R&TTE directive 1999/5/EC)

The following items were completed and are considered relevant and sufficient:

- Essential requirements as in [Article 3]
- Protection requirements for health and safety as in [Article 3.1a]
- Testing for electric safety according to [EN 60950]
- Protection requirements for electromagnetic compatibility in [Article 3.1b]
- Testing for electromagnetic compatibility according to [EN 301 489-1] & [EN 301 489-17]
- Effective use of the radio spectrum as in [Article 3.2]
- Radio test suites according to [EN 300 328-2]

France Restricted Wireless Frequency Bands

Some areas of France have a restricted frequency band. The worst case maximum authorized power indoors are:

- 10mW for the entire 2.4 GHz band (2400 MHz–2483.5 MHz)
- 100mW for frequencies between 2446.5 MHz and 2483.5 MHz

NOTE: Channels 10 through 13 inclusive operate in the band 2446.6 MHz to 2483.5 MHz.

There are few possibilities for outdoor use: On private property or on the private property of public persons, use is subject to a preliminary authorization procedure by the Ministry of Defense, with maximum authorized power of 100mW in the 2446.5–2483.5 MHz band. Use outdoors on public property is not permitted.

In the departments listed below, for the entire 2.4 GHz band:

- Maximum authorized power indoors is 100mW
- Maximum authorized power outdoors is 10mW

Departments in which the use of the 2400–2483.5 MHz band is permitted with an EIRP of less than 100mW indoors and less than 10mW outdoors:

01	Ain	02	Aisne	03	Allier
05	Hautes Alpes	08	Ardennes	09	Ariège
11	Aude	12	Aveyron	16	Charente
24	Dordogne	25	Doubs	26	Drôme
32	Gers	36	Indre	37	Indre et Loire
41	Loir et Cher	45	Loiret	50	Manche
55	Meuse	58	Nièvre	59	Nord
60	Oise	61	Orne	63	Puy du Dôme
64	Pyrénées Atlantique	66	Pyrénées Orientales	67	Bas Rhin
70	Haute Saône	71	Saône et Loire	75	Paris
82	Tarn et Garonne	84	Vaucluse	88	Vosges
89	Yonne	90	Territoire de Belfort	94	Val de Marne

This requirement is likely to change over time, allowing you to use your wireless LAN card in more areas within France. Please check with ART for the latest information (www.art-telecom.fr)

NOTE: Your WLAN Card transmits less than 100mW, but more than 10mW.

Canadian Department of Communications Statement

This digital apparatus does not exceed the Class B limits for radio noise emissions from digital apparatus set out in the Radio Interference Regulations of the Canadian Department of Communications.

This class B digital apparatus complies with Canadian ICES-003.

IC Radiation Exposure Statement for Canada

This equipment complies with IC radiation exposure limits set forth for an uncontrolled environment. To maintain compliance with IC RF exposure compliance requirements, please avoid direct contact to the transmitting antenna during transmitting. End users must follow the specific operating instructions for satisfying RF exposure compliance.

Operation is subject to the following two conditions:

- This device may not cause interference and
- This device must accept any interference, including interference that may cause undesired operation of the device.

CE Mark Warning



CE marking for devices without wireless LAN/Bluetooth

The shipped version of this device complies with the requirements of the EEC directives 2004/108/EC "Electromagnetic compatibility" and 2006/95/EC "Low voltage directive".



CE marking for devices with wireless LAN/ Bluetooth

This equipment complies with the requirements of Directive 1999/5/EC of the European Parliament and Commission from 9 March, 1999 governing Radio and Telecommunications Equipment and mutual recognition of conformity.

Wireless Operation Channel for Different Domains

N. America	2.412-2.462 GHz	Ch01 through CH11
Japan	2.412-2.484 GHz	Ch01 through Ch14
Europe ETSI	2.412-2.472 GHz	Ch01 through Ch13

ENERGY STAR complied product



ENERGY STAR is a joint program of the U.S. Environmental Protection Agency and the U.S. Department of Energy helping us all save money and protect the environment through energy efficient products and practices.

All ASUS products with the ENERGY STAR logo comply with the ENERGY STAR standard, and the power management feature is enabled by default. The monitor and computer are automatically set to sleep after 15 and 30 minutes of user inactivity. To wake your computer, click the mouse or press any key on the keyboard.

Please visit <http://www.energy.gov/powermanagement> for detail information on power management and its benefits to the environment. In addition, please visit <http://www.energystar.gov> for detail information on the ENERGY STAR joint program.

NOTE: Energy Star is NOT supported on FreeDOS and Linux-based products.

ASUS contact information

ASUSTeK COMPUTER INC.

Address 15 Li-Te Road, Peitou, Taipei, Taiwan 11259
 Telephone +886-2-2894-3447
 Fax +886-2-2890-7798
 E-mail info@asus.com.tw
 Web site www.asus.com.tw

Technical Support

Telephone +86-21-38429911
 Online support support.asus.com

ASUS COMPUTER INTERNATIONAL (America)

Address 800 Corporate Way, Fremont, CA 94539, USA
 Telephone +1-812-282-3777
 Fax +1-510-608-4555
 Web site usa.asus.com

Technical Support

Telephone +1-812-282-2787
 Support fax +1-812-284-0883
 Online support support.asus.com

ASUS COMPUTER GmbH (Germany and Austria)

Address Harkort Str. 21-23, D-40880 Ratingen, Germany
 Fax +49-2102-959911
 Web site www.asus.de
 Online contact www.asus.de/sales

Technical Support

Telephone +49-1805-010923*
 Support Fax +49-2102-9599-11*
 Online support support.asus.com

* EUR 0.14/minute from a German fixed landline; EUR 0.42/minute from a mobile phone.

Manufacturer	ASUSTeK Computer Inc.	
	Tel:	+886-2-2894-3447
	Address:	No. 150, LI-TE RD., PEITOU, TAIPEI 112, TAIWAN R.O.C
Authorised representative in Europe	ASUSTeK Computer GmbH	
	Address:	HARKORT STR. 21-23, 40880 RATINGEN, GERMANY

Free Manuals Download Website

<http://myh66.com>

<http://usermanuals.us>

<http://www.somanuals.com>

<http://www.4manuals.cc>

<http://www.manual-lib.com>

<http://www.404manual.com>

<http://www.luxmanual.com>

<http://aubethermostatmanual.com>

Golf course search by state

<http://golfingnear.com>

Email search by domain

<http://emailbydomain.com>

Auto manuals search

<http://auto.somanuals.com>

TV manuals search

<http://tv.somanuals.com>