

**ASUS**<sup>®</sup>

# **TW300-E5 / P14**

*Intel<sup>®</sup> LGA775 Core<sup>™</sup> 2 Extreme /  
Core<sup>™</sup> 2 Quad / Core<sup>™</sup> 2 Duo Series  
Workstation  
User's Manual*



E3822

First Edition

May 2008

**Copyright © 2008 ASUSTeK COMPUTER INC. All Rights Reserved.**

No part of this manual, including the products and software described in it, may be reproduced, transmitted, transcribed, stored in a retrieval system, or translated into any language in any form or by any means, except documentation kept by the purchaser for backup purposes, without the express written permission of ASUSTeK COMPUTER INC. ("ASUS").

ASUS provides this manual "as is" without warranty of any kind, either express or implied, including but not limited to the implied warranties or conditions of merchantability or fitness for a particular purpose. In no event shall ASUS, its directors, officers, employees, or agents be liable for any indirect, special, incidental, or consequential damages (including damages for loss of profits, loss of business, loss of use or data, interruption of business and the like), even if ASUS has been advised of the possibility of such damages arising from any defect or error in this manual or product.

Specifications and information contained in this manual are furnished for informational use only, and are subject to change at any time without notice, and should not be construed as a commitment by ASUS. ASUS assumes no responsibility or liability for any errors or inaccuracies that may appear in this manual, including the products and software described in it.

Product warranty or service will not be extended if: (1) the product is repaired, modified or altered, unless such repair, modification or alteration is authorized in writing by ASUS; or (2) the serial number of the product is defaced or missing.

Products and corporate names appearing in this manual may or may not be registered trademarks or copyrights of their respective companies, and are used only for identification or explanation and to the owners' benefit, without intent to infringe.

# Contents

|                          |      |
|--------------------------|------|
| Contents .....           | iii  |
| Notices .....            | viii |
| Safety information ..... | ix   |
| About this guide .....   | x    |

## Chapter 1: Product introduction

|       |                               |     |
|-------|-------------------------------|-----|
| 1.1   | System package contents ..... | 1-2 |
| 1.2   | Serial number label .....     | 1-2 |
| 1.3   | System specifications .....   | 1-3 |
| 1.4   | Front panel features.....     | 1-5 |
| 1.5   | Rear panel features.....      | 1-6 |
| 1.6   | Internal features .....       | 1-7 |
| 1.7   | LED information .....         | 1-8 |
| 1.7.1 | Front panel LEDs .....        | 1-8 |
| 1.7.2 | LAN (RJ-45) LEDs .....        | 1-8 |

## Chapter 2: Hardware setup

|       |  |      |
|-------|--|------|
| 2.1   | Chassis cover.....                           | 2-2  |
| 2.1.1 | Removing the left side cover.....            | 2-2  |
| 2.1.2 | Removing the right side cover .....          | 2-3  |
| 2.2   | Motherboard overview .....                   | 2-4  |
| 2.3   | Central Processing Unit (CPU) .....          | 2-5  |
| 2.3.1 | Installing the CPU .....                     | 2-5  |
| 2.3.2 | Installing the CPU heatsink.....             | 2-8  |
| 2.4   | System memory .....                          | 2-10 |
| 2.4.1 | Overview .....                               | 2-10 |
| 2.4.2 | Memory configurations.....                   | 2-11 |
| 2.4.3 | Installing a DIMM .....                      | 2-12 |
| 2.4.4 | Removing a DIMM .....                        | 2-12 |
| 2.5   | Installing hard disk drives.....             | 2-13 |
| 2.6   | Installing 5.25-inch drives .....            | 2-15 |
| 2.6.1 | Removing the front panel cover .....         | 2-15 |
| 2.6.2 | Installing an additional optical drive ..... | 2-16 |
| 2.7   | Expansion cards .....                        | 2-19 |
| 2.7.1 | Installing expansion cards.....              | 2-19 |
| 2.7.2 | Configuring an expansion card .....          | 2-20 |

# Contents

|                                    |  |             |
|------------------------------------|--|-------------|
| 2.7.3                              | Interrupt assignments .....                  | 2-21        |
| <b>2.8</b>                         | <b>Removing components .....</b>             | <b>2-22</b> |
| 2.8.1                              | Removing the floppy disk drive .....         | 2-22        |
| 2.8.2                              | Removing the system fan .....                | 2-23        |
| 2.8.3                              | Removing the SATA backplane .....            | 2-24        |
| <b>2.9</b>                         | <b>Connecting cables .....</b>               | <b>2-26</b> |
| <br>                               |  |             |
| <b>Chapter 3: Motherboard info</b> |  |             |
| <b>3.1</b>                         | <b>Motherboard layouts.....</b>              | <b>3-2</b>  |
| <b>3.2</b>                         | <b>Jumpers .....</b>                         | <b>3-6</b>  |
| <b>3.3</b>                         | <b>Connectors .....</b>                      | <b>3-8</b>  |
| 3.3.1                              | Rear panel connectors.....                   | 3-8         |
| 3.3.2                              | Internal connectors .....                    | 3-11        |
| <br>                               |  |             |
| <b>Chapter 4: BIOS information</b> |  |             |
| <b>4.1</b>                         | <b>Managing and updating your BIOS .....</b> | <b>4-2</b>  |
| 4.1.1                              | ASUS Update utility .....                    | 4-2         |
| 4.1.2                              | Creating a bootable floppy disk.....         | 4-5         |
| 4.1.3                              | ASUS EZ Flash 2 utility.....                 | 4-6         |
| 4.1.4                              | AFUDOS utility.....                          | 4-7         |
| 4.1.5                              | ASUS CrashFree BIOS 3 utility .....          | 4-9         |
| <b>4.2</b>                         | <b>BIOS setup program .....</b>              | <b>4-10</b> |
| 4.2.1                              | BIOS menu screen.....                        | 4-11        |
| 4.2.2                              | Menu bar.....                                | 4-11        |
| 4.2.3                              | Navigation keys.....                         | 4-11        |
| 4.2.4                              | Menu items .....                             | 4-12        |
| 4.2.5                              | Sub-menu items.....                          | 4-12        |
| 4.2.6                              | Configuration fields .....                   | 4-12        |
| 4.2.7                              | Pop-up window .....                          | 4-12        |
| 4.2.8                              | Scroll bar.....                              | 4-12        |
| 4.2.9                              | General help .....                           | 4-12        |
| <b>4.3</b>                         | <b>Main menu .....</b>                       | <b>4-13</b> |
| 4.3.1                              | System Time .....                            | 4-13        |
| 4.3.2                              | System Date .....                            | 4-13        |
| 4.3.3                              | Legacy Diskette A .....                      | 4-13        |
| 4.3.4                              | Language.....                                | 4-13        |

# Contents

|            |                                    |             |
|------------|------------------------------------|-------------|
| 4.3.5      | SATA 1~6.....                      | 4-14        |
| 4.3.6      | SATA Configuration.....            | 4-15        |
| 4.3.7      | AHCI Configuration.....            | 4-16        |
| 4.3.8      | System Information.....            | 4-17        |
| <b>4.4</b> | <b>Ai Tweaker menu.....</b>        | <b>4-18</b> |
| 4.4.1      | Ai Overclock Tuner.....            | 4-18        |
| 4.4.2      | CPU Ratio Control.....             | 4-19        |
| 4.4.3      | FSB Strap to North Bridge.....     | 4-19        |
| 4.4.4      | DRAM Frequency.....                | 4-20        |
| 4.4.5      | DRAM Command Rate.....             | 4-20        |
| 4.4.6      | DRAM CMD Skew on Channel A/B.....  | 4-20        |
| 4.4.7      | DRAM CLK Skew on Channel A/B.....  | 4-20        |
| 4.4.8      | DRAM Timing Control.....           | 4-20        |
| 4.4.9      | DRAM Static Read Control.....      | 4-21        |
| 4.4.10     | Ai Clock Twister.....              | 4-21        |
| 4.4.11     | Transaction Booster.....           | 4-22        |
| 4.4.12     | CPU Voltage.....                   | 4-22        |
| 4.4.13     | CPU PLL Voltage.....               | 4-22        |
| 4.4.14     | FSB Termination Voltage.....       | 4-22        |
| 4.4.15     | DRAM Voltage.....                  | 4-22        |
| 4.4.16     | North Bridge Voltage.....          | 4-22        |
| 4.4.17     | South Bridge Voltage.....          | 4-23        |
| 4.4.18     | Clock Over-Charging Voltage.....   | 4-23        |
| 4.4.19     | CPU Spread Spectrum.....           | 4-23        |
| 4.4.20     | PCIE Spread Spectrum.....          | 4-24        |
| <b>4.5</b> | <b>Advanced menu.....</b>          | <b>4-25</b> |
| 4.5.1      | CPU Configuration.....             | 4-25        |
| 4.5.2      | Chipset.....                       | 4-27        |
| 4.5.3      | OnBoard Devices Configuration..... | 4-28        |
| 4.5.4      | PCI PnP.....                       | 4-29        |
| 4.5.5      | USB Configuration.....             | 4-30        |
| <b>4.6</b> | <b>Power menu.....</b>             | <b>4-31</b> |
| 4.6.1      | Suspend Mode.....                  | 4-31        |
| 4.6.2      | Repost Video on S3 Resume.....     | 4-31        |
| 4.6.3      | ACPI 2.0 Support.....              | 4-31        |

# Contents

|            |                                   |             |
|------------|-----------------------------------|-------------|
| 4.6.4      | ACPI APIC Support.....            | 4-31        |
| 4.6.5      | APM Configuration.....            | 4-32        |
| 4.6.6      | Hardware Monitor .....            | 4-33        |
| <b>4.7</b> | <b>Boot menu .....</b>            | <b>4-35</b> |
| 4.7.1      | Boot Device Priority .....        | 4-35        |
| 4.7.2      | Boot Settings Configuration ..... | 4-36        |
| 4.7.3      | Security .....                    | 4-37        |
| <b>4.8</b> | <b>Tools menu .....</b>           | <b>4-39</b> |
| 4.8.1      | ASUS EZ Flash 2.....              | 4-39        |
| 4.8.2      | ASUS O.C. Profile.....            | 4-40        |
| 4.8.3      | Ai Net 2 .....                    | 4-41        |
| <b>4.9</b> | <b>Exit menu.....</b>             | <b>4-42</b> |

## Chapter 5: RAID configuration

|            |   |             |
|------------|---|-------------|
| <b>5.1</b> | <b>RAID configurations .....</b>                              | <b>5-2</b>  |
| 5.1.1      | RAID definitions .....  | 5-2         |
| 5.1.2      | Installing hard disk drives.....                              | 5-3         |
| 5.1.3      | Setting the RAID item in BIOS.....                            | 5-3         |
| <b>5.2</b> | <b>Marvel® 88SE6145 RAID BIOS Configuration Utility .....</b> | <b>5-4</b>  |
| 5.2.1      | Creating a RAID set.....                                      | 5-5         |
| 5.2.2      | Deleting an array.....  | 5-8         |
| <b>5.3</b> | <b>Intel® Matrix Storage Manager Option ROM Utility .....</b> | <b>5-10</b> |
| 5.3.1      | Creating a RAID 0 set (Stripe) .....                          | 5-11        |
| 5.3.2      | Creating a RAID 1 set (Mirror) .....                          | 5-13        |
| 5.3.3      | Creating a RAID 10 set (Stripe + Mirror).....                 | 5-14        |
| 5.3.4      | Creating a RAID 5 set (Parity) .....                          | 5-15        |
| 5.3.5      | Deleting a RAID set .....                                     | 5-16        |
| 5.3.6      | Resetting disks to Non-RAID .....                             | 5-17        |
| 5.3.7      | Rebuilding the RAID .....                                     | 5-17        |
| 5.3.8      | Exiting the Intel® Matrix Storage Manager .....               | 5-20        |
| 5.3.9      | Setting the Boot array use MB BIOS Setup Utility .....        | 5-20        |
| 5.3.10     | Global Array Manager .....                                    | 5-21        |

## Chapter 6: Driver installation

|            |  |            |
|------------|--|------------|
| <b>6.1</b> | <b>RAID driver installation .....</b>                    | <b>6-2</b> |
| 6.1.1      | Creating a RAID driver disk without entering the OS..... | 6-2        |

# Contents

|            |  |             |
|------------|--|-------------|
| 6.1.2      | Creating a RAID/SATA driver disk in Windows® ..... | 6-2         |
| 6.1.3      | Installing the RAID controller driver .....        | 6-3         |
| 6.1.4      | Installing an operating system .....               | 6-5         |
| <b>6.2</b> | <b>Support DVD information .....</b>               | <b>6-6</b>  |
| 6.2.1      | Running the support DVD .....                      | 6-6         |
| 6.2.2      | Drivers menu .....                                 | 6-7         |
| 6.2.3      | Utilities menu .....                               | 6-8         |
| 6.2.4      | Make Disk menu .....                               | 6-10        |
| 6.2.5      | Manual menu .....                                  | 6-11        |
| 6.2.6      | ASUS Contact information .....                     | 6-11        |
| 6.2.7      | Other information .....                            | 6-12        |
| <b>6.3</b> | <b>Software information .....</b>                  | <b>6-14</b> |
| 6.3.1      | ASUS MyLogo2™ .....                                | 6-14        |
| 6.3.2      | Audio configurations .....                         | 6-16        |
| 6.3.3      | ASUS PC Probe II .....                             | 6-24        |
| 6.3.4      | ASUS AI Suite .....                                | 6-30        |
| 6.3.5      | ASUS AI Gear 2 .....                               | 6-32        |
| 6.3.6      | ASUS AI Nap .....                                  | 6-33        |
| 6.3.7      | ASUS AI N.O.S. .....                               | 6-34        |
| 6.3.8      | ASUS Q-Fan 2 .....                                 | 6-35        |
| 6.3.9      | ASUS AI Booster .....                              | 6-36        |

## Appendix: Reference information

|            |  |            |
|------------|--|------------|
| <b>A.1</b> | <b>Intel® EM64T .....</b>                                | <b>A-2</b> |
|            | Using the Intel® EM64T feature .....                     | A-2        |
| <b>A.2</b> | <b>Enhanced Intel SpeedStep® Technology (EIST) .....</b> | <b>A-2</b> |
| A.2.1      | System requirements .....                                | A-2        |
| A.2.2      | Using the EIST .....                                     | A-3        |
| <b>A.3</b> | <b>Intel® Hyper-Threading Technology .....</b>           | <b>A-4</b> |
|            | Using the Hyper-Threading Technology .....               | A-4        |
| <b>A.4</b> | <b>Simple fixes .....</b>                                | <b>A-5</b> |

# Notices

## Federal Communications Commission Statement

This device complies with Part 15 of the FCC Rules. Operation is subject to the following two conditions:

- This device may not cause harmful interference, and
- This device must accept any interference received including interference that may cause undesired operation.

This equipment has been tested and found to comply with the limits for a Class B digital device, pursuant to Part 15 of the FCC Rules. These limits are designed to provide reasonable protection against harmful interference in a residential installation. This equipment generates, uses and can radiate radio frequency energy and, if not installed and used in accordance with manufacturer's instructions, may cause harmful interference to radio communications. However, there is no guarantee that interference will not occur in a particular installation. If this equipment does cause harmful interference to radio or television reception, which can be determined by turning the equipment off and on, the user is encouraged to try to correct the interference by one or more of the following measures:

- Reorient or relocate the receiving antenna.
- Increase the separation between the equipment and receiver.
- Connect the equipment to an outlet on a circuit different from that to which the receiver is connected.
- Consult the dealer or an experienced radio/TV technician for help.



---

**WARNING!** The use of shielded cables for connection of the monitor to the graphics card is required to assure compliance with FCC regulations. Changes or modifications to this unit not expressly approved by the party responsible for compliance could void the user's authority to operate this equipment.

---

## Canadian Department of Communications Statement

This digital apparatus does not exceed the Class B limits for radio noise emissions from digital apparatus set out in the Radio Interference Regulations of the Canadian Department of Communications.

This class B digital apparatus complies with Canadian ICES-003.



---

This symbol of the crossed out wheeled bin indicates that the product (electrical, electronic equipment and mercury-containing button cell battery) should not be placed in municipal waste. Check local regulations for disposal of electronic products.

---



# Safety information

## Electrical Safety

- Before installing or removing signal cables, ensure that the power cables for the system unit and all attached devices are unplugged.
- To prevent electrical shock hazard, disconnect the power cable from the electrical outlet before relocating the system.
- When adding or removing any additional devices to or from the system, contact a qualified service technician or your dealer. Ensure that the power cables for the devices are unplugged before the signal cables are connected. If possible, disconnect all power cables from the existing system before you service.
- If the power supply is broken, do not try to fix it by yourself. Contact a qualified service technician or your dealer.

## Operation Safety

- Servicing of this product or units is to be performed by trained service personnel only.
- Before operating the server, carefully read all the manuals included with the server package.
- Before using the server, make sure all cables are correctly connected and the power cables are not damaged. If any damage is detected, contact your dealer as soon as possible.
- To avoid short circuits, keep paper clips, screws, and staples away from connectors, slots, sockets and circuitry.
- Avoid dust, humidity, and temperature extremes. Place the server on a stable surface.



This product is equipped with a three-wire power cable and plug for the user's safety. Use the power cable with a properly grounded electrical outlet to avoid electrical shock.

### Lithium-Ion Battery Warning

**CAUTION!** Danger of explosion if battery is incorrectly replaced. Replace only with the same or equivalent type recommended by the manufacturer. Dispose of used batteries according to the manufacturer's instructions.

### CD-ROM Drive Safety Warning

**CLASS 1 LASER PRODUCT**

### Heavy System

**CAUTION!** This server system is heavy. Ask for assistance when moving or carrying the system.

# About this guide

## Audience

This user guide is intended for system integrators and experienced users with at least basic knowledge of configuring a workstation.

## Contents

This guide contains the following parts:

### 1. Chapter 1: Product Introduction

This chapter describes the general features of the workstation, including sections on front panel and rear panel specifications.

### 2. Chapter 2: Hardware setup

This chapter lists the hardware setup procedures that you have to perform when installing or removing system components.

### 3. Chapter 3: Motherboard information

This chapter gives information about the motherboard that comes with the workstation. This chapter includes the motherboard layout, jumper settings, and connector locations.

### 4. Chapter 4: BIOS information

This chapter tells how to change system settings through the BIOS Setup menus and describes the BIOS parameters.

### 5. Chapter 5: RAID configuration

This chapter provides information on how to configure your hard disk drives as RAID sets.

### 6. Chapter 6: Driver installation

This chapter provides information on how to install the drivers for system components. This chapter also describes the software applications that the barebone workstation supports.

### 7. Appendix: Reference information

This section provides information about the CPU features and technologies and a troubleshooting guide for solving common problems when using the barebone workstation.

## Conventions

To make sure that you perform certain tasks properly, take note of the following symbols used throughout this manual.



**WARNING:** Information to prevent injury to yourself when trying to complete a task.



**CAUTION:** Information to prevent damage to the components when trying to complete a task.



**IMPORTANT:** Instructions that you **MUST** follow to complete a task.



**NOTE:** Tips and information to aid in completing a task.

## Reference

Visit the ASUS websites worldwide that provide updated information for all ASUS hardware and software products. Refer to the ASUS contact information for details.



# Chapter 1

This chapter describes the general features of the workstation, including sections on front panel and rear panel specifications.



## 1.1 System package contents

Check your system package for the following items.

|                |   |
|----------------|---|
| Model Name     | TW300-E5/P14  |
| Chassis        | ASUS T10 Pedestal Chassis   |
| Motherboard    | ASUS P5E WS Professional  |
| Component      | 1 x 450W Single Power Supply<br>1 x 95mm System Fan<br>5 x SATA Cables<br>1 x 7-in-1 Card Reader<br>4 x Internal HDD trays<br>1 x Front I/O Board |
| Accessories    | 1 x ASUS TW300-E5/P14 User's Guide<br>1 x TW300-E5/P14 Support CD<br>1 x Bag of Screws<br>1 x AC Power Cable<br>1 x CPU Heatsink                  |
| Optional Items | -   |



If any of the above items is damaged or missing, contact your retailer.

## 1.2 Serial number label

Before requesting support from the ASUS Technical Support team, you must take note of the product's serial number containing 12 characters such as xxxxxxxxxxxx. See the figure below.

With the correct serial number of the product, ASUS Technical Support team members can then offer a quicker and satisfying solution to your problems.



## 1.3 System specifications

The ASUS TW300-E5/PI4 is a workstation featuring the ASUS P5E WS Professional motherboard. The workstation supports Intel® LGA775 Core™ 2 Extreme / Core™ 2 Quad / Core™ 2 Duo processors with EM64T technology, plus other latest technologies through the chipsets onboard.

| Model Name             |  | TW300-E5/PI4  |
|------------------------|--|---|
| Processor / System Bus |  | 1 x Socket LGA775   |
|                        |  | <b>Quad-core:</b><br>Intel® Core™ 2 Extreme QX9000 Series (45nm)<br>Intel® Core™ 2 Extreme QX6000 Series<br>Intel® Core™ 2 Quad Q9000 Series (45nm)<br>Intel® Core™ 2 Quad Q6000 Series<br><b>Dual-core:</b><br>Intel® Core™ 2 Duo E8000 Series (45nm)<br>Intel® Core™ 2 Duo E6000 Series         |
|                        |  | FSB 1333 / 1066 / 800 MHz with EM64T  |
| Core Logic             |  | Intel® X38 MCH<br>Intel® ICH9R<br>PCI-X NEC upd720404   |
| ASUS Features          | Q Fan  | √   |
| Memory                 | Total Slots                                  | 4 (Dual-Channel)  |
|                        | Capacity                                     | Maximum up to 8GB   |
|                        | Memory Type                                  | DDR2 800 / 667 ECC and Non-ECC, Unbuffered  |
|                        | Memory Size                                  | 512MB, 1GB, and 2GB   |
| Expansion Slots        | Total PCI/PCI-X/PCI-E Slots                  | 6   |
|                        | Slot Type                                    | 2 x PCIe x16 Gen2 slots (x16 link)<br>1 x PCIe x1 slot (x1 link)<br>1 x PCI-X 64bit/133MHz slot<br>2 x PCI 32-bit / 33MHz slots (5V)  |
| Storage                | SATA Controller                              | 6 x SATAII 300MB/s ports<br><b>Intel® ICH9R:</b><br>Intel Matrix Storage (for Windows only)<br>- Supports software RAID 0, 1, 5 and 10<br><b>Marvell 88SE6145 SATA Controller:</b><br>- Supports software RAID 0, 1, 5, and 10 (for Windows)<br>- Supports software RAID 0, 1, and 10 (for Linux) |
| HDD Bays               | I = internal<br>A or S will be hot-swappable | 4 x Internal SATAII HDD Bays  |

(continued on the next page)

|   |            |  |
|---|------------|--|
| <b>Networking</b>                                       | <b>LAN</b> | 2 x Marvell® 8056 PCI-E GbE LANs   |
| <b>Auxiliary Storage FDD / CD / DVD</b>                 |            | 1 x 7-in-1 Card Reader<br>2 x 5.25" Optical Drives (Options: 16X DVD-ROM / DVD-RW)   |
| <b>Graphic</b>  | <b>VGA</b> | Graphic Add-on Card Configuration Option:<br><b>Option 1: Professional 2D</b><br>- NVIDIA Quadro NVS290 (256 MB, up to 2 cards)<br><b>Option 2: Entry 3D</b><br>- NVIDIA Quadro FX370 (256 MB, up to 2 cards)<br>- NVIDIA Quadro FX570 (256 MB, up to 2 cards)<br><b>Option 3: Mid-range 3D</b><br>- NVIDIA Quadro FX 1700 (512 MB, up to 2 cards) |
| <b>Onboard I/O</b>                                      |            | 1 x PS/2 keyboard port<br>2 x RJ-45 ports<br>1 x S/PDIF Out port (Coaxial + Optical)<br>8 x USB 2.0 ports (Front x 2, Rear x 6)<br>2 x eSATA ports<br>1 x IEEE1394a port<br>6 x Audio ports  |
| <b>OS Support</b>                                       |            | Genuine Windows® XP Professional 32 / 64-bit<br>Genuine Windows® Vista Business 32 / 64-bit  |
| <b>Anti-virus Software</b>                              |            | Norton® Internet Security 2007 (Trial Version)   |
| <b>Dimension (HH x WW x DD)</b>                         |            | 441mm x 207mm x 517mm  |
| <b>Net Weight Kg (CPU, DRAM &amp; HDD not included)</b> |            | 16 Kg  |
| <b>Power Supply</b>                                     |            | 450W Single Power Supply   |
| <b>Environment</b>                                      |            | Operation temperature: 10°C~35°C<br>Non operation temperature: -40°C~70°C<br>Non operation humidity: 20%~90% (Non-condensing)  |

\*Specifications are subject to change without notice.



## 1.4 Front panel features

The barebone server displays a simple yet stylish front panel with easily accessible features. The power and reset buttons, LED indicators, optical drive, and two USB ports are located on the front panel.

The drive bays, power and reset buttons, LED indicators, CD/DVD-ROM drive, floppy drive, and USB 2.0 ports are located on the front panel. For future installation of 5.25-inch devices, two drive bays are available.

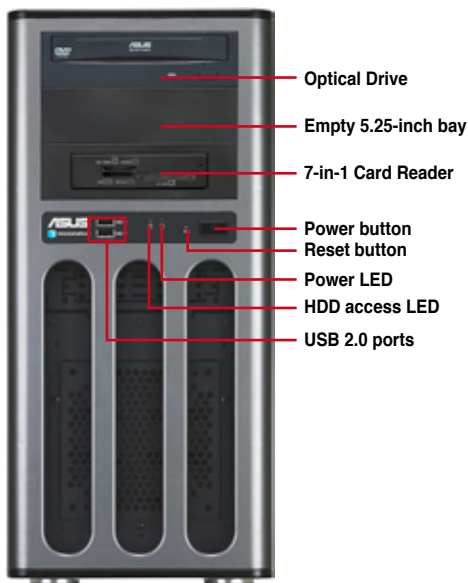

---

Refer to section 1.7.1 **Front panel LEDs** for the LED descriptions.

---

# 1.5 Rear panel features

The rear panel includes a slot for the motherboard rear I/O ports, expansion slots, a power supply module, and a vent for the system fan.



The ports for the PS/2 keyboard, PS/2 mouse, USB, VGA, and Gigabit LAN do not appear on the rear panel if motherboard is not present.

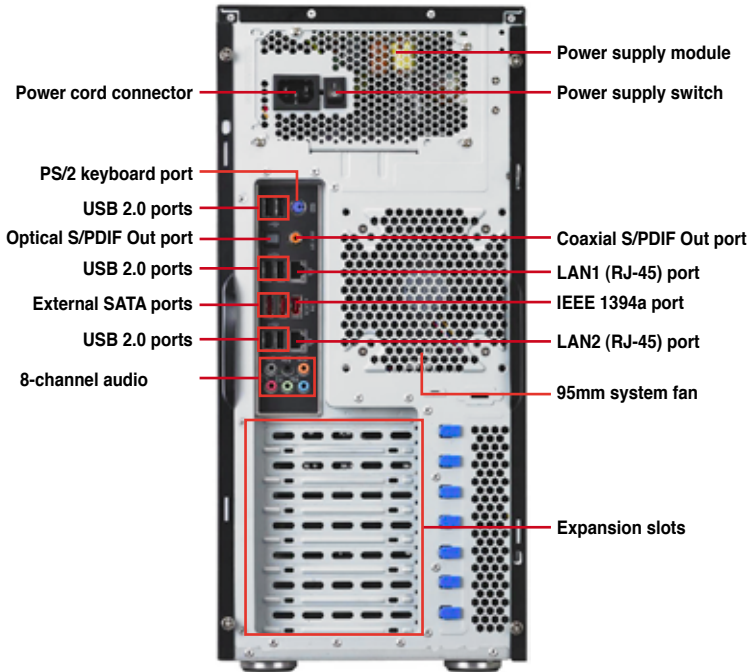

## 1.6 Internal features

The barebone server includes the basic components as shown.

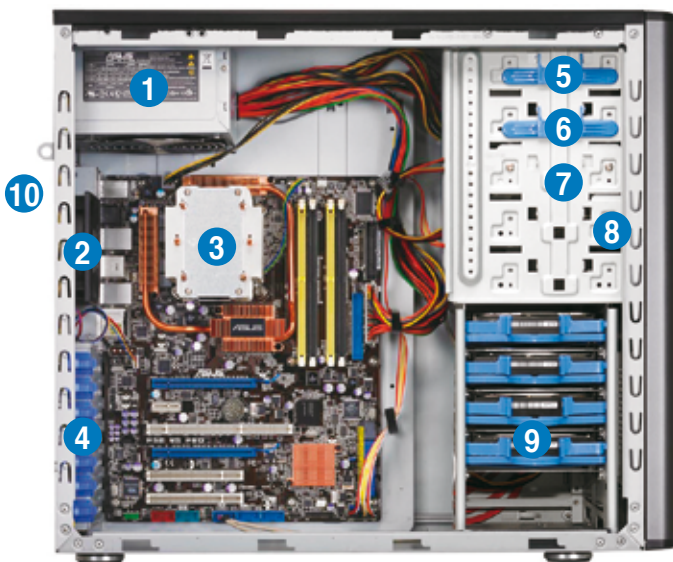

1. Power supply unit
2. 95mm system fan
3. ASUS P5E WS Professional motherboard
4. Expansion card locks
5. Optical drive
6. 5.25-inch drive bay
7. 7-in-1 Card Reader
8. Front I/O board (hidden)
9. Internal HDD bays
10. Chassis intrusion switch

# 1.7 LED information

## 1.7.1 Front panel LEDs

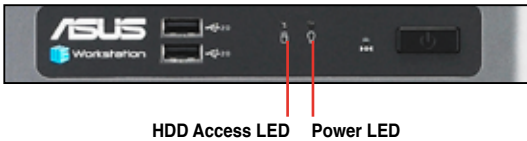

| LED            | Icon | Display status  | Description                                 |
|----------------|------|-----------------|---|
| Power LED      |      | ON              | System power ON                             |
| HDD Access LED |      | OFF<br>Blinking | No activity<br>Read/write data into the HDD |

## 1.7.2 LAN (RJ-45) LEDs

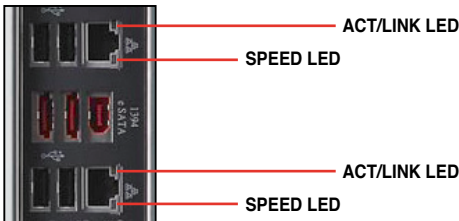

| ACT/LINK LED |               | SPEED LED |                     |
|--------------|---------------|-----------|---------------------|
| Status       | Description   | Status    | Description         |
| OFF          | No link       | OFF       | 10 Mbps connection  |
| GREEN        | Linked        | ORANGE    | 100 Mbps connection |
| BLINKING     | Data activity | GREEN     | 1 Gbps connection   |

# Chapter 2

This chapter lists the hardware setup procedures that you have to perform when installing or removing system components.



## 2.1 Chassis cover

### 2.1.1 Removing the left side cover

You have to remove the left side cover to install or replace internal components of the server system.



- Ensure that you unplug the power cord before removing the side cover.
- Take extra care when removing the side cover. Keep your fingers from components inside the chassis that can cause injury, such as the CPU fan, rear fan, and other sharp-edged parts.

To remove the left side cover

1. Remove the two screws that secure the left side cover to the chassis.

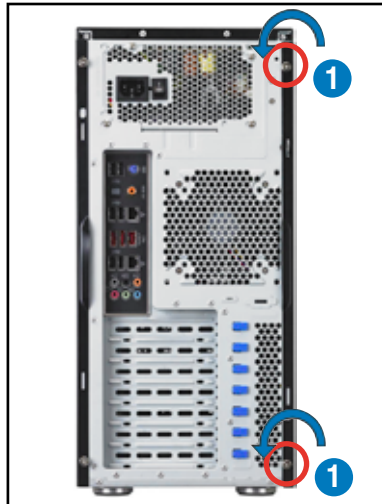

2. Slide the left side cover for about half an inch toward the rear until it is disengaged from the chassis.
3. Carefully lift the cover and set it aside.



## 2.1.2 Removing the right side cover

Most internal components can be installed or replaced after removing the left side cover. However, for components such as Serial ATA hard disk drives, you may have to remove the right side cover for easier component installation or replacement.

To remove the right side cover

1. Remove the two screws that secure the left side cover to the chassis.

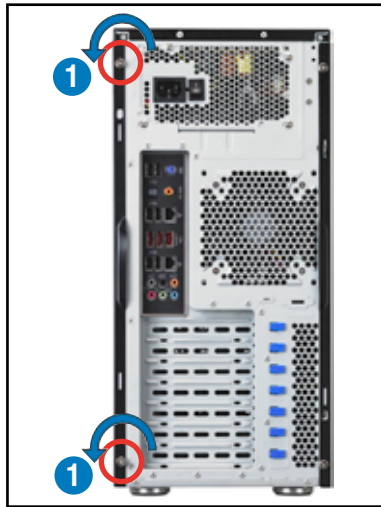

2. Slide the right side cover for about half an inch toward the rear until it is disengaged from the chassis.
3. Carefully lift the cover and set it aside.



## 2.2 Motherboard overview

The barebone server comes with the P5E WS Professional motherboard already installed. The motherboard is secured to the chassis by nine (9) screws as indicated by the circles in the illustration below.



Refer to **Chapter 3: Motherboard information** for detailed information on the motherboard.

Place this side towards the rear of the chassis

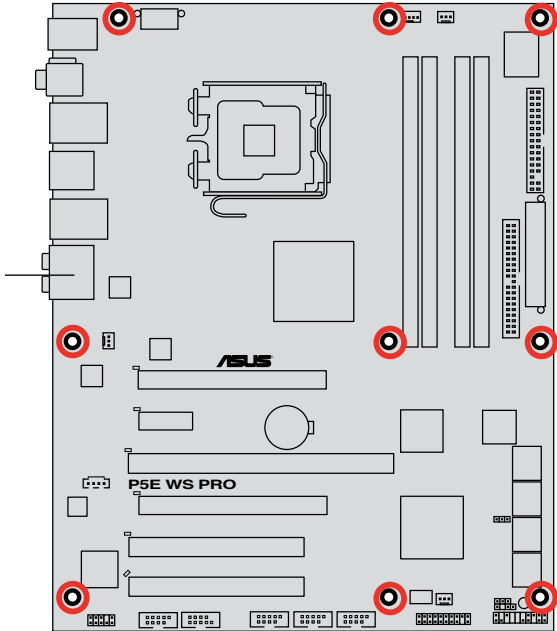

Ensure to unplug the power cord before installing or removing any motherboard component or connection. Failure to do so can cause you physical injury and damage motherboard components.



## 2.3 Central Processing Unit (CPU)

The motherboard comes with a surface mount LGA775 socket designed for the Intel® Xeon 3300 / 3200 / 3100 / 3000 Series processor in the 775-land package

### 2.3.1 Installing the CPU

To install a CPU:

1. Locate the CPU socket on the motherboard.

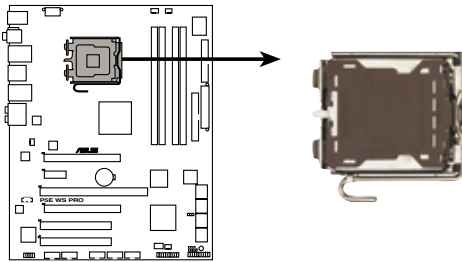

**P5E WS Professional CPU Socket 775**



Before installing the CPU, make sure that the socket box is facing towards you and the load lever is on your left.

2. Press the load lever with your thumb (A), then move it to the left (B) until it is released from the retention tab.

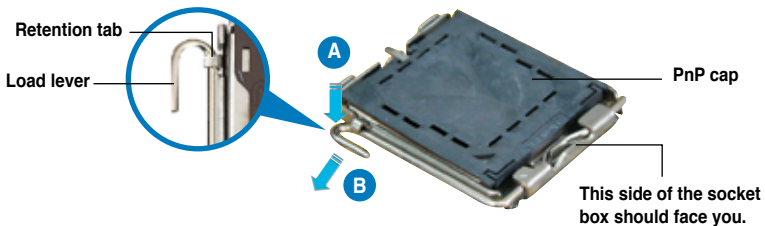

To prevent damage to the socket pins, do not remove the PnP cap unless you are installing a CPU.

3. Lift the load lever in the direction of the arrow to a 135° angle.

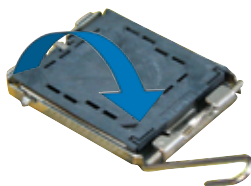

4. Lift the load plate with your thumb and forefinger to a 100° angle (A), then push the PnP cap from the load plate window to remove (B).

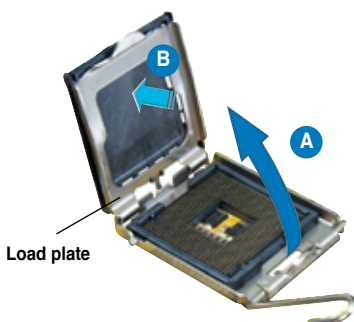

5. Position the CPU over the socket, making sure that the gold triangle is on the bottom-left corner of the socket. The socket alignment key should fit into the CPU notch.

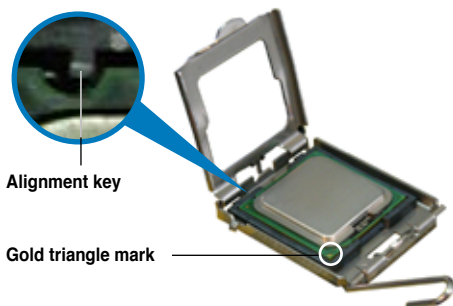

The CPU fits in only one correct orientation. DO NOT force the CPU into the socket to prevent bending the connectors on the socket and damaging the CPU!

6. Close the load plate (A), then push the load lever (B) until it snaps into the retention tab.



---

The motherboard supports Intel® Core 2 Extreme / Core 2 Quad / Core 2 Duo Series LGA775 processors with the Intel® Enhanced Memory 64 Technology (EM64T), Enhanced Intel SpeedStep® Technology (EIST), and Hyper-Threading Technology. Refer to the Appendix for more information on these CPU features.

---

## 2.3.2 Installing the CPU heatsink

The Intel® Core™ 2 Extreme / Core™ 2 Quad / Core™ 2 Duo Series processors require an Intel certified or ASUS qualified heatsink and fan assembly to ensure optimum thermal condition and performance.

When you buy a boxed Intel CPU, the package includes the cooler, fan, retention brackets, screws, thermal grease, installation manual, and other items that are necessary for CPU installation.



- Ensure that you have applied the thermal grease to the top of the CPU before installing the heatsink and fan.
- Refer to the installation manual that came with the CPU package for details on heatsink/fan assembly and installation.

To install the CPU cooler and fan

1. Place the cooler on top of the installed CPU, making sure that the four screws match the holes on the support plate.

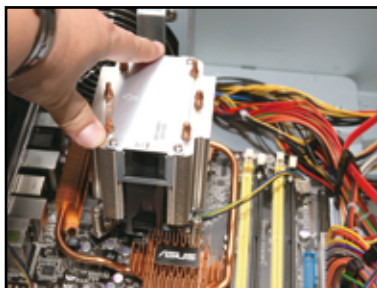

2. Use a screwdriver to tighten the four cooler screws in a diagonal sequence.

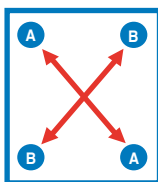

3. Connect the CPU fan cable to the connector on the motherboard labeled **CPU\_FAN**.

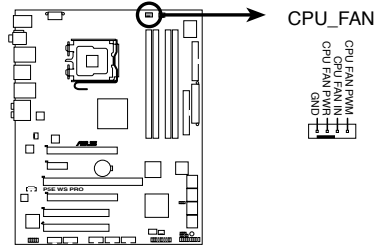

**P5E WS Professional CPU fan connector**



---

Do not forget to connect the **CPU\_FAN** connector! Hardware monitoring errors can occur if you fail to plug this connector.

---

## 2.4 System memory

### 2.4.1 Overview

The motherboard comes with four Double Data Rate II (DDR2) Dual Inline Memory Modules (DIMM) sockets to support 240-pin DDR2 modules.

The figure illustrates the location of the DDR2 DIMM sockets:

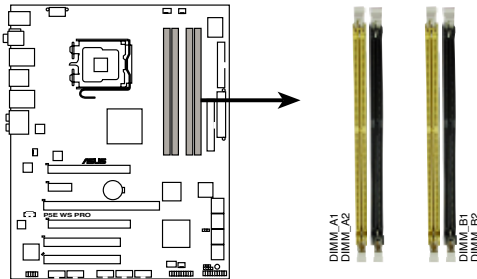

**P5E WS Professional 240-pin DDR2 DIMM sockets**

| Channel   | Sockets             |
|-----------|---------------------|
| Channel A | DIMM_A1 and DIMM_A2 |
| Channel B | DIMM_B1 and DIMM_B2 |



This chipset officially supports DDR2 800/667MHz. With the ASUS Super Memspeed Technology, the motherboard natively supports up to DDR2 1066MHz and provides more ratio setting items than the chipset officially supports. Refer to the table below for details.

|             |      |     |     |      |     |     |
|-------------|------|-----|-----|------|-----|-----|
| <b>FSB</b>  | 1333 |     |     | 1066 |     |     |
| <b>DDR2</b> | 1066 | 800 | 667 | 1066 | 800 | 667 |

## 2.4.2 Memory configurations

You may install 256 MB, 512 MB, 1 GB, and 2 GB ECC and non-ECC, unbuffered DDR2 DIMMs into the DIMM sockets.



- You may install varying memory sizes in Channel A and Channel B. The system maps the total size of the lower-sized channel for the dual-channel configuration. Any excess memory from the higher-sized channel is then mapped for single-channel operation.
- Always install DIMMs with the same CAS latency. For optimum compatibility, it is recommended that you obtain memory modules from the same vendor.
- If you install four 1GB memory modules, the system may only recognize less than 3GB of total memory because of address space allocation for other critical functions. This limitation appears on Windows® Vista 32-bit / Windows® XP 32-bit operation systems since it does not support Physical Address Extension (PAE) mode.
- If you install Windows® Vista 32-bit / Windows® XP 32-bit operation system, a total memory of less than 3GB is recommended.
- This motherboard does not support memory modules made up of 128 Mb chips or double sided x16 memory modules.



- Due to chipset limitation, this motherboard can only support up to 8 GB on the operating systems listed below. You may install a maximum of 2 GB DIMMs on each slot.

### 64-bit

Windows® XP Professional x64 Edition  
Windows® Vista x64 Edition

- Some old-version DDR2-800 DIMMs may not match Intel®'s On-Die-Termination (ODT) requirement and will automatically downgrade to run at DDR2-667. If this happens, contact your memory vendor to check the ODT value.
- Due to chipset limitation, DDR2-800 with CL=4 will be downgraded to run at DDR2-667 by default setting. If you want to operate with lower latency, adjust the memory timing manually.

### 2.4.3 Installing a DIMM



Unplug the power supply before adding or removing DIMMs or other system components. Failure to do so can cause severe damage to both the motherboard and the components.

To install a DIMM:

1. Unlock a DIMM socket by pressing the retaining clips outward.
2. Align a DIMM on the socket such that the notch on the DIMM matches the break on the socket.
3. Firmly insert the DIMM into the socket until the retaining clips snap back in place and the DIMM is properly seated.

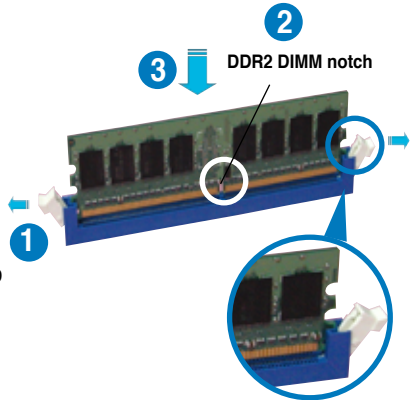

Unlocked retaining clip



- A DDR2 DIMM is keyed with a notch so that it fits in only one direction. Do not force a DIMM into a socket to avoid damaging the DIMM.
- The DDR2 DIMM sockets do not support DDR DIMMs. DO not install DDR DIMMs to the DDR2 DIMM sockets.

### 2.4.4 Removing a DIMM

To remove a DIMM:

1. Simultaneously press the retaining clips outward to unlock the DIMM.



Support the DIMM lightly with your fingers when pressing the retaining clips. The DIMM might get damaged when it flips out with extra force.

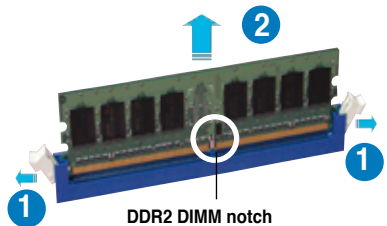

2. Remove the DIMM from the socket.



## 2.5 Installing hard disk drives

The server system supports four Serial ATA hard disk drives through screw-free hard disk drive holders.

To install a Serial ATA hard disk drive

1. Follow the instruction in section **2.1.2 Removing the right side cover** to remove the right side cover.
2. Slightly push inward the HDD holder handles to release the HDD holder lock from the HDD bay, as shown in the right figure.
3. Carefully pull the HDD holder out of the HDD bay, as shown in the right figure.

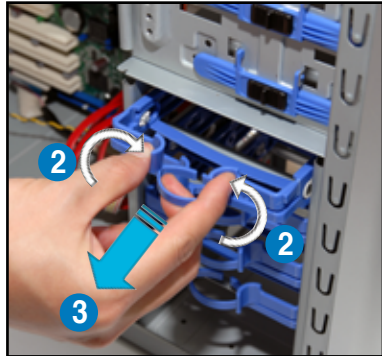

4. Locate the four pin caps on the HDD holder. Align one side of the HDD screw holes to one side of the cage pin caps, as shown in the right figure.

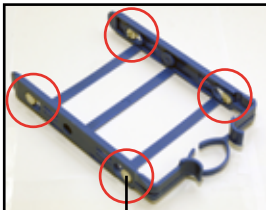

Pin cap



5. Follow the direction of the arrow in the right figure and slightly bend the HDD holder.



6. Attach the other side of the HDD screw holes to the cage pin caps, as shown in the right figure.

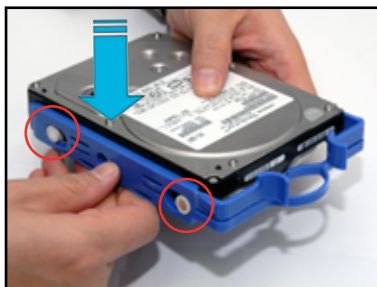

7. Carefully insert the HDD holder and push it all the way to the depth of the bay until the cage handles fix to the HDD bay.

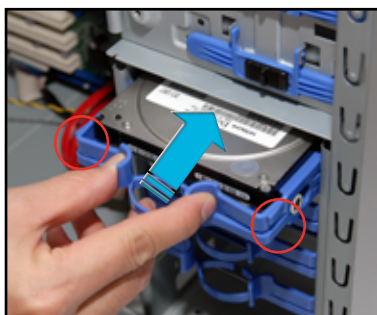

## 2.6 Installing 5.25-inch drives



Ensure to unplug the power cable before installing or removing any system components. Failure to do so may cause severe damage to the motherboard and other system components!

The system comes with two 5.25-inch drive bays located on the upper front part of the chassis. An optical drive that comes standard/optional with the system package occupies the uppermost bay (labeled 1). The lower bay (labeled 2) is available for additional 5.25-inch optical, zip, or floppy disk drives.



You must remove the front panel cover before installing a 5.25-inch drive.



### 2.6.1 Removing the front panel cover

To remove the front panel cover

1. Follow the instructions in section **2.1 Chassis cover** to remove both the side covers.
2. Locate the front cover slot on the bottom of the front cover.



- Carefully remove the front panel cover, and then set aside.



## 2.6.2 Installing an additional optical drive



Configure your optical drive as Master/Slave device before installing it to the drive bay. Refer to the optical drive documentation for details.

To install an additional optical drive

- Select the drive bay you intend to use. Push the knock down metal cover in and out of the chassis until it is removed.

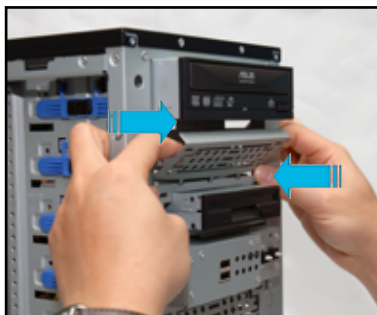

Take extra care when removing the knock down metal cover. Use tools such as a screw driver to bend and remove the metal cover to avoid physical injury.



2. Follow the direction of the arrows in the figure to unlock and lift the drive bay lock.

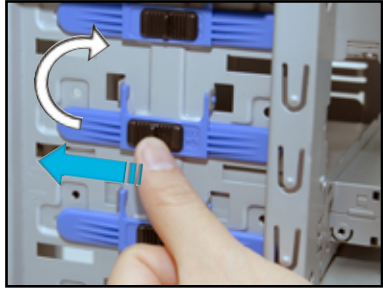

3. Carefully insert the drive to the bay.



4. Align the drive to the bay screw holes, and then lock the drive bay lock.

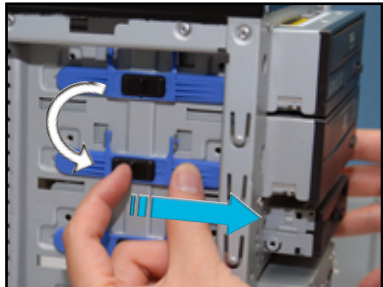

5. Connect a 40-pin IDE cable (from the first optical drive) and a 4-pin power plug (from the power supply unit) to the connectors on the drive.

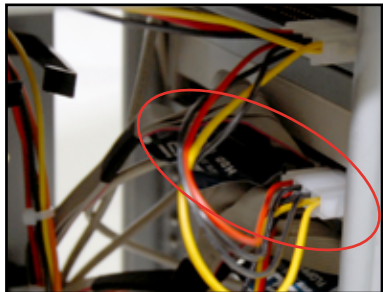

6. Remove the front panel bay cover opposite the drive bay you used by pressing the hooks inward.



7. Reinstall the front panel and side covers when done.



## 2.7 Expansion cards

### 2.7.1 Installing expansion cards

The system comes with two PCI Express x16 slots (x8 link), one PCI Express x1 slot (x1 link), one PCI-X 64bit/133MHz slot, and two PCI 32-bit/33MHz/5V slots.



Ensure to unplug the power cable before installing or removing an expansion card. Failure to do so may cause severe damage to the motherboard and other system components!

To install an expansion card

1. Before installing the expansion card, read the documentation that came with it and make the necessary hardware settings for the card.
2. Lay the system on its side on a flat, stable surface.
3. Select the slot that you intend to use, and then remove the knock down metal cover.
4. Slightly push down the expansion card lock to unlock it from the chassis.

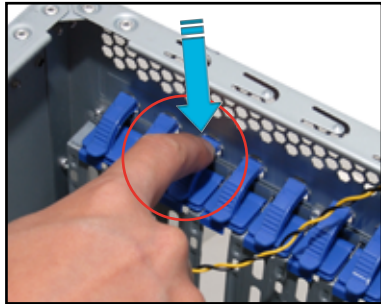

5. Lift the expansion card lock by following the direction of the arrow in the right figure.

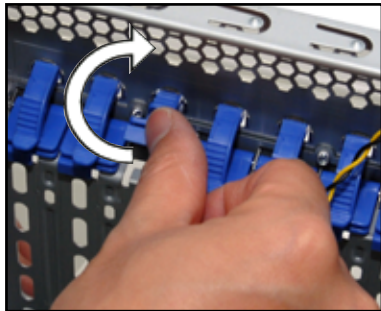

6. Align the card connector with the slot, then press firmly until the card is completely seated on the slot.

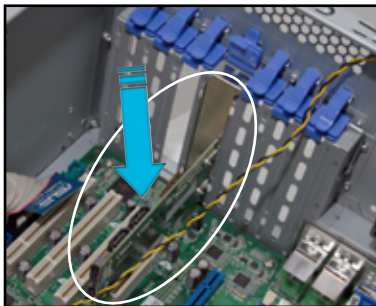

7. Restore the expansion card lock to its original position and push it down until you hear a click sound.

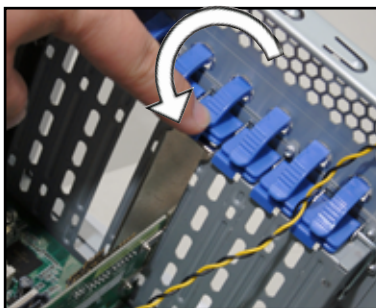

## 2.7.2 Configuring an expansion card

After installing the expansion card, configure it by adjusting the software settings.

1. Turn on the system and change the necessary BIOS settings, if any. See Chapter 4 for information on BIOS setup.
2. Assign an IRQ to the card. Refer to the tables on the next page.
3. Install the software drivers for the expansion card.



---

When using PCI cards on shared slots, ensure that the drivers support “Share IRQ” or that the cards do not need IRQ assignments. Otherwise, conflicts will arise between the two PCI groups, making the system unstable and the card inoperable. Refer to the table on the next page for details.

---



### 2.7.3 Interrupt assignments

| IRQ | Priority | Standard function            |
|-----|----------|------------------------------|
| 0   | 1        | System timer                 |
| 1   | 2        | Keyboard controller          |
| 2   | –        | Re-direct to IRQ#9           |
| 3   | 11       | IRQ holder for PCI steering* |
| 4   | 12       | Communications port (COM1)*  |
| 5   | 13       | IRQ holder for PCI steering* |
| 6   | 14       | Floppy disk controller       |
| 7   | 15       | IRQ holder for PCI steering* |
| 8   | 3        | System CMOS/Real Time Clock  |
| 9   | 4        | IRQ holder for PCI steering* |
| 10  | 5        | IRQ holder for PCI steering* |
| 11  | 6        | IRQ holder for PCI steering* |
| 12  | 7        | PS/2 compatible mouse port*  |
| 13  | 8        | Numeric data processor       |
| 14  | 9        | IRQ holder for PCI steering* |
| 15  | 10       | IRQ holder for PCI steering* |

\* These IRQs are usually available for PCI devices.

#### IRQ assignments for this motherboard

|                      | A      | B      | C      | D      | E | F      | G      | H      |
|----------------------|--------|--------|--------|--------|---|--------|--------|--------|
| PCI Slot 1           | Shared | –      | –      | –      | – | –      | –      | –      |
| PCI Slot 2           | –      | Shared | –      | –      | – | –      | –      | –      |
| LAN 1 (8056)         | –      | –      | Shared | –      | – | –      | –      | –      |
| LAN 2 (8056)         | –      | –      | –      | Shared | – | –      | –      | –      |
| SATA (Marvell)       | Shared | –      | –      | –      | – | –      | –      | –      |
| PCIe X16_1           | Shared | –      | –      | –      | – | –      | –      | –      |
| PCIe X16_2           | Shared | –      | –      | –      | – | –      | –      | –      |
| PCIe X1_1            | –      | Shared | –      | –      | – | –      | –      | –      |
| PCIX_1               | –      | Shared | –      | –      | – | –      | –      | –      |
| USB Controller 1     | –      | –      | –      | –      | – | –      | –      | Shared |
| USB Controller 2     | –      | –      | –      | Shared | – | –      | –      | –      |
| USB Controller 3     | –      | –      | Shared | –      | – | –      | –      | –      |
| USB Controller 4     | Shared | –      | –      | –      | – | –      | –      | –      |
| USB Controller 5     | Shared | –      | –      | –      | – | –      | –      | –      |
| USB Controller 6     | –      | –      | –      | –      | – | Shared | –      | –      |
| USB 2.0 Controller 1 | –      | –      | –      | –      | – | –      | –      | Shared |
| USB 2.0 Controller 2 | –      | –      | Shared | –      | – | –      | –      | –      |
| SATA Controller 1    | –      | –      | Shared | –      | – | –      | –      | –      |
| SATA Controller 2    | –      | –      | –      | –      | – | –      | Shared | –      |
| Azalia ALC888        | –      | –      | –      | –      | – | –      | Shared | –      |

## 2.8 Removing components

You may need to remove previously installed system components when installing or removing other system components, or when replacing a defective component. This section tells how to remove the following components:

1. Floppy disk drive (FDD)
2. System fan
3. SATA backplane

### 2.8.1 Removing the floppy disk drive

To remove the FDD

1. Disconnect the FDD power plug and signal cable.

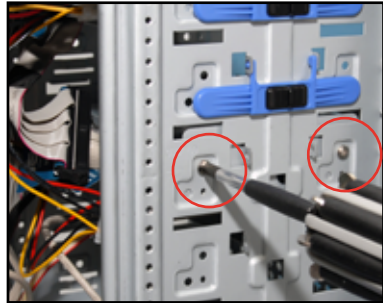

3. Carefully pull the FDD bay from the chassis.



4. Remove the four screws from the FDD bay to release the FDD.



## 2.8.2 Removing the system fan

To remove the system fan

1. Disconnect the chassis fan cable from the **CHA\_FAN1** connector on the motherboard.

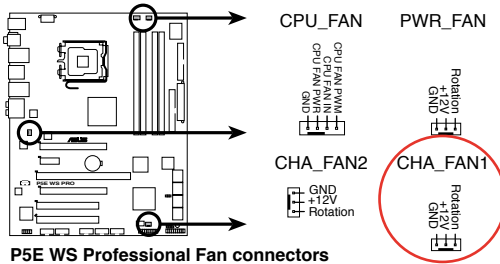

2. Locate and remove four system fan screws at the rear panel. Keep the screws for later use.



Hold the system fan with one hand while removing the system screws.

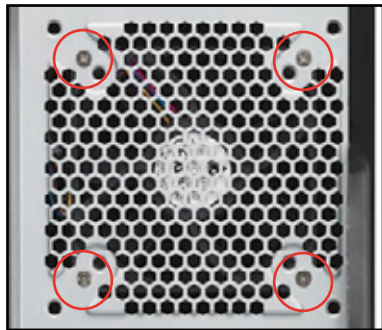

3. Remove the system fan, and then set aside.



## 2.8.3 Removing the SATA backplane

To remove the SATA backplane

1. Remove the right side cover first. Disconnect all SATA cables and power cables connected to the SATA backplane.



Remove all hard drives before removing the SATA backplane.

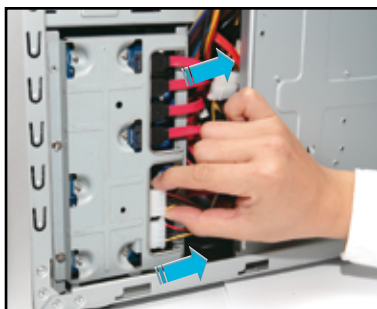

2. Remove all the six screws on the back of the SATA backplane holder with a screwdriver.

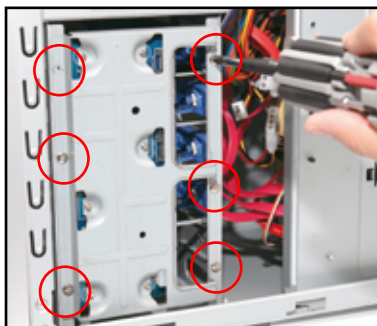

3. Take out the SATA backplane with the backplane holder and place on a flat surface. The TW300-E5/PI4 Workstation uses only the four SATA HDD connectors labelled DEVICE1-4.

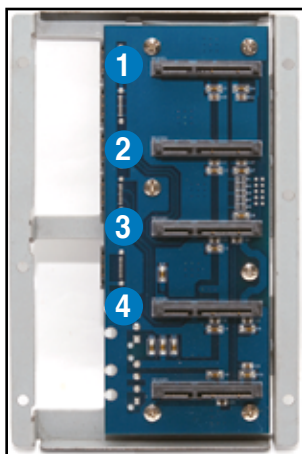

4. Remove all the six screws on the holder to replace the SATA backplane.

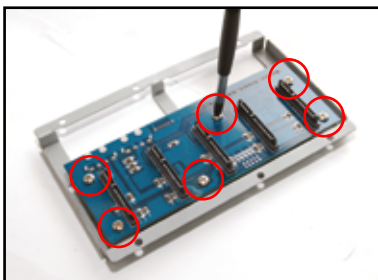

## 2.9 Connecting cables

The TW300-E5/PI4 chassis includes the power and signal cables that you need to connect to the motherboard, storage drives, and other devices that you intend to install.



- The bundled system cables are pre-connected before shipment. You do not need to disconnect these cables unless you will remove pre-installed components to install additional devices.
- Refer to Chapter 3 for detailed information on the connectors.



### Standard cables connected to the motherboard

- |                              |                             |
|------------------------------|-----------------------------|
| 1. 24-pin ATX 12V power plug | 5. IDE signal cable         |
| 2. 4-pin ATX 12V power plug  | 6. Serial ATA signal cables |
| 3. Card Reader cable         | 7. System panel cable       |
| 4. Front panel USB 2.0 cable | 8. System fan cable         |

# Chapter 3

This chapter gives information about the motherboard that comes with the workstation. This chapter includes the motherboard layout, jumper settings, and connector locations.



# 3.1 Motherboard layouts

## P5E WS Professional Motherboard

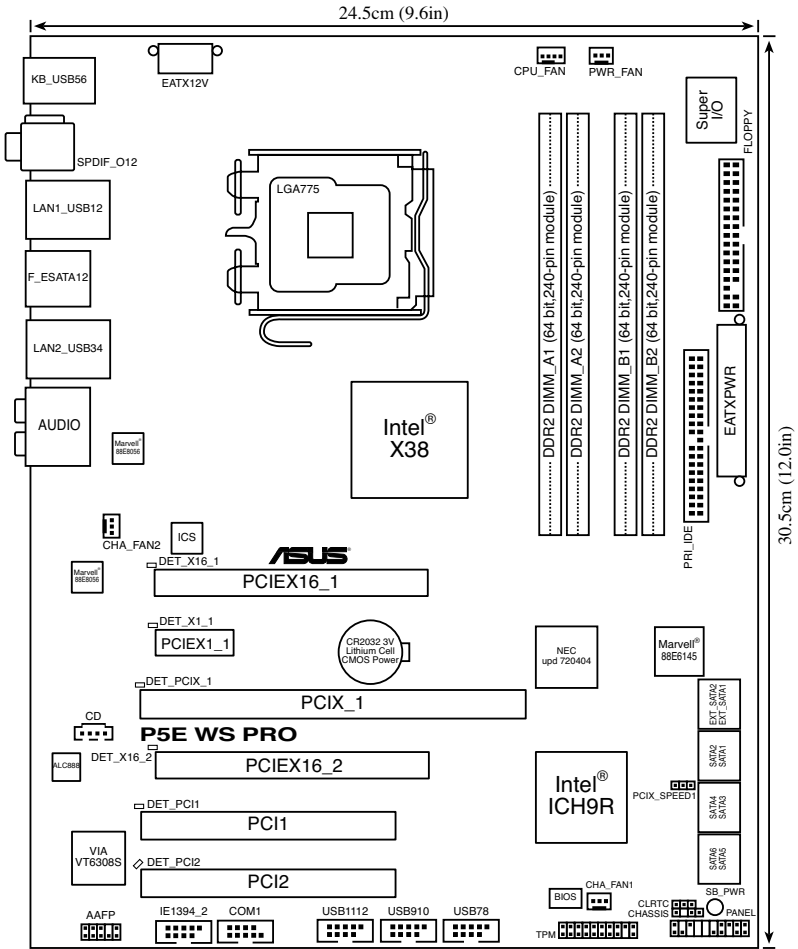

Refer to **3.3 Connectors** for more information about rear panel connectors and internal connectors.



## Onboard LED

The motherboard comes with a standby power LED that lights up to indicate that the system is ON, in sleep mode, or in soft-off mode. This is a reminder that you should shut down the system and unplug the power cable before removing or plugging in any motherboard component. The illustration below shows the location of the onboard LED.

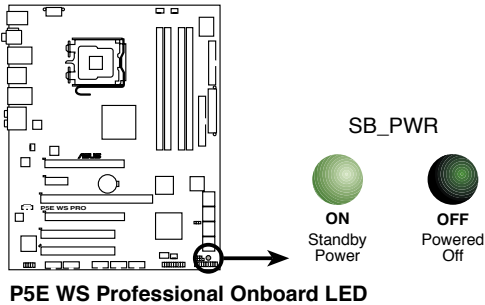

## AI Slot Detector

This motherboard comes with on-board LEDs that light up when the PCIE/PCI devices are not correctly installed. When the power cord is plugged in and the LED lights up, reinstall the device correctly. Refer to the figure on the right for the location of the LEDs.

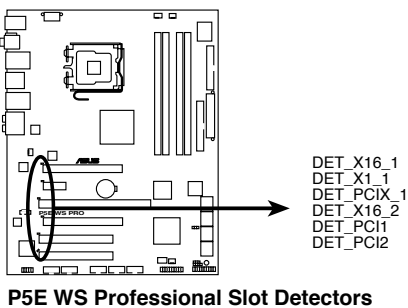

- The PCIeX16\_1-2 slots (blue) support PCIe x16 cards only. The AI Slot Detector lights up when you install x1 or x4 cards to these slots.
- When the AI Slot Detector lights up for incorrect installation, make sure to turn off the power supply unit before reinstalling the card to avoid electrical shock hazard.

## Layout contents

| Jumper                                     | Page |
|--|------|
| 1. Clear RTC RAM (3-pin CLRRTC_EN)         | 3-6  |
| 2. PCI-X Speed setting (3-pin PCIX_SPEED1) | 3-7  |

| Rear panel connectors             | Page |
|-----------------------------------|------|
| 1. PS/2 keyboard port (purple)    | 3-8  |
| 2. Coaxial S/PDIF Out port        | 3-8  |
| 3. LAN 1 (RJ-45) port             | 3-8  |
| 4. IEEE 1394a port                | 3-8  |
| 5. LAN 2 (RJ-45) port             | 3-8  |
| 6. Center/Subwoofer port (orange) | 3-8  |
| 7. Rear Speaker Out port (black)  | 3-8  |
| 8. Line In port (light blue)      | 3-8  |
| 9. Line Out port (lime)           | 3-8  |
| 10. Microphone port (pink)        | 3-9  |
| 11. Side Speaker Out port (gray)  | 3-9  |
| 12. USB 2.0 ports 3 and 4         | 3-9  |
| 13. External SATA ports           | 3-9  |
| 14. USB 2.0 ports 1 and 2         | 3-10 |
| 15. Optical S/PDIF Out port       | 3-10 |
| 16. USB 2.0 ports 5 and 6         | 3-10 |

| Internal connectors |   | Page |
|---------------------|---|------|
| 1.                  | Floppy disk drive connector (34-1 pin FLOPPY)   | 3-11 |
| 2.                  | IDE connector (40-1 pin PRI_IDE)  | 3-12 |
| 3.                  | ICH9R Serial ATA connectors [blue] (7-pin SATA1-6)                                      | 3-13 |
| 4.                  | Marvell® 88SE6145 Serial ATA RAID connectors [black] (7-pin EXT_SATA1-2)                | 3-14 |
| 5.                  | USB connectors (10-1 pin USB78, USB910, USB1112)  | 3-15 |
| 6.                  | IEEE 1394a port connector (10-1 pin IE1394_1)   | 3-15 |
| 7.                  | Optical audio drive connector (4-pin CD)  | 3-16 |
| 8.                  | Serial port connector (10-1 pin COM1)   | 3-16 |
| 9.                  | CPU, chassis, and power fan connectors (4-pin CPU_FAN, 3-pin CHA_FAN1-2, 3-pin PWR_FAN) | 3-17 |
| 10.                 | Chassis intrusion connector (4-1 pin CHASSIS)   | 3-17 |
| 11.                 | Front panel audio connector (10-1 pin AAFP)   | 3-18 |
| 12.                 | TPM connector (20-1 pin TPM)  | 3-18 |
| 13.                 | ATX power connectors (24-pin EATXPWR, 8-pin EATX12V)                                    | 3-19 |
| 14.                 | System panel connector (20-8-pin PANEL)   | 3-20 |
| 15.                 | ASUS Q-connector (system panel)   | 3-21 |

## 3.2 Jumpers

### 1. Clear RTC RAM (CLRRTC1)

This jumper allows you to clear the Real Time Clock (RTC) RAM in CMOS. You can clear the CMOS memory of date, time, and system setup parameters by erasing the CMOS RTC RAM data. The onboard button cell battery powers the RAM data in CMOS, which include system setup information such as system passwords.

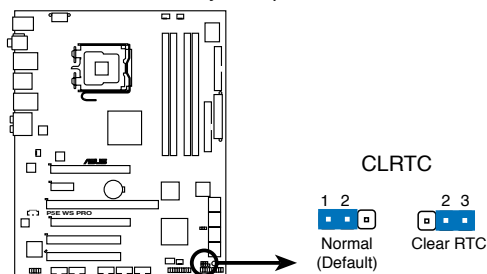

#### P5E WS Professional Clear RTC RAM

To erase the RTC RAM

1. Turn OFF the computer and unplug the power cord.
2. Move the jumper cap from pins 1–2 (default) to pins 2–3. Keep the cap on pins 2–3 for about 5–10 seconds, then move the cap back to pins 1–2.
3. Plug the power cord and turn ON the computer.
4. Hold down the <Del> key during the boot process and enter BIOS setup to re-enter data.



---

Except when clearing the RTC RAM, never remove the cap on CLRRTC jumper default position. Removing the cap will cause system boot failure!

---



---

If the steps above do not help, remove the onboard battery and move the jumper again to clear the CMOS RTC RAM data. After the CMOS clearance, reinstall the battery.

---

## 2. PCI-X Speed setting (3-pin PCIX\_SPEED1)

This jumper allows you to set the PCI-X slot's maximum frequency capability.

**The jumper cap on pins 1-2:** 133 MHz capability for the PCI-X slot.

**The jumper cap on pins 2-3:** 100 MHz capability for the PCI-X slot.

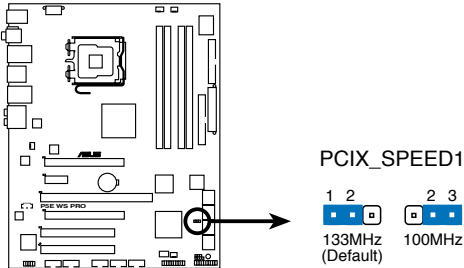

**P5E WS Professional PCIX speed setting**

## 3.3 Connectors

### 3.3.1 Rear panel connectors

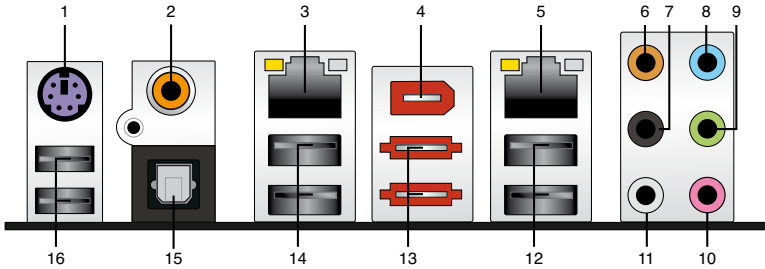

1. **PS/2 keyboard port (purple).** This port is for a PS/2 keyboard.
2. **Coaxial S/PDIF Out port.** This port connects an external audio output device via a coaxial S/PDIF cable.
3. **LAN1 (RJ-45) port.** Supported by Marvell® Gigabit LAN controller, this port allows Gigabit connection to a Local Area Network (LAN) through a network hub. Refer to the table below for the LAN port LED indications.
4. **IEEE1394a port.** This 6-pin IEEE 1394a port provides high-speed connectivity for audio/video devices, storage peripherals, PCs, or portable devices.
5. **LAN2 (RJ-45) port.** Supported by Marvell® Gigabit LAN controller, this port allows Gigabit connection to a Local Area Network (LAN) through a network hub. Refer to the table below for the LAN port LED indications.

#### LAN port LED indications

| Activity/Link LED |               | Speed LED |                     |
|-------------------|---------------|-----------|---------------------|
| Status            | Description   | Status    | Description         |
| OFF               | No link       | OFF       | 10 Mbps connection  |
| ORANGE            | Linked        | ORANGE    | 100 Mbps connection |
| BLINKING          | Data activity | GREEN     | 1 Gbps connection   |

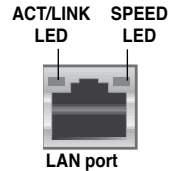

6. **Center/Subwoofer port (orange).** This port connects the center/subwoofer speakers.
7. **Rear Speaker Out port (black).** This port connects the rear speakers in a 4-channel, 6-channel, or 8-channel audio configuration.
8. **Line In port (light blue).** This port connects the tape, CD, DVD player, or other audio sources.
9. **Line Out port (lime).** This port connects a headphone or a speaker. In 4-channel, 6-channel, and 8-channel configuration, the function of this port becomes Front Speaker Out.

10. **Microphone port (pink).** This port connects a microphone.
11. **Side Speaker Out port (gray).** This port connects the side speakers in an 8-channel audio configuration.



Refer to the audio configuration table below for the function of the audio ports in 2, 4, 6, or 8-channel configuration.

### Audio 2, 4, 6, or 8-channel configuration

| Port       | Headset<br>2-channel | 4-channel         | 6-channel         | 8-channel         |
|------------|----------------------|-------------------|-------------------|-------------------|
| Light Blue | Line In              | Line In           | Line In           | Line In           |
| Lime       | Line Out             | Front Speaker Out | Front Speaker Out | Front Speaker Out |
| Pink       | Mic In               | Mic In            | Mic In            | Mic In            |
| Orange     | –                    | –                 | Center/Subwoofer  | Center/Subwoofer  |
| Black      | –                    | Rear Speaker Out  | Rear Speaker Ou   | Rear Speaker Out  |
| Gray       | –                    | –                 | –                 | Side Speaker Out  |

12. **USB 2.0 ports 3 and 4.** These two 4-pin Universal Serial Bus (USB) ports are available for connecting USB 2.0 devices.
13. **External SATA ports.** These ports connect to external Serial ATA hard disk drives. To configure a RAID 0, 1, 5 or 10 set, install an external Serial ATA hard disk drive to the external Serial ATA port and an internal Serial ATA hard disk drive to the onboard Serial ATA connectors labeled EXT\_SATA1 or EXT\_SATA2.



The external SATA ports support external Serial ATA 3.0 Gb/s devices. Longer cables support higher power requirements to deliver signal up to two meters away, and enables improved hot-swap function.

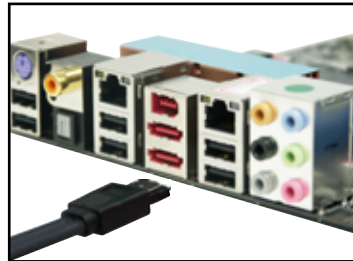

- Before creating a RAID set using Serial ATA hard disks, make sure that you have connected the Serial ATA signal cables and installed Serial ATA hard disk drives; otherwise, you cannot enter the Marvell RAID utility and SATA setup during POST.
- If you intend to create a RAID configuration using one of these connectors, set the **Marvell SATA/PATA Controller** item in the BIOS to [RAID Mode]. See section 4.5.3 **OnBoard Devices Configuration** for details.



- 
- DO NOT insert different connectors to these ports.
  - DO NOT unplug the external Serial ATA box when a RAID 0 or RAID 1 is configured.
- 

- 14. USB 2.0 ports 1 and 2 .** These two 4-pin Universal Serial Bus (USB) ports are available for connecting USB 2.0 devices.
- 15. Optical S/PDIF Out port.** This port connects an external audio output device via an optical S/PDIF cable.
- 16. USB 2.0 ports 5 and 6.** These two 4-pin Universal Serial Bus (USB) ports are available for connecting USB 2.0 devices.



### 3.3.2 Internal connectors

#### 1. Floppy disk drive connector (34–1 pin FLOPPY1)

This connector is for the provided Floppy Disk Drive (FDD) signal cable. Insert one end of the cable to this connector, then connect the other end to the signal connector at the back of the floppy disk drive.

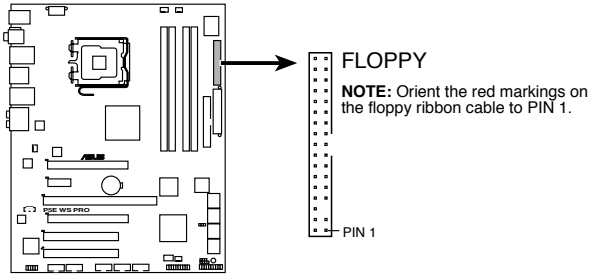

**P5E WS Professional Floppy disk drive connector**



---

Pin 5 on the connector is removed to prevent incorrect cable connection when using a FDD cable with a covered Pin 5.

---

## 2. IDE connector (40-1 pin PRI\_IDE)

The onboard IDE connector is for the Ultra DMA 133/100 signal cable. There are three connectors on each Ultra DMA 133/100 signal cable: blue, black, and gray. Connect the blue connector to the motherboard's IDE connector, then select one of the following modes to configure your device.

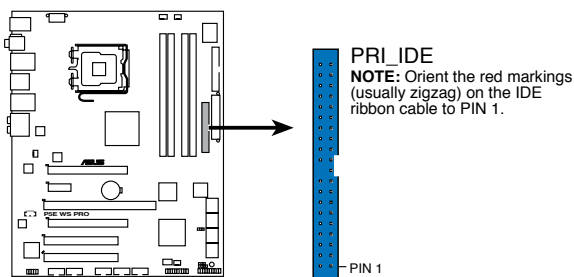

**P5E WS Professional IDE connector**

|               | Drive jumper setting   | Mode of device(s) | Cable connector |
|---------------|------------------------|-------------------|-----------------|
| Single device | Cable-Select or Master | -                 | Black           |
| Two devices   | Cable-Select           | Master            | Black           |
|               |                        | Slave             | Gray            |
|               | Master                 | Master            | Black or gray   |
|               | Slave                  | Slave             |                 |



- Pin 20 on the IDE connector is removed to match the covered hole on the Ultra ATA cable connector. This prevents incorrect insertion when you connect the IDE cable.
- Use the 80-conductor IDE cable for Ultra ATA 100/66/33 IDE devices.



If any device jumper is set as "Cable-Select," make sure all other device jumpers have the same setting.

### 3. ICH9R Serial ATA connectors [blue] (7-pin SATA1-6)

These connectors are for the Serial ATA signal cables for Serial ATA hard disk drives and optical disk drives.

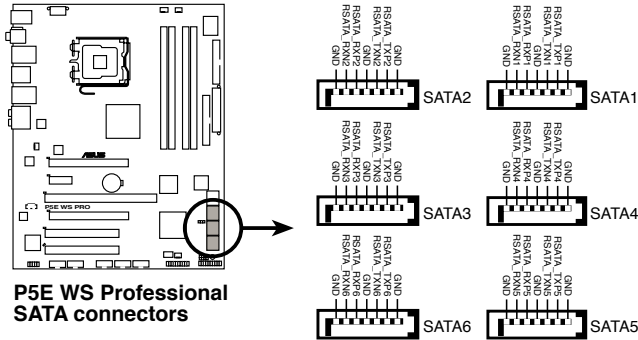

- When using the connectors in Standard IDE mode, connect the primary (boot) hard disk drive to the SATA1/2 connector. Refer to the table below for the recommended SATA hard disk drive connections.
- These connectors are set to Standard IDE mode by default. In Standard IDE mode, you can connect Serial ATA boot/data hard drives to these connectors. If you intend to create a Serial ATA RAID set using these connectors, set the Configure SATA as item in the BIOS to [RAID]. See section 4.3.6 SATA Configuration for details.
- Before creating a RAID set, refer to 5.1 RAID Configurations or the manual bundled in the motherboard support DVD.

### Serial ATA hard disk drive connection

| Connector | Color | Setting | Use            |
|-----------|-------|---------|----------------|
| SATA 1/2  | Blue  | Master  | Boot disk      |
| SATA 3/4  | Blue  | Slave   | Boot/Data disk |
| SATA 5/6  | Blue  | Master  | Boot disk      |



Connect the right-angle side of SATA signal cable to SATA device. Or you may connect the right-angle side of SATA cable to the onboard SATA port to avoid mechanical conflict with huge graphics cards.

Right angle side

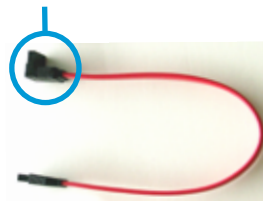

#### 4. Marvell® 88SE6145 Serial ATA RAID connectors [black] (7-pin EXT\_SATA1-2)

These connectors are for Serial ATA signal cables that support Serial ATA hard disk drives. To configure RAID 0, RAID 1, RAID 5 or RAID 10, install an internal Serial ATA hard disk drive to one of these connectors and an external Serial ATA drive to one of the external SATA ports.

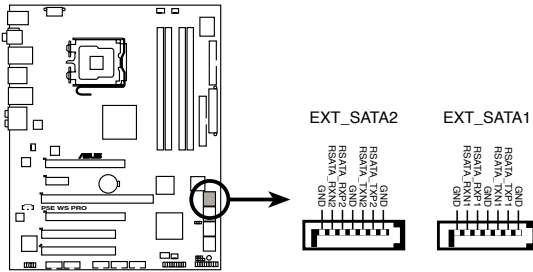

**P5E WS Professional EXT\_SATA connectors**



- Please install the Marvell® Controller driver before using the black Serial ATA RAID connectors (EXT\_SATA1-2). Refer to **6.2.4 Make Disk** menu for details.
- If you intend to create a RAID configuration using one of the Marvell® Serial ATA RAID connectors and one of the external SATA ports, it is strongly recommended to install the OS on the internal hard disk drive and use the external hard disk drive as a data disk.



Before creating a RAID set using Serial ATA hard disks, make sure that you have connected the Serial ATA signal cables and installed Serial ATA hard disk drives; otherwise, you cannot enter the Marvell RAID utility and SATA BIOS setup during POST.

## 5. USB connectors (10-1 pin USB78, USB910, USB1112)

These connectors are for USB 2.0 ports. Connect the USB module cable to any of these connectors, then install the module to a slot opening at the back of the system chassis. These USB connectors comply with USB 2.0 specification that supports up to 480 Mbps connection speed.

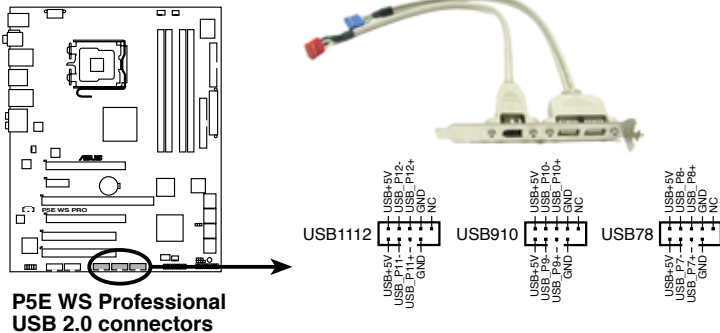

**P5E WS Professional  
USB 2.0 connectors**



Never connect a 1394 cable to the USB connectors. Doing so will damage the motherboard!



You can connect the USB cable to ASUS Q-Connector (USB, blue) first, and then install the Q-Connector (USB) to the USB connector onboard.

## 6. IEEE 1394a port connector (10-1 pin IE1394\_1)

This connector is for an IEEE 1394a port. Connect the IEEE 1394a module cable to this connector, then install the module to a slot opening at the back of the system chassis.

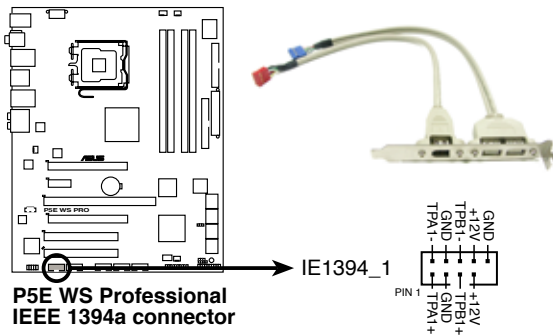

**P5E WS Professional  
IEEE 1394a connector**



Never connect a USB cable to the IEEE 1394a connector. Doing so will damage the motherboard!



You can connect the 1394 cable to ASUS Q-Connector (1394, red) first, and then install the Q-Connector (1394) to the 1394 connector onboard.

**7. Optical drive audio connector (4-pin CD)**

These connectors allow you to receive stereo audio input from sound sources such as a CD-ROM, TV tuner, or MPEG card.

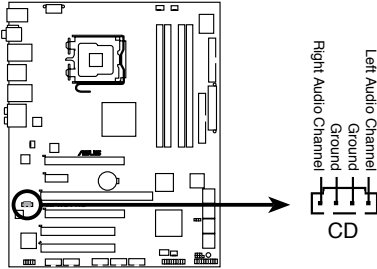

**P5E WS Professional Internal audio connector**

**8. Serial port connector (10-1 pin COM1)**

This connector is for a serial (COM) port. Connect the serial port module cable to this connector, then install the module to a slot opening at the back of the system chassis.

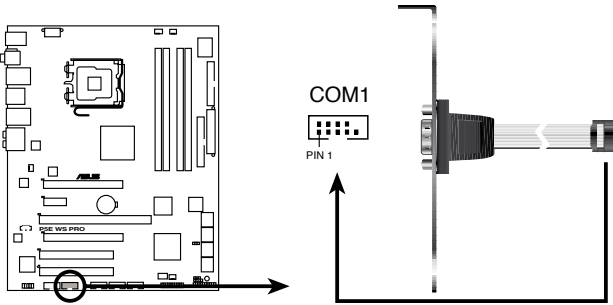

**P5E WS Professional COM port connector**

**9. CPU, chassis, and power fan connectors (4-pin CPU\_FAN, 3-pin CHA\_FAN1-2, 3-pin PWR\_FAN)**

The fan connectors support cooling fans of 350 mA~2000 mA (24 W max.) or a total of 1 A~7 A (84 W max.) at +12V. Connect the fan cables to the fan connectors on the motherboard, making sure that the black wire of each cable matches the ground pin of the connector.



Do not forget to connect the fan cables to the fan connectors. Insufficient air flow inside the system may damage the motherboard components. These are not jumpers! Do not place jumper caps on the fan connectors!

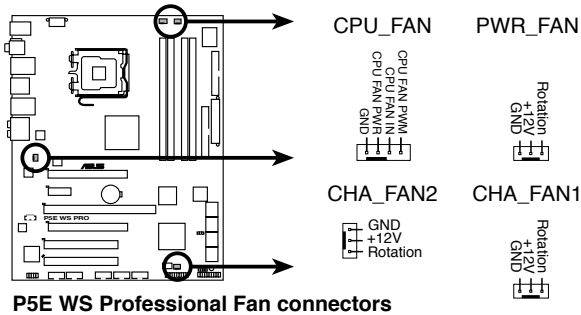

**P5E WS Professional Fan connectors**



Only the CPU-FAN and CHA-FAN 1-2 connectors support the ASUS Q-FAN 2 feature.

**10. Chassis intrusion connector (4-1 pin CHASSIS)**

This connector is for a chassis-mounted intrusion detection sensor or switch. Connect one end of the chassis intrusion sensor or switch cable to this connector. The chassis intrusion sensor or switch sends a high-level signal to this connector when a chassis component is removed or replaced. The signal is then generated as a chassis intrusion event.

By default, the pin labeled “Chassis Signal” and “Ground” are shorted with a jumper cap. Remove the jumper caps only when you intend to use the chassis intrusion detection feature.

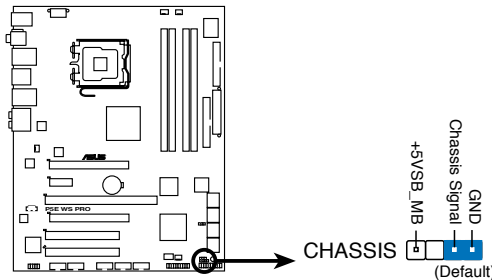

**P5E WS Professional Chassis intrusion connector**

## 11. Front panel audio connector (10-1 pin AAFP)

This connector is for a chassis-mounted front panel audio I/O module that supports either HD Audio or legacy AC`97 audio standard. Connect one end of the front panel audio I/O module cable to this connector.

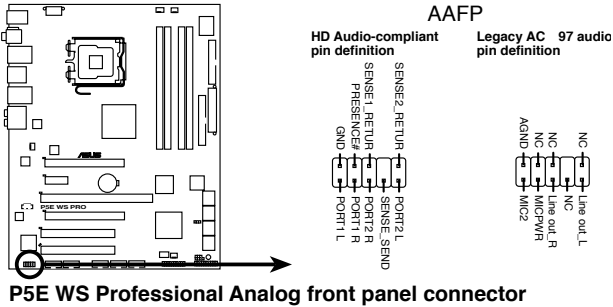

- We recommend that you connect a high-definition front panel audio module to this connector to avail of the motherboard's high-definition audio capability.
- By default, this connector is set to **[HD Audio]**. If you want to connect an **AC`97** front panel audio module to this connector, set the **Front Panel Type** item in the BIOS setup to **[AC`97]**. See section **4.5.3 Onboard Devices Configuration** for details.

## 12. TPM connector (20-1 pin TPM) [Optional]

This connector supports a Trusted Platform Module (TPM) system, which can securely store keys, digital certificates, passwords, and data. A TPM system also helps enhance network security, protects digital identities, and ensures platform integrity.

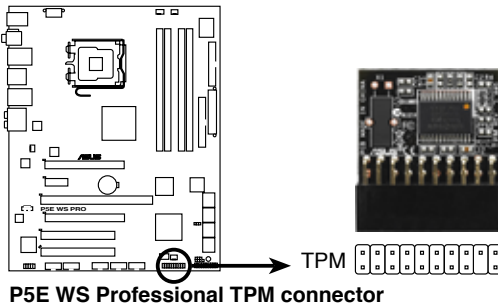



### 13. ATX power connectors (24-pin EATXPWR, 8-pin EATX12V)

These connectors are for ATX power supply plugs. The power supply plugs are designed to fit these connectors in only one orientation. Find the proper orientation and push down firmly until the connectors completely fit.

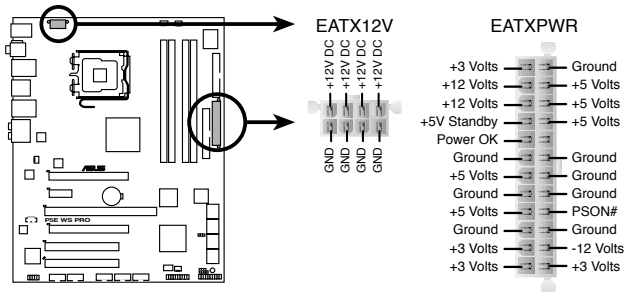

**P5E WS Professional ATX power connectors**



- For a fully configured system, we recommend that you use a power supply unit (PSU) that complies with ATX 12 V Specification 2.0 (or later version) and provides a minimum power of 400 W.
- Do not forget to connect the 8-pin EATX12V power plug; otherwise, the system will not boot.
- Use of a PSU with a higher power output is recommended when configuring a system with more power-consuming devices. The system may become unstable or may not boot up if the power is inadequate.
- If you want to use two high-end PCI Express x16 cards, use a PSU with 500W to 600W power or above to ensure the system stability.
- If you are uncertain about the minimum power supply requirement for your system, refer to the **Recommended Power Supply Wattage Calculator** at <http://support.asus.com/PowerSupplyCalculator/PSCalculator.aspx?SLanguage=en-us> for details.

## 14. System panel connector (20-8 pin PANEL)

This connector supports several chassis-mounted functions.

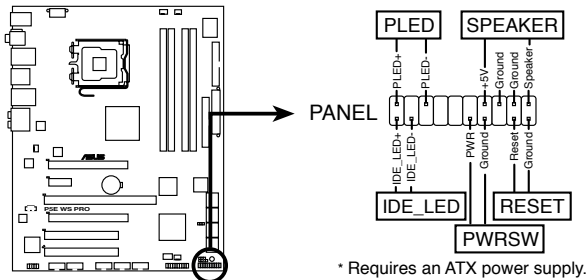

**P5E WS Professional System panel connector**

- **System power LED (2-pin PLED)**

This 2-pin connector is for the system power LED. Connect the chassis power LED cable to this connector. The system power LED lights up when you turn on the system power, and blinks when the system is in sleep mode.

- **Hard disk drive activity LED (2-pin IDE\_LED)**

This 2-pin connector is for the HDD Activity LED. Connect the HDD Activity LED cable to this connector. The IDE LED lights up or flashes when data is read from or written to the HDD.

- **System warning speaker (4-pin SPEAKER)**

This 4-pin connector is for the chassis-mounted system warning speaker. The speaker allows you to hear system beeps and warnings.

- **ATX power button/soft-off button (2-pin PWRSW)**

This connector is for the system power button. Pressing the power button turns the system on or puts the system in sleep or soft-off mode depending on the BIOS settings. Pressing the power switch for more than four seconds while the system is ON turns the system OFF.

- **Reset button (2-pin RESET)**

This 2-pin connector is for the chassis-mounted reset button for system reboot without turning off the system power.

## 15. Q-Connector (system panel)

You can use ASUS Q-Connector to connect / disconnect chassis front panel cables by only a few steps. Directions below shows how to install ASUS Q-Connector.

### Step1.

Connect correct front panel to ASUS Q-Connector first. You can refer to the marking on Q-Connector itself to know the detail pin definition.

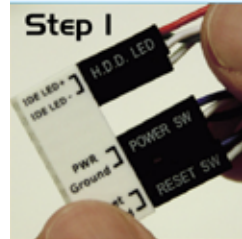

### Step2.

Properly install the ASUS Q-Connector to the System panel connector.



### Step3.

Front panel functions are enabled.

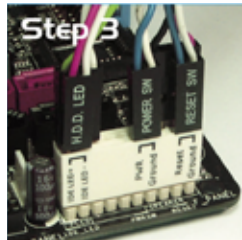



# Chapter 4

This chapter tells how to change system settings through the BIOS Setup menus and describes the BIOS parameters.



## 4.1 Managing and updating your BIOS

The following utilities allow you to manage and update the motherboard Basic Input/Output System (BIOS) setup.

1. **ASUS Update** (Updates the BIOS in Windows® environment.)
2. **ASUS EZ Flash 2** (Updates the BIOS using a floppy disk or USB flash disk.)
3. **ASUS AFUDOS** (Updates the BIOS using a bootable floppy disk.)
4. **ASUS CrashFree BIOS 3** (Updates the BIOS using a bootable floppy disk, USB flash disk or the motherboard support DVD when the BIOS file fails or gets corrupted.)

Refer to the corresponding sections for details on these utilities.



---

Save a copy of the original motherboard BIOS file to a bootable floppy disk or USB flash disk in case you need to restore the BIOS in the future. Copy the original motherboard BIOS using the ASUS Update or AFUDOS utilities.

---

### 4.1.1 ASUS Update utility

The ASUS Update is a utility that allows you to manage, save, and update the motherboard BIOS in Windows® environment. The ASUS Update utility allows you to:

- Save the current BIOS file
- Download the latest BIOS file from the Internet
- Update the BIOS from an updated BIOS file
- Update the BIOS directly from the Internet, and
- View the BIOS version information.

This utility is available in the support DVD that comes with the motherboard package.



---

ASUS Update requires an Internet connection either through a network or an Internet Service Provider (ISP).

---

### Installing ASUS Update

To install ASUS Update:

1. Place the support DVD in the optical drive. The Drivers menu appears.
2. Click the Utilities tab, then click Install ASUS Update VX.XX.XX.
3. The ASUS Update utility is copied to your system.



Quit all Windows® applications before you update the BIOS using this utility.

## Updating the BIOS through the Internet

To update the BIOS through the Internet:

1. Launch the ASUS Update utility from the Windows® desktop by clicking **Start > Programs > ASUS > ASUSUpdate > ASUSUpdate**. The ASUS Update main window appears.

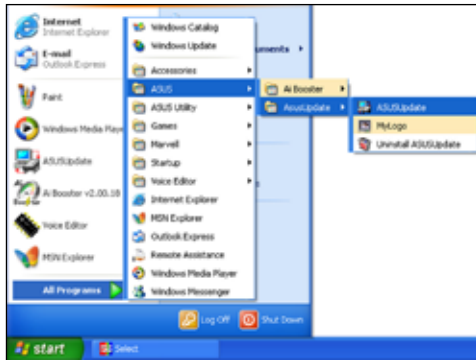

2. Select **Update BIOS** from the Internet option from the drop-down menu, then click **Next**.
3. Select the ASUS FTP site nearest you to avoid network traffic, or click **Auto Select**. Click **Next**.

- From the FTP site, select the BIOS version that you wish to download. Click **Next**.
- Follow the screen instructions to complete the update process.



The ASUS Update utility is capable of updating itself through the Internet. Always update the utility to avail all its features.



## Updating the BIOS through a BIOS file

To update the BIOS through a BIOS file:

- Launch the ASUS Update utility from the Windows® desktop by clicking **Start > Programs > ASUS > ASUSUpdate > ASUSUpdate**. The ASUS Update main window appears.
- Select Update BIOS from a file option from the drop-down menu, then click **Next**.



- Locate the BIOS file from the Open window, then click **Open**.
- Follow the screen instructions to complete the update process.

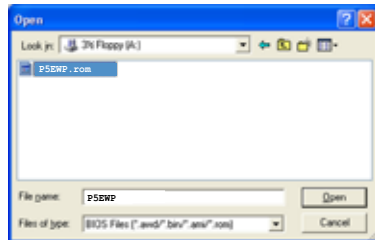



## 4.1.2 Creating a bootable floppy disk

1. Do either one of the following to create a bootable floppy disk.

### DOS environment

- a. Insert a 1.44MB floppy disk into the drive.
- b. At the DOS prompt, type *format a: /s* then press <Enter>.

### Windows® XP environment

- a. Insert a 1.44 MB floppy disk to the floppy disk drive.
- b. Click **Start** from the Windows® desktop, then select **My Computer**.
- c. Select the 3 1/2 Floppy Drive icon.
- d. Click File from the menu, then select **Format**. A **Format 3 1/2 Floppy Disk** window appears.
- e. Select **Create an MS-DOS startup disk** from the format options field, then click **Start**.

### Windows® Vista environment

- a. Insert a formatted, high density 1.44 MB floppy disk to the floppy disk drive.
  - b. Click  from the Windows® desktop, then select **Computer**.
  - c. Right-click **Floppy Disk Drive** then click **Format** to display the **Format 3 1/2 Floppy** dialog box .
  - d. Select the **Create an MS-DOS startup disk** check box.
  - e. Click **Start**.
2. Copy the original or the latest motherboard BIOS file to the bootable floppy disk.

### 4.1.3 ASUS EZ Flash 2 utility

The ASUS EZ Flash 2 feature allows you to update the BIOS without having to go through the long process of booting from a floppy disk and using a DOS-based utility. The EZ Flash 2 utility is built in the BIOS chip so it is accessible by pressing <Alt> + <F2> during the Power-On Self Tests (POST).

To update the BIOS using EZ Flash 2

1. Visit the ASUS website (www.asus.com) to download the latest BIOS file for the motherboard.
2. Save the BIOS file to a floppy disk or a USB flash disk, then restart the system.
3. You can launch the EZ Flash 2 by two methods.
  - (1) Insert the floppy disk / USB flash disk that contains the BIOS file to the floppy disk drive or the USB port.

Press <Alt> + <F2> during POST to display the following.

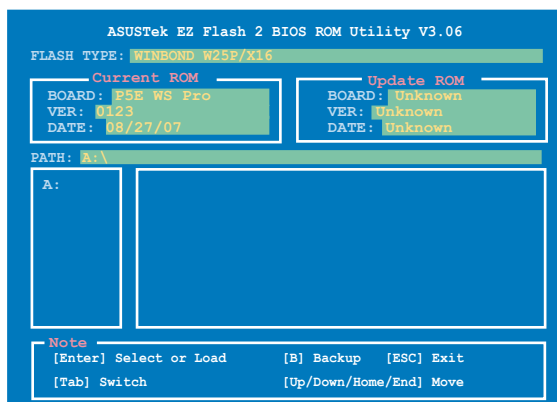

- (2) Enter BIOS setup program. Go to the **Tools** menu to select **EZ Flash 2** and press <Enter> to enable it.

You can switch between drives by pressing <Tab> before the correct file is found. Then press <Enter>.

4. When the correct BIOS file is found, EZ Flash 2 performs the BIOS update process and automatically reboots the system when done.



- This function can support devices such as a USB flash disk or a floppy disk with **FAT 32/16** format and single partition only.
- Do not shut down or reset the system while updating the BIOS to prevent system boot failure!

### 4.1.4 AFUDOS utility

The AFUDOS utility allows you to update the BIOS file in DOS environment using a bootable floppy disk with the updated BIOS file. This utility also allows you to copy the current BIOS file that you can use as backup when the BIOS fails or gets corrupted during the updating process.

#### Copying the current BIOS

To copy the current BIOS file using the AFUDOS utility:



- Make sure that the floppy disk is not write-protected and has at least 1024KB free space to save the file.
- The succeeding BIOS screens are for reference only. The actual BIOS screen displays may not be same as shown.

1. Copy the AFUDOS utility (afudos.exe) from the motherboard support DVD to the bootable floppy disk you created earlier.
2. Boot the system in DOS mode, then at the prompt type:

```
afudos /o[filename]
```

where the [filename] is any user-assigned filename not more than eight alphanumeric characters for the main filename and three alphanumeric characters for the extension name.

```
A:\>afudos /oOLDBIOS1.rom
```

Main filename    Extension name

3. Press <Enter>. The utility copies the current BIOS file to the floppy disk.

```
A:\>afudos /oOLDBIOS1.rom
AMI Firmware Update Utility - Version 1.19 (ASUS V2.07 (03.11.24BB))
Copyright (C) 2002 American Megatrends, Inc. All rights reserved.
Reading flash ..... done
Write to file..... ok
A:\>
```

The utility returns to the DOS prompt after copying the current BIOS file.

#### Updating the BIOS file

To update the BIOS file using the AFUDOS utility:

1. Visit the ASUS website ([www.asus.com](http://www.asus.com)) and download the latest BIOS file for the motherboard. Save the BIOS file to a bootable floppy disk.



---

Write the BIOS filename on a piece of paper. You need to type the exact BIOS filename at the DOS prompt.

---

2. Copy the AFUDOS utility (afudos.exe) from the motherboard support DVD to the bootable floppy disk you created earlier.
3. Boot the system in DOS mode, then at the prompt type:  
**afudos /i[filename]**

where [filename] is the latest or the original BIOS file on the bootable floppy disk.

```
A:\>afudos /iP5EWP.ROM
```

4. The utility verifies the file and starts updating the BIOS.

```
A:\>afudos /iP5EWP.ROM
AMI Firmware Update Utility - Version 1.19(ASUS V2.07(03.11.24BB))
Copyright (C) 2002 American Megatrends, Inc. All rights reserved.

WARNING!! Do not turn off power during flash BIOS
Reading file ..... done
Reading flash ..... done

Advance Check .....
Erasing flash ..... done
Writing flash ..... 0x0008CC00 (9%)
```



---

Do not shut down or reset the system while updating the BIOS to prevent system boot failure!

---

5. The utility returns to the DOS prompt after the BIOS update process is completed. Reboot the system from the hard disk drive.

```
A:\>afudos /iP5EWP.ROM
AMI Firmware Update Utility - Version 1.19(ASUS V2.07(03.11.24BB))
Copyright (C) 2002 American Megatrends, Inc. All rights reserved.

WARNING!! Do not turn off power during flash BIOS
Reading file ..... done
Reading flash ..... done

Advance Check .....
Erasing flash ..... done
Writing flash ..... done
Verifying flash .... done

Please restart your computer

A:\>
```

## 4.1.5 ASUS CrashFree BIOS 3 utility

The ASUS CrashFree BIOS 3 is an auto recovery tool that allows you to restore the BIOS file when it fails or gets corrupted during the updating process. You can update a corrupted BIOS file using the motherboard support DVD or the USB flash disk that contains the updated BIOS file.



Prepare the motherboard support DVD, the floppy disk or the USB flash disk containing the updated motherboard BIOS before using this utility.

### Recovering the BIOS from the support DVD

To recover the BIOS from the support DVD

1. Turn on the system.
2. Insert the motherboard support DVD to the optical drive.
3. The utility displays the following message and automatically checks the DVD for the BIOS file.

```
Bad BIOS checksum. Starting BIOS recovery...
Checking for floppy...
```

When found, the utility reads the BIOS file and starts flashing the corrupted BIOS file.

```
Bad BIOS checksum. Starting BIOS recovery...
Checking for floppy...
Floppy found!
Reading file "PSEWP.ROM". Completed.
Start flashing...
```

4. Restart the system after the utility completes the updating process.

### Recovering the BIOS from the USB flash disk

To recover the BIOS from the USB flash disk:

1. Insert the USB flash disk that contains the BIOS file to the USB port.
2. Turn on the system.
3. The utility will automatically checks the devices for the BIOS file. When found, the utility reads the BIOS file and starts flashing the corrupted BIOS file.
4. Restart the system after the utility completes the updating process.



- Only the USB flash disk with FAT 32/16 format and single partition can support ASUS CrashFree BIOS 3. The device size should be smaller than 8GB.
- DO NOT shut down or reset the system while updating the BIOS! Doing so can cause system boot failure!

## 4.2 BIOS setup program

This motherboard supports a programmable firmware chip that you can update using the provided utility described in section 4.1 **Managing and updating your BIOS**.

Use the BIOS Setup program when you are installing a motherboard, reconfiguring your system, or prompted to “Run Setup.” This section explains how to configure your system using this utility.

Even if you are not prompted to use the Setup program, you can change the configuration of your computer in the future. For example, you can enable the security password feature or change the power management settings. This requires you to reconfigure your system using the BIOS Setup program so that the computer can recognize these changes and record them in the CMOS RAM of the SPI chip.

The firmware chip on the motherboard stores the Setup utility. When you start up the computer, the system provides you with the opportunity to run this program. Press <Del> during the Power-On Self-Test (POST) to enter the Setup utility; otherwise, POST continues with its test routines.

If you wish to enter Setup after POST, restart the system by pressing <Ctrl+Alt+Delete>, or by pressing the reset button on the system chassis. You can also restart by turning the system off and then back on. Do this last option only if the first two failed.

The Setup program is designed to make it as easy to use as possible. Being a menu-driven program, it lets you scroll through the various sub-menus and make your selections from the available options using the navigation keys.



- 
- The default BIOS settings for this motherboard apply for most conditions to ensure optimum performance. If the system becomes unstable after changing any BIOS settings, load the default settings to ensure system compatibility and stability. Select the **Load Default Settings** item under the Exit Menu. See section 4.9 **Exit Menu**.
  - The BIOS setup screens shown in this section are for reference purposes only, and may not exactly match what you see on your screen.
  - Visit the ASUS website ([www.asus.com](http://www.asus.com)) to download the latest BIOS file for this motherboard.
-

## 4.2.1 BIOS menu screen

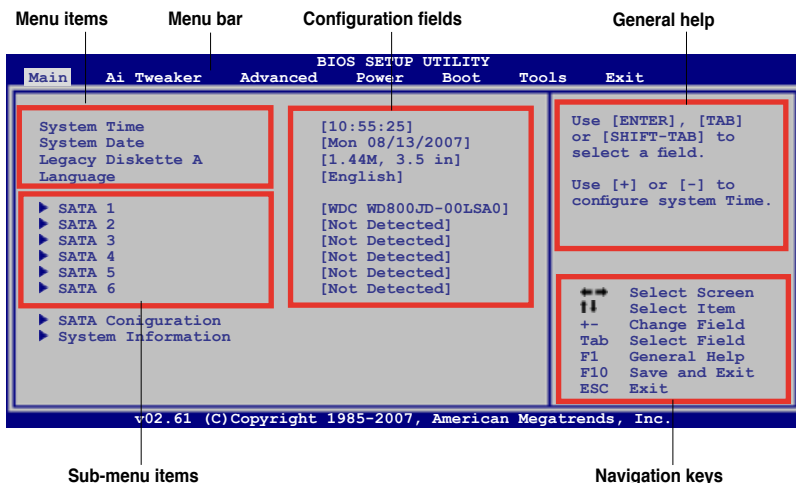

## 4.2.2 Menu bar

The menu bar on top of the screen has the following main items:

- |                   |  |
|-------------------|--|
| <b>Main</b>       | For changing the basic system configuration                    |
| <b>Ai Tweaker</b> | For changing the system performance settings                   |
| <b>Advanced</b>   | For changing the advanced system settings                      |
| <b>Power</b>      | For changing the advanced power management (APM) configuration |
| <b>Boot</b>       | For changing the system boot configuration                     |
| <b>Tools</b>      | For configuring special system functions                       |
| <b>Exit</b>       | For selecting the exit options and loading default settings    |

To select an item on the menu bar, press the right or left arrow key on the keyboard until the desired item is highlighted.

## 4.2.3 Navigation keys

At the bottom right corner of a menu screen are the navigation keys for that particular menu. Use the navigation keys to select items in the menu and change the settings.



Some of the navigation keys differ from one screen to another.

### 4.2.4 Menu items

The highlighted item on the menu bar displays the specific items for that menu. For example, selecting Main shows the Main menu items.

The other items (Advanced, Power, Boot, and Exit) on the menu bar have their respective menu items.

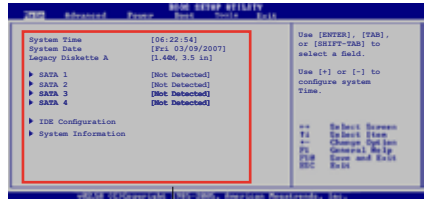

Main menu items

### 4.2.5 Sub-menu items

A solid triangle before each item on any menu screen means that the item has a sub-menu. To display the sub-menu, select the item and press <Enter>.

### 4.2.6 Configuration fields

These fields show the values for the menu items. If an item is user-configurable, you can change the value of the field opposite the item. You cannot select an item that is not user-configurable.

A configurable field is enclosed in brackets, and is highlighted when selected. To change the value of a field, select it then press <Enter> to display a list of options. Refer to 4.2.7 Pop-up window.

### 4.2.7 Pop-up window

Select a menu item then press <Enter> to display a pop-up window with the configuration options for that item.

### 4.2.8 Scroll bar

A scroll bar appears on the right side of a menu screen when there are items that do not fit on the screen. Press the Up/Down arrow keys or <Page Up> /<Page Down> keys to display the other items on the screen.



Pop-up window

Scroll bar

### 4.2.9 General help

At the top right corner of the menu screen is a brief description of the selected item.



## 4.3 Main menu

When you enter the BIOS Setup program, the Main menu screen appears, giving you an overview of the basic system information.



Refer to section **4.2.1 BIOS menu screen** for information on the menu screen items and how to navigate through them.

```

BIOS SETUP UTILITY
Main  Ai Tweaker  Advanced  Power  Boot  Tools  Exit

System Time           [10:55:25]
System Date           [Wed 08/22/2007]
Legacy Diskette A    [1.44M, 3.5 in]
Language              [English]

▶ SATA 1              [WDC WD800JD-00LSA0]
▶ SATA 2              [Not Detected]
▶ SATA 3              [Not Detected]
▶ SATA 4              [Not Detected]
▶ SATA 5              [Not Detected]
▶ SATA 6              [Not Detected]

▶ SATA Configuration
▶ System Information

Use [ENTER], [TAB] or [SHIFT-TAB] to select a field.

Use [+] or [-] to configure system Time.

*** Select Screen
!! Select Item
+- Change Field
Tab Select Field
F1 General Help
F10 Save and Exit
ESC Exit

v02.61 (C) Copyright 1985-2007, American Megatrends, Inc.
```

### 4.3.1 System Time [xx:xx:xx]

Allows you to set the system time.

### 4.3.2 System Date [Day xx/xx/xxxx]

Allows you to set the system date.

### 4.3.3 Legacy Diskette A [1.44M, 3.5 in.]

Sets the type of floppy drive installed.

Configuration options: [Disabled] [720K, 3.5 in.] [1.44M, 3.5 in.]

### 4.3.4 Language [English]

Allows you to choose the BIOS language version from the options. Configuration options: [Chinese BIG5] [Chinese (GB)] [Japanese] [Français] [German] [English]

### 4.3.5 SATA 1~6

While entering Setup, the BIOS automatically detects the presence of IDE devices. There is a separate sub-menu for each IDE device. Select a device item then press <Enter> to display the IDE device information.

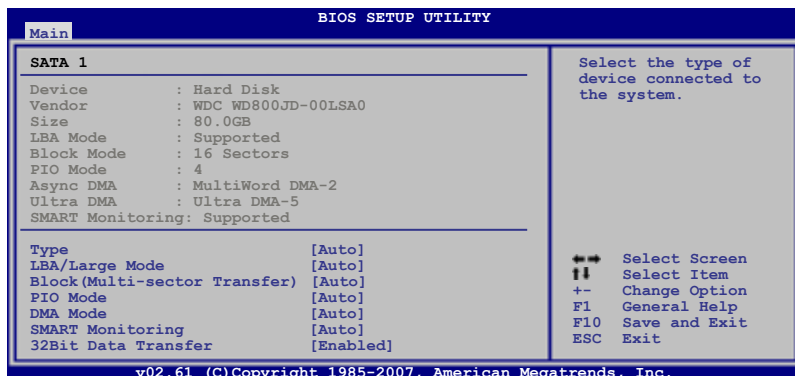

The BIOS automatically detects the values opposite the dimmed items (Device, Vendor, Size, LBA Mode, Block Mode, PIO Mode, Async DMA, Ultra DMA, and SMART monitoring). These values are not user-configurable. These items show Not Detected if no IDE device is installed in the system.

#### Type [Auto]

Selects the type of IDE drive. Setting to [Auto] allows automatic selection of the appropriate IDE device type. Select [CDROM] if you are specifically configuring a CD-ROM drive. Select [ARMD] (ATAPI Removable Media Device) if your device is either a ZIP, LS-120, or MO drive.

Configuration options: [Not Installed] [Auto] [CDROM] [ARMD]

#### LBA/Large Mode [Auto]

Enables or disables the LBA mode. Setting to [Auto] enables the LBA mode if the device supports this mode, and if the device was not previously formatted with LBA mode disabled. Configuration options: [Disabled] [Auto]

#### Block (Multi-sector Transfer) [Auto]

Enables or disables data multi-sectors transfers. When set to [Auto], the data transfer from and to the device occurs multiple sectors at a time if the device supports multi-sector transfer feature. When set to [Disabled], the data transfer from and to the device occurs one sector at a time.

Configuration options: [Disabled] [Auto]

#### PIO Mode [Auto]

Selects the PIO mode.

Configuration options: [Auto] [0] [1] [2] [3] [4]

## DMA Mode [Auto]

Selects the DMA mode. Configuration options: [Auto] [SWDMA0] [SWDMA1] [SWDMA2] [MWDMA0] [MWDMA1] [MWDMA2] [UDMA0] [UDMA1] [UDMA2] [UDMA3] [UDMA4] [UDMA5]

## SMART Monitoring [Auto]

Sets the Smart Monitoring, Analysis, and Reporting Technology. Configuration options: [Auto] [Disabled] [Enabled]

## 32Bit Data Transfer [Enabled]

Enables or disables 32-bit data transfer. Configuration options: [Disabled] [Enabled]

## 4.3.6 SATA Configuration

The items in this menu allow you to set or change the configurations for the SATA devices installed in the system. Select an item then press <Enter> if you want to configure the item.

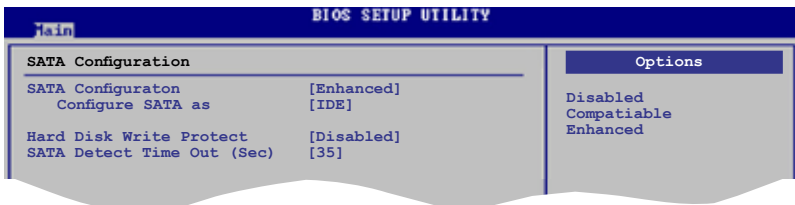

## SATA Configuration [Enhanced]

Configuration options: [Disabled] [Compatible] [Enhanced]

### Configure SATA as [IDE]

Sets the configuration for the Serial ATA connectors supported by the Southbridge chip.

Configuration options: [IDE] [RAID] [AHCI]



- If you want to use the Serial ATA hard disk drives as Parallel ATA physical storage devices, keep the default setting [IDE].
- If you want the Serial ATA hard disk drives to use the Advanced Host Controller Interface (AHCI), set this item to [AHCI]. The AHCI allows the onboard storage driver to enable advanced Serial ATA features that increases storage performance on random workloads by allowing the drive to internally optimize the order of commands.
- If you want to create a RAID 0, RAID 1, RAID 5, RAID 10, or the Intel® Matrix Storage Technology configuration from the Serial ATA hard disk drives, set this item to [RAID].

## Hard Disk Write Protect [Disabled]

Disables or enables device write protection. This will be effective only if device is accessed through BIOS Configuration option: [Disabled] [Enabled]

## SATA Detect Time Out (Sec) [35]

Selects the time out value for detecting ATA/ATAPI devices.  
Configuration options: [0] [5] [10] [15] [20] [25] [30] [35]

### 4.3.7 AHCI Configuration

This menu is the section for AHCI configuration. It appears only when you set the **Configure SATA as** item from the sub-menu of **SATA Configuration** to [AHCI].

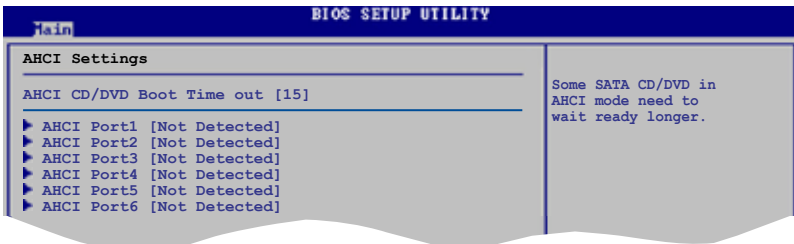

## AHCI CD/DVD Boot Time out [15]

Selects the boot time out value for AHCI CD/DVD devices.  
Configuration options: [0] [5] [10] [15] [20] [25] [30] [35]

## AHCI Port1~6 [XXXX]

Displays the status of auto-detection of SATA devices.

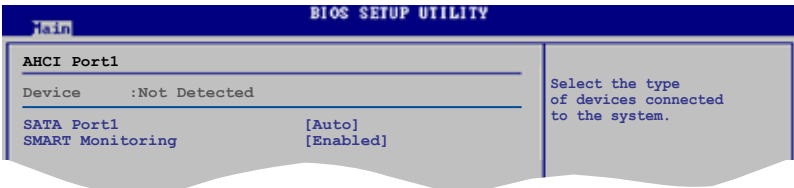

### SATA Port1 [Auto]

Allows you to select the type of device connected to the system.  
Configuration options: [Auto] [Not Installed]

### SMART Monitoring [Enabled]

Allows you to set the Self-Monitoring, Analysis and Reporting Technology.  
Configuration options: [Disabled] [Enabled]

### 4.3.8 System Information

This menu gives you an overview of the general system specifications. The BIOS automatically detects the items in this menu.

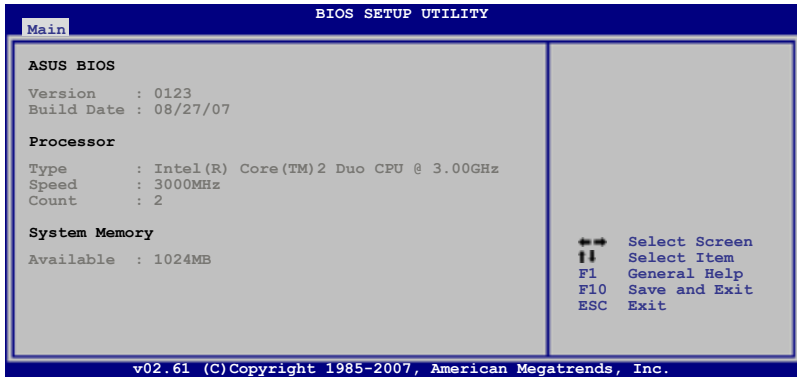

#### ASUS BIOS

Displays the auto-detected BIOS information.

#### Processor

Displays the auto-detected CPU specification.

#### System Memory

Displays the auto-detected system memory.

## 4.4 Ai Tweaker menu

The Ai Tweaker menu items allow you to change the settings for the system performance.



Take caution when changing the settings of the Ai Tweaker menu items. Incorrect field values can cause the system to malfunction.

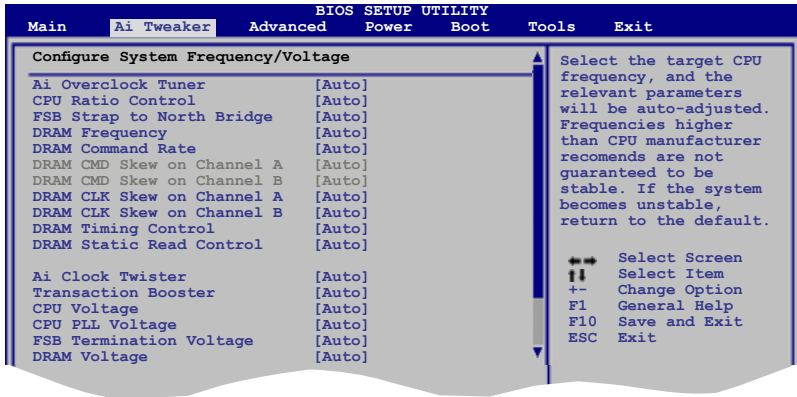

Scroll down to display the following items:



### 4.4.1 Ai Overclock Tuner [Auto]

Allows selection of CPU overclocking options to achieve desired CPU internal frequency. Select one of the preset overclocking configuration options:

|               |   |
|---------------|---|
| <b>Manual</b> | Allows you to individually set overclocking parameters.   |
| <b>Auto</b>   | Loads the optimal settings for the system.  |
| <b>N.O.S.</b> | The ASUS Non-delay Overclocking System feature intelligently determines the system load and automatically boosts the performance for the most demanding tasks.  |
| <b>X.M.P.</b> | If you install memory module(s) supporting the eXtreme Memory Profile (X.M.P.) Technology, choose this item to set the profile(s) supported by your memory module(s) for optimizing the system performance. |



The following sub-item only appears when you set the **Ai Overclock Tuner** item to [N.O.S].

#### N.O.S. Mode [Auto]

Allows you to set the Non-Delay Overclocking System mode.

Configuration options: [Auto] [Standard] [Sensitive] [Heavy Load]

#### Turbo N.O.S. [Overclock 3%]

This sub-item appears only when you set the **N.O.S. Mode** item to either [Standard], [Sensitive], or [Heavy Load]. Allows you to set the maximum overclock percentage for the selected N.O.S. mode.

Configuration options: [Overclock 3%] [Overclock 5%] [Overclock 10%] [Overclock 15%] [Overclock 20%] [Overclock 30%]



The configuration options for the following sub-item vary depending on the DIMMs you install on the motherboard.

#### eXtreme Memory Profile [Disabled]

This item appears only when you set the **Ai Overclock Tuner** item to [X.M.P.]. Allows you to select the X.M.P. mode supported by your Memory module.

Configuration options: [Disabled] [Profile #1] [Profile #2]

### 4.4.2 CPU Ratio Control [Auto]

This item allows you to set the ratio between CPU Core Clock and FSB Frequency. The value is adjusted by typing the desired values using the numeric keypad and press the <Enter> key. You can also use the <+> and <-> keys to adjust the value. To restore the default setting, type [auto] using the keyboard and press the <Enter> key.

Configuration options: [Auto] [06.0]–[31.0]

### 4.4.3 FSB Strap to North Bridge [Auto]

When set to [Auto], the FSB Strap will be adjusted automatically by FSB Frequency and DRAM Frequency.

Configuration options: [Auto] [200MHz] [266MHz] [333MHz]



The following item appears only when you set the **Ai Overclock Tuner** item to [Manual].

### FSB Frequency [XXX]

Displays the frequency sent by the clock generator to the system bus and PCI bus. The value of this item is auto-detected by the BIOS. Use the <+> and <-> keys to adjust the FSB frequency. You can also type the desired CPU frequency using the numeric keypad. The values range from 200 to 800. Refer to the table below for the correct Front Side Bus and CPU External Frequency settings.

#### FSB/CPU External Frequency Synchronization

| Front Side Bus | CPU External Frequency |
|----------------|------------------------|
| FSB 1333       | 333 MHz                |
| FSB 1066       | 266 MHz                |
| FSB 800        | 200 MHz                |



---

The following item appears only when you set the **Ai Overclock Tuner** item to [Manual], [N.O.S.] and [X.M.P.].

---

## **PCIe Frequency [Auto]**

Allows you to set the PCI Express frequency. Use the <+> and <-> keys to adjust the PCIe frequency. The values range from 100 to 150.

### **4.4.4 DRAM Frequency [Auto]**

Allows you to set the DDR2 operating frequency.

Configuration options: [Auto] [DDR2-667MHz] [DDR2-800MHz] [DDR2-835MHz] [DDR2-1002MHz] [DDR2-1066MHz] [DDR2-1111MHz] [DDR2-133MHz] [DDR2-\*1200 MHz\*]



---

The DRAM Frequency configuration options vary with the FSB Frequency settings.

---



---

Selecting a very high DRAM frequency may cause the system to become unstable! If this happens, revert to the default setting.

---

### **4.4.5 DRAM Command Rate [Auto]**

Configuration options: [Auto] [1T] [2T]

### **4.4.6 DRAM CMD Skew on Channel A/B [Auto]**

These items are adjustable only when you set the DRAM Command Rate item to [1T] and may help enhancing DRAM stability on 1T mode.

Configuration options: [Auto] [Advance 175ps] [Advance 150ps] [Advance 125ps] [Advance 100ps] [Advance 75ps] [Advance 50ps] [Advance 25ps] [Normal] [Delay 25ps] [Delay 50ps] [Delay 75ps] [Delay 100ps] [Delay 125ps] [Delay 150ps] [Delay 175ps]

### **4.4.7 DRAM CLK Skew on Channel A/B [Auto]**

Adjusting these items may help enhancing DRAM overclocking ability.

Configuration options: [Auto] [Advance 350ps] [Advance 300ps] [Advance 250ps] [Advance 200ps] [Advance 150ps] [Advance 100ps] [Advance 50ps] [Normal] [Delay 50ps] [Delay 100ps] [Delay 150ps] [Delay 200ps] [Delay 250ps] [Delay 300ps] [Delay 350ps]

### **4.4.8 DRAM Timing Control [Auto]**

Configuration options: [Auto] [Manual]





- The following sub-items appear only when you set the DRAM Timing Control item to [Manual].
- The configuration options for some of the following items vary depending on the DIMMs you install on the motherboard.

CAS# Latency [ 5 DRAM Clocks]

Configuration options: [3 DRAM Clocks] [4 DRAM Clocks] [5 DRAM Clocks] [6 DRAM Clocks] [7 DRAM Clocks]

RAS# to CAS# Delay [ 5 DRAM Clocks]

Configuration options: [3 DRAM Clocks] [4 DRAM Clocks]~[17 DRAM Clocks] [18 DRAM Clocks]

RAS# Precharge [ 5 DRAM Clocks]

Configuration options: [3 DRAM Clocks] [4 DRAM Clocks]~[17 DRAM Clocks] [18 DRAM Clocks]

RAS# Active Time [15 DRAM Clocks]

Configuration options: [3 DRAM Clocks] [4 DRAM Clocks]~[33 DRAM Clocks] [34 DRAM Clocks]

RAS# to RAS# Delay [Auto]

Configuration options: [Auto] [1 DRAM Clocks]~[15 DRAM Clocks]

Row Refresh Cycle Time [Auto]

Configuration options: [Auto] [20 DRAM Clocks] [25 DRAM Clocks] [30 DRAM Clocks] [35 DRAM Clocks] [42 DRAM Clocks]

Write Recovery Time [Auto]

Configuration options: [Auto] [1 DRAM Clocks]~[15 DRAM Clocks]

Write to Read Delay [Auto]

Configuration options: [Auto] [1 DRAM Clocks]~[15 DRAM Clocks]

Read to Precharge Time [Auto]

Configuration options: [Auto] [1 DRAM Clocks]~[15 DRAM Clocks]

#### **4.4.9 DRAM Static Read Control [Auto]**

Configuration options: [Auto] [Disabled] [Enabled]

#### **4.4.10 Ai Clock Twister [Auto]**

Allows you to set the DRAM performance. Set this item to [Light] to enhance DRAM compatibility, or [Strong] to enhance DRAM performance.

Configuration options: [Auto] [Moderate] [Light] [Strong]

#### 4.4.11 Transaction Booster [Auto]

Allows you to set the system performance.

Configuration options: [Auto] [Disabled] [Enabled]

##### Relax Level [1]

This sub-item appears only when you set the **Transaction Booster** item to [Disabled]. Set this item to a higher level to get better compatibility. Use the <+> and <-> keys to adjust the value. The values range from 1 to 4.

##### Boost Level [1]

This sub-item appears only when you set the **Transaction Booster** item to [Enabled]. Set this item to a higher level to get better performance. Use the <+> and <-> keys to adjust the value. The values range from 1 to 8.



---

The following seven items on the next page appear only when you set the **Ai Overclock Tuner** item to [Manual] and [X.M.P.] and are adjusted by typing the desired values using the numeric keypad and press the <Enter> key. Use the <+> and <-> keys to adjust the value. To restore the default setting, type [auto] using the keyboard and press the <Enter> key.

---

#### 4.4.12 CPU Voltage [Auto]

Allows you to set the CPU VCore voltage. The values range from 0.85000V to 1.70000V with a 0.00625V interval.



---

Refer to the CPU documentation before setting the CPU Vcore voltage. Setting a high VCore voltage may damage the CPU permanently, and setting a low VCore voltage may make the system unstable.

---

#### 4.4.13 CPU PLL Voltage [Auto]

Allows you to set the CPU PLL voltage. The values range from 1.00V to 2.30V with a 0.02V interval.

#### 4.4.14 FSB Termination Voltage [Auto]

Allows you to set the front side bus termination voltage. The values range from 1.20V to 1.50V with a 0.02V interval.

#### 4.4.15 DRAM Voltage [Auto]

Allows you to set the DRAM voltage. The values range from 1.80V to 3.00V with a 0.02V interval.

#### 4.4.16 North Bridge Voltage [Auto]

Allows you to set the North Bridge voltage. The values range from 1.25V to 1.91V with a 0.02V interval.



- Setting the CPU PLL Voltage, FSB Termination Voltage, DRAM Voltage and North Bridge Voltage to a high level may damage the chipset, memory module, and CPU permanently. Proceed with caution.
- Some values of the CPU PLL Voltage, FSB Termination Voltage, DRAM Voltage and North Bridge Voltage items are labeled in different color, indicating the risk levels of high voltage settings. Refer to the table below for details.
- The system may need better cooling system to work stably under high voltage settings.

|                         | Blue        | Yellow      | Purple      | Red         |
|-------------------------|-------------|-------------|-------------|-------------|
| CPU PLL Voltage         | 1.50V~1.78V | 1.80V~2.00V | 2.02V~2.20V | 2.22V~2.30V |
| FSB Termination Voltage | 1.20V~1.38V | 1.40V~1.50V | N/A         | N/A         |
| DRAM Voltage            | 1.80V~1.86V | 1.88V~1.92V | 1.94V~2.50V | 2.52V~3.00V |
| North Bridge Voltage    | 1.25V~1.41V | 1.43V~1.55V | 1.57V~1.73V | 1.75V~1.91V |

#### 4.4.17 South Bridge Voltage [Auto]

Allows you to set the South Bridge voltage. The values range from 1.05V to 1.15V with a 0.10V interval.

#### 4.4.18 Clock Over-Charging Voltage [Auto]

Allows you to set the Clock Over-Charging voltage. The values range from 0.70V to 1.00V with a 0.10V interval.



The following three items appear only when you set the **Ai Overclock Tuner** item to [Manual], [N.O.S.], and [X.M.P.].

#### CPU Voltage Damper [Auto]

Allows you to enable or disable the CPU voltage damper.  
Configuration options: [Auto] [Disabled] [Enabled]

#### CPU Voltage Reference [Auto]

Configuration options: [Auto] [0.63x] [0.615x] [0.65x] [0.67x]

#### North Bridge Voltage Reference [Auto]

Configuration options: [Auto] [0.67x] [0.61x]

#### 4.4.19 CPU Spread Spectrum [Auto]

Allows you to disable or set to auto the CPU clock spread spectrum.  
Configuration options: [Auto] [Disabled]

#### **4.4.20 PCIE Spread Spectrum [Auto]**

Allows you to disable or set to auto the PCI Express clock spread spectrum.

Configuration options: [Auto] [Disabled]

## 4.5 Advanced menu

The Advanced menu items allow you to change the settings for the CPU and other system devices.



Take caution when changing the settings of the Advanced menu items. Incorrect field values can cause the system to malfunction.

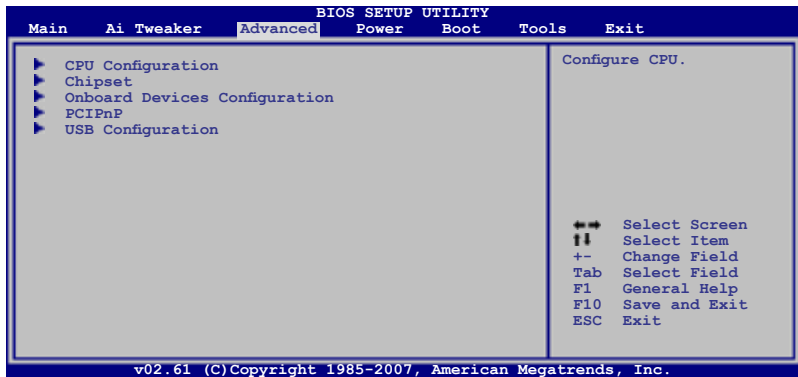

### 4.5.1 CPU Configuration

The items in this menu show the CPU-related information that the BIOS automatically detects.

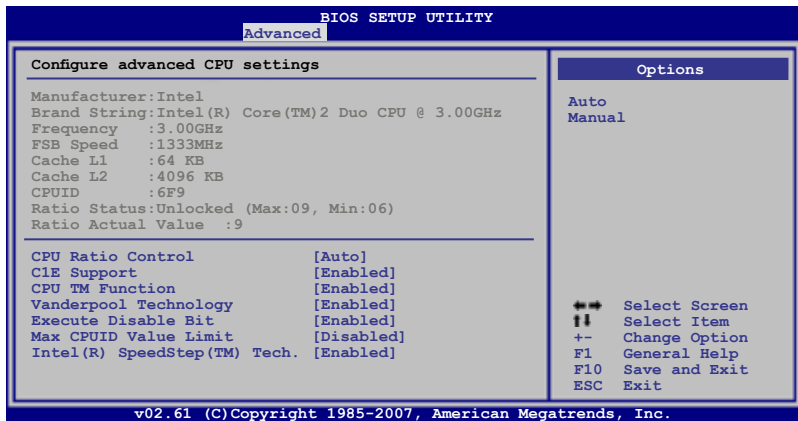

### **CPU Ratio Control [Auto]**

This item allows you to set the ratio between CPU Core Clock and FSB Frequency. The value is adjusted by typing the desired values using the numeric keypad and press the <Enter> key. You can also use the <+> and <-> keys to adjust the value. To restore the default setting, type [auto] using the keyboard and press the <Enter> key.

Configuration options: [Auto] [06.0]–[31.0]

### **C1E Support [Enabled]**

Allows you to enable or disable Enhanced Halt State support.

Configuration options: [Disabled] [Enabled]

### **CPU TM Function [Enabled]**

This function enables the overheated CPU to throttle the clock speed to cool down.

Configuration options: [Disabled] [Enabled]

### **Vanderpool Technology [Enabled]**

The Vanderpool Technology allows a hardware platform to run multiple operating systems separately and simultaneously, enabling one system to virtually function as several systems.

Configuration options: [Disabled] [Enabled]

### **Execute Disable Bit [Enabled]**

Allows you to enable or disable the No-Execution Page Protection Technology.

Setting this item to [Disabled] forces the XD feature flag to always return to zero (0).

Configuration options: [Disabled] [Enabled]

### **Max CPUID Value Limit [Disabled]**

Setting this item to [Enabled] allows legacy operating systems to boot even without support for CPUs with extended CPUID functions.

Configuration options: [Disabled] [Enabled]



---

The following item appears only when you set the **CPU Ratio Control** to [Auto]

---

### **Intel(R) SpeedStep (TM) Tech. [Disabled]**

When set to [Disabled], the CPU runs at its default speed. When set to [Enabled], the CPU speed is controlled by the operating system.

Configuration options: [Enabled] [Disabled]

## 4.5.2 Chipset

The Chipset menu allows you to change the advanced chipset settings. Select an item then press <Enter> to display the sub-menu.

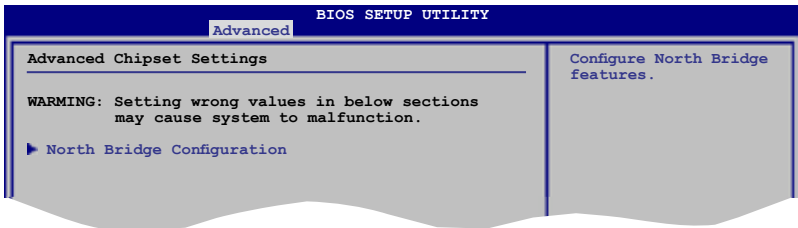

### North Bridge Configuration

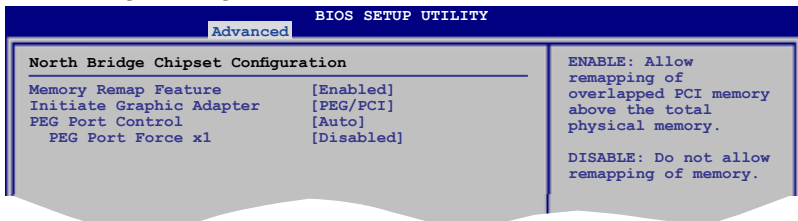

#### Memory Remap Feature [Enabled]

Allows you to enabled or disable the remapping of the overlapped PCI memory above the total physical memory. Enable this option only when you install 64-bit operating system. Configuration options: [Disabled] [Enabled]

#### Initiate Graphic Adapter [PEG/PCI]

Allows you to decide which graphics controller to use as the primary boot device. Configuration options: [PCI/PEG] [PEG/PCI]

#### PEG Port Control [Auto]

Configuration options: [Auto] [Disabled]

#### **PEG Force x1 [Disabled]**

This item appears when the **PEG Port Control** item is set to [Auto].

Configuration options: [Enabled] [Disabled]

## 4.5.3 OnBoard Devices Configuration

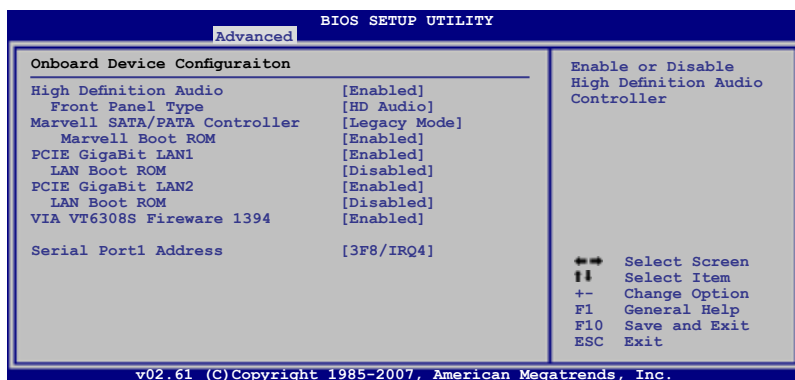

### High Definition Audio [Enabled]

Allows you to enable or disable the High Definition Audio.

Configuration options: [Enabled] [Disabled]

#### Front Panel Type [HD Audio]

This item appears only when you enable the previous item and allows you to set the front panel audio connector (AAFP) mode to legacy AC'97 or high-definition audio depending on the audio standard that the front panel audio module supports.

Configuration options: [AC97] [HD Audio]

### Marvell SATA/PATA Controller [Legacy Mode]

Set this item to **RAID Mode** to create a RAID set using the EXT\_SATA1-2 connectors and the external SATA ports.

Configuration options: [Legacy Mode] [RAID Mode] [Disabled]

#### Marvell Boot ROM [Enabled]

This item appears only when you set the previous item to [Legacy Mode] or [RAID Mode].

Configuration options: [Disabled] [Enabled]



Please install the Marvell® Controller driver before using the black Serial ATA connectors (EXT\_SATA1-2). Refer to **6.2.4 Make Disk menu** for details.



## PCIE GigaBit LAN1 [Enabled]

Configuration options: [Enabled] [Disabled]

### LAN Boot ROM [Disabled]

This item appears only when you enable the previous item.

Configuration options: [Disabled] [Enabled]

## PCIE GigaBit LAN2 [Enabled]

Configuration options: [Enabled] [Disabled]

### LAN Boot ROM [Disabled]

This item appears only when you enable the previous item.

Configuration options: [Disabled] [Enabled]

## VIA VT6308S Firewire 1394 [Enabled]

Configuration options: [Enabled] [Disabled]

## Serial Port1 Address [3F8/IRQ4]

Allows the BIOS to select the Serial Port1 base address.

Configuration options: [Disabled] [3F8/IRQ4] [2F8/IRQ3] [3E8/IRQ4] [2E8/IRQ3]

## 4.5.4 PCI PnP

The PCI PnP menu items allow you to change the advanced settings for PCI/PnP devices.



Take caution when changing the settings of the PCI PnP menu items. Incorrect field values can cause the system to malfunction.

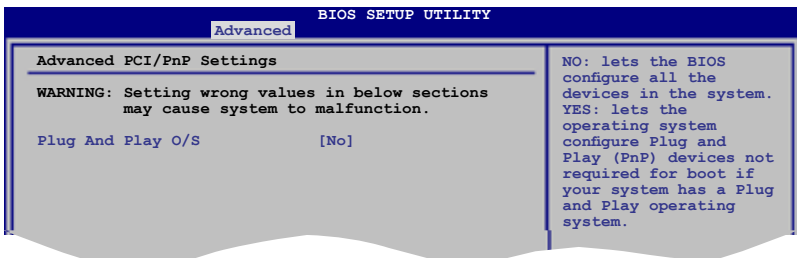

## Plug And Play O/S [No]

When set to [No], BIOS configures all the devices in the system. When set to [Yes] and if you install a Plug and Play operating system, the operating system configures the Plug and Play devices not required for boot.

Configuration options: [No] [Yes]

## 4.5.5 USB Configuration

The items in this menu allows you to change the USB-related features. Select an item then press <Enter> to display the configuration options.

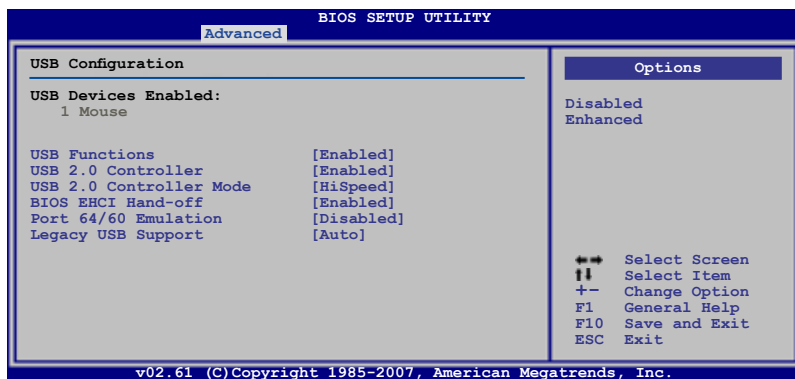

The **USB Devices Enabled** item shows auto-detected values. If no USB device is detected, the item shows **None**.

### USB Functions [Enabled]

Allows you to enable or disable the USB functions. The following sub-items appear when this item is set to [Enabled]. Configuration options: [Disabled] [Enabled]

### USB 2.0 Controller [Enabled]

Allows you to enable or disable the USB 2.0 controller. Configuration options: [Enabled] [Disabled]

### USB 2.0 Controller Mode [HiSpeed]

Allows you to set the USB 2.0 controller mode to HiSpeed (480 Mbps) or FullSpeed (12 Mbps). This item appears only when you enable the **USB 2.0 Controller** item. Configuration options: [FullSpeed] [HiSpeed]

### BIOS EHCI Hand-off [Enabled]

Allows you to enable support for operating systems without an EHCI hand-off feature. Configuration options: [Disabled] [Enabled]

### Port 64/60 Emulation [Disabled]

Allows you to enable or disable the I/O port 60h/64h emulation support. This item should be enabled for the complete USB keyboard legacy support for non-USB aware OSes. Configuration options: [Disabled] [Enabled]

### Legacy USB Support [Auto]

Allows you to enable or disable support for legacy USB devices. Setting to [Auto] allows the system to detect the presence of USB devices at startup. If detected, the USB controller legacy mode is enabled. If no USB device is detected, the legacy USB support is disabled. Configuration options: [Disabled] [Enabled] [Auto]

## 4.6 Power menu

The Power menu items allow you to change the settings for the Advanced Power Management (APM). Select an item then press <Enter> to display the configuration options.

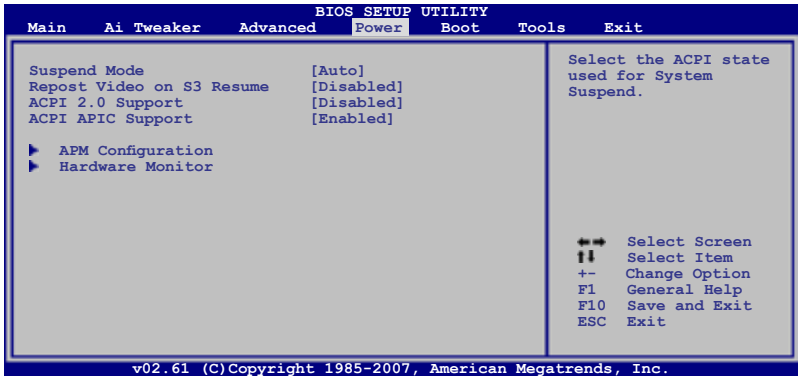

### 4.6.1 Suspend Mode [Auto]

Allows you to select the Advanced Configuration and Power Interface (ACPI) state to be used for system suspend.

Configuration options: [S1 (POS) Only] [S3 Only] [Auto]

### 4.6.2 Repost Video on S3 Resume [Disabled]

Determines whether to invoke VGA BIOS POST on S3/STR resume.

Configuration options: [Disabled] [Enabled]

### 4.6.3 ACPI 2.0 Support [Disabled]

Allows you to add more tables for Advanced Configuration and Power Interface (ACPI) 2.0 specifications.

Configuration options: [Disabled] [Enabled]

### 4.6.4 ACPI APIC Support [Enabled]

Allows you to enable or disable the Advanced Configuration and Power Interface (ACPI) support in the Advanced Programmable Interrupt Controller (APIC). When set to Enabled, the ACPI APIC table pointer is included in the RSDT pointer list.

Configuration options: [Disabled] [Enabled]

## 4.6.5 APM Configuration

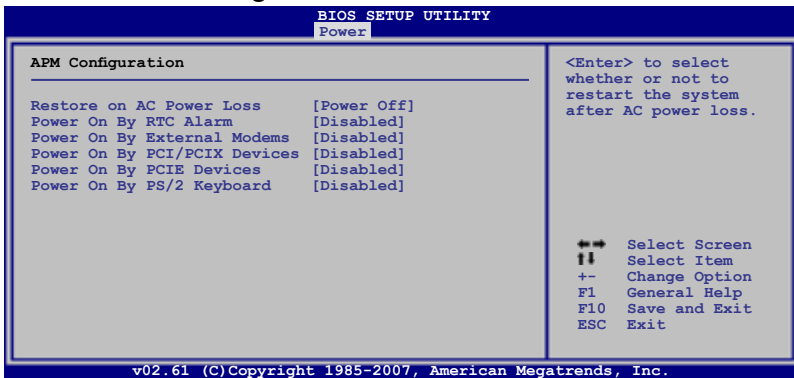

### Restore On AC Power Loss [Power Off]

When set to Power Off, the system goes into off state after an AC power loss. When set to Power On, the system goes on after an AC power loss. When set to Last State, the system goes into either off or on state, whatever the system state was before the AC power loss.

Configuration options: [Power Off] [Power On] [Last State]

### Power On By RTC Alarm [Disabled]

Allows you to enable or disable RTC to generate a wake event. When this item is set to Enabled, the items **RTC Alarm Date / RTC Alarm Hour / RTC Alarm Minute / RTC Alarm Second** will become user-configurable with set values.

Configuration options: [Disabled] [Enabled]

### Power On By External Modems [Disabled]

This allows either settings of [Enabled] or [Disabled] for powering up the computer when the external modem receives a call while the computer is in Soft-off mode.

Configuration options: [Disabled] [Enabled]



The computer cannot receive or transmit data until the computer and applications are fully running. Thus, connection cannot be made on the first try. Turning an external modem off and then back on while the computer is off causes an initialization string that turns the system power on.

### Power On By PCI/PCIX Devices [Disabled]

Allows you to enable or disable the PME to wake up from S5 by PCI devices.

Configuration options: [Disabled] [Enabled]

### Power On By PCIE Devices [Disabled]

Allows you to enable or disable the PCIE devices to generate a wake event.

Configuration options: [Disabled] [Enabled]

## Power On By PS/2 Keyboard [Disabled]

Allows you to disable the Power On by PS/2 keyboard function or set specific keys on the PS/2 keyboard to turn on the system. This feature requires an ATX power supply that provides at least 1A on the +5VSB lead.

Configuration options: [Disabled] [Space Bar] [Ctrl-Esc] [Power Key]

## 4.6.6 Hardware Monitor

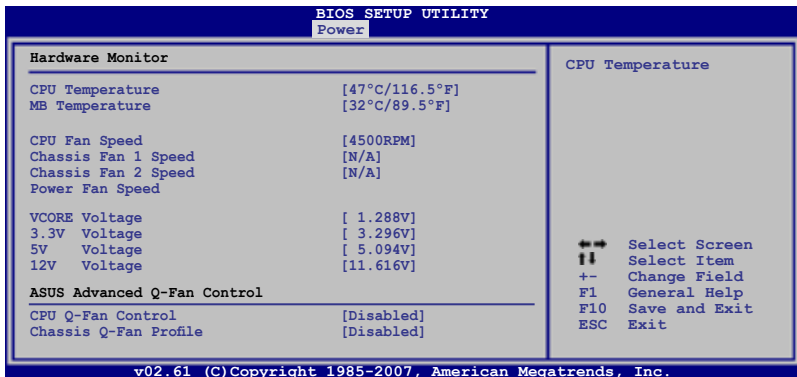

### CPU Temperature [xxx°C/xxx°F]

### MB Temperature [xxx°C/xxx°F]

The onboard hardware monitor automatically detects and displays the motherboard and CPU temperatures. Select [Ignored] if you do not wish to display the detected temperatures.

### CPU Fan Speed [xxxxRPM] or [Ignored] / [N/A]

The onboard hardware monitor automatically detects and displays the CPU fan speed in rotations per minute (RPM). If the fan is not connected to the motherboard, the field shows [N/A].

### Chassis Fan 1/2 Speed [xxxxRPM] or [Ignored] / [N/A]

### Power Fan Speed [xxxxRPM] or [Ignored] / [N/A]

The onboard hardware monitor automatically detects and displays the chassis fan speed and power fan speed in rotations per minute (RPM). If the fan is not connected to the motherboard, the field shows [N/A].

### VCore Voltage, 3.3V Voltage, 5V Voltage, 12V Voltage

The onboard hardware monitor automatically detects the voltage output through the onboard voltage regulators. Select [Ignored] if you do not want to detect this item.

### **CPU Q-Fan Control [Disabled]**

Allows you to enable or disable the CPU Q-Fan controller.

Configuration options: [Disabled] [Enabled]



---

The **CPU Fan Profile** item appears when you enable the **CPU Q-Fan Control** feature.

---

### **CPU Fan Profile [Optimal]**

Allows you to set the appropriate performance level of the CPU Q-Fan. When set to [Optimal], the CPU fan automatically adjusts depending on the CPU temperature. Set this item to [Silent Mode] to minimize fan speed for quiet CPU fan operation, or [Performance Mode] to achieve maximum CPU fan speed.

Configuration options: [Optimal] [Silent Mode] [Performance Mode]

### **Chassis Q-Fan Control [Disabled]**

Allows you to enable or disable the chassis Q-Fan controller.

Configuration options: [Disabled] [Enabled]



---

The **Chassis Fan Ratio** and **Chassis Target Temperature** items appear when you enable the **Chassis Q-Fan Control** feature.

---

### **Chassis Fan Ratio [Auto]**

Allows you to select the fan speed ratio so that the fans operate at a low CPU temperature. Setting a very low ratio may cause a dramatical fan speed drop and trigger a hardware monitor warning message.

Configuration options: [Auto] [90%] [80%] [70%] [60%]

### **Chassis Target Temperature [37°C]**

The CPU fan speed will be adjusted to maintain the CPU temperature as low as the selected temperature.

Configuration options: [28°C] [31°C] [34°C] [37°C] [40°C] [43°C] [46°C]

## 4.7 Boot menu

The Boot menu items allow you to change the system boot options. Select an item then press <Enter> to display the sub-menu.

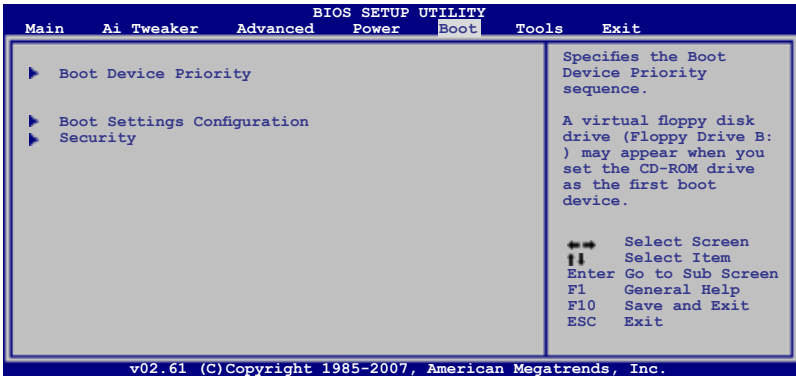

### 4.7.1 Boot Device Priority

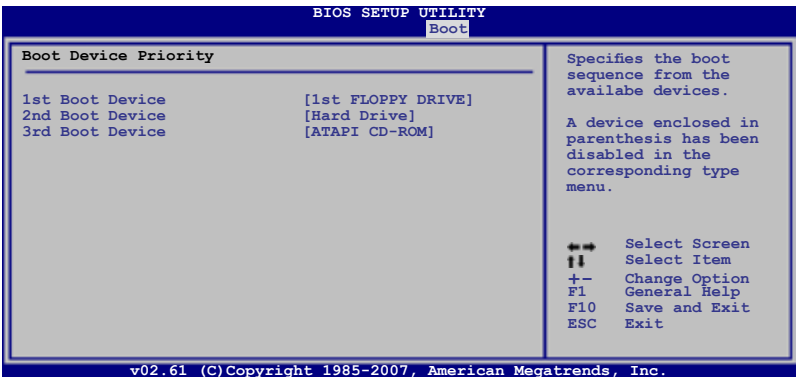

#### 1st ~ xxth Boot Device [xxx Drive]

These items specify the boot device priority sequence from the available devices. The number of device items that appears on the screen depends on the number of devices installed in the system.

Configuration options: [1st FLOPPY DRIVE] [Hard Drive] [ATAPI CD-ROM] [Disabled]

## 4.7.2 Boot Settings Configuration

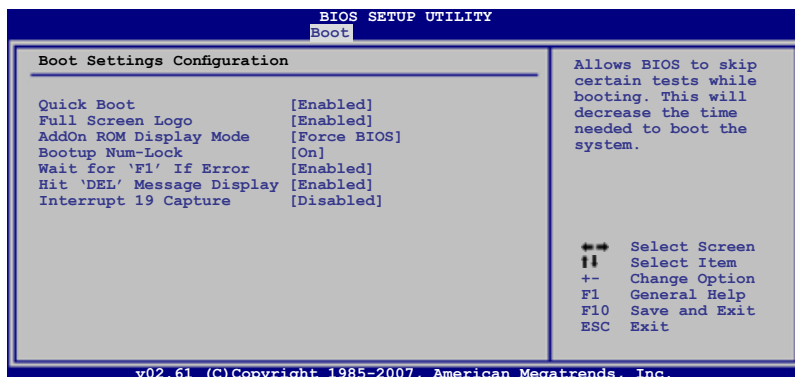

### Quick Boot [Enabled]

Enabling this item allows the BIOS to skip some power on self tests (POST) while booting to decrease the time needed to boot the system. When set to [Disabled], BIOS performs all the POST items.

Configuration options: [Disabled] [Enabled]

### Full Screen Logo [Enabled]

This allows you to enable or disable the full screen logo display feature.

Configuration options: [Disabled] [Enabled]



Set this item to [Enabled] to use the ASUS MyLogo2™ feature.

### AddOn ROM Display Mode [Force BIOS]

Sets the display mode for option ROM.

Configuration options: [Force BIOS] [Keep Current]

### Bootup Num-Lock [On]

Allows you to select the power-on state for the NumLock.

Configuration options: [Off] [On]

### Wait for 'F1' If Error [Enabled]

When set to Enabled, the system waits for the F1 key to be pressed when error occurs. Configuration options: [Disabled] [Enabled]

### Hit 'DEL' Message Display [Enabled]

When set to Enabled, the system displays the message "Press DEL to run Setup" during POST. Configuration options: [Disabled] [Enabled]

### Interrupt 19 Capture [Disabled]

When set to [Enabled], this function allows the option ROMs to trap Interrupt 19.

Configuration options: [Disabled] [Enabled]



### 4.7.3 Security

The Security menu items allow you to change the system security settings. Select an item then press <Enter> to display the configuration options.

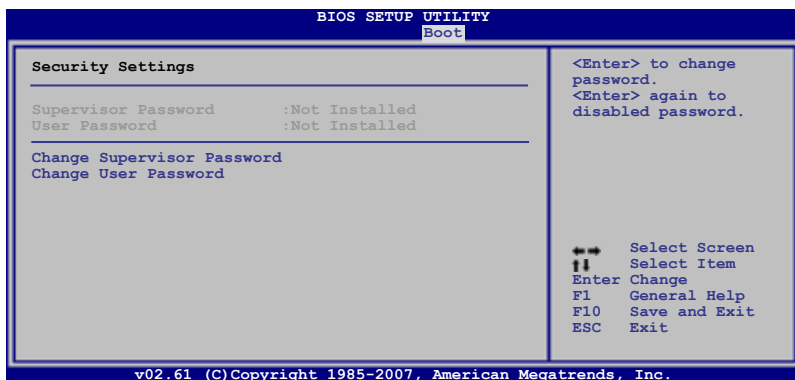

#### Change Supervisor Password

Select this item to set or change the supervisor password. The Supervisor Password item on top of the screen shows the default Not Installed. After you set a password, this item shows Installed.

To set a Supervisor Password:

1. Select the Change Supervisor Password item and press <Enter>.
2. From the password box, type a password composed of at least six letters and/or numbers, then press <Enter>.
3. Confirm the password when prompted.

The message "Password Installed" appears after you successfully set your password.

To change the supervisor password, follow the same steps as in setting a user password.

To clear the supervisor password, select the Change Supervisor Password then press <Enter>. The message "Password Uninstalled" appears.



---

If you forget your BIOS password, you can clear it by erasing the CMOS Real Time Clock (RTC) RAM. See section **3.2 Jumper** for information on how to erase the RTC RAM.

---

After you have set a supervisor password, the other items appear to allow you to change other security settings.

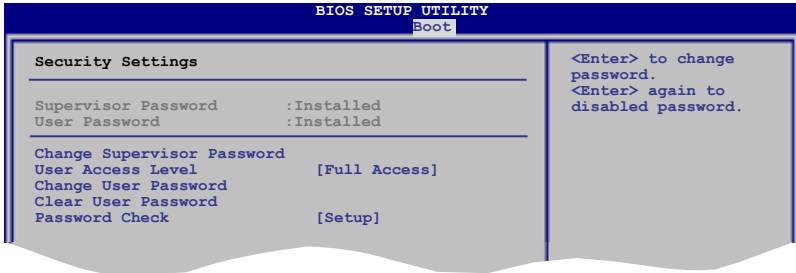

## User Access Level [Full Access]

This item allows you to select the access restriction to the Setup items.  
Configuration options: [No Access] [View Only] [Limited] [Full Access]

**No Access** prevents user access to the Setup utility.

**View Only** allows access but does not allow change to any field.

**Limited** allows changes only to selected fields, such as Date and Time.

**Full Access** allows viewing and changing all the fields in the Setup utility.

## Change User Password

Select this item to set or change the user password. The User Password item on top of the screen shows the default Not Installed. After you set a password, this item shows Installed.

To set a User Password

1. Select the Change User Password item and press <Enter>.
2. On the password box that appears, type a password composed of at least six letters and/or numbers, then press <Enter>.
3. Confirm the password when prompted.

The message "Password Installed" appears after you set your password successfully.

To change the user password, follow the same steps as in setting a user password.

## Clear User Password

Select this item to clear the user password.

## Password Check [Setup]

When set to [Setup], BIOS checks for user password when accessing the Setup utility. When set to [Always], BIOS checks for user password both when accessing Setup and booting the system.

Configuration options: [Setup] [Always]

## 4.8 Tools menu

The Tools menu items allow you to configure options for special functions. Select an item then press <Enter> to display the sub-menu.

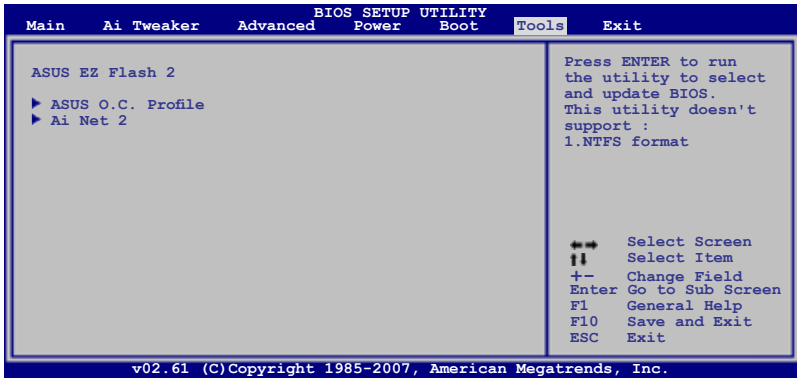

### 4.8.1 ASUS EZ Flash 2

Allows you to run ASUS EZ Flash 2. When you press <Enter>, a confirmation message appears. Use the left/right arrow key to select between [Ok] or [Cancel], then press <Enter> to confirm your choice. Please see section 4.1.3 for details.

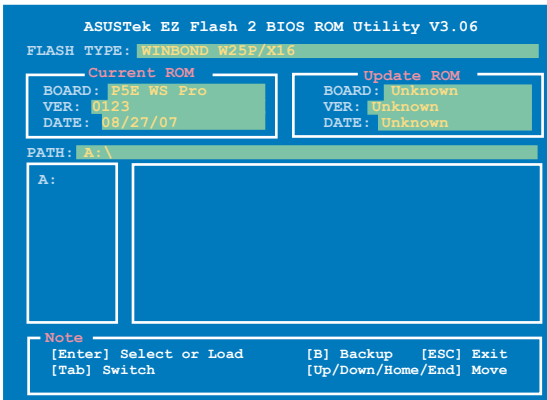

## 4.8.2 ASUS O.C. Profile

This item allows you to store or load multiple BIOS settings.

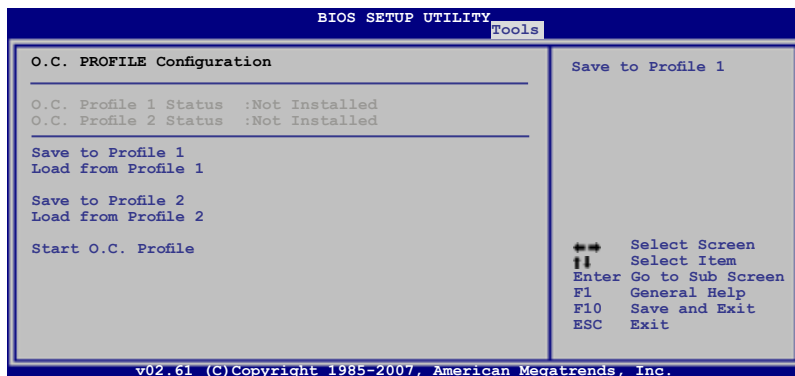

### Save to Profile 1/2

Allows you to save the current BIOS file to the BIOS Flash. Press <Enter> to save the file.

### Load from Profile 1/2

Allows you to load the previous BIOS settings saved in the BIOS Flash. Press <Enter> to load the file.

### Start O.C. Profile

Allows you to run the utility to save and load CMOS. Press <Enter> to run the utility.

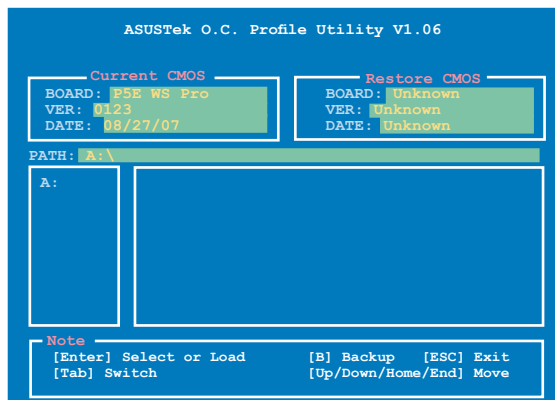

- This function can support devices such as a USB flash disk or a floppy disk with FAT 32/16 format and single partition only.
- DO NOT shut down or reset the system while updating the BIOS to prevent the system boot failure!

### 4.8.3 Ai Net 2

This menu displays the status of the Local Area Network (LAN) cables connected to the LAN (RJ-45) ports.

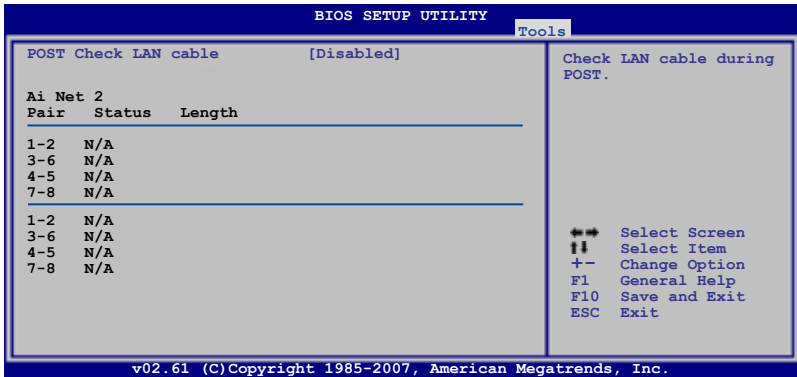

#### POST Check LAN cable [Disabled]

Allows you to enable or disable LAN cable check during POST. When enabled, the menu reports the cable faults or shorts, and displays the point (length) where the faults or shorts are detected.

Configuration options: [Disabled] [Enabled]

## 4.9 Exit menu

The Exit menu items allow you to load the optimal or failsafe default values for the BIOS items, and save or discard your changes to the BIOS items.

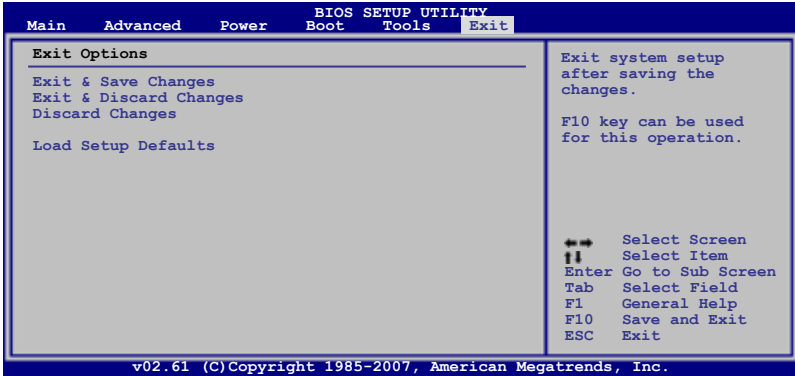

Pressing <Esc> does not immediately exit this menu. Select one of the options from this menu or <F10> from the legend bar to exit.

### Exit & Save Changes

Once you are finished making your selections, choose this option from the Exit menu to ensure the values you selected are saved to the CMOS RAM. An onboard backup battery sustains the CMOS RAM so it stays on even when the PC is turned off. When you select this option, a confirmation window appears. Select YES to save changes and exit.



If you attempt to exit the Setup program without saving your changes, the program prompts you with a message asking if you want to save your changes before exiting. Press <Enter> to save the changes while exiting.

### Exit & Discard Changes

Select this option only if you do not want to save the changes that you made to the Setup program. If you made changes to fields other than System Date, System Time, and Password, the BIOS asks for a confirmation before exiting.

### Discard Changes

This option allows you to discard the selections you made and restore the previously saved values. After selecting this option, a confirmation appears. Select YES to discard any changes and load the previously saved values.

### Load Setup Defaults

This option allows you to load the default values for each of the parameters on the Setup menus. When you select this option or if you press <F5>, a confirmation window appears. Select YES to load default values. Select Exit & Save Changes or make other changes before saving the values to the non-volatile RAM.

# Chapter 5

This chapter provides information on how to configure your hard disk drives as RAID sets.



ASUS TW300-E5/P14

Download from [Www.Somanuals.com](http://www.Somanuals.com). All Manuals Search And Download.

# RAID configuration

## 5.1 RAID configurations

The motherboard comes with two RAID controllers that allow you to configure Serial ATA hard disk drives as RAID sets.

- The **Intel® ICH9R Southbridge RAID** includes a high performance SATA RAID controller that supports RAID 0, RAID 1, RAID 10, and RAID 5 for six independent Serial ATA channels.
- **Marvell® 88SE6145 RAID**. Enabled by Marvell® 88SE6145 controller, the Marvell® RAID extends the advantages of software RAID beyond internal hard disk drives to external hard disk drives or port-multiplier devices.

### 5.1.1 RAID definitions

**RAID 0 (Data striping)** optimizes two identical hard disk drives to read and write data in parallel, interleaved stacks. Two hard disks perform the same work as a single drive but at a sustained data transfer rate, double that of a single disk alone, thus improving data access and storage. Use of two new identical hard disk drives is required for this setup.

**RAID 1 (Data mirroring)** copies and maintains an identical image of data from one drive to a second drive. If one drive fails, the disk array management software directs all applications to the surviving drive as it contains a complete copy of the data in the other drive. This RAID configuration provides data protection and increases fault tolerance to the entire system. Use two new drives or use an existing drive and a new drive for this setup. The new drive must be of the same size or larger than the existing drive.

**RAID 5** stripes both data and parity information across three or more hard disk drives. Among the advantages of RAID 5 configuration include better HDD performance, fault tolerance, and higher storage capacity. The RAID 5 configuration is best suited for transaction processing, relational database applications, enterprise resource planning, and other business systems. Use a minimum of three identical hard disk drives for this setup.

**RAID 10** is data striping and data mirroring combined without parity (redundancy data) having to be calculated and written. With the RAID 10\* configuration you get all the benefits of both RAID 0 and RAID 1 configurations. Use four new hard disk drives or use an existing drive and three new drives for this setup.

**Intel® Matrix Storage.** The Intel® Matrix Storage technology supported by the ICH9R chip allows you to create a RAID 0, RAID 1, RAID 5, and RAID 10\* function to improve both system performance and data safety. You can also combine two RAID sets to get higher performance, capacity, or fault tolerance provided by the difference RAID function. For example, RAID 0 and RAID 1 set can be created by using only two identical hard disk drives.



---

If you want to boot the system from a hard disk drive included in a created RAID set, copy first the RAID driver from the support CD to a floppy disk before you install an operating system to the selected hard disk drive. Refer to section **6.1.1 Creating a RAID driver disk** for details.

---



## 5.1.2 Installing hard disk drives

The motherboard supports Serial ATA hard disk drives. For optimal performance, install identical drives of the same model and capacity when creating a disk array.

To install the SATA hard disks for a RAID configuration:

1. Install the SATA hard disks into the drive bays.
2. Connect the SATA signal cables.
3. Connect a SATA power cable to the power connector on each drive.

## 5.1.3 Setting the RAID item in BIOS

You must set the RAID item in the BIOS Setup before you can create a RAID set(s). To do this:

1. Enter the BIOS Setup during POST.
2. Go to the **Main Menu**, select **SATA Configuration**, then press <Enter>.
3. Select the item **Configure SATA as**, then press <Enter> to display the configuration options.
4. Select **RAID** from the Configure SATA as item options, then press <Enter>.
5. Save your changes, then exit the BIOS Setup.



---

Refer to **Chapter 4** for details on entering and navigating through the BIOS Setup.

---

## 5.2 Marvel® 88SE6145 RAID BIOS Configuration Utility

The Marvell® 88SE6145 RAID BIOS Configuration utility allows you to create RAID 0, RAID 1, RAID 10, or RAID 5 set(s) from Serial ATA hard disk drives that are connected to the Serial ATA connectors supported by the Southbridge.

To enter the Marvell® RAID BIOS Configuration utility:

1. Install all the Serial ATA hard disk drives at Red SATA Connector.
2. Turn on the system.
3. During POST, press <Ctrl> + <M> to enter the utility main menu.

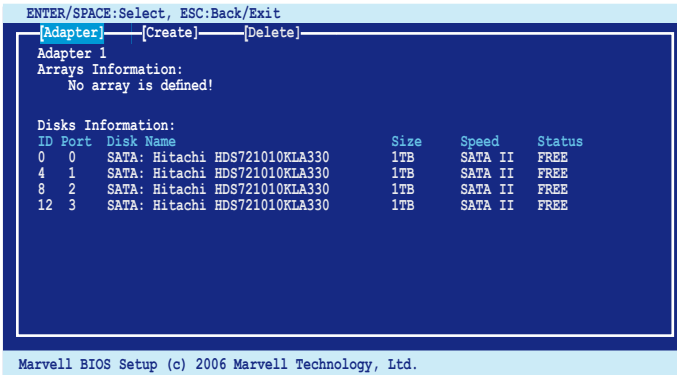

4. Press <Enter> and select a desired adapter for RAID configuration.

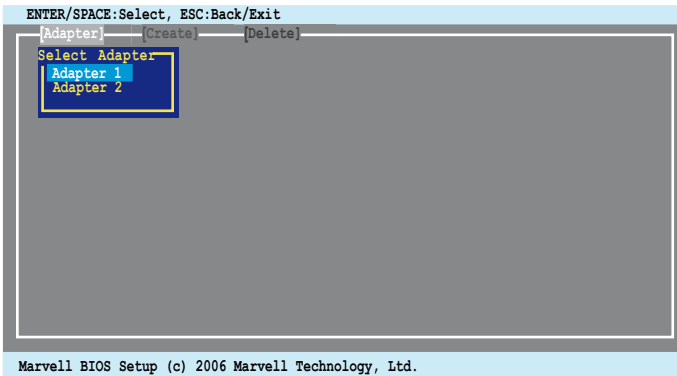

The RAID BIOS setup screens shown in this section are for reference only and may not exactly match the items on your screen.

## 5.2.1 Creating a RAID set

To create a RAID set:

1. From the utility menu bar, select Create on the top.

```
ENTER/SPACE>Select, ESC:Back/Exit
[Adapter] [Create] [Delete]
Adapter 1
Arrays Information:
  No array is defined!

Disks Information:
ID Port  Disk Name                               Size  Speed  Status
0  0      SATA: Hitachi HDS721010KLA330           1TB   SATA II  FREE
4  1      SATA: Hitachi HDS721010KLA330           1TB   SATA II  FREE
8  2      SATA: Hitachi HDS721010KLA330           1TB   SATA II  FREE
12 3      SATA: Hitachi HDS721010KLA330           1TB   SATA II  FREE

Marvell BIOS Setup (c) 2006 Marvell Technology, Ltd.
```

2. Press <Enter>. The screen shows the disks you can add to make up the RAID set. Use the arrow key to select a disk and press <Enter> or <Space> to include this disk in the array.

```
ENTER/SPACE>Select, ESC:Back/Exit
[Adapter] [Create] [Delete]
Select free disks to create
ID Port  Disk Name                               Size  Speed  Status
0  0      SATA: Hitachi HDS721010KLA330           1TB   SATA II  FREE
4  1      SATA: Hitachi HDS721010KLA330           1TB   SATA II  FREE
8  2      SATA: Hitachi HDS721010KLA330           1TB   SATA II  FREE
12 3      SATA: Hitachi HDS721010KLA330           1TB   SATA II  FREE
NEXT

Marvell BIOS Setup (c) 2006 Marvell Technology, Ltd.
```

3. After you have selected the desired disks, select **NEXT** to create array.

4. The **Create Array** screen appears.

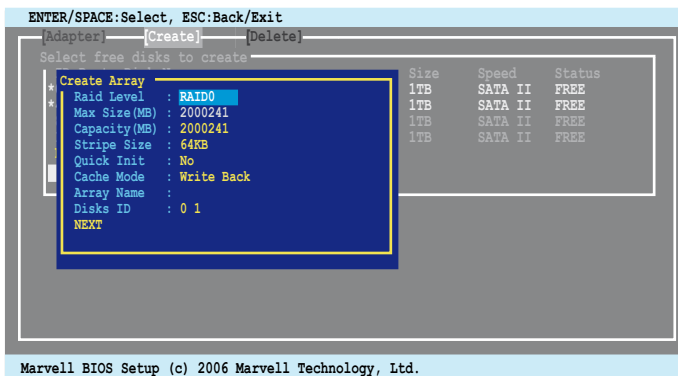

5. Use the arrow key to select the **RAID Level** item and press <Enter> to display the available RAID set. Select a RAID set and press <Enter> to create.

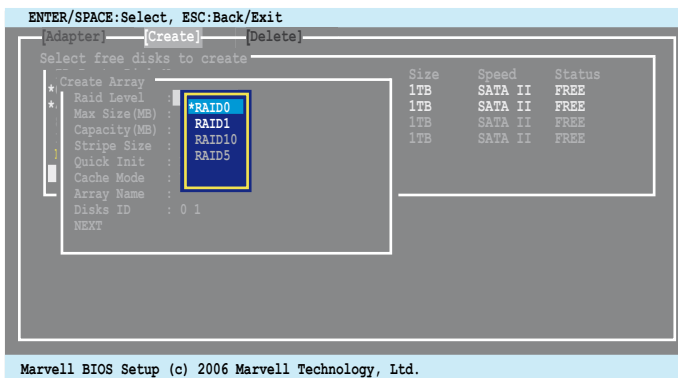

- The available RAID sets vary with the number of disks you select. The RAID sets that you are not allowed to create are grayed out.
- Except for the **RAID Level** item, we recommend you keep the default values for the other items in **Create Array** screen.

6. A confirmation screen appears. Press <Y> to confirm the array creation.

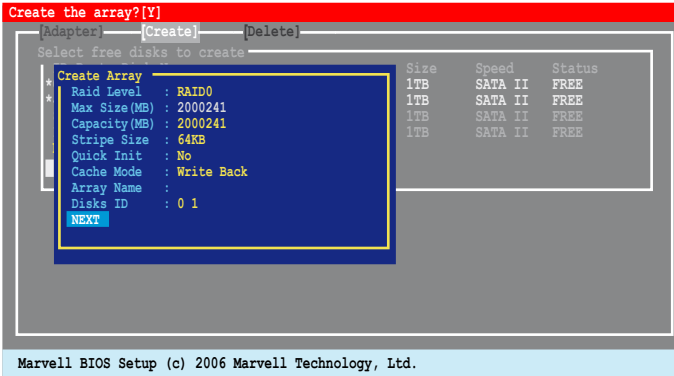

7. The newly created array appears in **Arrays Information**.

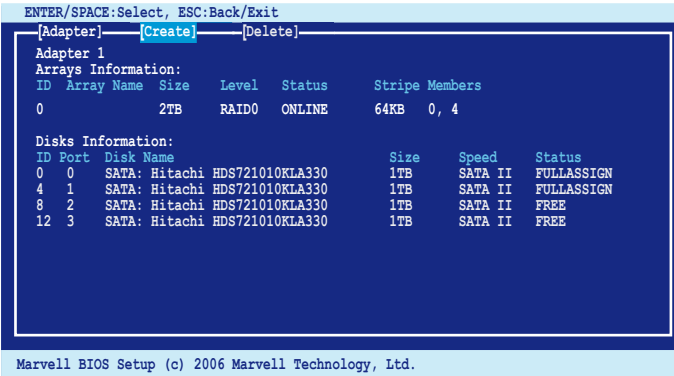

## 5.2.2 Deleting an array

To delete a RAID set:

1. From the utility menu bar, select Delete on the top and press <Enter> and the **Delete array** screen appears.

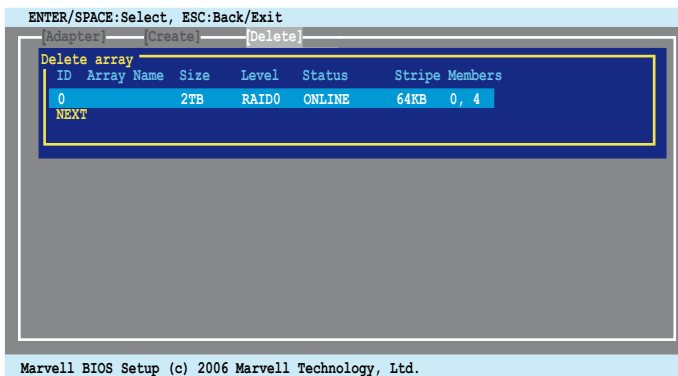

2. Select a desired array to delete and select **NEXT**. Press <Y> after the confirmation screen appears.

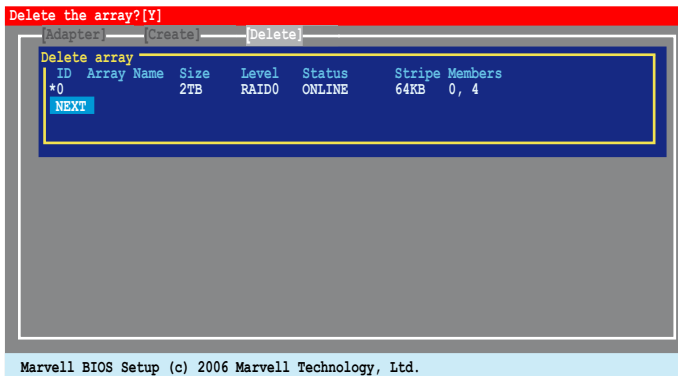

3. Press <Y> again to confirm and delete the selected array.

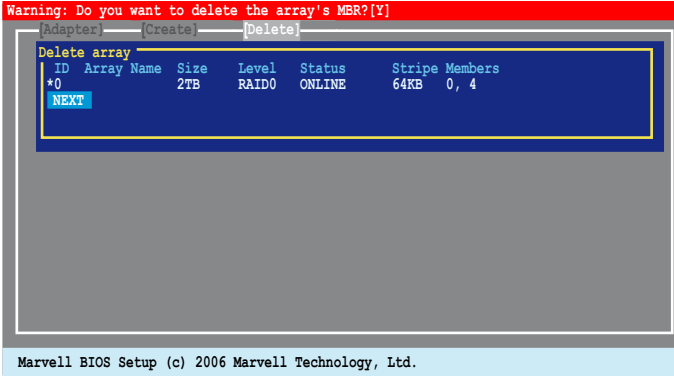

---

You cannot recover lost data if you delete an array. Make sure you back up important data before deleting an array.

---

## 5.3 Intel® Matrix Storage Manager Option ROM Utility

The Intel® Matrix Storage Manager Option ROM utility allows you to create RAID 0, RAID 1, RAID 0+1, and RAID 5 set(s) from Serial ATA hard disk drives.

To enter the Intel® Matrix Storage Manager Option ROM Utility:

1. Turn on the system after installing all Serial ATA hard disk drives.
2. During POST, press <Ctrl+I> to display the utility main menu.

```
Intel(R) Matrix Storage Manager Option ROM v7.6.0.1011 ICH9R wRAID5
Copyright(C) 2003-05 Intel Corporation. All Rights Reserved.

[ MAIN MENU ]
1. Create RAID Volume
2. Delete RAID Volume
3. Reset Disks to Non-RAID
4. Exit

[ DISK/VOLUME INFORMATION ]

RAID Volumes:
None defined.

Physical Disks:
Port      Drive Model      Serial #      Size      Type/Status(Vol ID)
0         XXXXXXXXXXXX    XXXXXXXX    XX.XXGB   Non-RAID Disk
1         XXXXXXXXXXXX    XXXXXXXX    XX.XXGB   Non-RAID Disk
2         XXXXXXXXXXXX    XXXXXXXX    XX.XXGB   Non-RAID Disk
3         XXXXXXXXXXXX    XXXXXXXX    XX.XXGB   Non-RAID Disk

[↑↓]-Select      [ESC]-Exit      [ENTER]-Select Menu
```

The navigation keys at the bottom of the screen allow you to move through the menus and select the menu options.



The RAID BIOS setup screens shown in this section are for reference only and may not exactly match the items on your screen.



The utility supports maximum four hard disk drives for RAID configuration.



### 5.3.1 Creating a RAID 0 set (Stripe)

To create a RAID 0 set:

1. From the utility main menu, select **1. Create RAID Volume**, then press <Enter>. This screen appears.

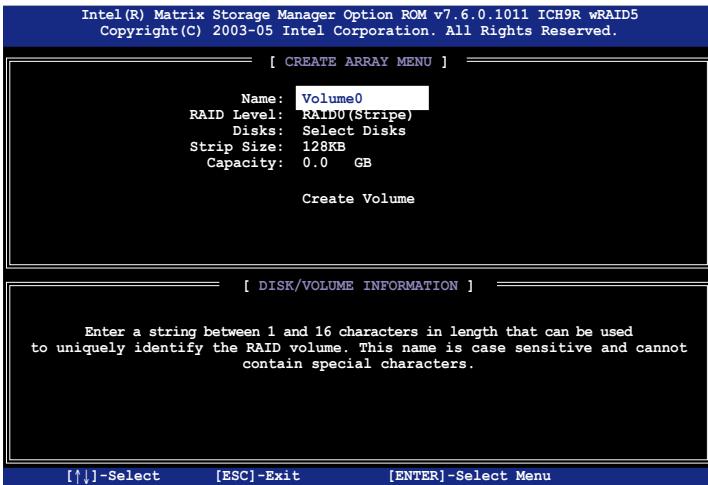

2. Enter a name for the RAID 0 set, then press <Enter>.
3. Highlight **RAID Level**, press the up/down arrow key to select **RAID 0 (Stripe)**, then press <Enter>.
4. Highlight the **Disks** item, then press <Enter> to select the hard disk drives you want to include in the RAID set. The **SELECT DISKS** screen appears.

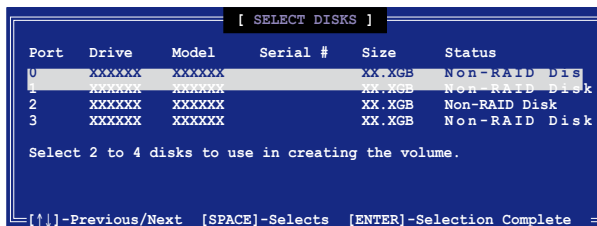

5. Use the up/down arrow key to highlight a drive, then press <Spacebar> to select. A small triangle marks the selected drive. Press <Enter> after completing your selection.

6. Use the up/down arrow key to select the stripe size for the RAID 0 array, then press <Enter>. The available stripe size values range from 4 KB to 128 KB. The default stripe size is 128 KB..



---

A lower stripe size is recommended for server systems. A higher stripe size is recommended for multimedia computer systems used mainly for audio and video editing.

---

7. Highlight the **Capacity** item, enter the desired RAID volume capacity, then press <Enter>. The default value indicates the maximum allowed capacity.
8. When the **Create Volume** item is highlighted, press <Enter>. A warning message appears.



9. Press <Y> to create the RAID volume and return to the main menu, or <N> to go back to the **Create Array** menu.

### 5.3.2 Creating a RAID 1 set (Mirror)

To create a RAID 1 set:

1. From the utility main menu, select **1. Create RAID Volume**, then press <Enter>. This screen appears.

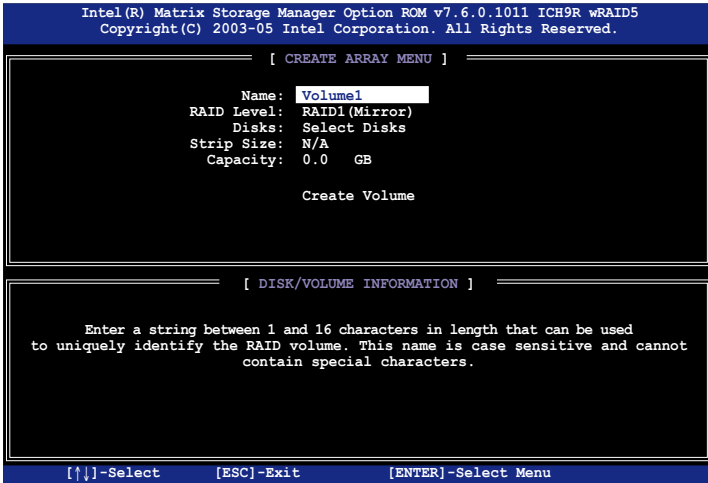

2. Enter a name for the RAID 1 set, then press <Enter>.
3. Highlight **RAID Level**, press the up/down arrow key to select **RAID 1 (Mirror)**, then press <Enter>.
4. Follow steps 4 to 5 and 7 to 9 of the previous section to create the RAID 1 set.

### 5.3.3 Creating a RAID 10 set (Stripe + Mirror)

To create a RAID 10 set:

1. From the utility main menu, select **1. Create RAID Volume**, then press <Enter>. This screen appears.

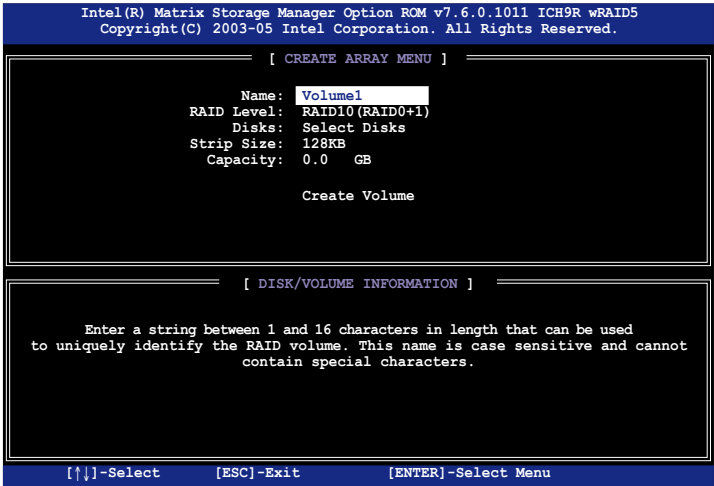

2. Enter a name for the RAID 10 set, then press <Enter>.
3. Highlight **RAID Level**, press the up/down arrow key to select RAID 10 (RAID0+1), then press <Enter>.
4. Follow steps 4 to 9 of section **5.3.1 Creating a RAID 0 set (striped)** to create the RAID 10 set.

### 5.3.4 Creating a RAID 5 set (Parity)

To create a RAID 5 set:

1. From the utility main menu, select **1. Create RAID Volume**, then press <Enter>. This screen appears.

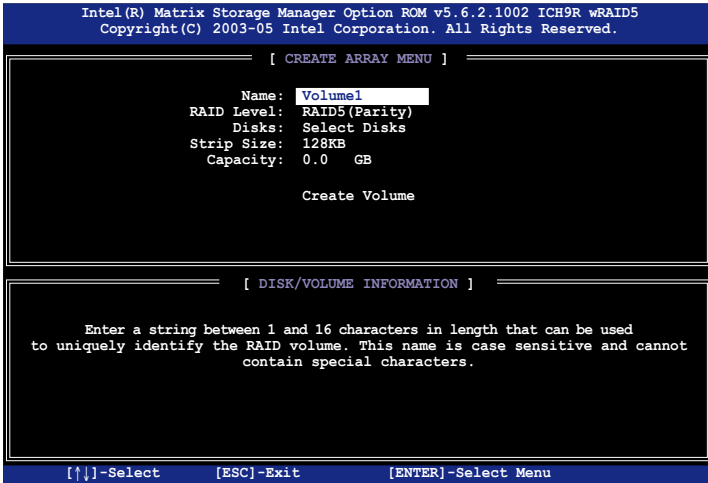

2. Enter a name for the RAID 10 set, then press <Enter>.
3. Highlight **RAID Level**, press the up/down arrow key to select RAID 5, then press <Enter>.
4. Follow steps 4 to 9 of section **5.3.1 Creating a RAID 0 set (striped)** to create the RAID 5 set.

### 5.3.5 Deleting a RAID set



Take caution when deleting a RAID set. You will lose all data on the hard disk drives when you delete a RAID set.

To delete a RAID set:

1. From the utility main menu, select **2. Delete RAID Volume**, then press <Enter> to display this screen.

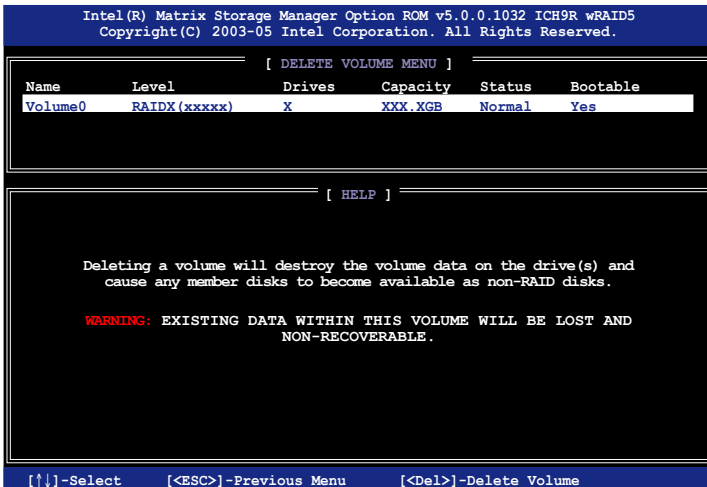

2. Use the up/down arrow key to select the RAID set you want to delete, then press <Del>. This window appears.



3. Press <Y> to delete the RAID set and return to the utility main menu; otherwise, press <N> to return to the **Delete Volume** menu.

### 5.3.6 Resetting disks to Non-RAID



Take caution before you reset a RAID volume hard disk drive to non-RAID. Resetting a RAID volume hard disk drive deletes all internal RAID structure on the drive.

To reset a RAID set hard disk drive:

1. From the utility main menu, select **3. Reset Disks to Non-RAID**, then press <Enter> to display this screen.

```
[ RESET RAID DATA ]

Resetting RAID data will remove internal RAID structures
from the selected RAID disks. By removing these structures,
the drive will revert back to a non-RAID disk.

WARNING: Resetting a disk causes all data on the disk to be lost.

Port  Drive Model      Serial #      Size      Status
 0  XXXXXXXXXXXXX  XXXXXXXX    XX.XGB  Member D.
 1  XXXXXXXXXXXXX  XXXXXXXX    XX.XGB  Member Disk

      Select the disks that should be reset.

[Left/Right]-Previous/Next  [SPACE]-Selects  [ENTER]-Selection Complete
```

2. Use the up/down arrow key to highlight the RAID set drive you want to reset, then press <Space> to select.
3. Press <Enter> to reset the RAID set drive. A confirmation message appears.
4. Press <Y> to reset the drive or press <N> to return to the utility main menu.
5. Follow steps 2 to 4 to select and reset other RAID set drives.

### 5.3.7 Rebuilding the RAID



This option is only for the RAID 1, RAID 5 and RAID 10 level.

Rebuilding the RAID with other non-RAID disk:

1. If one member of physical SATA Hard disk within the array is off-line or failed, the status of array will become to be degraded from normal. The following displays as:

```
Copyright(C) 2003-05 Intel Corporation. All Rights Reserved.

RAID Volumes:
ID   Name      Level      Strip  Size   Status  Bootable
 0   Volume0   RAID1(Mirror)  N/A   74.5GB Degraded Yes

Physical Disks:
Port Drive Model      Serial #      Size   Type/Status(Vol ID)
 1   ST380013FS  5JY7XSE9     74.5GB Member Disk(0)
 3   HDS722580VLSA80  VN6GHCCEW1EKMC  76.7GB Non-RAID Disk

Press <Ctrl>+<D> to enter Configuration Utility....
```

2. Press <Ctrl-I> to enter the Intel Matrix Storage Manager RAID configuration utility after POST.
3. If there is available Non-RAID SATA Hard Disk, the utility will prompt the windows for rebuilding the RAID. Press <Enter> to select the port of destination disk for rebuilding or press <ESC> to exit



The size of destination disk for rebuilding should be the same or bigger as the original hard disk.

4. After selecting, the volumes with **Rebuild** status will be rebuilt within the operating system.

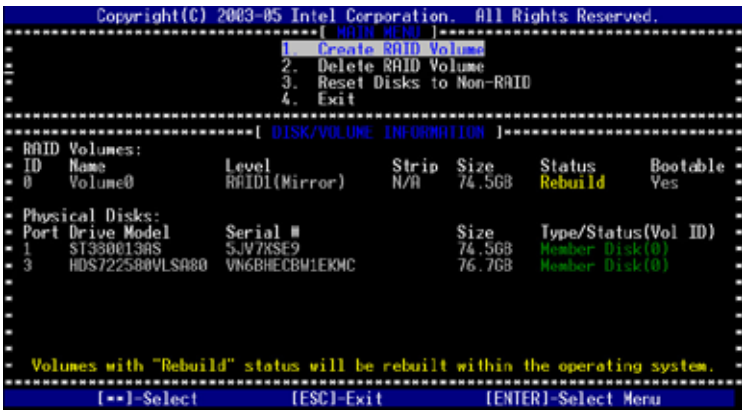

5. Exit the SATA RAID utility. When operating system is running, select the Intel Matrix Storage Console from the Start Menu or click the Intel Matrix Storage Manager tray icon.
6. From the **View** menu, select **Advanced Mode** to display a detailed view of the Intel Matrix Storage Console.
7. From the **Volumes** view in the device pane, select the RAID volume. The status will display **Rebuilding % complete**. After the rebuild is complete, the status will display **Normal**.



Rebuilding the RAID with new installed disk:

1. If one member of physical SATA Hard disk within the array is off-line or failed, the status of array will become to be degraded from normal. The following displays as.

```
Copyright(C) 2003-05 Intel Corporation. All Rights Reserved.

RAID Volumes:
ID Name Level Strip Size Status Bootable
0 Volume0 RAID1(Mirror) N/A 74.5GB Degraded Yes

Physical Disks:
Port Drive Model Serial # Size Type/Status(Vol ID)
1 ST380013AS SJV7KSE9 74.5GB Member Disk(0)
3 HDS722580VLSA80 VNG6BHECBW1EKMC 76.7GB Non-RAID Disk

Press <Ctrl><M> to enter Configuration Utility.....
```

2. Remove the failed SATA hard disk and install the same specification of new SATA hard disk into the same SATA Port. After reboot, the rebuild will occur automatically.



The size of new disk for rebuilding should be the same or bigger as the original hard disk.

3. After selecting, the volumes with **Rebuild** status will be rebuilt within the operating system.

```
Copyright(C) 2003-05 Intel Corporation. All Rights Reserved.
-----[ MAIN MENU ]-----
1. Create RAID Volume
2. Delete RAID Volume
3. Reset Disks to Non-RAID
4. Exit

-----[ DISK/VOLUME INFORMATION ]-----
RAID Volumes:
ID Name Level Strip Size Status Bootable
0 Volume0 RAID1(Mirror) N/A 74.5GB Rebuild Yes

Physical Disks:
Port Drive Model Serial # Size Type/Status(Vol ID)
1 ST380013AS SJV7KSE9 74.5GB Member Disk(0)
3 HDS722580VLSA80 VNG6BHECBW1EKMC 76.7GB Member Disk(0)

Volumes with "Rebuild" status will be rebuilt within the operating system.

[**]-Select [ESC]-Exit [ENTER]-Select Menu
```

4. Exit the SATA RAID utility. When the operating system is running, select the Intel Matrix Storage Console from the Start Menu or click the Intel Matrix Storage Manager tray icon.
5. From the **View** menu, select **Advanced Mode** to display a detailed view of the Intel Matrix Storage Console.
6. From the **Volumes** view in the device pane, select the **RAID** volume. The status will display **Rebuilding % complete**. After the rebuild is complete, the status will display **Normal**.

### 5.3.8 Exiting the Intel® Matrix Storage Manager

To exit the utility:

1. From the utility main menu, select **4. Exit**, then press <Enter>. This window appears.



2. Press <Y> to exit or press <N> to return to the utility main menu.

### 5.3.9 Setting the Boot array use MB BIOS Setup Utility

1. When creating multi-raid via Intel(r) Matrix Storage Manager RAID, we would like to assign one array to be the boot drive. The following shows as the status of current arrays:



2. Re-boot the system and press <Del> to enter the Motherboard BIOS Setup Utility during POST.
3. Go to [Boot] menu → [Boot Device Priority]. Then, select the desired boot array and use <+> or <-> key to change the boot device priority.

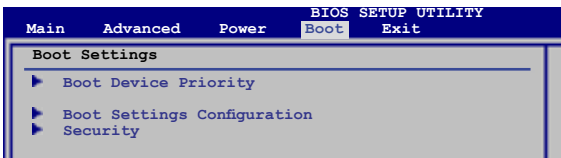

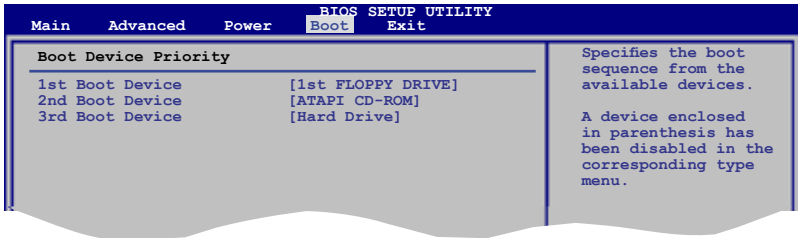

4. Exit the BIOS Setup Utility and save the changes.

### 5.3.10 Global Array Manager

You may also create a RAID set(s) in Windows® operating environment using the Global Array Manager (GAM) application. The GAM application is available from the motherboard support CD.



---

Refer to the GAM user guide in the motherboard support CD for details.

---



# Chapter 6

This chapter provides information on how to install the drivers for system components. This chapter also describes the software applications that the barebone workstation supports.



ASUS TW300-E5/P14

## 6.1 RAID driver installation

A floppy disk with the RAID driver is required when installing Windows® XP operating system on a hard disk drive that is included in a RAID set. For Windows® Vista operating system, use either a floppy disk or a USB device with the RAID driver.

### 6.1.1 Creating a RAID driver disk without entering the OS

To create a RAID/SATA driver disk without entering the OS

1. Boot your computer.
2. Press <Del> during POST to enter the BIOS setup utility.
3. Set the optical drive as the primary boot device.
4. Insert the support DVD into the optical drive.
5. Save changes and exit BIOS.
6. Press any key when the system prompts "Press any key to boot from the optical drive."
7. When the menu appears, press <1> to create a RAID driver disk.
8. Insert a formatted floppy disk into the floppy drive then press <Enter>.
9. Follow succeeding screen instructions to complete the process.

### 6.1.2 Creating a RAID/SATA driver disk in Windows®

To create a RAID driver disk in Windows® environment

1. Start Windows®.
2. Place the motherboard support DVD into the optical drive.
3. Go to the **Make Disk** menu, then select the RAID driver disk you wish to create:
  - Click **Make Intel ICH9R AHCI/RAID 32bit Driver** to create an Intel® ICH9R RAID driver disk for a 32-bit system.
  - Click **Make Intel ICH9R AHCI/RAID 64bit Driver** to create an Intel® ICH9R RAID driver disk for a 64-bit system.
4. Insert a floppy disk/USB device into the floppy disk drive/USB port.
5. Follow succeeding screen instructions to complete the process.



---

Write-protect the floppy disk to avoid computer virus infection.

---

## 6.1.3 Installing the RAID controller driver

### Windows® XP OS

To install the RAID controller driver when installing Windows® XP OS

1. Boot the computer using the Windows® XP installation CD. The Windows® XP Setup starts.
2. Press <F6> when the message “**Press F6 if you need to install a third party SCSI or RAID driver...**” appears at the bottom of the screen.
3. When prompted, press <S> to specify an additional device.

```
Windows Setup
-----
Setup could not determine the type of one or more mass storage devices
installed in your system, or you have chosen to manually specify an adapter.
Currently, Setup will load support for the following mass storage device(s):

<none>

* To specify additional SCSI adapters, CD-ROM drives, or special
  disk controllers for use with Windows, including those for
  which you have a device support disk from a mass storage device
  manufacturer, press S.

* If you do not have any device support disks from a mass storage
  device manufacturer, or do not want to specify additional
  mass storage devices for use with Windows, press ENTER.

S=Specify Additional Device  ENTER=Continue  F3=Exit
```

4. Insert the RAID driver disk you created earlier to the floppy disk drive, then press <Enter>.

```
Windows Setup
-----

Please insert the disk labeled
Manufacturer-supplied hardware support disk
into Drive A:

* Press ENTER when ready.

ENTER=Continue  ESC=Cancel  F3=Exit
```

5. Select the RAID controller driver from the list, then press <Enter>.

### Marvell 6145 SATA Controller

Select **Marvell 61XX SATA Controller 32bit Driver** for 32bit Windows Server OS, **Marvell 61XX SATA Controller 64bit Driver** for 64bit Windows Server OS, **Marvell 61XX SATA Controller Vista 32bit Driver** for 32bit Windows Vista OS, or **Marvell 61XX SATA Controller Vista 64bit Driver** for 64bit Windows Vista OS, and then press <Enter>.

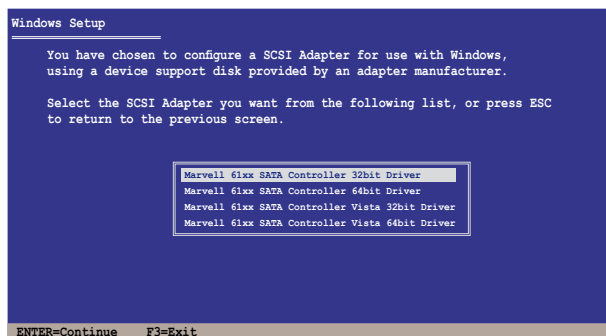

### Intel Matrix Storage

Select **Intel(R) 82801GR/GH SATA RAID Controller (Desktop ICH7RDH)** for Intel Matrix Storage RAID mode from the list, then press <Enter>.

If you configured SATA as AHCI Mode in the BIOS setup utility of IDE Configuration, first install the **Intel SATA AHCI Driver** during windows setup. Then, select the **Intel(R) 82801GR/GH SATA AHCI Controller (Desktop ICH7RDH)** from the list. Refer to section 6.1.1 **Creating a RAID driver disk** to create the Intel SATA Driver for windows system.

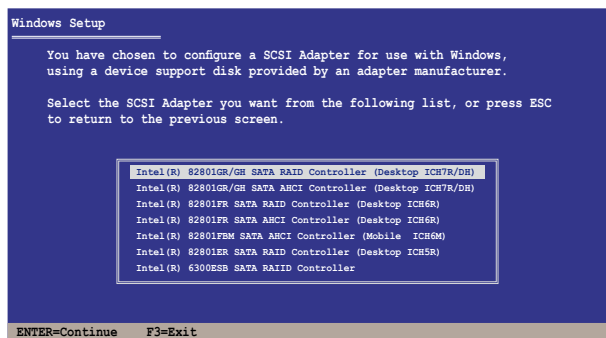



6. The Windows® Setup loads the RAID controller drivers from the RAID driver disk. When prompted, press <Enter> to continue installation.
7. Setup then proceeds with the OS installation. Follow screen instructions to continue.

## Windows® Vista OS

To install the RAID controller driver when installing Windows® Vista OS

1. Insert the floppy disk with RAID driver into the floppy disk drive.
2. During the OS installation, select **Load Driver**, click **Browse**, then select **Floppy Disk Drive (A:)**. Click **OK**.
3. Select **Intel ICH9R** and click **Next**.
4. Follow the succeeding screen instructions to complete the installation.

### 6.1.4 Installing an operating system

This motherboard supports Windows® XP/64-bit XP/Vista/64-bit Vista operating systems (OS). Always install the latest OS version and corresponding updates to maximize the features of your hardware.



- 
- Motherboard settings and hardware options vary. Use the setup procedures presented in this chapter for reference only. Refer to your OS documentation for detailed information.
  - Make sure that you install Windows® XP Service Pack 2 or later versions before installing the drivers for better compatibility and system stability.
-

## 6.2 Support DVD information

The support DVD that came with the motherboard package contains the drivers, software applications, and utilities that you can install to avail all motherboard features.



The contents of the support DVD are subject to change at any time without notice. Visit the ASUS website([www.asus.com](http://www.asus.com)) for updates.

### 6.2.1 Running the support DVD

Place the support DVD to the optical drive. The DVD automatically displays the Drivers menu if Autorun is enabled in your computer.



Click an icon to display support DVD/motherboard information

Click an item to install



If Autorun is NOT enabled in your computer, browse the contents of the support DVD to locate the file ASSETUP.EXE from the BIN folder. Double-click the ASSETUP.EXE to run the DVD.

## 6.2.2 Drivers menu

The drivers menu shows the available device drivers if the system detects installed devices. Install the necessary drivers to activate the devices.



### **ASUS InstAll - Installation Wizard for Drivers**

Installs all of the drivers through the Installation Wizard.

### **Intel(R) Chipset Inf Update Program**

Installs the Intel® chipset Inf update program.

### **Realtek Audio Driver**

Installs the Realtek® ALC 888 audio driver and application.

### **USB 2.0 Driver**

Installs the Universal Serial Bus 2.0 (USB 2.0) driver.

## 6.2.3 Utilities menu

The Utilities menu shows the applications and other software that the motherboard supports.



Click to display the next page



Click to return to the previous page

### ASUS InstAll-Installation Wizard for Utilities

Installs all of the utilities through the Installation Wizard.

### ASUS PC Probe II

This smart utility monitors the fan speed, CPU temperature, and system voltages, and alerts you of any detected problems. This utility helps you keep your computer in healthy operating condition.

### ASUS AI Suite

Installs the ASUS AI Suite.

## **ASUS Update**

Allows you to download the latest version of the BIOS from the ASUS website.



---

Before using the ASUS Update, make sure that you have an Internet connection so you can connect to the ASUS website.

---

## **Adobe Acrobat Reader V7.0**

Installs the Adobe® Acrobat® Reader that allows you to open, view, and print documents in Portable Document Format (PDF).

## **Microsoft DirectX 9.0c**

Installs the Microsoft® DirectX 9.0 driver. The Microsoft DirectX® 9.0 is a multimedia technology that enhances computer graphics and sound. DirectX® improves the multimedia features of your computer so you can enjoy watching TV and movies, capturing videos, or playing games in your computer. Visit the Microsoft website ([www.microsoft.com](http://www.microsoft.com)) for updates.

## **WinDVD Copy5 Trial**

Installs the InterVideo DVD Copy5 trial version.

## **InterVideo MediaOne Gallery**

Installs the media library and all-in-one software.

## **Ulead PhotoImpact 12 SE**

Installs the PhotoImpact image editing software.

## **CyberLink PowerBackup**

Installs CyberLink PowerBackup to back up and restore your data easily.

## **Corel Snapfire Plus SE**

Installs Corel Snapfire Plus SE.

## **Anti-Virus Utility**

The anti-virus application detects and protects your computer from viruses that destroys data.

## 6.2.4 Make Disk menu

The Make Disk menu contains items to create Intel® ICH9R RAID driver disk/ Marvell® 61xx PATA/eSATA driver disk.



### **Make Intel ICH9R AHCI/RAID 32bit/64bit Driver**

Allows you to create an Intel® ICH9R RAID driver disk for a 32/64-bit system.

### **Make Marvell 61xx PATA/eSATA Driver**

Allows you to create a Marvell® 61xx PATA/eSATA driver disk.

## 6.2.5 Manual menu

The Manual menu contains a list of supplementary user manuals. Click an item to open the folder of the user manual.



Most user manual files are in Portable Document Format (PDF). Install the Adobe® Acrobat® Reader from the Utilities tab before opening a user manual file.



## 6.2.6 ASUS Contact information

Click the Contact tab to display the ASUS contact information. You can also find this information on the inside front cover of this user guide.

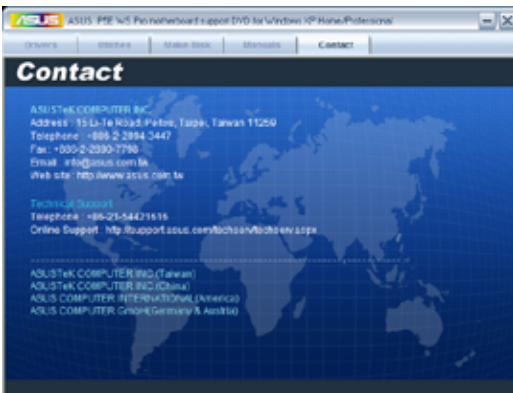





## Technical support Form

Displays the ASUS Technical Support Request Form that you have to fill out when requesting technical support.



ASUS TECHNICAL SUPPORT REQUEST FORM

REGISTRATION DESCRIPTION

COMPANY NAME: CONTACT NAME:

PHONE NUMBER: FAX # (AREA):

PHYSICAL ADDRESS: E-MAIL ADDRESS:

HARDWARE DESCRIPTION

| DESCRIPTION   | MODEL #1   | MODEL#(PLEASE) |
|---------------|------------|----------------|
| CPU BRAND     | SPED(CPU)  | SPED(CPU)      |
| CPU SPEED     | SPED(CPU)  | SPED(CPU)      |
| CACHE BRAND   | SPED(CPU)  | SPED(CPU)      |
| RAM SIZE      | MODEL NAME | MODEL NAME     |
| CD/DVD BRAND  | MODEL NAME | MODEL NAME     |
| BACKUP BRAND  | MODEL NAME | MODEL NAME     |
| OTHER STORAGE | MODEL NAME | MODEL NAME     |

ADD-ON CARD DESCRIPTION (MODEL NAME-VENDOR)

| DESCRIPTION  | MODEL NAME-VENDOR |
|--------------|-------------------|
| PCI SLOT #1  |                   |
| PCI SLOT #2  |                   |
| PCI SLOT #3  |                   |
| PCI SLOT #4  |                   |
| PCI SLOT #5  |                   |
| PCI SLOT #6  |                   |
| PCI SLOT #7  |                   |
| PCI SLOT #8  |                   |
| PCI SLOT #9  |                   |
| PCI SLOT #10 |                   |

SOFTWARE DESCRIPTION

OPERATING SYSTEM:

APPLICATION SOFTWARE:

DEVICE DRIVERS:

PROBLEM DESCRIPTION: (What PROBLEMS and UNDER WHAT SITUATIONS?)

## Filelist

Displays the contents of the support DVD and a brief description of each in text format.



File list for the included support software for ASUS WS P80 motherboard

| File Name   | Description |
|-------------|-------------|
| CHM         | ...         |
| CPU         | ...         |
| Motherboard | ...         |
| Audio       | ...         |
| LAN         | ...         |
| WiFi        | ...         |
| CPU         | ...         |
| WiFi        | ...         |
| HIS         | ...         |
| VCT         | ...         |
| Chipset     | ...         |
| Win_2003    | ...         |
| WinXP       | ...         |
| Win7        | ...         |
| Win8        | ...         |
| Win10       | ...         |
| Win11       | ...         |

## 6.3 Software information

Most of the applications in the Support DVD have wizards that will conveniently guide you through the installation. View the online help or readme file that came with the software application for more information.

### 6.3.1 ASUS MyLogo2™

The ASUS MyLogo2™ utility lets you customize the boot logo. The boot logo is the image that appears on screen during the Power-On Self-Tests (POST). The ASUS MyLogo2™ is automatically installed when you install the ASUS Update utility from the Support DVD. See section 6.2.3 **Utilities menu** for details.



- Before using the ASUS MyLogo2™, use the AFUDOS utility to make a copy of your original BIOS file, or obtain the latest BIOS version from the ASUS website. See section 4.1.4 **AFUDOS utility**.
- Make sure that the BIOS item Full Screen Logo is set to [Enabled] if you wish to use ASUS MyLogo2. See section 4.7.2 **Boot Settings Configuration**.
- You can create your own boot logo image in GIF file format.
- The file size should be smaller than 150 K.

To launch the ASUS MyLogo2™

1. Launch the ASUS Update utility. Refer to section 4.1.1 **ASUS Update utility** for details.
2. Select **Options** from the drop down menu, then click **Next**.
3. Check the option **Launch MyLogo** to replace system boot logo before flashing BIOS, then click **Next**.
4. Select **Update BIOS** from a file from the drop down menu, then click **Next**.
5. When prompted, locate the new BIOS file, then click **Next**. The ASUS MyLogo window appears.
6. From the left window pane, select the folder that contains the image you intend to use as your boot logo.



- When the logo images appear on the right window pane, select an image to enlarge by clicking on it.



- Adjust the boot image to your desired size by selecting a value on the Ratio box.



- When the screen returns to the ASUS Update utility, flash the original BIOS to load the new boot logo.
- After flashing the BIOS, restart the computer to display the new boot logo during POST.

### 6.3.2 Audio configurations

The Realtek® audio CODEC provides 8-channel audio capability to deliver the ultimate audio experience on your computer. The software provides Jack-Sensing function, S/PDIF Out support, and interrupt capability. The CODEC also includes the Realtek® proprietary UAJ® (Universal Audio Jack) technology for all audio ports, eliminating cable connection errors and giving users plug and play convenience.

Follow the installation wizard to install the Realtek® Audio Driver from the support CD/DVD that came with the motherboard package.

If the Realtek audio software is correctly installed, you will find the **Realtek HD Audio Manager** icon on the taskbar.

From the taskbar, double-click on the SoundEffect icon to display the Realtek HD Audio Manager.



Realtek HD Audio Manager

#### A. Realtek HD Audio Manager for Windows Vista™



## Information

Click the **Information** button (  ) to display information about the audio driver version, DirectX version, audio controller, audio codec, and language setting.

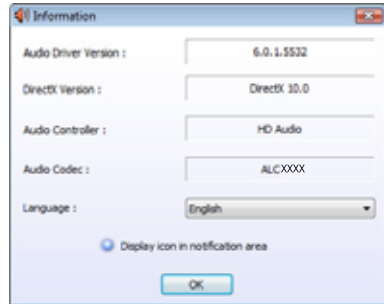

## Device advanced settings

Click **Device advanced settings** to show further settings for the playback and recording device.

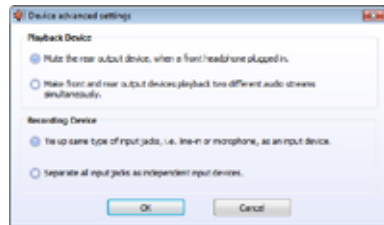

## Connector settings

Click the **Connector Settings** button (  ) to show further settings for the analog/digital output/input ports.

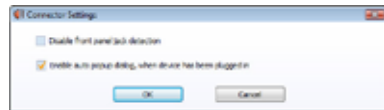

## Exit

Click the **Exit** button or the **OK** button (  ) to exit the Realtek HD Audio Manager.

## Configuration options

Click any of the tabs in this area to configure your audio settings.



The Configuration options shown in this section are for reference purposes only and may not exactly match what you see on your screen. In the Windows Vista™ environment, Realtek HD Audio Manager automatically detects devices connected to the analog/digital ports and shows corresponding configuration options tabs.

## Digital Output

The Realtek® audio CODEC allows you to connect an external audio output device via the coaxial/digital S/PDIF port. You can set your listening environment, set the karaoke, or select pre-programmed equalizer settings for your listening pleasure.

To set the digital output options

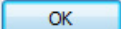
1. From the Realtek HD Audio Manager, click the **Digital Output** tab.
2. Click **Set Default Device** to set the digital output port as the default audio output device.
3. Click the **Sound Effects** sub-tab for options on changing the acoustic environment and karaoke settings, or click the **Default Format** sub-tab for options on changing the default audio output format.
4. Click  to effect the Digital Output settings and exit.



## Speakers

The **Speakers** tab allows you to configure audio output settings using the analog audio ports.

To set the speakers options

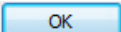
1. From the Realtek HD Audio Manager, click the **Speakers** tab.
2. Click **Set Default Device** to set the analog ports as the default audio output device.
3. Click the **Speaker Configuration** sub-tab for audio channel options and test.
4. Click the **Sound Effects** sub-tab for options on changing the acoustic environment and karaoke settings.
5. Click the **Room Correction** sub-tab for individual speaker distance adjustment.
6. Click the **Default Format** sub-tab for options on changing the default audio output format.
7. Click  to effect the Speakers settings and exit.

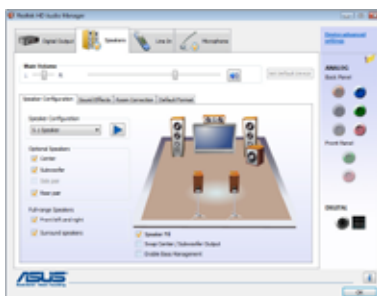

### Line In

The **Line In** tab allows you to configure audio input settings using the analog line in port.

To set the analog line in options

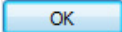
1. From the Realtek HD Audio Manager, click the **Line In** tab.
2. Click **Set Default Device** to set the analog line in port as the default audio input device.
3. The Line In tab allows you to adjust the recording and playback volume and set a default format for audio input.
4. Click  to effect the Line In settings and exit.

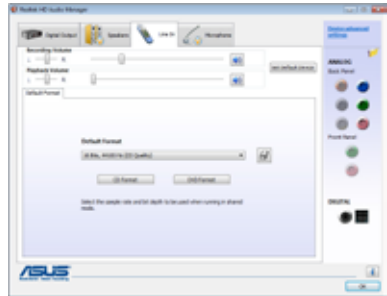

### Microphone

The **Microphone** tab allows you to configure the audio input settings using the analog microphone port and to check if your microphone device is connected properly.

To set the Microphone options

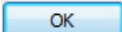
1. From the Realtek HD Audio Manager, click the **Microphone** tab.
2. In the **Microphone Effects** sub-tab, click the **Noise Suppression** option button to reduce the static background noise when recording. Click the **Acoustic Echo Cancellation** option button to reduce the echo from the front speakers when recording. Click the **Beam Forming** option button to eliminate surrounding noise interferences.
3. Click the **Default Format** sub-tab for options on changing the default audio input format.
4. Click  to effect the Microphone settings and exit.



## B. Realtek HD Audio Manager for Windows XP™



### Information

Click the information button (  ) to display information about the audio driver version, DirectX version, audio controller, audio codec, and language setting.



### Minimize

Click the minimize button (  ) to minimize the window.

### Exit

Click the exit button (  ) to exit the Realtek HD Audio Manager.



## Configuration options

Click any of the tabs in this area to configure your audio settings.

### Sound Effect

The Realtek® audio CODEC allows you to set your listening environment, adjust the equalizer, set the karaoke, or select pre-programmed equalizer settings for your listening pleasure.

To set the sound effect options

1. From the Realtek HD Audio Manager, click the **Sound Effect** tab.
2. Click the shortcut buttons or the drop-down menus for options on changing the acoustic environment, adjust the equalizer, or set the karaoke to your desired settings.
3. Click  to effect the Sound Effect settings and exit.



### Mixer

The Mixer option allows you to configure audio output (playback) volume and audio input (record) volume.

To set the mixer options

1. From the Realtek HD Audio Manager, click the **Mixer** tab.
2. Turn the volume buttons to adjust the Playback and/or Record volume.



The Mixer option activates voice input from all channels by default. Make sure to set all channels to mute (  ) if you do not want voice input.

3. Make adjustments to Wave, SW Synth, Front, Rear, CD volume, Mic volume, Line Volume, and Stereo mix, etc. by clicking the control tabs and dragging them up and down until you get the desired levels.



Click the next button (  ) to display more menu options.

4. Click  to effect the Mixer settings and exit.

### Audio I/O

The Audio I/O option allows you configure your input/output settings.

To set the Audio I/O options



1. From the Realtek HD Audio Manager, click the **Audio I/O** tab.
2. Click the drop-down menu to select the channel configuration.
3. The control settings window displays the status of connected devices. Click  for analog and digital options.
4. Click <OK> to effect the Audio I/O settings and exit



### Microphone

The Microphone option allows you configure your input/output settings and to check if your audio devices are connected properly.

To set the Microphone options

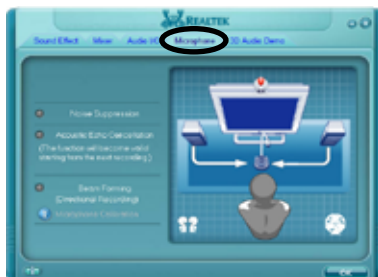

1. From the Realtek HD Audio Manager, click the **Microphone** tab.
2. Click the **Noise Suppression** option button to reduce the static background noise when recording.
3. Click the **Acoustic Echo Cancellation** option button to reduce the echo from the front speakers when recording.
4. Click the **Beam Forming** option button to eliminate surrounding noise interferences. Click  to start microphone calibration.
5. Click  to effect the Microphone settings and exit.



### 3D Audio Demo

The 3D Audio Demo option gives you a demonstration of the 3D audio feature.

To start the 3D Audio Demo

1. From the Realtek HD Audio Manager, click the **3D Audio Demo** tab.
2. Click the option buttons to change the sound, moving path, or environment settings.
3. Click  to test your settings.
4. Click  to effect the 3D Audio Demo settings and exit.



### 6.3.3 ASUS PC Probe II

PC Probe II is a utility that monitors the computer's vital components, and detects and alerts you of any problem with these components. PC Probe II senses fan rotations, CPU temperature, and system voltages, among others. Because PC Probe II is software-based, you can start monitoring your computer the moment you turn it on. With this utility, you are assured that your computer is always at a healthy operating condition.

#### Installing PC Probe II

To install PC Probe II on your computer:

1. Place the Support DVD to the optical drive. The Drivers installation tab appears if your computer has an enabled Autorun feature.



---

If Autorun is not enabled in your computer, browse the contents of the Support DVD to locate the setup.exe file from the ASUS PC Probe II folder. Double-click the **setup.exe** file to start installation.

---

2. Click the **Utilities** tab, then click **ASUS PC Probe II**.
3. Follow the screen instructions to complete installation.

#### Launching PC Probe II

You can launch the PC Probe II right after installation or anytime from the Windows® desktop.

To launch the PC Probe II from the Windows® desktop, click **Start > All Programs > ASUS > PC Probe II > PC Probe II v1.xx.xx**. The PC Probe II main window appears.

After launching the application, the PC Probe II icon appears in the Windows® taskbar. Click this icon to close or restore the application.









#### Using PC Probe II

##### Main window

The PC Probe II main window allows you to view the current status of your system and change the utility configuration. By default, the main window displays the Preference section. You can close or restore the Preference section by clicking on the triangle on the main window right handle.



Click to close the Preference panel

| Button  | Function  |
|---|---|
|  | Opens the Configuration window                      |
|  | Opens the Report window                             |
|  | Opens the Desktop Management Interface window       |
|  | Opens the Peripheral Component Interconnect window  |
|  | Opens the Windows Management Instrumentation window |
|  | Opens the hard disk drive, memory, CPU usage window |
|  | Shows/Hides the Preference section                  |
|  | Minimizes the application                           |
|  | Closes the application                              |

### Sensor alert

When a system sensor detects a problem, the main window right handle turns red, as the illustrations below show.



When displayed, the monitor panel for that sensor also turns red. Refer to the Monitor panels section for details.

### Preference

You can customize the application using the Preference section in the main window. Click the box before each preference to activate or deactivate.

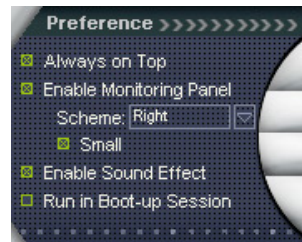

## Hardware monitor panels

The hardware monitor panels display the current value of a system sensor such as fan rotation, CPU temperature, and voltages.

The hardware monitor panels come in two display modes: hexagonal (large) and rectangular (small). When you check the Enable Monitoring Panel option from the Preference section, the monitor panels appear on your computer's desktop.



Large display



Small display

### Changing the monitor panels position

To change the position of the monitor panels in the desktop, click the arrow down button of the Scheme options, then select another position from the list box. Click OK when finished.



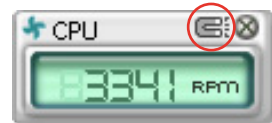

### Moving the monitor panels

All monitor panels move together using a magnetic effect. If you want to detach a monitor panel from the group, click the horseshoe magnet icon. You can now move or reposition the panel independently.



### Adjusting the sensor threshold value

You can adjust the sensor threshold value in the monitor panel by clicking the  or  buttons. You can also adjust the threshold values using the Config window.

You cannot adjust the sensor threshold values in a small monitoring panel.

Click to increase value

Click to decrease value



### Monitoring sensor alert

The monitor panel turns red when a component value exceeds or is lower than the threshold value. Refer to the illustrations below.



Large display



Small display

### WMI browser

Click **WMI** to display the WMI (Windows Management Instrumentation) browser. This browser displays various Windows® management information. Click an item from the left panel to display on the right panel. Click the plus sign (+) before WMI Information to display the available information.



You can enlarge or reduce the browser size by dragging the bottom right corner of the browser.

### DMI browser

Click **DMI** to display the DMI (Desktop Management Interface) browser. This browser displays various desktop and system information. Click the plus sign (+) before DMI Information to display the available information.



## PCI browser

Click **PCI** to display the PCI (Peripheral Component Interconnect) browser. This browser provides information on the PCI devices installed on your system. Click the plus sign (+) before the PCI Information item to display available information.



## Usage

The Usage browser displays real-time information on the CPU, hard disk drive space, and memory usage. Click **USAGE** to display the Usage browser.

### Hard disk drive space usage

The Hard Disk tab displays the used and available hard disk drive space. The left panel of the tab lists all logical drives. Click a hard disk drive to display the information on the right panel. The pie chart at the bottom of the window represents the used (blue) and the available HDD space.



### Memory usage

The Memory tab shows both used and available physical memory. The pie chart at the bottom of the window represents the used (blue) and the available





### CPU usage

The CPU tab displays real-time CPU usage in line graph representation. If the CPU has an enabled Hyper-Threading, two separate line graphs display the operation of the two logical processors.

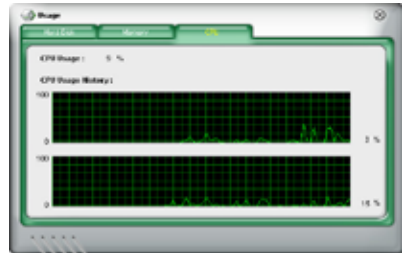

## Configuring PC Probe II

Click  to view and adjust the sensor threshold values.

The Config window has two tabs: Sensor/Threshold and Preference. The Sensor/Threshold tab enables you to activate the sensors or to adjust the sensor threshold values. The Preference tab allows you to customize sensor alerts, or change the temperature scale.

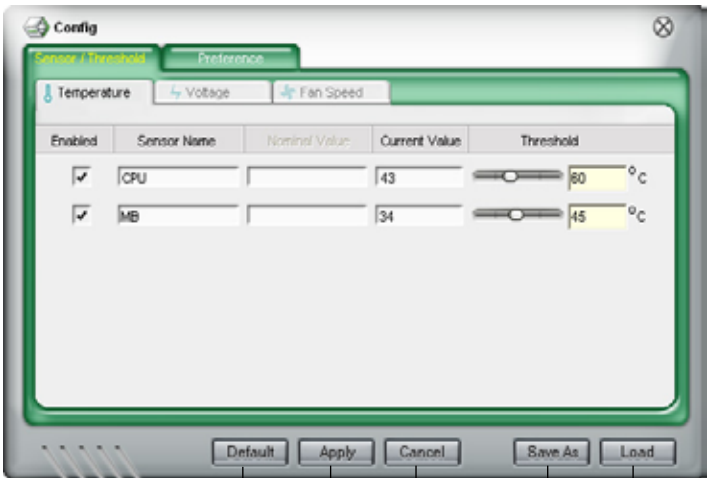

Loads the default threshold values for each sensor

Applies your changes

Cancels or ignores your changes

Loads your saved configuration

Saves your configuration

### 6.3.4 ASUS AI Suite

ASUS AI Suite allows you to launch AI Gear 2, AI N.O.S., AI Booster, AI Nap, and Q-Fan 2 utilities easily.

#### Installing AI Suite

To install AI Suite on your computer:

1. Place the support DVD to the optical drive. The Drivers installation tab appears if your computer has an enabled Autorun feature.
2. Click the Utilities tab, then click **AI Suite**.
3. Follow the screen instructions to complete installation.

#### Launching AI Suite

You can launch the AI Suite right after installation or anytime from the Windows® desktop.

To launch the AI Suite from the Windows® desktop, click **Start > All Programs > ASUS > AI Suite > AI Suite v1.xx.xx**. The AI Suite main window appears.

After launching the application, the AI Suite icon appears in the Windows® taskbar. Click this icon to close or restore the application.

#### Using AI Suite

Click the AI N.O.S., AI Gear 2, AI Nap, AI Booster, or Q-Fan 2 icon to launch the utility, or click the Normal icon to restore the system to normal state.

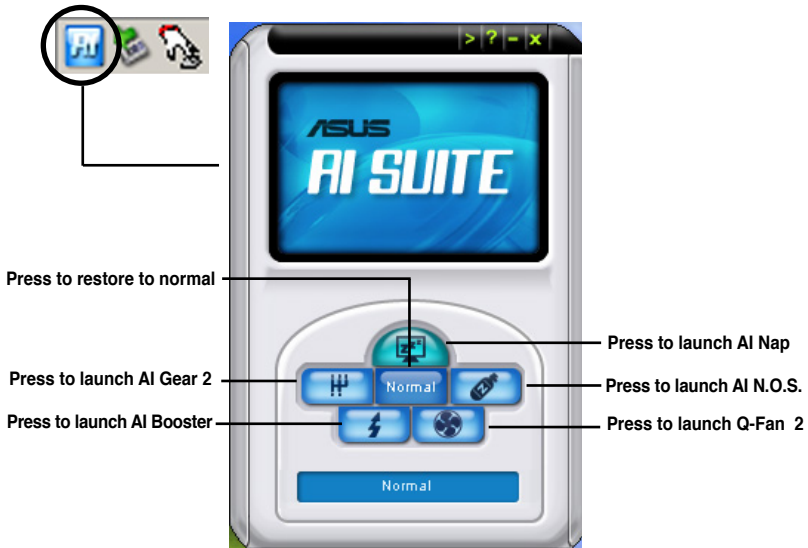

## Other feature buttons

Click  on right corner of the main window to open the monitor window.



Click  on right corner of the expanded window to switch the temperature from degrees Centigrade to degrees Fahrenheit.



### 6.3.5 ASUS AI Gear 2

ASUS AI Gear 2 provides four system performance options that allows you to select the best performance setting for your computing needs. This easy-to-use utility adjusts the processor frequency and vCore voltage to minimize system noise and power consumption.

After installing AI Suite from the bundled support DVD, you can launch AI Gear 2 by double-clicking the AI Suite icon on your Windows OS taskbar and then click the AI Gear 2 button on the AI Suite main window.

Shift the gear to the performance setting that you like.

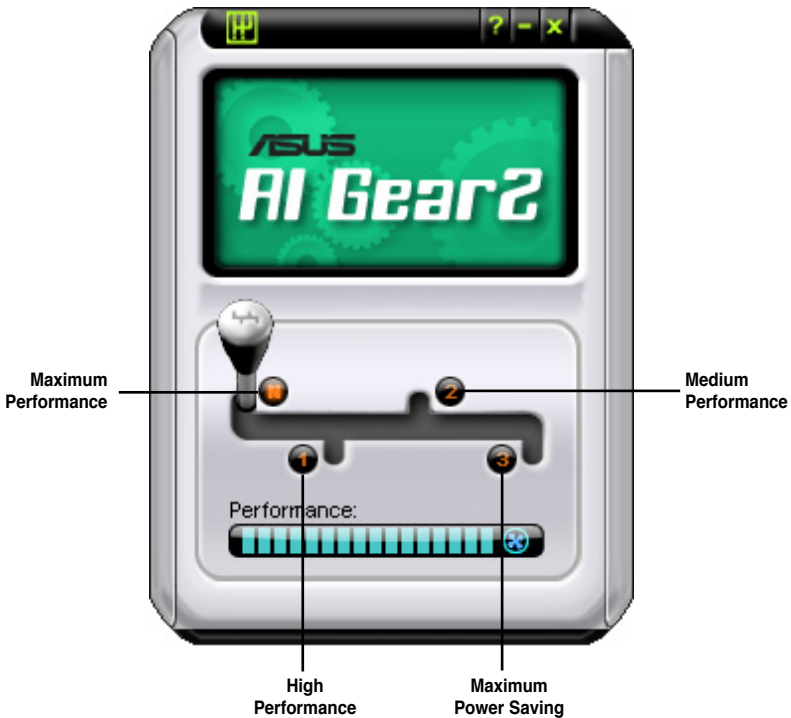

### 6.3.6 ASUS AI Nap

This feature allows you to minimize the power consumption of your computer whenever you are away. Enable this feature for minimum power consumption and a quieter system operation.

After installing AI Suite from the bundled support DVD, you can launch the utility by double-clicking the AI Suite icon on the Windows OS taskbar and click the AI Nap button on the AI Suite main window.

Click **Yes** on the confirmation screen.

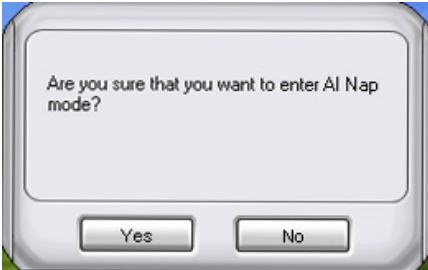

To exit AI Nap mode, press the system power or mouse button then click **Yes** on the confirmation screen.

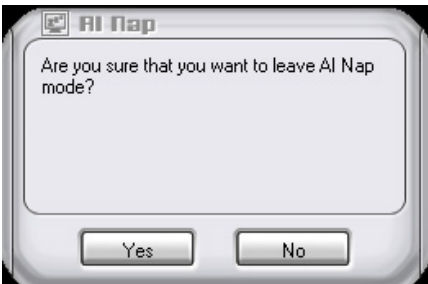

---

To switch the power button functions from AI Nap to shutting down, just right click the **AI Suite** icon on the OS taskbar, select **AI Nap** and click **Use power button**. Unclick the the item to switch the function back.

---

### 6.3.7 ASUS AI N.O.S.

This ASUS Non-delay Overclocking System feature intelligently determines the system load and automatically boosts the performance for the most demanding tasks.

After installing AI Suite from the bundled support DVD, you can launch the utility by double-clicking the AI Suite icon on the Windows OS taskbar and click the AI N.O.S. button on the AI Suite main window.

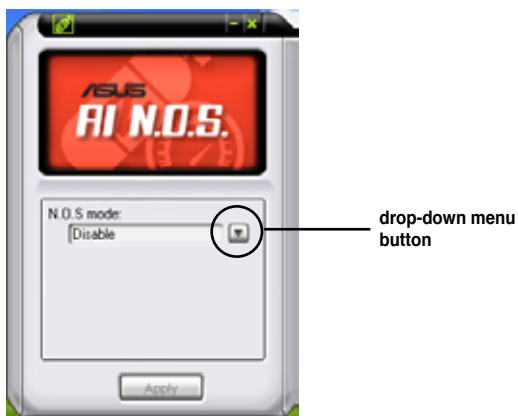

Click the drop-down menu button and select **Disable** or **Manual**.

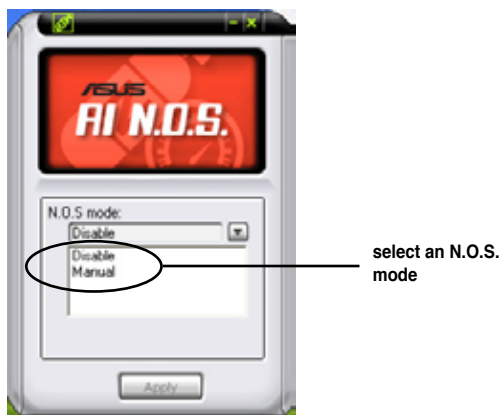

Click **Apply** at the bottom to save the configuration.

### 6.3.8 ASUS Q-Fan 2

This ASUS Q-Fan 2 Control feature allows you to set the appropriate performance level of the CPU Q-Fan 2 or the Chassis Q-Fan 2 for more efficient system operation. After enabling the Q-Fan 2 function, the fans can be set to automatically adjust depending on the temperature, to decrease fan speed, or to achieve the maximum fan speed.

After installing AI Suite from the bundled support DVD, you can launch the utility by double-clicking the AI Suite icon on the Windows® OS taskbar and click the Q-Fan 2 button on the AI Suite mAIIn window.

Click the drop-down menu button and display the fan names. Select **CPU Q-Fan** or **CHASSIS Q-Fan**. Click the **Enabled** box to activate this function.



**Profile** list appears after clicking the **Enabled** box. Click the drop-down list button and select a profile. **Optimal** mode makes the fans adjust speed with the temperature; **Silent** mode minimizes fan speed for quiet fan operation; **Performance** mode boosts the fan to achieve maximal fan speed for the best cooling effect.

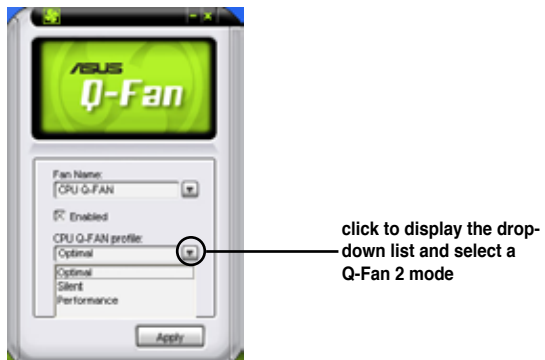

Click **Apply** at the bottom to save the setup.

### 6.3.9 ASUS AI Booster

The ASUS AI Booster application allows you to overclock the CPU speed in Windows® environment without the hassle of booting the BIOS.

After installing AI Suite from the bundled support DVD, you can launch the utility by double-clicking the AI Suite icon on the Windows® OS taskbar and click the AI Booster button on the AI Suite main window.

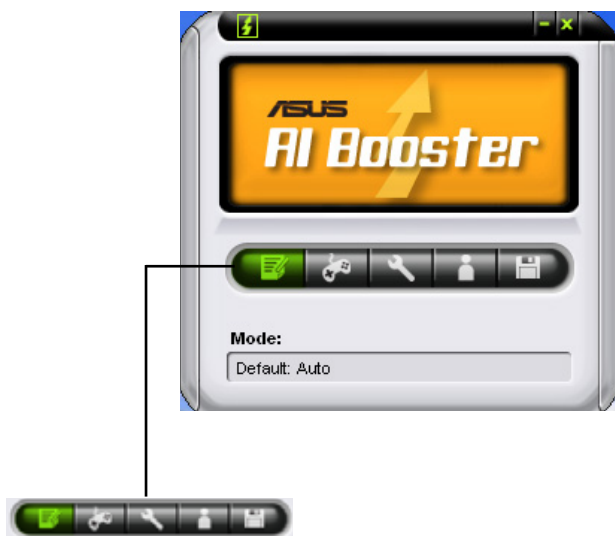

The options on the taskbar allow you to use the default settings, adjust CPU/Memory/PCI-E frequency manually, or create and apply your personal overclocking configurations.



# Appendix

This section provides information about the CPU features and technologies and a troubleshooting guide for solving common problems when using the barebone workstation.



ASUS TW300-E5/P14

Download from [Www.Somanuals.com](http://www.Somanuals.com). All Manuals Search And Download.

# Reference information

## A.1 Intel® EM64T

---



- The motherboard is fully compatible with Intel® LGA775 processors running on 32-bit operating systems.
  - The motherboard comes with a BIOS file that supports EM64T. You can download the latest BIOS file from the ASUS website ([www.asus.com/support/download/](http://www.asus.com/support/download/)) if you need to update the BIOS file. See Chapter 4 for details.
  - Visit [www.intel.com](http://www.intel.com) for more information on the EM64T feature.
  - Visit [www.microsoft.com](http://www.microsoft.com) for more information on Windows® 64-bit OS.
- 

### Using the Intel® EM64T feature

To use the Intel® EM64T feature:

1. Install an Intel® CPU that supports the Intel® EM64T.
2. Install a 64-bit operating system (Windows® Vista 64-bit Edition or Windows® XP Professional x64 Edition).
3. Install the 64-bit drivers for the motherboard components and devices from the support DVD.
4. Install the 64-bit drivers for expansion cards or add-on devices, if any.



Refer to the expansion card or add-on device(s) documentation, or visit the related website, to verify if the card/device supports a 64-bit system.

---

## A.2 Enhanced Intel SpeedStep® Technology (EIST)

---



- The motherboard comes with a BIOS file that supports EIST. You can download the latest BIOS file from the ASUS website ([www.asus.com/support/download/](http://www.asus.com/support/download/)) if you need to update the BIOS. See Chapter 4 for details.
  - Visit [www.intel.com](http://www.intel.com) for more information on the EIST feature.
- 

### A.2.1 System requirements

Before using EIST, check your system if it meets the following requirements:

- Intel® processor with EIST support
- BIOS file with EIST support
- Operating system with EIST support (Windows® Vista, Windows® XP SP2 / Linux 2.6 kernel or later versions)

## A.2.2 Using the EIST

To use the EIST feature:

1. Turn on the computer, then enter the BIOS Setup.
2. Go to the **Advanced** Menu, highlight **CPU Configuration**, then press <Enter>.
3. Set the **Intel(R) SpeedStep Technology** item to [Enabled], and then press <Enter>.
4. Press <F10> to save your changes and exit the BIOS setup.
5. After the computer restarts, right click on a blank space on the desktop, then select **Properties** from the pop-up menu.
6. When the **Display Properties** window appears, click the **Screen Saver** tab.
7. Click the **Power** button on the **Monitor** power section to open the **Power Options Properties** window.

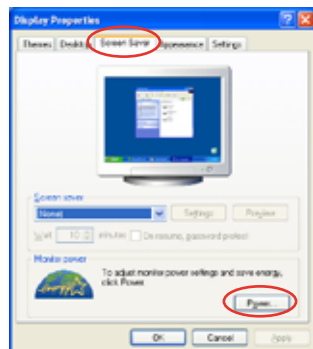

8. On the **Power schemes** section, click , then select any option except Home/Office Desktop or Always On.
9. Click **Apply**, then click **OK**.
10. Close the **Display Properties** window.

After you adjust the power scheme, the CPU internal frequency slightly decreases when the CPU loading is low.

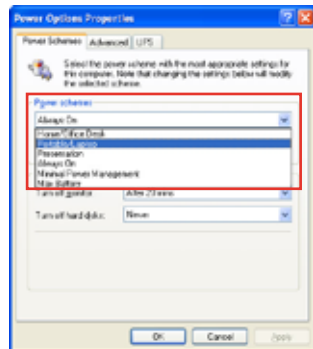

The screen displays and procedures may vary depending on the operating system.

## A.3 Intel® Hyper-Threading Technology

---



- The motherboard supports Intel® Pentium® LGA775 processors with Hyper-Threading Technology.
  - Hyper-Threading Technology is supported under Windows® Vista/XP and Linux 2.4.x (kernel) and later versions only. Under Linux, use the Hyper-Threading compiler to compile the code. If you are using any other operating systems, disable the Hyper-Threading Technology item in the BIOS to ensure system stability and performance.
  - Installing Windows® XP Service Pack 1 or later version is recommended.
  - Make sure to enable the Hyper-Threading Technology item in BIOS before installing a supported operating system.
  - For more information on Hyper-Threading Technology, visit [www.intel.com/info/hyperthreading](http://www.intel.com/info/hyperthreading).
- 

### Using the Hyper-Threading Technology

To use the Hyper-Threading Technology:

1. Install an Intel® Pentium® CPU that supports Hyper-Threading Technology.
2. Power up the system and enter the BIOS Setup. Under the **Advanced** menu, make sure that the item **Hyper-Threading Technology** is set to [Enabled].  
The BIOS item appears only if you installed a CPU that supports Hyper-Threading Technology.
3. Restart the computer.

## A.4 Simple fixes



Some problems that you may encounter are not due to defects on the system or the components. These problems only requires simple troubleshooting actions that you can perform by yourself.

| Problem  | Action  |
|--|---|
| <b>The power LED on the workstation or on the monitor do not light up</b>            | <ol style="list-style-type: none"><li>1. Check if the power cable is properly connected to the power connector in the system rear panel.</li><li>2. Ensure that the power cables are connected to a grounded power outlet.</li><li>3. Press the power button to make sure that the system is turned on.</li></ol> |
| <b>The keyboard does not work</b>  | Check if the keyboard cable is properly connected to the PS/2 keyboard port.  |
| <b>The mouse does not work</b>   | Check if the mouse cable is properly connected to the mouse port.   |
| <b>The system does not perform power-on self tests (POST) after it was turned on</b> | <ol style="list-style-type: none"><li>1. Check the memory modules and make sure you installed the DIMMs the system supports.</li><li>2. Ensure that the DIMMs are properly installed on the sockets.</li></ol>  |
| <b>The system continuously beeps after it was turned on.</b>                         | <ol style="list-style-type: none"><li>1. Check the memory modules and make sure you installed supported DIMMs.</li><li>2. Ensure that the DIMMs are properly installed on the sockets.</li></ol>  |
| <b>The message “Non-system disk or disk error” appears</b>                           | <ol style="list-style-type: none"><li>1. Check if a bootable HDD is active.</li><li>2. Check if the HDDs are properly installed.</li></ol>  |
| <b>Network connection not available</b>  | <ol style="list-style-type: none"><li>1. Ensure that the network cable is connected to the LAN port on the rear panel.</li><li>2. Ensure that you have installed the LAN drivers from the support CD.</li></ol>   |



## Free Manuals Download Website

<http://myh66.com>

<http://usermanuals.us>

<http://www.somanuals.com>

<http://www.4manuals.cc>

<http://www.manual-lib.com>

<http://www.404manual.com>

<http://www.luxmanual.com>

<http://aubethermostatmanual.com>

Golf course search by state

<http://golfingnear.com>

Email search by domain

<http://emailbydomain.com>

Auto manuals search

<http://auto.somanuals.com>

TV manuals search

<http://tv.somanuals.com>