



Rack Gigabit Switch Layer 2

24 ports 10/100Mbps Ethernet Switch

with 2 ports

1000BASE-T or 1000BASE-SX

User's Guide

The Atlantis Land logo is a registered trademark of Atlants Land SpA. All other names mentioned mat be trademarks or registered trademarks of their respective owners. Subject to change without notice. No liability for technical errors and/or omissions.

FCC Warning

This equipment has been tested and found to comply with the regulations for a Class A digital device, pursuant to Part 15 of the FCC Rules. These limits are designed to provide reasonable protection against harmful interference when the equipment is operated in a commercial environment. This equipment generates, uses, and can radiate radio frequency energy and, if not installed and used in accordance with this user's guide, may cause harmful interference to radio communications. Operation of this equipment in a residential area is likely to cause harmful interference, in which case the user will be required to correct the interference at his or her own expense.

CE Mark Warning

This is a Class A product. In a domestic environment, this product may cause radio interference, in which case the user may be required to take adequate measures.

A02-F24-2C(F)/M2 (september 2002)

TABLE OF CONTENTS

ABOUT THIS GUIDE	II
TERMS/USAGE	II
INTRODUCTION	1
FAST ETHERNET TECHNOLOGY.....	1
GIGABIT ETHERNET TECHNOLOGY	1
SWITCHING TECHNOLOGY	3
FEATURES	4
UNPACKING AND INSTALLATION	5
UNPACKING	5
INSTALLATION	6
RACK MOUNTING	7
IDENTIFYING EXTERNAL COMPONENTS	9
FRONT PANEL	9
REAR PANEL	10
UNDERSTANDING LED INDICATORS	11
PORTS 1~24 STATUS LEDs	12
PORT 25 & PORT 26 STATUS LEDs.....	13
CONNECTING THE SWITCH.....	15
CONNECTING STEP-BY-STEP.....	15
CABLE SPECIFICATION.....	16
CONFIGURING THE SWITCH.....	17
PORT SPEED & DUPLEX MODE	17
CONFIGURATION VIA CONSOLE PORT	17
TECHNICAL SPECIFICATIONS.....	19

ABOUT THIS GUIDE

Congratulations on your purchase of the *Management/Smart Gigabit & Fast Ethernet Switch (2×1000BASE plus 24×10/100BASE ports)*.

In this guide, you will find about the following four models:

1. 2×1000BASE-T plus 24×10/100BASE-TX Gigabit Switch
2. 2×1000BASE-SX plus 24×10/100BASE-TX Gigabit Switch

These four are designed to deliver full scalability of 10/100/1000Mbps, providing a simple solution to today's complicated networking environment.

Terms/Usage

In this guide, the term “**Switch**” (first letter upper case) refers to your *Management/Smart Gigabit & Fast Ethernet Switch (2×1000BASE plus 24×10/100BASE ports)*, and ”**switch**” (first letter lower case) refers to other Ethernet switches.

INTRODUCTION

This chapter describes the features of the Switch and some background information about Ethernet/Fast Ethernet/Gigabit Ethernet switching technology.

Fast Ethernet Technology

The growing importance of LANs and the increasing complexity of desktop computing applications are fueling the need for high performance networks. A number of high-speed LAN technologies have been proposed to provide greater bandwidth and improve client/server response times. Among them, 100BASE-T (Fast Ethernet) provides a non-disruptive, smooth evolution from the current 10BASE-T technology. The non-disruptive and smooth evolution nature, and the dominating potential market base, virtually guarantee cost-effective and high performance Fast Ethernet solutions.

100Mbps Fast Ethernet is a standard specified by the IEEE 802.3 LAN committee. It is an extension of the 10Mbps Ethernet standard with the ability to transmit and receive data at 100Mbps, while maintaining the CSMA/CD Ethernet protocol. Since the 100Mbps Fast Ethernet is compatible with all other 10Mbps Ethernet environments, it provides a straightforward upgrade and takes advantage of the existing investment in hardware, software, and personnel training.

Gigabit Ethernet Technology

Gigabit Ethernet is an extension of IEEE 802.3 Ethernet utilizing the same packet structure, format, and support for CSMA/CD protocol, full duplex, flow control, and management objects, but with a tenfold

increase in theoretical throughput over 100-Mbps Fast Ethernet and a hundredfold increase over 10-Mbps Ethernet. Since it is compatible with all 10-Mbps and 100-Mbps Ethernet environments, Gigabit Ethernet provides a straightforward upgrade without wasting a company's existing investment in hardware, software, and trained personnel.

The increased speed and extra bandwidth offered by Gigabit Ethernet are essential to coping with the network bottlenecks that frequently develop as computers and their busses get faster and more users use applications that generate more traffic. Upgrading key components, such as your backbone and servers to Gigabit Ethernet can greatly improve network response times as well as significantly speed up the traffic between your subnets.

Gigabit Ethernet supports video conferencing, complex imaging, and similar data-intensive applications. Likewise, since data transfers occur 10 times faster than Fast Ethernet, servers outfitted with Gigabit Ethernet NIC's are able to perform 10 times the number of operations in the same amount of time.

The phenomenal bandwidth delivered by Gigabit Ethernet was the most cost-effective method to take advantage of today's rapidly improving switching and routing internetworking technologies. And with expected advances in silicon technology and digital signal processing that enabled Gigabit Ethernet to eventually operate over unshielded twisted-pair (UTP) cabling, outfitting your network with a powerful 1000-Mbps-capable backbone/server connection creates a flexible foundation for the next generation of network technology products.

Switching Technology

Another approach to pushing beyond the limits of Ethernet technology is the development of switching technology. A switch bridges Ethernet packets at the MAC address level of the Ethernet protocol transmitting among connected Ethernet or Fast Ethernet LAN segments.

Switching is a cost-effective way of increasing the total network capacity available to users on a local area network. A switch increases capacity and decreases network loading by dividing a local area network into different *segments*, which don't compete with each other for network transmission capacity.

The switch acts as a high-speed selective bridge between the individual segments. The switch, without interfering with any other segments, automatically forwards traffic that needs to go from one segment to another. By doing this the total network capacity is multiplied, while still maintaining the same network cabling and adapter cards.

Switching LAN technology is a marked improvement over the previous generation of network bridges, which were characterized by higher latencies. Routers have also been used to segment local area networks, but the cost of a router, the setup and maintenance required make routers relatively impractical. Today switches are an ideal solution to most kinds of local area network congestion problems.

Features

- **24×10/100Mbps Auto-negotiation Ethernet ports and 2×10/100/1000Mbps Auto-negotiation Copper Gigabit Ethernet ports or 2×1000BASE-SX Fiber Gigabit Ethernet ports**
- **Auto MDI-X for all TX ports**
- **Full/half duplex transfer mode for each port**
- **Wire speed reception and transmission**
- **Store-and-Forward switching method**
- **Integrated address Look-Up Engine, supports 32K MAC addresses**
- **Supports 2Mbytes RAM for data buffering**
- **Supports port base VLAN / Trunking**
- **Supports IEEE 802.1p QoS**
- **Extensive front-panel diagnostic LEDs**
- **Broadcast storm protection**
- **IEEE 802.3x flow control for full-duplex**
- **Back pressure flow control for half-duplex**
- **Provide console port for easy configuration**
- **Standard 19” Rack-mount size**

UNPACKING AND INSTALLATION

This chapter provides unpacking and installation information for the Switch. To avoid causing any damage to the Switch, we recommend that you read this chapter carefully before starting installation.

Unpacking

Open the shipping carton of the Switch and carefully unpack the items inside. The carton should contain the following items:

- **The Smart Gigabit Ethernet Switch**
- **One AC power cord, suitable for your area's electrical power connections**
- **Four rubber pads to be used for shock cushioning**
- **Screws and two mounting brackets**
- **User's Guide**
- **Diskette for Manageable/Smart function user's guide**
- **Console Cable: RS232 9pin (male) to 9pin (male)**

If any item is found missing or damaged, please contact your local reseller for replacement.

Installation

The site where you place the Switch may greatly affect its performance. When installing, take the following into your consideration:

- **Install the Switch in a site free from strong electromagnetic field generators (such as motors), vibration, dust, and direct exposure to sunlight.**
- **Leave at least 10cm of space at the front and rear of the Switch for ventilation.**
- **Install the Switch on a sturdy, level surface that can support its weight, or in an EIA standard-size equipment rack.**
- **For information on rack installation, see the next section Rack Mounting.**
- **When installing the Switch on a level surface, attach the adhesive rubber pads to the bottom. The rubber pads cushion the Switch and protect its case from scratching.**

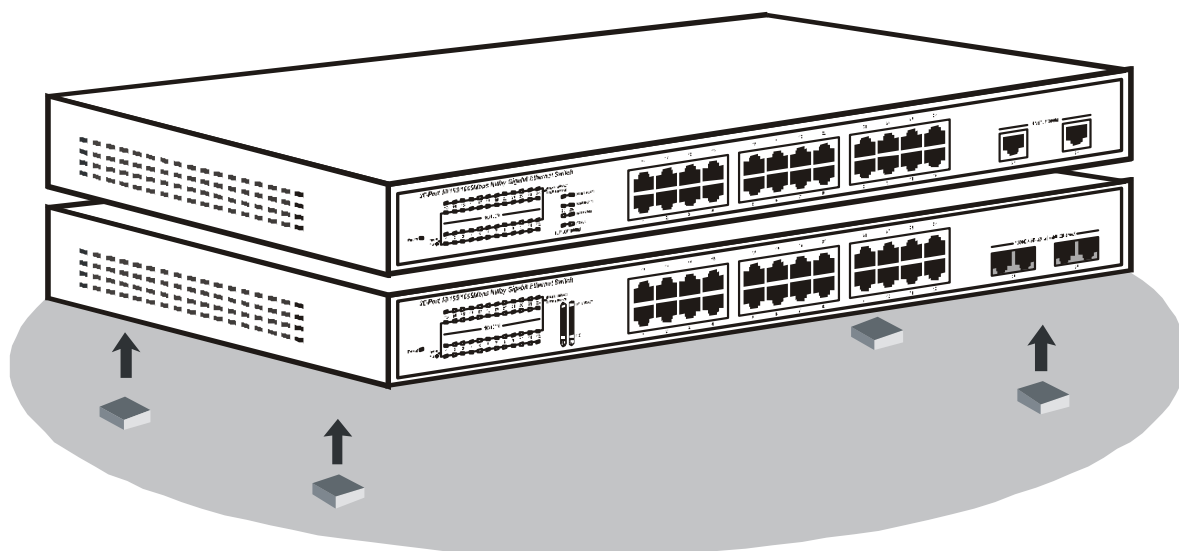

Rack Mounting

The Switch can be mounted in an EIA standard-size, 19-inch rack, which can be placed in a wiring closet with other equipments. Attach the mounting brackets to both sides of the Switch (one at each side), and secure them with the provided screws.

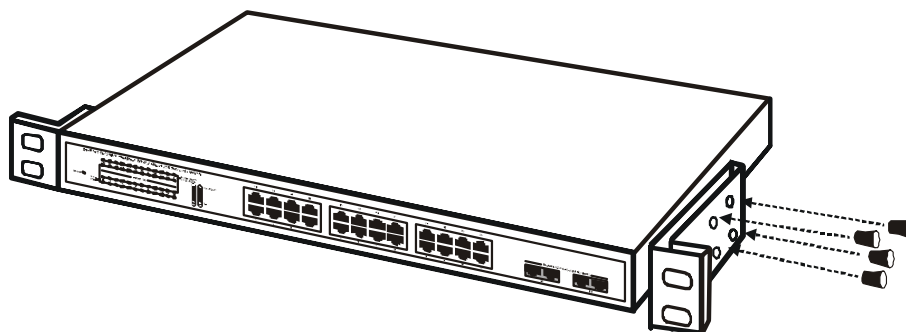

Then, use screws provided with the equipment rack to mount the Switch in the rack.

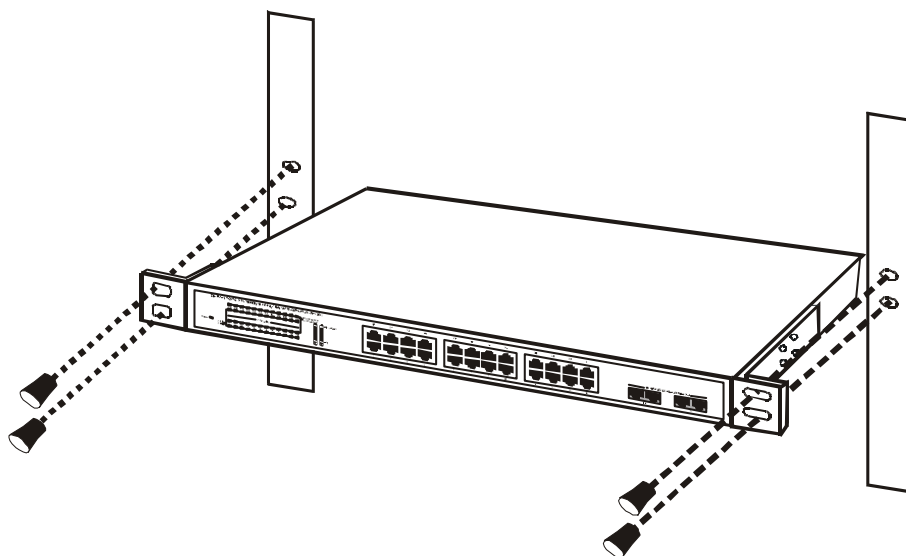

IDENTIFYING EXTERNAL COMPONENTS

This chapter identifies all the major external components of the Switch. Both the front and rear panels are shown below, with a description of each panel features.

Front Panel

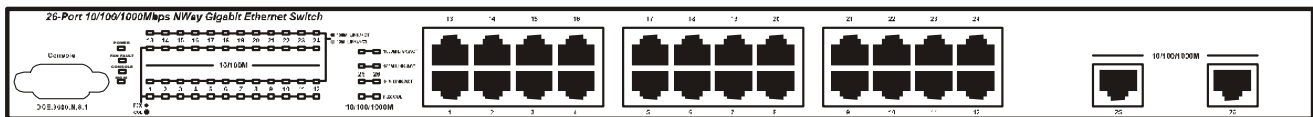

2 × 1000BASE-T plus 24 × 10/100BASE-TX Gigabit Switch

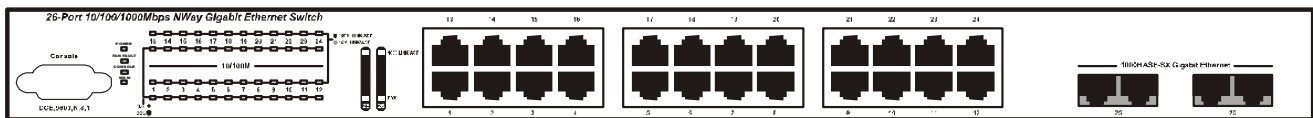

2 × 1000BASE-SX plus 24 × 10/100BASE-TX Gigabit Switch

➤ LED Indicators

Refer to the next chapter *Understanding LED Indicators* for detailed information on the meaning of each LED indicator.

PORT 1 TO PORT 24

➤ 10/100BASE-TX Twisted-Pair Ports (RJ-45)

Use any of these RJ-45 ports to connect workstations or hubs or switches to the Switch. These ports are auto MDI-X ports.

PORT 25 & PORT 26

- **1000BASE-T Twisted Pair Ports (RJ-45) or**
- **1000BASE-SX Fiber-Optic Ports (SC)**
- These two RJ-45 ports are auto MDI-X ports: The Switch is equipped with two Gigabit twisted pair ports, the ports will auto negotiate 10/100/1000Mbps.
- The Switch is equipped with two Gigabit fiber-optic ports, the SC ports can connect to fiber networks on the other end with the same connector.

CONSOLE PORT

Attach a *console cable* to this console port at the left side of the front panel, and connect it to a workstation's RS232. This will enable a console configuration from a remote terminal.

Rear Panel

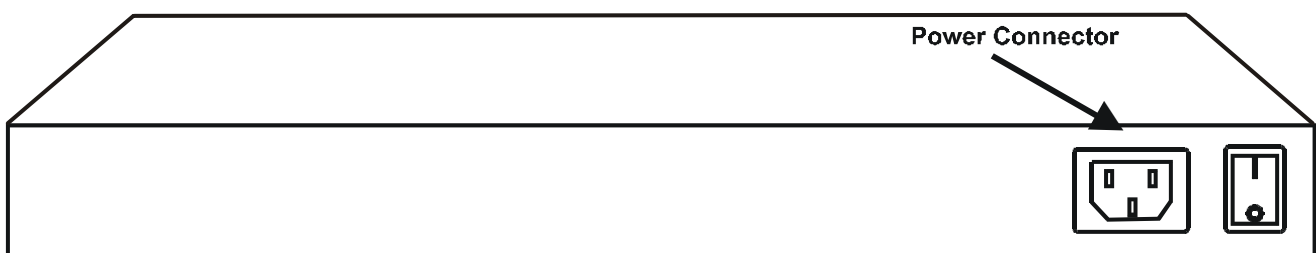

➤ **AC Power Connector:**

Attach the supplied power cord to this power connector and connect it to the power outlet.

Use the switch beside this power connector to turn on or turn off the power.

UNDERSTANDING LED INDICATORS

The front panel LEDs provide instant status feedback, and, helps monitor and troubleshoot when needed.

- **PWR** **Power Indicator (green)**
On : When the green light is on, the Switch is receiving power.
Off : Power cut off or improper connection.
- **FAN FAULT** **Fan Indicator (Amber)**
On : Lights amber when the fan fails to work.
Off : The fan is running normally.
- **CONSOLE** **Console Indicator (green)**
On : Lights green when the console is logged in.
Blinking : Blink green when the console is transmitting data.
Off : The console is not logged in.
- **MGM (Optional)** **Management Indicator (green)**
On : Lights green when the CPU is working.
Off : The CPU is not working.

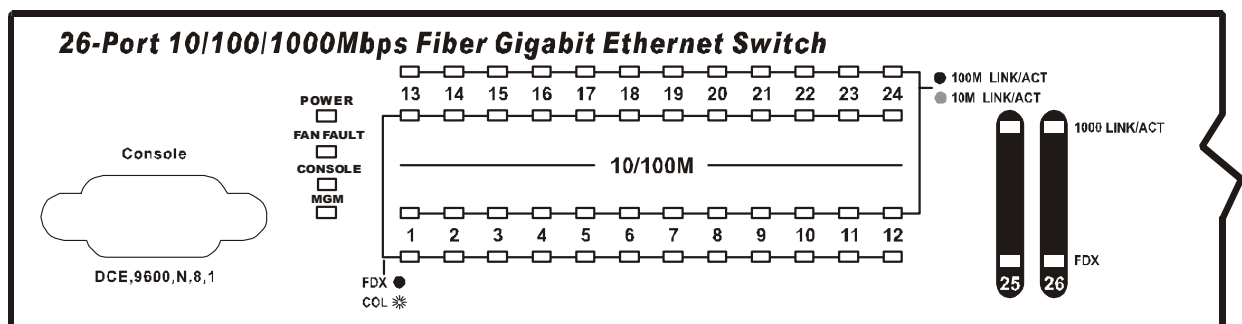

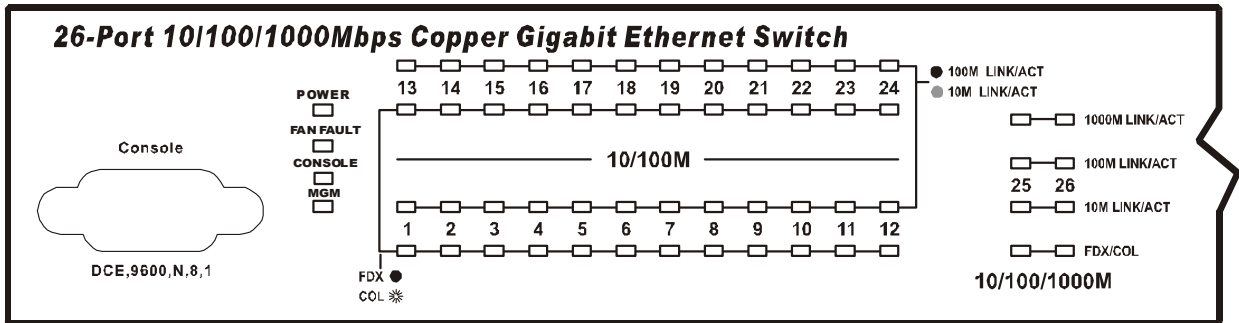

Ports 1~24 Status LEDs

➤ LINK/ACT Link/Activity (green; amber)

On (Green)	: When the green light is on, the respective port is connected to a 100Mbps Fast Ethernet network.
Blinking (Green)	: When the green light is blinking, the port is transmitting or receiving data on the 100Mbps network.
On (Amber)	: When the amber light is on, the respective port is connected to a 10Mbps Ethernet network.
Blinking (Amber)	: When the amber light is blinking, the port is transmitting or receiving data on the 10Mbps network.
Off	: No link activity.

➤

➤ FDX/COL Full Duplex/Collision (green)

On	: When the green light is on, the respective port is in full duplex (FDX) mode.
Blinking	: Collision occurs.
Off	: When the green light is off, the respective port is in half duplex mode.

Port 25 & Port 26 Status LEDs

1000BASE-T

➤ **1000M LINK/ACT** **Link/Activity (green)**

On	:	When the green light is on, the respective port is connected to a Gigabit Ethernet network.
Blinking	:	When the green light is blinking, the port is transmitting or receiving data on the 1000Mbps network.
Off	:	No link activity.



➤ **100M LINK/ACT** **Link/Activity (green)**

On	:	When the green light is on, the respective port is connected to a Fast Ethernet network.
Blinking	:	When the green light is blinking, the port is transmitting or receiving data on the 100Mbps network.
Off	:	No link activity.



➤ **10M LINK/ACT** **Link/Activity (green)**

On	:	When the green light is on, the respective port is connected to a Ethernet network.
Blinking	:	When the green light is blinking, the port is transmitting or receiving data on the 10Mbps network.
Off	:	No link activity.

➤ **FDX/COL Collision/Full Duplex (green)**

On	:	When the green light is on, the respective port is in full duplex (FDX) mode.
Blinking	:	Collision occurs.
Off	:	When the green light is off, the respective port is in half duplex mode.

1000BASE-SX

➤ **LINK/ACT Link/Activity (green)**

On	:	When the green light is on, the respective port is connected to a Gigabit Ethernet network.
Blinking	:	When the green light is blinking, the port is transmitting or receiving data on the 1000Mbps network.
Off	:	No link activity.

➤

➤ **FDX/COL Collision/Full Duplex (green)**

On	:	When the green light is on, the respective port is in full duplex (FDX) mode.
Blinking	:	Collision occurs.
Off	:	When the green light is off, the respective port is in half duplex mode.

CONNECTING THE SWITCH

Referring to the cable specification below, use appropriate cables that meet your speed and cabling requirements when connecting the Switch to your network.

The LAN card capabilities play an important role. If any status LED indicator is not shining after making a proper connection, check the PC LAN card, the cable, the Switch conditions and connections.

Connecting Step-by-Step

- Step 1:** First, ensure the power of the switch and end devices is turned off.
- Step 2:** Consult Cable Specifications Table on next page for cabling requirements based on connectors and speed.
- Step 3:** Connect one end of the cable to the switch and the other end to a desired device.
- Step 4:** When the connections between two end devices are made successfully, turn on the power and the switch is operational.

Cable Specification

Speed	Connector	Port Speed Half/Full Duplex	Cable	Max. Distance
10BASE-T	RJ-45	10/20 Mbps	2-pair UTP/STP Cat. 3, 4, 5	100 m
100BASE-TX	RJ-45	100/200 Mbps	2-pair UTP/STP Cat. 5	100 m
1000BASE-T	RJ-45	1000/2000 Mbps	4-pair UTP/STP Cat. 5 (Cat. 5E is recommended)	100 m
1000BASE-SX (*Wavelength of 850nm)	SC	1000/2000 Mbps	62.5/125 μ m multi-mode fiber	220 m
	SC	1000/2000 Mbps	50/125 μ m multi- mode fiber	550 m

CONFIGURING THE SWITCH

This chapter explains how to configure the Switch to enable its smart functions.

Port Speed & Duplex Mode

By default, the Switch determines the transmission mode by auto-negotiation for any new twisted-pair or fiber connection after attaching the proper cable to a specific port.

For 10/100/1000Mbps RJ-45 ports, if the attached device does not support auto-negotiation or has auto-negotiation disabled, an auto-sensing process is initiated to select speed (10Mbps or 100Mbps or 1000Mbps) and duplex mode (half or full duplex).

For 1000Mbps SC ports, if the attached device does not support auto-negotiation or has auto-negotiation disabled, an auto-sensing process is initiated to select duplex mode (half or full duplex).

Configuration via Console Port

Attach one end of a serial cable to the console port on the Switch, and the other end to a RS232 port on a remote workstation.

The configuration of the Switch is enabled through the console port. However, it is necessary to configure a terminal emulation program, i.e. NetTerm, HyperTerminal.

Console port settings	Baud rate of 9600bps
	No parity
	8 data bits
	1 stop bit
	Flow Control: None

The Management/Smart function setting user's guide is in the attached Diskette.

Product Support

If you continue to have problems you should contact the dealer where you bought this product. If you have any other questions you can contact the Atlantis Land company directly at the following address:

AtlantisLand spa
 Via Gandhi 5 Ing2,Scala A
 20017 Mazzo di Rho(MI)

Tel: 02/93906085, 02/93907634(help desk) Fax: 02/93906161

Email: info@atlantisland.it or tecnici@atlantisland.it

WWW: <http://www.atlantisland.it> or www.atlantis-land.com

TECHNICAL SPECIFICATIONS

General	
Standards	IEEE 802.3 10BASE-T Ethernet IEEE 802.3u 100 BASE-TX Fast Ethernet IEEE 802.3ab 1000BASE-T Gigabit Ethernet IEEE 802.3z 1000BASE-SX Gigabit Ethernet
Protocol	CSMA/CD
Data Transfer Rate	Ethernet: 10Mbps (half duplex), 20Mbps (full duplex) Fast Ethernet: 100Mbps (half duplex), 200Mbps (full duplex) Gigabit Ethernet: 1000Mbps (half duplex), 2000Mbps (full duplex)
Topology	Star
Network Cables	10BASE-T: 2-pair UTP/STP Cat. 3,4,5; up to 100m 100BASE-TX: 2-pair UTP/STP Cat. 5; up to 100m 1000BASE-T: 4-pair UTP/STP Cat. 5; up to 100m (Cat. 5E is recommended) 1000BASE-SX: 62.5/125 micron multimode fiber optic, up to 220m 50/125 micron multimode fiber optic, up to 550m
Number of 10/100Mbps Ports	24 × 10/100Mbps twisted pair ports (RJ-45, auto MDI-X)
Number of 1000Mbps Ports	2 × 1000Mbps twisted pair ports (RJ-45, auto MDI-X) OR 2 × 1000Mbps fiber-optic ports (SC)

Physical and Environmental

AC inputs:	100 to 240 VAC, 50 or 60 Hz internal universal power supply
Power Consumption:	25 watts. (max.)
Temperature	Operating: 0° ~ 50° C, Storage: -10° ~ 70° C
Humidity	Operating: 10% ~ 90%, Storage: 5% ~ 90%
Dimensions:	440 x 200 x 44 mm (W x H x D)
Weight:	2.8kg
Emissions:	FCC Class A, CE Mark Class A, VCCI Class A

Performance

Transmits Method:	Store-and-forward
RAM Buffer:	2M Bytes per device
Filtering Address Table:	32K entries per device
Packet Filtering/Forwarding Rate:	10Mbps Ethernet: 14,880/pps 100Mbps Fast Ethernet: 148,800/pps 1000Mbps Gigabit Ethernet: 1488,000/pps
MAC Address Learning:	Automatic update

Free Manuals Download Website

<http://myh66.com>

<http://usermanuals.us>

<http://www.somanuals.com>

<http://www.4manuals.cc>

<http://www.manual-lib.com>

<http://www.404manual.com>

<http://www.luxmanual.com>

<http://aubethermostatmanual.com>

Golf course search by state

<http://golfingnear.com>

Email search by domain

<http://emailbydomain.com>

Auto manuals search

<http://auto.somanuals.com>

TV manuals search

<http://tv.somanuals.com>