

Thera

Pocket PC with Integrated CDMA 1x Digital Phone

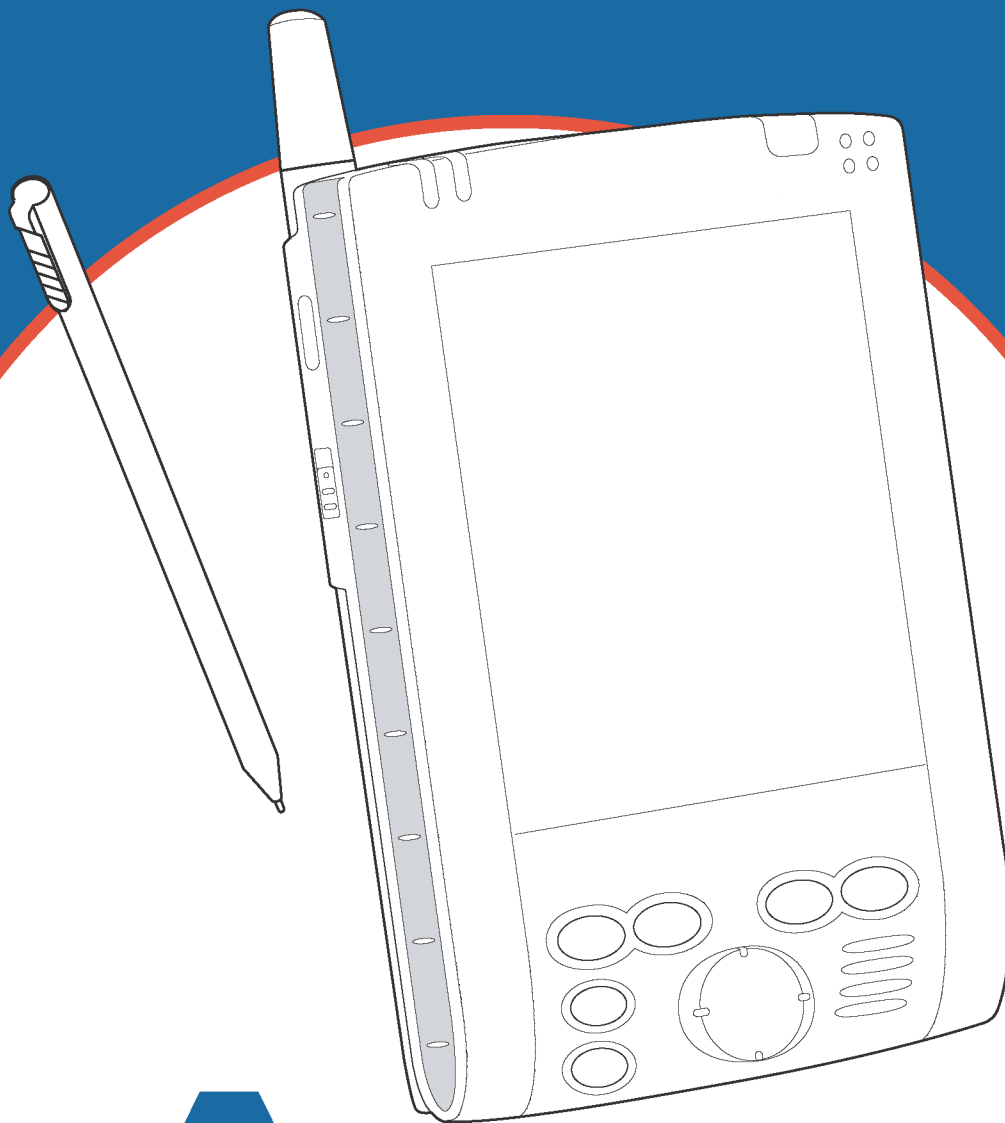

AUDIOVOX
COMMUNICATIONS CORP.



USER'S GUIDE

INTRODUCTION

It is important you read this manual (USER'S GUIDE) before using your device (*Thēra* Pocket PC) to ensure its proper operation.

It is recommended that important data stored in your device should be saved to a memory card (sold separately) or your personal computer (data transfer with ActiveSync®) on a regular basis. Before returning your unit for service, be sure to back up your data and remove any confidential, proprietary or personal information. Audiovox Communications Corp. is not responsible for damage to or loss of any programs, data or removable storage media.

The purpose of the Safety Instructions in this manual is to provide you with warnings and safety instructions that will assist in preventing the misuse of your device.

- * All of the Safety Instructions that are contained in this manual must be read carefully and must be fully understood before you attempt to use your device in order to avoid potential hazards that could cause bodily injury or property damage, or could result in damage to your device or loss of data.
- * Always keep this manual in a convenient place for future reference.

Trademark Information

- Microsoft, ActiveSync, Outlook, Pocket Outlook, Windows, Windows NT, and the Windows logo are either registered trademarks or trademarks of Microsoft Corporation in the United States and/or other countries. Microsoft products are licensed to OEMs by Microsoft Licensing, Inc., a wholly owned subsidiary of Microsoft Corporation.
- Sierra Wireless, the Sierra Wireless logo, red wave design and, Watcher are trademarks of Sierra Wireless, Inc. Heart of the Wireless Machine is a registered trademark of Sierra Wireless, Inc. © 2001 Sierra Wireless, inc.
- Other product names mentioned in this manual are trademarks or registered trademarks of the respective companies.

Please note that copying and modifying, changing or editing any material on the Internet, except using it privately for non-commercial purpose, may infringe the author's copyright protected by the Copyright Act.

Product Name: *Thera*

Model Number(s): CET0200A (PDA2032)

FCC Notice "Declaration of Conformity Information"

This equipment has been tested and found to comply with the limits for a Class B digital device, pursuant to part 15 of the FCC Rules. These limits are designed to provide reasonable protection against harmful interference in a residential installation. This equipment generates, uses and can radiate radio frequency energy and, if not installed and used in accordance with the instructions, may cause harmful interference to radio communications.

However, there is no guarantee that interference will not occur in a particular installation. If this equipment does cause harmful interference to radio or television reception, which can be determined by turning the equipment off and on, the user is encouraged to try to correct the interference by one or more of the following measures:

- Reorient or relocate the receiving antenna.
- Increase the separation between the equipment and receiver.
- Connect the equipment into an outlet on a circuit different from that to which the receiver is connected.
- Consult the dealer or an experienced radio/TV technician for help.

Warning: Only peripherals complying with the FCC class B limits may be attached to this equipment.

Operation with non-compliant peripherals or peripherals not recommended by us is likely to result in interference to radio and TV reception. Shielded cables must be used between the external devices and the cradle connecting port.

Changes or modifications made to this equipment, not expressly approved by us or parties authorized by us could void the user's authority to operate the equipment.

This device complies with part 15 of the FCC Rules. Operation is subject to the following two conditions:

- (1) This device may not cause harmful interference, and
- (2) this device must accept any interference received, including interference that may cause undesired operation.

Product Name: USB Cradle

Model Number(s): CEX0208B (CRU2032B)

FCC Notice "Declaration of Conformity Information"

This equipment has been tested and found to comply with the limits for a Class B digital device, pursuant to part 15 of the FCC Rules. These limits are designed to provide reasonable protection against harmful interference in a residential installation. This equipment generates, uses and can radiate radio frequency energy and, if not installed and used in accordance with the instructions, may cause harmful interference to radio communications.

However, there is no guarantee that interference will not occur in a particular installation. If this equipment does cause harmful interference to radio or television reception, which can be determined by turning the equipment off and on, the user is encouraged to try to correct the interference by one or more of the following measures:

- Reorient or relocate the receiving antenna.
- Increase the separation between the equipment and receiver.
- Connect the equipment into an outlet on a circuit different from that to which the receiver is connected.
- Consult the dealer or an experienced radio/TV technician for help.

This device complies with part 15 of the FCC Rules. Operation is subject to the following two conditions:

- (1) This device may not cause harmful interference, and
- (2) this device must accept any interference received, including interference that may cause undesired operation.

SAFETY INSTRUCTIONS

- **There are two categories of Safety Instructions included in this manual:**
 - ✓ Product Warnings, (i.e., what must never be done to assure avoiding those hazards that could cause bodily injury or property damage); and
 - ✓ User Directions (i.e., what must always be done to assure the safe use of your device).
- **The Safety Instructions contained in this manual have been categorized in accordance with the seriousness of the potential hazards through the use of Signal Words.**

Those Signal Words, and their intended meanings, are as follows:

DANGER: Indicates that a failure to observe the Safety Instructions could result in death or catastrophic bodily injury.

WARNING: Indicates that a failure to observe the Safety Instructions could result in serious bodily injury.

CAUTION: Indicates that a failure to observe the Safety Instructions could result in minor bodily injury or property damage.

NOTE: Designates important information that relates to activities and/or conditions that might result in loss of data and/or damage to your device.

Safe Use And Operation of Your Device

All portable computers produce low levels of RF energy due to the generation of digital timing pulses by its clock oscillator circuits. Your device has been equipped with internal shielding to minimize stray emissions of RF energy. Airlines may nevertheless prohibit the on-board use of portable PCs (and all other portable electronic devices that could potentially emit stray RF energy), particularly during take-offs and landings, to prevent any possible interference with the reception of signals by airborne electronic navigational devices. Other locations, such as hospitals, may also restrict the use of Pocket PC's and other devices that emit low-level RF energy.

WARNING

- Always request and obtain prior consent and approval of an authorized airline representative before using your device aboard an aircraft.
- Always follow the instructions of the airline representative whenever using your device aboard an aircraft, to prevent any possible interference with airborne electronic equipment.

WARNING

- Always comply with posted prohibitions of the use of RF-emitting devices, such as in hospitals. Failure to follow such directives could result in the interference with medical equipment and/or devices.
- Never come closer than 6 inches to a person with a heart pacemaker implant when using this device. Failure to do so could result in interference with the function of the pacemaker.

WARNING

- Never use your device while driving an automobile or any other moving vehicle. Always pull out of traffic and come to a stop in a legally permissible and safe location before using your device. Failure to do so could result in serious bodily injury in a traffic accident.
- Never use your device while walking. Usage while walking could result in bodily injury caused by inattention to automobile traffic or other pedestrian hazards.

WARNING

- Never allow metallic objects, such as staples and paper clips, to enter inside your device. Metallic objects, such as staples and paper clips, if allowed to enter your device, could cause the generation of excess heat or fire.
- Never connect terminals (metal parts) to metallic objects (such as wires). Connecting terminals to metal objects could cause excessive heat or fire.
- Always immediately disconnect the AC Adapter from the power outlet and turn the battery switch to the "Stop" position in the event the device emits an unusual odor or sound or generates smoke.

WARNING

- Never use or store your device in the following locations:
 - Anywhere it may be exposed to water, such as a bathroom or sauna;
 - In conditions of high humidity, such as in the rain or fog;
 - Where your device will be exposed to high temperatures, such as near a fire or equipment that emits high temperatures;
 - In direct sunlight; or
 - In a sealed automobile left in the sun and subject to high temperatures.
 - Never store or transport flammable liquids, gases or explosive materials in the same compartment of your automobile as the device or any of its accessories, as possible sparking in the PC could cause ignition or explosion.
 - When driving, always secure your device in its softcase, when it is not in use. Never place your device on the passenger seat or any place else in the car where it can become a projectile during a collision or stop.
- Never drop your device or subject it to severe shock. Dropping your device or subjecting it to severe shock could cause the built-in battery to leak, ignite and/or rupture.
- Always immediately remove your device and its battery from the vicinity of any source of heat, such as an open flame, in the event the built-in battery leaks liquid or emits an unusual odor. Continued use of your device under either of these conditions could cause ignition (i.e., fire) of the leaked battery liquid, or rupture.
- Never touch any fluid that might leak from the built-in battery. Such liquid when in contact with

the eyes or skin, could cause injury to the skin or eyes. ***Should the liquid come into contact with the eyes, irrigate the eyes thoroughly with clean water and immediately seek medical attention.*** In the event the liquid comes into contact with the skin or clothing, wash it away immediately with clean water.

Failure to follow the above directions concerning use and storage could result in bodily injury and/or property damage due to battery liquid leakage, fire or rupture. Failure to follow the above directions concerning use and storage could also result in damage to your device.

WARNING

- Always use authorized Audiovox accessories and optional devices when operating this device, as the use of incompatible auxiliary equipment could result in fire, electric shock or other bodily injury. The use of unauthorized accessories will also void your Warranty.

WARNING

- Never attempt to disassemble, repair or make any modification to your device. Disassembly, modification or any attempt at repair could cause bodily injury or property damage, as well as damage to the device itself.

WARNING

- Your device is not a toy. Never allow children to play with your device. Misuse, rough or improper handling of your device by children could result in serious bodily injury for any of the enumerated safety warnings in this manual. In addition, always keep all accessories and components out of the reach of small children as small parts might present a choking hazard.

Seek immediate medical attention if choking occurs or if any small part has been swallowed.

CAUTION

- Never raise the sound volume level too high when using your device with earphones. An excessive sound volume level could cause damage to your hearing.
- Never touch the liquid that might leak from a broken liquid crystal display. Contact with this liquid could cause a skin rash. If the crystal display liquid should come into contact with the skin or clothing, wash it immediately with clean water.

NOTE

- Under certain conditions, data may be lost, including:
 - ✓ Failure to follow all instructions for use and warnings in this manual.
 - ✓ Misuse of your device;
 - ✓ Subjecting the main unit of your device to static electricity and/or noise;
 - ✓ Total loss of electric charge in the built-in battery; and
 - ✓ Servicing of your device.

SAFETY INSTRUCTIONS

- Use of your device in locations where the following ambient environmental conditions are exceeded:
 - ✓ Under normal operational use ambient temperatures not less than 32°F and not in excess of 104°F (0°C and 40°C);
 - ✓ With humidity of not less than 30% or in excess of 80%; and
 - ✓ When charging the battery ambient temperatures not less than 41°F and not to exceed 95°F (5°C and 35°C).
- Do not store or use your device in the following locations:
 - ✓ Those subject to extremely high or low temperatures;
 - ✓ Dusty locations; and
 - ✓ Locations or sites subject to strong vibration.

Use or storage in these location, sites or areas can result in product failure, malfunction or loss of data.
- Avoid connecting your device to an external device such as a computer in an environment likely to be affected by static electricity. For example, during low-humidity weather, shuffling your shoes upon a rug can produce static electricity. Before you handle your computer, you should touch a grounded object to discharge any static electricity from your body.
- Do not subject your device to sudden and severe temperature changes. This could result in moisture condensation in the device that could cause damage to your device, computer function loss, and/or the loss of data. In the event of moisture condensation, allow your device to dry out completely.
- It is normal for the AC Adapter to become warm when charging.
- Disconnect the power plug from the outlet when not in use.
- Take care not to sit on device when it is located in the back pocket of trousers, etc. This could cause damage to your device or malfunction of the device functions.
- Do not place objects on top of your device or drop them on top of your device. This could cause damage to your device and/or malfunction.
- Never paint or apply any foreign substance to this device as this can clog and damage moving parts.
- Clean terminals (metallic parts) on a regular basis with a dry cotton swab. Dirty terminals could affect battery charging.
- Never use organic solvents such as benzene or paint thinner to clean your device. Use of these solvents can cause deformation or discoloration. Wipe dirty parts with a soft dry cloth.
- Do not wipe the display with a damp or wet cloth or touch the display with damp or wet hands. Wiping or touching the display under this condition can cause product failure or malfunction. Always use a soft dry cloth to wipe the display.
- When using the optional “SD memory card”, be sure to read the relevant instruction manual and ensure that you know the proper procedures for their use and compatibility with your device.
 - ✓ Never subject the card to any severe shock while connected to your device. Such a shock can cause damage to the card and a malfunction.
 - ✓ Do not carry your device with the card connected to it. This can result in the damage or loss of the card.

- When the device is operating, do not insert or remove the “SD memory card” into or out of the SD card slot or connect or disconnect the device from the cradle as this may cause loss of stored data, or product failure/malfunction.
- Never connect cradle terminals with metallic objects, such as wires. Connecting these terminals with metallic objects may cause the production of excess heat, burns and damage to the charger and/or your device.
- To avoid eye strain, take frequent visual breaks, focusing on objects located at a distance greater than 15 feet.

CAUTION

- A lithium ion battery is used in this device. When a replacement is needed, please request the dealer from whom your device was purchased to assist you.
- Lithium ion batteries are recyclable. When you replace your built-in battery, please request the repair center to recycle the battery in accordance with RBRC standards. When disposing of the battery by yourself, please call RBRC at (800) 822-8837 for tips on the proper disposal of the lithium ion battery. Never dispose of the battery with ordinary waste.



Safe Use of AC Adapter

DANGER

- Never attempt to disassemble or repair an AC Adapter, and never alter the power cords or plugs as exposure to electric shock hazards may result.
Always contact an authorized Audiovox service center, if repair or replacement is required.
- If the plug will not fit into the available outlet, have a proper outlet installed by a qualified electrician. Improper connection can result in the risk of electric shock. Never attempt to modify or alter the AC cord or plug of the AC Adapter.

WARNING

- Never allow the AC Adapter to come into contact with water or any other liquid. Water or any other liquid in contact with the AC Adapter can create a risk of fire or electric shock.
- Always use the authorized Audiovox AC Adapter to avoid any risk of fire or damage to your device or battery. Bodily injury or property damage may occur as a result of the use of an unauthorized and incompatible AC Adapter.
- Never use an AC Adapter if it has a damaged or worn power cord or plug. The use of damaged or worn power cords or plugs could result in electric shock, burns or fire. Contact an authorized Audiovox service center immediately to obtain a suitable replacement.
- Never connect or disconnect the AC Adapter with wet hands. Connecting or disconnecting the AC Adapter to a power source with wet hands could cause electric shock.
- Never attempt to connect or disconnect the power plug with damp or wet hands. Connecting or disconnecting the power plug with damp or wet hands could result in an electric shock.
- Always unplug the AC Adapter from the power source before attempting any cleaning in order to avoid the risk of electric shock. Always use a soft dry cloth to clean the equipment, after it has been unplugged.
- Never attempt to use an unauthorized AC Adapter with your device in order to avoid any risk of bodily injury or property damage. Since unauthorized accessories have different specifications, they may be incompatible with your device.

CAUTION

- Never place an AC Adapter on a wooden surface (or any other surface that could be marred by exposure to heat) while it is in use. Since its surface temperature of the AC adapter increases during normal use, always rest it on a suitable heat-insulating material.
- Never cover the AC Adapter with any object while it is in use, and never place it adjacent to a heat source. An excessive temperature increase could detrimentally affect its performance.
- Never place a Power Supply Cable near a heat source, as damage to the cord or to its insulation could result.
- Always use a surge protector when utilizing the AC Adapter during an electrical storm. Otherwise, a power surge could result in the loss of stored data.
- Always use a surge protector when utilizing the AC Adapter near an electrical noise source such as high voltage line or power source. Otherwise, a power surge could result in loss of stored data.
- In order to avoid any possibility of a fire, always insert the power plug into household electric outlet supplying 120V AC.
- When traveling abroad, never plug the AC Adapter into a power source that does not correspond to both the voltage and the frequency specified on the rating plate of the AC Adapter, as equipment damage and fire will result. When you connect to a power supply of more than 125V AC, change the Power Supply Cable with one that corresponds to the power supply specification. Failure to do so could cause a fire.

CAUTION

- Never drop the AC adapter or subject it to severe shock. This may cause ignition or electric shock, as well as damage to the adapter.
- Always locate an accessory Power Supply Cable so that it will not be stepped on, tripped over, or otherwise subjected to damage or stress.
- Never place heavy objects on a Power Supply Cable, as this could result in damage to the cord.
- Never bend or twist a Power Supply Cable, and never pull on a Power Supply Cable in an attempt to remove an AC Adapter or accessory plug from a socket. Always grasp the AC Adapter or the accessory plug directly when unplugging the Power Supply Cable in order to avoid damaging the cable.
- Always ensure the power plug pins are clean and free of dust or other foreign material by wiping the pins with a clean dry cloth. Dust or other foreign material accumulation on the power plug pins could cause fire.
- Be certain to insert the power plug deeply into a socket. Failure to do so could cause a fire and an electric shock.
- Always disconnect the AC Adapter from the power source when it is not in use.

SAFE USE AND OPERATION OF DEVICE (WIRELESS HANDHELD PHONE)

Read this information before using your device.

Your device is a low power radio transmitter and receiver. When it is ON, it receives and also sends out radiofrequency (RF) signals.

FCC RF EXPOSURE INFORMATION

In August 1996, the Federal Communications Commission (FCC) of the United States, with its action in Report and Order FCC 96-326, adopted an updated safety standard for human exposure to radiofrequency (RF) electromagnetic energy emitted by FCC regulated transmitters. Those guidelines are consistent with the safety standard previously set by both U.S. and international standards bodies. The design of this device complies with the FCC guidelines and these international standards.

Use only the supplied or an approved antenna. Unauthorized antennas, damaged antennas, modifications, or attachments could impair call quality, damage the phone, or result in violation of FCC regulations. Please contact your local dealer for replacement antenna.

Body-worn Operation

This device was tested with the BC-2032 belt clip and LB-2032 softcase, offered by Audiovox, as an accessory to this device and was found to comply with the FCC exposure requirements. Other third-party belt clip and softcase or holsters have not been tested with this device and therefore their compliance with the FCC RF exposure limits cannot be confirmed.

When operating this device, a minimum separation distance of 1 inch (2.5 cm) must be maintained between the user's body and the device, including its antenna, to comply with the FCC exposure limits.

This particular device has not been designed for held-to-ear use and should never be used against the ear. It is designed to be used in a belt clip with an earphone microphone or as a speakerphone.

For more information about RF exposure, please visit the FCC website at www.fcc.gov.

PHONE OPERATION

When speaking into the Microphone or the Earphone Microphone, a minimum separation distance of 1 inch (2.5 cm) must be maintained between the user's face and the device, including its antenna, to comply with the FCC exposure limits.

This particular device has not been designed for held-to-ear use and should never be used against the ear.

In front of your face, hold the device keeping distance from your body. or, In front of your face, hold the device wearing the earpiece keeping distance from your body.

Tips on Efficient Operation:

For your phone to operate most efficiently:

- Do not touch the antenna unnecessarily and keep the antenna from metal when the phone is in use. Contact with the antenna affects call quality and may cause the phone to operate at a higher power level than otherwise needed.

WARNING

DRIVING

Never use a device and/or cell phone while driving an automobile or any other moving vehicle. Always pull out of traffic and come to a stop in a legally permissible and safe location before using your device. Failure to do so could result in serious bodily injury in a traffic accident.

WARNING

ELECTRONIC DEVICES

Most modern electronic equipment is shielded from RF signals. However, certain electronic equipment may not be shielded against the RF signals from your device.

Pacemakers

The Health Industry Manufacturers Association recommends that a minimum separation of six (6") inches must be maintained between your device and a pacemaker to avoid potential interference with the pacemaker. These recommendations are consistent with the independent research and recommendations of Wireless Technology Research.

Persons with pacemakers:

- Should ALWAYS keep the device more than six (6") inches from their pacemaker when the device is turned ON.
- Should not carry the device in a breast pocket.
- If you have any reason to suspect that interference is taking place, turn your device OFF immediately.

WARNING

Vehicles

RF signals may affect improperly installed or inadequately shielded electronic systems in motor vehicles. Check with the manufacturer or its representative regarding your vehicle. You should also consult the manufacturer of any equipment that has been added to your vehicle.

Posted Facilities

Turn your device OFF in any facility where posted notices require so.

AIRCRAFT

FCC regulations prohibit using your device while in the air. Turn your device OFF before boarding an aircraft.

BLASTING AREAS

To avoid interfering with blasting operations, turn your device OFF when in a “Blasting area” or in areas posted “Turn off two-way radio”. Obey all signs and instructions.

POTENTIALLY EXPLOSIVE ATMOSPHERES

Turn your device OFF when in any area with a potentially explosive atmosphere and obey all signs and instructions. Sparks in such areas could cause an explosion or fire resulting in bodily injury or even death. Areas with a potentially explosive atmosphere are often, but not always marked clearly. Potential areas may include: fueling areas (such as gasoline stations); below deck on boats; fuel or chemical transfer or storage facilities; vehicles using liquefied petroleum gas (such as propane or butane); areas where the air contains chemicals or particles (such as grain, dust, or metal powders); and any other area where you would normally be advised to turn off your vehicle engine.

For Vehicles Equipped with an Air Bag

An air bag inflates with great force. DO NOT place objects, including either installed or portable wireless equipment, in the area over the air bag or in the air bag deployment area. If in-vehicle wireless equipment is improperly installed and the air bag inflates, serious injury could result.

CAUTION

Hearing Aids

Some digital wireless phones may interfere with some hearing aids. In the event of such interference, you may want to consult your service provider [or call the customer service line to discuss alternatives].

Other Medical Devices

If you use any other personal medical device, consult the manufacturer of your device to determine if they are adequately shielded from external RF energy. Your physician may be able to assist you in obtaining this information.

Turn your device OFF in health care facilities when any regulations posted in these areas instruct you to do so. Hospitals or health care facilities may be using equipment that could be sensitive to external RF energy.

“device OFF” means to turn the Radio Standby Switch “OFF”, then turn the power off using the Power button.

SAR Information

Specific Absorption Rate

THIS MODEL PHONE MEETS THE GOVERNMENT'S REQUIREMENTS FOR EXPOSURE TO RADIO WAVES.

Your wireless phone is a radio transmitter and receiver. It is designed and manufactured not to exceed the emission limits for exposure to radiofrequency (RF) energy set by the Federal Communications Commission of the U.S. Government. These limits are part of comprehensive guidelines and establish permitted levels of RF energy for the general population. The guidelines are based on standards that were developed by independent scientific organizations through periodic and thorough evaluation of scientific studies. The standards include a substantial safety margin designed to assure the safety of all persons, regardless of age and health.

The exposure standard for wireless mobile phones employs a unit of measurement known as the Specific Absorption Rate, or SAR. The SAR limit set by the FCC is 1.6 W/kg.* Tests for SAR are conducted with the phone transmitting at its highest certified power level in all tested frequency bands. Although the SAR is determined at the highest certified power level, the actual SAR level of the phone while operating can be well below the maximum value. This is because the phone is designed to operate at multiple power levels so as to use only the power required to reach the network. In general, the closer you are to a wireless base station antenna, the lower the power output.

Before a phone model is available for sale to the public, it must be tested and certified to the FCC that it does not exceed the limit established by the government-adopted requirement for safe exposure. The tests are performed in positions and locations (e.g., worn on the body) as required by the FCC for each model. The highest SAR value for this model phone tested when being worn on the body, as described in this user guide, is 0.56W/kg. (Body-worn measurements differ among phone models, depending upon available accessories and FCC requirements). While there may be differences between the SAR levels of various phones and at various positions, they all meet the government requirement for safe exposure.

The FCC has granted an Equipment Authorization for this model phone with all reported SAR levels evaluated as in compliance with the FCC RF exposure guidelines. SAR information on this model phone is on file with the FCC and can be found under the Display Grant section of <http://www.fcc.gov/oet/fccid> after searching on FCC ID CJ6CET0200MT.

Additional information on Specific Absorption Rates (SAR) can be found on the Cellular Telecommunications & Internet Association (CTIA) web-site at <http://www.phonefacts.net>.

* In the United States and Canada, the SAR limit for mobile phones used by the public is 1.6 watts/kg (W/kg) averaged over one gram of tissue. The standard incorporates a substantial margin of safety to give additional protection for the public and to account for any variations in measurements.

Table of Contents

SAFETY INSTRUCTIONS	5
SAFE USE AND OPERATION OF DEVICE (WIRELESS HANDHELD PHONE)	12
SAR Information	15
Chapter 1: Getting Started	18
Welcome	19
Where to Find Information	19
Chapter 2: Basic Skills	20
Parts Names and Function	21
Battery Charging	27
Initial Setup	29
Setup Options	30
Connecting to a Computer	31
Today Screen	32
Programs	34
Navigation Bar and Command Bar	35
Pop-up Menus	36
Notifications	36
Entering Information	37
Entering Text Using the Input Panel	37
Finding and Organizing Information	46
Customizing Your Device	47
Chapter 3: Phone Functions	55
Using Phone Function	56
Placing Calls	62
Receiving a Call	64
Call Waiting	66
Call Forwarding	66
Three-Way Calling	66
Voice Mail	66
Digital Numeric Page	66
Missed Call	67
Link Dialing	67
Emergency Dialing	68
Phone Book	68
KeyGuard Lock	69
Scratch Pad	69

	Speed Dial	70
	Call Log	71
	Options (Preferences)	72
	SMS (Messaging)	78
	Accessing the Internet	83
Chapter 4:	Microsoft® ActiveSync®	86
Chapter 5:	Microsoft® Pocket Outlook®	89
	Calendar: Scheduling Appointments and Meetings	90
	Contacts: Tracking Friends and Colleagues	93
	Tasks: Keeping a To Do List	96
	Notes: Capturing Thoughts and Ideas	99
	Inbox: Sending and Receiving E-mail Messages	101
Chapter 6:	Companion Programs	106
	Pocket Word	107
	Pocket Excel	111
	MSN® Messenger	113
	Windows Media™ Player for Pocket PC	117
	Microsoft® Reader	118
Chapter 7:	Pocket Internet Explorer	122
	The Mobile Favorites Folder	123
	Mobile Favorites	123
	Using AvantGo Channels	125
	Using Pocket Internet Explorer	126
Chapter 8:	Getting Connected	128
	Transferring Items Using Infrared	129
	Connecting to the Internet	130
	Connecting to Work	131
	Ending a Connection	132
	Connecting Directly to an E-mail Server	132
	Get Help on Connecting	132
Chapter 9:	Optional Functions	133
	Home	134
	Backing Up	141
Chapter 10:	Additional Information	145
	Resetting	146
	Clearing Memory (Initialization)	147
	Specifications	148

Chapter 1

Getting Started

Welcome

Congratulations on the purchase of your *Thera* Pocket PC. You can keep your most important business and personal information up to date and close at hand. And with the power of Microsoft® ActiveSync® you can synchronize and download information on your desktop or laptop computer with your handheld device.

With your *Thera* Pocket PC you can:

- Make and receive phone calls.
- Instantly view the day's appointments with the touch of a button.
- Send and receive e-mails.
- Download web pages.
- Make handwritten notes

Where to Find Information

This manual describes your device hardware, an overview of its programs and explains how to connect to a computer, network, or the Internet. See the Quick Start Card for instructions on setting up the device and installing ActiveSync®.

For information on:	See this source:
Programs on your device	This manual and device Help. To view Help, tap  then Help .
Additional programs that can be installed on the device	The Companion CD.
Connecting to and synchronizing with a computer	The Quick Start Card or ActiveSync® Help on your computer. To view Help, click Help then Microsoft ActiveSync Help .
Last-minute updates and detailed technical information	The Read Me files, located in the Microsoft ActiveSync folder on the computer and on the Companion CD.
Up-to-date information on Pocket PC	http://www.microsoft.com/mobile/pocketpc
Product & technical support information about <i>Thera</i> and other Audiovox Pocket PC devices.	http://www.audiovox.com/pda

Chapter 2

Basic Skills

Parts Names and Function

■ Main Unit (front view)

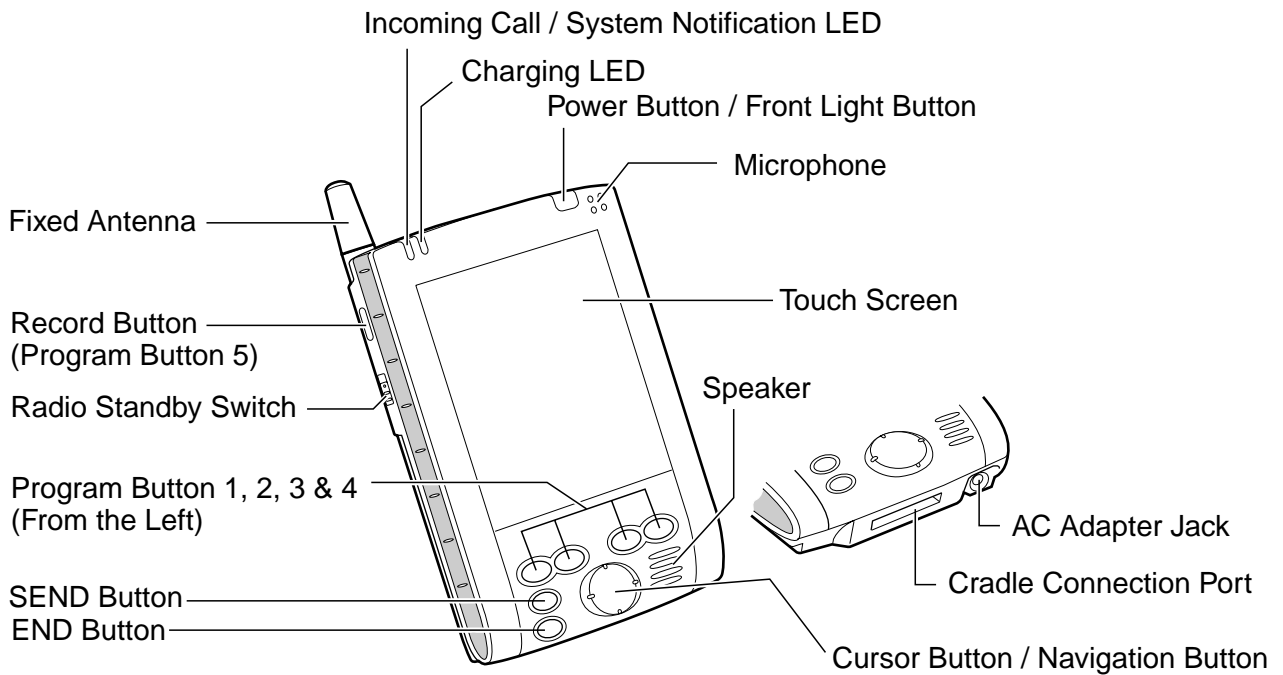

■ The Cradle

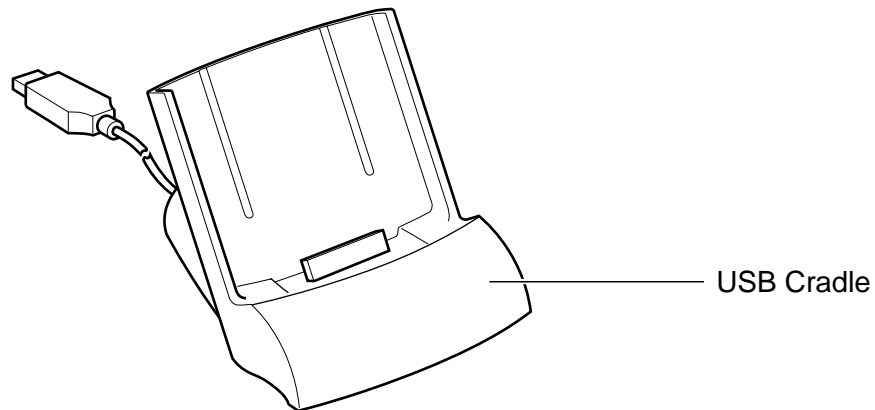

■ Initial Setting of Program Buttons

- Program button 1Calendar
- Program button 2Tasks
- Program button 3Home
- Program button 4Contacts
- Program button 5Voice Recorder

■ Main Unit (back view)

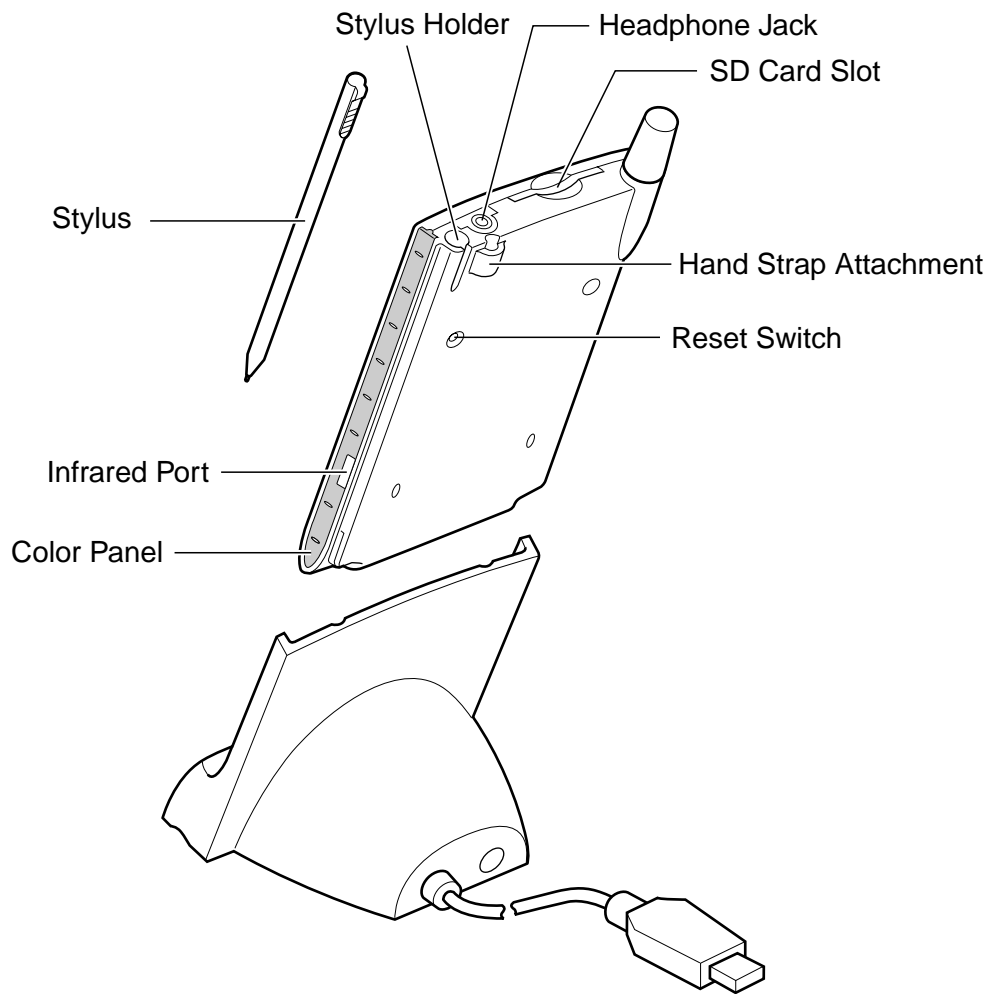

Power Button / Front Light Button

Press this to turn the device and the front light on/off.

Power button	When the power is off	When the power is on
Press and hold.	The power turns on.	The front light alternately turns on/off.
Press it quickly.	The power turns on.	The power turns off.

Even if the power is turned off, pressing the program button turns the power on and the program screen is displayed. (However, you can change the setting. See “Setting Power” in “Customizing Your Device” later in this chapter.)

When using the device under high ambient temperatures and the temperature inside of the device goes up (to about 144°F or more), the power is forcibly turned off. In this case, after the temperature inside of the device cooled down, turn the power on and use the device under appropriate ambient temperatures. (144°F=62°C)

Battery Switch

The Battery Switch supplies/cuts the battery power to the device. When shipped, the setting is “Stop.” Before using your device for the first time:

1. Detach the Color Panel (see illustration) to expose the Battery Switch.

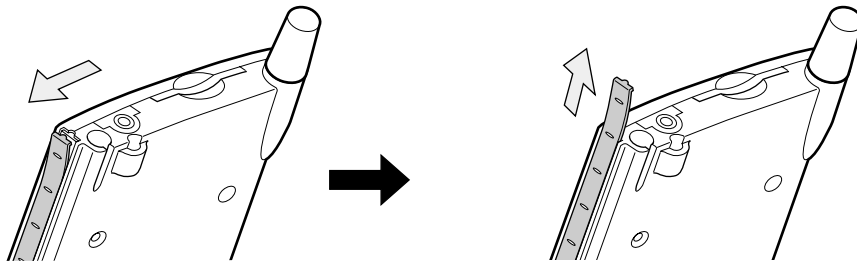

2. Confirm that the Radio Standby Switch is set to “OFF,” then slide the Battery Switch to “Supply” (lower side).

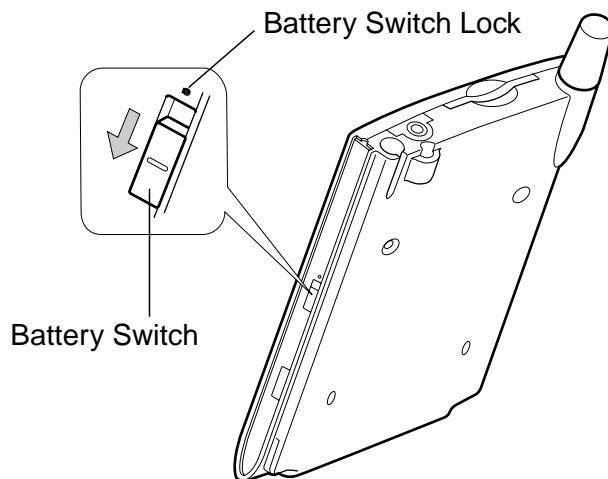

3. Reattach the Color Panel.

...  **Note** Returning the switch to the “Stop” (the upper side) resets the device back to its factory settings - initial setup will need to be repeated. To move to the “Stop” side, slide the switch while inserting the stylus into the Battery Switch Lock.

Charging LED

- Steady orange Built-in battery charging
- Flashing yellow Charging has stopped due to extreme temperatures. Charge at a temperature of approximately 41°F - 95°F (5°C and 35°C).
- Steady green Built-in battery fully charged.
- Steady yellow Built-in battery charging but level is not strong enough to power.

Incoming Call / System Notification LED

- Fast flashing orange Incoming call
(Approx. 2Hz)
- Slow flashing orange Indicates alarm as set through **Calendar** or **Tasks**.
(Approx. 1Hz)

Radio Standby Switch

Determines functionality of device. To turn ON, slide Radio Standby Switch to the upper side.

- ON Can be used as phone to make and receive calls
- OFF Cannot function as a phone

Using the Stylus

Use only on touch-screen for menu selection or data input.

- **Tap:** Touch the screen once with the stylus to open items and select options.
- **Drag:** Hold the stylus on the screen and drag it across to select text and images. Drag in a list to select multiple items.
- **Tap and hold:** Tap and hold the stylus on an item to see a list of actions available for that item. On the pop-up menu that appears, tap the action you want to perform.

...  **Note** Only use the supplied stylus on the touch screen. If the stylus tip becomes damaged, replace with a new one. Using a ballpoint pen or damaged stylus may damage the screen.

About Cursor Button

Navigate the cursor on screen by pressing the upper, lower, right or left part of the cursor button. Press the center of the button to select an option or program.

...  **Note** The cursor movement depends on the screen. When the cursor is at the right or the left side of the screen, it may not move.

Earphone Microphone

The supplied Earphone Microphone can be used to receive phone calls. When the Earphone Microphone is inserted into the device, the microphone and speaker on the main unit will become inactive.

Also, this microphone can be used as a recorder.

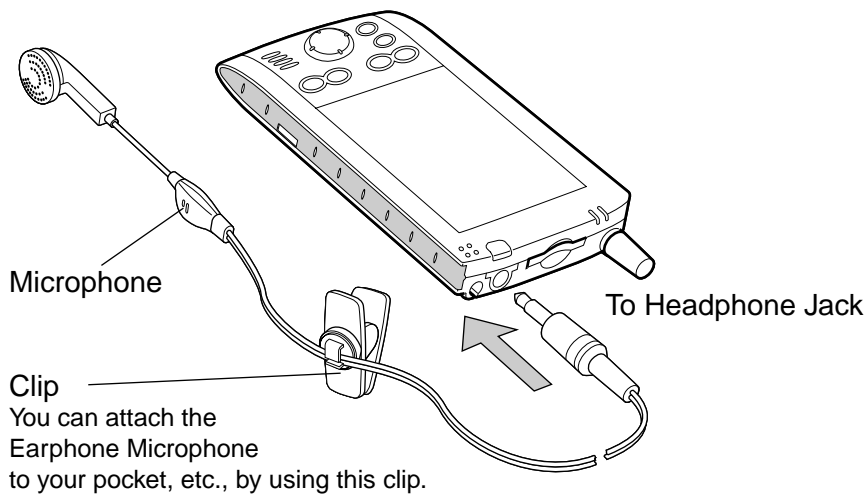

This device's phone component can be used with the Earphone Microphone or as a speakerphone. Unlike conventional cell phones, it is not designed to be held against the head in conversation. Such unauthorized use of the phone, without an Earphone Microphone or other than as a speakerphone, is contrary to the design of this product and is not recommended. For instructions on how to use the phone with Earphone Microphone or as a speakerphone, please refer to page 61 of this manual.

...  **Note** Do not use the Earphone Microphone when turning on and off the device or when connecting or disconnecting the Earphone Microphone to/from the device because a loud noise may be otherwise emitted during connection and disconnection.

Audio Remote Controller with Microphone

The supplied Audio Remote Controller with Microphone can be used to listen to audio playback. Combined with the headphone (sold separately), it can be used to receive phone calls. When the Audio Remote plug is inserted into the device, the microphone and speaker on the main unit will become inactive.

Also, this microphone can be used as a recorder.

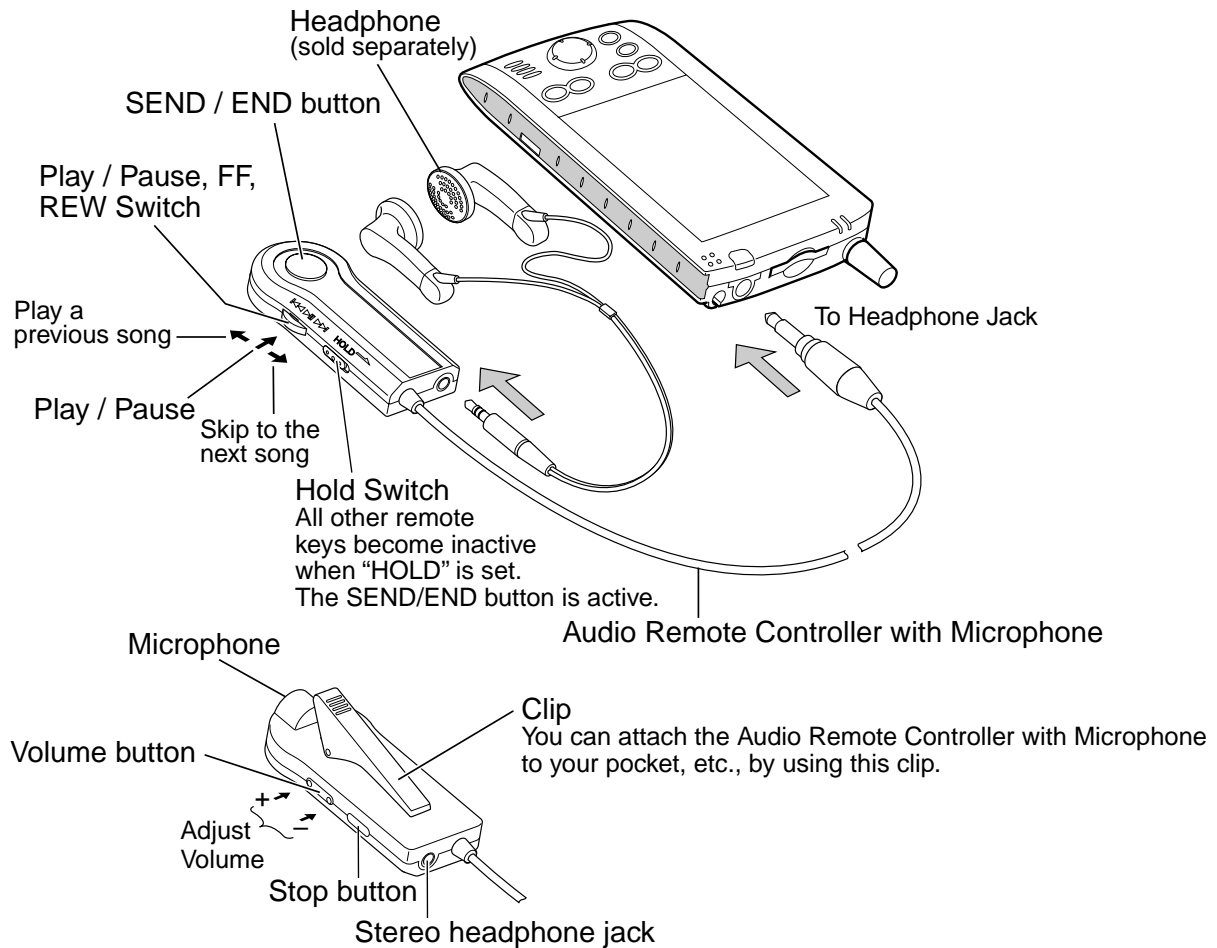

During a call, it is not possible to adjust the volume with the Volume button.

Use ø 3.5mm mini-plug type headphone to connect to the Audio Remote Controller with Microphone.

This device's phone component can be used with the Audio Remote Controller with Microphone or as a speakerphone. Unlike conventional cell phones, it is not designed to be held against the head in conversation. Such unauthorized use of the phone, without an Audio Remote Controller with Microphone or other than as a speakerphone, is contrary to the design of this product and is not recommended. For instructions on how to use the phone with Audio Remote Controller with Microphone or as a speakerphone, please refer to page 61 of this manual.

Battery Charging

When using the device for the first time, set the Battery Switch to the supply side (see page 23), then fully charge the battery.

Charging the Battery

You can use two charging methods.

When you connect the AC Adapter to the device, turn the power off.

- Connect the supplied AC Adapter to the cradle as shown in the figure below, and then insert the device into the cradle.

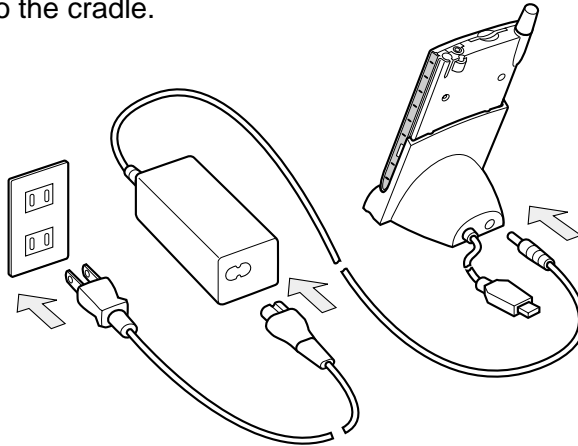

- Connect the supplied AC Adapter to the device as shown in the figure below.

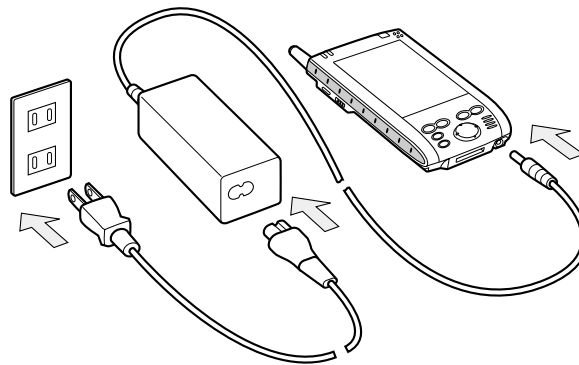

...  **Note** Charge the battery in an environment between 41°F - 95°F (5°C and 35°C). Temperatures outside this range may pause the charging process. Refer to page 24 for additional information on charging.

When charging the battery for the first time, or immediately after setting the battery switch to the supply side, fully charge the battery. If the battery is not fully charged, the remaining battery power will not be accurately displayed.

Maximizing the Battery Operating Time

- Whenever possible, use the device with the AC Adapter – especially when it is connected to your computer.
- Select the short powered-off time in the setting menu. This will shorten the time the unit will remain on if not used. See “Customizing Your Device” later in this chapter for more information.
- Turn off the front light.
- Set the screen brightness to power savings mode (front light off) or shorten the front light turn-off time. See “Customizing Your Device” later in this chapter for more information.
- For optimal performance use in an environment between 59°F - 77°F (15°C and 25°C). Anything outside this temperature range may decrease the operating time.

Battery Life

The built-in battery has a limited life that will gradually decrease after repeated charging. Replace the battery when you notice a dramatic decrease in battery performance.

Battery Charge Level and Stored Data Protection



If the battery charge level becomes extremely low or completely discharged, stored memory data will be deleted. As soon as the low battery status icon or the alarm message appears, immediately connect the AC Adapter to the device so it can charge.

- The battery gradually discharges even when not in use. If not used for a long time, it may completely discharge.
- It is strongly recommended that you save the device’s memory data to your computer or a storage card. The manufacturer is not responsible for data changed or lost due to battery discharge. For back up, see “Backing Up” in Chapter 9.

Initial Setup

When using your device for the first time, completely charge the battery then follow the initial setup procedures below:

1. Press the Power button and when the welcome screen appears, tap the screen with the stylus to start the setup process.
2. When the align screen appears, follow the directions for adjusting the touch screen until the stylus screen appears.
 - If a finger or any other object touches the screen during a correction, it will be cancelled. Repeat the correction procedure.

...  **Note** To display the align screen after the initial setup process, press the Record button while pressing the center of the navigation button, or by tapping , **Settings**, **System**, and then **Screen**.

3. Read and understand how to use the stylus, then tap **Next**.

...  **Note** See “Using the Stylus” on page 24 for more information.

4. Read and understand pop-up menu operation, then tap **Next**.
 - Read the on-screen explanation and then operate the screen.
Display the pop-up menus, and cut and paste the data according to the screen instructions.
When this stage is complete, tap **Next**.
5. Follow the directions for setting the location, then tap **Next**.
6. When the complete screen appears, initial setup is finished. After tapping the screen, the Today screen will appear and the device will be ready to use. See “Today Screen,” later in this chapter for more information.

Setup Options

Method of Setting Card into SD Card Slot

Inserting a card:

1. Turn off the power.
2. Insert the card with its contact surface (metal contact surface) facing backward into the device.

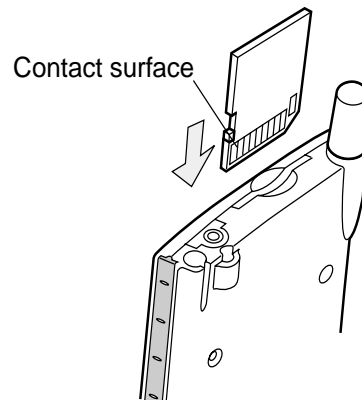

...  **Note** An SD dummy card is loaded in the SD card slot at purchase. Remove the SD dummy card before inserting the card.

Removing a card:

1. Make sure that no application is accessing the SD card.
2. Turn off the power.
3. Lightly press down on the card until a clicking sound is heard. The card will pop out slightly from the slot.
4. Pull the card straight up to remove.

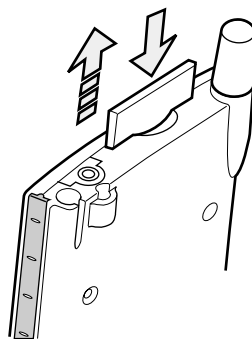

Connecting to a Computer

Before connecting your device to a computer, check the following.

- ActiveSync® is on your computer. (For installation procedures of ActiveSync®, see Quick Start Card.)
- The device is turned off.
- The computer you're connecting has an available USB port for the cradle.

To connect using the supplied USB cradle:

1. Connect the USB cradle to your computer as shown in the illustration below.

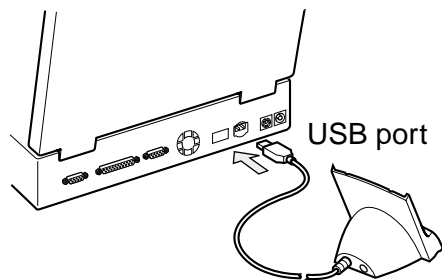

2. Insert the device into the USB cradle.

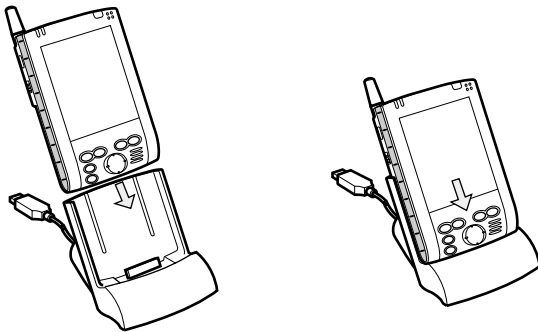

Make sure that the connector on the cradle is inserted into the port on the bottom of the device. Data can not be transferred if the connection is not made.

When your device is properly inserted into the cradle, your device will turn on automatically and ActiveSync® will automatically open on your computer.







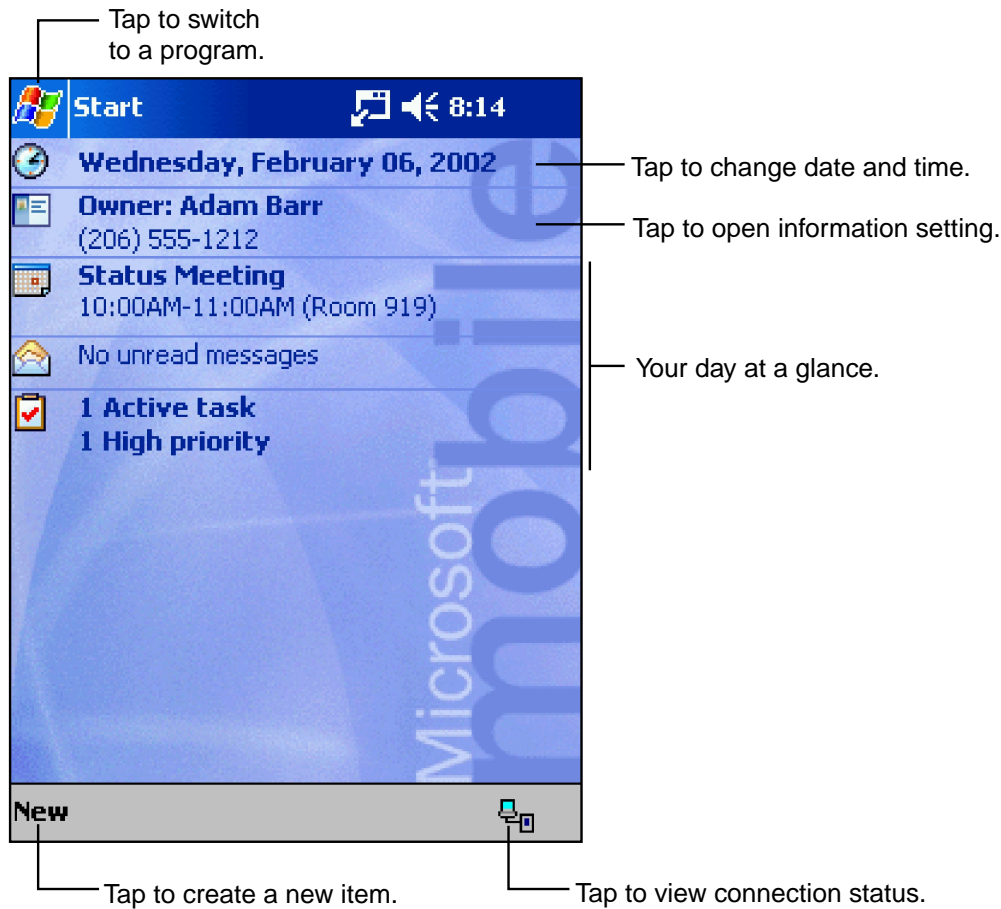



...  **Note** Avoid using your device in environments that are likely to be affected by static electricity or are prone to high electrical noise. If you connect your device to a computer via the docking cradle for data transfer or data restoration purposes, Audiovox Communications Corp. will not be responsible for any device or computer malfunction, problems with data transfer or (strikethrough: restoration creation or data communication), or data modification/loss that may occur in these environments.



Today Screen

The Today screen appears when you turn on your device after 4 hours of inactivity. It can be accessed by tapping  and then **Today**.







Following are some of the status icons you may see.

Status Icon	Meaning
	Turns all sounds on and off and changes the volume level
	Battery charging
	Battery is low
	Battery is very low
	Battery is full
	Active connection
	Synchronization is beginning or ending
	Synchronization in process
	Notification that a new program or system update is available
	Instant message received
	E-mail message received



...  **Note** If more notification icons need to be displayed than there is room for on the screen, the  will display. Tap the icon to view all the notifications.

Watcher™ Status Icons:

When Watcher™ is activated, the following icons may be displayed on the command bar of the Today screen.











Status Icon	Meaning
	Not connected to the network
	Connected to the network
	There is a missed call
	There is an unread SMS message
	There is a voice mail message

Programs

Switch from one program to another by using the  menu. To access programs not listed on the drop down menu, tap , **Programs**, then the desired program.

You can also switch to another program by pressing any of the five program buttons located on the front and side of the device. The icons above the buttons identify the factory set programs (from left to right) – Calendar, Tasks, Home and Contacts. The Record button on the side is for voice recording. To reprogram these buttons to activate other programs, see page 47, “Adjusting Settings.”

The following table is a partial list of programs on your device.

Icon	Program	Description
	ActiveSync®	Synchronize information between your device and your computer.
	Calendar	Keep track of your appointments and create meeting requests.
	Contacts	Keep track of your friends and colleagues.
	Inbox	Send and receive e-mail messages.
	Pocket Internet Explorer	Browse Web and WAP sites, and download new programs and files from the Internet.
	Notes	Create handwritten or typed notes, drawings, and recordings.
	Tasks	Keep track of your tasks.
	Pocket Excel	Create Excel spreadsheets or view and edit Excel spreadsheets created on your computer.
	MSN® Messenger	Send and receive instant messages with your MSN® Messenger contacts.
	Pocket Word	Create new documents or view and edit Word documents created on your computer.

In addition to the programs listed above, Windows Media™ Player, Backup, Calculator, File Explorer, Home, Infrared Receive, Microsoft Reader, Terminal Services Client, Watcher, Solitaire are pre- installed.

...  **Note** The program can be launched by using Home. See “Home” in Chapter 9.

Navigation Bar and Command Bar

The navigation bar, located at the top of the screen, displays the active program and time, and allows you to switch programs and close screens.

The command bar at the bottom of the screen performs tasks in the open program, and includes menu names, buttons and the Input Panel button. Tap **New** to create a new item in the program.

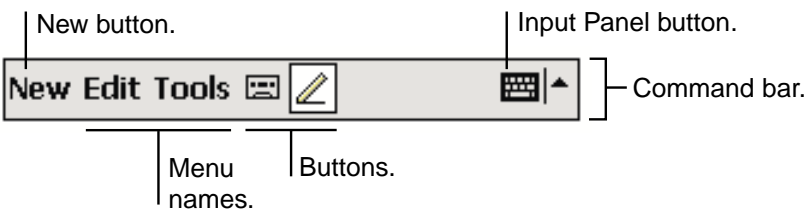
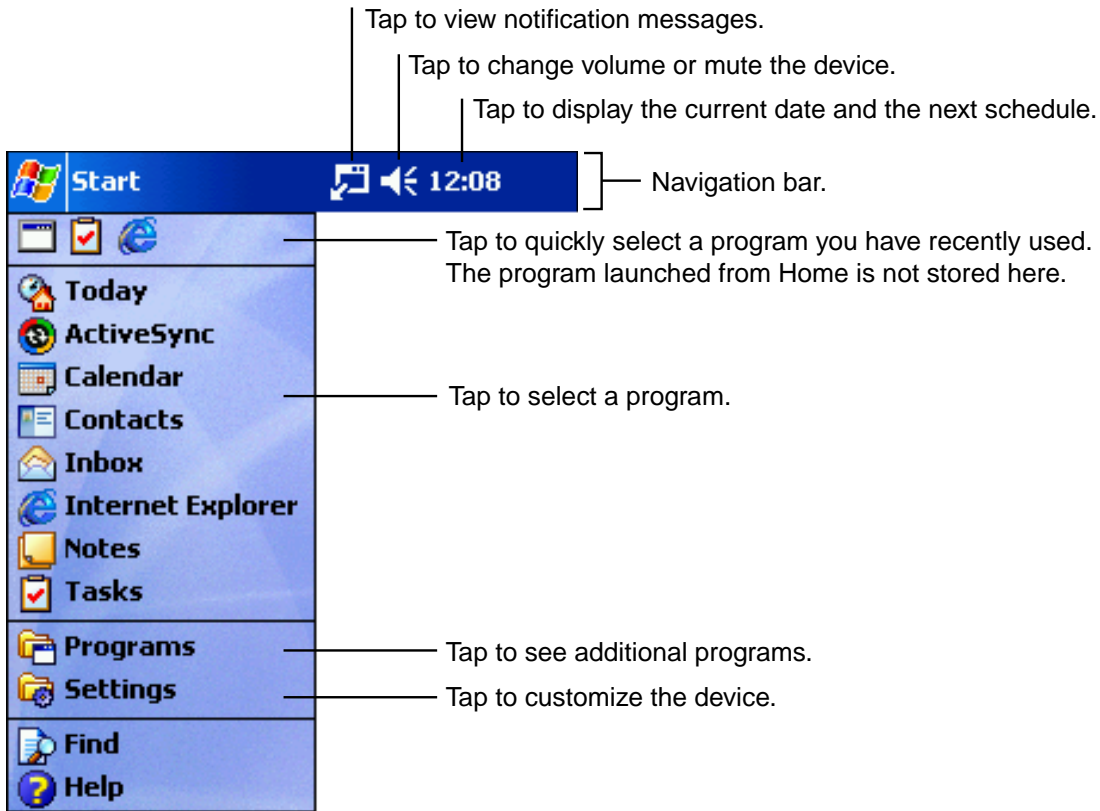

... **Note** If you tap on the right of the navigation bar, you can close that program screen. Also, if you tap on the navigation bar, you can close that screen.

To end the program, tap , **Settings**, **System**, **Memory** and **Running Programs**, and select the program you wish to end, then tap **Stop**.

You can also end the program with Home.

Pop-up Menu

Pop-up menus provide quick access to select an action for an item, and vary with each program. To access a pop-up menu, tap and hold the stylus on the item you want to perform the action on. When the menu appears, lift the stylus and tap the desired action. Tap anywhere outside the menu to close it.

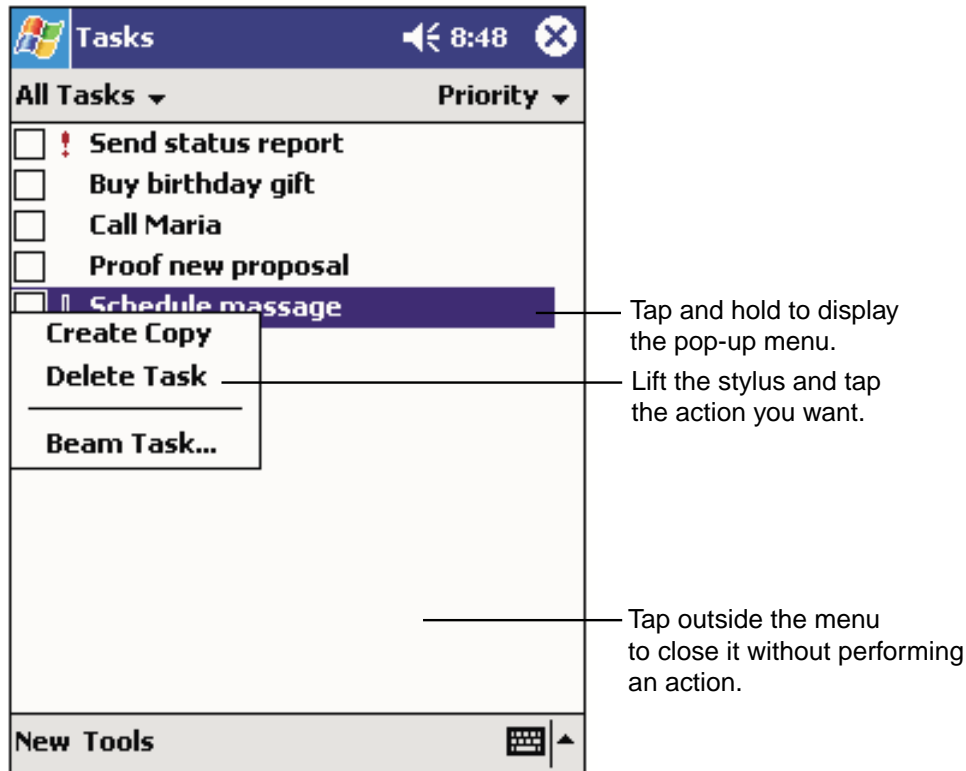

Notifications

Your device can remind you when you have an appointment or task scheduled, or serve as an alarm clock. Notification options include:

- A message box on the screen
- A sound (which you select)
- A flashing light

To select reminder types and sounds, tap  and then **Settings**. In the **Personal** tab, tap **Sounds & Notifications**. The selected options will apply for the entire device.

Entering Information

Options for entering new information include:

- Using the input panel to enter typed text.
- Writing or drawing pictures directly on the screen.
- Recording a message by speaking into the microphone.
- Using Microsoft® ActiveSync® to synchronize or copy information from your computer to the your device.

Entering Text Using the Input Panel

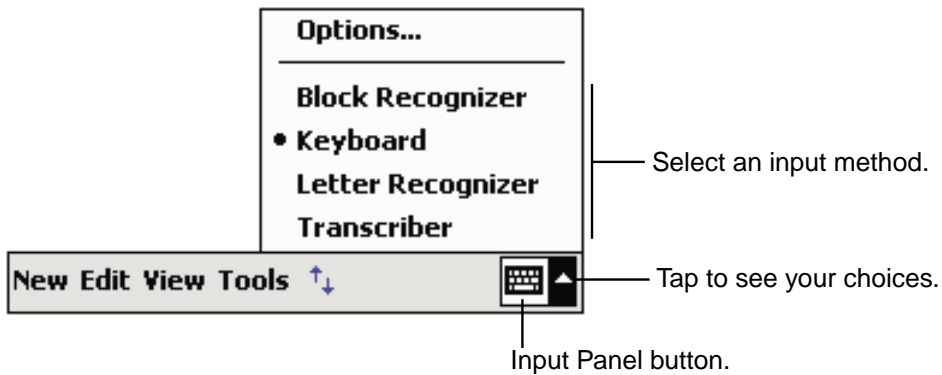

Use the input panel to enter information in any program by either typing using the soft keyboard, or by writing using the Letter Recognizer, Block Recognizer or Transcriber. With either option the characters will appear as typed text on the screen.

To view/hide the input panel, tap the Input Panel button. Tap the arrow next to it to see your options.

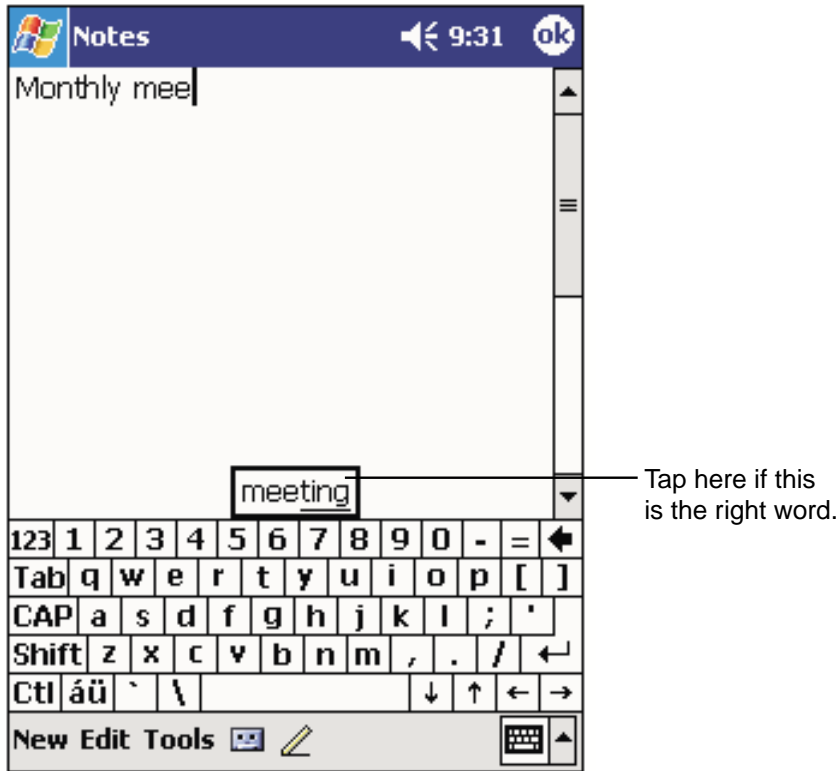

When you use the input panel, your device anticipates the word you are typing or writing and displays it above the input panel. When you tap the displayed word, it is inserted into your text at the insertion point. The more you use your device, the more words it learns to anticipate.



...  **Note** To change word suggestion options, such as the number of words suggested at one time, tap , **Settings, Personal tab, Input,** and then the **Word Completion** tab.

Typing with the soft keyboard:

1. Tap the arrow next to the Input Panel button and then **Keyboard**.
2. Use the stylus to tap the keys on the soft keyboard.

Using Letter Recognizer:

With Letter Recognizer you can write letters using the stylus just as you would on paper.

1. Tap the arrow next to the Input Panel button and then **Letter Recognizer**.
2. Write a letter in the box – it will automatically be converted to typed text on the screen.

For specific instructions, open Letter Recognizer and tap the question mark icon next to the writing area.

Using Block Recognizer:

With Block Recognizer you can use the stylus to input character strokes similar to those used on other devices.

1. Tap the arrow next to the Input Panel button and then **Block Recognizer**.
2. Write a letter in the box — it will automatically be converted to typed text on the screen.

For specific instructions, open Block Recognizer and tap the question mark icon next to the writing area.

Using Transcriber:

With Transcriber you can write anywhere on the screen using the stylus just as you would on paper. Unlike Letter Recognizer and Block Recognizer, you can write a sentence or more of information. Then, pause and let Transcriber change the written characters to typed characters.

1. Tap the arrow next to the Input Panel button and then **Transcriber**.
2. Tap **OK** to close the explanation screen of Transcriber.
3. Write anywhere on the screen.

For specific instructions, open Transcriber and tap the question mark icon next to the writing area.

Selecting typed text:

1. Drag the stylus across the text you want to select.
2. Format or edit text by tapping the command on the **Edit** menu or by tapping and holding the selected words until the pop-up menu appears.

Writing on the Screen

To write on the screen, write the same way do on paper. The text can be edited, formatted or converted at a later time.

Writing on the screen:

- To switch to the writing mode, tap the **Pen** button. Lines will appear on the screen to help you write.

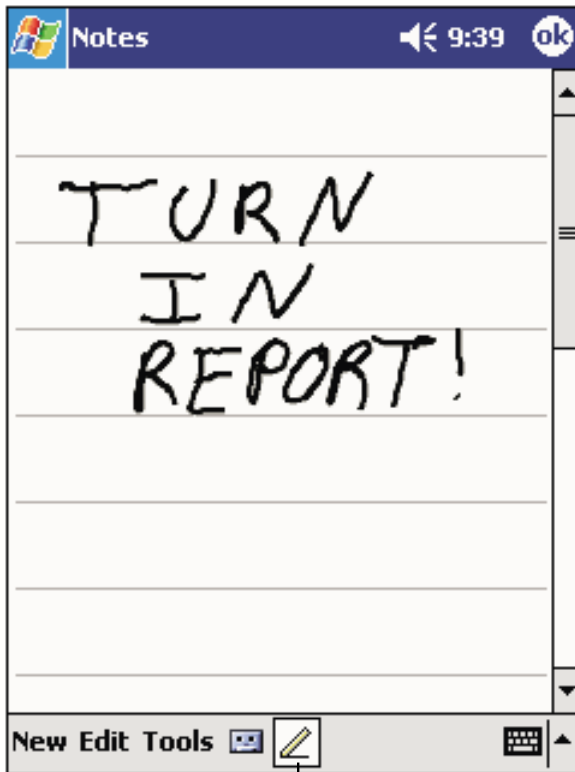

Tap the Pen button and use your stylus like a pen.

...  **Note** Not all programs that accept writing feature the **Pen** button. Refer to that program's documentation to find out how to switch to writing.

If you accidentally write on the screen, tap **Edit**, then **Undo** and try again.

To select writing:

If you want to edit or format writing, you must select it first.

1. Tap the **Pen** button to cancel the writing mode.
2. Drag the stylus across the text you want to select.

You can cut, copy, and paste written text in the same way you work with typed text: tap and hold the selected words and then tap an editing command on the pop-up menu, or tap the command on the **Edit** menu.

Converting writing to text:

- Tap **Tools** and then **Recognize**.

If you want to convert only certain words, select them before tapping **Recognize** on the **Tools** menu (or tap and hold the selected words and then tap **Recognize** on the pop-up menu). If a word is not recognized, it is left as writing.

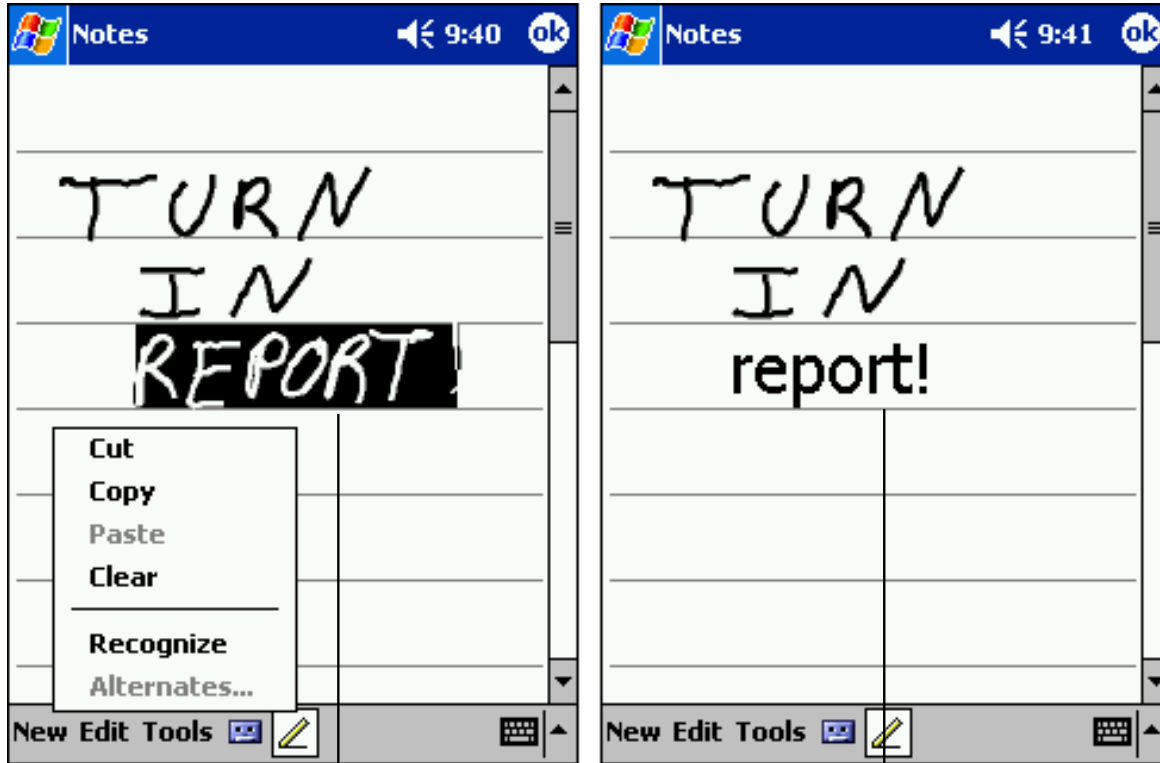

Select the text you want to convert and tap Recognize on the pop-up menu.

The writing is turned into text.

If the word conversion is incorrect, you can select an alternative word by tapping and holding down on the wrong word. On the pop-up menu tap **Alternates** and browse the list. Either tap the word you want to use, or tap the writing at the top of the menu to return to the original writing.

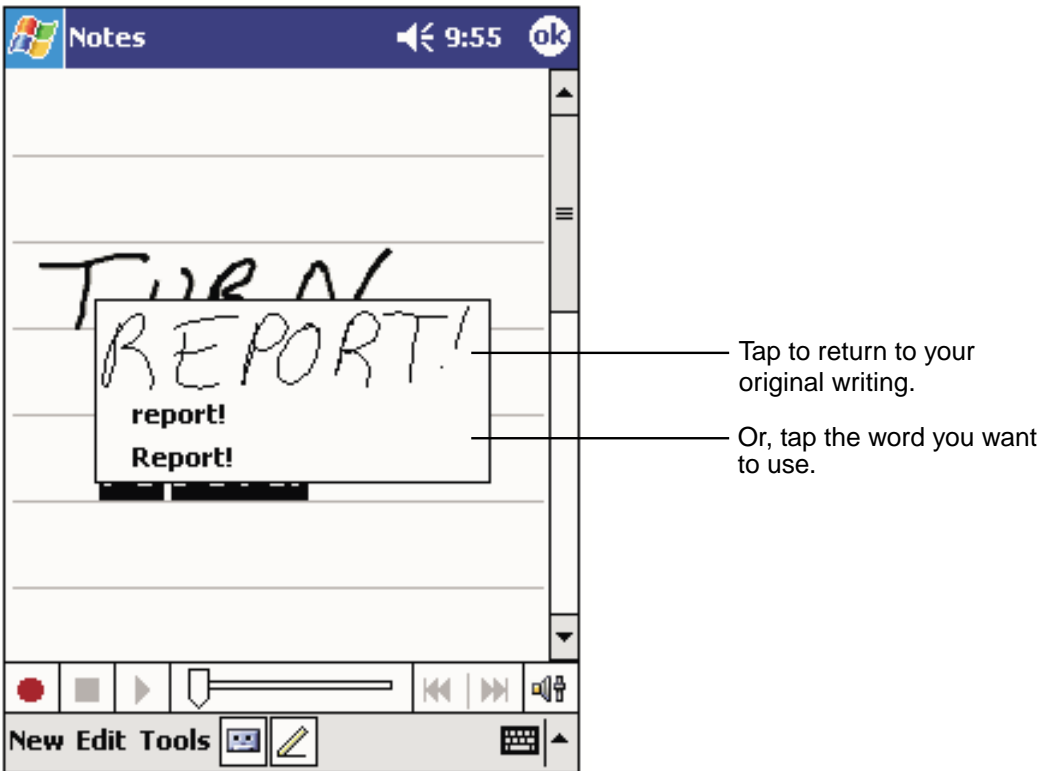

For best recognition:

- Write neatly within the lines and draw descenders below the line. Write the cross of the “t” and apostrophes below the top line so they aren’t confused with the word above. Write periods and commas above the line.
- Using the **Tools** menu, increase the zoom level to 300%.
- Write the letters of words close together and leave big gaps between words.
- Any changes made to a word after you attempt to recognize it (such as changing a “3” to an “8”) will not be included if you attempt to recognize it again.

...  **Note** Hyphenated words, foreign words that use special characters such as accents, and some punctuation cannot be converted.

Drawing on the Screen

Draw on the screen in the same way that you write on it. The only difference is how the items are selected and edited. For example, drawings can be resized - writing cannot.

Creating a drawing:

- A drawing box will appear when you cross any three ruled lines on your first stroke. Subsequent strokes in or touching the box become part of the drawing. Drawings that do not cross three lines will be considered writing.

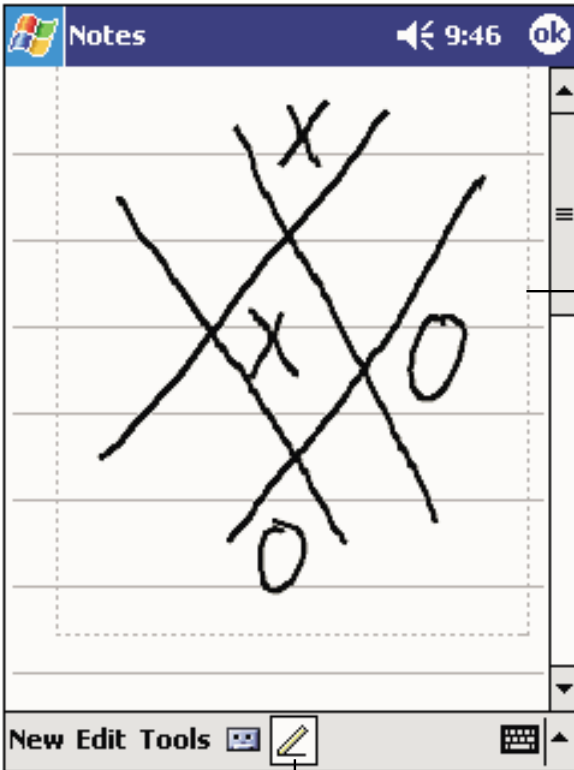

The drawing box indicates the boundaries of the drawing.

Pen button.

...  **Note** You may want to change the zoom level so that you can more easily work on or view your drawing. Tap **Tools** and then a zoom level.

Selecting a drawing:

If you want to edit or format a drawing, you must select it first.

- Tap and hold the stylus on the drawing until the selection handle appears. To select multiple drawings, deselect the **Pen** button and then drag to select the drawings you want.

You can cut, copy, and paste selected drawings by tapping and holding the selected drawing and then tapping an editing command on the pop-up menu, or by tapping the command on the **Edit** menu. To resize a drawing, make sure the **Pen** button is not selected, and drag a selection handle.



Recording a Message

A message can also be recorded on any program where you can write or draw on screen. In Calendar, tasks and Contacts, you can include a recording in the **Notes** tab. In the Notes program, you can either create a stand-alone recording or include a recording with a written note. With the Inbox program a recording can be added to an e-mail.

When recording or playing a message during data communication, hold the device keeping distance from your body as shown on page 61.

Creating a recording:

1. Hold the device's microphone near your mouth or sound source.
2. Press and hold the Record button (on the left side) until it beeps.
3. While holding down the button make the recording.
4. Release the button to stop recording and two beeps will sound. The new recording appears in the note list or as an embedded icon.

...  **Note** Tapping the Record  button on the Recording toolbar can also make a recording. To end recording, press the Stop  button.

To play a recording, tap it in the list or tap its icon in the note.

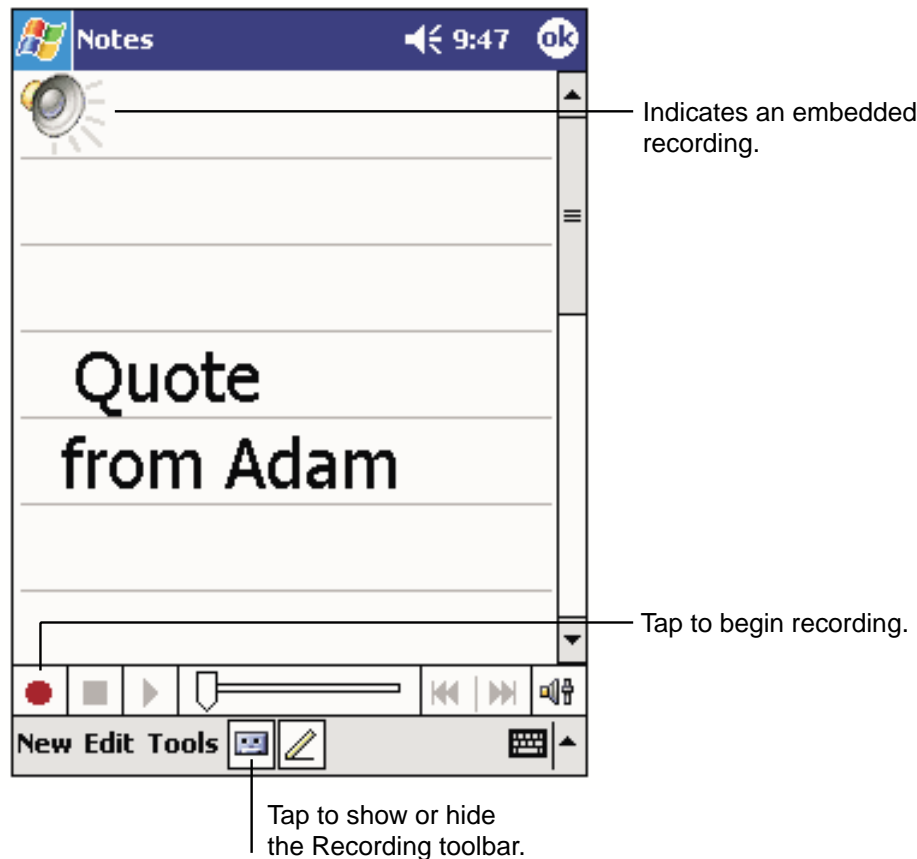

Using My Text

My Text quickly inserts preset and frequently used messages into the text entry areas of Inbox or MSN® Messenger. To insert a message, tap **My Text** and select a message.

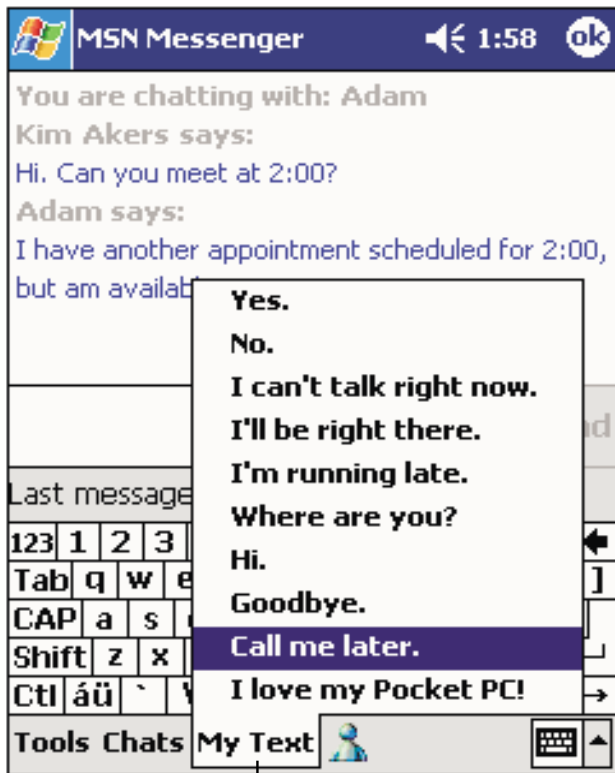

Tap to select a prewritten message.

...  **Note** You can add text after inserting a My Text message.

To edit a My Text Message, tap **Edit My Text Messages** in the **Tools** menu. Select the message you wish to edit and make the changes. Tap **OK** in the upper right corner to complete the change.

Finding and Organizing Information

To quickly locate information using the Find feature, tap **Find** in the  menu.

...  **Note** To quickly find information that is taking up storage space on your device, select **Larger than 64 KB** in **Type**.

File Explorer can also find files on your device and organize them into folders. To access from the  menu, tap **Programs**, then **File Explorer**.

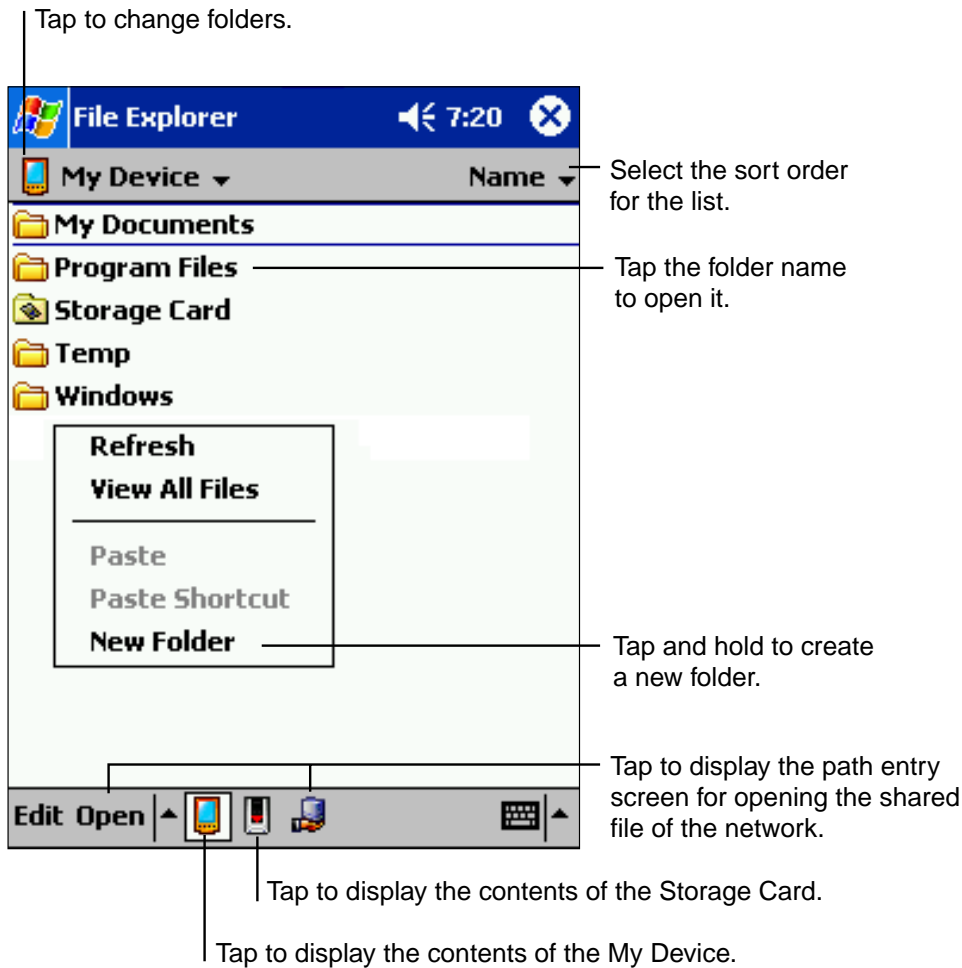



...  **Note** To move files in File Explorer, tap and hold the item you want to move then tap **Cut** or **Copy**. Go to the file where you want to move the document and tap **Paste** on the pop-up menu.

Customizing Your Device

Customize your device by adjusting the settings and installing additional software.

Adjusting Settings

Settings can be adjusted by tapping , **Settings**, and then the **Personal** or **System** tab located at the bottom of the screen. The following settings can be adjusted:

- **Clock:** To change the time or to set alarms.
- **Menus:** To customize what appears on the  menu, and to enable a pop-up menu from the **New** button.
- **Owner Information:** To enter your contact information.
- **Today:** To customize the look and the information that is displayed on the Today screen.
- **Buttons:** To assign your favorite program to the program button.
- **Remove Programs:** See the following pages.
- **Password:** To limit access to your device. See the following pages.
- **Front Light:** See the following pages.
- **Power:** To maximize battery life. See the following pages.
- **Memory:** See the following pages.

Adding or Removing Programs

Programs installed on your device at the factory are stored on ROM (read-only memory) and cannot be removed or accidentally lost. ROM programs can be updated using special installation programs with a *.xip extension. Any programs and files added after factory installation are stored in RAM (random access memory). As long as you have enough memory, you can install any program created for your device. To find software for your device, visit the Pocket PC website at <http://www.microsoft.com/mobile/pocketpc>.

...  **Note** If you update ROM programs using special installation programs with a *.xip extension, do not use the backup data which you made before updating ROM programs.

Adding programs using ActiveSync®:

Before installing a program on your device, the appropriate software will need to be installed on the computer.

1. Determine which version of the software to install by tapping , then **Settings**. On the **System** tab, tap **About**. In the **Version** tab, make a note of the information in **Processor**.
2. Download the program to your computer (Or insert the CD or disk that contains the program into your computer). You may see a single *.xip, *.exe, or *.zip file, a Setup.exe file, or several versions of files for different Pocket PC types and processors. Be sure to select the program designed for the Pocket PC and your device processor type.
3. Read any installation instructions, Read Me files, or documentation that comes with the program. Many programs provide special installation instructions.
4. Connect your device and your computer.
5. Double-click the *.exe file.
 - If the file is an installer, the installation wizard will begin. Follow the directions on the screen. Once the software has been installed on your computer, the installer will automatically transfer the software to your device.
 - If the file is not an installer, an error message will appear stating that the program is valid but designed for a different computer. You will need to move this file to your device. If you cannot find any installation instructions for the program in the Read Me file or documentation, use ActiveSync® Explore to copy the program file to the Program Files folder on your device. For more information on copying files using ActiveSync®, see ActiveSync® Help.

Once installation is complete, tap , **Programs**, and then the program icon.

Adding a program directly from the Internet:

1. Determine which version of the software to install by tapping , then **Settings**. On the **System** tab, tap **About**. In the **Version** tab, make a note of the information in **Processor**.
2. Download the program to your device straight from the Internet using Pocket Internet Explorer. You may see a single *.xip, *.exe or *.zip file, a Setup.exe file, or several versions of files for different device types and processors. Be sure to select the program designed for the Pocket PC and your device processor type.
3. Read any installation instructions, Read Me files, or documentation that comes with the program. Many programs provide special installation instructions.
4. Tap the file, such as a *.xip or *.exe file. The installation wizard will begin. Follow the directions on the screen.

Adding a program to the Start menu:

Tap , **Settings**, **Menus**, the **Start Menu** tab, then the check box for the program. If you do not see the program listed, you can either use File Explorer on the device to create a shortcut the program to the Start Menu folder or use ActiveSync® on your computer to create a shortcut to the program and place the shortcut in the Start Menu folder.

- **Using File Explorer on the device:** Tap , **Programs**, **File Explorer**, and locate the program (tap the folder list, labeled **My Documents** by default, then **My Device** to see a list of all folders on the device). Tap and hold the program and tap **Copy** on the pop-up menu. Open the Start Menu folder located in the Windows folder, tap and hold a blank area of the screen, and tap **Paste Shortcut** on the pop-up menu.

The program will now appear on the  menu. For more information on using File Explorer, see “Finding and Organizing Information,” on page 46.

- **Using ActiveSync® on your computer:** Use the Explorer in ActiveSync® to explore your device files and locate the program. Right-click the program, then click **Create Shortcut**. Move the shortcut to the Start Menu folder in the Windows folder. The shortcut now appears on the  menu. For more information, see ActiveSync® Help.

Removing programs:

- Tap , then **Settings**. On the **System** tab, tap **Remove Programs**.

If the program does not appear in the list of installed programs, use File Explorer on your device to locate the program, tap and hold the program, and then tap **Delete** on the pop-up menu.

Setting Password

Protect data and settings by choosing a password that will be requested every time the power is turned on.

1. Tap , then **Settings**. On the **Personal** tab, tap **Password**.
2. Select the type of password you would like to use.

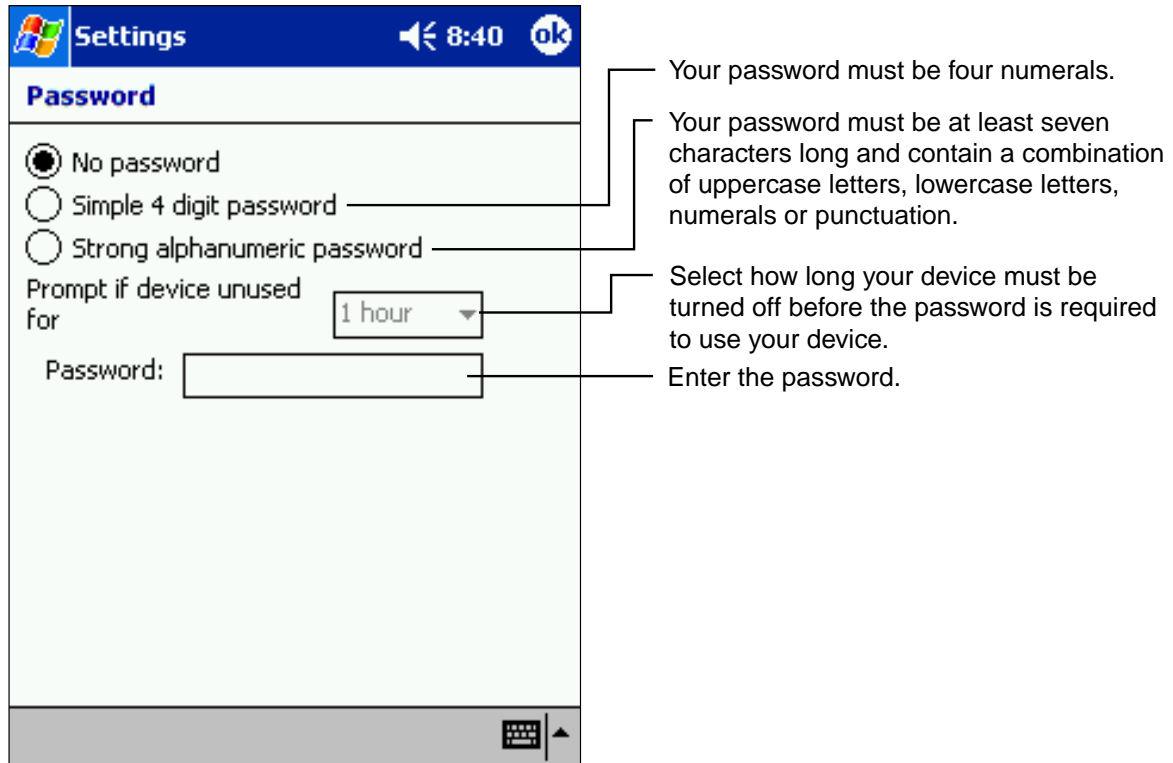

3. Enter a password and tap **OK**.
4. Tap **YES** on the confirmation screen. The password is saved and the screen returns to the Personal tab screen.

...  **Note** Record your password in a safe place. If you wish to change your password, you will have to know the existing one to access the Password setting screen. If you forget your password, you will have to initialize the device, which deletes all stored data and settings. If the power is off, you will not be able to answer or make a phone call without entering your password. You can automatically receive a call when the Auto-Answer is activated. However, you cannot disconnect without entering the password.

Setting the Front Light

1. Tap , then **Settings**. On the **System** tab, tap **Front Light**.
2. Set the Front Light.

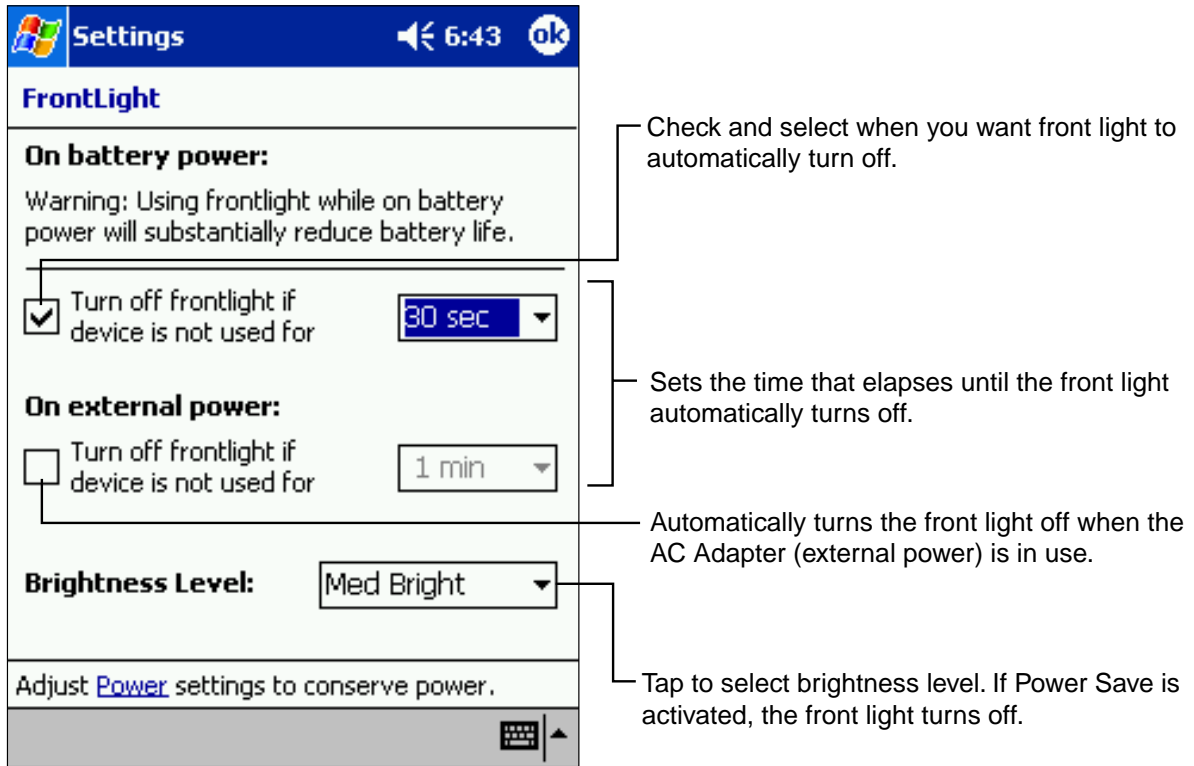

3. When finished, tap **OK**.

...  **Note** If the remaining battery power decreases, the brightness level may be lower than the selected setting.

Setting Power

To confirm and control power usage:

1. Tap , then **Settings**. On the **System** tab, tap **Power**.
2. Set Power Options.

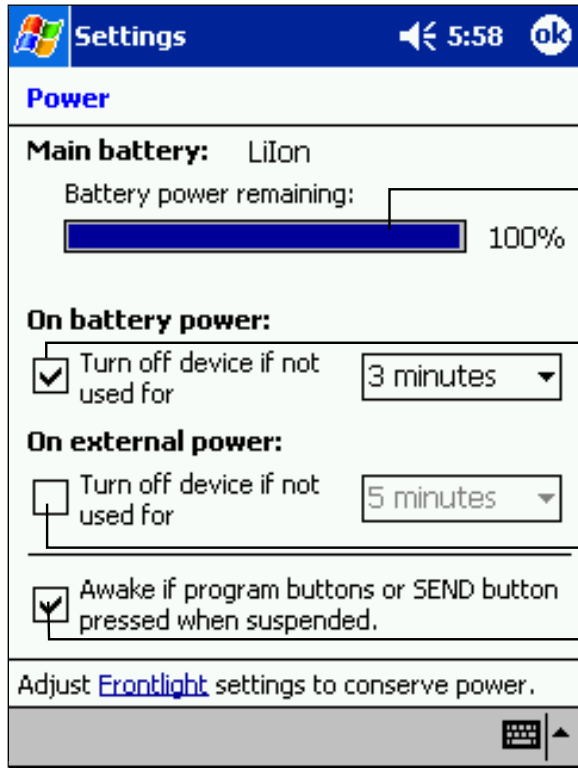

The screenshot shows the Windows Settings application with the 'Power' settings page. The top bar shows the Windows logo, 'Settings', a back arrow, the time '5:58', and an 'OK' button. The main content area is titled 'Power' and includes the following sections:

- Main battery:** LiIon. Below this is a 'Battery power remaining:' section with a blue progress bar and '100%'.
- On battery power:** A checkbox is checked for 'Turn off device if not used for', with a dropdown menu set to '3 minutes'.
- On external power:** A checkbox is unchecked for 'Turn off device if not used for', with a dropdown menu set to '5 minutes'.
- A checkbox is checked for 'Awake if program buttons or SEND button pressed when suspended'.
- At the bottom, there is a link to 'Adjust [Frontlight](#) settings to conserve power.'

Annotations on the right side of the image explain the following elements:

- The battery progress bar: Displays remaining battery power. When the AC Adapter is used, the battery charging mode is displayed, but the remaining battery power is not displayed.
- The 'On battery power' checkbox: When checked, automatically turns off when the device hasn't been used for a user-set amount of time.
- The 'On external power' checkbox: Sets the time that elapses until the power automatically turns off.
- The 'Awake if program buttons or SEND button pressed when suspended' checkbox: Automatically turns the power off when the AC Adapter (external power) is in use.
- The 'Awake if program buttons or SEND button pressed when suspended' checkbox: Check to turn the power on if you press the program buttons or the SEND button when the device is off. To prevent the device from being turned on when the button is pressed accidentally, clear the checkbox.

3. When finished, tap **OK**.

Setting Memory

Memory for the device is automatically managed. You can adjust data storage memory and program running memory, and confirm the amount of free space on a storage card.

Changing memory allocation:

1. Tap , then **Settings**. On the **System** tab, tap **Memory** to display the Memory setting screen.

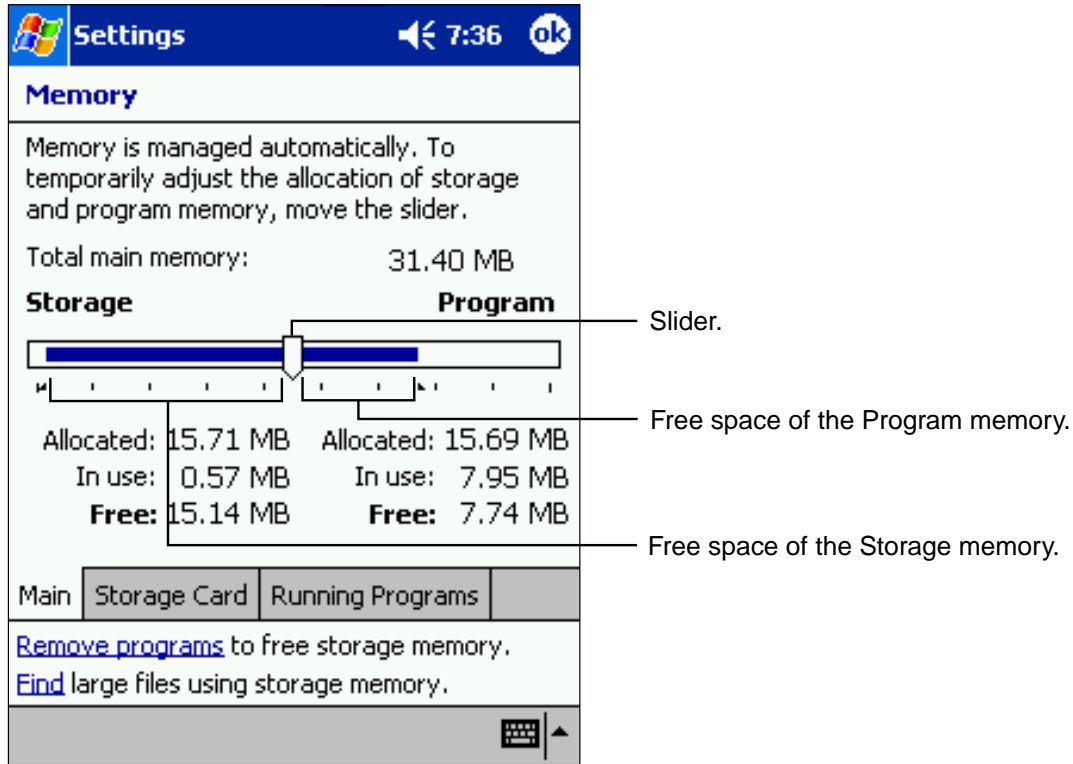

2. Drag the slider widthwise to adjust the memory allocation between Storage and Program.
3. When finished, tap **OK**.

To confirm usage status of a storage card:

1. Tap , then **Settings**. On the **System** tab, tap **Memory**, then the **Storage Card** tab on the bottom.

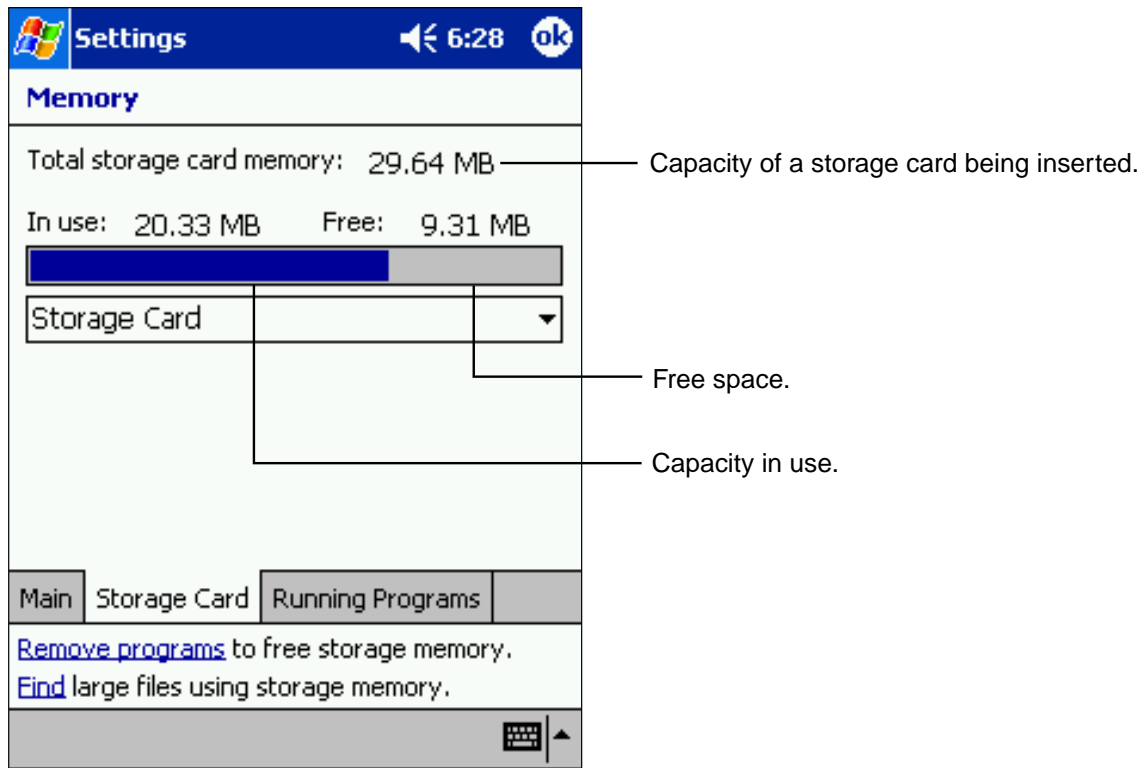



2. When finished, tap **OK**.

Releasing memory:

If memory is approaching full capacity, you can free up space by:

- Transferring data to a storage card or to your computer then delete it from your device.
- Deleting unnecessary files and programs.
- Quitting the program currently in use.

...  **Note** For more detailed information on operation method or the releasing memory, tap  then **Help**.

Chapter 3

Phone Functions

This device's phone component can be used with the Earphone Microphone or as a speakerphone. Unlike conventional cell phones, it is not designed to be held against the head in conversation. Such unauthorized use of the phone, without an Earphone Microphone or other than as a speakerphone, is contrary to the design of this product and is not recommended. For instructions on how to use the phone with Earphone Microphone or as a speakerphone, please refer to page 61 of this manual.

Using Phone Function

Launching Watcher

The "Watcher" program is used for the phone functions of your device. When the Radio Standby Switch is ON and Watcher is launched, the Watcher screen automatically is displayed when a call is received, even if you are currently using another program.

1. Turn the Radio Standby Switch (located on the left side) ON. Watcher will automatically launch and the phone can be used when the main screen appears.

...  **Note** When launched, a watcher status icon is displayed on the right part of the Today screen command bar.

As long as the Radio Standby Switch is ON, the Watcher screen will automatically appear when a call is received, **even if the main unit is off**.

Thera is operated by the Pocket PC operating system and the application programs on the device, pre-loaded and post-loaded. If the system get in such unusual case as when a button or tapping the screen does not respond, the phone functions are also unavailable, voice or data, outgoing or incoming. In such a case, please reset your device. See Chapter 10 (Resetting).

Ending Watcher

1. Turn the Radio Standby Switch OFF. Watcher will turn off and the screen will disappear. Do not quit Watcher during a call or communication.

...  **Note** When Watcher is OFF, the phone functions will not work even if the device is on. If you turn the switch OFF while the device is OFF, the device will turn on automatically, and then the Watcher will turn off.

Main Screen

DATA tab

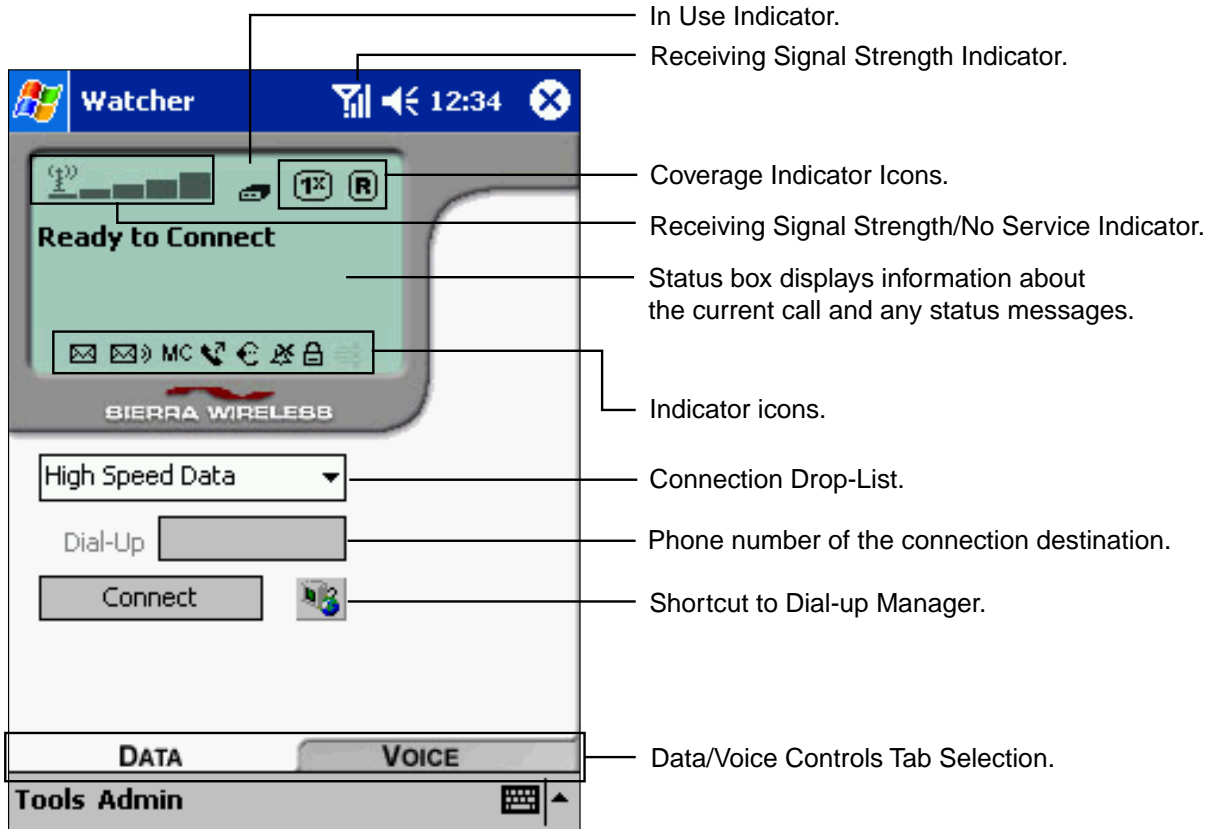



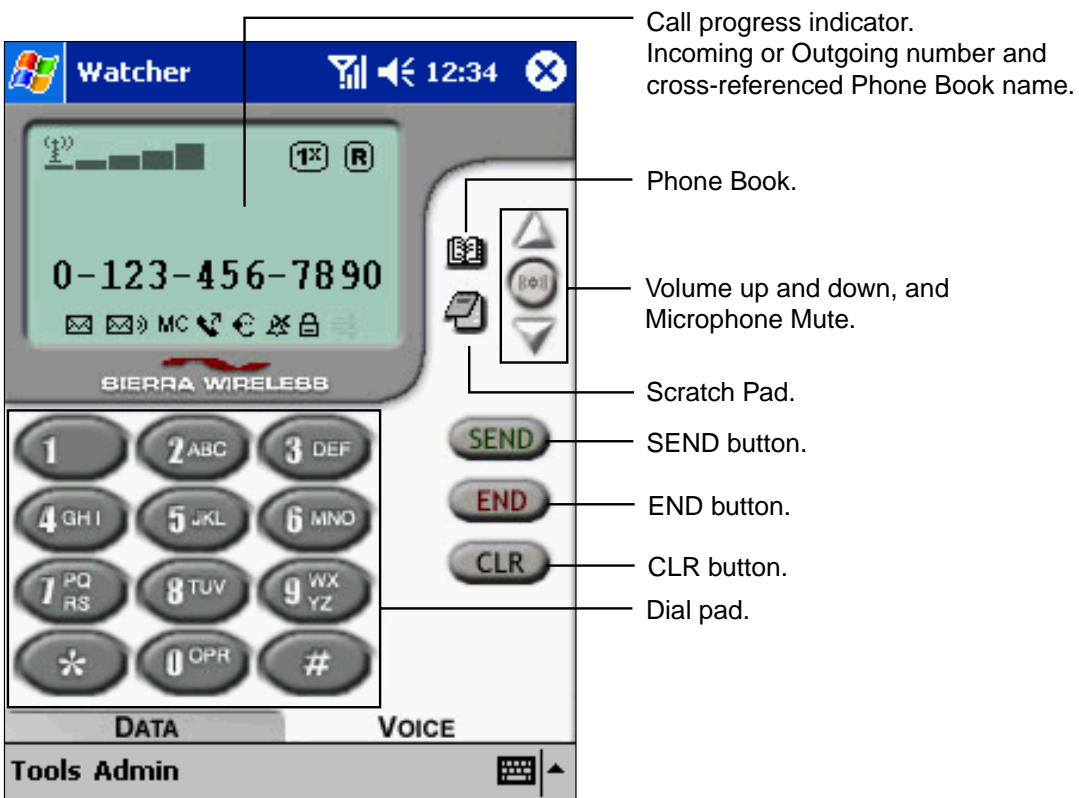









VOICE tab







Icons

Icons of the display indication

Icon	Meaning
	Auto-Answer incoming Voice Calls
	Unread message waiting - flashes when message is set to high priority.
	One or more voice mail messages
	One or more missed calls
	Earphone connected to the device
	When receiving a call, the ringer tone sounds and the vibrating alert vibrates simultaneously.
	When receiving a call, the ringer tone does not sound but the vibrating alert vibrates.
	When receiving a call, the ringer tone does not sound and the vibrating alert does not vibrate.
	Mutes during a call.
	Enhanced Voice Privacy is available during a call.
	1x Service can be used
	Roaming

Icons of the modem

Icon	Meaning
	Modem is currently unusable.
	Data transfer
	High speed data transfer
	Voice call

Keypad Operation List

Regardless of the program in use, pressing the SEND button or the END button while Watcher is open displays the **VOICE** tab of the Watcher screen.

Even if the power is turned off, pressing the SEND button turns the power on and displays the **VOICE** tab screen. (However, the setting can be changed not to turn the power on.)

When the Watcher screen is displayed, the SEND/END buttons on the device perform the same functions as the **SEND/END** buttons on the screen. Button functions include:

	Idle	Incoming Call	During a Voice Call
SEND	Calls phone number displayed on screen. If a phone number is not displayed, last number dialed is called.	Answer a call.	Answers incoming call; switches to Three-Way calling.
END	Delete all entered numbers at once.	Reject the incoming call.	End all calls including the three-way calling.
CLR	Delete entered numbers one by one or tap and hold CLR button to delete them all at one time.	Mute the ringer tone.	Delete messages or entered numbers one by one. Tap and hold the CLR button to delete them all at one time.
0-9, *, #	Enter the number you wish to call. Tap and hold the Speed Dial location number for one-touch dialing of that number.	If Any-key Answer is set, you can answer a call by tapping any of these keys.	Number entered is displayed on screen.

Navigation Button and Program

When in the Watcher screen, pressing the navigation button on the device opens the following programs:

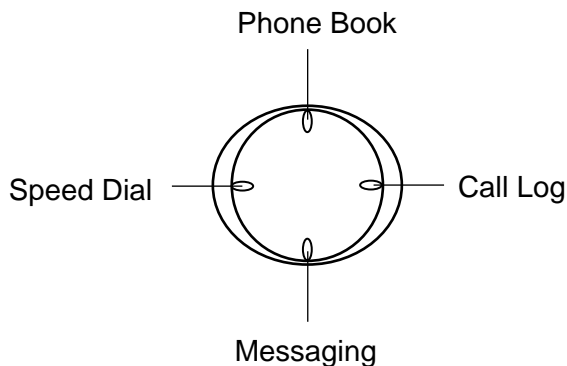

- Top : Phone Book
- Bottom : Messaging
- Right : Call Log
- Left : Speed Dial

Tools menu:

The following items can be selected from the **Tools** menu of the **DATA** and **VOICE** tabs:

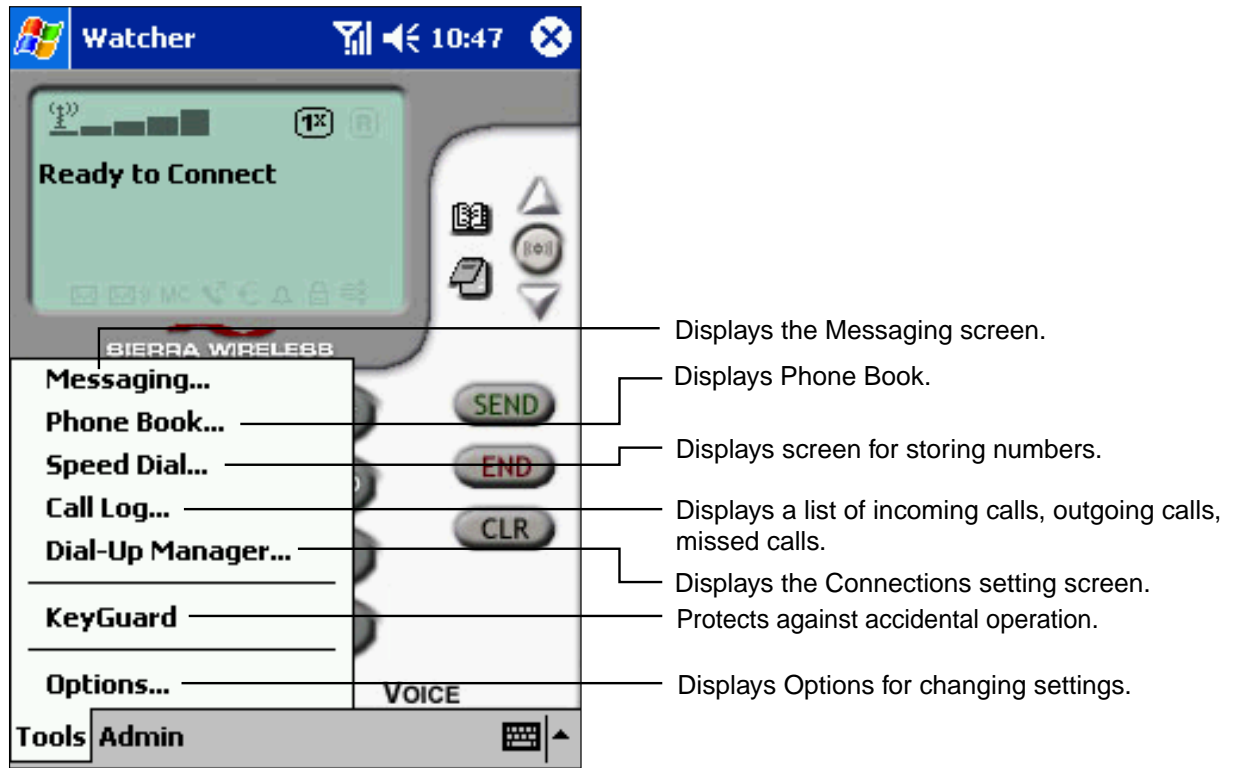

Admin menu:

The following items can be selected from the **Admin** menu of the **DATA** and **VOICE** tabs:

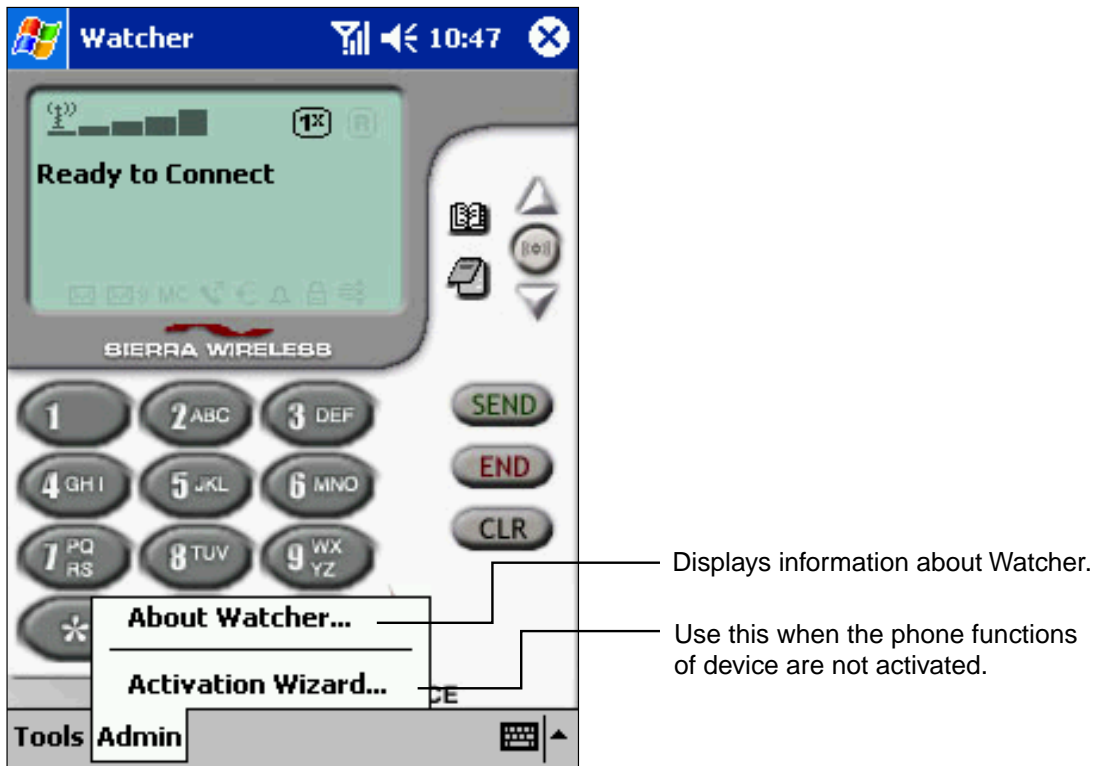

Talking on the Phone

Here explains how to use your device when you talk on the phone. Keep the device from your face more than 1 inch (2.5 cm).

Using the Microphone and Speaker:

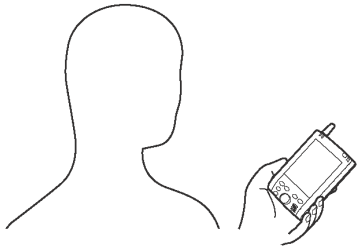

Using the Earphone Microphone:

To use the supplied Earphone Microphone, insert it into the headphone jack.

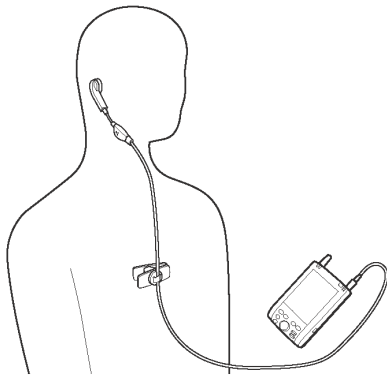

For the Earphone Microphone, see page 25 of Chapter 2.

Using the Audio Remote Controller with Microphone:

To use the Audio Remote Controller with Microphone, insert it into the headphone jack and insert the headphone (sold separately) into the stereo headphone jack of the Audio Remote Controller with Microphone.

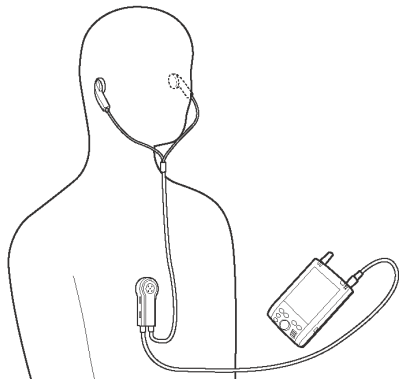

For the Audio Remote Controller with Microphone, see page 26 of Chapter 2.

To use the **SEND/END** button of the controller, press and immediately release for **SEND** and press and hold for **END**.

Placing Calls

To place a call, Watcher must be launched.

Dialing

1. On the **VOICE** tab screen, use the dial pad to enter the phone number and tap **SEND**.
☎ appears when the call is connected.





- ...  **Note** If a mistake is made while dialing, tap **CLR** to clear the last digit, or **END** to clear the entire number.

Ending a Call

1. Tap **END** to end a call. The call time will disappear from the screen.

Dialing from the Phone Book

1. To access Phone Book either tap  on the **VOICE** tab screen or tap **Phone Book** on the **Tools** menu.
2. Select the phone number you wish to call, then tap **Dial** on the command bar.  appears when the call is connected.

...  **Note** **Dial** can be found in the pop-up menu that appears when you tap and hold a phone book entry. Double tapping the desired phone number also places the call.

Speed Dialing

1. On the **VOICE** tab screen, tap and hold the corresponding speed dial location number of the number you wish to call for at least one second. The phone number stored at that location is dialed.

...  **Note** Selecting the corresponding speed dial location on the keypad and then tapping **SEND** can also place Speed Dial calls.

For more details on this function see “Speed Dial” (page 70).

Dialing from the Call Log

1. Tap **Call Log** on the **Tools** menu.
2. Tap the number you want to dial and select **Dial** from the **File** menu, or press the center of the navigation button.

...  **Note** You can also place calls by tapping and holding the number you want to dial and selecting **Dial** from the pop-up menu. For details on the Call Log screen, see “Call Log” (page 71).

Redialing

1. Tap **SEND** on the **VOICE** tab screen to call the last number dialed.

...  **Note** The redial function does not work when there has been a missed call.

Receiving a Call

Depending on the settings, an incoming call is alerted with an audible sound, a flashing indicator, or a vibrating alert.

1. To answer a call, tap the **SEND** button on the device or the screen. Tapping **CLR** or the Volume button can mute the ringer tone.

About Any-key Answer:

- When activated, Any-key Answer enables calls to be answered by tapping any button, other than the **END**, **CLR** or Volume buttons. This also includes the four program buttons on the front of the device.
- To set, in the **VOICE** tab screen, tap **Tools, Options**, and then scroll over to **Voice** at the bottom of the screen. For more information, see page 77.

About Caller ID:

If a call is received from a number stored in the Pocket Outlook® Contacts list, the name and number will be displayed. "Unknown" will be displayed if the caller is not on the Contacts list.

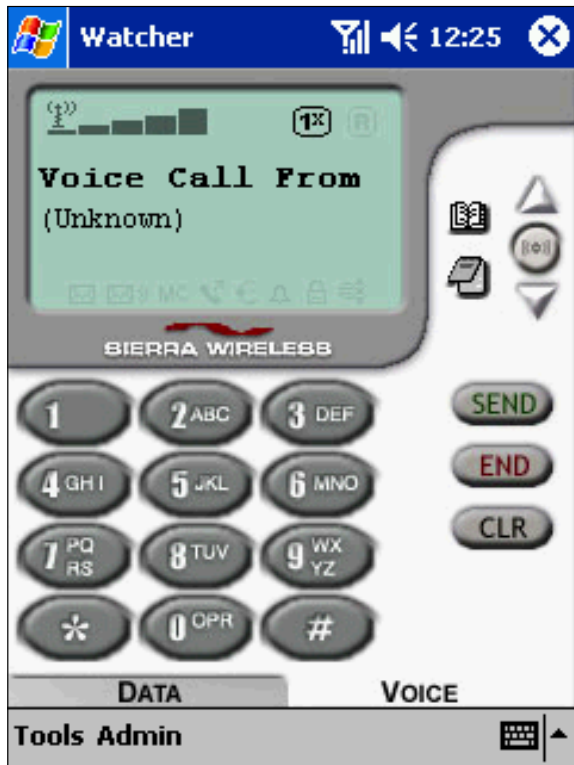

...  **Note** When **END** is tapped during an incoming call, it is rejected and the missed call icon **MC** appears.

Volume Control

Adjust the ringer volume by using the Speaker Icon on the navigation bar and the call volume (the speakerphone volume) by using the Volume buttons.

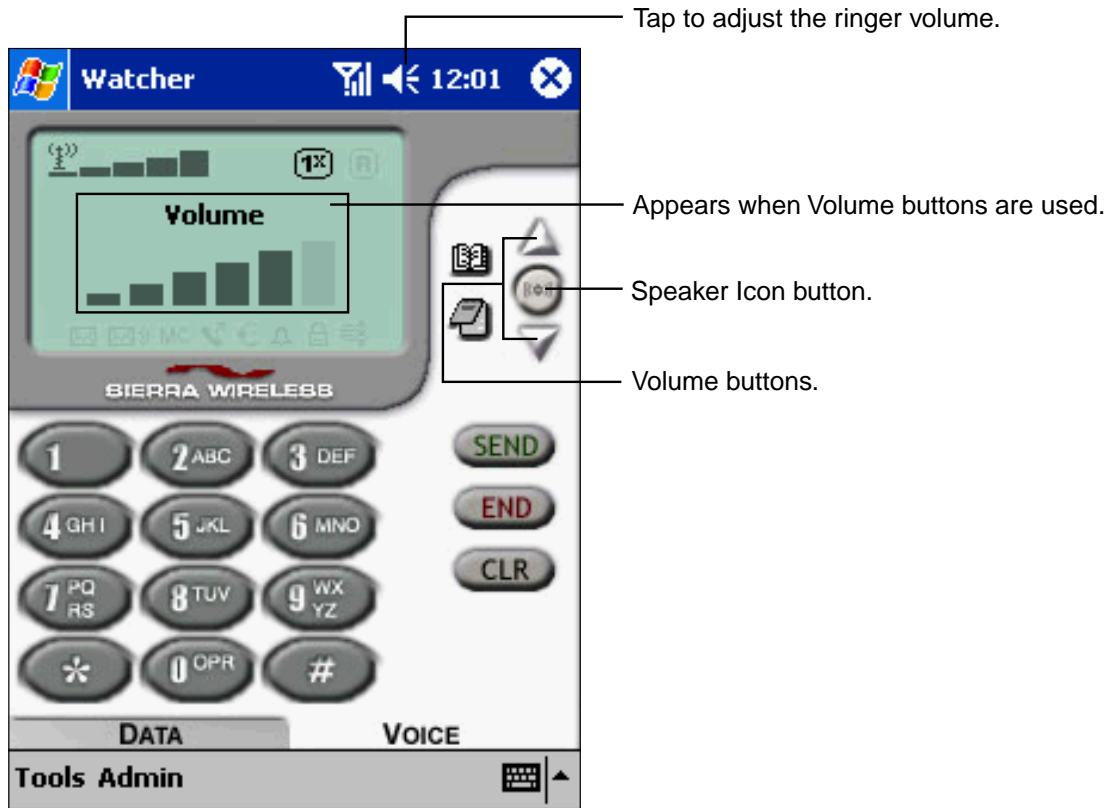

Speaker Icon button:

The ringer type changes each time you tap the Speaker Icon button.

The setting options in standby mode are "Ringer Only," "Ring and Vibe," "Vibrate Only," and "Silent Mode" (Ring and Vibe Off).

During a call, the setting switches between "Sound on" and "Mute".

Volume buttons:

When you tap the Volume buttons, a volume bar appears on the screen to indicate the call volume level (6 levels excluding Mute).

The call volume (the speakerphone volume) can be adjusted by tapping **Tools** on the **VOICE** tab screen, then **Options**, then **Sounds** at the bottom of the screen.

Call Waiting

When you're on the phone and another call is received, you hear a call waiting tone and "Call Alert From" appears on the display.

1. Tap **SEND** to put the original party on hold and switch to the new caller. When speaking to the new caller, the information for the first caller will not be displayed.
2. Tap **SEND** to switch to the original caller.

Call Forwarding

Call Forwarding transfers incoming calls to another phone number. Please contact your service provider about this feature.

Three-Way Calling

Three-Way Calling allows you to simultaneously talk to two callers at different phone numbers. Please contact your service provider about the availability of this feature.

1. When connected to one party, tap **SEND** and enter the second party's number, then tap **SEND** again.
2. When the second call is connected, tap **SEND** to talk to both callers.
3. Tap **END** to disconnect both parties.

Voice Mail

 appears on the display when you have new voice mail.

1. Tap .
2. On the confirmation dialog screen, tap **Yes**. The phone connects to your voice mailbox. The voice mailbox phone number can be set at the **Voice** tab in **Options**. For details, see page 77.

Digital Numeric Page

When Digital numeric page is received, "Numeric Page: XXX-XXXX" appears on the screen. XXX-XXXX is numerical.

The received "Digital numeric page" is saved as SMS in **Inbox**.

To call the number, tap **Messaging** on the **Tools** menu, then select the Digital numeric page, then tap **Call back Sender** on the **File** menu.

Missed Call

MC appears if you do not answer a call.

Tap **END** to turn off the missed call message.

Returning Missed Calls

To return the last missed call, tap **SEND**. When **MC** is tapped, the Call Log appears. This can be used to select a contact to call back. For details on the Call Log function, see page 71.

...  **Note** If the caller's number is not identified, you cannot call back.

Link Dialing

With Link Dialing you can place calls require multiple inputs in a sequence of continuous operations. It is set when storing phone numbers in the Contacts of Pocket Outlook®.

Link Dialing Storing

1. From the Today screen tap **New** then **Contact**.
2. Enter the phone number.
3. After the phone number, enter uppercase "L" or lowercase "l", then the next number.
4. To enter more numbers repeat step 3.
5. Once all the numbers are entered, tap **OK** then start Phone Book in Watcher.
6. Tap **Refresh** on the command bar. The set number is read into Phone Book, and calls can now be placed from there using Link Dialing.

Example: 604-323-**** L 9837*** l 9832**

Emergency Dialing

Emergency calls can be placed - even if the phone is not registered or activated, or KeyGuard is activated -- as long as the power is on and there is a signal.

1. Enter "911" from the dial pad and tap **SEND**.
2. Tap **END** to end the call.

...  **Note** If an emergency number is stored in Speed Dial you will be able to dial it by pressing a single key. However, speed dial will not work if KeyGuard is enabled.

The emergency call number varies from region to region.

Phone Book

The Phone Book screen, which displays the names and numbers stored in Contacts, can be used to place calls. Numbers added to Contacts can easily be transferred to the Phone Book.

To display the Phone Book, go to the **VOICE** tab screen, and tap , or tap **Phone Book** on the **Tools** menu. To dial, tap the contact you wish to call, and tap **Dial**.

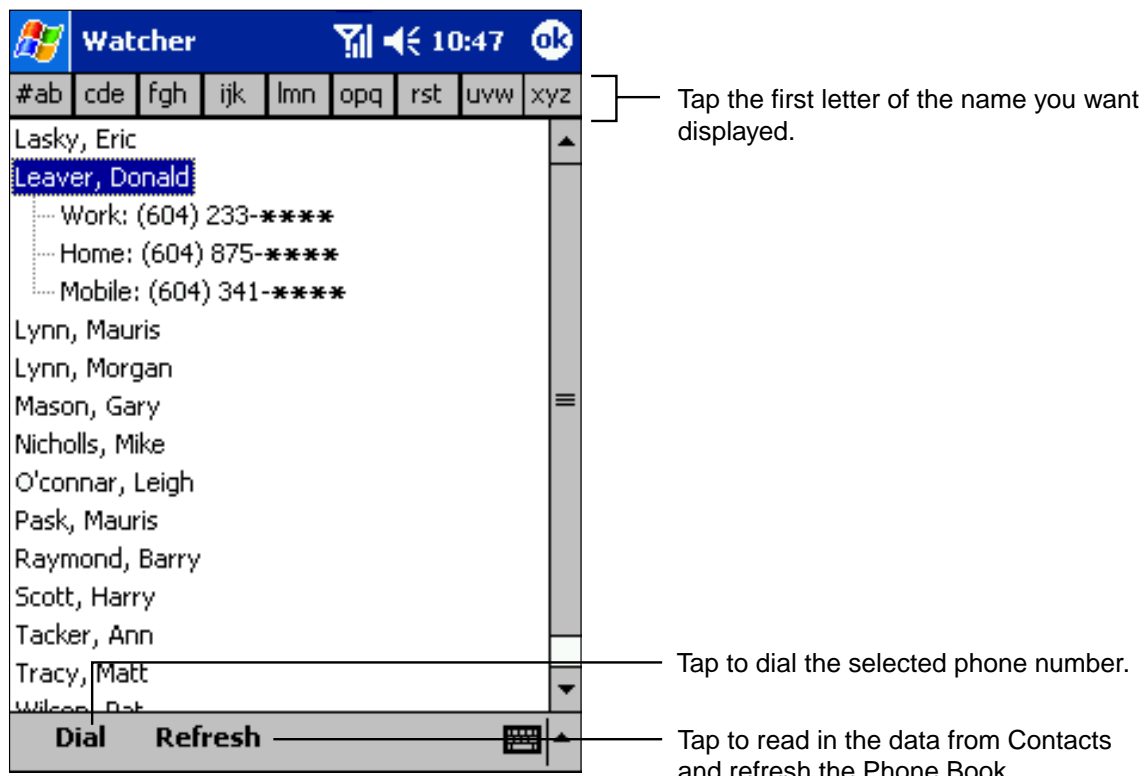

...  **Note** Names and phone numbers cannot be added directly to the Phone Book screen. They must be entered in Contacts first.

KeyGuard Lock

This function guards against accidentally inputting numbers or pressing unwanted keys. To enable from the **VOICE** tab screen:

1. Tap **Tools**, then **KeyGuard**. “KeyGuard enabled” appears on the screen.
2. Repeat the same process to turn KeyGuard off.

...  **Note** When KeyGuard is enabled, the only functions that can be performed are selecting the **Tools/Admin** menus, placing emergency calls, receiving incoming calls (by tapping **SEND**), and turning the KeyGuard mode off.

Scratch Pad

The Scratch Pad allows you to take notes while on the phone. To access, tap .

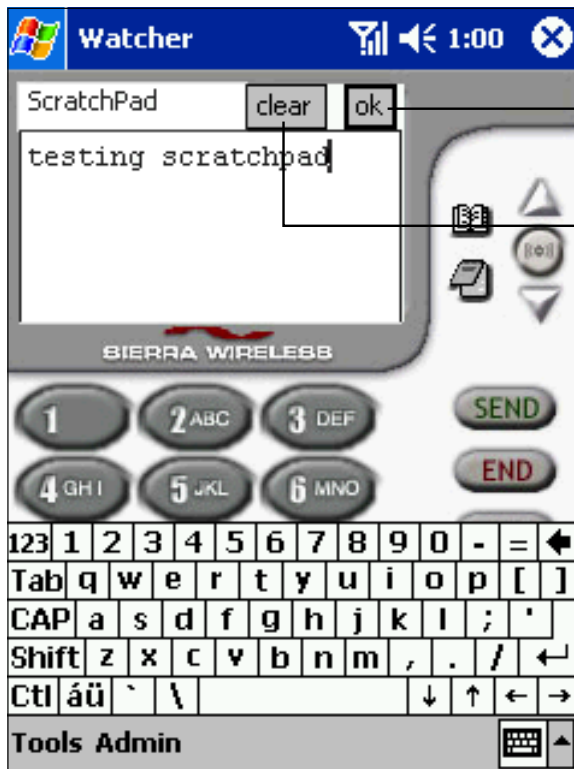

Tap to close Scratch pad.
Contents will remain even when device is shut down.

Tap to delete all notes.

Speed Dial

Using speed dial simplifies calling.

Storing

1. To access speed dial list, tap **Speed Dial** on the **Tools** menu or press left on the navigation button.
2. Tap the area next to the dial pad number where you want to store a phone number, and the Phone Book screen appears.
3. Select the contact you want to store, then tap **Add** on the command bar.
4. Tap **OK**.

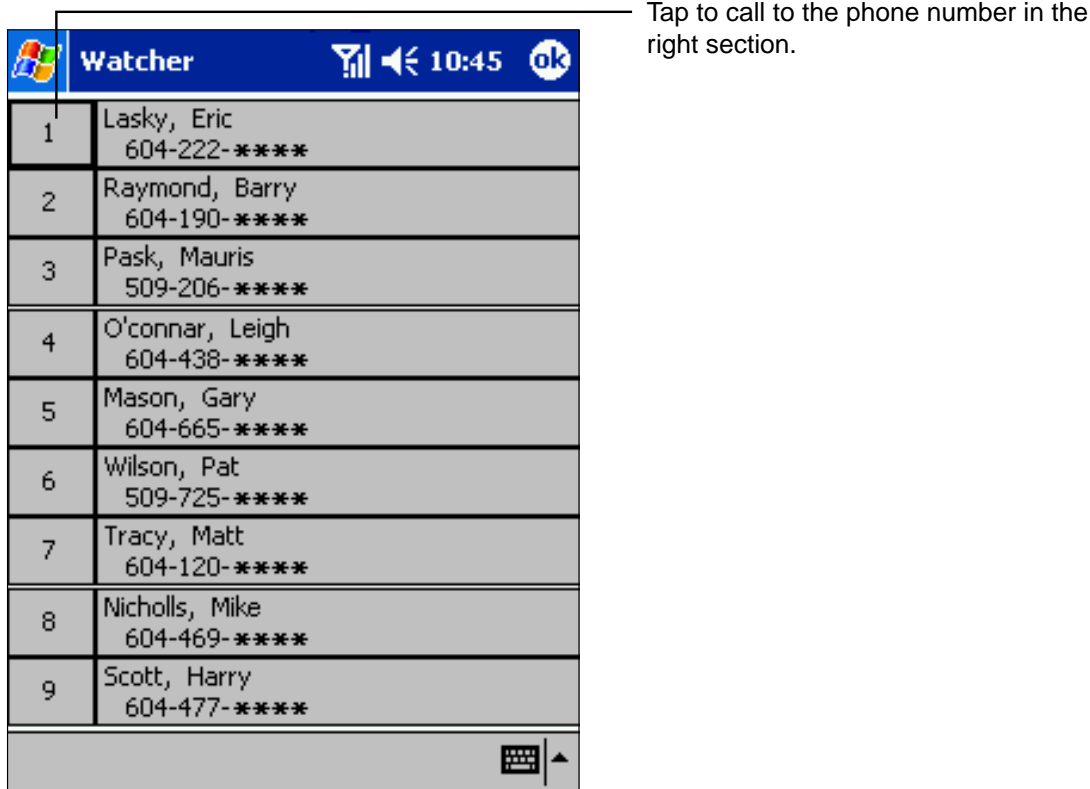

Clearing

1. Tap **Speed Dial** on the **Tools** menu or press left on the navigation button. The phone number section storing dial pad number appears.
2. Tap and hold the entry you want cleared.
3. When the pop-up menu appears, tap **Clear Speed Dial Entry**. “<Unassigned>” appears in the location.
4. Tap **OK**.

Call Log

Call Log screen displays a list of incoming, outgoing and missed calls, including caller information and call time. To display, tap **Call Log** on the **Tools** menu or press right on the navigation button.

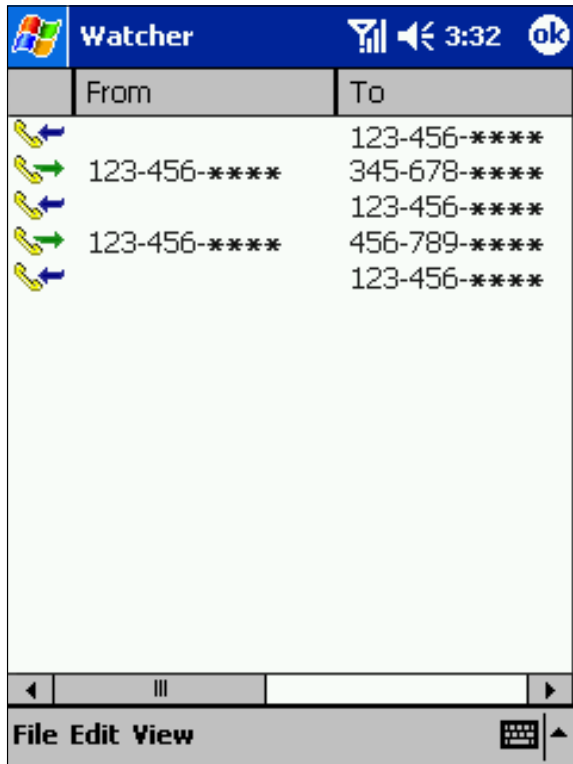

When you tap and hold a log entry a pop-up menu displaying **Delete**, **Copy Phone Number** and **Dial**.

Adding Telephone Numbers From the Log

1. Tap and hold the contact name, when pop-up menu appears tap **Copy Phone Number**.
2. Tap **Contacts** and **New**.
3. Using the **Edit** menu at the bottom of screen and paste the copied number into the phone number section.

... **Note** Numbers marked "Unknown" in the call log cannot be called or stored in Contacts.

Storing Call Log As a Text File

1. Tap **Save As** on the **File** menu.
2. Name the text file on the Save As screen.
3. Tap **OK**.

Options (Preferences)

Tap **Options** on the **Tools** menu to display the Options setting screen. A number of settings (Security, Sounds, etc.) can be made at this screen.

General

The screenshot shows the 'Options' screen with the following settings and annotations:

- Data-Call Inactivity Timeout: Disconnect**: after 5 min. (Sets number of minutes a line is disconnected after data communication ends. (**Display** tab of **Options** can be set to display warning before line is disconnected.)
- Incoming Calls: Answer**: all calls as Voice. (Select the mode for answering incoming calls.)
- Call Logging: Retain**: last 100 calls. (Select the number of calls to be retained in the Call Log. Calls exceeding this number are automatically deleted.)
- Active NAM Profile**: NAM 1 - (not used). (When contracting with two NAMs (Number Assignment Modules), you can select to use either of the NAMs.)
- System Select**: Automatic. (System selection is possible in an area that permits roaming. Automatic A: Scans the Priority system, if not found, scans the A-system. Automatic B: Scans the Priority system, if not found, scans the B-system. Home Only: Permits only home service. Automatic: Permits roaming if the home service is not found.)
- Update System Clock with CDMA time during start-up. (When checked, CDMA network updates the time when Watcher is launched.)
- TTY Mode. (Check when connecting teletypewriter, etc. to the headphone jack.)

At the bottom of the screen are three buttons:

- Cancel**: Tap to return to the previous screen without storing the settings.
- Restore**: Tap to restore all the settings to the defaults.
- Save**: Tap to save the new settings.

The operations for **Cancel**, **Restore** and **Save** are common for each tab screen.

Display

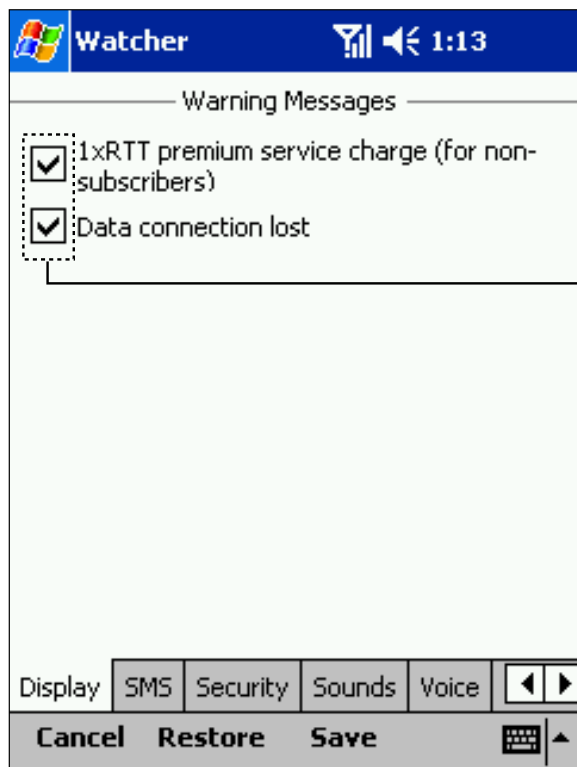

Check to display the Warning Message while meeting the conditions on the right part.

Messaging

Sets options for short message services.

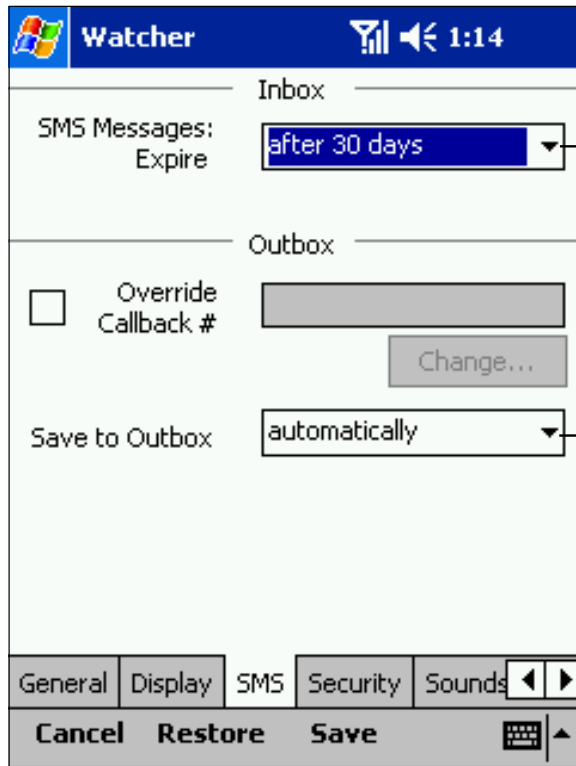

Sets messages expiration dates.

Check here then tap **Change** to display the Callback entry screen. Enter the phone number you want displayed as a callback number when a message is sent.

Sets Outbox storage preference.

Security

Use **Security** tab to lock the modem or change the password.

When the modem is locked, most menu functions (**Options**, **Messaging**, **Call Log** etc.) cannot be used. (The **Unlock Modem** menu can be selected.)

Also, no calls other than emergency calls can be placed, and when a call is received, the caller's phone number is displayed "***".

The default of the lock code is the last four digits of the device's phone number, if the phone is activated.

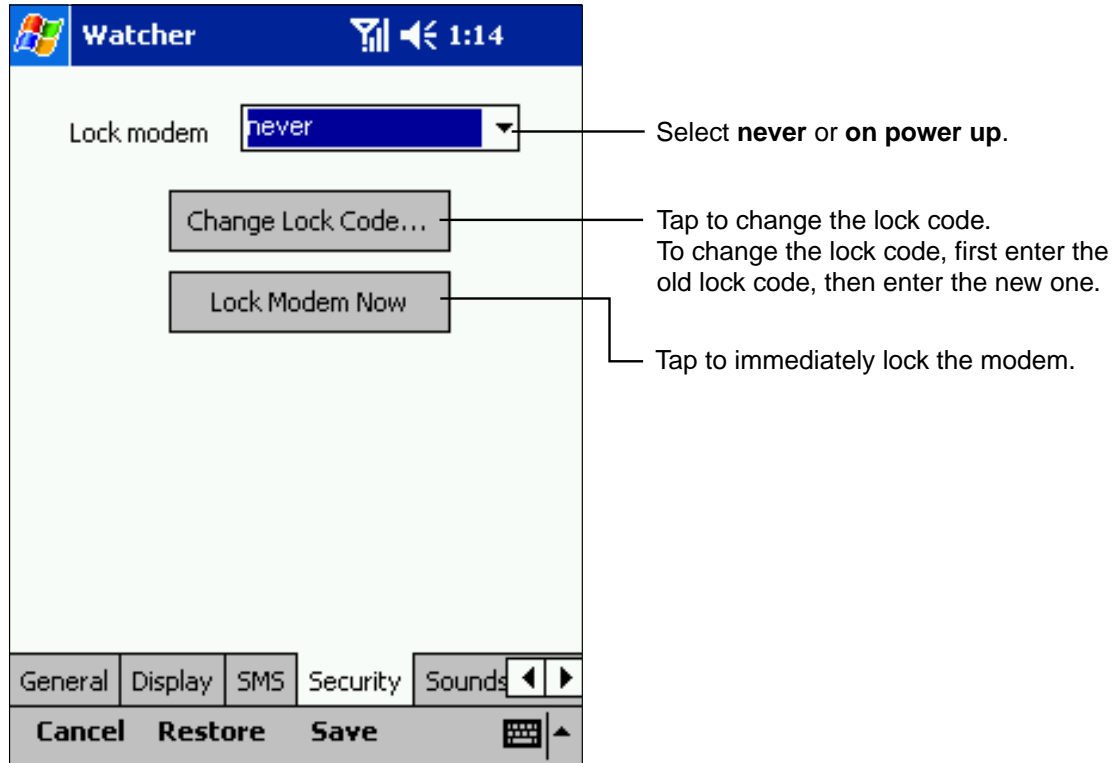

Sounds

Use to select the sounds for incoming calls, voice mail and SMS messages.

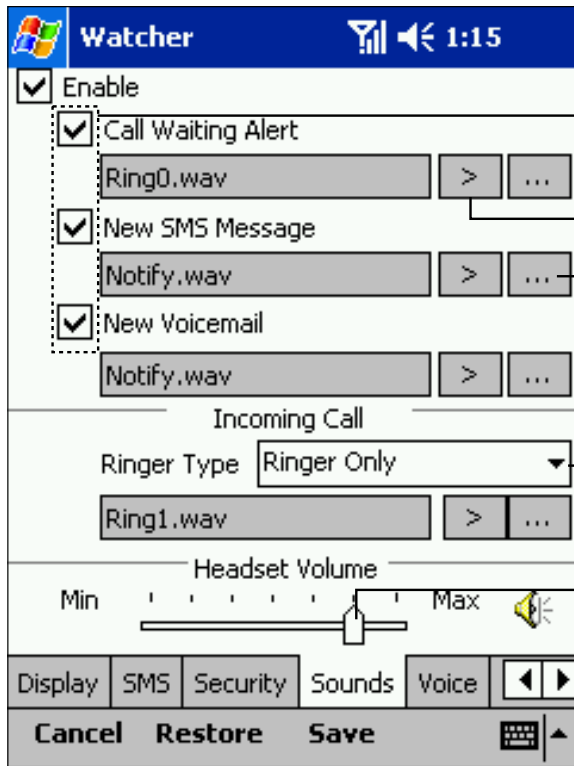

When a box is checked that alert will sound.

Tap ">" to play selected sound.

Tap "..." to select a sound file.

Select a receiving type from "Ringer Only", "Ring and Vibe", "Vibrate Only" and "Ring and Vibe Off" in the "Incoming Call" section. You can also select a receiving type with the Speaker Icon button on the **VOICE** tab screen.

Adjust the volume of the conversation. The volume can also be changed at the **VOICE** tab.

Voice

Determines when auto-answer function answers phone. Ideal to use while driving.

Determines when to retry a call that did not connect.

When checked, automatically adds hyphenation when phone numbers are entered on dial pad.

When this is checked, incoming calls can be answered by pressing any key other than **END**, **CLR** and the Volume button. This function does not work in the KeyGuard mode.

Sets the dial pad tone length.

When checked, tone is not sounded.

When checked, tone sounds every minute during phone calls.

When this is checked, a tone is sounded when calls are interrupted, when the service area switches from home to roaming, etc.

Enter the phone number, then tap **Change** to set the number for checking your voice mail.

SMS (Messaging)







Contact your service provider before using this function.

Tap **Messaging** on the **Tools** menu to display the SMS message screen.

 appears on the display when you receive a message, flashing if it is high priority.

Tap this indicator to open the SMS screen.

The following is a list of the icons displayed with the SMS function.

Icon	Meaning
	High priority message.
	Saved, unsent message in the Outbox .
	Error occurred during transmission and message not sent.
	Transmission to network is complete.
	Mail recipient received message.
	Messages marked with this check will be deleted when Delete is selected from the Edit menu.

Inbox

Received messages are stored in the **Inbox**.

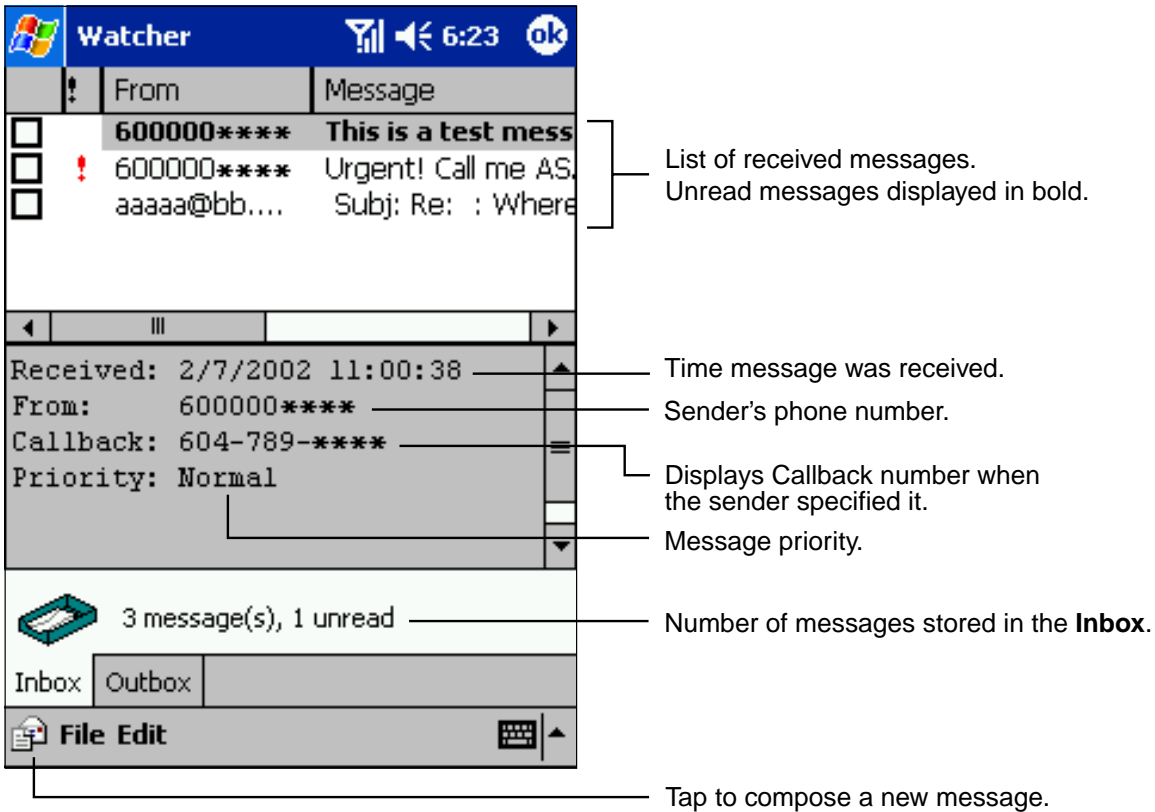

The following options can be selected through the **File** menu:

New Message: Create a new message

Forward Message: Forwards message to another party

Reply to Sender: Reply to sender with the sending number already entered.

Call back Sender: Calls the sender back.

The following options can be selected through the **Edit** menu.

Delete: Deletes checked messages

Delete All: Deletes all messages in box, regardless of whether or not they are checked.

Outbox

Sent and unsent messages are stored in the **Outbox**.

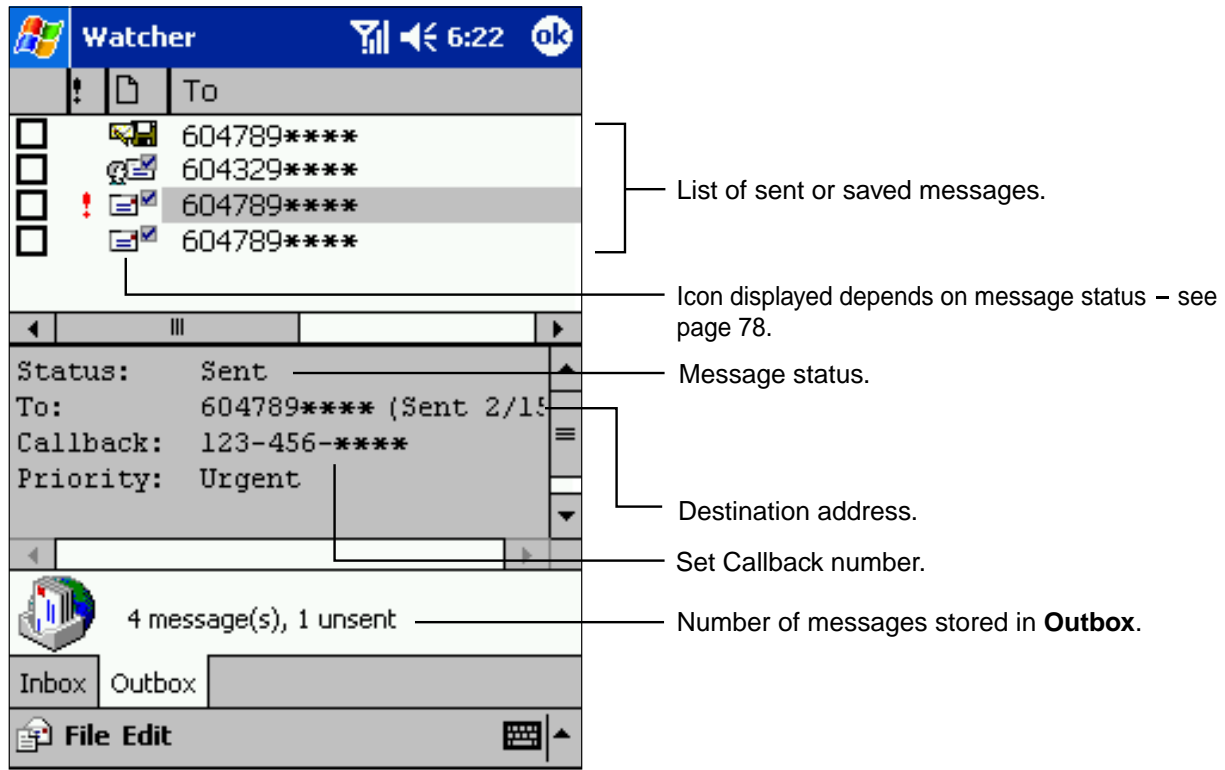

The following options can be selected from the **File** menu.

Edit Message: Edits stored messages - overwriting previous message.

New Message: Create a new message

The following options can be selected through the **Edit** menu.

Delete: Deletes checked messages

Delete All: Deletes all messages in box, regardless of whether or not they are checked.

Composing New Messages

1. At the Messaging screen, tap  on the command bar.
2. Enter the recipient's phone number or address with the input panel or by accessing the Phone Book by tapping **To**. (See the following page.)
3. Select **Normal** or **Urgent** for Priority.
4. Enter the message and press **Send**. If the message is successfully transmitted, the screen automatically closes.

...  **Note** Selecting **Send** from the **File** menu also sends messages.

To store sent messages in the **Outbox** see the **SMS** tab in **Options**. This function must be set if you want to check whether or not the recipient received the message.

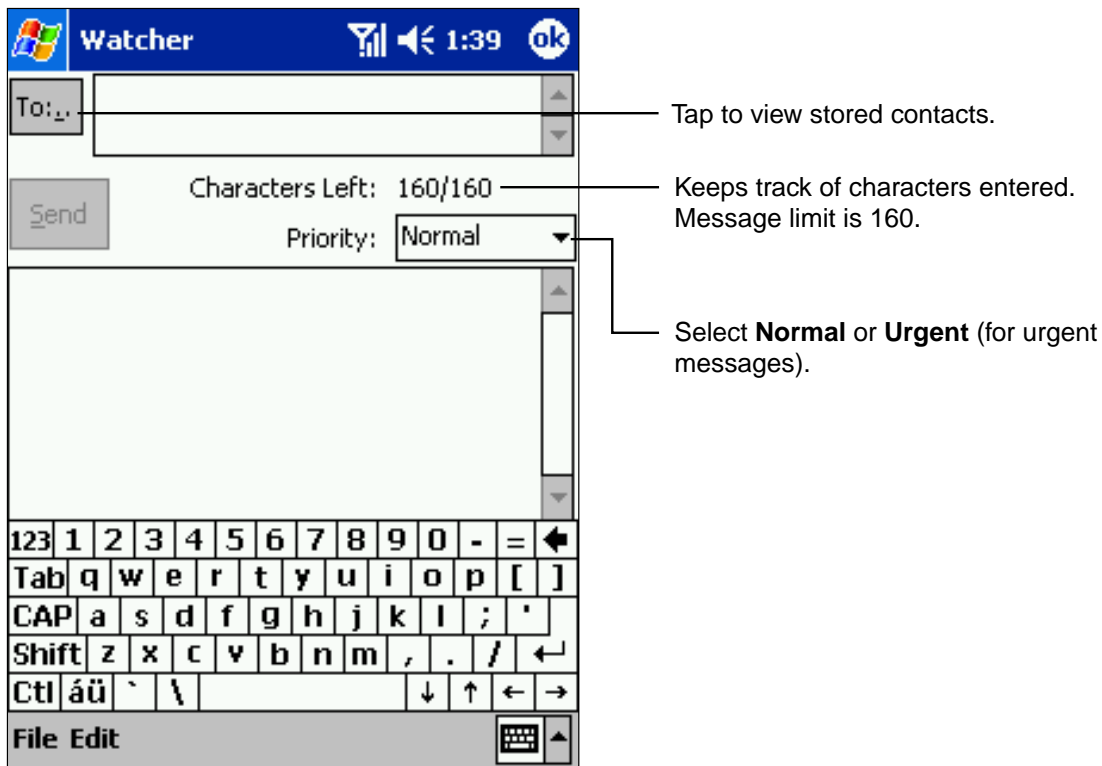

The following options can be selected from the **File** menu.

Send: Sends message.

Save: Saves message to **Outbox** without sending it. To send the message, select it in the **Outbox**, tap **Edit Message** from the **File** menu, then tap **Send**.

Tap **OK** to stop operations. Select **Yes** when the save message appears to store the message, and **No** not to save it.

Selecting recipients:

1. On the message screen, tap **To**.
2. Select the recipient from the list, then tap **Add**. Recipients can also be selected by continually double tapping the phone number or address.
3. After selecting recipients, tap **OK**.

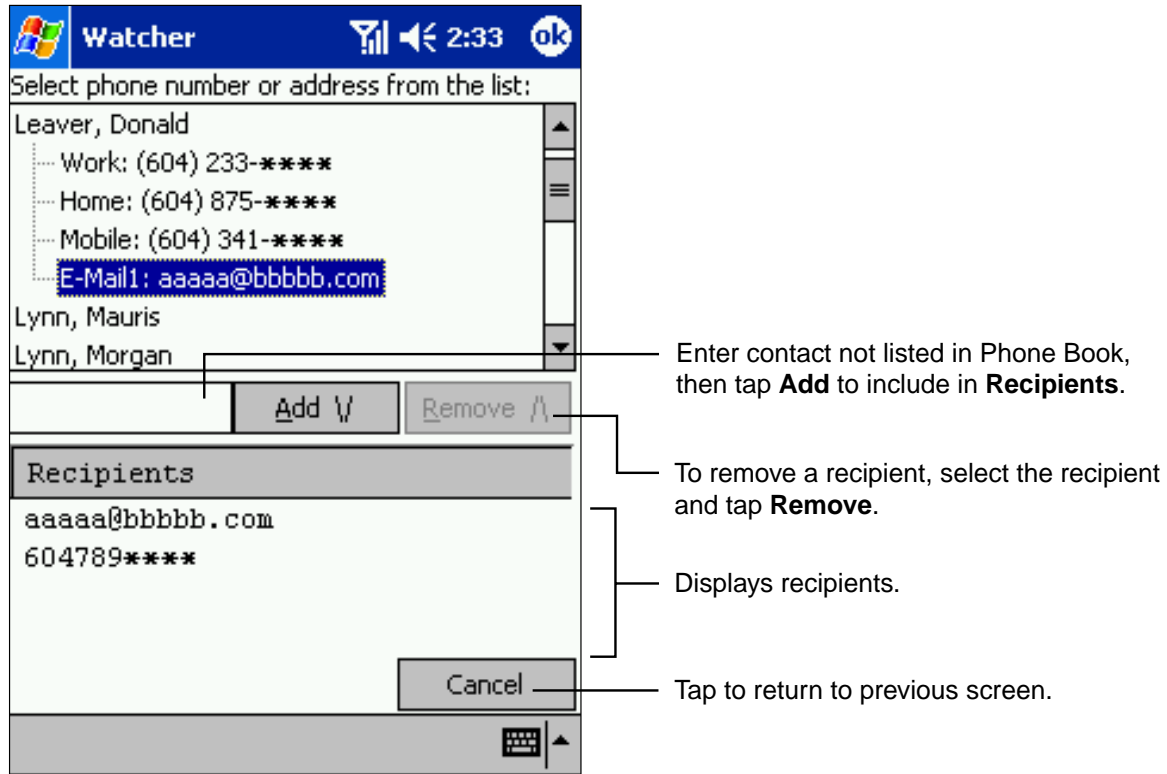

Sending messages to multiple recipients:

Add multiple recipients by repeating steps outlined above. If not using names from the Phone Book list, enter a “,” or “;” after each number.

For example: 98701****; 98712****;

Accessing the Internet

Access the Internet by selecting **Circuit Switch Data** or **High Speed Data** from the **DATA** tab or by using an ISP.

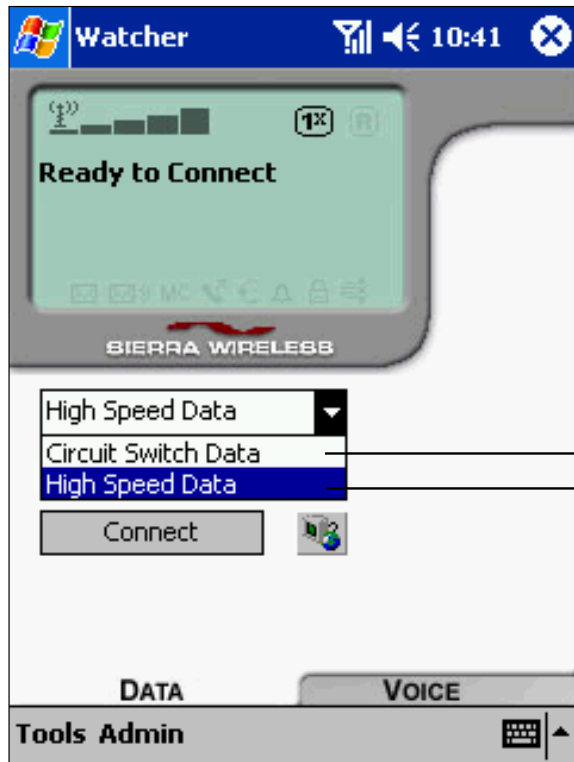

High-speed packet service.
Connection service allowing smooth connection to the Internet.

1. Tap the pull-down list and select the desired connection name.
2. Tap **Connect** to access the Internet.

Using Subscribed Internet Service Provider (ISP):

1. Tap **Dial-Up Manager** on the **Tools** menu. The Connections setting screen appears.

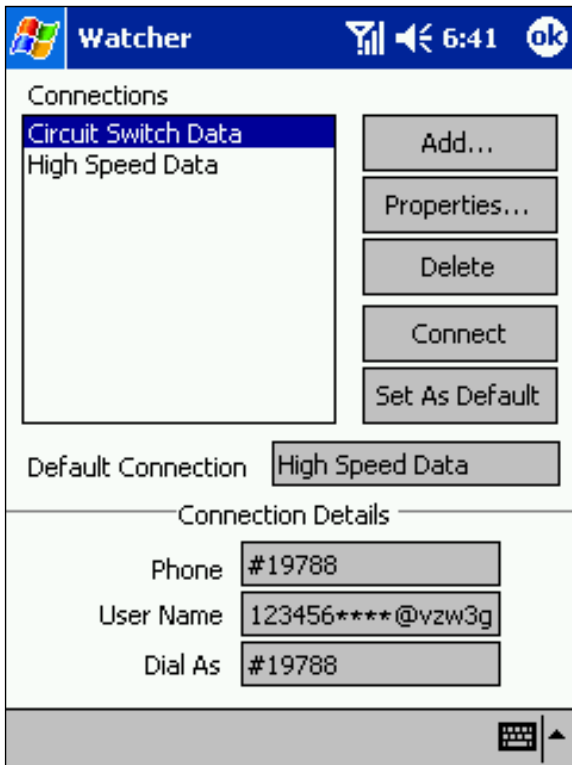

2. Tap **Add**.
3. Enter the required information.

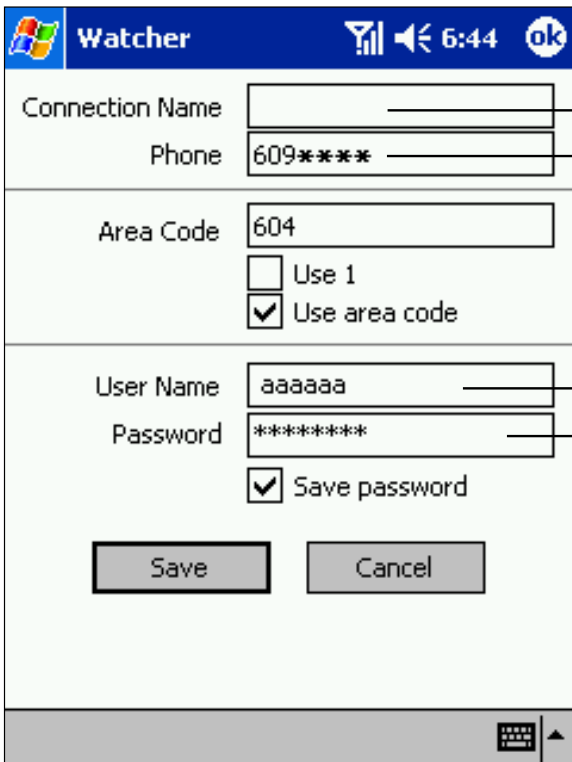

Enter the connection name. (Example: ISP name)

Enter the connection number.

Enter the connection user name specified by the ISP.

Enter the connection password.

4. Tap **Save**. The settings are now stored and can be accessed.

...  **Note** After establishing the dial-up setting using the Sierra Wireless SB555 Modem by setting **Connection of Settings**, if you restart Watcher with Radio Standby Switch, you can also use the connection setting from the **DATA** tab screen. For more information on setting **Connection of Settings**, see “Connecting to the Internet” in Chapter 8.

After the setting is entered, you can access your subscribed ISP. Tap **Connect** from the **DATA** tab screen to connect to the Internet, once connected, you can:

- Send and receive e-mail messages by using Inbox. Before you can use Inbox, you need to provide the information it needs to communicate with the e-mail server. For specific instructions, see “Connecting Directly to an E-mail Server,” in Chapter 8.
- Visit Web and WAP pages by using Pocket Internet Explorer. For more information, see Chapter 7.
- Send and receive instant messages with MSN® Messenger. For more information, see “MSN® Messenger,” in Chapter 6.

Chapter 4

Microsoft® ActiveSync®

Microsoft® ActiveSync® synchronizes the information on your computer with the information on your device. Synchronization compares data between the two and updates both with the most recent information. For example:

- Keep Pocket Outlook® data up-to-date by synchronizing your device with your computer's Microsoft® Outlook®.
- Synchronize Microsoft® Word and Microsoft® Excel files between the two. Files will be automatically converted to the correct format.

...  **Note** Use ActiveSync® options to select which types of information to be synchronized.

With ActiveSync®, you can also:

- Back up and restore your device data.
- Copy (rather than synchronize) files between your device and computer.
- Control when synchronization occurs by selecting a synchronization mode. For example, you can synchronize continually while connected to your computer or only when you choose the synchronize command.
- Select which information types are synchronized and control how much data is synchronized. For example, you can choose how many weeks of past appointments you want synchronized.

Before you begin synchronization, install ActiveSync® on your computer from the Companion CD. For more information on installing ActiveSync®, see your Quick Start Card. ActiveSync® is already installed on your device.

After installation is complete, the ActiveSync® Setup Wizard will:

1. Help connect your device to your computer.
2. Set up a partnership to synchronize information between the two devices.
3. Customize the synchronization settings.

Synchronization automatically begins when you finish using the Wizard. After this initial synchronization, view your device's Calendar, Contacts and Tasks. Everything stored in Microsoft® Outlook® on your computer should now be on your device. Disconnect the device from your computer and you're ready to go.

To initiate ActiveSync® on your device, tap , and then tap **ActiveSync**.

For information about using ActiveSync® on your computer, see ActiveSync® Help in the ActiveSync® program.

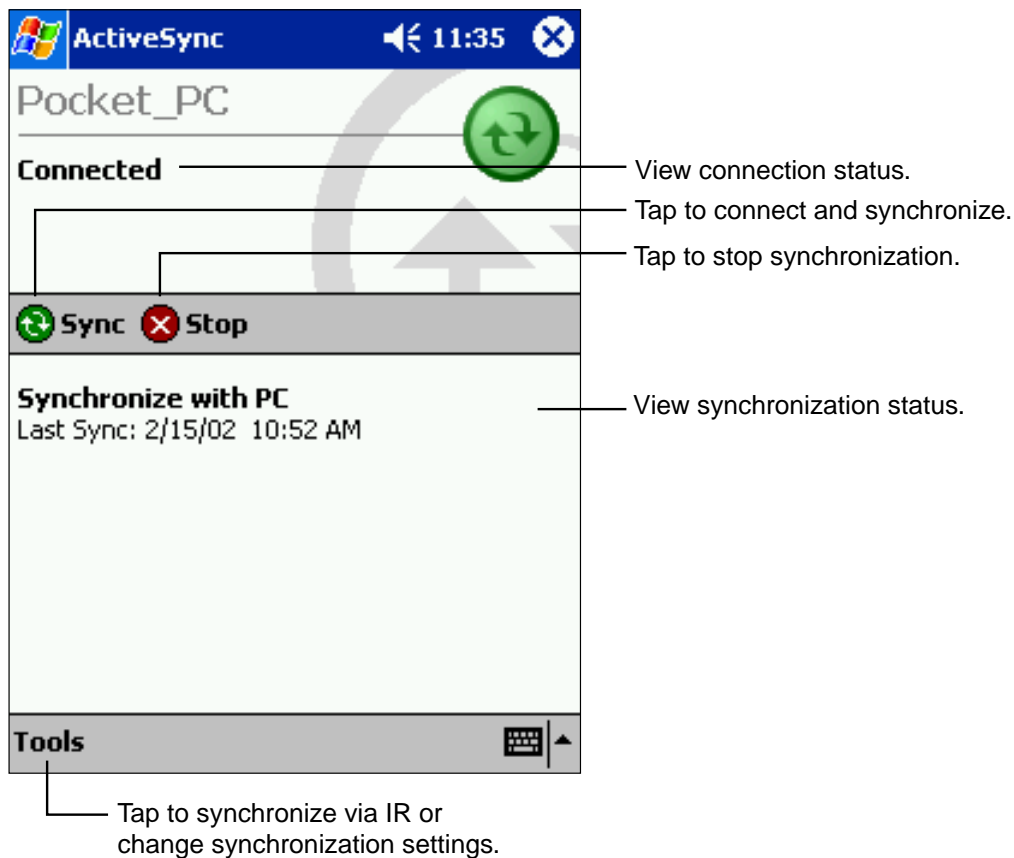

For more information about ActiveSync® on your device, switch to ActiveSync®, tap , then tap **Help**.

Chapter 5

Microsoft® Pocket Outlook®

Microsoft® Pocket Outlook® includes Calendars, Contacts, Tasks, Inbox and Notes which can be used individually or together. For example, e-mail addresses stored in Contacts can be used to address e-mail messages in Inbox.

ActiveSync® synchronizes information in Microsoft® Outlook® or Microsoft® Exchange on your computer with your device, comparing changes made on both and updating each of them with the latest information. For information on using ActiveSync®, see ActiveSync® Help on the computer.

Calendar: Scheduling Appointments and Meetings

Use Calendar to schedule appointments, including meetings and other events. You can check your appointments in one of several views (Agenda, Day, Week, Month, and Year) and easily switch views by tapping one of the 5 view icons at the bottom of the screen or by pressing the Calendar Program (button#1 on front of your device).

To access the Calendar, tap , then **Calendar**. Or, press the Calendar Program button on the front of the device.

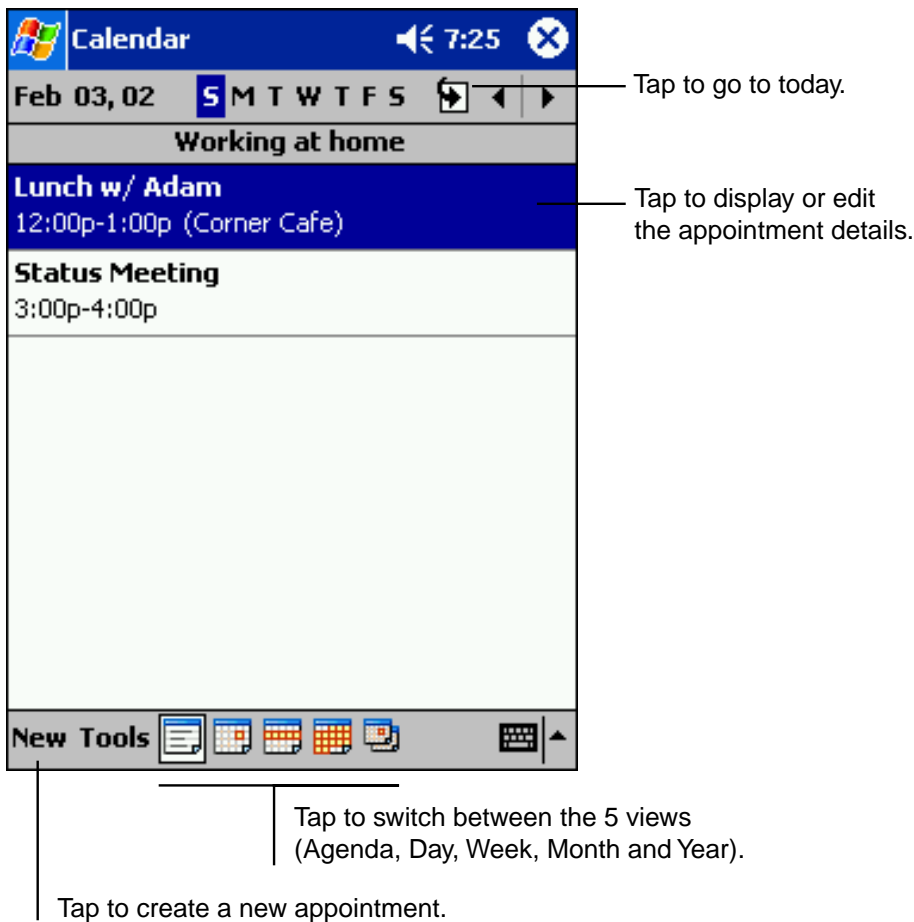

...  **Note** Tap **Options** on the **Tools** menu to customize the Calendar display.



Creating an appointment:

If you are in Day or Week view, tap the desired date and time for the appointment.

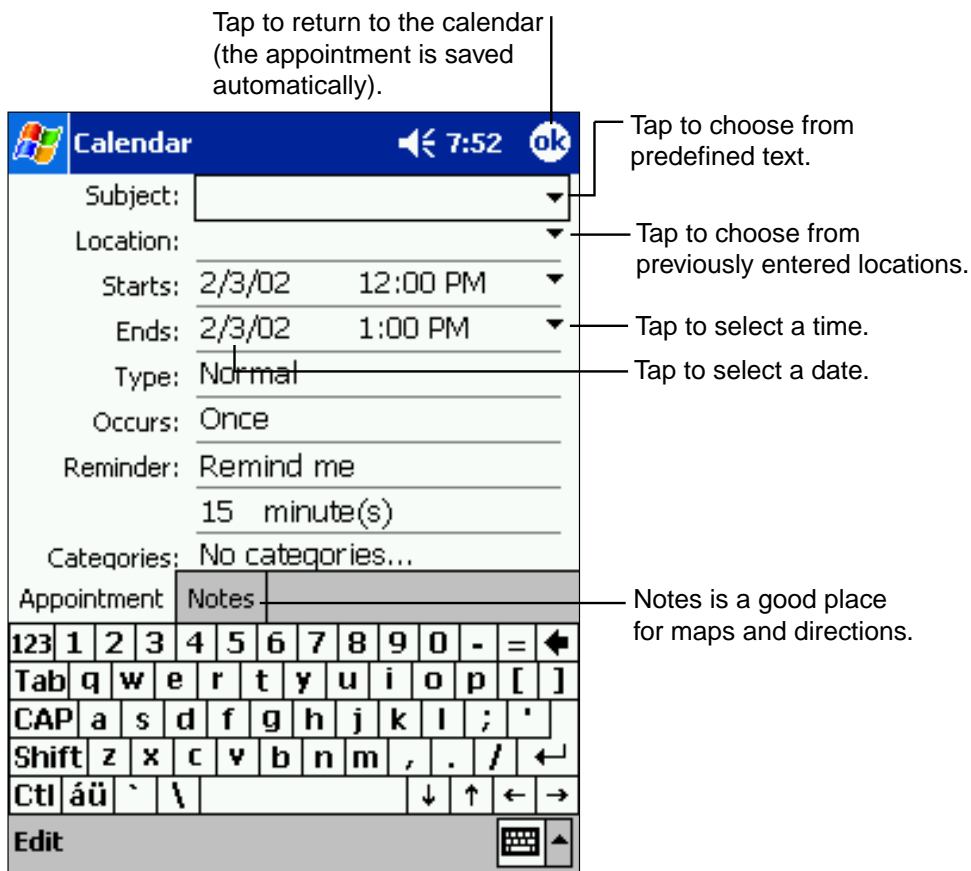
1. Tap **New**.



2. Enter a description and location.
3. Adjust date and time as needed.
4. Enter other desired information. Hide the input panel to view all available fields.
5. Tap the **Notes** tab to add notes or a drawing, or to create a recording. For more information see "Notes: Capturing Thoughts and Ideas" later in this chapter.
6. Tap **OK** when finished.

...  **Note** If you select **Remind me** in an appointment, your device will remind you according to the options set in the  menu, **Settings, Personal tab, Sounds & Notifications**.

Using the Summary Screen

Tap an appointment to display the summary screen. To make changes, tap **Edit**.

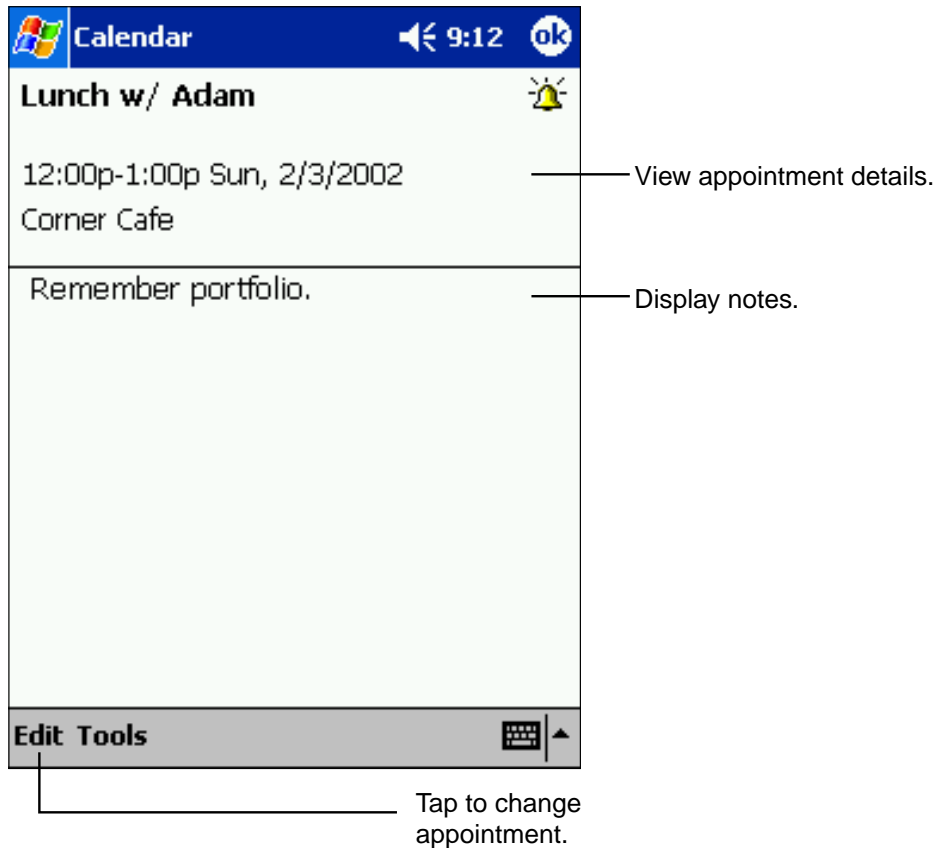

Creating Meeting Requests

Calendar can set up meetings with Outlook® or Pocket Outlook® users. The meeting request will be created automatically and sent either when you synchronize Inbox or when you connect to your e-mail server. Indicate how you want meeting requests sent by tapping **Tools** then **Options**. If you send and receive e-mail messages through ActiveSync®, select **ActiveSync**.

To schedule a meeting:

1. Create an appointment.
2. In the appointment details, hide the input panel, then tap **Attendees**.
3. Select the meeting attendees from your Contacts list. Tap **OK**.

The meeting notice is created automatically and placed in the Outbox folder.

For more information on sending and receiving meeting requests, see Calendar Help and Inbox Help on the device.

Contacts: Tracking Friends and Colleagues

Contacts maintains an easily accessible list of friends and colleagues (See note below). The device's infrared (IR) port allows you to quickly share Contacts information with other device users. To access Contacts, tap , then **Contacts**. Or, press the Contacts Program button on the front of the device.

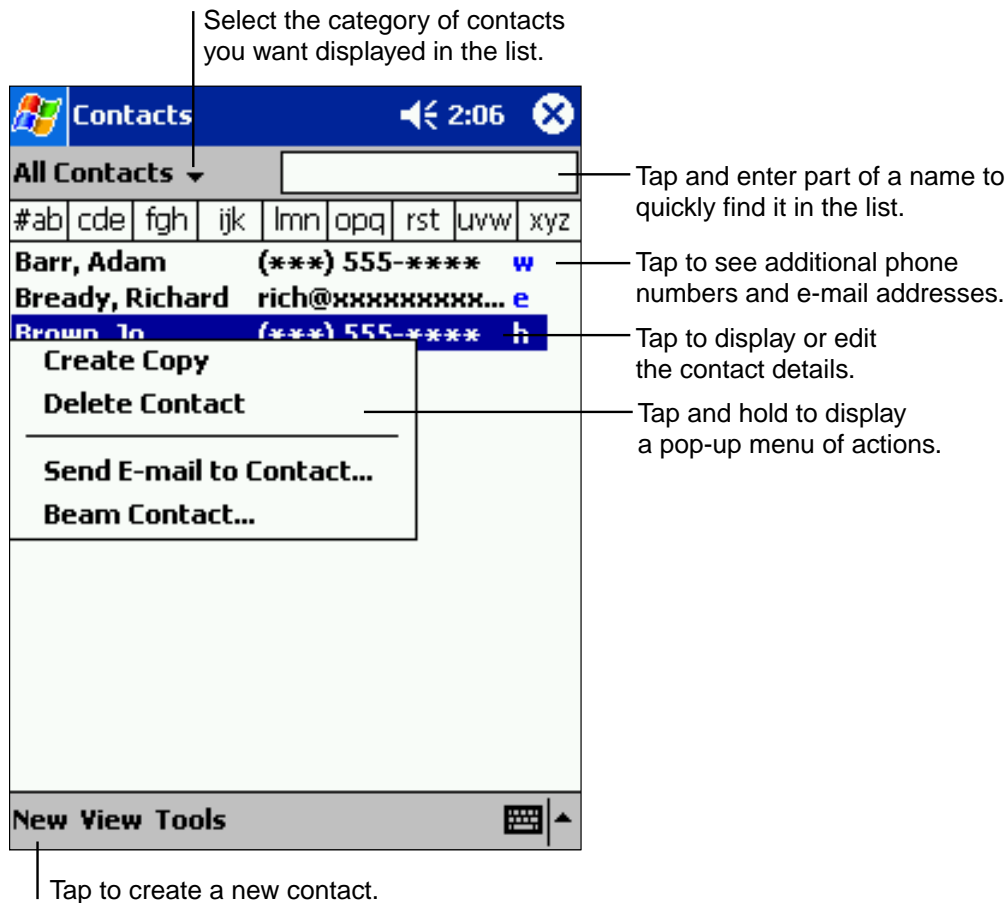

...  **Note** Tap **Tools** then **Options** to change the way information is displayed.

All phone numbers stored in **Contacts** can be accessed from the Phone Book to place a call.

When transferring the contact to another device by using infrared (IR), tap and hold that contact, then tap the **Beam Contact** from the displayed pop-up menu. For more information, See "Transferring Items Using Infrared" in chapter 8.

Creating a contact:

1. Tap **New**.

Tap to return to the contact list (the contact is saved automatically).

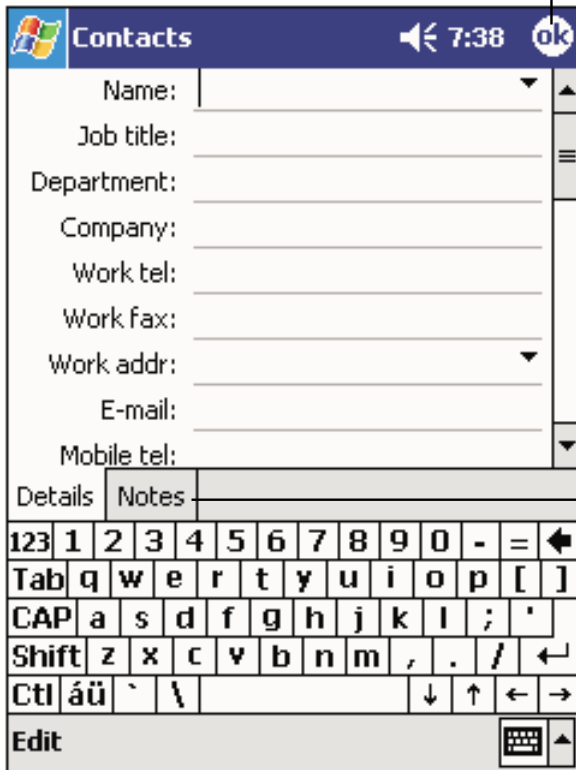

Scroll to see more fields.

Notes is a good place for maps and directions.

2. Enter name and contact information. Scroll down to see all available fields.
3. Tap **Categories** to assign the contact to a category. In the list, Contacts can be displayed by category.
4. Tap the **Notes** tab to add notes or a drawing, or to create a recording. For more information, see “Notes: Capturing Thoughts and Ideas” later in this chapter.
5. Tap **OK** when finished.

Finding a contact

There are four ways to find a contact from the contact list:

- Enter a name in the box under the navigation bar. To view all contacts, clear text from the box or tap the button to the right of the box.
- Tap the category list (labeled **All Contacts** by default) and select the type of contact you want displayed. To view unassigned contacts, select **No Categories**. Select **All Contacts** to view the entire contacts list.
- To view contacts by their company names, tap **View**, then **By Company**. The number of contacts working for that company will be displayed to the right of the company name.
- Tap , **Find**, enter the contact name, select **Contacts** for the type, then tap **Go**.

Using the Summary Screen

Tap a contact to display the summary screen. To make changes, tap **Edit**.

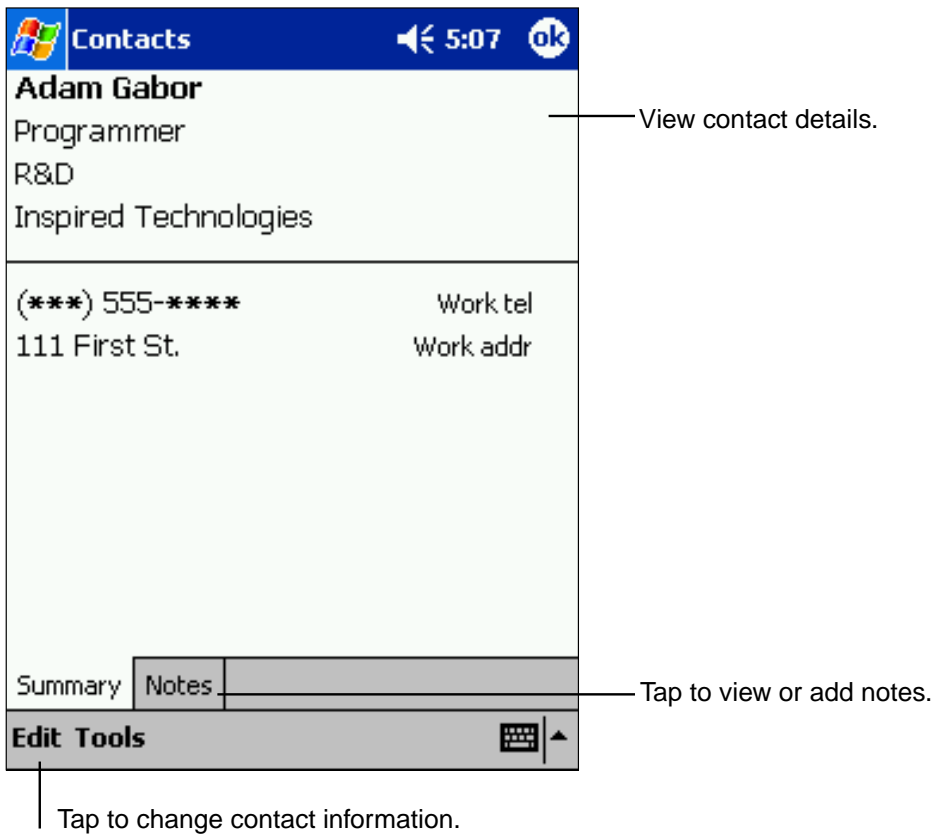

Tasks: Keeping a To Do List

Tasks keeps track of what has to be done. To access, tap , then **Tasks**. Or, press the Tasks Program button on the front of the device.

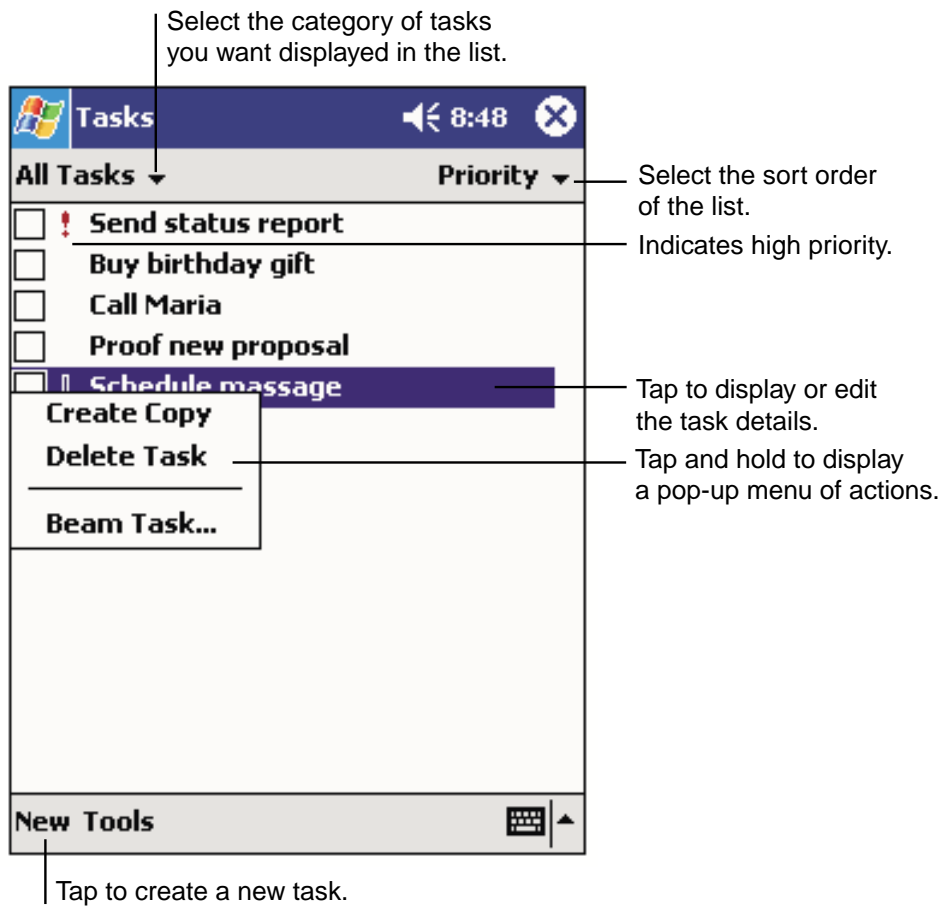

...  **Note** Tap **Tools** then **Options** to change the way information is displayed.

Creating a task:

1. Tap **New**.

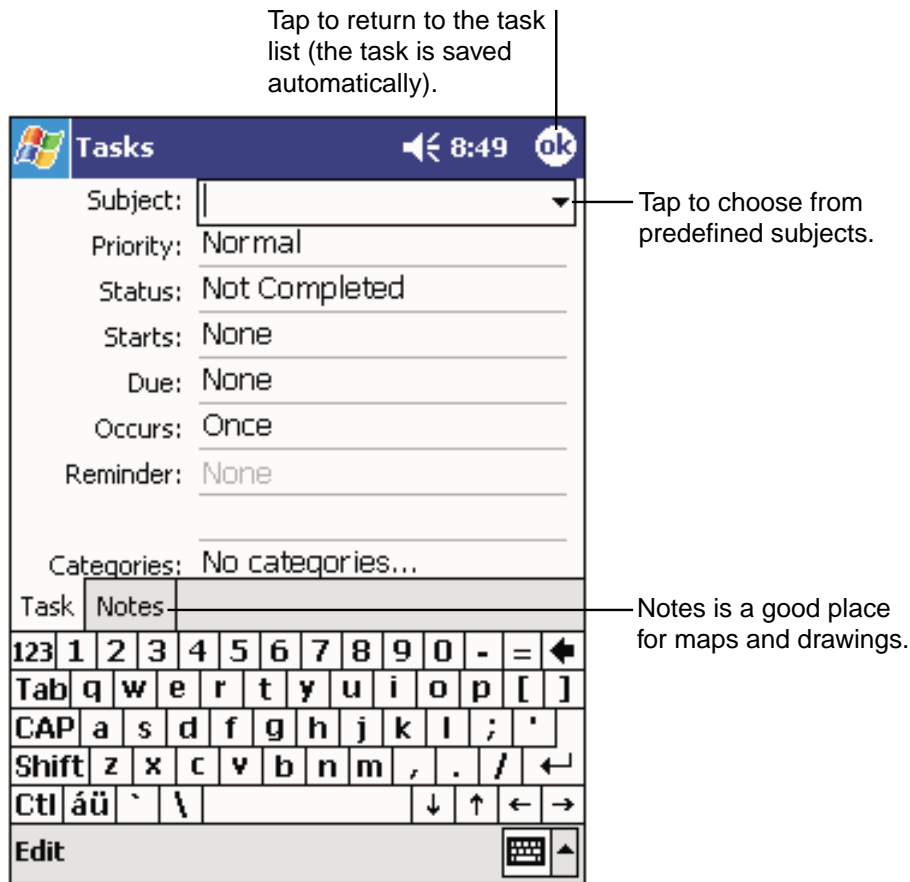

2. Enter a description.
3. Enter a start and due date or other information by tapping the field. To see all available fields, hide the input panel.
4. Tap **Categories** to assign the task a category. In the list, Tasks can be displayed by category.
5. Tap the **Notes** tab to add notes or a drawing, or to create a recording. For more information, see “Notes: Capturing Thoughts and Ideas” later in this chapter.
6. Tap **OK** when finished.

...  **Note** To quickly create a task with only a subject, tap **Entry Bar** on the **Tools** menu. Then, tap **Tap here to add a new task** and enter your task information.

Using the Summary Screen

Tap a task to display the summary screen. To make changes, tap **Edit**.

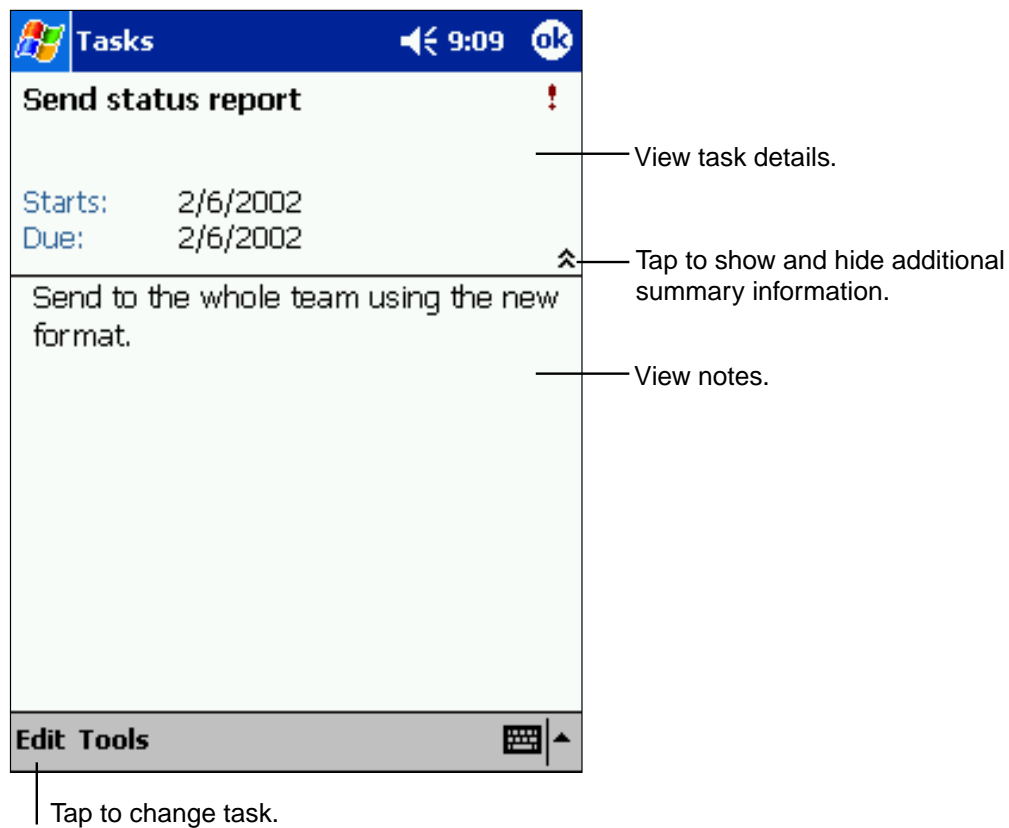

Notes: Capturing Thoughts and Ideas

Notes quickly captures thoughts, reminders, ideas and phone numbers. You can also create a recording to include with the entry.

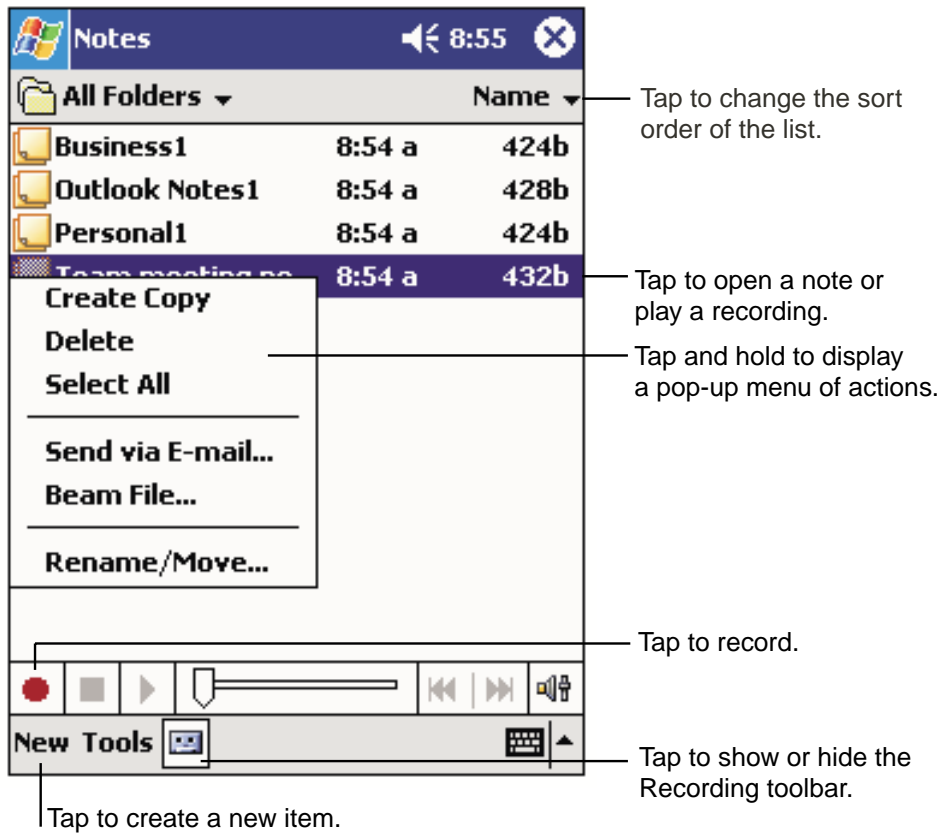

Creating a note:

1. Tap **New**.
2. Create your note by writing, drawing, typing, and recording. For more information about using the input panel, writing and drawing on the screen, and creating recordings, see “Entering Text Using the Input Panel” in Chapter 2.

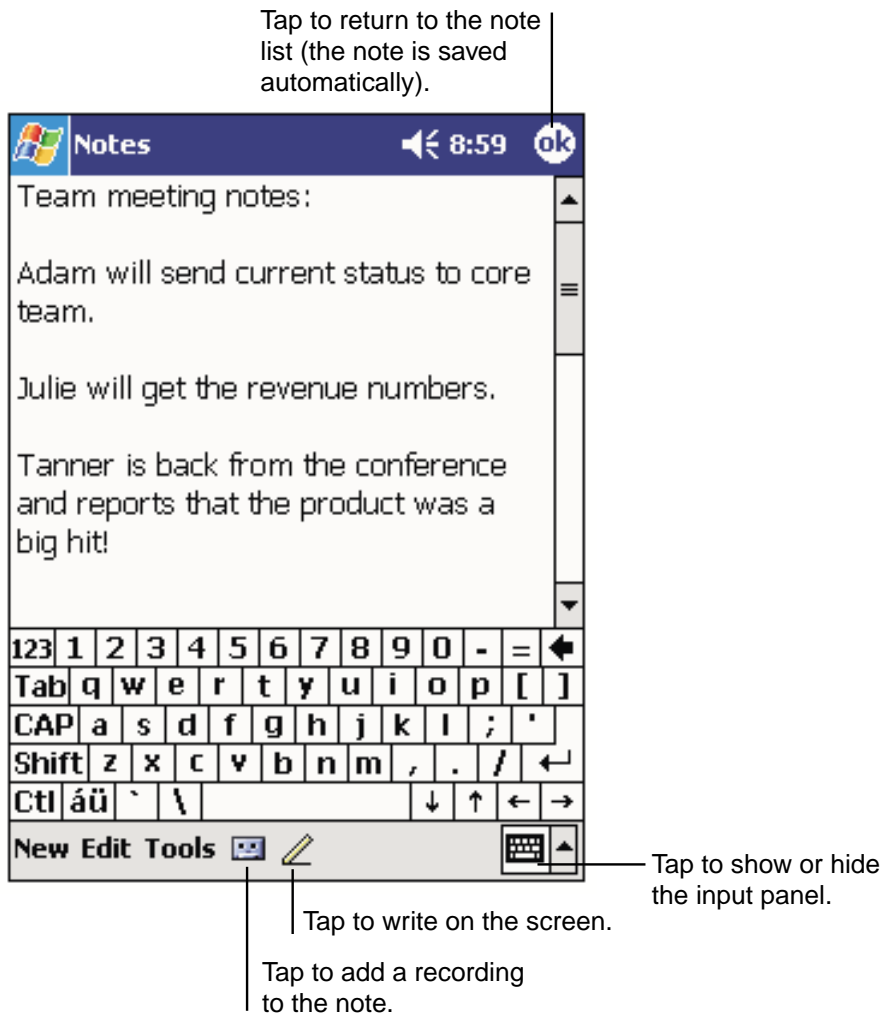

Inbox: Sending and Receiving E-mail Messages

Use Inbox to send and receive e-mail messages in either of these ways:

- Synchronize e-mail messages with Microsoft® Exchange or Microsoft® Outlook® on your computer.
- Send and receive e-mail messages by connecting directly to an e-mail server through an Internet service provider (ISP) or a network.

Synchronizing E-mail Messages

E-mail messages can be synchronized as part of the general synchronization process. You will need to enable Inbox synchronization in ActiveSync®. For information on enabling Inbox synchronization, see ActiveSync® Help on the computer.

During synchronization:

- Messages are copied from the mail folders of Exchange or Outlook® on your computer to the ActiveSync folder in Inbox on your device. By default, you will receive messages from the past five days only, the first 100 lines of each message, and those not including file attachments.
- E-mail messages in the Outbox folder on your device are transferred to Exchange or Outlook®, and then sent from those programs.
- E-mail messages in subfolders must be selected in ActiveSync® on your computer in order to be transferred.

...  **Note** You can also synchronize e-mail messages with your computer from a remote location. For more information, see Chapter 8.

Connecting Directly to an E-mail Server

The phone on your device can send and receive e-mail messages by connecting to an e-mail server. For more information about establishing this remote connection, see Chapter 8.

Once connected to the e-mail server:

- New messages are downloaded to the device Inbox folder,
- Messages in the device Outbox folder are sent; and
- Deleted messages are removed from the device Inbox folder

Messages received directly from an e-mail server are linked to your e-mail server rather than your computer. When a message is deleted from your device, it will also be deleted from the e-mail server the next time you connect.

When working online connected to your server, you can immediately read and respond to messages - they are sent as soon as you tap **Send**, saving space on your device.

To work offline, download new message headers or partial messages, and disconnect from the server. You can then mark which messages to completely download the next time you connect.

Using the Message List

Received messages are displayed in the message list - the most recently received are listed first.

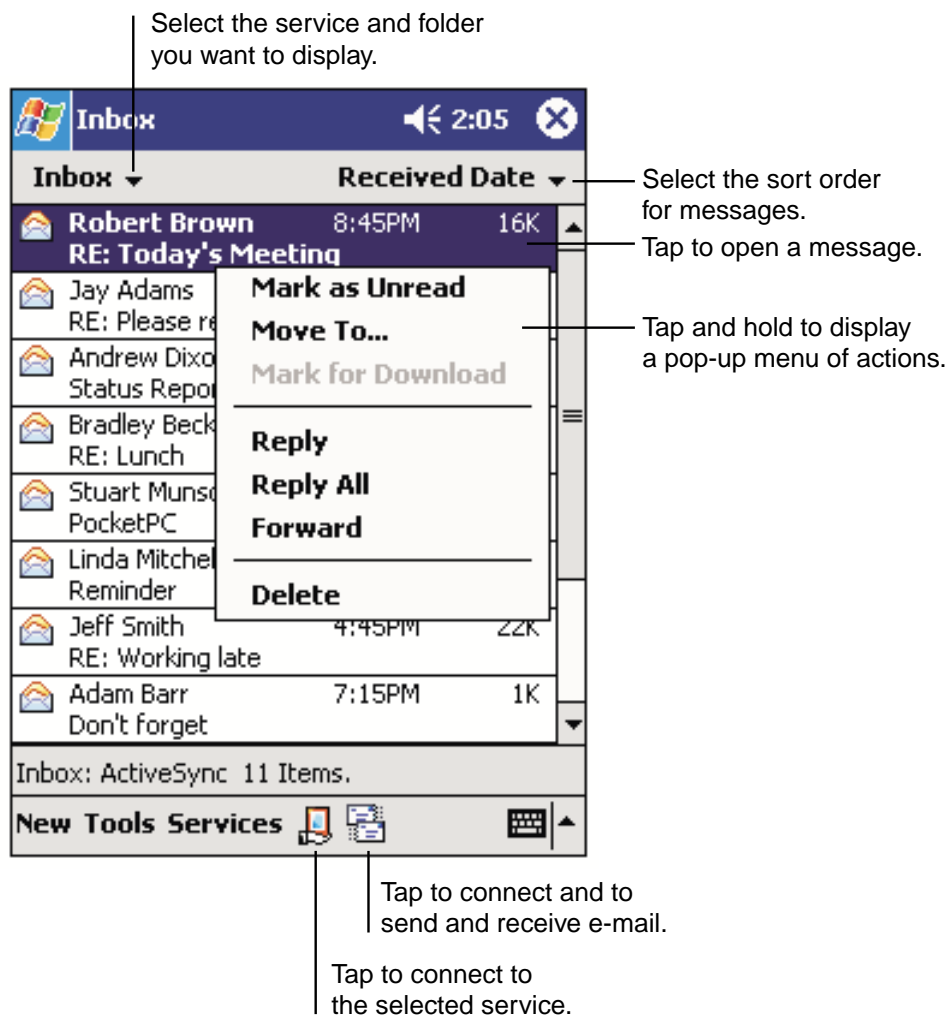

When you receive a message, tap it to open it. Unread messages are displayed in bold.

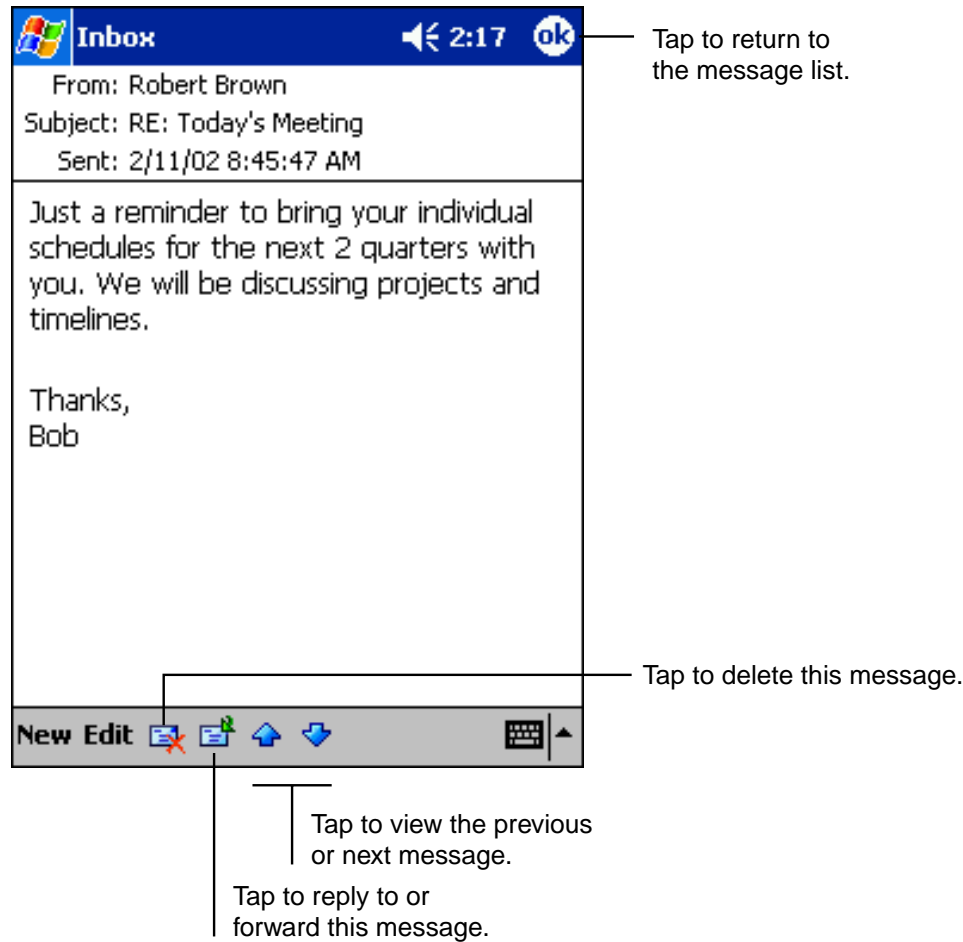

To retrieve a full message during your next synchronization or e-mail server connection, tap and hold the message. On the pop-up menu tap **Mark for Download**.

Specify downloading preferences when you set up the service or select your synchronization options.

- Inbox synchronization options can be changed using ActiveSync® options. See ActiveSync® Help for more information.
- To change options for e-mail server connections, tap **Tools** then tap **Options**. On the **Service** tab, tap the service you want to change. To remove a service, tap and hold the service and select **Delete**.

Composing Messages

1. Tap **New**.
2. In the **To** field, enter the e-mail addresses of the recipients, separating the names with a semi-colon, or select a name from the contact list by tapping and holding **To**, or by tapping the **Address Book** button.

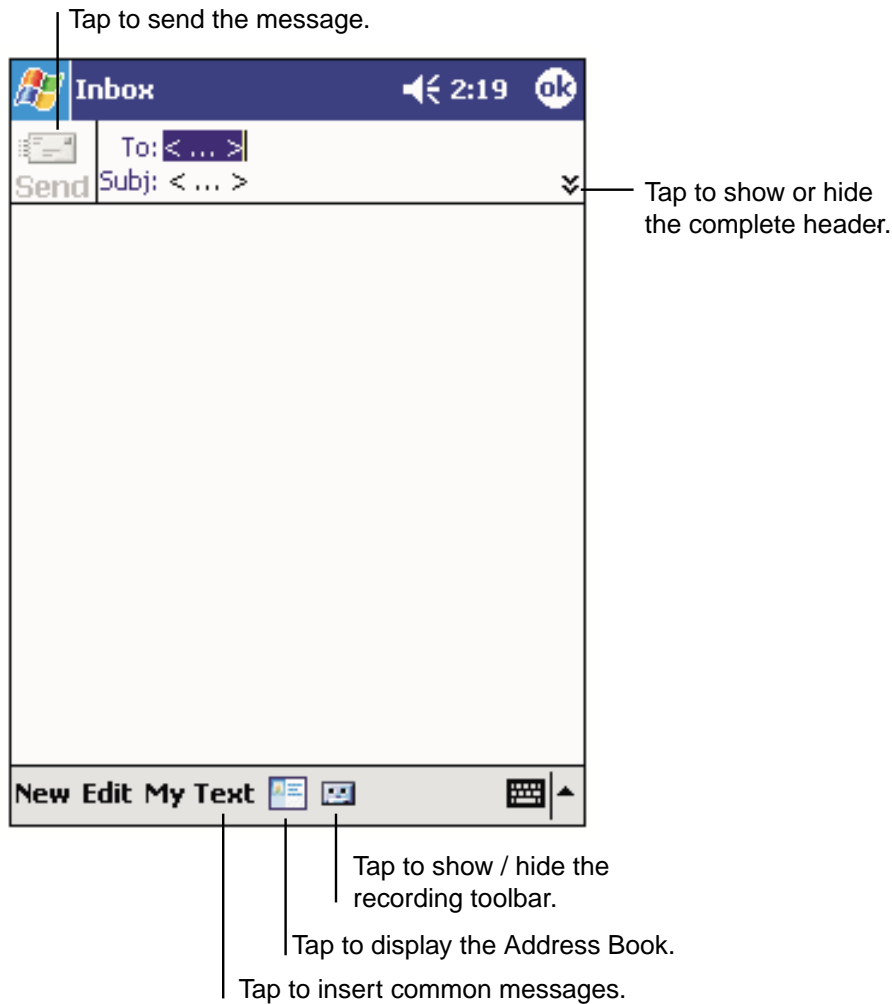

3. Compose your message. To enter preset or frequently used messages, tap **My Text** and select a message.
4. Tap **Send** when you've finished the message. If you are working offline, the message is moved to the Outbox folder and will be sent the next time you connect.

Managing E-mail Messages and Folders

Messages are displayed in one of five folders: Inbox, Deleted Items, Drafts, Outbox and Sent Items. The Deleted Items folder contains messages that have been deleted on the device. The behavior of the Deleted and Sent Items folders depends on the options you have chosen. In the message list, tap **Tools** then **Options**. On the **Message** tab, select your options.

To create new folders, tap **Tools** then **Manage Folders**. For all service except ActiveSync®, you can access folder options by tapping **Tools** then **Manage Folders**. To move a message to another folder, tap and hold the message and then tap **Move to** on the pop-up menu.

Folder behavior with a direct connection to an e-mail server

The behavior of the folders you create depends on whether you are using ActiveSync®, POP3, or IMAP4:

- If you use ActiveSync®, e-mail messages in the Inbox folder in Outlook® will automatically be synchronized with your device. You can select to synchronize additional folders by designating them for ActiveSync®. The folders you create and the messages you move will then be mirrored on the server. For example, if you move two messages from the Inbox folder to a folder named Family, and you have designated Family for synchronization, the server creates a copy of the Family folder and copies the messages into that folder. You can then read the messages while away from your computer.
- If you use POP3 and you move e-mail messages to a folder you created, the link is broken between the messages on the device and their copies on the mail server. The next time you connect, the mail server will see that the messages are missing from the device Inbox and delete them from the server. While this eliminates duplicate copies of messages, you will no longer have access to messages moved to folders created anywhere except the device.
- If you use IMAP4, the folders you create and the e-mail messages you move are mirrored on the server. Therefore, messages are available to you anytime you connect to your mail server, whether it is from your device or computer.

Chapter 6

Companion Programs

Companion programs include Microsoft® Pocket Word, Microsoft® Pocket Excel, Windows Media™ Player for Pocket PC, and Microsoft® Reader.

To switch to a companion program, tap , then **Programs**, then the program name.

Pocket Word

Pocket Word works with Microsoft® Word on your computer, providing easy access to copies of documents. You can also create new documents on your device or copy documents from your computer.

To create a new file, tap , **Programs, Pocket Word**, then **New**. Or, from the Today screen, tap **New**, then **Word Document**. Only one document can be opened at a time; when you open a second you will have to save the first. Documents can be saved in a variety of formats including Word (.doc), Pocket Word (.psw), Rich Text Format (.rtf), and Plain Text (.txt).

Pocket Word contains a list of stored files. Tap a file to open it, and tap and hold to delete, make copies of, or send it from the pop-up menu.

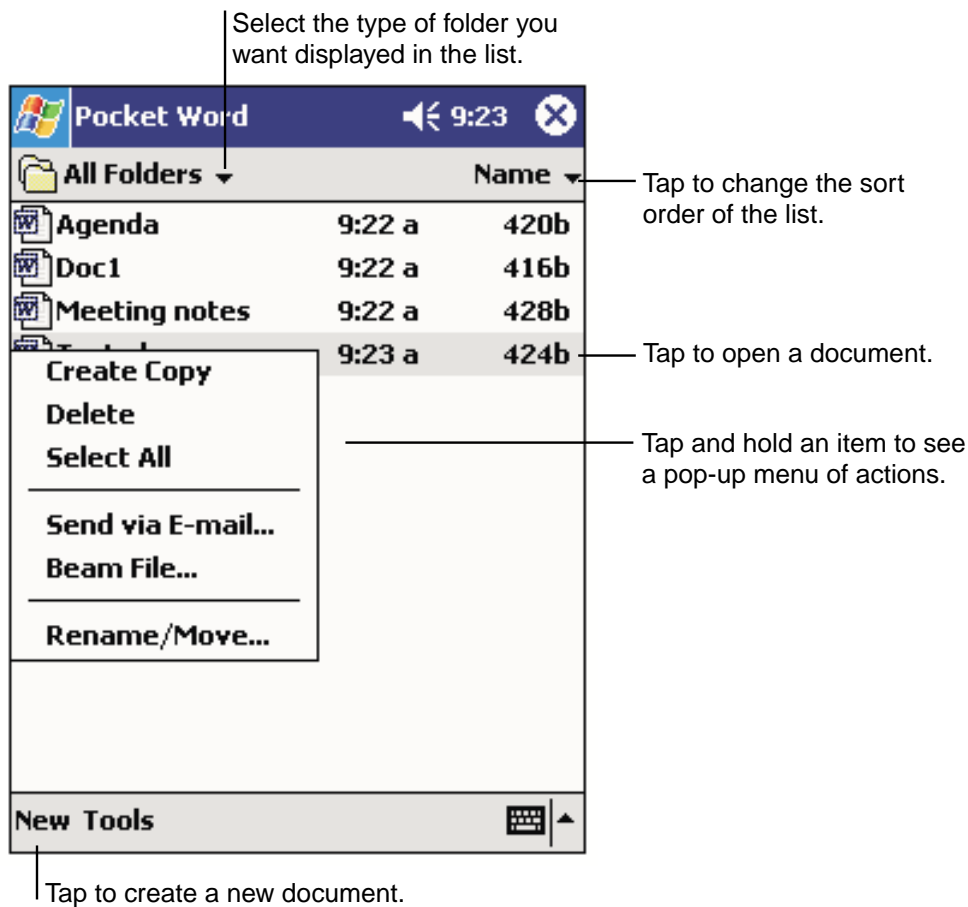

You can enter information in Pocket Word in one of four modes (typing, writing, drawing, and recording), which are displayed on the **View** menu. Each mode has its own toolbar, which you can show and hide by tapping the **Show/Hide Toolbar** button on the command bar.

Note You can change the zoom magnification by tapping **View** then **Zoom**. Then select the percentage you want. Select a higher percentage to enter text and a lower one to see more of your document.

If you're opening a Word document created on a computer, select **Wrap to Window** on the **View** menu so that you can see the entire document.

Typing Mode

Enter text using the input panel (See "Entering Text Using the Input Panel" in Chapter 2 for more information). To format or edit text, highlight it by dragging the stylus over the text you wish to select. Use the **Edit** menu or toolbars for formatting changes.

To search for text within a document, tap **Edit** then **Find/Replace**.

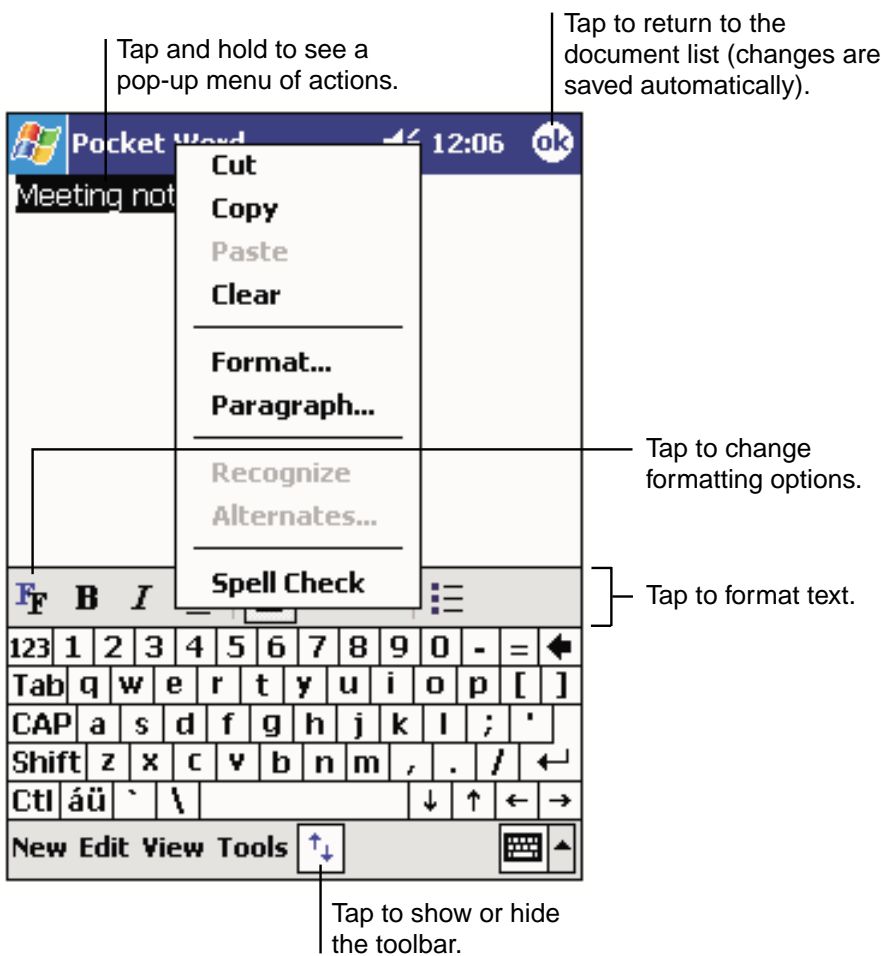

Writing Mode

In writing mode, use your stylus to write directly on the screen. Ruled lines are displayed as a guide, and the zoom magnification is greater than in typing mode to allow you to write more easily. For more information on writing and selecting writing, see “Entering Text Using the Input Panel” in Chapter 2.

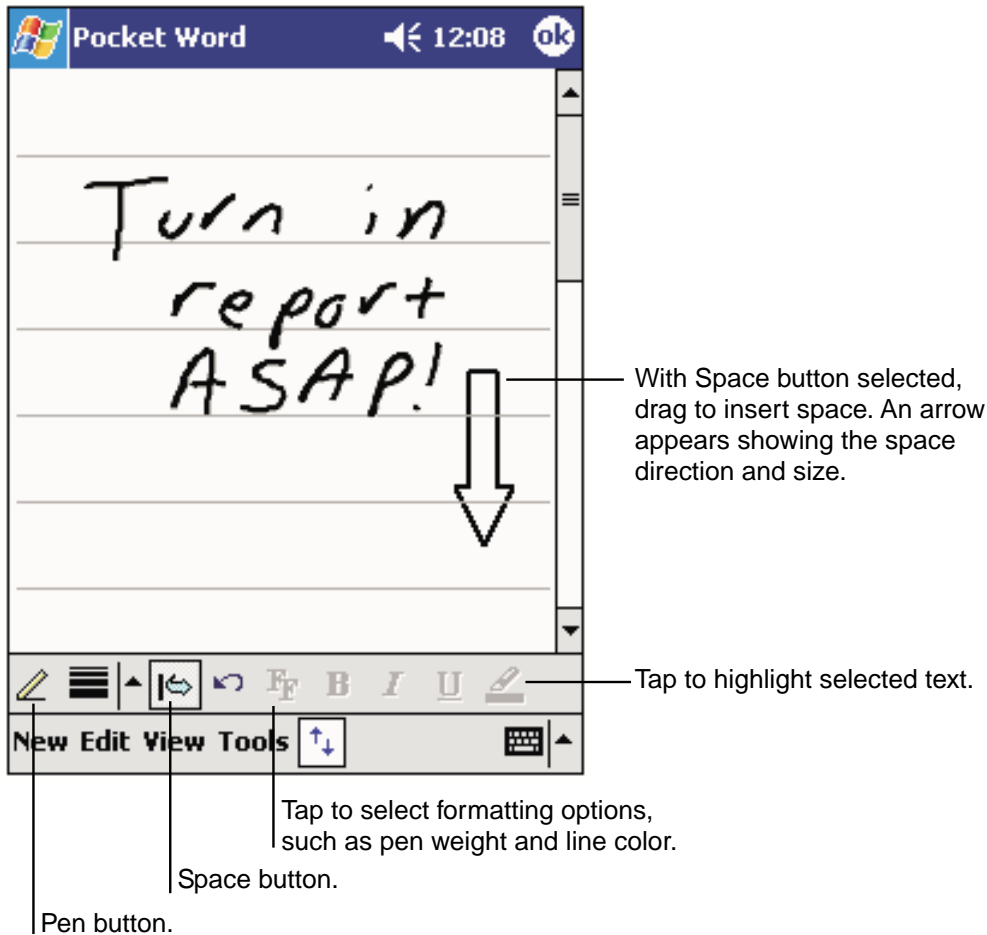

...  **Note** If you cross three ruled lines in a single stylus stroke, the writing becomes a drawing, and can be edited and manipulated as described in the following section.

Written words are converted to graphics (metafiles) when a Pocket Word document is converted to a Word document on your computer.

Drawing Mode

In drawing mode, use your stylus to draw on the screen. Gridlines appear as a guide. When you lift your stylus off the screen after the first stroke, you'll see a drawing box indicating the boundaries of the drawing. Every subsequent stroke within or touching the drawing box becomes part of the drawing. For more information on drawing and selecting drawings, see "Entering Text Using the Input Panel" in Chapter 2.

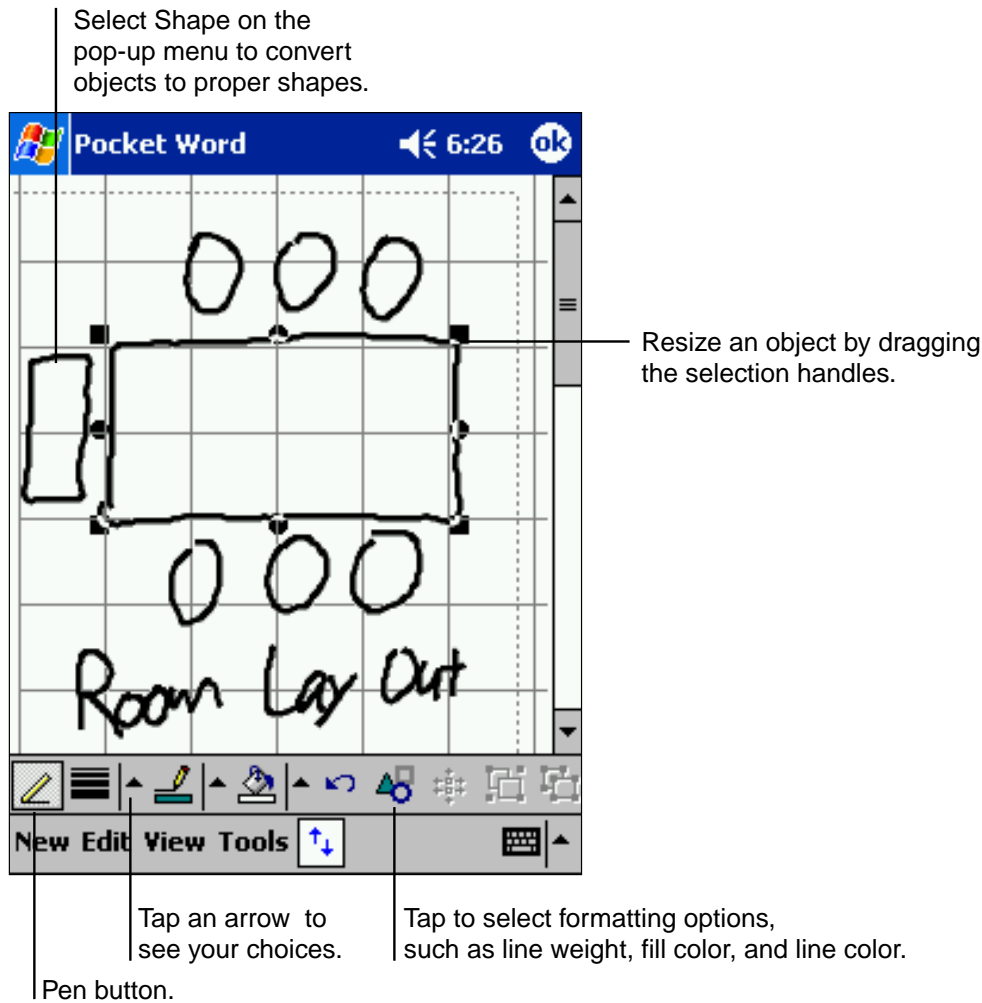

Recording Mode

In recording mode, you can embed a recording into your document. Recordings are saved as .wav files. For more information on recording, see "Entering Text Using the Input Panel" in Chapter 2.

For more information on using Pocket Word, tap  then **Help**.

Pocket Excel

Pocket Excel works with Microsoft® Excel on your computer, providing easy access to copies of spreadsheets. You can also create new spreadsheets on your device or copy spreadsheets from your computer.

To create a new file, tap , **Programs, Pocket Excel**, then **New**. Or, from the Today screen, tap **New**, then **Excel Workbook**. Only one spreadsheet can be opened at a time; when you open a second you will have to save the first. Spreadsheets can be saved in a variety of formats including Excel (.xls) and Pocket Excel (.pls).

Pocket Excel contains a list of stored files. Tap a file to open it, and tap and hold to delete, make copies of, or send it from the pop-up menu.

Pocket Excel provides fundamental spreadsheet tools such as formulas, functions, sorting and filtering. To display toolbar, tap **View** then **Toolbar**.

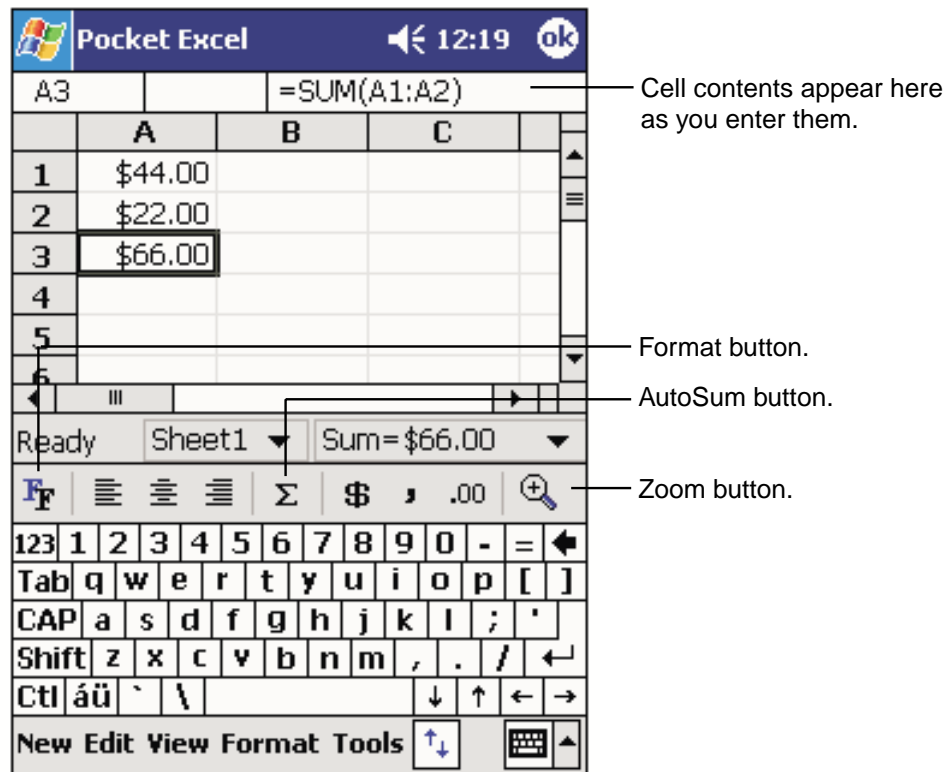

...  **Note** If your spreadsheet contains sensitive information, you can protect it with a password. To do so, open the file, tap **Edit**, then **Password**. Every time you open that file, you will need to enter the password.

Tips for Working in Pocket Excel

- To view in full screen mode, tap **View** then **Full Screen**. Tap **Restore** to exit mode.
- Tap **View** to select items you want to show or hide.
- To freeze panes, select the cell(s) you want to freeze, tap **View** then **Freeze Panes**. Freeze the top and leftmost panes in a spreadsheet to keep row and column labels visible as you scroll through a sheet.
- To split panes to view different areas of a spreadsheet, tap **View** then **Split**. Drag the split bar to the desired location. To remove, tap **View** then **Remove Split**.
- To hide a row or column, select it then tap **Format**, then **Row** or **Column**, then **Hide**. To show a hidden row or column tap **Tools**, then **Go To**, then type a reference that is in the hidden row or column. Then tap **Format**, then **Row** or **Column**, then **Unhide**.

For more information on using Pocket Excel, tap  then **Help**.

MSN® Messenger

MSN® Messenger on your mobile device is an instant messaging program that lets you:

- View a list of instant messaging contacts who are online.
- Send and receive instant messages.
- Have instant message conversations with groups of contacts.

To use MSN® Messenger, you must have a Microsoft Passport™ account or a Microsoft® Exchange e-mail account. If you have a Hotmail® or MSN® account, you already have a Passport. Once you have obtained either a Microsoft Passport™ or a Microsoft® Exchange account, you are ready to set up your account.

...  **Note** Sign up for a Microsoft Passport™ account at <http://www.passport.com>. Get a free Microsoft® Hotmail® e-mail address at <http://www.hotmail.com>.

To switch to MSN® Messenger, tap , **Programs**, then tap **MSN Messenger**.

Setting Up

Before you can connect, you must enter Passport or Exchange account information.

To set up an account and sign in:

1. In the **Tools** menu, tap **Options**.
2. On the **Accounts** tab, enter your Passport or Exchange account information.
3. Tap **OK**.
4. Tap the sign-in screen and tap **Sign in**.

...  **Note** If you use MSN® Messenger on your computer, your contacts will automatically show up on your device.

Working with Contacts

The MSN® Messenger window displays all your message contacts divided into Online and Not Online categories. While connected, tap and hold any contact and a pop-up menu appears allowing you to chat, send e-mail, block the contact or delete the contact.

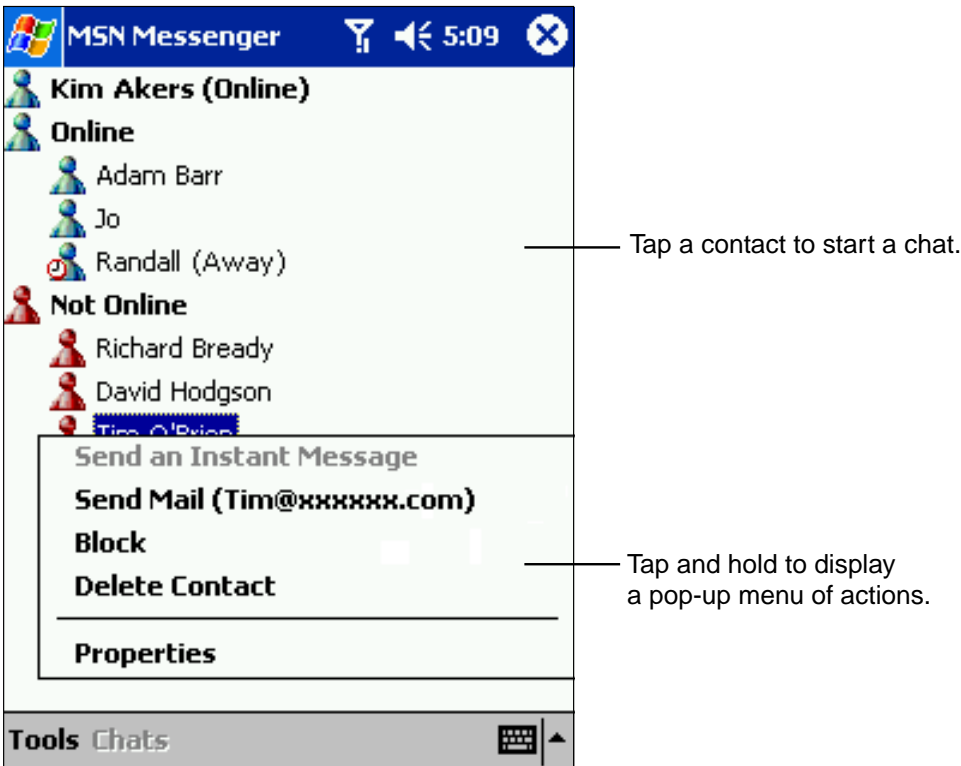



...  **Note** To see others online without being seen, in the **Tools** menu, tap **My Status** and select **Appear Offline**.

If you block a contact, you will appear offline but will remain on the blocked contact's list. To unblock a contact, tap and hold the contact, then tap **Unblock** on the pop-up menu.

Chatting with Contacts

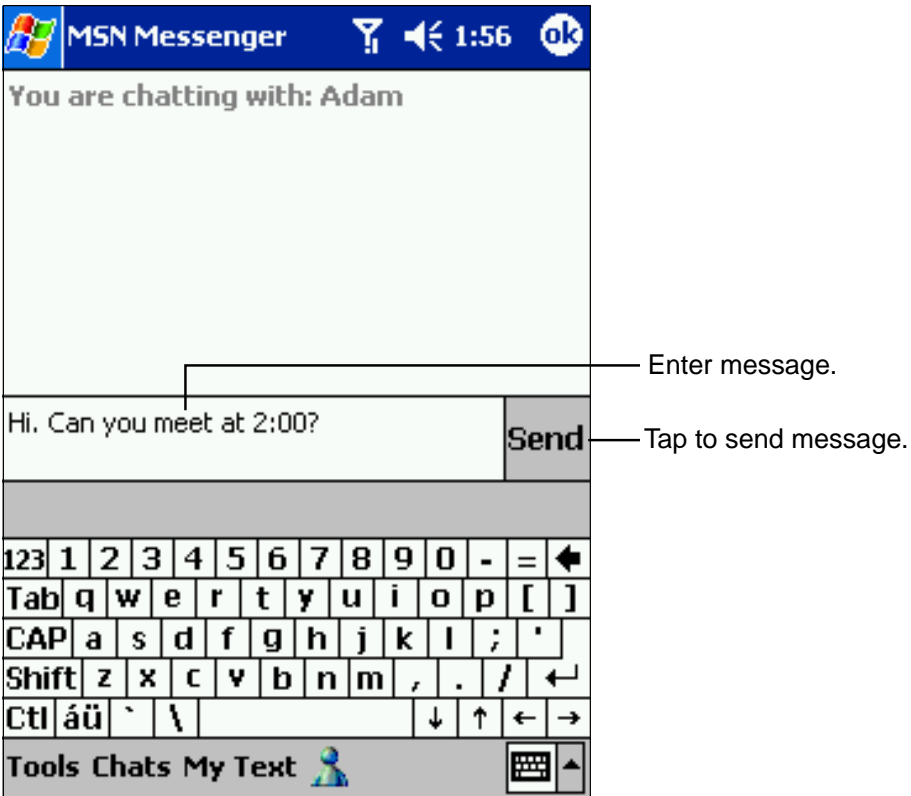
Tap a contact name to open a chat window. Enter your message in the text entry area, or tap **My Text** to enter a preset message, and tap **Send**. To invite another contact to a multi-user chat, in the **Tools** menu, tap **Invite** and tap the contact you wish to invite.



...  **Note** To switch back to the main window without closing a chat, tap the **Contacts** button. To revert back to your chat window, tap **Chats** and select the person whom you were chatting with.

To see if the contact you are chatting with is responding, look for the message under the text entry area.

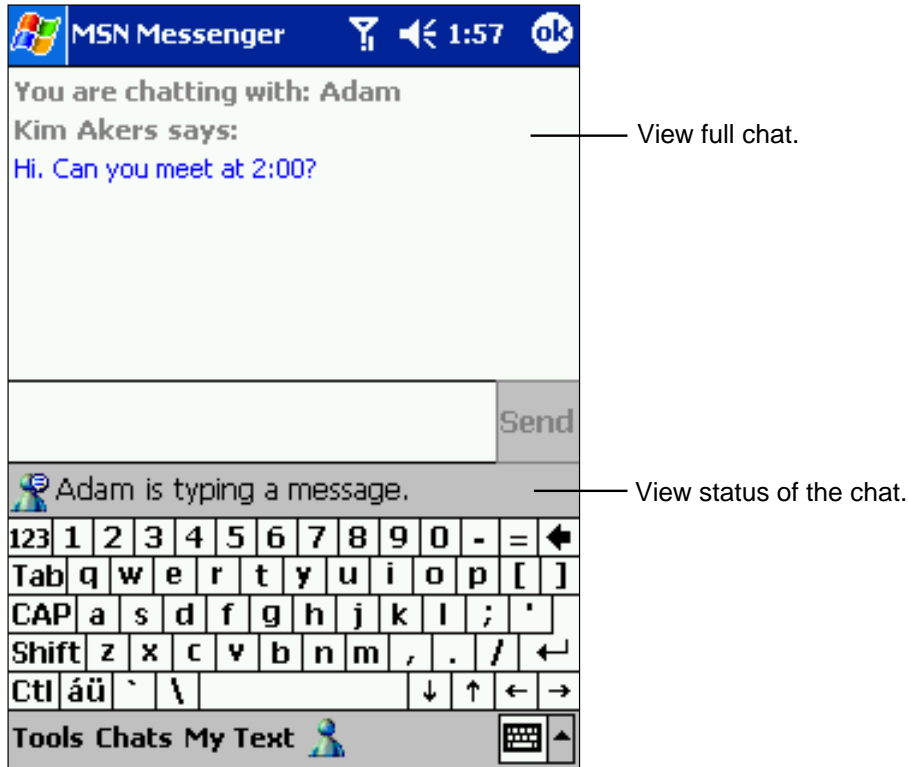

For more information on using MSN® Messenger, tap  then **Help**.

Windows Media™ Player for Pocket PC

Use Microsoft® Windows Media™ Player for Pocket PC to play digital audio and video files that are stored on your device or on a network. To switch to Windows Media™ Player for Pocket PC, tap



, then tap **Windows Media**.



Use Microsoft® Windows Media™ Player on your computer to copy digital audio and video files to your device. You can play Windows Media™ and MP3 files on your device.

Windows Media™ player can be used even if the screen is turned off. Tap **Tools**, **Settings** then **Buttons**, and select **Screen Toggle** from the pull-down list beside “Select Function”, then press the program button you wish to allocate. By pressing the allocated button, you can turn on and off the screen.

For more information about using Windows Media™ Player for Pocket PC, tap , then tap **Help**.

Microsoft® Reader

Microsoft® Reader enables you to read eBooks on your device. Using ActiveSync®, book files can be copied from your computer to your device.

Each book consists of a cover page, an optional table of contents, and the pages of the book. You can:

- Page through the book by using the cursor button on your device or by tapping the page number on each page.
- Annotate the book with highlighting, bookmarks, notes, and drawings.
- Search for text and look up definitions for words.

The Guidebook contains detailed information on using the software. To open, tap **Help** on the Reader command bar. From a book page, tap and hold the book title, then tap **Help** on the pop-up menu.

To open Microsoft® Reader, tap , **Programs** then **Microsoft Reader**.

Getting Books on Your Device

Download book files from the Web by visiting your favorite eBook retailer and following the directions for downloading.

The Companion CD also includes sample books and a dictionary in the MSReader folder of the APPS folder.

The Read Me file in the EBOOKS folder of the MSReader folder provides directions for using ActiveSync® to download files from your computer.

Using the Library

The Library is your Reader home page; it displays a list of all books stored on your device or storage card.

To open the Library:

- On the Reader command bar, tap **Library**.
- On a book page, tap the book title, and then tap **Library** on the pop-up menu.

To open a book, tap its title in the Library list.

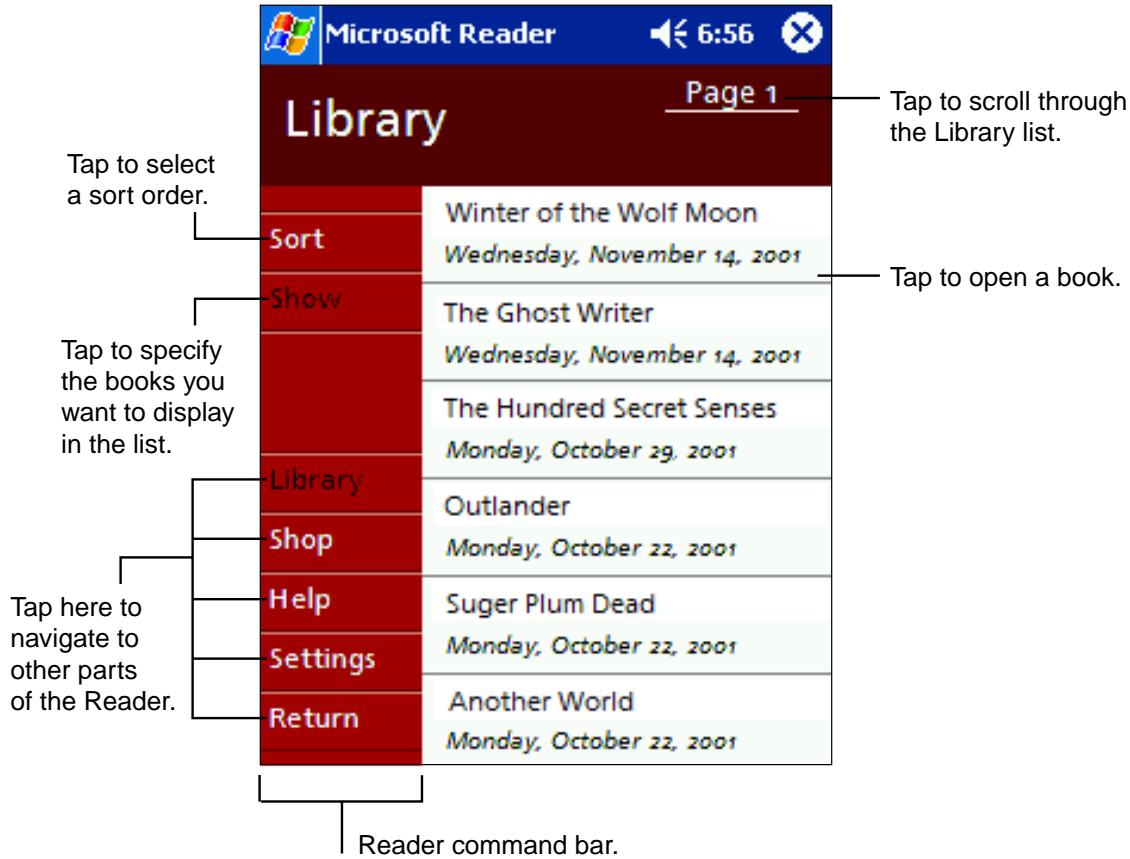

Reading a Book

Each book consists of a cover page, an optional table of contents, and the pages of the book. Navigation options are listed in the bottom portion of the cover page.

The first time you open a book, you'll probably want to go to the first page or to the table of contents, if there is one. Subsequently, whenever you open the book, you'll be automatically taken to the last page read.

In addition to the text, each book page includes a page number and book title.

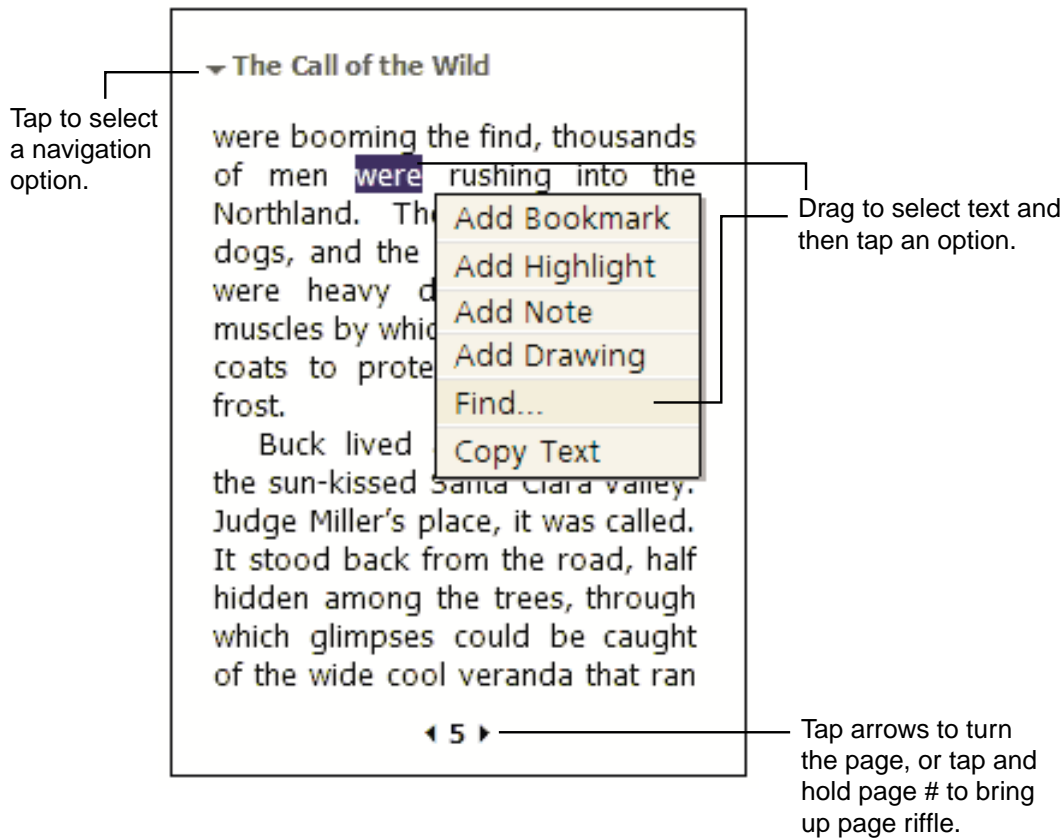

You can also page through a book by using the cursor button on your device.

Using Reader Features

Reading an eBook gives you several options not available with paper books. Select text by dragging stylus across it and follow options outlined below:

- **Search for Text:** Find text by tapping **Find** on the pop-up menu. Enter your search word and tap the desired **Find** option. Results are highlighted on the page. Tap outside the box to close **Find**, and to return to your original page, tap the title then **Return** on the pop-up menu.
- **Copy Text:** You can copy text from books into any program that accepts text. Select the text you want to copy, then tap **Copy Text** on the pop-up menu. Paste it into the program of your choice.
- **Bookmarks:** When **Add Bookmark** is selected from the pop-up menu, a color-coded bookmark appears in the right margin. Multiple bookmarks can be added, and they can be accessed from anywhere in the book by tapping the bookmark icon.
- **Highlights:** When text is highlighted, it appears with a colored background.
- **Notes:** Enter text in the note that appears on top of the page. To show or hide the note, tap the Note icon displayed in the left margin.
- **Drawing:** When you add a drawing, a Drawing icon appears in the top-right corner of the page along with tools on the bottom of the page.
- Tap **Go to** then **Annotations** on the book's cover page to see a list of the book's annotations including bookmarks, highlights, text notes and drawings. Tapping an entry takes you to the annotated page.

Removing a Book

When you finish reading a book, it can be deleted (to conserve space) by tapping and holding the title in the Library list, and then **Delete** on the pop-up menu.

Chapter 7

Pocket Internet Explorer

Use Microsoft® Pocket Internet Explorer to view Web or WAP pages in either of these ways:

- During synchronization with your computer, download your favorite links and mobile favorites that are stored in the Mobile Favorites subfolder in Internet Explorer on the computer.
- Connect to an Internet service provider (ISP) or network and browse the Web. See “Accessing the Internet” in Chapter 3.

When connected to an ISP or network, you can also download files and programs from the Internet or intranet.

To switch to Pocket Internet Explorer, tap  then **Internet Explorer**.

The Mobile Favorites Folder

Only items in your computer’s Mobile Favorites folder will be synchronized with your device. This folder is automatically created when ActiveSync® is installed.

Favorite Links

During synchronization your computer’s Mobile Favorites folder is synchronized with your device’s Pocket Internet Explorer. Both computers are updated each time you synchronize. If the link is not marked as mobile favorite, you will have to connect to your ISP or network to view page content. For more information, see ActiveSync® Help on the computer.

Mobile Favorites

If you are using Microsoft® Internet Explorer 5.0 or later on your computer, you can download mobile favorites to your device. Synchronize the web content of your mobile favorites downloads to your device so that you can view pages while you are disconnected from your ISP and computer. Use the Internet Explorer plug-in installed with ActiveSync® to create mobile favorites quickly.

To create a mobile favorite:

1. In Internet Explorer on your computer, click **Tools** then **Create Mobile Favorite**.
2. To change the link name, enter a new name in the **Name** box.
3. Optionally, in **Update**, select a desired update schedule.
4. Click **OK**. Internet Explorer downloads the latest version of the page to your computer.

5. If you want to download the pages that are linked to the mobile favorites you just created, right-click the mobile favorite then click **Properties**. In the **Download** tab, specify the number of links deep you want to download. To conserve device memory, go only one level deep.
6. Synchronize your device and computer and the Mobile Favorites folder will be downloaded to your device.

...  **Note** If a scheduled update was not specified in step 3, content will have to be manually downloaded to update both computers. To see the last time content was downloaded to the computer, click **Tools** then **Synchronize** from the Internet Explorer window. Manually download content as needed.

To add a button to your computer's Internet Explorer toolbar for creating mobile favorites, click **View, Toolbars** then **Customize**.

Saving device memory:

To minimize the amount of memory used by mobile favorites:

- In the Favorites settings, select ActiveSync® options and turn off pictures and sounds, or stop select mobile favorites from being downloaded. For more information see ActiveSync® Help.
- Limit the number of downloaded linked pages. On your computer's Internet Explorer, right click the mobile favorite you want changed and then **Properties**. In the **Download** tab, specify 0 or 1 for the number of linked pages you want to download.

Using AvantGo Channels

AvantGo, a free interactive service that provides access to personalized content and popular websites, can be subscribed to directly from your device. Content can be downloaded when you synchronize your device and computer, or directly from the Internet. Visit the AvantGo website for more information.

To sign up for AvantGo:

1. In ActiveSync® options on the computer, turn on synchronization for the AvantGo information type.
2. In Pocket Internet Explorer on your device, tap the Favorites button to display your list of favorites.
3. Tap the AvantGo Channels link.
4. Tap the Activate button.
5. Follow the directions on the screen. You will need to synchronize your device with your computer and then tap the My Channels button to complete the AvantGo setup.

When synchronization is complete, tap the AvantGo Channels link in your list of favorites to see a few of the most popular channels. To add or remove channels, tap the **Add** or **Remove** link.

Using Pocket Internet Explorer

Pocket Internet Explorer can browse mobile favorites and channels that have been downloaded to your device without connecting to the Internet. Or, you can connect to the Internet through an ISP or a network connection.



- Hide pictures button.
- Favorites button.
- Home button.
- Refresh button.

Viewing mobile favorites:

1. Tap the **Favorites** button to display your list of favorites.

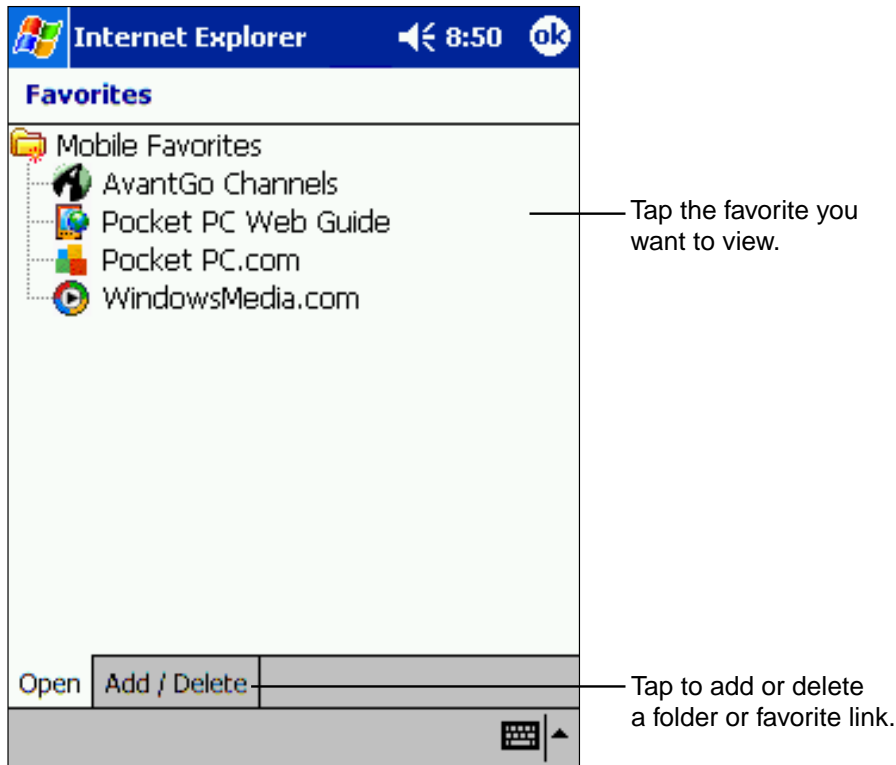

2. Tap the page you want to view.

The version of the page that was downloaded the last time you synchronized will be displayed. If the page is not on your device, the favorite will be dimmed. Synchronize with your computer to download the page to your device, or connect to the Internet to view the page.

Browsing the Internet:

1. Set up a connection to your ISP or corporate network using **Connections**, as described in Chapter 8.
2. To connect and start browsing, do one of the following:
 - Tap the Favorites button, and then tap the favorite you want to view.
 - Tap **View** then **Address Bar**. Enter the destination web address and tap . Tap the arrow to select from previously entered websites.

...  **Note** To add a favorite link, tap and hold on the page and tap **Add to Favorites** in the pop-up menu.

Chapter 8

Getting Connected

Your device can exchange information with other mobile devices as well as your computer, a network, or the Internet. The connection options include the following:

- The device's infrared (IR) port can send and receive files from another device. See "Transferring Items Using Infrared" below for more information.
- When connected to the Internet via your service provider, you can send and receive e-mail by using Inbox and view web and WAP pages using Pocket Internet Explorer. Your service provider should provide the software necessary to install other services, such as paging and faxing. See "Connecting to the Internet" later in this chapter for more information.
- When connected to a Network, you can send and receive e-mail by using Inbox and view web and WAP pages using Pocket Internet Explorer and synchronize with your computer. See "Connecting to Work" later in this chapter for more information.
- Remotely connect to your computer to synchronize information such as Pocket Outlook®. See ActiveSync® Help on your computer or Connection Help on your device for more information.

Transferring Items Using Infrared

Using infrared (IR), you can send and receive information, such as contacts and appointments, between two devices.

Sending information:

1. Locate the item to send.
2. Align the IR ports so that they are unobstructed and within a close range.
3. Tap and hold the item, and tap **Beam Item** on the pop-up menu.

...  **Note** You can also send items, but not folders, from File Explorer. Tap and hold the item you want to send, then tap **Beam File** on the pop-up menu.

Receiving information:

1. Align the IR ports so that they are unobstructed and within a close range.
2. Have the owner of the other device send the information to you. Your device will automatically receive it.

Connecting to the Internet

You can connect to your ISP, and use the connection to send and receive e-mail messages and view Web or WAP pages.

...  **Note** To connect to the Internet using Watcher, see “Accessing the Internet,” Chapter 3.

Creating a modem connection to an ISP:

1. Obtain the following information from your ISP: ISP dial-up access telephone number, user name, password, and TCP/IP settings. Some ISPs require information in front of the user name, such as MSN/username.
2. Tap  then **Settings**. In the **Connections** tab, tap **Connections**. Under The Internet settings, select **Internet Settings** and tap **Modify**.
3. In the **Modem** tab, tap **New**.
4. Enter a name for the connection, such as “ISP Connection.”
5. In the **Select a modem** list, select **Sierra Wireless SB555 Modem**.
6. In the **Baud rate** list, select **110**. It means the Baud rate is 230400bps.
7. You should not need to change any settings in **Advanced**. Most ISPs now use a dynamically-assigned address. If the ISP you are connecting to does not use a dynamically-assigned address, tap **Advanced** then the **TCP/IP** tab, and enter the address. When finished, tap **OK** and then **Next**.
8. Enter the access phone number, and tap **Next**.
9. Select other desired options, and tap **Finish**. Then tap **OK**.
10. In the **Dialing Locations** tab, specify your current location and phone type. These settings will apply to all connections you create.

To automatically start a connection perform one of the following tasks:

- Use the Inbox to send and receive messages. Review “Connecting Directly to an E-mail Server” later in this chapter for detailed set-up instructions.
- Use Internet Explorer to visit Web and WAP pages. See Chapter 7 for more information.
- Use MSN® Messenger to send and receive instant messages. See “MSN® Messenger” in Chapter 6 for more information.

...  **Note** Before using the built-in modem (Sierra Wireless SB555 Modem) to connect from applications, be sure to tap **Connect** on the **DATA** tab screen of Watcher.

Connecting to Work

To connect to a network at work, you need to set up a RAS account through your network administrator, then follow the steps below in “Creating a modem connection to a network.”

- Create a modem connection by using a RAS account. Before you can create this modem connection, your network administrator will need to set up a RAS account for you. If this is the method you want to use, see “Creating a modem connection to a network.” Your network administrator may also give you VPN settings.

Creating a modem connection to a network:

1. Get the following information from your network administrator: dial-up access telephone number, user name, password, domain name, and TCP/IP settings.
2. Tap  then **Settings**. In the **Connections** tab, tap **Connections**. Under The Internet settings, select **Work Settings** and tap **Modify**.
3. In the **Modem** tab, tap **New**.
4. Enter a name for the connection, such as “Company Connection.”
5. In the **Select a modem** list, select **Sierra Wireless SB555 Modem**.
6. In the **Baud rate** list, select **110**. It means the Baud rate is 230400bps.
7. You should not need to change any settings in **Advanced**. Most servers now use a dynamically-assigned address. If the server you are connecting to does not use a dynamically-assigned address, tap **Advanced** and then the **TCP/IP** tab and enter the address. When finished, tap **OK** then **Next**.
8. Enter the access phone number, and tap **Next**.
9. Select other desired options, and tap **Finish**. Then tap **OK**.
10. In the **Dialing Locations** tab, specify your current location and phone type. These settings will apply to all connections you create.

To automatically start a connection perform one of the following tasks:

- Use the Inbox to send and receive messages. Review “Connecting Directly to an E-mail Server” later in this chapter for detailed set-up instructions.
- Use Internet Explorer to visit Web and WAP pages. See Chapter 7 for more information.
- Use MSN® Messenger to send and receive instant messages. See “MSN® Messenger” in Chapter 6 for more information.
- Synchronize. See ActiveSync® Help on the computer for more information.

Ending a Connection

To disconnect, do one of the following:

- When connected via dial-up or VPN, tap the Connection icon, , on your navigation bar and tap **End**.
- When connected via cradle, detach your device from the cradle.
- When connected via Infrared, move the device away from the other one.

Connecting Directly to an E-mail Server

You can set up a connection to an e-mail server so that you can send and receive e-mail messages by using a modem or network connection and Inbox on your device.

...  **Note** The ISP or network must use a POP3 or IMAP4 e-mail server and an SMTP gateway.

You can use multiple e-mail services to receive messages. For each e-mail address you intend to use, set up and name the e-mail service following the directions below.

To set up an e-mail service:

- In Inbox on your device, tap **Services**, then **New Service**. Follow the directions in the New Service wizard.

For an explanation of a screen, tap  then **Help**. When finished, to connect to your e-mail server, tap **Services** then **Connect**. For more information on using the Inbox program, see “Inbox: Sending and Receiving E-mail Messages” in Chapter 5.

Get Help on Connecting

Additional help and information can be found in the following locations:

- “Inbox: Sending and Receiving E-mail Messages” in Chapter 5.
- Online Help on the device. Tap  then **Help**. Tap **View, All Installed Help**, then **Inbox** or **Connections**.
- ActiveSync® Help on the computer. In ActiveSync®, click **Microsoft ActiveSync Help** on the **Help** menu.
- For troubleshooting information, see the Pocket PC Web site at: <http://www.microsoft.com/mobile/pocketpc>.

Chapter 9

Optional Functions

Home

To easily launch the built-in or installed applications, tap the icon displayed on the Home screen.

Launching an Application from Home

1. Tap , **Programs**, then **Home** to display the Home screen.

You can also launch the Home by pressing the device Home Program button.

For initial setting, the respective application icons are registered on three tabs: **Main**, **Programs** and **Games**. In the **Running** tab, active applications are displayed.

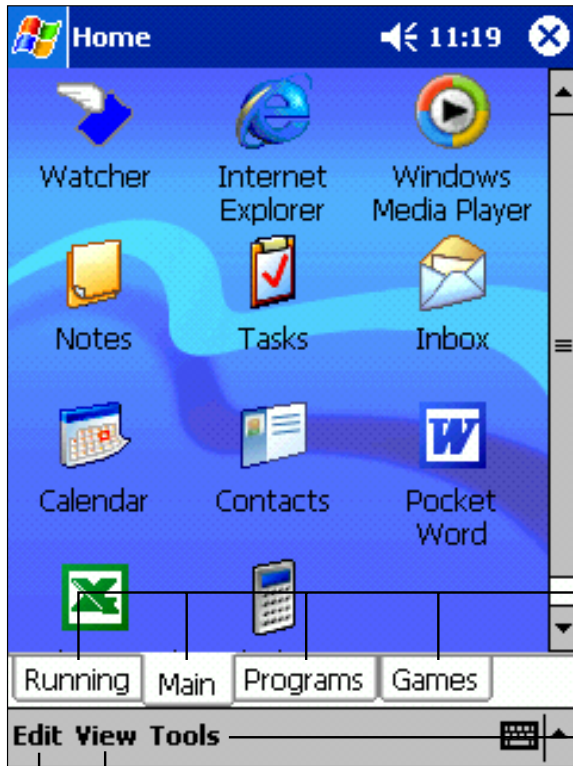

Tab.

Tap to select **Tab Settings** or **About**.

Tap to select **Large Icon**, **Small Icon** or **Text Color**.

Tap to select **Paste** or **Add**.

2. Tap the desired tab, then tap the application icon you want to launch.

...  **Note** Press the Home Program button to switch tabs.

An application can also be launched by moving the cursor button to select a program and pressing it to launch.

You can add up to 10 tabs, with up to 18 icons in each.

About Running

The **Running** tab displays active applications. Icons do not appear.

To activate/stop the application:

To activate an application tap its name, or tap **Activate** in the pop-up menu.

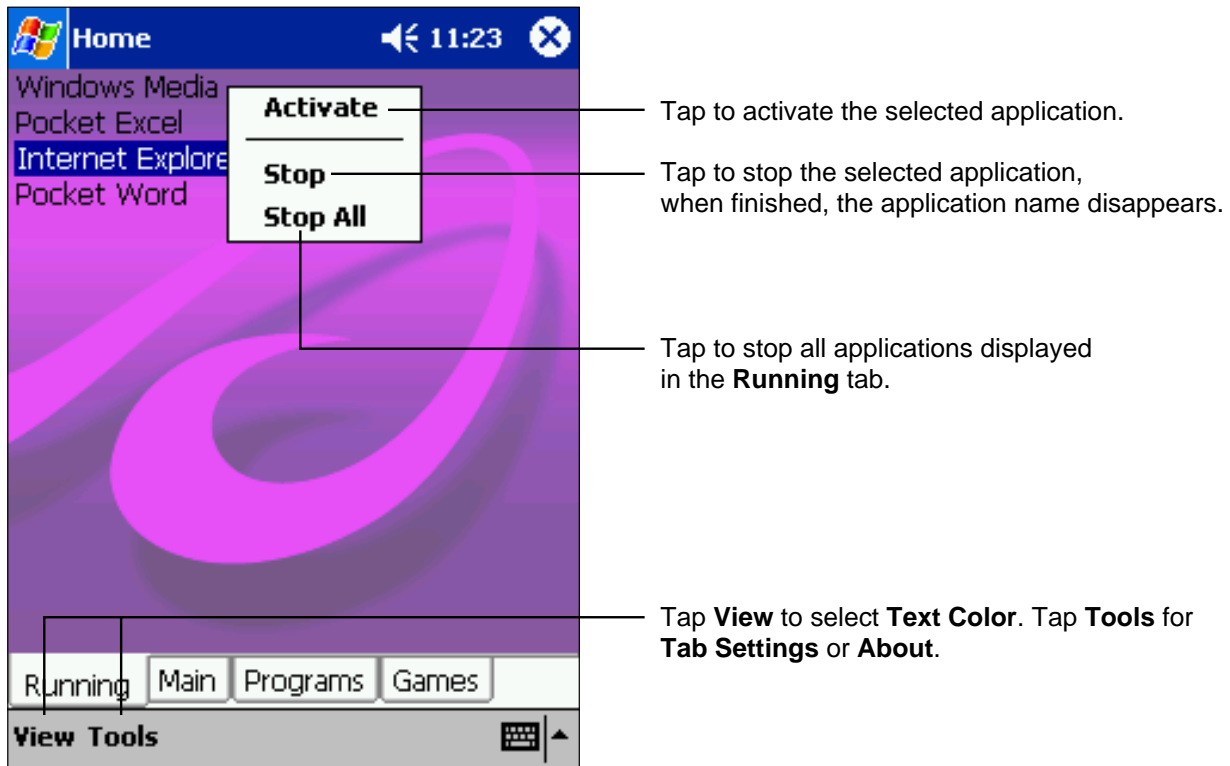



















...  **Note** Tap and hold anywhere on the **Running** tab, except the application names, and **Stop All** appears in the pop-up menu.

“Activate”, “Stop” and “Stop All” of the running application can also be operated with **Memory of System** tab of **Settings**.

Display Icon List

The following list shows the tabs and icons for the initial setup.

Tabs	Icons	Applications	Tabs	Icons	Applications
Running			Programs		Front Light
Main		Watcher	Programs		Power
		Pocket Internet Explorer			File Explorer
		Windows Media™ Player			Backup
		Notes			Infrared Receive
		Tasks			Microsoft® Reader
		Inbox			MSN® Messenger
		Calendar	Games		Solitaire
		Contacts			
		Pocket Word			
		Pocket Excel			
	Calculator				

Moving an Application Icon into Another Tab

A moved icon appears next to the last icon in its new location. It cannot be moved to a tab that already contains 18 icons.

To move using pop-up menu:

1. Tap and hold the icon to be moved.
2. Tap **Cut** on the pop-up menu.
3. Tap the destination tab, then tap **Paste** on the **Edit** menu.

...  **Note** You can also select **Paste** from the pop-up menu displayed by tapping and holding any portion other than the icon.

To move using drag and drop:

Tap the icon you want to move and drag it to the destination tab, after the tab name is highlighted, drop it.

The icon is transferred and deleted from its original location.

...  **Note** If the icon is dragged and dropped in the same tab, it will return to its original position on the tab screen.

Deleting an Icon

1. Tap and hold the icon to be deleted.
2. Tap **Drop** on the pop-up menu.

...  **Note** You cannot delete the Watcher icon.

Adding an Icon

Application and file icons can be added to the Home screen.

1. Tap **Edit**, then **Add** to display the Add Application screen.

You can also select **Add** from the pop-up menu displayed by tapping and holding any portion other than the icon.

2. Tap ▼ of Application file to show the file list. If there is no desired file on the file list, you can find it by tapping **Browse**. To refer to all folders and files, tap **Browse** to show the Browse Dialog screen. When the file is selected, its name is displayed in the Application file box.

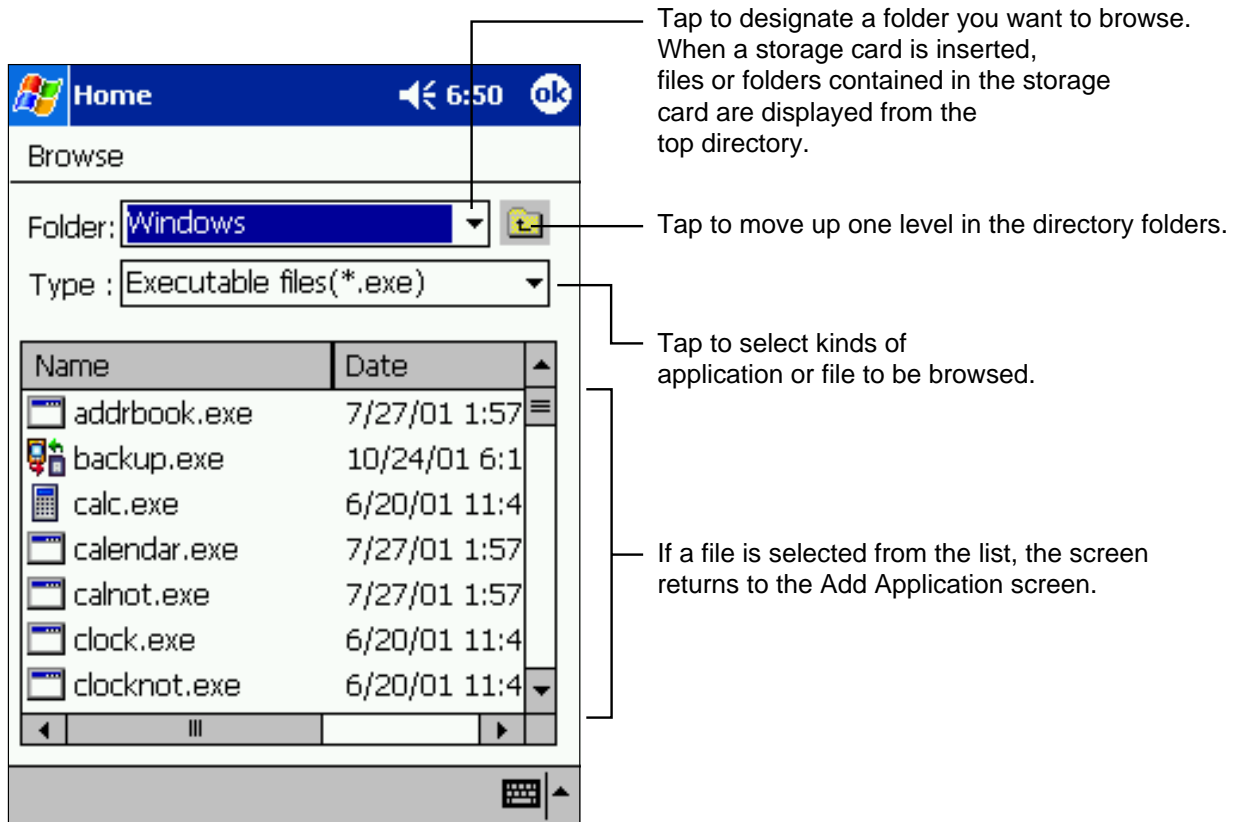

3. Enter an icon name (up to 32 characters) in the Application name box that will display on the Home screen.

4. Tap **OK** when finished.

... **Note** A new icon cannot be added if the Application file is not designated or if the Application name is not entered.

An icon added from a storage card cannot be launched unless the same card is inserted in the device.

Tab Setting

A tab can be added, deleted, or removed from the Tab Settings screen.

Adding a tab:

1. Tap **Tools**, then **Tab Settings**.
2. Tap **New** to display a text box.
3. Enter the new tab name (up to 10 characters) and tap **OK** when finished.
4. Tap **OK** on the Tab Settings screen to return to the Home screen.

Deleting a tab:

1. Tap **Tools**, then **Tab Settings**.
2. Select the tab to delete, then tap **Delete**. Tap **Yes** or **No** in the confirmation box. **All icons contained in the tab will also be deleted.**
3. Tap **OK** on the Tab Settings screen to return to the Home screen.

...  **Note** You cannot delete the Running tab or the tab containing the Watcher icon.

Changing the name of a tab:

1. Tap **Tools**, then **Tab Settings**.
2. Select the tab to be renamed and tap **Rename**.
3. Enter a new name (up to 10 characters), and tap **OK** when finished.
4. Tap **OK** on the Tab Settings screen to return to the Home screen.

...  **Note** You cannot rename the **Running** tab.

Changing a background:

1. Select the background setup tab on the Tab Settings screen, then tap **Browse** to display the Browse Dialog screen.
Even if a storage card is inserted, the files in the storage card will not be displayed.
2. Tap the desired bitmap file from the list to return to the Tab Settings screen.
3. Tap **OK** on the Tab Settings screen to return to the Home screen.

...  **Note** Only bitmap files can be set on the screen background. The displayable range of the bitmap image on the Home screen is 240 (W) X 246 (H).

Text Color Setting

To set the Text Color:

1. Tap the tab whose color you want to set to display the selected tab screen.
2. Tap **View**, then **Text Color** to display the color list.
You can set the color of the application name as desired.
3. Tap the color you want to set, and the color of the application name changes.

Backing Up

Device data can be backed up on a storage card, which can be later restored to your device. Periodical data backup is strongly recommended.

The following types of data can be backed up:

- **File:** Files created by Pocket Word, Pocket Excel, Notes or other installed programs. Other files stored in the memory.
- **Registry:** Setting information on Windows® CE or Built-in Program.
- **Database:** Microsoft® Pocket Outlook® database information.

...  **Note** Password data and other menu setup information cannot be restored.

Before backing up, restoring, or deleting a backup file, connect an AC Adapter to your device, set the Radio Standby Switch to OFF and close all applications. Do not press any button or slide the switch while the backup or restore is in progress. Otherwise, the operation of this device is not guaranteed.

If you update ROM programs using special installation programs with a *.xip extension, do not use the backup data made before updating the ROM programs.

When the system was changed, data that was backed up before the change cannot be restored.

Making a Backup

1. Insert a storage card.
2. Tap , **Programs**, then **Backup** to display the Backup screen.
3. Select **Backup** from **Functionality**.

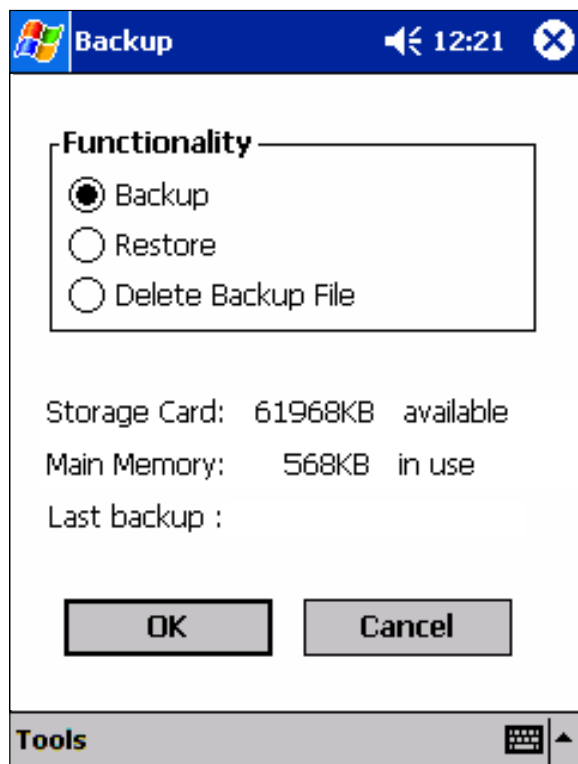

4. Tap **OK** to display the screen confirming all the applications are closed.
5. Tap **OK** to display the Backup password input screen.
6. Enter a password.



Enter a password.
You can enter a password up to 16 characters. Backup can be made even without entry of a password. If a password is entered, that password is required at the time of restore.

...  **Note** If you choose a password, do not forget it. Backup data cannot be restored without entering it.

7. Tap **OK**. The progress bar is displayed during the backup process. When the backup is completed, the backup finish message appears.
8. Tap **OK** to return to the previous screen.
9. Tap **Cancel** to close the Backup screen.

...  **Note** The backup process stops if the remaining storage card capacity runs low. Check the storage capacity before starting to back up.
If the storage card is write protected, it cannot save backup data. Cancel the write protection before backing up.

Carrying Out Restore Operation

To restore is to overwrite the backed up data from the storage card onto the main memory of your device.

- If the same file name exists in the main memory of your device, this file data is replaced with the backup data from the storage card.
 - If files exist in the main memory but not in the backup file, they will not be overwritten.
1. Insert the storage card, which contains backup data into your device.
 2. Tap , **Programs**, then **Backup** to display the Backup screen.
 3. Select **Restore** from **Functionality**.

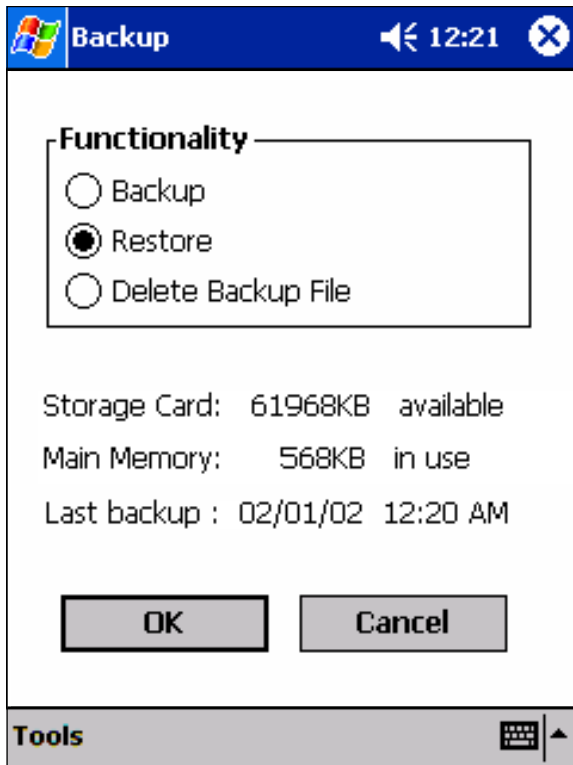

4. Tap **OK** to display the screen confirming all the applications are closed.
5. Tap **OK** to display the Restore password input screen.
6. Enter the password that was established for the backed up data. If you backed up without a password, you do not need to enter one.
7. Tap **OK**. The progress bar is displayed during the restore process.
When the restore is completed, the restore finish message appears.
8. Tap **OK**. Your device is reset and restarts automatically.

...  **Note** If your device memory becomes short of its capacity during restore, the restore process stops. Increase the memory allocation of the main memory of your device (see "Setting Memory" in "Customizing Your Device" in Chapter 2), then restart the restore procedure.

Deleting a Backup File

1. Insert the storage card, which contains backup data to be deleted.
2. Tap , **Programs**, then **Backup** to display the Backup screen.
3. Select **Delete Backup File** from **Functionality**.

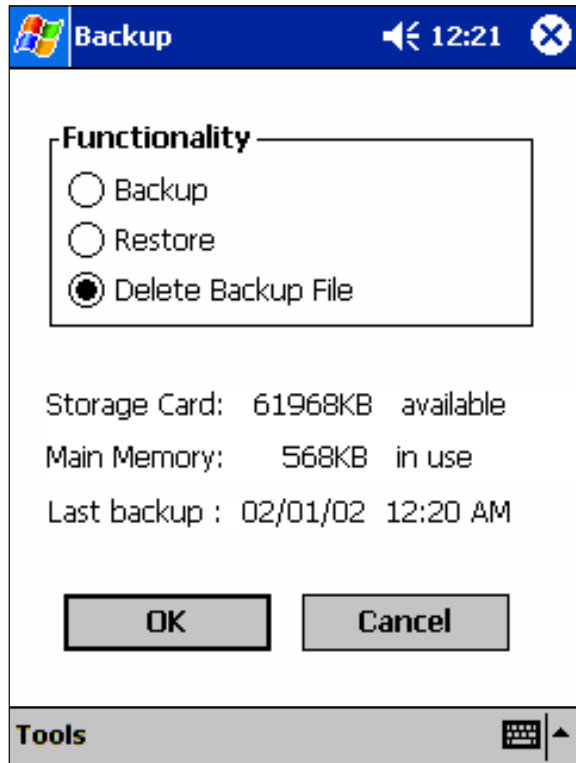

4. Tap **OK** to display the Delete Backup File confirmation screen.
5. Tap **OK** to delete the backup file.

Chapter 10

Additional Information

Resetting

Reset is equal to “Restart” on a computer. Reset only in unusual circumstances such as when the screen freezes and doesn’t respond to tapping. Information not saved prior to resetting will be deleted.

When your device is reset, phone functions are ended.

To reset, press and release the Reset Switch while the power is on. Once reset, the Today screen appears.

...  **Note** If the function cannot be restored even after resetting, initialize your device (see “Clearing Memory” on the next page).

- When the power is on, press the Reset Switch with the stylus, then release. By doing so, reset is made and the Today screen appears.

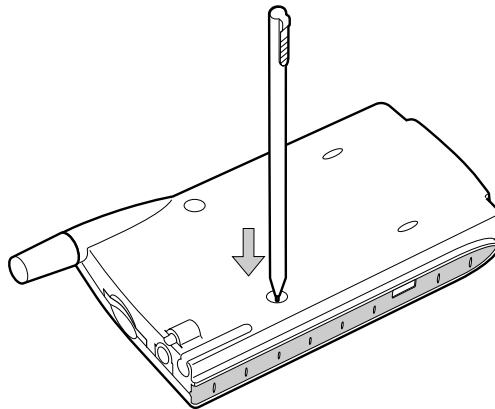

Clearing Memory (Initialization)

Initializing the device returns it to the status when it was originally purchased.

- ...  **Note** Initializing the device deletes all stored data, except built-in programs.
Before initialization, we recommend storing the memory data of the device into your computer or a storage card.
Before initialization, remove a storage card.

To initialize:

1. Turn off the power.
2. Press the Power button while pressing and holding the Reset Switch with the stylus, then release the Power button.
3. Release the Reset Switch.

When initialization is complete, the welcome screen appears. Proceed with setup.

Specifications

External dimensions	3 in. x 5 in. x 3/4 in. (excluding protrusion part) (77.5(W) x 127.5(H) x 19.5(D) mm)
Operating conditions	Temperature: 32°F to 104°F (0°C to 40°C), Humidity: 30 to 80% RH <ul style="list-style-type: none"> • Temperature capable of charging: 41°F to 95°F (5°C to 35°C) (According to the operating status, the charging may pause even when the ambient temperature is below 95°F (35°C).)
Built-in battery	Advanced Lithium Ion battery
Processor	Intel® StrongARM SA-1110 206MHz
Memory	32MB SDRAM
Display	Reflective color TFT, 240x320 pixels, 65,536 colors
Interface	
SD card slot	Possible to insert SD memory card or SDI/O card Note: The security function of the SD memory card is not usable. Data encrypted by the SD memory card security function-compatible equipment is not usable.
Infrared port	Based on IrDA Ver.1.2, Maximum data transmission speed: 115 kbps
Stereo headphone jack	ø2.5mm, five poles stereo mini plug
Cradle connection port	
AC Adapter jack	
AC Adapter	INPUT: 100-240V AC, 0.36-0.2A, 50-60Hz OUTPUT: 5V DC, 3A <ul style="list-style-type: none"> • An attached Power Supply Cable is a 125 V AC type.

Although the display is manufactured using an extremely high order of technology, there may be a case that some dots do not light or always light. It is not a malfunction.

**U.S. Food and Drug Administration - Center for Devices and Radiological Health****Consumer Update on Wireless Phones****1. Do wireless phones pose a health hazard?**

The available scientific evidence does not show that any health problems are associated with using wireless phones. There is no proof, however, that wireless phones are absolutely safe. Wireless phones emit low levels of radiofrequency energy (RF) in the microwave range while being used. They also emit very low levels of RF when in the stand-by mode. Whereas high levels of RF can produce health effects (by heating tissue), exposure to low level RF that does not produce heating effects causes no known adverse health effects. Many studies of low level RF exposures have not found any biological effects. Some studies have suggested that some biological effects may occur, but such findings have not been confirmed by additional research. In some cases, other researchers have had difficulty in reproducing those studies, or in determining the reasons for inconsistent results.

2. What is FDA's role concerning the safety of wireless phones?

Under the law, FDA does not review the safety of radiation-emitting consumer products such as wireless phones before they can be sold, as it does with new drugs or medical devices. However, the agency has authority to take action if wireless phones are shown to emit radiofrequency energy (RF) at a level that is hazardous to the user. In such a case, FDA could require the manufacturers of wireless phones to notify users of the health hazard and to repair, replace or recall the phones so that the hazard no longer exists.

Although the existing scientific data do not justify FDA regulatory actions, FDA has urged the wireless phone industry to take a number of steps, including the following:

- Support needed research into possible biological effects of RF of the type emitted by wireless phones;
- Design wireless phones in a way that minimizes any RF exposure to the user that is not necessary for device function; and
- Cooperate in providing users of wireless phones with the best possible information on possible effects of wireless phone use on human health.

FDA belongs to an interagency working group of the federal agencies that have responsibility for different aspects of RF safety to ensure coordinated efforts at the federal level. The following agencies belong to this working group:

- National Institute for Occupational Safety and Health
- Environmental Protection Agency
- Federal Communications Commission
- Occupational Safety and Health Administration
- National Telecommunications and Information Administration

The National Institutes of Health participates in some interagency working group activities, as well.

FDA shares regulatory responsibilities for wireless phones with the Federal Communications Commission (FCC). All phones that are sold in the United States must comply with FCC safety guidelines that limit RF exposure. FCC relies on FDA and other health agencies for safety questions about wireless phones.

FCC also regulates the base stations that the wireless phone networks rely upon. While these base stations operate at higher power than do the wireless phones themselves, the RF exposures that people get from these base stations are typically thousands of times lower than those they can get from wireless phones. Base stations are thus not the subject of the safety questions discussed in this document.

3. What kinds of phones are the subject of this update?

The term “wireless phone” refers here to hand-held wireless phones with built-in antennas, often called “cell,” “mobile,” or “PCS” phones. These types of wireless phones can expose the user to measurable radiofrequency energy (RF) because of the short distance between the phone and the user’s head. These RF exposures are limited by Federal Communications Commission safety guidelines that were developed with the advice of FDA and other federal health and safety agencies. When the phone is located at greater distances from the user, the exposure to RF is drastically lower because a person’s RF exposure decreases rapidly with increasing distance from the source. The so-called “cordless phones,” which have a base unit connected to the telephone wiring in a house, typically operate at far lower power levels, and thus produce RF exposures far below the FCC safety limits.

4. What are the results of the research done already?

The research done thus far has produced conflicting results, and many studies have suffered from flaws in their research methods. Animal experiments investigating the effects of radiofrequency energy (RF) exposures characteristic of wireless phones have yielded conflicting results that often cannot be repeated in other laboratories. A few animal studies, however, have suggested that low levels of RF could accelerate the development of cancer in laboratory animals. However, many of the studies that showed increased tumor development used animals that had been genetically engineered or treated with cancer-causing chemicals so as to be pre-disposed to develop cancer in the absence of RF exposure. Other studies exposed the animals to RF for up to 22 hours per day. These conditions are not similar to the conditions under which people use wireless phones, so we don’t know with certainty what the results of such studies mean for human health.

Three large epidemiology studies have been published since December 2000. Between them, the studies investigated any possible association between the use of wireless phones and primary brain cancer, glioma, meningioma, or acoustic neuroma, tumors of the brain or salivary gland, leukemia, or other cancers. None of the studies demonstrated the existence of any harmful health effects from wireless phone RF exposures. However, none of the studies can answer questions about long-term exposures, since the average period of phone use in these studies was around three years.

5. What research is needed to decide whether RF exposure from wireless phones poses a health risk?

A combination of laboratory studies and epidemiological studies of people actually using wireless phones would provide some of the data that are needed. Lifetime animal exposure studies could be completed in a few years. However, very large numbers of animals would be needed to provide reliable proof of a cancer promoting effect if one exists. Epidemiological studies can provide data that is directly applicable to human populations, but 10 or more years' follow-up may be needed to provide answers about some health effects, such as cancer. This is because the interval between the time of exposure to a cancer-causing agent and the time tumors develop - if they do - may be many, many years. The interpretation of epidemiological studies is hampered by difficulties in measuring actual RF exposure during day-to-day use of wireless phones. Many factors affect this measurement, such as the angle at which the phone is held, or which model of phone is used.

6. What is FDA doing to find out more about the possible health effects of wireless phone RF?

FDA is working with the U.S. National Toxicology Program and with groups of investigators around the world to ensure that high priority animal studies are conducted to address important questions about the effects of exposure to radiofrequency energy (RF).

FDA has been a leading participant in the World Health Organization International Electromagnetic Fields (EMF) Project since its inception in 1996. An influential result of this work has been the development of a detailed agenda of research needs that has driven the establishment of new research programs around the world. The Project has also helped develop a series of public information documents on EMF issues.

FDA and the Cellular Telecommunications & Internet Association (CTIA) have a formal Cooperative Research and Development Agreement (CRADA) to do research on wireless phone safety. FDA provides the scientific oversight, obtaining input from experts in government, industry, and academic organizations. CTIA-funded research is conducted through contracts to independent investigators. The initial research will include both laboratory studies and studies of wireless phone users. The CRADA will also include a broad assessment of additional research needs in the context of the latest research developments around the world.

7. How can I find out how much radiofrequency energy exposure I can get by using my wireless phone?

All phones sold in the United States must comply with Federal Communications Commission (FCC) guidelines that limit radiofrequency energy (RF) exposures. FCC established these guidelines in consultation with FDA and the other federal health and safety agencies. The FCC limit for RF exposure from wireless telephones is set at a Specific Absorption Rate (SAR) of 1.6 watts per kilogram (1.6 W/kg). The FCC limit is consistent with the safety standards developed by the Institute of Electrical and Electronic Engineering (IEEE) and the National Council on Radiation Protection and Measurement. The exposure limit takes into consideration the body's ability to remove heat from the tissues that absorb energy from the wireless phone and is set well below levels known to have effects.

Manufacturers of wireless phones must report the RF exposure level for each model of phone to the FCC. The FCC website (<http://www.fcc.gov/oet/rfsafety>) gives directions for locating the FCC identification number on your phone so you can find your phone's RF exposure level in the online listing.

8. What has FDA done to measure the radiofrequency energy coming from wireless phones?

The Institute of Electrical and Electronic Engineers (IEEE) is developing a technical standard for measuring the radiofrequency energy (RF) exposure from wireless phones and other wireless handsets with the participation and leadership of FDA scientists and engineers. The standard, "Recommended Practice for Determining the Spatial-Peak Specific Absorption Rate (SAR) in the Human Body Due to Wireless Communications devices: Experimental Techniques," sets forth the first consistent test methodology for measuring the rate at which RF is deposited in the heads of wireless phone users. The test method uses a tissue-simulating model of the human head. Standardized SAR test methodology is expected to greatly improve the consistency of measurements made at different laboratories on the same phone. SAR is the measurement of the amount of energy absorbed in tissue, either by the whole body or a small part of the body. It is measured in watts/kg (or milliwatts/g) of matter. This measurement is used to determine whether a wireless phone complies with safety guidelines.

9. What steps can I take to reduce my exposure to radiofrequency energy from my wireless phone?

If there is a risk from these products—and at this point we do not know that there is—it is probably very small. But if you are concerned about avoiding even potential risks, you can take a few simple steps to minimize your exposure to radiofrequency energy (RF). Since time is a key factor in how much exposure a person receives, reducing the amount of time spent using a wireless phone will reduce RF exposure.

- If you must conduct extended conversations by wireless phone every day, you could place more distance between your body and the source of the RF, since the exposure level drops off dramatically with distance. For example, you could use a headset and carry the wireless phone away from your body or use a wireless phone connected to a remote antenna.

Again, the scientific data do not demonstrate that wireless phones are harmful. But if you are concerned about the RF exposure from these products, you can use measures like those described above to reduce your RF exposure from wireless phone use.

10. What about children using wireless phones?

The scientific evidence does not show a danger to users of wireless phones, including children and teenagers. If you want to take steps to lower exposure to radiofrequency energy (RF), the measures described above would apply to children and teenagers using wireless phones. Reducing the time of wireless phone use and increasing the distance between the user and the RF source will reduce RF exposure.

Some groups sponsored by other national governments have advised that children be discouraged from using wireless phones at all. For example, the government in the United Kingdom distributed leaflets containing such a recommendation in December 2000. They noted that no evidence exists that using a wireless phone causes brain tumors or other ill effects. Their recommendation to limit wireless phone use by children was strictly precautionary; it was not based on scientific evidence that any health hazard exists.

11. What about wireless phone interference with medical equipment?

Radiofrequency energy (RF) from wireless phones can interact with some electronic devices. For this reason, FDA helped develop a detailed test method to measure electromagnetic interference (EMI) of implanted cardiac pacemakers and defibrillators from wireless telephones. This test method is now part of a standard sponsored by the Association for the Advancement of Medical Instrumentation (AAMI). The final draft, a joint effort by FDA, medical device manufacturers, and many other groups, was completed in late 2000. This standard will allow manufacturers to ensure that cardiac pacemakers and defibrillators are safe from wireless phone EMI.

FDA has tested hearing aids for interference from handheld wireless phones and helped develop a voluntary standard sponsored by the Institute of Electrical and Electronic Engineers (IEEE). This standard specifies test methods and performance requirements for hearing aids and wireless phones so that no interference occurs when a person uses a “compatible” phone and a “compatible” hearing aid at the same time. This standard was approved by the IEEE in 2000.

FDA continues to monitor the use of wireless phones for possible interactions with other medical devices. Should harmful interference be found to occur, FDA will conduct testing to assess the interference and work to resolve the problem.

12. Where can I find additional information?

For additional information, please refer to the following resources:

- FDA web page on wireless phones (<http://www.fda.gov/cdrh/phones/index.html>)
- Federal Communications Commission (FCC) RF Safety Program (<http://www.fcc.gov/oet/rfsafety>)
- International Commission on Non-Ionizing Radiation Protection (<http://www.icnirp.de>)
- World Health Organization (WHO) International EMF Project (<http://www.who.int/emf>)
- National Radiological Protection Board (UK) (<http://www.nrpb.org.uk/>)



AUDIOVOX COMMUNICATIONS CORP.

555 Wireless Blvd., Hauppauge, New York 11788, 800-229-1235
16808 Marquardt Avenue, Cerritos, California 90701, 562-802-5100

<http://www.audiovox.com>

Free Manuals Download Website

<http://myh66.com>

<http://usermanuals.us>

<http://www.somanuals.com>

<http://www.4manuals.cc>

<http://www.manual-lib.com>

<http://www.404manual.com>

<http://www.luxmanual.com>

<http://aubethermostatmanual.com>

Golf course search by state

<http://golfingnear.com>

Email search by domain

<http://emailbydomain.com>

Auto manuals search

<http://auto.somanuals.com>

TV manuals search

<http://tv.somanuals.com>