

Installation / Warranty

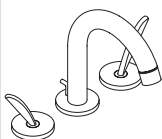

Starck
10133XX1

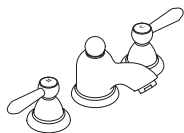

Carlton
17125XX1

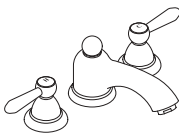

Carlton
17135XX1

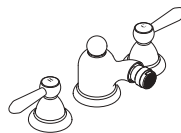

Carlton
17235XX1

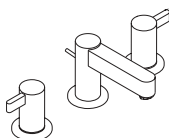

Steel
35033801



Allegroh
36135XX1



Terrano
37135XX1



Terrano
37136XX1



Terrano
37235XX1



Phoenix
17104XX1

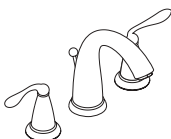

Phoenix
17105XX1

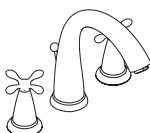

Phoenix
17114XX1

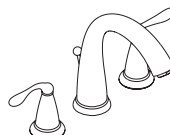

Phoenix
17115XX1

AXOR[®]
hansgrohe

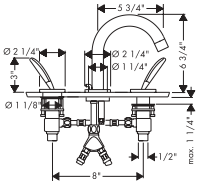

Starck
10133XX1

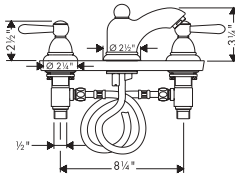

Carlton
17125XX1

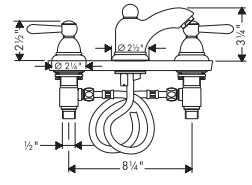

Carlton
17135XX1

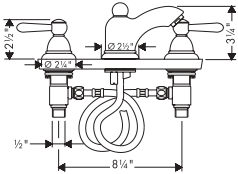

Carlton
17235XX1

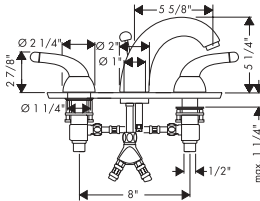

Allegroh
36135XX1

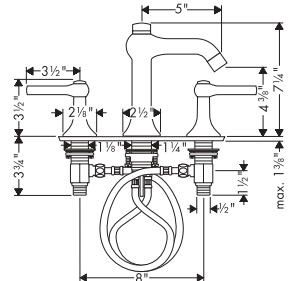

Terrano
37135XX1

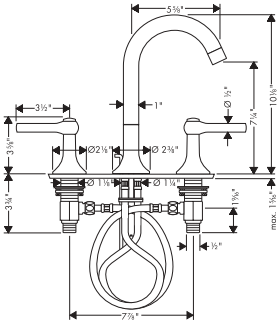

Terrano
37136XX1

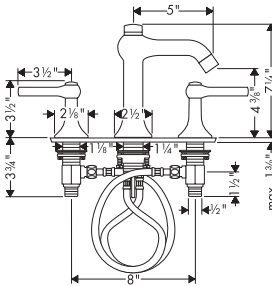

Terrano
37235XX1

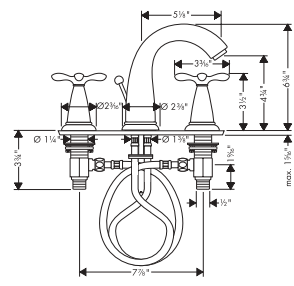

Phoenix
17104XX1

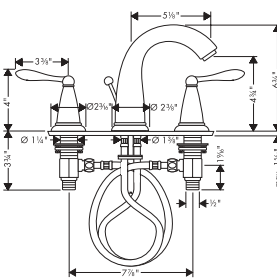

Phoenix
17105XX1

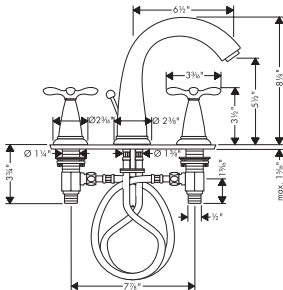

Phoenix
17114XX1

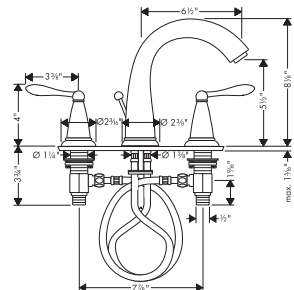

Phoenix
17115XX1

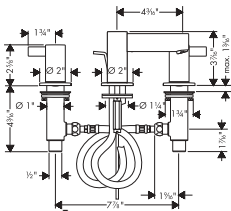

Steel
35033801

Technical data

Hole size in deck Spout:	min. 1 1/4" max. 1 5/8"
Hole size in deck Valve:	min. 1 1/8" max. 1 1/4"
Operating pressure:	max. 147 psi
Recommended operating press.:	14.7 - 72.5 psi
Test pressure:	232 psi
Hot water temperature:	max. 176° F
Recommended hot water temp.:	149° F

Assembly

1. Flush pipe lines thoroughly.
2. Mount spout and valves onto lavatory. The hot water supply (red point on valve) should be connected to the LHS and the cold on the RHS.
3. Screw pop-up rod onto the pop-up rod extending from faucet.
4. **Starck/Alleghro:**
Attach compression "Y" onto bottom of spout fitting. Screw in stainless steel flex hose connectors into "Y" and onto side outlet of hot and cold valves.
Carlton/Phoenix/Terrano/Steel:
Connect flex hose with valves.
5. Attach handle trim and connect pop-up assembly.
6. Turn on supply stops and check function of faucet.
7. Check all connections for leakage.

Major pressure differences between cold and hot water in supply should be avoided and balanced.

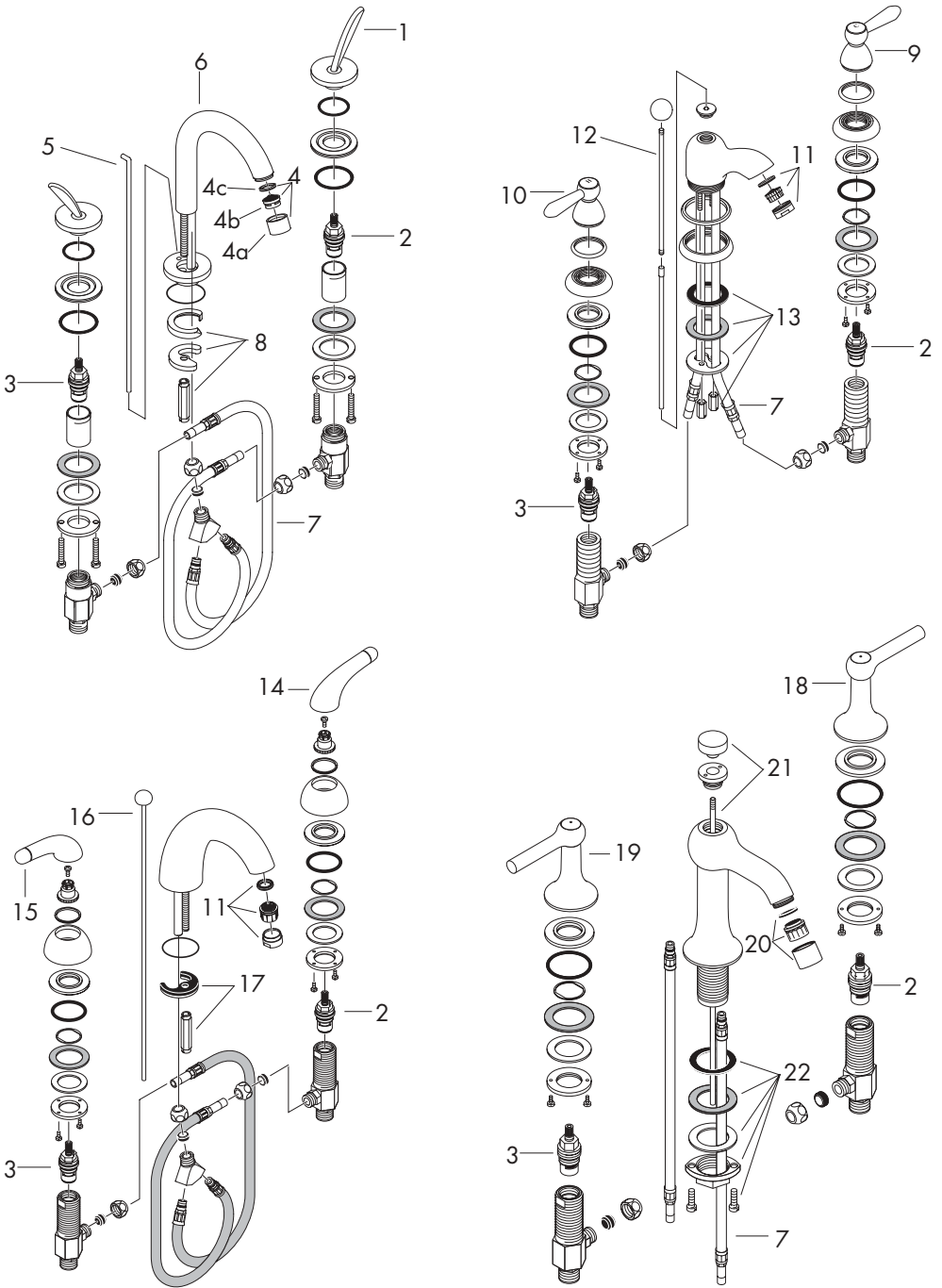

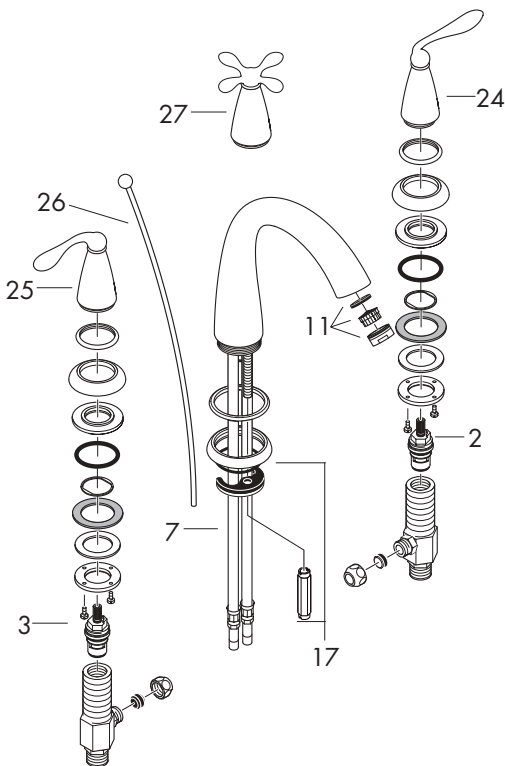

Spare parts

1	Handle	10091XX0
2	Stop unit for cold water	96765000
3	Stop unit for warm water	96766000
4	Aerator	94010XX0
4a	Aerator casing	10072868
4b	Sieve	10235710
4c	Gasket	90328910
5	Lift rod	94083XX0
6	Spout cpl.	94014XX0
7	Tube	94071000
8	Fixation cpl.	94701000
9	Handle for cold water	17296XX0
10	Handle for warm water	17295XX0
11	Aerator	13085000
12	Lift rod	94028XX0
13	Fixation cpl.	94138000
14	Handle for cold water	36192XX0
15	Handle for warm water	36191XX0
16	Lift rod	92620XX0
17	Fixation cpl.	96016000
18	Handle for cold water	37296XX0
19	Handle for warm water	37295XX0
20	Aerator	96336XX0
21	Lift rod	96335XX0
22	Fixation cpl.	13961000
23	Spout	96521XXX
24	Handle for cold water	96629XX1
25	Handle for warm water	96628XX1
26	Lift rod	92620XX0
27	Handle for warm/cold water	96793XX1

XX = Color code:

Starck/Terrano/Phoenix

- 00 chrome
- 81 satinox

Carlton/Allegroh

- 00 chrome
- 09 chrome/gold
- 93 polished brass

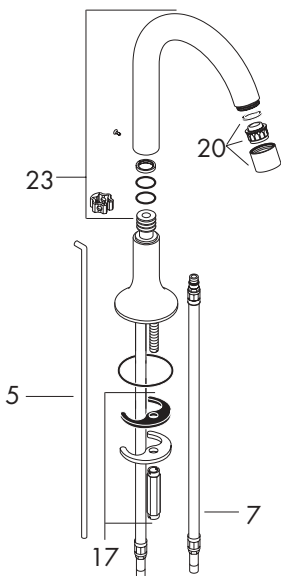

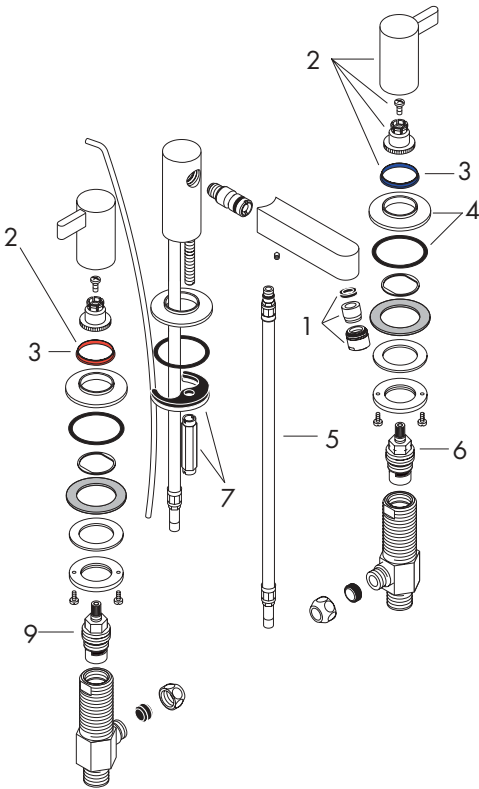

Spare parts

1	Aerator cpl.	96683800
2	Handle cold / hot water	35293800
3	Color-ring cold / hot water	97127000
4	Escutcheon	97128800
5	Tube	94071000
6	Stop unit for cold water	96765000
7	Fixation cpl.	96016000
8	Lift rod	96657800
9	Stop unit for warm water	96766000

Cleaning Recommendation for Hansgrohe Products

Modern faucetry and shower products utilize a combination of materials to comply with the needs of the market with regard to design and functionality.

To avoid damage, it is necessary to use some caution when cleaning. Damage caused by improper treatment is not covered under the Hansgrohe warranty.

Cleaning Materials for Faucets and Showers

- To remove lime scale, use only products made specifically for that purpose. Always follow the manufacturer's instructions when using.
- Do not use cleaners that contain hydrochloric, formic, acetic, or phosphoric acids, as these will cause considerable damage to finishes and to plastic components.
- Never mix cleaning materials.
- Never use cleaners containing abrasives. Do not use abrasive cleaning cloths, pads, or sponges.

Cleaning Procedures

- Clean your faucets and shower products as and when required. Regular cleaning will prevent scale buildup and water spotting.
- Follow the label instructions. Do not allow any cleaner to remain on the product for longer than necessary.
- When using spray cleaners, spray first onto a sponge or cloth – do not spray directly onto the product.
- After cleaning, rinse thoroughly with clear water to remove any cleaner residue.

Important

- Soap and shampoo residue can also cause damage to the product. Rinse well with clean water after use.
- If the surface is already damaged, harsh cleaning materials will cause further damage.

Limited Lifetime Consumer Warranty

This product has been manufactured and tested to the highest quality standards by Hansgrohe, Inc. ("Hansgrohe"). This warranty is limited to Hansgrohe products which are purchased by a consumer in the United States after March 1, 1996, and installed in either the United States or Canada.

WHO IS COVERED BY THE WARRANTY

This warranty extends to the original consumer purchaser only.

WHAT IS COVERED BY THE WARRANTY

The warranty covers only your Hansgrohe manufactured product. Hansgrohe warrants this product against defects in material or workmanship as follows: Hansgrohe will repair at no charge for parts or labor or, at its option, replace any product or part of the product which proves defective because of improper workmanship and/or material, under normal installation, use, service and maintenance. If Hansgrohe is unable to provide a replacement and repair is not practical or cannot be timely made, Hansgrohe may elect to refund the purchase price in exchange for the return of the product.

LENGTH OF THE WARRANTY

Replacement of repaired parts of products will be covered for the term of this warranty as stated in the following two sentences. If you are a consumer who purchased the product for use primarily for personal, family or household purposes, this warranty extends for as long as you own the product and the home in which the product is installed. If you purchased the product for use primarily for any other purpose, including, without limitation, a commercial purpose, this warranty extends only (i) for 1 year with respect to Interaktiv products, and (ii) for 5 years, with respect to Axor and Pharo products.

THIS WARRANTY DOES NOT COVER, AND HANSGROHE WILL NOT PAY FOR:

- A. Conditions, malfunctions or damage not resulting from defects in material or workmanship.
- B. Conditions, malfunctions, or damage resulting from (1) improper installation, improper maintenance, misuse, abuse, negligence, accident or alteration, or (2) the use of abrasive or caustic cleaning agents or "no rinse" cleaning products, or the use of the product in any manner contrary to the product instructions.
- C. Labor and other expenses for disconnection or return of the product for warranty service, or for installation or reinstallation of the product.
- D. Accessories or related products not manufactured by Hansgrohe.

TO OBTAIN WARRANTY SERVICE

Contact your Hansgrohe retailer, or write to Technical Service at:

Hansgrohe Inc.
1492 Bluegrass Lakes Parkway
Alpharetta GA 30004

Or call Hansgrohe toll-free at (800) 334 0455.

In requesting warranty service, you will need to provide:

1. The sales receipt or other evidence of the date and place of purchase.
2. A description of the problem.
3. Delivery of the product or the defective part, postage prepaid, and carefully packed and insured, to Hansgrohe Inc. 1492 Bluegrass Lakes Parkway, Alpharetta Georgia 30004, Attention: Technical Service, if required by Hansgrohe.

When warranty service is completed, any repaired or replacement product or part will be returned to you postage prepaid.

**EXCLUSIONS AND LIMITATIONS
REPAIR OR REPLACEMENT (OR, IN LIMITED CIRCUMSTANCES, REFUND OF THE PURCHASE PRICE) AS PROVIDED UNDER THIS WARRANTY IS THE EXCLUSIVE REMEDY OF THE PURCHASER. HANSGROHE NEITHER ASSUMES NOR AUTHORIZES ANY PERSON TO CREATE FOR IT ANY OTHER OBLIGATION OR LIABILITY IN CONNECTION WITH THIS PRODUCT.**

HANSGROHE SHALL NOT BE LIABLE TO PURCHASER OR ANY OTHER PERSON FOR ANY INCIDENTAL, SPECIAL, OR CONSEQUENTIAL DAMAGES, ARISING OUT OF A BREACH OF THIS WARRANTY OR ANY IMPLIED WARRANTY (INCLUDING MERCHANTABILITY).

Some States do not allow the exclusion or limitation of incidental or consequential damages, so the above limitation or exclusion may not apply to you.

This warranty gives you specific legal rights, and you may also have other rights which vary from state to state.

You may be required by law to give us a reasonable opportunity to correct or cure any failure to comply before you can bring any action in court against us under the Magnuson-Moss Warranty Act.

PRODUCT INSTRUCTIONS AND QUESTIONS

Upon purchase or prior to installation, please carefully inspect your Hansgrohe product for any damage or visible defect. Prior to installing, always carefully study the enclosed instructions on the proper installation and the care and maintenance of this product. If you have questions at any time about the use, installation or performance of your Hansgrohe product, or this warranty, please call or write to us at the toll-free number and address provided above.

hansgrohe

AXOR | PHARO

Hansgrohe Inc.
1490 Bluegrass Lakes Parkway
Alpharetta GA 30004

Free Manuals Download Website

<http://myh66.com>

<http://usermanuals.us>

<http://www.somanuals.com>

<http://www.4manuals.cc>

<http://www.manual-lib.com>

<http://www.404manual.com>

<http://www.luxmanual.com>

<http://aubethermostatmanual.com>

Golf course search by state

<http://golfingnear.com>

Email search by domain

<http://emailbydomain.com>

Auto manuals search

<http://auto.somanuals.com>

TV manuals search

<http://tv.somanuals.com>