

B & K Components, Ltd.

REFERENCE 50 SERIES 2

User Manual

**Seven Channel Surround
A/V Preamplifier Processor**

USER MANUAL - Reference 50 Series 2

© 2004 B&K Components Ltd. All rights reserved.

The information in this manual is copyright protected. No part of this manual may be copied or reproduced in any form without prior written consent from B&K Components, Ltd.

B&K Components Ltd. SHALL NOT BE LIABLE FOR OPERATIONAL, TECHNICAL OR EDITORIAL ERRORS/OMISSIONS MADE IN THIS MANUAL. The information in this manual is subject to change without prior notice.

Accessories Included



- | | |
|---------------------------|-----------------------------|
| 1 - SR10.1 Remote Control | 1 - Warranty Card |
| 1 - AM Antenna | 1 - User Manual |
| 1 - FM Dipole Antenna | 1 - Serial to RJ-45 Adapter |
| 1 - Power Cord | 1 - BKcSuite CD-ROM |

SIMPLY BETTER! is a registered trademark of B&K Components, Ltd. Manufactured under license from Dolby Laboratories. "Dolby", "Surround EX", "Pro Logic" and the double-D symbol are trademarks of Dolby Laboratories. Manufactured under license from Digital Theater Systems, Inc. US Pat. No.5,451,942, 5,956,674, 5,974,380, 5,978,762, 6,487,535 and other U.S and worldwide patents issued and pending. "DTS", "DTS-ES" and "Neo:6" trademarks of Digital Theater Systems, Inc. Copyright 1996, 2003 Digital Theater Systems, Inc. All Rights Reserved. Motorola®, * DigitalDNA™, "Powered by Motorola™", Motorola name and logo are registered trademarks of Motorola, Inc. All Rights Reserved.

Limited Warranty

B&K Components Ltd., referred to herein as B&K, warrants your B&K equipment against all defects in material and workmanship for a period of five years from the date of purchase. This warranty applies only to the original purchaser and only to equipment in normal residential use and service. Defective equipment must be returned to B&K, prepaid, accompanied by proof of purchase and sufficient payment to cover the cost of return shipping and handling, and will be repaired or replaced at the discretion of B&K whose decision as to the method of reparation will be final.

This warranty shall not apply to any equipment which is found to have been improperly installed, incorrectly fused, misused, abused, or subjected to harmful elements, used in any way not in accordance with instructions supplied with the unit, or to have been modified, repaired or altered in any way without the expressed, written consent of B&K. This warranty does not apply to the cabinet or appearance items such as the faceplate or control buttons, nor does it cover any expenses incurred in shipping the unit to and from the manufacturer's service department.

This warranty on B&K Components, Ltd. products is NOT VALID if the products have been purchased from an unauthorized dealer or an E-tailer or if the original factory serial number has been removed, defaced or replaced in any way. B&K Components, Ltd. sells its products through authorized dealers in order to ensure that consumers obtain proper dealer service and support. Buying from an authorized B&K Components, Ltd. dealer insures that you have a FACTORY WARRANTY on your B&K Components, Ltd. product. If you have any questions concerning your Factory Warranty call B&K Components, Ltd. at 716-656-0026.

Upgradeability : B&K is one of the first manufacturers in the audio/video industry to consistently offer software and hardware upgrades to its processing of audio signals. Through upgrades B&K delivers exceptional value to its customers. But what is "upgradeability"? Upgradeability is not a guarantee; we define it as a philosophy of designing and manufacturing products so that as audio technology evolves, B&K can provide enhancements and improvements to its products that are economically viable.

THE EXPRESS FACTORY WARRANTY HEREIN CONTAINED IS IN LIEU OF ANY AND ALL OTHER WARRANTIES, EXPRESSED OR IMPLIED, INCLUDING ANY WARRANTY OF MERCHANTABILITY, UPGRADEABILITY OR OF FITNESS FOR ANY PARTICULAR PURPOSE. B&K COMPONENTS, LTD. SHALL NOT UNDER ANY CIRCUMSTANCES BE LIABLE FOR DAMAGES, INCLUDING SPECIAL, INCIDENTAL, EXEMPLARY, PUNITIVE OR CONSEQUENTIAL DAMAGES ARISING OUT OF OR IN CONNECTION WITH THE PURCHASE, USE OR PERFORMANCE OF ANY B&K PRODUCT.

This warranty gives you specific legal rights. You may also have other rights which vary from State to State. Some States do not allow the exclusion or limitation of incidental or consequential damages and the foregoing exclusions may not apply to you.

No agent, representative, dealer or employee of B&K has the authority to increase or alter the obligations or terms of this warranty.

Returning Equipment

No equipment may be returned to B&K Components Ltd. without a RETURN AUTHORIZATION (RA). Should you find it necessary to return equipment to B&K, for any reason, a RETURN AUTHORIZATION (RA) number must be issued by B&K in respect to the equipment being returned. You may request an RA number by calling B&K at the numbers below. We will need the following information to issue your RA number. Please have it ready before you call.

1. Your name, address, and phone number.
2. The model and serial number of the equipment being returned.
3. A description of the problem being experienced.
4. Your sales receipt.

Your call will be referred to a Technical Service Representative who will work with you to resolve the problem. If it is determined that the unit must be returned for repair, an RA number will be issued.

2100 Old Union Road Buffalo, NY 14227 1-800-543-5252 In NY: 716-656-0026 fax: 716-656-1291
e-mail: info@bkcomp.com Web Site: www.bkcomp.com

| | |
|---|----|
| ACCESSORIES AND LIMITED WARRANTY..... | ii |
| TABLE OF CONTENTS..... | 1 |
| SAFETY PRECAUTIONS..... | 3 |
| FEATURES..... | 4 |
| AUDIO OVERVIEW..... | 5 |
| AUDIO AND SURROUND FORMATS..... | 6 |
| FRONT PANEL DESCRIPTION..... | 10 |
| BACK PANEL DESCRIPTION..... | 11 |
| QUICK START CONSIDERATIONS..... | 12 |
| HARDWARE CONNECTIONS..... | 13 |
| SOURCE CONNECTIONS..... | 13 |
| Source Connection Diagram..... | 13 |
| SACD or DVD-Audio Connection..... | 13 |
| VIDEO MONITOR CONNECTION..... | 14 |
| Component Video Monitor Connection..... | 14 |
| S-Video Monitor Connection..... | 14 |
| Composite Video Monitor Connection..... | 14 |
| SURROUND OUTPUT CONNECTIONS..... | 15 |
| 7.1 Balanced Output Connection..... | 15 |
| 6.1 / 5.1 Balanced Output Connection..... | 16 |
| RCA Surround Outputs / Subwoofer Connection..... | 17 |
| PASS THROUGH / RECORD LOOP CONNECTIONS..... | 18 |
| CONTROL OUTPUT CONNECTION..... | 18 |
| IR Emitter Connection..... | 18 |
| +12VDC Control Connection..... | 19 |
| ZONE B CONNECTIONS..... | 19 |
| Zone B Audio Amplification..... | 19 |
| Zone B Video Connection..... | 19 |
| REFERENCE 50 Series2 ZONE B CONNECTION DIAGRAM..... | 20 |
| KEYPAD CONNECTION..... | 21 |
| ZONE A & ZONE B IR CONNECTIONS..... | 21 |
| AM / FM ANTENNA CONNECTION..... | 21 |
| SETTING UP THE SYSTEM..... | 22 |
| THE MENU SYSTEM..... | 22 |
| MAIN MENU SELECTIONS..... | 23 |
| SYSTEM SETUP..... | 24 |
| SETUP SPEAKERS..... | 25 |
| 1. Speaker Size..... | 25 |
| 2. Setup Speaker Location..... | 26 |
| 3. Setup Speaker Levels..... | 26 |
| 4. Setup Crossover + LFE..... | 26 |
| 5. Setup Room Equalization..... | 27 |
| 6. Room Resonance (Notch Filters)..... | 27 |
| SETUP INPUTS..... | 29 |
| SETUP PRESETS..... | 30 |
| SETUP DISPLAYS..... | 31 |
| SETUP MUSIC MODES..... | 31 |
| MEMORY BACKUP/RESTORE..... | 31 |
| UNIT INFORMATION..... | 32 |
| ADVANCED MENU..... | 32 |
| Zone '1' Home Theater..... | 33 |
| Power on Titles..... | 34 |
| Control Outputs..... | 34 |

| | |
|--|------|
| DSP Usage..... | 35 |
| Security Options..... | 35 |
| RS-232 Control Port..... | 36 |
| Plug and Play Timing Setup..... | 37 |
| Zone 2 'B' Second Zone..... | 38 |
| FACTORY RESET..... | 38 |
| SR10.1 REMOTE CONTROL OPERATION..... | 39 |
| UNIT OPERATION..... | 40 |
| Master Power On / Off..... | 40 |
| On / Standby..... | 40 |
| Adjusting Volume..... | 40 |
| Center, Rear and Subwoofer Volume..... | 40 |
| Source Selection..... | 40 |
| Z1 Operation - Theater..... | 41 |
| Sleep Timer..... | 41 |
| Z2 Operation - Second Zone..... | 41 |
| Zone Operation Button..... | 41 |
| AM / FM Tuner Operation..... | 42 |
| Headphone Operation..... | 42 |
| FRONT PANEL DISPLAY OPERATION..... | 43 |
| Processor Status..... | 43 |
| AUDIO MODES & SPEAKER SELECTIONS..... | 45 |
| Audio Mode Usages..... | 45 |
| Speaker Selections..... | 47 |
| EQUALIZATION SETTINGS AND ADJUSTMENTS..... | 48 |
| PRESETS..... | 49 |
| Saving a Preset..... | 49 |
| Recalling a Preset..... | 51 |
| Favorite Presets..... | 51 |
| SR10.1 REMOTE EDITOR SOFTWARE..... | 51 |
| Learning IR Codes..... | 53 |
| BKcSuite SETUP SOFTWARE..... | 54 |
| Troubleshooting Guide For BKcSuite..... | 55 |
| TROUBLESHOOTING..... | 56 |
| BACK PANEL PICTURE..... | 57 |
| ON SCREEN MENU FLOW CHART..... | 58 |
| SPECIFICATIONS..... | Back |

Product Information

| | |
|------------------------|------------------------------|
| Date of Purchase: | _____ |
| Preamplifier Model #: | <u>Reference 50 Series 2</u> |
| Preamplifier Serial #: | _____ |
| Purchased From: | _____ |
| Address: | _____ |
| | _____ |
| Phone #: | _____ |



CAUTION
RISK OF ELECTRIC SHOCK
DO NOT OPEN



SAFETY PRECAUTIONS

WARNING: to prevent fire or shock hazard, do not expose this unit to rain or moisture. Care should be taken to prevent objects or liquid from entering the enclosure. Never handle the power cord with wet hands.

- The lightning flash with arrowhead within a triangle is intended to alert the user of the presence of uninsulated "dangerous voltage" within the product's enclosure that may constitute a risk of electric shock to you.
- The exclamation point within a triangle is intended to alert the user of the presence of important operating and maintenance (servicing) instructions in the literature accompanying the unit.
- Caution: To prevent the risk of electric shock, do not remove cover. No user-serviceable parts inside. Refer servicing to qualified service personnel.
- If an outdoor antenna is installed, be sure it is grounded to provide some protection against voltage surges and built up static charges. Keep outdoor antennas away from power lines.
- Unplug the preamplifier from the AC outlet when plugging in or unplugging cables, when left unused for an extended period of time, when moving the preamplifier, or when you suspect lightning in your area.
- Prevent damage to the power cord. Replace the power cord if it becomes damaged in any way. Always grasp the plug on the power cord when plugging or unplugging the preamplifier from the AC outlet.
- Your system may produce sound levels capable of causing permanent hearing loss. Do not operate for extended periods of time at high volume levels.
- Protect the preamplifier from impact and place the preamplifier on a level surface.
- The preamplifier is equipped with raised feet to provide ventilation, reduce acoustic feedback, and protect against scratching the surface the unit is resting on. B & K advises against removing the feet.
- Do not stack anything on top of the preamplifier (processor, source, etc.) **Leave a minimum of 3"** clearance from the top of the preamplifier to the next shelf (or component).
- The preamplifier should be located away from sources sensitive to heat.
- Do not perform any internal modifications to the preamplifier.
- Always connect the preamplifier's power cord to a dedicated AC outlet for normal operation.
- If young children are present, adult supervision should be provided until the children are capable of following all rules for safe operation.
- Mistaking CONTROL OUTPUT or IR INPUT connectors for audio/video inputs or outputs may damage your preamplifier or other components.
- System impedance **SHOULD NOT** fall below the nominal impedance of the amplifier stage, i.e two 8Ω speakers in parallel = 4Ω (system impedance). Minimum stability refers to the periodic audio passages that demand large amounts of current at which time the output impedance drops.

The preamplifier should be serviced by qualified personnel when:

- A. The preamplifier is not functioning properly.
- B. Objects have entered the chassis.
- C. The preamplifier was exposed to rain or any other type of moisture.
- D. The preamplifier was dropped, or the chassis is damaged.

FEATURES

The Reference 50 Series2 preamplifier is a versatile Audio/Video control center. This preamplifier is designed to sound sensational and be an attractive, easy-to-use addition to your Audio/Video system.

Video Transcoding - Allows composite and S-Video inputs to source the composite, S-Video and component video outputs. Composite video will transcode to S-Video and S-Video will transcode to composite. Video transcoding allows a single set of component video cables to be used with a video monitor.

Balanced Outputs - 7.1 balanced surround outputs are provided for superior transmission of audio material to the power amplification stage.

Balanced Inputs - Two Balanced source inputs are provided for superior transmission of audio material for up to two source components.

Room Equalization (Notch Filters) - Three sweepable notch filters and variable equalization are available in the digital domain for use in achieving the best possible room response.

Motorola™ 371  Processor - The latest in Motorola™ technology provides outstanding processing power.

Two-zone operation - One main digital & analog A/V zone, (Theater Zone) plus a separate independent analog A/V zone for use with a second listening/viewing area (2nd zone).

CK1.2 Keypad Compatible - B&K's CK1.2 Keypad easily integrates with the B&K processor/preamplifier for control of the main theater zone or the second A/V Zone B.

Sleep Timer - 30 minutes to 4 hours in 30 minute increments.

5 Year Parts and Labor Warranty - For all B&K products sold through authorized dealers.

Gold Plated Connectors - Improved sound with minimum signal loss and degradation.

Internal Digitally Synthesized AM/FM Stereo tuner - Store up to 40 AM or FM stations in A/V presets.

Digital inputs/outputs - Six coaxial and five optical inputs. Two coaxial outputs (Theater zone & Second zone) and one optical output for the Theater zone.

Analog inputs/outputs - Seven A/V inputs each with stereo audio, composite video and S-video inputs. One assignable SACD or DVD-Audio input. One set of 7.1 line-level outputs. Three analog (record) loop outputs.

Control Outputs - Four 12 VDC @ 50 mA outputs for turning on (triggering) B&K amplifiers and controlling external systems such as a projection screen. Up to three control outputs can be configured for IR outputs to allow integration with a keypad or IR repeater control system.

IR inputs - Two IR inputs for keypads or external IR repeater control systems.

A/V presets - 40 preset memories allow instant recall of user settings and system configuration.

Customized Input and Preset Names - Assign custom names to presets, inputs, and the power on message.

RS-232 Control - Easy control and interface of your B&K product with other system controllers.

96/24 bit A/D and 192/24 bit capable D/A Conversion - Ultra high reproduction resolution of musical details.

96/24 Bit Processing - 96/24 bit digital data and analog source material use 96 kHz, 24 bit DSP processing during all stereo listening modes.

Selectable Bass Management Crossover Frequency and Slope - Allows system versatility for bass adjustments and management to assure superior performance from your speaker system. Shelving equalization adjustments can be made to either end of the response frequency spectrum to further enhance the listening room for optimal playback.

Upgradeable - Modular design allows for future A/D, D/A, DSP, and Digital Preamplifier upgrades. State of the art today, state of the art tomorrow.

AUDIO / VIDEO OVERVIEW

Definitions

Sources - A source is considered to be any device that can be connected to the audio/video receiver or processor and transmit a signal that can be seen or heard. Typical sources include DVD players, satellite boxes, CD players, etc. Your preamplifier can provide audio from its built-in AM/FM tuner. Your preamplifier is designed to accommodate a wide range of audio and video signals.

Zone - A zone is usually a room or section of the house that has speakers and/or video installed in it. Your preamplifier includes a full preamp/processor for Zone A, the main theater zone, plus an additional analog audio and video preamp for Zone B - the second zone. Two zones allow for watching a Dolby Digital movie in the main theater while simultaneously using the built-in AM/FM tuner in the second zone.

Amplifier - An amplifier takes the output of a pre-amplifier/processor and increases its levels necessary to drive a speaker. In a receiver the amplifier is combined into the same box with the processor. B&K employs high current amplifiers in their receivers. These amplifiers are also available as separate components.

Speakers - A surround sound system typically uses 5 speakers located left front, center front, right front, right surround, and left surround plus a subwoofer located anywhere in the room. With the new developments in surround technology from companies such as Dolby Laboratories and DTS, it is now possible to improve spatial expressions with an additional channel of information for use with a 6th or 7th surround back speaker(s). Although best results are achieved using seven large speakers plus a subwoofer, this is not always practical. Excellent results can be achieved using small and/or fewer speakers, as long as you go through the setup procedures described later in the manual. Your processor includes the capability of reproducing up to 7.1 channels of surround information.

A/V Preamplifier - An A/V preamplifier has the capability to select from a number of A/V sources, adjust volume levels and route the audio to an amplifier and video to a video monitor. An A/V preamplifier requires the use of an external power amplifier.

Surround Processor - A processor typically includes the capability to decode one or more surround formats, and convert between digital and analog as required. Your A/V preamplifier includes a high quality Motorola™ processor capable of decoding the various audio surround formats.

Composite video vs. S-video vs. Component video - Composite video is the oldest standard for color video. It combines the luminance (brightness or black-and-white) and chrominance (color) information onto a single conductor. At the monitor, this *composite* video signal must be separated again for its display which results in *some* degradation of the original video quality. S-video is a standard that uses separate conductors for the luminance (Y) and chrominance (C) information resulting in better video quality. Component video is a form of video which first became popular with the introduction of the DVD player. Most component video signals are a variation of the red, green and blue signals that make up a television image. The simplest type, RGB, consists of the three discrete R, G & B signals sent over three video cables. Another type consists of R-Y, B-Y and Y (also known as YUV), sent over three video cables. Y is the luminance channel, R-Y is the red component minus the luminance information, and B-Y is the blue component minus the luminance information. Your preamplifier is capable of switching composite, S-video and component video signals, and converting between signal types. Your A/V preamplifier is capable of transcoding composite video and S-video to component YUV video signals.

Transcoding - Video transcoding is the process of converting one video format to another. Video transcoding is a new technology brought about by the need to integrate these many different video formats. Video transcoding does not change the resolution of the original video signal and allows different video formats to be viewed on one video monitor. Video transcoding research is being driven by the need to integrate video technologies pertaining to computer networks, cell phone, PDAs, television and satellite. Your A/V preamplifier is capable of transcoding composite video and S-video to component YUV signals.

Analog vs. Digital Audio - This refers to the method used to place audio information on the source material and how they are delivered to your preamplifier from the source. Analog signals exactly represent the sound you will hear through a continuously varying voltage. Audio cassettes are analog recordings and are normally delivered to your preamplifier over a pair of coaxial audio cables.

Digital signals closely approximate the original audio signals with a set of numbers referred to as a bitstream. CDs and DVDs are sources of digital audio and are normally connected to your preamplifier through a single coaxial or optical digital cable. There are several different bitstream formats available. The simplest format is called Pulse Code Modulation (PCM). In PCM, the bitstream directly represents the original 2-channel audio. In Dolby Digital and DTS (see "Audio and Surround Formats" below) bitstreams are modified using a process called compression to squeeze more information into limited space. DTS squeezes 5.1 channels into the space normally required for two uncompressed channels, while Dolby Digital squeezes 5.1 channels into about $\frac{1}{4}$ the space required for two channels. Your preamplifier automatically detects the bitstream currently being provided from the source and performs the required decompression and surround processing. If no digital signal is present your preamplifier will automatically switch to analog processing. All sounds that you hear from your speakers are analog. Digital signals are automatically converted to analog by your preamplifier before being output to the speakers.

If analog signals exactly represent the audio, while digital signals only approximate it, why would I want to use digital?

All analog sources add some amount of noise and distortion to the audio signal. Additional noise can be picked up through the cables from the source to your preamplifier. It is impossible for the preamplifier to tell the difference between the desired signal and the added noise and distortion, so it reproduces both of them. The result is increased background noise and decreased dynamic range and fidelity. Digital signals are virtually immune to noise and distortion. The preamplifier can, therefore, reproduce the signal with the greatest possible fidelity. We recommend you use digital signals whenever possible. Also Dolby Digital and DTS (see "Audio and Surround Formats" below) work only with digital signals.

AUDIO AND SURROUND FORMATS

Your source material will be played back on your B&K processor in one of the following possible formats described below. Each format can be used for various listening conditions.

Monaural (Mono) - Mono is the oldest format available. It contains a single, full range audio channel. Modern recordings are seldom made in this format, however older movies and music may only be available in this format. You may get mono from any source - digital or analog. Your preamplifier can produce mono in one to seven channels depending on speaker and audio setup. Since all modern sources are stereo, the mono information is usually replicated on both the left and right channels.

Stereo - Stereo contains two discrete, full-range front left and right audio channels. This is the most common format for music and is also used on many movies. You may get stereo from any source - digital or analog. Sound will normally come from the seven speaker channels, but your preamplifier can produce stereo in two to seven channels, depending on speaker and audio setup.

Dolby Digital 5.1 - Dolby Digital 5.1 is a method of transmitting and storing 5.1-channel soundtracks via digital media such as DVDs, digital cable, digital broadcast TV (DTV), and satellite transmissions. Dolby Digital 5.1 is transmitted over the optical digital or coax digital connections. Unlike the Dolby Surround encode/decode Pro Logic process, which sacrifices channel separation to get surround onto any stereo soundtrack, Dolby Digital 5.1 is a discrete system that keeps the multiple channels fully separated throughout the encoding and decoding processes. In addition to having full-range front left, center, right, left surround, and right surround channels, Dolby Digital 5.1 soundtracks carry a sixth (".1") channel recorded with low-frequency effects. For more information on Dolby Laboratories, please visit www.dolby.com.

Dolby Digital Surround EX - Dolby® Digital Surround EX™ provides a third surround channel on Dolby Digital movie soundtracks. The third surround channel can be decoded at the cinema's or home viewer's option for playback over surround speakers located behind the seating area. The left and right surround channels are reproduced by surround speakers to the sides. To maintain compatibility, the back surround channel is matrix-encoded onto the left and right surround channels of an otherwise conventional 5.1 mix, so no information is lost when the film is played in conventional 5.1.

A 5.1-channel soundtrack can be played on a 5.1-speaker system. But it is not always understood that it can also be played on a 6.1- or a 7.1-speaker system. To do this, the two surround signals on the 5.1 soundtrack are spread across the three or four surround speakers. This distribution can be accomplished by a Dolby Digital EX decoder, or other proprietary methods provided in home theater equipment by various manufacturers.

Dolby Pro Logic II - Pro Logic II brings exciting features and advanced performance for decoding the many thousands of existing Dolby Surround programs, making them sound more like a discrete Dolby Digital 5.1-channel version than ever before. Pro Logic II is able to decode the thousands of existing Dolby Surround movies and TV shows already on the shelf, compatibly, and with enhanced image stability. The improvements in decoding techniques mean that the discreteness of the sound field elements are better preserved in the decoding process than was possible with the standard Pro Logic technology. Pro Logic II offers a music mode to expand stereo non-matrix recordings into a five-channel layout in a way that does not diminish the subtlety and integrity of the original stereo recordings.

Dolby Pro Logic IIx - Dolby Pro Logic IIx is a new extension of Dolby Pro Logic II technology. This highly sophisticated algorithm processes native stereo audio signals and 5.1-channel multi-channel content to produce 6.1 or 7.1 output channels. Dolby Pro Logic IIx expands the choice in playback system configuration (allowing 5.1, 6.1, or 7.1 playback channels) and, when incorporated into an A/V receiver or processor such as B&K, it allows a convenient upgrade path from a traditional 5.1-channel sound system to 7.1 output channels. The surround back channels are decoded into stereo

Center width - The Center Width control allows the user to modify the amount of steering that is applied to Center signals. As steering is reduced, the Center signal originates increasingly from the Left and Right speakers, and is concurrently reduced in the Center speaker. The purpose of the Center Width control is to reduce the "hard Center channel" phenomenon that sometimes results from Center signal steering of stereo encoded soundtracks.

Panorama - The function of the Panorama mode is to create a more enveloping front surround field. It is equally useful when applied to Dolby Pro Logic IIx processing.

Movie or Music - Surround programs are primarily movie based. Even TV dramas are essentially mixed like movies. When programs are mixed in surround, they are monitored through the surround decoder that will be used for playback in the cinema or home. Movie mode is the reference decoder mode for any such surround-encoded program.

Music, on the other hand, is commonly mixed for stereo playback, and no surround monitoring is done by the mixer. When played back through a surround decoder, the results may not always be optimal. This is because a movie-type decoder is expecting a signal that has been deliberately surround encoded. Music mode brings the benefits of a highly natural and balanced multichannel surround sound field to content that was not specifically encoded for surround playback.

DTS 5.1 (Digital Theater Systems) - DTS is a multi-channel digital audio compression format transmitted over optical digital or coaxial digital connections. DTS is dedicated to delivering the "Ultimate Entertainment Experience." DTS has created a media-delivery format that makes audio tracks sound more dynamic, more realistic and more closely matching the original than other digitally encoded soundtracks and consumer media. Coupled with the multi-dimensional playback benefit of surround sound technology, DTS audio quality dramatically improves and enhances content. DTS 5.1 is an ultra realistic home theater environment, it delivers discrete channel precision plus the all-enveloping realism for which DTS is renown. For more information on the various DTS formats, visit www.DTSonline.com.

DTS NEO:6 - An advanced matrix decoder. It will take any two-channel source and expand it into five or six channels, depending on the user's speaker layout. Two-channel sources include VHS tapes, broadcast television, stereo CDs and DVDs. DTS Neo:6 provides separate, optimized modes for stereo music materials and matrix surround motion picture soundtracks. DTS Neo:6 also decodes a center-surround channel from Extended Surround matrix soundtracks. Music and movie filters can be applied to the NEO:6 decoder. The differences between these two filters apply primarily to the differences in the type of soundtrack being played back.

DTS-ES 6.1 (Extended Surround) - The Extended Surround (ES) adds a discrete back center-surround channel to the existing 5.1-channel array. DTS-ES Discrete 6.1 is the only home format that can deliver 6.1 discrete channels. DTS-ES is fully compatible with all types of multi-channel systems. All sounds will be heard even when played back on a system with less than 6.1 speakers

DTS Neo:6 Movie - Movie steers decoded material toward the center channel while preserving the integrity of the stereo mix. When listening to movies using the DTS Neo:6 movie decoder with stereo TV shows or other surround-encoded programs, there is further enhancement to soundfield directionally, which is close to the quality of discrete 6.1-channel sound. Conventional narrow band monaural surround channel is played as stereo with a more realistic feel and movement.

DTS Neo:6 Music - Music steers the effects into the soundfield by utilizing the surround channels for a more spacious, 3-dimensional feeling. When listening to music using the DTS Neo:6 music decoder, stereo music recordings are able to provide a wide and deep soundfield. DTS Neo:6 music decoder allows you to tailor the Center Image to your own preference. The Center Image control allows the sound of the center channel to be placed between its own speaker and the left and right front speakers.

Bass Management - Dolby Digital and DTS-ES formats may contain up to 6 full range channels plus an LFE (Low Frequency Effects) channel. Only a system with six full-range (large) speakers plus a subwoofer can directly reproduce these formats. However, almost all commercially available center channel speakers and bookshelf speakers are considered small and incapable of reproducing the lowest bass frequencies without distortion or even damage to the speaker. Many people use small speakers in the rear of their system, while others use small speakers for all channels. Some people may choose not to use a center channel or surround speakers at all. Use of a subwoofer is mandatory when using small speakers to reproduce low frequencies. In order to handle any possible combination of large, small, or missing speakers, a home theater system must contain good bass management. Your B&K preamplifier contains a complete bass management system. You can use as few as two large (full range) front left and right speakers or two small front left and right speakers. Wherever a small speaker is used, the bass management system filters low frequency information from going to that speaker ("high pass"). This bass information is re-routed to a speaker that can handle it, usually a subwoofer. If no subwoofer is present, it can send the low frequency and LFE to large front or surround speakers. The bass management crossover point can be adjusted by the user according to the types of speakers being used.

Notch Filters (Parametric Equalization)- Notch filters are used to enhance the frequency response of a given room. The full range frequency spectrum in an ideal scenario is completely flat. This means that there is no variation in the decibel level between any of the frequencies as you sweep up or down the frequency range. This type of response is almost impossible to achieve. Due to the physical geometry of any given room, the sound waves will bounce off walls, doors or windows within the room. This reflection of sound

waves is a desirable effect to a point. Different locations in the room will have waves that collide with one another. This collision can cause a superposition (addition or subtraction) of the audible wavelength. In either case, these locations are referred to as nodes. If a positive node occurs in the primary listening position, that frequency drowns out all other frequencies at that location, resulting in limited frequency response for that location in the room. A node can occur at any frequency, however nodes are much more prevalent in the lower frequency ranges (below 130Hz). In these lower frequencies, the wavelengths are physically long enough that a superposition can have a more dramatic effect than frequencies at a higher (shorter) wavelength. A notch filter provides a means by which the preamplifier can effectively 'notch' out resonant frequencies to achieve a balanced frequency response for a given room. Once the frequency response has been returned to its reference level, a fuller, more dynamic audio reproduction can be heard. B&K supports three separate notch filters for the frequency range of 20 Hz to 300Hz.

DVD-Audio (also referred to as MLP) - DVD-Audio (also referred to as MLP™) - Meridian^R Lossless Packing. MLP™ is a lossless compression system for high-quality linear PCM audio. For DVD-Audio MLP™ performs lossless compression of 1 to 6 channels of 14 to 24-bit material sampled at rates between 32kHz and 192kHz. With lossless compression, the decompressed signal is bit-for-bit identical to the master, just 'packed' into a lower data rate which ultimately results in a reduced size to be stored on the disc. Currently, DVD-Audio can only be delivered to your preamplifier via the analog 5.1 inputs. Sound will normally come from your front left, front right, center, left surround, and right surround speakers, as well as your subwoofer, but your processor can produce sound in one (mono) to seven channels. Dolby Pro Logic IIx is used to matrix the surround back left and surround back right channels if a seven channel configuration is used.

SACD (Super Audio CD) - Is a new audio recording format aimed at providing higher fidelity audio reproduction than the compact disc. It was developed by Sony™ and Philips™. The sound of SACD comes directly from Direct Stream Digital (DSD) recording technology. SACD disks generally contain a 2-channel stereo mix. Many also contain a 5.1 surround sound mix. DSD's simplified mechanism for recording and playback results in a frequency response over 100kHz and a dynamic range over 120dB across the audible frequency range. DSD increases the resolution of music by more closely following the original wave form of the music, which results in music reproduction that is remarkably pure and faithful to the original. For additional information concerning the technology behind SACD, visit Sony Electronics SACD.

Cinema Processing - Cinema is an exclusive set of standards and technologies that can be applied to any B&K surround mode. In a typical movie theater the front left, right, and center speakers are located behind the screen. The screen tends to block high frequency information. Therefore, movie soundtracks often have boosted high frequency content to compensate for the effects of the screen. This boost can cause some soundtracks to sound overly bright in a home theater where speakers are typically not behind a screen. B&K cinema mode adjusts the front left, right, and center frequency response to compensate for the boost applied for the movie theater.



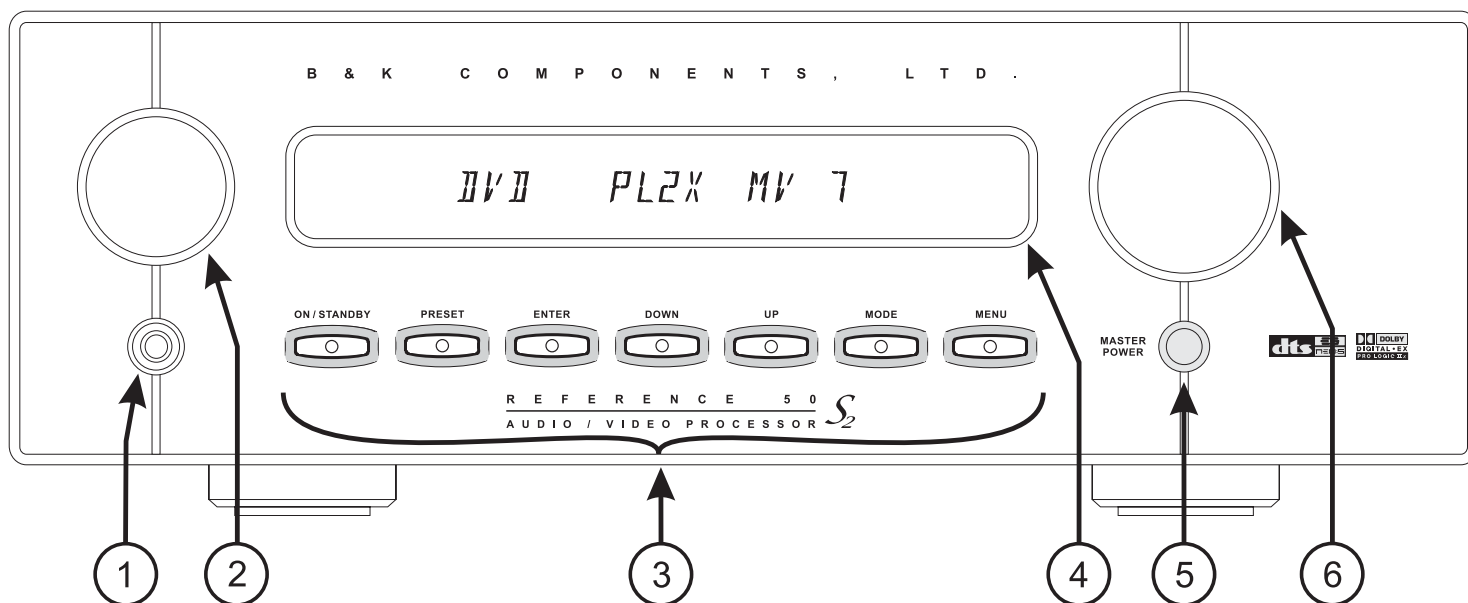



High Current Amplifiers - A high-current amplifier is capable of delivering power into low impedance speakers without going into protection and/or shutting down. Ideally, an amplifier's output power would double every time the load presented at its output is halved. In a typical amplifier-speaker circuit, voltage and current are delivered to a very complex load consisting of speaker drivers, resistors, inductors, and capacitors. Voltage may be thought of as the potential to do work, and current as what actually flows to do the work. Although basic power may be calculated by the simple multiplication of voltage and current, it is the delivery of the power from the amplifier to the complex speaker load that accounts for why two amplifiers may have the same power rating into identical impedances (speaker loads), but deliver a significantly different sound quality. Some of these sound quality differences may include perceived loudness, depth, and clarity. High quality speakers can have nominal impedances from 8 - 2 Ohms. During very loud and dynamic audio passages, the speaker load may dip below 2 Ohms. These low impedance drops may cause a high voltage power amplifier with limited power storage capacity to sound harsh and distorted. A high-current amplifier operates with much less effort and typically does not have any problem with low impedance speakers. B&K amplifiers and receivers are High Current Power amplifiers.



1. Headphone Jack - Headphones having a standard ¼" (6.3mm) stereo plug can be connected to the headphone output.

2. Source Selector - Turning the selector clockwise or counterclockwise will cycle through the available inputs. Available inputs are V1, V2, TV, DVD, CD, SAT, TAPE, FM and AM.

3. Front panel buttons -

| | |
|--|--|
|  ON/STANDBY | Toggles the preamplifier in and out of standby mode, (ON or OFF). |
|  PRESET | Cycles through audio presets for instant preset recall. |
|  ENTER | Confirm Selection. Presets, menu options, unit status. |
|  DOWN & UP | Steps through audio options or menu selections when in the menu system. Allows AM/FM tune - (down) or tune + (up). |
|  MODE | Steps through audio modes |
|  MENU | Enters into and out of the menu system. |

4. Display - The preamplifier display contains a 16 character display. It will display current status of the preamplifier and any changes being performed.

5. Main power switch - Removes all power to the preamplifier. *Normal operation of the preamplifier requires the power switch to remain on.* Use the ON/STANDBY button for daily on and off of the preamplifier. ON/STANDBY places the unit in standby mode that allows turning back on with the remote control. Only turn the preamplifier off with the main power switch when not using the preamplifier for an extended period of time.

6. Volume control - Turning the volume control clockwise increases the volume level, counterclockwise decreases the volume level. The volume knob is also used to change other preamplifier settings.

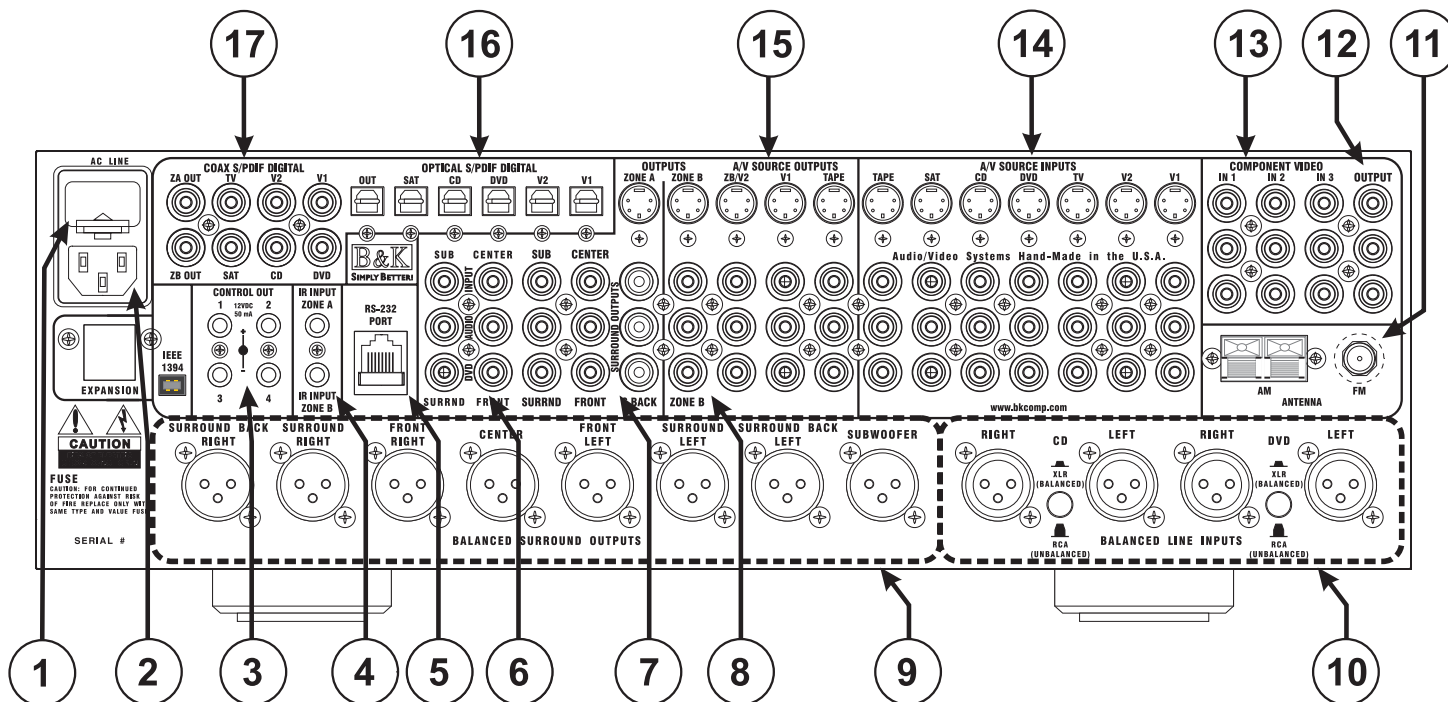

1. **AC fuse holder** - Holds the AC Line fuse. Replace only with same type and value - .5 amp Fast Blow. Note: The voltage rating label is located on the AC fuse holder cover plate.
2. **AC input receptacle** - For attaching the supplied AC power cord to the preamplifier.
3. **Four 10-12VDC @ 50mA Control Outputs** - 1/8" (3.5mm) mono mini plug. Trigger outputs for controlling external devices, such as amplifiers, projection screens, IR emitter, etc. [Page 18](#).
4. **ZA & ZB IR Data Input** - Accepts IR from an external IR source. Internally summed.
5. **Main RJ-45 jack** - RS-232 input/output for computer interface and RS-232 controller applications. A B&K CK1.2 keypad can also be connected to the RJ-45 jack. [Page 36](#).
6. **DVD-Audio 5.1 inputs** - Connections for a DVD-Audio or other 5.1 analog source device. [Page 13](#).
7. **RCA Surround outputs** - 7.1 Outputs for driving external power amplifiers or powered speakers. [Page 17](#).
8. **Zone B Output** - Line outputs for supplying the second zone. Configurable fixed or variable. [Page 19](#).
9. **Balanced Surround (XLR) outputs** - Connections for 7.1 speakers in the main theater zone. [Page 15](#).
10. **Balanced Source (XLR) Inputs** - The CD and/or DVD inputs can accommodate a balanced input signal.
11. **Antenna inputs** - Connections for the AM and FM antennas. [Page 21](#).
12. **Component Video output** - Component video pass through. Transcoded component video output. [Page 14](#).
13. **Component Video inputs** - Three assignable component video inputs. [Page 14](#).
14. **A/V Source inputs** - Seven sources can be connected using analog audio, composite video or S-Video.
15. **A/V Source record outputs** - Tape loop outputs will provide analog audio / video source signals for zone A or Zone B recording. [Page 18](#).
16. **Optical SPDIF Digital** - Optical digital connections for connecting optical digital audio signals from the source to the preamplifier. 5 optical digital inputs, 1 digital output. [Page 13](#).
17. **Coax SPDIF Digital** - Coax digital inputs are used to connect coax digital audio signals from the source to the preamplifier. 6 coax digital inputs, 2 digital outputs. [Page 13](#).

QUICK START CONSIDERATIONS

Your B&K preamplifier is pre-programmed for ease of operation right out of the box. In general, there is minimal setup required to start using your new A/V preamplifier. To quickly setup and begin operating your preamplifier, follow these quick steps:

- 1 Start with all AC power cords unplugged from their designated AC outlet.
- 2 From each source device, connect the A/V cables to the appropriate A/V SOURCE INPUTS on the preamplifier's back panel.
- 3 Connect the audio cables from the preamplifier's OUTPUTS to the power amplifier INPUTS.
- 4 Connect the appropriate video cables from the preamplifier's video OUTPUTS to the video monitor's input(s).
- 5 Plug each AC power cord into its designated AC outlet.
- 6 Turn on the main power switch on the front of each unit. On the preamplifier, press the ON/STANDBY button on the front panel, or the ON button of the remote. Turn on all A/V sources.
- 7 Select a source with the SR10.1 remote control or front panel source control of the preamplifier.
- 8 For use with a component video monitor, please see Setup Inputs [page 30](#), Component Video Assignment.

The rest of this manual will describe in detail the many aspects of your new preamplifier. Some additional installation considerations should be noted as follows:

- It is important that your electronic equipment has proper ventilation. Failure to ventilate your preamplifier could result in erratic operation and possible failure caused by overheating. A minimum of 3" clearance should be maintained above the preamplifier. Do not place items directly on top of the preamplifier. Do not place flammable items on, around or near the A/V equipment (Curtains, paper, etc.).
- B&K supports various software programs that are able to aide in the setup process of the receiver/ preamplifier, SR10.1 remote and CK1.2 Keypad. This software is available online at B&K's website at www.bkcomp.com or by request from B&K's customer service. The setup software is easy to use and is intended to simplify the setup process of your new B&K products.
- Configure a system diagram of all components that are to be connected into the system. The preamplifier has seven sets of inputs. Even though the back panel is labeled for specific sources, in most cases it is possible to connect any source to any input. For example, if you have a satellite receiver you can connect it to the V2 input and it will work the same way as connecting it to the SAT input. Select V2 instead of SAT. The source name that will appear on the preamplifier's front panel and on the remote or keypad can be relabeled to match the source equipment that is being used.
- Determine the type of cable that is needed. Keep in mind that the quality of the cabling that is used can make a difference in the overall audio and video quality. Try to keep interconnecting cable runs as short as possible. When routing cables between equipment, be sure to keep AC cables separate from audio cables. It is a good idea to bundle like cables together to keep interference (noise) to a minimum.
- Decide on what types of audio and video signals are going to be used in the system. Determine the length of the cable for each component's connection and how it should be routed. It is a good idea to label each cable with a name or number at both ends when allocating each cable. Have all the cables you need before you begin the installation because it is inconvenient to run to the store when you are excited to hear what the system will sound like.
- Plan enough cable length and space to allow future access to the back panel.
- For best tuner reception, make sure the antenna is several feet away from the preamplifier and any other equipment that may produce high frequency interference such as personal computers, CD players, halogen lamps, etc.
- For best performance it is recommended that a dedicated AC power line or supply be used for the best audio reproduction. If the equipment is installed in a rack, be sure to insulate the equipment from the rack itself.

SOURCE CONNECTIONS

Your preamplifier supports several A/V input and output formats. In most cases only one audio and one video connection is needed for each source device. Shown below are the available options:

Analog audio (Stereo): left and right.

Digital audio: either coaxial or optical.

DVD-Audio & Super Audio CD (SACD): Analog 5.1

Composite video: coaxial (Yellow RCA).

Super-Video: S-Video.

Component video: Red, Green & Blue.

Connect an audio / video source to the surround preamplifier. Use the diagrams that follow as a guide for each of the seven source inputs. For analog audio connections, use the left and right (white and red) RCA connections. For composite video, use the yellow RCA connections. For S-video use the S-video connections. For digital audio, use EITHER the coaxial digital connection (orange RCA) or the optical digital connection per each source. The order of audio signal precedence per each input is: Optical Digital > Coax Digital > Analog left and right. For component video, use the red, green and blue RCA component connections. See Video Monitor Connection [page 14](#) for details on connecting a video monitor.

If the second zone of the surround preamplifier or the record loop outputs are going to be used, the analog audio and composite video and/or S-video signals must be connected to the surround preamplifier. The preamplifier will neither process nor convert digital audio or component video for use in the the second zone.

Source Connection Diagram

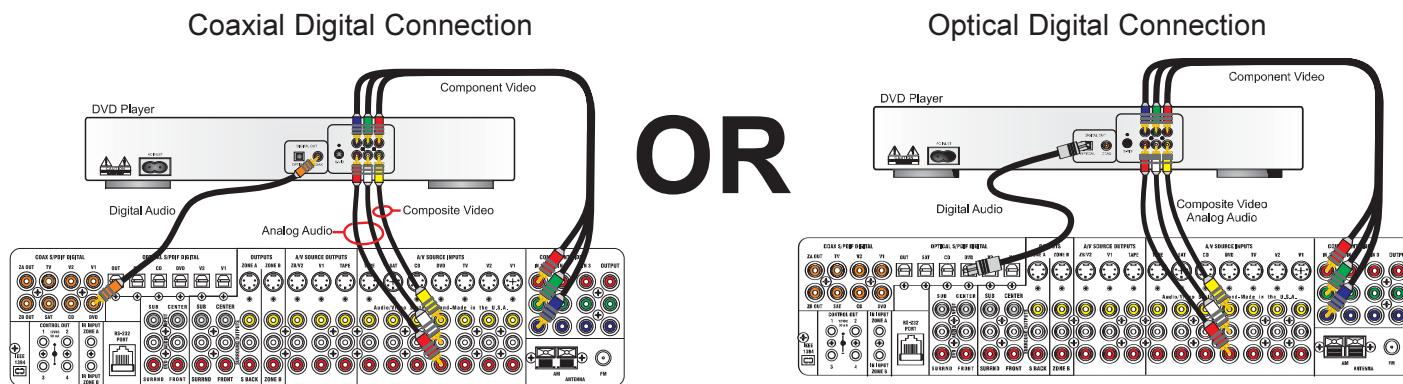

SACD or DVD-Audio Connection

DVD-Audio or SACD is a discrete 5.1 channel analog audio mode. If the source gear contains connections for DVD-Audio or SACD, use the DVD-Audio input connections on the back panel of the surround preamplifier. The DVD-Audio input can be assigned to any source input except Tape (see Setup Inputs [page 29](#)). Be sure to maintain the discrete channel connections. Each channel is labeled appropriately according to the speaker location in the room.

Many times, DVD-Audio players have multiple configuration options. The preamplifier does not supply bass or delay management for the DVD-Audio/SACD input. You should adjust your player's bass and delay management to match that of the preamplifier.

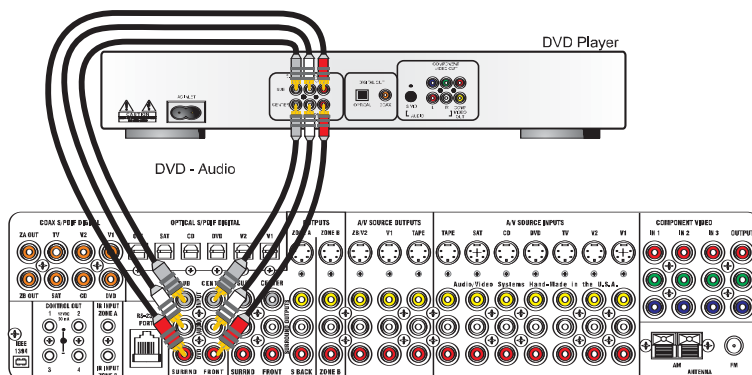

VIDEO MONITOR CONNECTION

There are many types of video monitors that can be used with your B&K system. Some popular video monitors are televisions, plasma screens, LCD screens and projectors. The B&K A/V processor has video and audio switching capability. The system source devices should be connected to the B&K processor for both audio and video. One set of video cables may be connected from the B&K preamplifier's component video OUT to the video monitor. The B&K video processor features video transcoding. Video transcoding allows multiple video formats to be combined onto one. Transcoding will not change the resolution of the image. Specifically composite video is transcoded to S-video (S) and component video. S-video is transcoded to composite video and component video. Component video is not transcoded. The On Screen Setup Menu is available in all three video formats. B&K recommends using the component video inputs for High Definition source signals.

Component Video Monitor Connection

The B&K surround preamplifier provides three sets of component video inputs and one component video output. Since there are seven A/V inputs and only three component inputs, the preamplifier must be configured for which component input to use with the selected A/V source. For example, component Input 1 is assigned to DVD, whenever DVD is selected, the component output will come from component Input 1. Composite to S or S to composite transcoding will continue to function for the DVD input. Component video is not transcoded to composite or S. If no component assignment is made to a particular input, the component output will be transcoded from the appropriate composite or S-video input. The preamplifier automatically detects the presence of composite or S-Video. No user assignment is necessary.

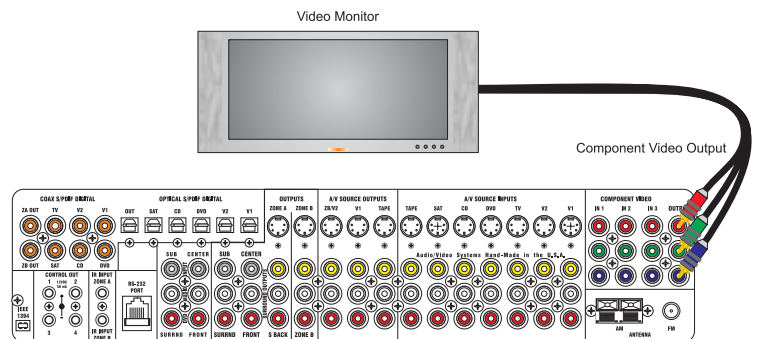

IMPORTANT: By factory default, all component video inputs are unassigned. For use with component video sources, HDTV receivers or progressive scan DVD players, each COMPONENT VIDEO must be assigned for use with an A/V SOURCE INPUT (page 29) to operate correctly.

S-Video Monitor Connection

Each of the seven A/V inputs are provided with an S-video input. There is an S-video output for each zone of the surround preamplifier. Zone A output will pass through S-Video or transcode from composite video. Zone B S-video output will provide output only from S-video inputs - there is no transcoding for Zone B. The Line Output section provides S-video outputs for recording devices in Zone A or Zone B. S-Video record outputs provide output only from S-video inputs - there is no video transcoding for the record outputs.

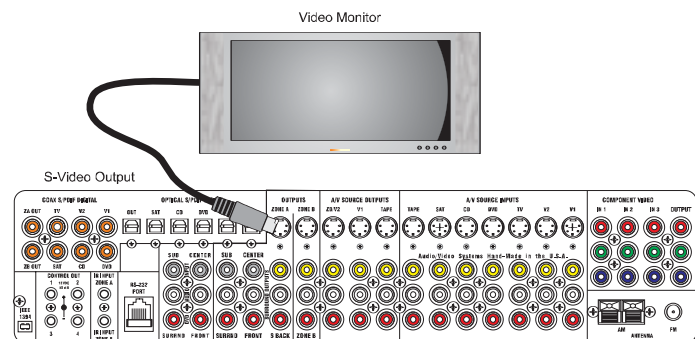

Composite Video Monitor Connection

Each of the seven A/V inputs are provided with a composite RCA video input (yellow). There is a composite RCA video output for each of the zones of the surround preamplifier. Zone A video output will pass composite video through or transcode from S-video. Zone B composite video output will provide output only from composite video inputs - there is no transcoding of video in Zone B. The Line Output section provides composite outputs for recording devices used in Zone A or Zone B. The composite video record outputs provide output only from composite video inputs - there is no video transcoding with the record outputs.

SURROUND OUTPUT CONNECTIONS

Your B&K preamplifier has two types of surround outputs: balanced (XLR) outputs and coaxial (RCA) outputs. Both types of outputs connect from the preamplifier directly to the amplifier in the system. Either type of connection can be used when connecting to the external amplifier. When connecting audio cables to the amplifier, be sure to match the labeled output channel to the position of the speaker in the room.

7.1 balanced surround outputs are provided. Each balanced connector will click when locked in place. To release, push in on the silver tab and unplug the balanced connector. Be sure to pull on the plug and not the wire. Eight coaxial (RCA) surround outputs are provided. The RCA output section on the back panel is labeled Surround Outputs. See [page 17](#) for a connection diagram using the coaxial connections.

For best acoustic results, be sure to set up the speakers using the speaker setup menu. To Setup System Speakers see [page 25](#).

7.1 Balanced Output Connections

To connect a 7.1 or 7.0 audio system using balanced cabling, see the connection diagram below. All seven surround outputs should be connected to the amplifier. The point one (.1) indicates whether or not the system will use a subwoofer. If a subwoofer is used, the Reference 50 Series2 has two subwoofer outputs, one balanced (XLR) Subwoofer out and one coaxial (RCA) Subwoofer out, either can be used for connecting a subwoofer into the audio system. If a subwoofer is going to be used, connect the subwoofer cable from the subwoofer output to the subwoofer. The diagram below illustrates using a balanced cable to connect a powered subwoofer.

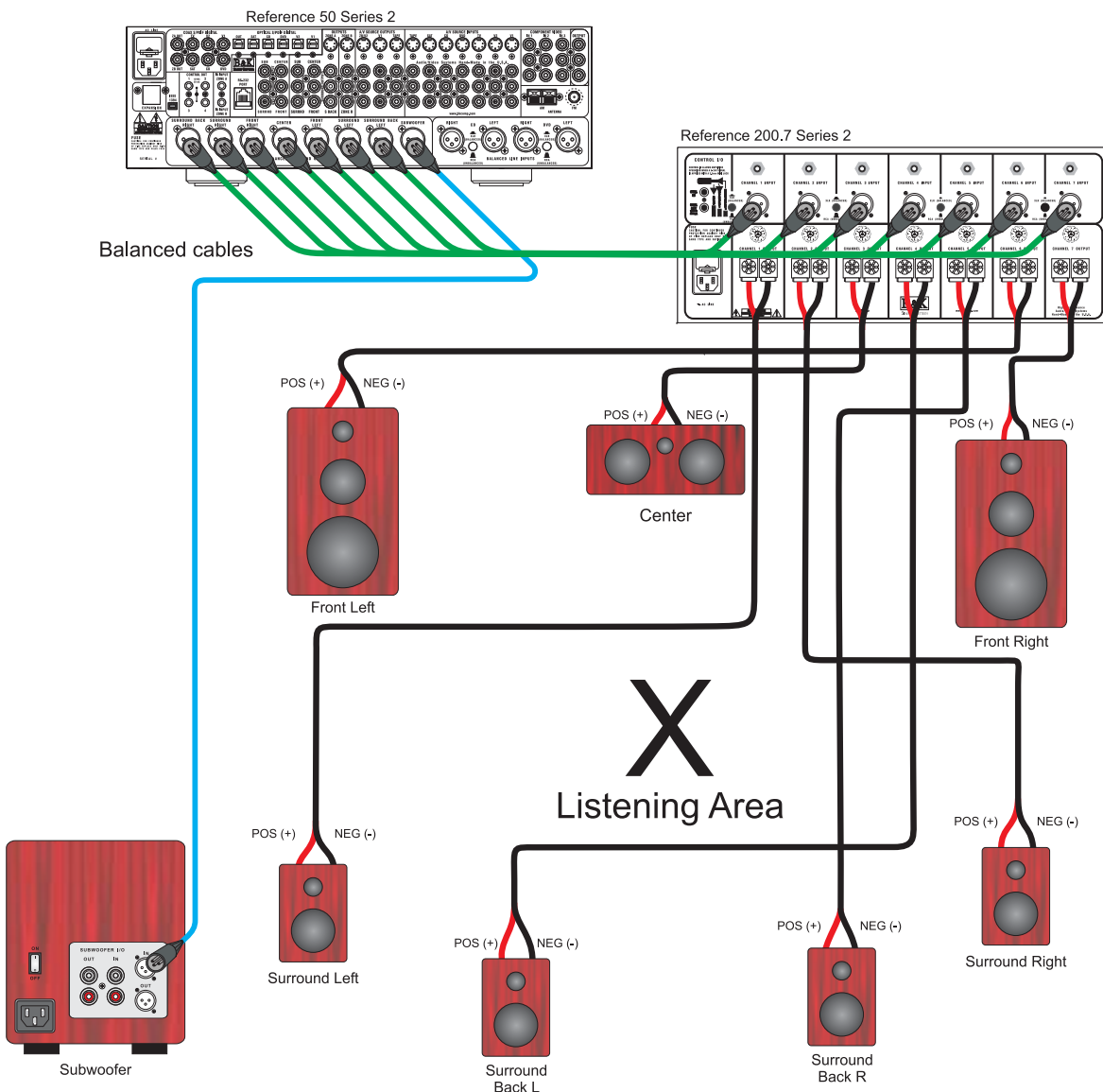

6.1 / 5.1 Balanced Output Connections

For use in a 6.1 or 6.0 audio setup, refer to the diagram below. We recommend the 6th speaker be connected to the surround back left channel of the surround preamplifier. However, either the back left or back right output will operate correctly when the system is configured for use with one back speaker. The point one (.1) indicates whether or not the system will use a subwoofer. If a subwoofer is used, The Reference 50 Series2 has two subwoofer outputs, one balanced (XLR) Subwoofer out and one coaxial (RCA) Subwoofer out, either output may be used. Connect the subwoofer cable from the subwoofer output to the subwoofer. The diagram below illustrates a connection using a balanced cable to connect to the subwoofer.

A 5.1 or 5.0 speaker setup will not use the 6th or 7th surround back channel(s). To use the Reference 50 Series2 in a 5.1 or 5.0 audio setup, only connect five channels using the surround speaker channels. Do not use the surround back left or surround back right for a 5.1 setup. The speaker setup menu will then used to configure the internal software for proper audio selection and operation (see [page 25](#)).

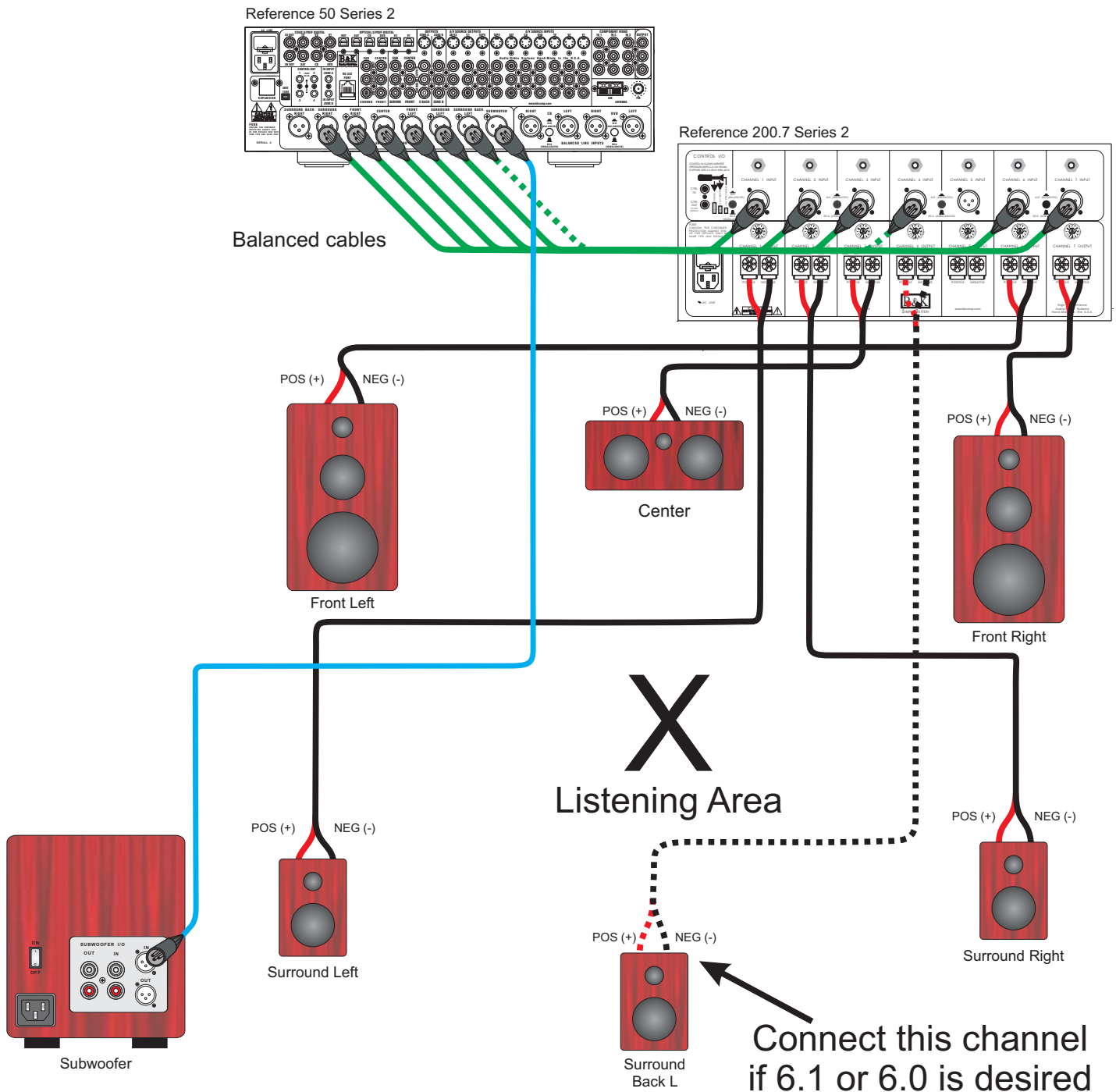

RCA Surround Output / Subwoofer Connection

The Reference 50 Series2 supplies 7.1 RCA coaxial surround outputs. These surround outputs can be used to connect an external amplifier or the subwoofer to the preamplifier. To connect seven audio channels, connect seven coaxial audio cables between the surround outputs and the amplifier inputs. Be sure to match the appropriate preamp output to the speakers location in the room, i.e. connect the center channel output to the center speaker amplifier channel. If a 5 channel audio system is desired, do not connect the surround back audio channels. If a 6 channel audio system is desired, connect the 6th channel to the surround back left channel. See [page 25](#) for speakers setup.

If a subwoofer is used, The Reference 50 Series2 has two subwoofer outputs, one balanced (XLR) Subwoofer out and one coaxial (RCA) Subwoofer out, either output can be used. Connect the subwoofer cable from the subwoofer output to the subwoofer. The diagram below illustrates seven channels plus the subwoofer connected using the coaxial RCA outputs.

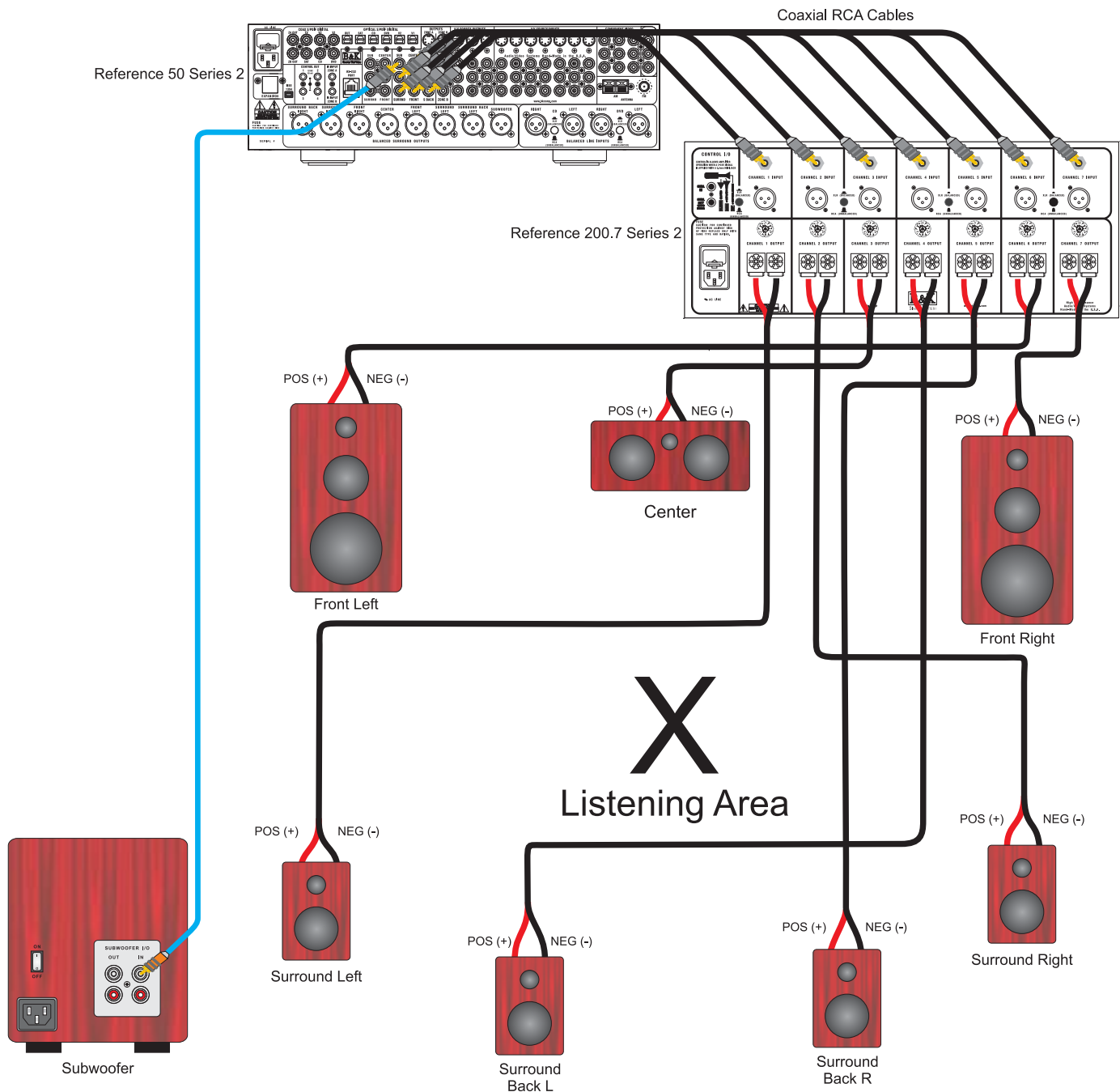

PASS THROUGH / RECORD LOOP CONNECTIONS

The B&K preamplifier has a few options for record/pass through outputs. There is a Zone A optical digital output, a Zone A coaxial digital output and a Zone B coaxial digital output. The B&K preamplifier provides three analog audio, composite & S-video outputs. These outputs are labeled TAPE, V1 and Z2/V2 in the Line Outputs section of the back panel.

Optical Digital Output - The optical digital output will output the digital signal of the source selected in the main theater zone (Zone A). Coaxial digital inputs are converted to optical. You need only connect one or the other. Analog inputs are not converted to digital output. If you wish to record both analog and digital sources you must connect both analog and digital inputs to your recorder.

Zone A and Zone B Coaxial Digital Outputs - The Zone A and Zone B coaxial digital outputs will output the digital signal of the source selected in the corresponding zone. Optical digital inputs are converted to coaxial. You need only connect one or the other. Analog inputs are not converted to coaxial digital output. If you wish to record both analog and digital sources you must connect both analog and digital to your recorder.

Tape Out - The analog Tape output is a pass through / record loop output for the source that is selected in the main theater zone. To prevent possible speaker damaging feedback, tape out will not output the TAPE source input. Digital audio is not converted to analog audio on the Tape output. You must connect analog audio to the A/V inputs if you want to make analog recordings from the input device. Only LtRt mode will downmix a digital bitstream into left and right analog. Video is not transcoded on the Tape output. If you have a composite recorder you must connect composite from each A/V source you wish to record. If you have a S-video recorder you must connect S-video from each A/V source you wish to record.

V1 Out - The V1 output can be configured as an output for a second recording device in Zone A or as a Zone A line output to connect a second video monitor and/or audio amplifier. As a record output, V1 will output the analog audio and video from the selected input in Zone A except when V1 is selected. This prevents feedback through the recording device which could damage your speakers. As a line output V1 will output the analog audio and video from whatever input is selected in Zone A. LtRt mode will downmix a digital bitstream to left and right. Record/Line settings also apply to the Zone A optical and coaxial digital outputs. Similar to the Tape output, digital audio is not converted to analog on the V1 output. Video is also not transcoded on the V1 output. To configure the V1 output see [page 33](#).

ZB / V2 Out - The V2 output can be configured as an output for a second recording device in Zone B or as a Zone B line output to connect a second video monitor and/or audio amplifier. As a record output, V2 will output the analog audio and video from the selected input in Zone B except when V2 is selected. This prevents feedback through the recording device which could damage your speakers. As a line output V2 will output the analog audio and video from whatever input is selected in Zone B. Record/Line settings also apply to the Zone B optical and coaxial digital outputs. As with the Tape output, digital audio is not converted to analog on the V2 output. Nor is video transcoded on the V2 output. To configure the V2 output, see [page 38](#).

CONTROL OUTPUT CONNECTION

The B&K surround preamplifier is supplied with four control outputs. These control outputs can be used for a variety of applications that require a 12 volt control or an IR output (pass through). The control outputs use a 1/8" (3.5mm) mono mini plug. Each output is 10-12VDC @ 50 mA. Control output 1 is strictly a +12VDC control trigger. Control outputs 2-4 can be set up as either +12VDC controls or as an IR pass through. To configure the control outputs, see the control setup section on [page 34](#).

IR Emitter Connection

To connect an IR emitter to the control output, one end should be terminated into a 3.5mm mono mini plug, tip (+), sleeve (-). The IR output will pass through IR signals received by the surround preamplifier. Only industry standard 38kHz IR may be used with the IR outputs. Additional resistance may be required in series with the IR emitter, check the current rating of the emitter you are using.

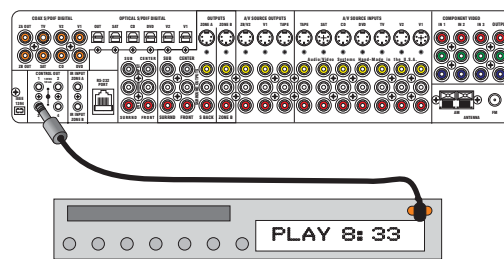

+12VDC Control Connection

If the +12VDC trigger is going to be used, it should be connected as shown right. An external amplifier is being used for this example, however the external device could be any device that employs a control trigger circuit. The plug must be wired as tip (+) and the sleeve (-). The diagram at right shows a B&K amplifier controlled with the +12Volt control.

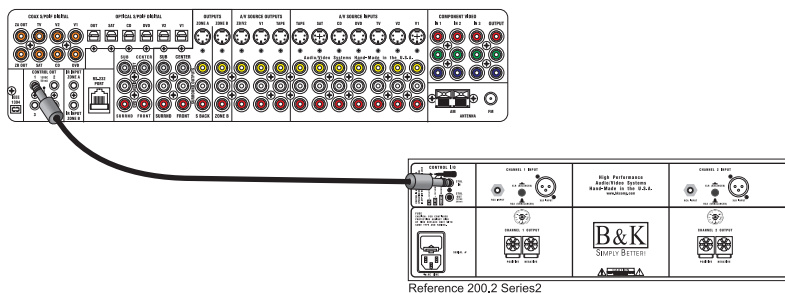

ZONE B CONNECTIONS

Your B&K preamplifier is capable of controlling a second independent analog audio and composite video or S-video zone. This second zone could encompass a small room or large area depending on how much amplification is supplied. The second zone is strictly analog audio, composite video and/or S-Video. There is no transcoding for Zone B. The composite video and analog (stereo) audio must be connected to the preamplifier in order to be seen and heard in the second zone. Control for the second zone can be accomplished by using a remote control or by connecting a CK1.2 Keypad. See [page 21](#) for keypad connection description. The audio and video output signals are connected from the Zone B outputs on the back panel of the preamplifier to a Zone B video monitor and a Zone B amplifier.

Zone B Audio Amplification

To connect an amplifier for second zone (Zone B) audio, connect RCA type audio cables between the Zone B left and right output to the second zone amplifier. The Zone B audio output can be configured fixed or variable. Connect the second zone video cable to the Zone B composite or S-video output. The second zone has the ability to link power and/or source input to the main theater zone. From the factory, the second zone is configured as a separate, independent audio and video zone. To configure the Zone 2 audio settings, see [page 38](#). The diagram on [page 20](#) illustrates how a Zone B amplifier should be connected to the Reference 50 Series2.

Zone B Video Connection

To connect a video monitor for second zone (Zone B) video, connect RCA type or S-video type video cable between the Zone B composite or S-Video output to the second zone video monitor. The Zone B video output will not display the On Screen Menu. Zone B video is not transcoded. The diagram on [page 20](#) illustrates how a Zone B Video monitor should be connected to the Reference 50 Series2.

REFERENCE 50 Series2 ZONE B CONNECTION DIAGRAM

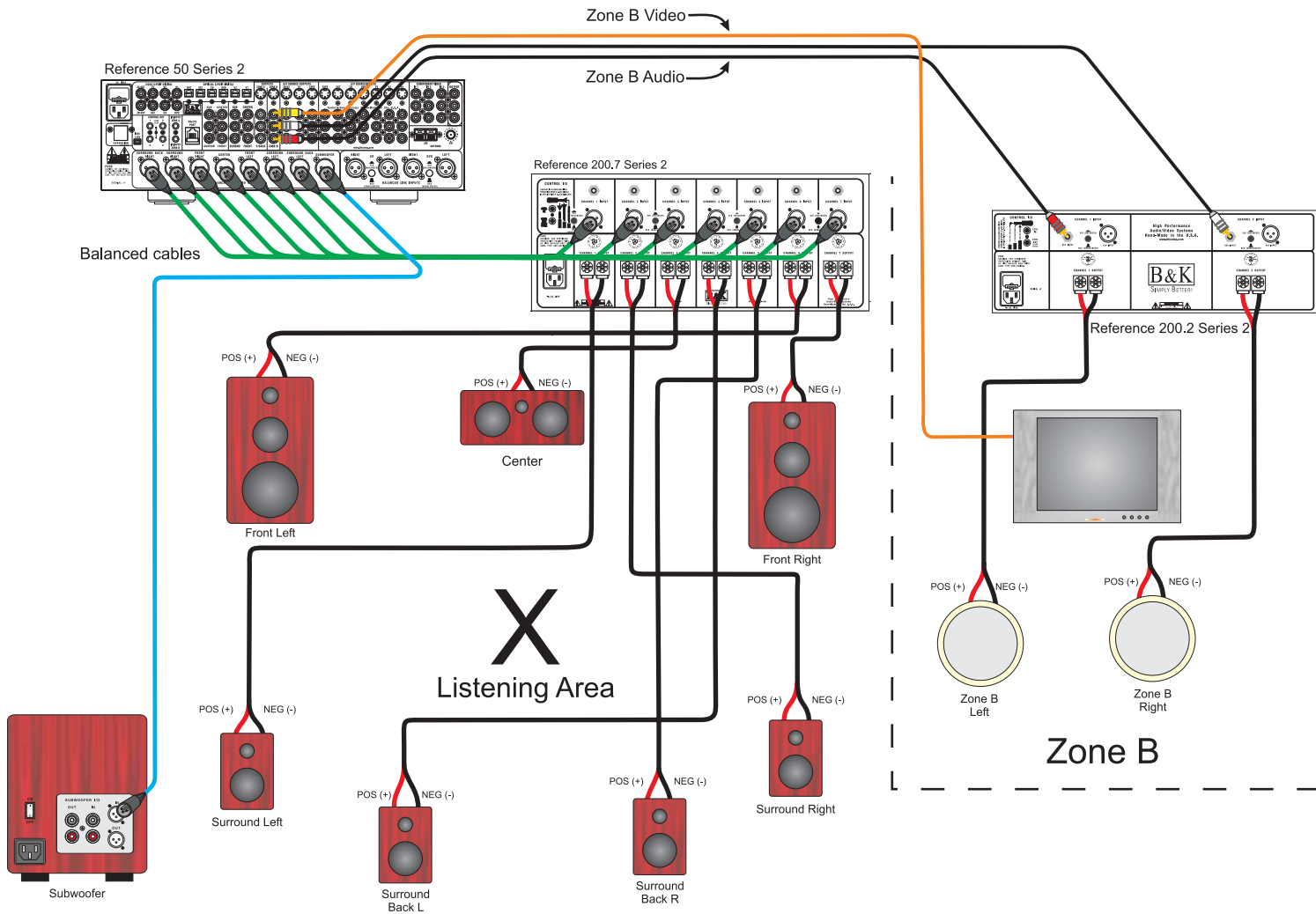

SETTING UP THE SYSTEM

The setup of the preamplifier will require navigation through the menu system. The system menu will display on the front panel as well as an On-Screen Menu format. The OSD menu is available on all three video format types. B&K recommends that a video monitor, connected to a Zone A video output, be used in conjunction with the SR10.1 remote to setup the system using the OSD menu. It is possible to set up your preamplifier directly from the front panel. The descriptions below are general instructions for using and navigating the menu system. A complete navigational menu system flow chart is located on [page 58](#).

B&K supports setup software (BKcSuite) that can be used to assist in the setup of the preamplifier. BKcSuite setup software is available on our website at www.bkcomp.com. BKcSuite provides a fast and easy way to configure the system parameters of the preamplifier using a personal computer or laptop equipped with a serial port. You can save the configuration files for later use or as a backup.



Directions for installing the BKcSuite are available on [page 54](#) or on our website. BKcSuite is compatible with any B&K audio processor and can be used in conjunction with the SR10.1 Remote or CK1.2 Keypad programming software.

THE MENU SYSTEM

MENU Button - Pressing the MENU button either on the remote or on the front panel will activate the menu system. Once you are in the menu system, the MENU button will step back to the next higher-level menu or, if you are already at the highest level, it will exit from the menu system.

EXIT (remote only) - From the remote control you may instantly exit the menu system by pressing the EXIT button. From the front panel press Menu repeatedly until you leave the menu system

UP/DOWN ARROWS - Once you are in the menu system, use the UP/DOWN ARROWS to move to the desired menu selection. With the supplied SR10.1 remote, rocking the thumb pad forward and backwards act as the up and down arrows. The current active menu line is highlighted in a contrasting color in the On-screen display and also shown on the front panel display.

SELECT / ENTER - Some menu selections select another menu level to be activated. Use the UP/DOWN ARROWS to move to the desired menu line. Pressing SEL or ENTER will activate the next menu. With the supplied SR10.1 remote, pressing on the center of the thumb pad also acts as the ENTER key.

NUMERIC KEY DIRECT ENTRY (remote only) - From the remote control you may also go directly to a menu line by typing the corresponding line number. If there is another menu level below that line it will be activated immediately (no ENTER required).

LEFT / RIGHT ARROWS (remote) or Volume Knob (front panel) - To change menu parameters, press the LEFT or RIGHT arrows to change the setting. There are no LEFT or RIGHT arrows on the front panel. The volume knob acts as the LEFT or RIGHT arrows. With the supplied SR10.1 remote, rocking the thumb pad left and right act as the left and right arrows.

TEXT EDITING - Some menu selections will allow you to edit text. Use the UP/DOWN ARROWS to change the current (blinking) character. Use the LEFT/RIGHT ARROWS (or VOLUME KNOB) to move to another character position. Additionally, while in the edit text mode, a successive press of a numeric key allows direct recall of the alphanumeric character map. It will allow a step through selecting between numbers, letters and/or symbols. The selection options for each of the numeric keys are as follows:

0 = [-, +, /, ?, space, 0]
 1 = [A, B, C, a, b, c, 1]
 2 = [D, E, F, d, e, f, 2]
 3 = [G, H, I, g, h, i, 3]

4 = [J, K, L, j, k, l, 4]
 5 = [M, N, O, m, n, o, 5]
 6 = [P, Q, R, p, q, r, 6]
 7 = [S, T, U, s, t, u, 7]

8 = [V, W, X, v, w, x, 8]
 9 = [Y, Z, y, z, 9]

MAIN MENU SELECTIONS

The main menu descriptions are accompanied by the On Screen Menu layout below. In some cases, the front panel will display a slightly abbreviated version of what the On Screen Menu shows due to character space limitations. The On Screen Menu is accessible from the component video output, the Zone A S-video output and the Zone A composite video output. B&K recommends using the On Screen Menu for adjusting unit parameters. The On Screen Menu is not available in Zone B.

On Screen Menu Format

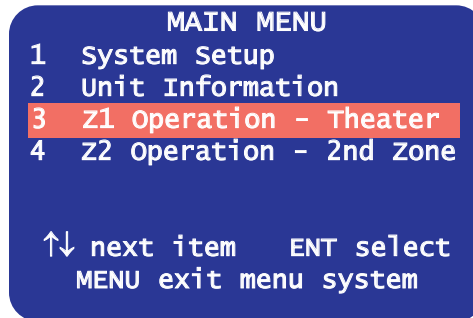

Front Panel Menu Format



1 System Setup - System setup should be used when initially setting up the preamplifier, or if system parameters need to be adjusted. [Page 24.](#)

2 Unit Information - Contains information about the unit make, model, serial number, software version, BKC-DIP version, phase locked loop chip version. This information may be needed when contacting customer service. [Page 32.](#)

3 Z1 Operation-Theater - Allows viewing and changing the entire state of Zone A. See Unit Operation [page 41.](#)

4 Z2 Operation-2nd Zone - Allows viewing and changing the entire state of Zone B. See Unit Operation [page 41.](#)

SYSTEM SETUP

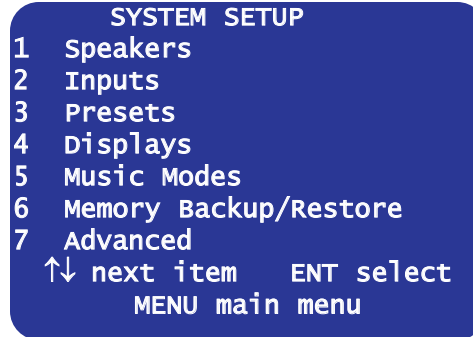

1. Setup Speakers

This menu configures the preamplifier for the number of speakers, speaker size, and location of the speakers in the room. It also contains room equalization options that can optimize the sound for a particular room. The overall sound quality of your system will depend upon how the parameters of this menu are setup. *It is very important that the speaker setup is performed when the preamplifier is initially installed or if any speakers are moved or changed.* [Page 25.](#)

2. Setup Inputs

This menu configures the preamplifier for the audio/video source devices that are connected to the system. This setup should be performed when the system is initially installed and whenever source components are added or removed. Setup inputs also describes the various audio modes and how each input is configured when it is selected. See [page 29.](#)

3. Setup Presets

This menu configures the preamplifier for how the presets will operate and be recalled. Presets allow virtual “snapshots” of the current settings to be saved. The presets can then be recalled at a later time. See [page 30.](#)

4. Setup Displays

This configures the preamplifier for preferences relating to the front panel and on-screen displays. To setup the display menu, see [Page 31.](#)

5. Music Modes

This menu configures the preamplifier for user preferred settings pertaining to the surround decoders. The preamplifier includes Dolby Pro Logic IIx and DTS NEO:6 processing which expands 2 channel stereo information into 6 or 7 channels. To setup music modes see [Page 31.](#)

6. Memory Backup/Restore

This menu allows a backup to be made of all system settings for restore at a later date. Once the setup of your preamplifier is complete it is recommended that you perform a memory backup. In case that an undesired change is made, the memory restore will allow you to restore your original settings. See [Page 31.](#)

SETUP SPEAKERS

1. Speaker Size

The speaker setup menu defines how many speakers are installed in the system, the relative size of the speakers, and their location in the room. This is the most important setup procedure that will be performed. The preamplifier comes from the factory setup for 7 small speakers and a subwoofer. If this does not match your speakers then audio information may be lost.

Speaker size refers to the frequency range the speaker(s) can handle. Audio material, particularly Dolby Digital and DTS movies, often contain large amounts of bass. If this bass information is sent to small speakers that are incapable of reproducing bass, then this information will be lost or distorted. TOO MUCH BASS MAY DAMAGE MANY SMALL SPEAKERS. By configuring the preamplifier for the correct type of speakers, it will appropriately route the bass information to the speakers that can reproduce it correctly. Typically, all bookshelf or satellite speakers are considered small. Smaller floor standing speakers with single woofers 8" or less should also be considered small. Floor standing speakers with 10" or larger woofers, or multiple smaller woofers may be considered large. These are general guidelines only - if you are unsure consult your speaker manufacturer or dealer. If there are all small speakers we strongly recommend the use of a subwoofer. If the speakers are large then the system may not require a subwoofer, but better results may be obtained with the use of a subwoofer, especially with Dolby Digital and DTS movies. Even if the speakers are capable of reproducing deep bass, better overall bass response may be obtained by setting these speakers to small. This allows bass to be reproduced from a single point (the subwoofer) and avoids the possibility of phase cancellation which can occur when bass is reproduced from multiple speakers.

Front Speakers - There must be at least 2 front speakers in order to use your preamplifier. Set them to small or large based on the guidelines above.

Center Speaker - It is not necessary to have a center speaker. Set it to small or large based on the guidelines above. Or, if there is no center speaker, set it to none. The center information will be reproduced in the front left and right speakers. No audio information is lost however the sense of voices coming from the screen may be lost.

Surround Speakers - It is not necessary to have surround speakers. Set them to small or large based on the guidelines above. Or, if there are no surround speakers, set them to none. The surround information will be reproduced in the front left and right speakers. No information is lost but the sense of spaciousness provided by discrete 5.1 channel soundtracks or 2 channel tracks enhanced by Dolby Pro Logic IIx or DTS NEO:6 may be lost.

Back Speakers - It is not necessary to have back speakers, however back speakers cannot be used unless the surrounds are used. If surround speakers are set to none, no options will appear for back speakers. There is the option to use 1 or 2 back speakers in either large or small varieties. If set to none, the back information will be reproduced in the surround speakers and although no information is lost, the sense of sounds coming from directly behind you may be lost.

Subwoofer - There are three choices for subwoofer. If set to none, all bass information, including LFE (.1 channel) will be routed to any large speakers in the setup above. If there are no large speakers and no sub, the bass information will be lost. The most common setting for subwoofer is Yes. The LFE channel and bass information from any small speakers is reproduced in the sub. Bass information from large speakers is reproduced only in the large speakers - it is not sent to the sub. B&K provides a third setting called Ultra. Ultra is identical to Yes as far as LFE and small speakers, but bass from large speakers is reproduced in the large speakers AND the sub therefore allowing bass to be reproduced from multiple locations in the room. The ultra setting also allows bass to be sent to the subwoofer when listening in Direct mode.

SETUP SPEAKERS

| | |
|---|-------------------|
| 1 | Speaker Size |
| 2 | Speaker Location |
| 3 | Speaker Levels |
| 4 | Crossover + LFE |
| 5 | Room Equalization |
| 6 | Room Resonance |

↑↓ next item ENT select
MENU main menu

SETUP SPEAKER SIZE

| | | |
|---|---------------|---------|
| 1 | Front | Large |
| 2 | Center | Small |
| 3 | Surround | Small |
| 4 | Surround Back | 2 Small |
| 5 | Subwoofer | Yes |

↑↓ next item adjust ←→
MENU setup speakers

2. Setup Speaker Location

Ideally the speakers should be positioned at an equal distance from the listening position. However, physical limitations usually require placing the speakers in other than optimum locations. The surround processor contains a means to electronically move each speaker's location. This allows for superior reproduction of the directional cues available during movie or music playback. Measure the distance in feet from your listening position to each speaker. Enter this information into the menu. The units can be changed to meters if preferred.

| SPEAKER | LOCATION | | | feet |
|-----------|----------|--------|-------|------|
| | Left | Center | Right | |
| Front | 10.0 | 10.0 | 10.0 | |
| Surround | 10.0 | | 10.0 | |
| Back | 10.0 | | 10.0 | |
| Subwoofer | | 10.0 | | |

↑↓ next item adjust ←→
MENU setup speakers

3. Setup Speaker Levels

Speaker level calibration will generate pink noise to allow the equalization of the volume levels of each speaker to make up for differences in speaker characteristics and distances from the listener to the speakers. Best results will be achieved using a Sound Pressure Level (SPL) meter. Set it to C Weighting and Slow Response. Place the meter at your listening position and adjust each speaker for an equal response. (SPL of **75dB** recommended).

If you don't have an SPL meter, adjust the levels by ear. Step through each speaker and adjust for approximately equal volume levels.

| SETUP | SPEAKER LEVELS | | | dB |
|-----------|----------------|--------|-------|----|
| | Left | Center | Right | |
| Front | 0.0 | 0.0 | 0.0 | |
| Surround | 0.0 | | 0.0 | |
| Back | 0.0 | | 0.0 | |
| Subwoofer | | 0.0 | | |

↑↓ next item adjust ←→
MENU setup speakers

4. Setup Crossover + LFE

High / Low pass crossover frequency - This sets the frequency at which bass tones are filtered from the small speaker channels and sent to the subwoofer. Set this according to the capabilities of the speakers. For very small bookshelf speakers the frequency may need to be raised to 100 or even 150 Hz. For speakers with larger woofers, the crossover frequency can then be lowered so only the lowest tones are sent to the subwoofer.

High / Low pass slope - A crossover doesn't simply send all content above 81 Hz to the main speakers and all content below 79 Hz to the sub. Instead there is a gradual transition. The crossover point is the frequency at which the amount of information in the subwoofer and main speaker(s) is equal. The crossover slope determines how gradual or abrupt this transition occurs (6, 12 or 24dB). More gradual slopes generally result in a smoother transition from main speakers to subwoofer. However, gradual transitions can cause distortion in small main speakers because too much bass is sent to them. Gradual transitions with higher crossover settings can also cause the perceived location of a sound to move from the correct main speaker location. Normally, you will want to use identical slopes for high pass and low pass. However, many small speakers include a 12dB high pass slope in the speaker itself. If this is the case, you will want to choose a 24dB low pass slope and 12dB high pass slope so that the end result is 24dB in both the subwoofer and main speakers. The crossover frequency should be set to match that built into the speakers (typically 80Hz).

The low pass slope can be set to EXTERNAL, 6, 12, or 24dB. The EXTERNAL setting will send full range to the subwoofer output allowing an external crossover to handle the low pass slope. If the subwoofer has an off or bypass selection for its internal crossover, we recommend setting it to off and using the preamplifier's crossover. If the subwoofer's crossover cannot be bypassed, but can be set to a high frequency, then the preamplifier's crossover can be used. If the subwoofer's crossover can't be defeated or raised to a high frequency we recommend that you set the preamplifier's low pass slope to external and adjust the preamplifier's crossover frequency to match that of the subwoofer.

| SETUP CROSSOVER + LFE | | |
|-----------------------|-----------------|---------|
| 1 | Crossover Freq | 80.0 Hz |
| 2 | High Pass Slope | 12.0 dB |
| 3 | Low Pass Slope | 24.0 dB |
| 4 | LFE Level | 0.0 dB |

↑↓ next item adjust ←→
MENU setup speakers

LFE (0.1) channel level - Usually this will be set to 0.0 dB (default). However, if there is no subwoofer you may wish to reduce the Low Frequency Effects (LFE) channel to lessen its contribution to the bass going to the remaining large speakers. Or, even with a subwoofer, you may just wish to reduce the overall LFE level, especially in a smaller situation such as an apartment. Note that this effects only the separate LFE (.1) channel available on Dolby Digital and DTS material it has no effect on the reproduction of normal bass from the front, center, or surround channels.

5. Setup Room Equalization

Sometimes it may be desirable to boost or reduce the levels above or below a certain frequency. This might be used to make up for small deficiencies in the listening room or speakers. The equalization can be applied only to certain speakers. This might be used to obtain a more consistent timbre between unmatched speakers. For example, if only the front speakers need to have frequencies above 10kHz boosted 1dB, then room equalization setup menu will be adjusted as shown right.

In some home theaters the center speaker is installed behind a projection screen. The screen will tend to cut the high frequencies. Applying a high boost only to the center channel can compensate for the losses introduced by the screen. Or possibly center and front left/right speakers are behind the screen. A high boost can be applied to all three of these speakers with no effect on the surround or back speakers. Shelving equalization helps to adjust level and frequency to aid in adjusting your room for a flat frequency response. Room Equalization parameters are applied globally regardless of the selected user EQ (The Variable EQ, the Loudness EQ, or the Vocal EQ). The graphs on the next page help describe how shelving equalization can affect the frequency response for a room. Room equalization is applied in all listening modes except DVD-Audio, Direct, and LiRt.

| SETUP ROOM EQUALIZATION | | |
|--|----------|---------|
| | Low | High |
| Frequency | 100.0 Hz | 10.0kHz |
| Gain | 0.0 dB | +1.0dB |
| Front | Off | On |
| Center | Off | Off |
| Surround | Off | Off |
| Back | Off | Off |
| Subwoofer | Off | |
| ↑↓ next item adjust ←→ MENU setup speakers | | |

6. Room Resonance (Notch Filters)

No speaker has perfectly flat frequency response. These deviations in frequency response contribute to each speaker's characteristic sound. This is why one speaker might be preferred over another. When a speaker is put into a room with walls, floor and a ceiling, reflected sounds can cancel or reinforce one another which further alters the frequency response.

At higher frequencies, hundreds of small peaks and dips can be measured in the frequency response. Attempts to remove all these small deviations would result in colorations to the sound that may not be desirable. The characteristic sound that made the particular speaker(s) attractive could be completely lost. Even if the hundreds of small peaks and dips would be adjusted, it would only be correct for a single position in the room. Moving your head just a few inches would require a completely different set of corrections.

At low frequencies, the picture is different. There are fewer peaks and dips, but they are much more dramatic. The peaks and dips persist over a much larger portion of the listening area. Dips can't be corrected electronically. Putting out more power at the dip frequency won't help. If the original and reflected waves cancel each other, they will cancel at 1 watt or 1000 watts. If you have major dips in the frequency response you can try repositioning your speakers, particularly the subwoofer. Fortunately, dips in the bass response are typically not that noticeable. When an instrument plays that particular frequency, the bass is lost, but the higher harmonics of the instruments tone are still there. To some degree, your ear and brain will fill in the missing information. Continued on next page...

| SETUP ROOM RESONANCE | | |
|--|----------------|--------|
| Test Tone | 100.0 Hz | - |
| | 30.0 dB | |
| Notch 1 | 150.0 Hz | 0.0 dB |
| Notch 1 width | 146.4-153.6 Hz | |
| Notch 2 | 100.0 Hz | 0.0 dB |
| Notch 2 width | 146.4-153.6 Hz | |
| Notch 3 | 50.0 Hz | 0.0 dB |
| Notch 3 width | 146.3-153.6 Hz | |
| Subwoofer Phase | | Invert |
| ↑↓ next item adjust ←→ MENU setup speakers | | |

The situation is different for large low-frequency peaks. These peaks are what tend to shake the knick-knacks off the shelves and result in an overall tubby sound to the bass. Fortunately, this CAN be remedied electronically...and without drastically altering the characteristic sound of your speakers. Typically a room will have 3 large peaks due to the distance between the front/back walls, left/right walls, and the floor/ceiling. B & K provides 3 notch filters to address each of these peaks. A test tone generator is provided to assist in the process of identifying the resonant peaks.

The test tone generator will generate an adjustable frequency tone between 20-300Hz. The test tone generator can generate the test tone at -42dB, -36dB and -30dB. The -30dB setting matches the levels you set up in the speaker level menu assuming 75dB speaker calibration. Normally you would use this setting. Two lower level settings are provided if you wish to perform these tests at lower volumes.

Initially, all filters are set to 0dB from the factory. Turn on the test tone generator at -30dB. Sweep the frequency range to locate the 3 highest peaks. Using an SPL meter, note the frequency and the level of these peaks. Also note the frequencies above and below the peak where the level is 3dB less than the peak. Adjust notch 1 frequency to the frequency of the first peak. Adjust the notch level to the difference between the peak level and the 75dB reference level. Adjust the notch width to the setting nearest those where the peak or peaks is 3dB lower. Repeat for notches 2 and 3.

This Room Response Example illustrates the frequency spectrum and how notch filters and shelf equalization can be effective. Note the "problem" spikes in the room response curve in the diagram at right. By applying the notch filters and the shelving equalization, a flatter room response can be obtained. Once the notch filters are adjusted, they are applied to all inputs in all music modes.

Notch Width - Some resonating frequencies span a greater width in the frequency spectrum than others. Each notch width can be adjusted between 4.8 - 33.4Hz depending on how wide or narrow each spike is.

Subwoofer Inversion - The subwoofer phase can be inverted 180 degrees. Set the test tone to the crossover frequency and adjust for the loudest sound.

Room Response Example

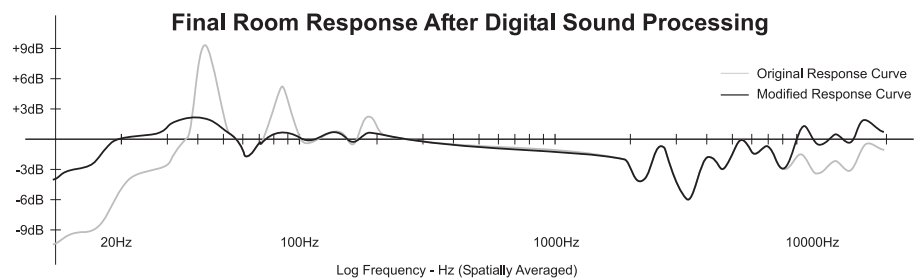
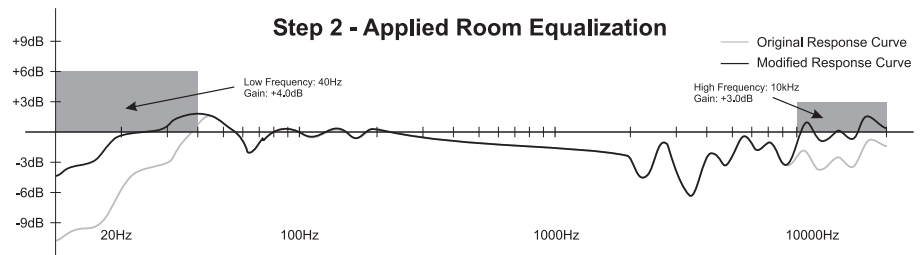
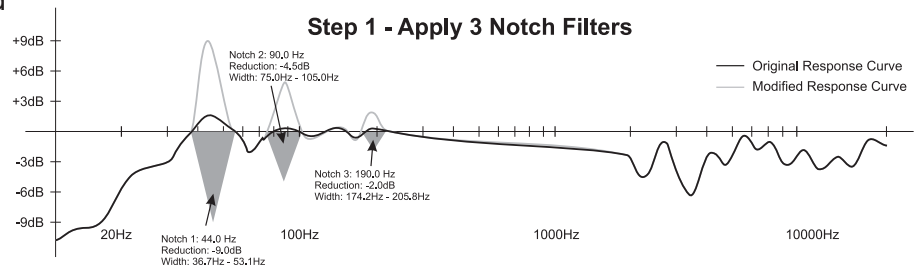
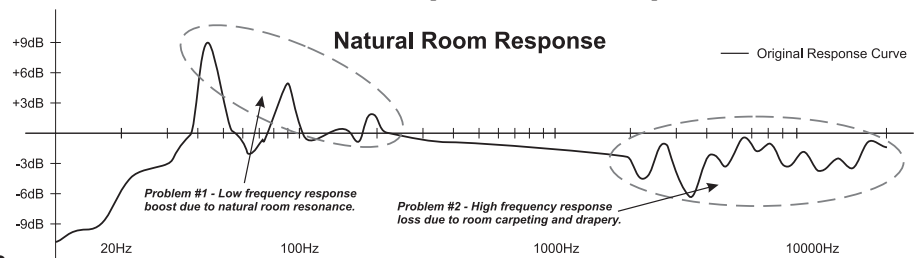

SETUP INPUTS

This menu allows you to tell your preamplifier how you would like each input to operate. You may repeat the following steps for each input by changing inputs on the top line of the menu or with the supplied remote control.

1. Default Audio Modes - There are two major categories of audio, 2-channel and 5.1 multi-channel. Two channel audio might come from an analog VCR, a PCM CD or a Dolby Digital 2.0 DVD. *The first three selections in this menu for Default Mode, Default Speakers and 2-chan Decoder apply only to 2-channel audio.* The Default Mode defines the listening mode the preamplifier will select when the input is first chosen. This default audio mode defines how you usually prefer to listen to a particular input. Do I usually listen to my satellite preamplifier with some sort of surround processing (Pro Logic IIx or NEO:6)? Do I like my CDs in pure stereo mode? Here is where you can set this up. The audio mode can be manually changed to a different listening mode for a particular movie or CD, but the preamplifier will always remember your favorite (default) mode that is set here. There are five audio modes in total; Mono, Stereo, Surround, Cinema or DVD-Audio. Each audio mode can be configured for each input for the number of speakers and 2-channel decoder used. See [page 45](#) for a description of how to use each audio mode.

2. Default speaker Selections - A speaker selection setting can be made for each audio mode. Do I like 2 channel material played back in a five speaker configuration, or expanded to include the surround back speakers? Do I like stereo in pure 2-channel or spread out to the center and/or surround speakers? Set mono to 1, stereo to 2, surround to 7 and the system will remember each setting independently per each input. The *default* speaker selection will be chosen each time the input is selected. The speaker selection can be manually changed to a different speaker selection for a particular movie or CD at any time. The preamplifier will always remember the favorite selections that are set here. See [page 47](#) for a detailed description of speaker selections.

| SETUP DVD INPUT | |
|---------------------------|--------------|
| 1 Default Mode | Surround |
| 2 Default Speakers | 6 |
| 3 2-chan decoder | DPLIIx Movie |
| 4 Multi-chan type | Surr Movie |
| 5 Level | +2.5 dB |
| 6 Name | DVD |
| 7 Component video | 1 |
| 8 DVD Audio Input | Yes |
| ↑↓ next item adjust ←→ | |
| MENU setup system | |

If a speaker selection is chosen that is not possible based on the information you entered in the Speaker Setup Menu, the preamplifier will automatically correct for this with no loss of audio information.

3. 2-Channel Matrix Decoders - Your preamplifier includes the latest 2-channel surround decoders from Dolby and DTS. Do you usually like your CDs in DTS NEO:6 Music?; Your 2-channel DVDs in Dolby Pro Logic IIx Movie? You can choose your favorite (default) decoder here for each input. If you don't like that mode for some particular CD, you can manually change to a different mode using the SR10.1 remote supplied. The preamplifier will always remember your favorite settings for each input.

4. Multi-Channel Filter Types - When the preamplifier detects multi-channel Dolby Digital or DTS material it will automatically choose to use all of the available speakers in the system. (It is important to configure the preamplifier for how many speakers there are in the speaker setup menus).

There are some choices for multi-channel audio. Do I like my DTS CDs in Surround Music? Do I like my 5.1 movies in Surround Movie? The preference can be set here. The multi-channel listening mode can be manually changed for a particular movie or CD. The preamplifier will always remember the favorite multi-channel mode that is set here. See [page 8](#) for descriptions of multi-channel modes.

5. Level - Each input gain can be adjusted +/- 6dB. Occasionally certain source devices, particularly analog sources, will have higher or lower than normal output levels. This setting allows the level to be adjusted so that there are no drastic volume changes when you switch inputs. Try a few different discs or channels before adjusting the level. It might be that a particular station has high or low output level rather than the entire satellite receiver.

6. Input name - Five characters maximum. From the factory, the preamplifier will display source names that match those printed on the back of the preamplifier and on the supplied SR10.1 remote. These names can be changed to match the type of source that is being used. For example, if a cable box is connected on the SAT input instead of a satellite receiver, the SAT name can be renamed to CABLE. The AM/FM Tuner name cannot be changed.

7. Component Video Assignment - The preamplifier includes 3 component video inputs that can be assigned to any of the 7 A/V inputs. **Component video is unassigned on all inputs from the factory.** For example, if there is a DVD player that has component video outputs, component input 1 can be assigned to the DVD input. Connect the DVD player's component outputs to component input 1. When DVD is selected, the component output will source from component input 1.

If the component video has been assigned for any input, transcoding from S to composite or composite to S will continue.

8. DVD-Audio input Assignment - DVD-Audio and Super Audio CD (SACD) introduce a third category of audio: multi-channel analog. The preamplifier provides one set of multi-channel analog inputs that can be assigned to any one A/V input except TAPE. When DVD Audio is selected as YES for a particular input, the default listening mode is automatically changed to DVD-Audio with 7 speakers. (The number of speakers used can be changed) When YES is selected for a particular input, any previously selected DVD-Audio input will automatically be reset to NO. Selecting 5 speakers is direct pass through.

SETUP PRESETS

The Setup Presets menu describes *how* the presets will operate.

Volume in Preset - YES or NO. If the volume of the preamplifier should be set to the preset level when the preset is recalled, select YES. If the volume of the preamplifier should remain at the current listening level when the preset is recalled, select NO.

Preset Names - AUTO or MANUAL. When saving a preset, the system automatically generates a simple name for the preset. The generic name consists of the source input and volume level. The name can be changed before saving the preset. The automatic naming can be defeated so that a custom title that was previously entered will not get erased if the preset settings are re-saved. Turning auto naming off (manual) allows that the name that is already present in the preset to be re-used when a new preset is saved to that location.

Zone A Favorite Recall - AUTO or ENTER. A preset can be recalled in one of two ways. Enter requires the ENTER button to be pressed to recall the preset. AUTO will allow the preset to recall automatically as you scroll through presets using the channel up/down buttons.

Zone A Favorite Presets - Press ENTER to bring up the FAVORITE PRESET MENU. Any preset can be recalled by typing in its number. Use this menu to mark or un-mark presets as favorites (Yes or No). Favorite presets can be recalled when using the preset up and down buttons. This menu can also be used to edit preset names.

Zone B Favorite Recall - Zone B has a separate set of presets with the same options as the Zone A presets.

Zone B Favorite Presets - Press ENTER to bring up the FAVORITE PRESET MENU. Any preset can be recalled by typing in its number. Use this menu to mark or un-mark presets as favorites (Yes or No). Favorite presets can be recalled when using the preset up and down buttons. This menu can also be used to edit preset names.

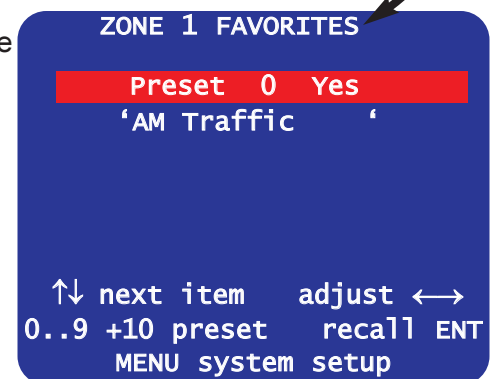
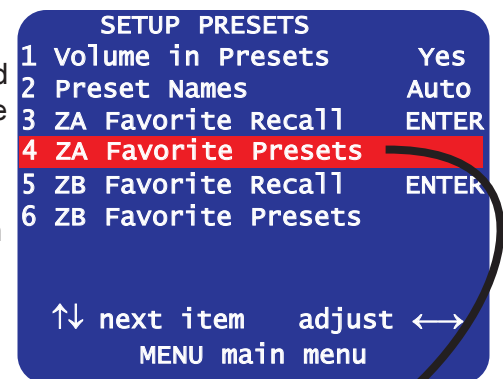

SETUP DISPLAYS

Front Panel - Describes the possible selections for the brightness of the front panel display. Bright, medium, dim.

OSD Color - Set the preferred color for the OSD menu. Default setting is blue. Select from Blue, Purple, Pink, Aqua, Lilac, Yellow, Red, or Green.

On Screen - All changes that are made to the preamplifier (volume, input, tuner frequency, etc. are displayed on the front panel. You can choose how much information is also displayed with the On-Screen Display (OSD).

Major Change - OSD will display changes to input and saving/recalling presets.

All Changes - OSD will display changes to input, saving/recalling presets, tuner station entry, Volume, bass, treble, channel gain and decoder adjustments.

Off - OSD will only display when the INFO button is pressed from the remote control or when entering into the menu system.

On Screen Time - This setting defines the length of time the info screen will display through the video output. The info screen timer may need to be adjusted when using video devices that auto detect the video resolution. Sometimes high definition monitors need more time to adjust to the low definition resolution of the splash screen. Most monitors will be compatible with the default time of 3 seconds.

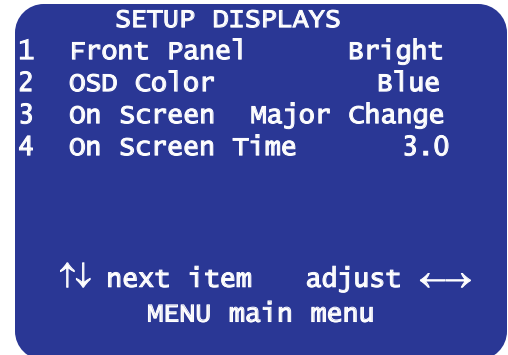

SETUP MUSIC MODES

B&K supports two different two-channel decoders; DTS NEO:6 and Dolby Pro Logic IIx. Each decoder supports surround adjustments that can be made pertaining to how audio information is directed throughout the soundstage. These adjustments apply only to the music mode of these decoders. In this menu you can set the preferred settings. The settings can be adjusted on the fly using the remote. The settings will always return to the settings in this menu when you first select the music mode. See [page 7](#) for a description of what these settings do.

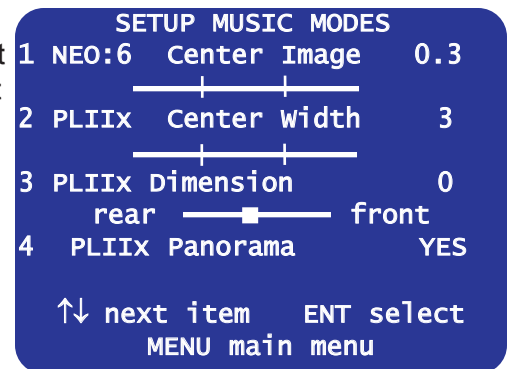

MEMORY BACKUP/RESTORE

This menu allows a backup to be made of all the customized settings that have been made to the Reference 50 Series2. The options in this selection are BACKUP and RESTORE. Even if a backup is not made, any customized settings will not be lost during normal day to day operation. It is a good idea to create a backup once all the settings have been made. These settings are then stored on an internal EEPROM. Select RESTORE, if you desire to recall the memory backup.

Note: A Factory Reset will erase of a previous memory backup.

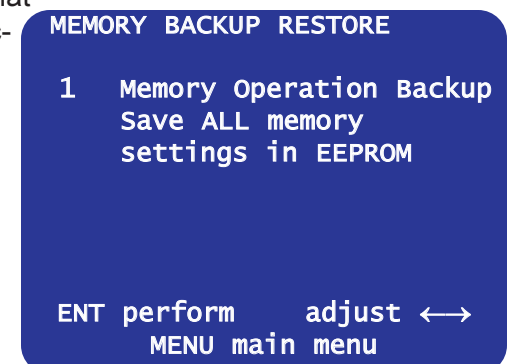

UNIT INFORMATION

Unit information provides hardware information about your preamplifier.

Unit - The model of the preamplifier

software - The software version currently running in the hardware.

S/N - Serial Number

BKC-DIP - B&K Components Device Interface Protocol version.

TUN-PLL - Tuner information

UNIT INFO

| | |
|------------|-----------------|
| 1 Unit | Ref 50 Series 2 |
| 2 software | version 1.00 |
| 3 S/N | 123456789 |
| 4 BKC-DIP | 1.2.01 |
| 5 TUN-PLL | LC72146 |

next item
MENU Main Menu

ADVANCED MENU

The advanced setup menu allows the user to adjust the following features. An advanced menu navigational flow chart is located on [page 58](#) of this manual. The categories that are reserved for the advanced menu are as follows:

- Zone maximum volume level.
- The IR code-set for each zone
- Power on Titles
- +12 Volt Control Outputs
- User Security
- Surround Mode Detection
- Plug n Play timing
- DSP usage
- RS-232 Settings

From the factory, the advanced menu is hidden from user access. To reveal the advanced menu, simultaneously press the UP, DOWN and ON/STANDBY buttons. Once these three buttons have been pressed, the Security Options Menu will display with "ADVANCED VISIBLE" highlighted. This will indicate the advanced menu is accessible. If the IR or front panel has been locked, this button press sequence will unlock them. After enabling advanced menu, the system setup menu will change:

Advanced Locked

```

SETUP SYSTEM
1 Speakers
2 Inputs
3 Presets
4 Displays
5 Music Modes
6 Memory Backup/Restore
←
↑↓ next item  ENT select
MENU main menu
  
```

Advanced Unlocked

```

SETUP SYSTEM
1 Speakers
2 Inputs
3 Presets
4 Displays
5 Music Modes
6 Memory Backup/Restore
7 Advanced
↑↓ next item  ENT select
MENU main menu
  
```

Descriptions of each option of the advanced system setup menu are as follows:

Zone '1' Home Theater - Allows adjustments for the main home theater zone. Set the max volume, zone ID, Record loop and surround mode options.

Power On Titles - Customize power on titles for customized personal greetings.

Control Out - Configure the 12VDC control outputs for control of external devices.

Security Options - Lock the front panel, memory or front panel IR sensor.

DSP Usage - Displays processor status in MIPS.

RS-232 Control Port - Configure the main RJ-45 jack for RS-232 communication.

Plug n Play Timing - Adjust the timers for the digital Plug n Play system. This is useful when adjusting for digital error muting.

Zone 'B' Second zone - Allows adjustments for the second zone. Set the max volume, zone ID, Record loop and the Zone A&B linking options.

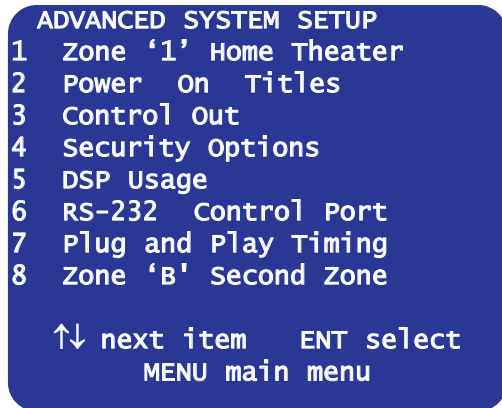

Zone '1' Home Theater

Max Level - Set the maximum volume for the main theater zone. This can be used to protect your speakers or ears from inadvertent excessive volume.

Zone ID - The product ID (IR code set) can be adjusted if operation with other B&K is gear is required. The default ID is 001 for the main theater zone and 002 for Zone B. The preamplifier can be assigned to any ID (B&K code-set) between 001 and 099. This allows ninety nine different B&K surround processors to operate independently using different remote controls. This feature is typically useful if multiple surround processors are used in the same system (B&K CT whole house audio systems). Zone A and Zone B cannot be assigned the same code set. The code-set 000 operates both zones of the preamplifier simultaneously.

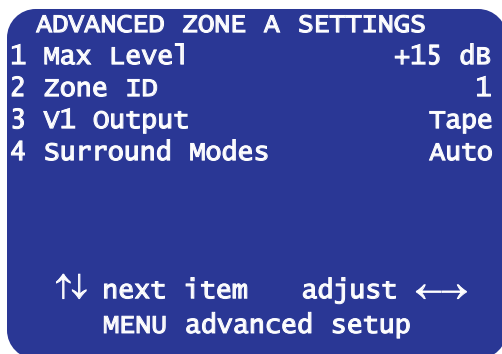

NOTE: If the code set of the preamplifier is changed, you will need to reprogram the IR code of the remote control being used. B&K offers the SR10.1 programming remote (supplied with the B&K Reference 50 Series2), the CK1.2 Keypad or MZ-128 remote.

V1 Output - TAPE or LINE. The V1 output can be configured as an output for a second recording device in Zone A (TAPE). The V1 output can also be configured as a Zone A line output to connect a second video monitor and/or audio amplifier (LINE). As a record output, V1 will output the analog audio and video from the selected input in Zone A except when V1 is selected. This prevents feedback through the recording device which could damage your speakers. As a line output V1 will output the analog audio and video from whatever input is selected in Zone A. Record/Line settings also apply to the Zone A optical and coaxial digital outputs.

Surround Modes - Select AUTO or MANUAL. Auto or manual engages or disengages the B&K Plug n Play System.

Auto - If set to AUTO, each time an input is selected the Plug n Play system will scan the various source signals and determine if a multi-channel digital bitstream is present. The main theater zone will then use the maximum number of hardware speakers specified in the speaker setup menu.

Manual - If set for MANUAL, each time an input is selected, the user will select the audio mode that will be used with the source signal, regardless of a what bitstream is present. Manual mode allows the preferences setup in the Surround audio mode to apply both to multi-channel and 2 channel source input signals.

Power on Titles

Personal power on greeting can be programmed to display on your B&K's front panel display. Both power on lines contain 16 alphanumeric characters. Power on titles will appear when the preamplifier is taken out of Standby.

Have fun with your power on titles, and try to WOW everyone. Power on titles are easy to set up using BKcSuite setup software.

```

POWER ON TITLES
1 Power On Line 1
  '   BK Components   '
2 Power On Line 2
  '   * Digital DNA   '

↑↓ next item   ENT select
MENU advanced setup
  
```

Control Output (12VDC control)

The preamplifier contains 4 control outputs. Control outputs are supplied to control external source devices such as amplifiers, projection screens, curtains, etc. The control outputs can also be configured to control an external device with IR. Each control can be configured as shown in the following table. Each input can dictate how that each control output can function. Control outputs are terminated using 1/8" (3.5mm) mono mini jacks. +12VDC control outputs supply 50mA maximum current each. Actual voltage can vary between 10-12VDC depending on the load. See below for control output table.

Off - Control output is off when the input is selected.

Zone A - The control output is on when Zone A is on and the input is selected in Zone A.

Zone B - The control output is on when Zone B is on and the input is selected in Zone B.

Zone A / B - The control output is on when Zone A or Zone B is on and that source is selected in either zone.

Remote - IR will pass-through from the front panel or a connected keypad to the control output. An IR emitter can be connected for control of an IR device. IR will only pass-through when the source is selected and the control is set for remote.

RS-232 - The control output can be controlled from a RS-232 command or RS-232 controller.

Phones - The control output is off when the preamplifier is in headphone mode. This way, if an external amplifier is used, it will be off when the headphones are in use.

```

CONTROL OUT 1 SETUP
1 TUNER      Phones
2 V1         Phones
3 V2         Phones
4 TV         Phones
5 DVD        Phones
6 CD         Phones
7 SAT        Phones
8 Tape       Phones

↑↓ next item   adjust ←→
MENU advanced setup
  
```

Each control output can be configured differently if desired. The following table defines the possible choices each control output can be set to. Note the shaded boxes are the default settings.

| <u>Control</u> | <u>Possible selections for each Input</u> | | | | | |
|----------------|---|---------------------|---------------------|-----------------------|---------------------|--------|
| 1 | Off | Phones (default) | Zone A | RS-232 | N/A | N/A |
| 2 | Off | Zone A | Zone B (default) | Zone A/B | Remote | RS-232 |
| 3 | Off | Zone A | Zone B | Zone A/B (default) | Remote | RS-232 |
| 4 | Off | Zone A | Zone B | Zone A/B | Remote (default) | RS-232 |

DSP Usage

This screen monitors the amount of processing power being used. Expressed in MIPS (Millions of Instructions per Second)

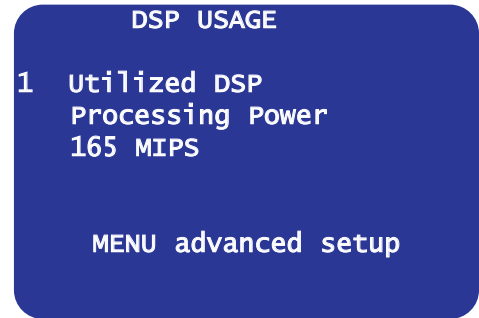

Security Options

In the security menu, the user can protect the preamplifier from accidental changes to unit settings or reprogramming. Changes made to the security menu will not take effect until you exit the setup menu. Once a security option has been activated, you may re-enter this menu by simultaneously pressing the UP, DOWN and STANDBY.

Advanced Menu - Visible or Hidden. This selection will hide or un-hide the advanced options menu. The advanced menu is choice seven in the System Setup menu. If the advanced menu is locked (default) pressing UP/DOWN/STANDBY will unlock the advanced menu and automatically display the security options menu.

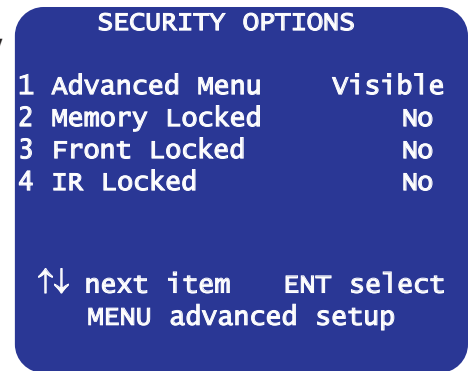

Memory Locked - Locking memory will prevent changing of your presets or system settings.

Front Locked - Locking the front panel will only allow operation of your preamplifier with a B&K remote or RS-232 computer Interface. Note if you inadvertently lock the front panel, simultaneously pressing STANDBY, UP and DOWN on the front panel will always enter the advanced security options to allow changing these settings. Locking the Front will still allow RS-232 "F" messages (front panel display) to be accepted.

IR Locked - YES or NO. Locking the IR will deactivate the IR sensor on the preamplifier front panel. If the front panel IR is locked, it will not allow a connected keypad or IR sensor to operate. Locking the IR will still allow RS-232 "I" messages (IR) to be accepted.

RS-232 Control Port

The RS-232 port refers to the main RJ-45 connection located on the preamplifier's back panel. The RJ-45 contains connections for transmission and reception of RS-232 data. See pin-out at right. The RJ-45 also supports power supply and IR input for CK1.2 Keypad interface.

Port - When disabling the RS-232 port, RS-232 strings will be neither transmitted nor received through the main RJ-45 jack. By default the RS-232 port is enabled.

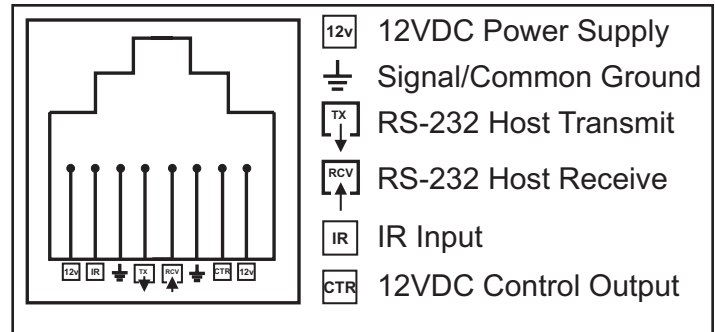

Baud rate - The default baud rate is 9600. B&K does not recommend using any baud rate other than 9600. When a Baud rate other than 9600 is used, Keypad status will not function.

Echo - Enabled or Disabled. This setting is for those with external control systems communicating to B&K products via RS-232. Echo will repeat RS-232 transmissions received through the main RJ-45 receive port.

Feedback (RS-232 Continuous Reply):

None (Default) = Neither BKC-DIP Update or Reply is generated.

Update = A change affecting a logical zone from the Front Panel or B&K IR generates an update message representing the specific front panel button or B&K IR command. The preamplifier must then be polled to determine the current status.

Reply = When set to "REPLY", the preamplifier will automatically generate BKC-DIP reply messages to allow unsolicited continuous feedback to an external RS-232 controller. A change affecting Zone A or Zone B from the Front Panel or B&K IR generates a reply message representing the new status of the parameter that was changed.

Typical format example of a BKC-DIP Reply :

An example BKC-DIP Reply message the Reference 50 Series2 will automatically generate when a master volume change is executed in Logical Zone 1 is (0,R,P1=FF,1=60;). Reply message Logical Zone 1 current Preset parameter Volume value is set to 60 hex or 0dB (assumes 0dB is the current setting).

"0" is the transmit ID

"R" is the BKC-DIP Reply message.

"P1=FF" is the BKC-DIP command for the current preset in logical Zone 1 (P1: main theater zone ID).

"1=60" is the current preset parameter (1: Volume), is set to the Hex value of 60 (volume at 0dB).

For a complete list of B&K RS-232 parameter Protocol, see the *Series_III_S2_10000.pdf* or greater located in the documentation of BKcSuite or online at B&K's website.

All (Both) = Outputs both a BKC-DIP Update and Reply messages.

Receive ID / Transmit ID - This is the identifier in B&K RS-232 protocol that allows B&K to "listen" (receive ID) or "talk" (transmit ID) to other B&K products. Change this identifier if you are using an external automation system to control more than one B&K products in series. The transmit and receive IDs are denoted by the first number in an RS-232 message i.e. (0,S,I,1=45;).

Note - If you change the Receive or Transmit ID, it does not affect setup with BKcSuite.

| RS-232 PORT SETUP | |
|--|----------|
| 1 Port | Enabled |
| 2 Baud rate | 9600 |
| 3 Echo | Disabled |
| 4 Feedback | None |
| 5 Receive ID | 0 |
| 6 Transmit ID | 0 |
| ↑↓ next item ENT select MENU advanced setup | |

Plug and Play Timing Setup

Plug and play timing pertains to the internal delays associated with the Plug n Play audio detection system.

DO NOT ADJUST THESE PARAMETERS UNLESS THERE IS A PROBLEM HEARING AUDIO

Your preamplifier has default audio Plug n Play settings that work with the majority of A/V sources and digital audio bitstreams. However, with the introduction of new A/V products into the market place, these Plug n Play audio detection parameters may need to be adjusted to improve upon the listening experience. An example might be that there is an inordinate amount of audio pops or snaps while changing Cable, HDTV or SAT channels. The quality of the original digital bitstream depends on many factors. It is our desire to minimize the amount of audio pops and snaps that may be transmitted thru to the speakers. Your preamplifier does not "filter" any imperfect digital bitstreams, nor does it make the digital bitstream a valid signal. However, because audio pops snaps are undesirable, your preamplifier will try to mute the audio before you hear it when there is a digital audio bitstream error. Although your preamplifier's muting circuitry may stop most of the digital errors from being heard, it does not guarantee that a digital error may never be heard.

The Plug n Play menu may be used to adjust mute times while the preamplifier is automatically switching between different types of digital audio formats (AC3 / DTS 5.0 / DTS 5.1, PCM). Usually these audio pops and snaps may be traced to a digital error on the incoming digital audio bitstream and corrected with a simple Mute Time adjustment.

Default Settings

Mute Time - 0.5 Sets the mute time for use with invalid digital audio information. In addition it is used to mute when a digital signal first appears or changes modes. Most notably, some DVD recorders output about 1.5 seconds of invalid digital bitsreams after you close the drawer.

Digital Sticky - 2.0 Only applies to changes from any digital audio mode back to analog. Changes from analog to digital are always fast. This parameter may be set long because most Cable and SAT receivers drop the digital audio bitstream when changing channels and there is really no need to revert back to analog. Note, some Cable and SAT receivers only output analog audio for certain broadcast channels. If the Digital Sticky parameter is set too long there may be a longer period of silence before you hear the audio with an analog only broadcast channel.

Mode Sticky - 1.0 Only applies to changes from AC3 or DTS to PCM. Changes from PCM to AC3 or DTS are typically fast. Many DVD players drop to PCM when skipping tracks. There is no need for the preamplifier to drop to PCM processing during this interval. However, because many DVDs contain AC3, DTS and PCM data on different tracks, setting the Mode Sticky parameter too long may cut off the audio from the beginning of AC3, DTS or PCM digital audio bitstreams.

Parameters Sticky - 1.0 Applies to how quickly the preamplifier will react to changes in sample rate, number of speaker channels in the bitstream, etc. Occasionally some players erroneously indicate these changes which causes the preamplifier to needlessly mute and adjust itself to these new parameters. Setting this parameter longer reduces the chance that the preamplifier will respond to an erroneous change but does increase the likelihood of muting the audio at the start of an audio playback.

PLUG AND PLAY TIMING

| | | |
|---|-------------------|-----|
| 1 | Mute Time | 0.5 |
| 2 | Digital sticky | 2.0 |
| 3 | Mode sticky | 1.0 |
| 4 | Parameters sticky | 1.0 |

Zone 2 'B' Second Zone

Level Control - Variable or fixed. The second zone can be configured for a fixed volume level if external volume control is desired.

Max Level - Set the maximum volume for the second zone. This can be used to protect your speakers or ears from inadvertent excessive volume. If Level Control is set to fixed, the max level will define the fixed volume level output for Zone B.

Zone ID - The product ID (IR code set) can be adjusted if operation with other B&K is gear is required. The default ID is 001 for the main theater zone and 002 for Zone B. The preamplifier can be assigned to any ID (B&K code-set) between 001 and 099. This allows ninety nine different B&K surround processors to operate independently using different remote controls. This feature is typically useful if multiple surround processors are used in the same system (B&K CT whole house audio systems). Zone A and Zone B cannot be assigned the same code set. The code-set 000 operates both zones of the preamplifier simultaneously.

NOTE: If the code set of the preamplifier is changed, you will need to reprogram the IR code of the remote control being used. B&K offers the SR10.1 programmable remote (supplied with the B&K AVR507 Series2 and AVR505 Series2), the CK1.2 Keypad or MZ-128 remote.

V2 Output - TAPE or LINE. The V2 output can be configured as an output for a second recording device in Zone B (TAPE). The V2 output can also be configured as a Zone B line output to connect a second zone B video monitor and/or audio amplifier (LINE). As a record output, V2 will output the analog audio and video from the selected input in Zone B except when V2 is selected. This prevents feedback through the recording device which could damage your speakers. As a line output V2 will output the analog audio and video from whatever input is selected in Zone B.

Link input to Zone A - YES or NO. The second zone's source selection may be linked with the Zone A source selection. In operation, whenever a source selection is made in the main theater zone, the source linkage will cause the same source to be selected in the second zone. Independent source selection is still available with the Zone B remote control, but any Zone A source selection supersedes the previous Zone B selection.

Link power to Zone A - YES or NO. Zone B power On/Off may be linked to Zone A. In operation, whenever power is set to ON in Zone A the power linkage feature will cause power to be set accordingly on Zone B. Zone B Independent power On/Off is still operational with the Zone B remote control, but any Zone A power command supersedes the previous Zone B power On/Off.

ADVANCED ZONE B SETTINGS

| | | |
|---|----------------------|----------|
| 1 | Level Control | Variable |
| 2 | Maximum Level | +15 dB |
| 3 | Zone ID | 2 |
| 4 | V2 Output | Tape |
| 5 | Link Input to Zone A | No |
| 6 | Link Power to Zone A | No |

↑↓ next item adjust ←→
MENU advanced setup

FACTORY RESET

Sometimes a factory reset is necessary in order to clear problematic symptoms sometimes experienced in the field. A factory reset will clear all system settings and all presets. A factory reset will also clear any information backed up onto the EEPROM that may have been accomplished by a Memory Backup.

**To perform a Factory Reset on a Reference 50 Series2,
simultaneously press and release the ON/STANDBY, DOWN and MENU buttons.**

Once you see "Reset Preset" on the front panel you can release the buttons. A reset will take approximately 60 seconds.

SR10.1 REMOTE CONTROL OPERATION

Your B&K preamplifier is supplied with a state-of-the-art remote control. The SR10.1 is a computer programmable learning remote. It can be programmed to control any or all of the components in your system using IR. The setup software CD-ROM for the remote is supplied in the box with the SR10.1. You can also download the setup software from the B&K website at www.bkcomp.com/support. **Be sure to perform a Live Update after the software has been installed on your PC.** For instructions on programming the SR10.1 see [page 51](#).



The default program of the remote is setup to control the main theater zone of the B&K preamplifier. Up to 20 devices can be stored and programmed on the remote. 10 devices are pre-programmed onto the main page for convenience. A definition of each default device button is as follows:

- B&K:** Operates the main theater zone of the preamplifier. It is pre-programmed for B&K Control.
- SAT:** Selects the SAT input in the main theater zone.
- DVD:** Selects the DVD input in the main theater zone.
- CD:** Selects the CD input in the main theater zone.
- TAPE:** Selects the TAPE input in the main theater zone.
- TV:** Selects the TV input in the main theater zone.
- V1:** Selects the V1 input in the main theater zone.
- V2:** Selects the V2 input in the main theater zone.
- FM:** Selects and controls the FM tuner in the main theater zone.
- AM:** Selects and controls the FM tuner in the main theater zone.

Each device can be programmed to control the source associated with the input on the B&K preamplifier. The setup software contains a database of various manufacturers' IR codes for devices, such as DVD players, CD players, music servers, TVs and more. IR commands can also be learned directly into the SR10.1 remote from the original source remote control.

The B&K device button in the figure left contains the IR commands that pertain specifically to the B&K preamplifier. Once the B&K device has been selected, press the PAGE button to step through the 4 pages of IR commands for the device. Press the MAIN button to return to main page 1. Press FAV to access favorite stations or common commands. The B&K device button layout is as follows:

- PAGE 1** = Source input selections. The Z button is available for temporarily changing the zone control of the remote. i.e. pressing Z then 2 will control the second zone temporarily.
- PAGE 2** = Audio mode selections.
- PAGE 3** = Imaging adjustments and user EQ selection. SLEEP enables the sleep timer and steps through timer increments. SAVE will save a preset
- PAGE 4** = Center channel, rear channel, subwoofer, bass and treble gains.

The Unit Operation section ([page 40](#)) of this manual documents the various ways of using the functions of the preamplifier from the SR10.1.

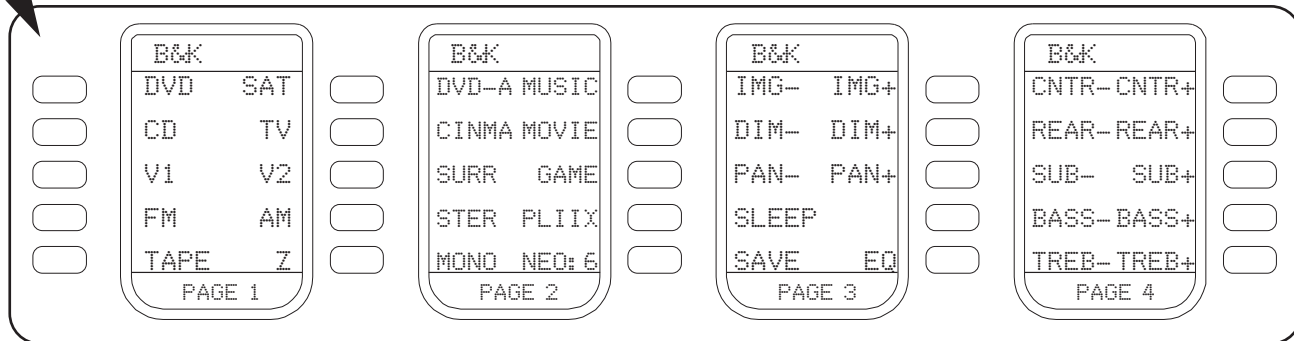
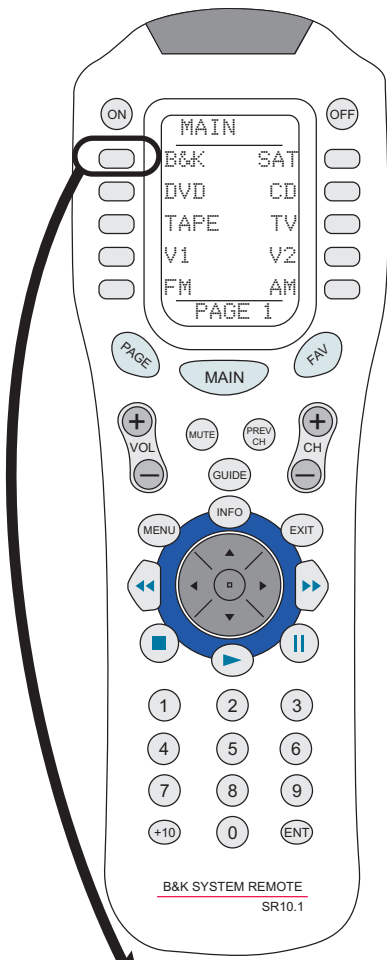

UNIT OPERATION

The following pages outline the normal day-to-day operation of your preamplifier from the supplied SR10.1 remote control. All unit functions can also be directly controlled from the front panel. The SR10.1 remote is capable of controlling both the B&K preamplifier plus other source gear in your system. This section will outline the usage of the SR10.1 Remote with your B&K processor. For a brief overview of the SR10.1 programming software, refer to [page 51](#). The full programming manual is available on our website. All programming software and product manuals are available online at www.bkcomp.com.

Master Power On/Off

The master power switch located on the front panel of your preamplifier must be "ON" (pressed in) for the preamplifier to operate. When this switch is OFF (pressed out) all power is shut off. This will prevent turning it back on with the remote control or keypad. For normal day to day operation, leave the master power switch in the ON position. Use the ON/STANDBY function for daily power on and off. This will allow the preamplifier to be turned on and off from the remote control or keypad.

Whenever turning on the master power switch, you must wait approximately 15 seconds while the processor restores its internal memory and initializes system parameters. You may want to turn off the master power switch only when your preamplifier will be idle for extended periods of time or during periods of power line fluctuations. The memory will not be lost while the master power switch is off.

On / Standby

For normal day to day operation, you will put your preamplifier in STANDBY or by using the ON and OFF buttons of the remote control. Standby mode keeps minimal functions running in order to allow the remote control or keypad to quickly power the unit up. Note that the front panel ON/STANDBY button is lit while your preamplifier is in standby and is not lit when your preamplifier is operating. The front panel display is off during standby. The remote control or keypad has discrete power OFF and ON IR commands to put the preamplifier in and out of standby mode. The power on titles will display every time the unit is brought out of standby mode.

Adjusting Volume

The front panel VOLUME control knob will control the volume. The volume knob is on the right side of the front panel. Volume can also be adjusted up or down using the remote control or a keypad. Volume ranges from -96dB to +15dB. 0dB is Dolby Reference level.

Center, Rear and Subwoofer Volume

The center channel, rear channels (surrounds and backs together) and/or the subwoofer volume levels can be tweaked independently. To adjust the volume for these channels, use the CNTR-/+, REAR-/+ or SUB-/+ from the remote control to adjust. These are temporary level adjustments and will reset to zero after an input change or standby on/off.

Source Selection

The front panel is equipped with a Source knob that allows you to rotate it to select any of the 7 inputs or the internal AM and FM tuner. The source knob is on the left hand side of the front panel. From the remote, press the button corresponding to the input you wish to select.

When using DVD-Audio, it is recommended to set DVD-Audio as the default audio mode for that particular input. If DVD-audio is not set as the default mode, first select the input to which DVD-Audio has been assigned, then press the DVD-A button from the remote control.

Z1 Operation - Theater

The Z1 Operation menu is provided to aid in the Theater zone operation. It does not have to be used in order to control the Theater zone. To access this menu, press the Menu button on the remote or front panel, scroll down and select choice three; Z1 Operation - Theater. This menu provides current settings for the main Zone A. The audio input and video input can be selected independently. If the Tape input is selected, the tape output for recording can be selected independently. If the AM or FM tuner is selected, the frequency can be changed. The master volume and individual speaker volumes for center, sub and rear (surrounds and backs together) can be adjusted. The surround mode and number of speakers used can be selected. If a 2-channel music mode is selected, hitting ENTER when Mode is selected will allow adjustment to the music mode parameters. The user EQ selection can be made. If the variable EQ is selected, pressing ENTER will allow you to adjust the bass and treble settings for the variable EQ. Any changes made in this menu will be reset when the input is changed. This operation menu is very helpful when setting up presets. You can see exactly what settings you have setup up before the preset is saved. To save a preset press the SAVE button. See [page 49](#) for more information on presets.

```

ZA OPERATION
Source FM      Stereo  103.3
Video V1      Volume -10.0
Mode Surround Center  +3.5
DPLIIX Music  Rear   -1.5
Spkrs        6 Sub   +1.5
Eq 2 Loudness
↑↓ next item  adjust ←→
0..9 +10 recall preset SAVE
MENU main menu

```

Sleep Timer

The preamplifier contains a sleep timer. The sleep timer has the ability to turn the preamplifier off (set to Standby) after a set time period. Sleep timer options span from 30 minutes up to 4 hours in 30 minute increments. Repeatedly pressing the sleep button will step through the timer increments. The sleep button is located on page 3 of the B&K device on the supplied SR10.1 remote control.

Z2 Operation - Second Zone

The Z2 Operation menu is provided to aid in the operation of the second zone. It does not have to be used in order to control the second zone. To access this menu, press the Menu button on the remote or the front panel, scroll down and select choice four; Z2 Operation - 2nd Zone. The audio input and video input can be selected independently. If the V2 input is selected, the V2 output for recording can be selected independently. If the AM or FM tuner is selected, the frequency can be changed. The master volume can be adjusted. Any changes made in this menu will be reset when the input is changed. This menu is very helpful when setting up presets. You can see exactly what settings you have setup up before the preset is saved. To save a preset press the SAVE button. See [page 49](#) for more information on presets.

```

ZB OPERATION
Power Off
Source DVD      Record DVD
Video DVD      Volume -25.0

↑↓ next item  adjust ←→
0..9 +10 recall preset SAVE
MENU main menu

```

Zone Operation Button

To set the preamplifier for temporary operation of either Zone 1 or Zone 2 use the Zone (Z) button on the SR10.1 remote. It is located on page 1 of the B&K device. See [page 39](#) for default remote layout. Press the zone button, then the zone ID code. The default zone codes are as follows:

- 1 - Operates the main theater zone.
- 2 - Operates the second zone.
- 0 - Operates both zones simultaneously.

Once the zone button and zone ID is pressed, the remote control will temporarily operate the zone until three seconds elapse with no command issued. The zone ID can be changed if desired (theater zone [page 33](#) or second zone [page 38](#)).

If a permanent method of controlling other zones is desired, the SR10.1 can be reprogrammed with the appropriate zone code assigned to one of the device buttons.

AM / FM Tuner Operation

All TUNER operations require the preamplifier source be set to TUNER. Press the FM or AM button to access the tuner.

Manual Tuning - From the remote control or the front panel, tap the UP or DOWN arrow to tune one frequency step at a time. Hold the up or down arrow to automatically seek up or down to the next available strong station. Very strong stations may cause seeking to stop one step away from the station's actual frequency. Check one step above or below if you are not sure. Your favorite stations can be saved in presets (see [page 49](#)).

Direct Frequency Entry Tuning - To directly recall a tuner frequency, press the FM or AM button, then enter the frequency of the station within the next 3 seconds.

Example - Button press steps for directly entering the radio station for 103.3 FM = FM - 1 - 0 - 3 - 3

Headphone Operation

Headphone mode allows output of the source selection using a set of headphones. The headphone jack uses a 1/4" (6.3mm) stereo jack. From the remote control select STEREO - 0. SURROUND - 0 is identical to STEREO-0. To select headphone mode from the front panel, select a source, press the MODE button. Press the UP or DOWN arrows to step through until the preamplifier switches into headphone mode. When in headphone mode, CONTROL OUT #1 is set to off (default). This feature allows your preamplifier to turn off external amplifiers or powered subwoofers with compatible 12VDC CONTROL inputs. The preamplifier will mute the surround output channels when in headphone mode. Headphone mode can also be set up to be recalled using a preset. (See speaker selection [page 47](#)).

While in 'HEADPHONE', equalization features of the preamplifier remain operational. The unit will stay in headphone mode until a different speaker selection is made. This feature allows the 'Headphone' selection to stay in effect until the unit is put into STANDBY.

WARNING: In order to provide full range audio to your headphones, it is necessary to override the bass management processing in your preamplifier. If you are using external amplifiers or powered speakers with no CONTROL OUT capability then full range audio will be sent to your front left and right speakers. If you have small front speakers we strongly suggest you manually turn off your external amplifiers or powered speakers before selecting 'HEADPHONE' operation. Otherwise speaker damage may occur.

FRONT PANEL DISPLAY OPERATION

The front panel display is capable of displaying 16 characters. The first five characters identify the current source input. The remaining 10 characters identify the the audio mode and the number of active speakers. All changes to volume, input, audio mode, etc. will be displayed for a few seconds on the front panel. When no changes are in progress, the front panel will display the input and surround mode. Some abbreviations are necessary. The various abbreviations are as follows:

Display definitions:

| | | | | | |
|-----|--------------|------------|--------------------|------------|-----------------------------|
| 4 | = 4 Surround | DTS | = DTS | DOLBY D | = Dolby Digital |
| 4B | = 4 Back | DTS ES DSC | = DTS Discrete 6.1 | DOLBY D EX | = Dolby Digital Surround EX |
| 5 | = 5 Surround | DTS ES MTX | = DTS Matrix 6.1 | PL2X | = Dolby Pro Logic IIx |
| 5B | = 5 Back | NEO6 | = DTS NEO:6 | | |
| SUR | = Surround | | | MU | = Music mode |
| | | | | MV | = Movie mode |

Processor Status

Processor status will display after an input selection or any time by pressing the INFO or ENTER button on the remote control. INFO will display the status on both the OSD and front panel, while ENTER will display status on the front panel only. The info status will display status for the source input selection, bitstream type, sampling rate, video type, audio mode, speaker selections, EQ setting, and surround processing types. The video source type is very important if you are mixing component, composite and S-video types. It will describe the video type the processor is using. The bitstream and speaker channel information is particularly important with DVDs since they may or may not contain certain soundtracks. When you initially start the DVD you may get a Dolby Digital (AC3) 2.0 soundtrack. To get the best possible sound, you may have to use the DVD player's menu system to activate the Dolby Digital 5.1 or DTS-ES multi-channel soundtracks. The last line will provide additional information about the surround or cinema mode processing currently in use. If you need to call B&K regarding a problem with your preamplifier be sure to note the status display before calling.

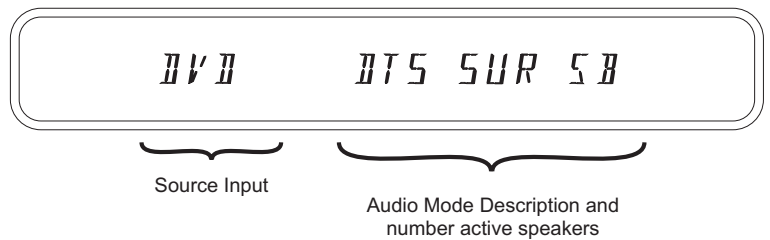

The info status will display status for the source input selection, bitstream type, sampling rate, video type, audio mode, speaker selections, EQ setting, and surround processing types. The video source type is very important if you are mixing component, composite and S-video types. It will describe the video type the processor is using. The bitstream and speaker channel information is particularly important with DVDs since they may or may not contain certain soundtracks. When you initially start the DVD you may get a Dolby Digital (AC3) 2.0 soundtrack. To get the best possible sound, you may have to use the DVD player's menu system to activate the Dolby Digital 5.1 or DTS-ES multi-channel soundtracks. The last line will provide additional information about the surround or cinema mode processing currently in use. If you need to call B&K regarding a problem with your preamplifier be sure to note the status display before calling.

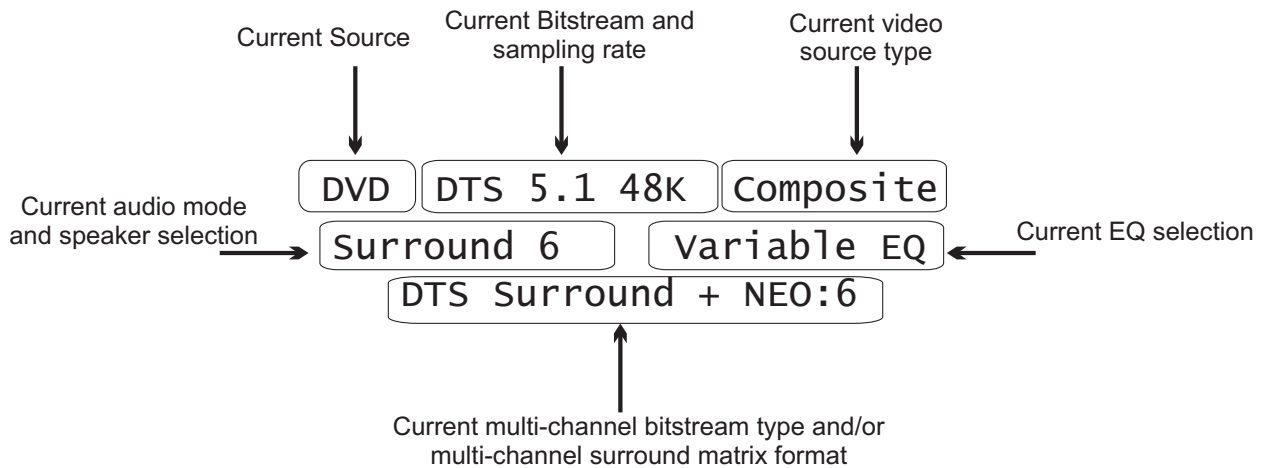

Note: Status display will scroll through each line of the display message on the front panel of the preamplifier. The ENTER button will not trigger the OSD.

The following tables represent a visual synopsis of how the front will respond depending on the audio mode, number of speakers and the audio signal type. The first table shows how the front panel will display multi-channel digital bitstreams. The second table shows how the front panel will display two channel audio types.

Digital Multi-Channel Bitstreams

| # of Speakers Used | Front Panel Display | | | |
|--------------------|---------------------|-----------|--|--|
| | MONO | STEREO | SURROUND | CINEMA |
| 1 | Mono 1 | Mono 1 | Mono 1 | Mono 1 |
| 2 | Mono 2 | STEREO 2 | STEREO 2 | STEREO 2 |
| 3 | Mono 3 | STEREO 3 | DOLBY D 3 DTS SUR 3 | DOLBY D 3 DTS SUR 3 |
| 4 Surrounds | Mono 4 | STEREO 4 | DOLBY D 4 DTS SUR 4 | DOLBY D 4 DTS SUR 4 |
| 4 Backs | Mono 4B | STEREO 4B | DOLBY D 4B DTS SUR 4B | DOLBY D 4B DTS SUR 4B |
| 5 Surrounds | Mono 5 | STEREO 5 | DOLBY D 5 DTS SUR 5 | DOLBY D 5 DTS SUR 5 |
| 5 Backs | Mono 5B | STEREO 5B | DOLBY D 5B DTS SUR 5B | DOLBY D 5B DTS SUR 5B |
| 6 | Mono 6 | STEREO 6 | DOLBY D EX DOLBY D MU DOLBY D MV DTS ES DSC DTS ES MTX | DOLBY D EX DOLBY D MU DOLBY D MV DTS ES DSC DTS ES MTX |
| 7 | Mono 7 | STEREO 7 | DOLBY D MU DOLBY D MV DTS SUR MV DTS SUR MU | DOLBY D MU DOLBY D MV DTS SUR MV DTS SUR MU |

Analog, PCM, AC3 2.0

| # of Speakers Used | Front Panel Display | | | |
|--------------------|---------------------|-----------|--|--|
| | MONO | STEREO | SURROUND | CINEMA |
| 1 | Mono 1 | Mono 1 | Mono 1 | Mono 1 |
| 2 | Mono 2 | STEREO 2 | STEREO 2 | STEREO 2 |
| 3 | Mono 3 | STEREO 3 | PL2X MV 3 PL2X MU 3 NEO6 MU 3 NEO6 MV 3 | PL2X MV 3 PL2X MU 3 NEO6 MU 3 NEO6 MV 3 |
| 4 Surrounds | Mono 4 | STEREO 4 | PL2X MV 4 PL2X MU 4 NEO6 MU 4 NEO6 MV 4 | PL2X MV 4 PL2X MU 4 NEO6 MU 4 NEO6 MV 4 |
| 4 Backs | Mono 4B | STEREO 4B | PL2X MV 4B PL2X MU 4B NEO6 MU 4B NEO6 MV 4B | PL2X MV 4B PL2X MU 4B NEO6 MU 4B NEO6 MV 4B |
| 5 Surrounds | Mono 5 | STEREO 5 | PL2X MV 5 PL2X MU 5 NEO6 MU 5 NEO6 MV 5 | PL2X MV 5 PL2X MU 5 NEO6 MU 5 NEO6 MV 5 |
| 5 Backs | Mono 5B | STEREO 5B | PL2X MV 5B PL2X MU 5B NEO6 MU 5B NEO6 MV 5B | PL2X MV 5B PL2X MU 5B NEO6 MU 5B NEO6 MV 5B |
| 6 | Mono 6 | STEREO 6 | PL2X MV 6 PL2X MU 6 NEO6 MU 6 NEO6 MV 6 | PL2X MV 6 PL2X MU 6 NEO6 MU 6 NEO6 MV 6 |
| 7 | Mono 7 | STEREO 7 | PL2X MV 7 PL2X MU 7 NEO6 MU 7 NEO6 MV 7 | PL2X MV 7 PL2X MU 7 NEO6 MU 7 NEO6 MV 7 |

AUDIO MODES & SPEAKER SELECTIONS

B&K incorporates a state-of-the-art software and hardware system that will prioritize the incoming audio signals (Plug n Play) and accordingly select the appropriate number of speakers, two-channel surround decoder (Dolby Pro Logic IIx or DTS NEO:6) or multi-channel surround mode (Movie or Music) depending on the user's preference. Multi-channel encoded bitstreams (DTS and Dolby Digital) are automatically detected and selected for any input. When a Dolby Digital or DTS multi-channel bitstream is detected, the number of speakers in the speaker setup menu are selected automatically. Plug n Play will give priority to digital bitstreams. If there is no multi-channel or two-channel digital bitstream present, Plug n Play will revert to the analog audio (left and right) inputs using the default audio mode.

This preamplifier includes five audio listening modes; mono, stereo, surround, cinema and DVD-audio. *Each* input (7 inputs) can be configured for *each* audio mode (4 audio modes), plus the DVD-Audio mode (see [page 29](#)). The preamplifier will store user preferences for each audio mode resulting in a *one touch* solution for recalling specific settings for various types of multi-media formats. For normal operation, the Setup Inputs preferences should be configured for the "favorite" (default) setting for each input. Occasionally, you may want to change the audio mode or speaker selection being used with an input. To quickly change the audio mode simply select Mono, Stereo, Surround, Cinema or DVD Audio via the remote control or the front panel Mode button. In addition, you may choose an audio listening mode immediately followed by a speaker selection. For example pressing STEREO-7 will select 7 speaker stereo mode. Pressing SURR - 5 will select 5 speaker surround. If you are listening to a *2-channel bitstream*, you may change the surround decoder (Dolby Pro Logic IIx or DTS Neo:6) and the operating mode of the surround decoder (Movie, Music, Game) using the corresponding buttons on the remote. From the front panel use the MODE button to step through surround modes and decoder types. Use the UP and DOWN arrows to select the desired number of speakers.

Audio Mode Usages

MONO - The audio signals are summed or downmixed to produce a single mono channel which can then be distributed evenly to the desired number of speakers. It is also useful in the case of a large listening group when it is difficult to put everyone near the optimum listening position. To quickly recall the mono mode from the remote control, press the MONO button then the number of desired speakers 0-9 (see table [page 47](#)). From the front panel press the MODE button, then the up and down arrows to select the number of speakers.

STEREO - The unmodified Left and right audio signals are evenly distributed to the desired number of left and right speakers. The center channel speaker receives a mono mix. Use this mode for true stereo listening or for expanding the stereo image to additional speakers. To quickly recall the stereo mode from the remote control, press the STER button then the number of desired speakers 0-9 (see table [page 47](#)). From the front panel press the MODE button, then the up and down arrows to select the number of speakers.

SURROUND - This mode is used to extract multi-channel surround information from a 2-channel audio source using one of the two available surround decoder types (DTS NEO:6 & Dolby Pro Logic IIx). To quickly recall the surround mode from the remote control, press the SURR button then the number of desired speakers 0-9 (see table [page 47](#)). To select surround from the front panel press the MODE button to scroll through the audio modes, then the UP and DOWN arrows to select the number of speakers. Movie or music mode have their own discrete IR command buttons for selection.

You have a choice of two methods for simulating multi-channel sound from a two channel source - Dolby Pro Logic IIx and DTS Neo:6. These decoders use different formulas for creating the simulated multi-channel soundfield. Each decoder type provides a MOVIE and a MUSIC mode. MOVIE places greater emphasis on the back speakers and MUSIC places greater emphasis on the surrounds. Dolby Pro Logic IIx and DTS provide an adjustable MUSIC mode. MUSIC mode adjustments are for the center image (width), surround image (dimension), and front-to-surround image (panorama). Use the IMG+/-, DIM+/- and PAN+/- buttons on the remote to adjust the various parameters for how the surround field is created. MOVIE mode is fixed and has no adjustment options. Continued on next page...

Material correctly mixed for Dolby Pro Logic contains no bass information in the surround channels and therefore, Dolby requires that no surround bass is mixed to the subwoofer when you have small surrounds. However, many video game systems do end up with bass information in the surrounds. In order to prevent loss of this bass information, PLIIx also provides GAME mode. GAME mode is otherwise identical to the MOVIE mode. NEO:6 has no such requirements on surround bass - surround bass is allowed to be mixed to the sub regardless of the mode selected. NEO:6 has no GAME mode.

The Surround mode is also used for multi-channel encoded bitstreams such as Dolby Digital and DTS-ES. Selecting SURROUND-5 passes the 5 main channels unmodified to the fronts, center, and surround speakers. Surround-6 engages Dolby Digital Surround EX or DTS Surround ES processing. Dolby Digital EX must be selected manually. Both of these processes extract monophonic information from the surrounds and places it in the back speaker(s). This is effective for material that has been mixed specifically for EX/ES, but may drastically reduce surround information for material that is not specifically mixed for 6-channels. Dolby provides a variation of Pro Logic IIx for processing surround and back channels for 5.1 material to make 7.1. Press SURROUND-7 to access this mode. Back speakers will contain 2 independent channels (stereo backs).

SURROUND-7 is the recommended mode for 5.1 material played back in seven channels. However, DTS provides two variations for 6.1 material; DTS-ES Matrix (MTX) and DTS-ES Discrete. DTS-ES Matrix (MTX) is specifically mixed to provide a single matrix surround back channel. The preamplifier will automatically select SURROUND-6 for ES MTX material with the same surround back information in both back channels (mono). DTS-ES Discrete (DSC) provides a completely independent discrete back channel. The preamplifier will automatically select SURROUND 6 for ES DSC material.

Cinema Mode - CINEMA mode is identical to SURROUND mode except that it adds high-frequency roll off to the front and center channels to compensate for certain movie soundtracks. In a movie theater the left, center, and right front speakers are typically located behind the movie screen. The movie screen tends to reduce the high frequency response. To compensate for this, movie soundtracks are mixed with boosted high frequencies. Often, this compensation is not removed when transferring the movie to DVD. B&K provides CINEMA mode to remove this undesirable high frequency boost. If a movie seems to have overly bright or harsh sound, use CINEMA mode. CINEMA mode is otherwise identical to surround mode, providing all of the same choices PLIIx, NEO:6, MOVIE, MUSIC, etc. However, CINEMA is not usually required for music material.

DVD Audio (SACD) - Use this audio mode with the analog outputs of a DVD-Audio player or any other 5.1 analog audio source device. To quickly recall the DVD-Audio mode from the remote control, press the DVDA button then the number of desired speakers 0-9 (see [page 47](#)). DVD-AUDIO - 5 is a direct analog pass-through. No equalization is applied to the DVD Audio input.

Note: In order to select the DVD-Audio mode, the source input assigned to the DVD-Audio mode must be selected before selecting the DVD-Audio mode. If no DVD Audio input is assigned (factory default), the DVD Audio mode is inactive.

Why do I need all these audio modes?

With the wide variety of audio source material available today, i.e. 2 channel stereo, 2 channel surround and multi-channel encoded audio, we believe that the reproduction of this material is best handled in audio categories. We have decided to define five "audio modes" which are actually different Plug and Play modes of operating our audio processor. Simply selecting an Audio Mode will automatically recall a plethora of user designated settings associated with each mode. Those settings are then applied to the audio signal being received. The Plug and Play system simplifies the process further by automatically detecting a bitstream and selecting a maximum number of speakers, so the user doesn't have to. Any of the five Audio Modes can be designated as "default" per each input.

Speaker Selections

The table below shows how your preamplifier will route audio information to the speaker channels depending on audio modes and speaker selection combinations. Audio information will not be lost in any speaker selection. The information for the missing speakers is mixed to other active speakers. When selecting four or five speakers, choose from the surround or back speakers. When the system setup is correctly performed, the preamplifier will route audio to fewer small speakers with the needed corrections to volume and "down mixing" applied automatically.

NOTE: The number provided on the left side of the table defines the speaker option that can be selected immediately after an audio mode selection from the SR10.1 remote control. For example, pressing STEREO-2 will select the front left and right speakers plus the subwoofer. Pressing SURROUND-7 will select the surround mode using seven speakers plus the subwoofer.

| | Speaker selection | Audio Mode | | | | |
|---------------------------|---------------------------------|------------|--------|----------|--------|-----------|
| | | Mono | Stereo | Surround | Cinema | DVD-Audio |
| M = Mono | Select 0 (Headphone) | | | | | |
| C = Center | Select 1 | | | | | |
| L = Left | Select 2 | | | | | |
| R = Right | Select 3 | | | | | |
| Lt = Downmix left | Select 4 Surround | | | | | |
| Rt = Downmix right | Select 4 Back | | | | | |
| Sb = Surround back | Select 5 Surround | | | | | |
| SI = Surround left | Select 5 Back | | | | | |
| Sr = Surround right | Select 6 | | | | | |
| Sbl = Surround back left | Select 7 | | | | | |
| Sbr = Surround back right | Select 8 (Analog Direct) | | | | | |
| | Select 9 (Bitstream downmix) | | | | | |

EQUALIZATION SETTINGS AND ADJUSTMENTS

The preamplifier provides 3 ways to modify the frequency response (equalization) for particular listening situations. These equalization are in addition to the room equalization and room resonance adjustments made in the speaker setup menu. Pressing the EQ button consecutively on the remote control will step through the preamplifier's user EQ selections. To quickly select an EQ, press EQ, then the EQ number. Equalization is not available for DVD-Audio, Direct, or LtRt Modes.

The available user EQ's are defined as follows:

0 Flat - No equalization applied.

1 Variable - User designated EQ settings. To adjust the variable EQ from the OSD, highlight the Variable EQ selection from the Z1 Operation - Theater Zone Menu. Press the ENTER button to access and adjust the variable EQ settings as shown. Bass and treble level adjustments can be made using the LEFT and RIGHT arrows. Your preamplifier allows the designation of the frequency at which the bass and treble adjustments occur.

LFE gain can be adjusted. Note that this affects only the separate LFE (.1) track available on Dolby Digital and DTS material it has no effect on the reproduction of normal bass from the front, center, or surround channels.

The dynamic range (Dolby Night-time mode) can be limited for late night listening while processing Dolby Digital or DTS bitstreams.

2 Loudness - The human ear's frequency response varies with volume level. At high levels it has relatively flat response, while at low levels its sensitivity to high and low frequencies are reduced. The loudness equalizer is designed to cancel the ear's frequency response anomalies to provide consistent tone at all volume levels. Note that you will hear little difference using the loudness control at high volumes as it has its greatest effect at lower volume levels.

3 Vocal - Frequency gains have been cut on both the high and low end for vocals only listening. This is useful for late night listening as it allows you to hear the dialogue, but reduces the volume of sound effects which might disturb others. Unlike Dolby Digital/DTS nighttime modes, the vocal filter is effective for all source material including PCM and analog.

This equalizer is also effective in reducing the vocal boominess often associated with FM talk radio. Some crackly old movie soundtracks will have improved clarity with the vocal filter on.

The table below outlines how the various EQs can be applied in each audio mode. To manually select an EQ, press the EQ button on the remote control followed by the EQ#.

| Equalizer | | Audio Mode | | | | | |
|-------------------|------|----------------|----------------|----------------|----------------|-----------|----------|
| EQ Name | EQ # | Mono | Stereo | Surround | Cinema | DVD Audio | Direct |
| Off (Flat) | 0 | No EQ | No EQ | No EQ | No EQ | No EQ | No EQ |
| Variable | 1 | User set | User set | User set | User set | bypassed | bypassed |
| Loudness | 2 | fixed response | fixed response | fixed response | fixed response | bypassed | bypassed |
| Vocal | 3 | fixed response | fixed response | fixed response | fixed response | bypassed | bypassed |

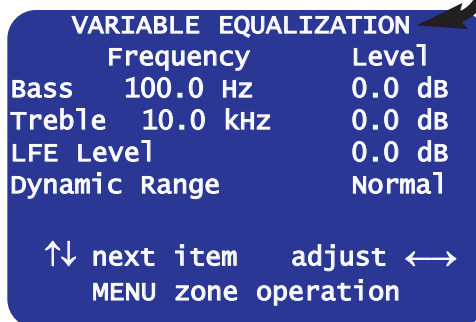
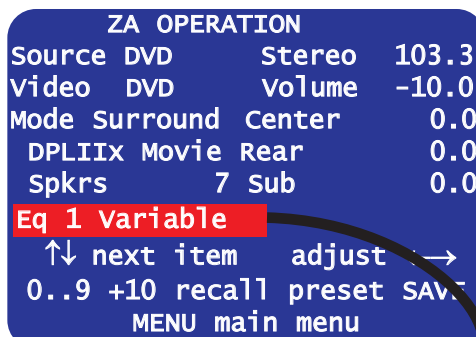

PRESETS

Saving a user preset is like taking a virtual picture of ALL USER settings in the preamplifier. This preset may then be recalled at any time. Up to 40 presets may be saved in either the main theater zone or the second zone. Presets provide a powerful method to recall favorite settings. Presets are easily recalled from the SR10.1 remote control. The parameters that may be saved with a preset are:

| | | |
|--------------|-------------------|-----------------------|
| Audio Source | Speaker Selection | Center channel volume |
| Video Source | Radio Station | Subwoofer volume |
| Audio Mode | User EQ | Rear channels volume |
| Volume | Record Loop | |

Preset titles can be customized according to the preset function. The following steps outline the procedure to save a preset.

Quick Preset Outline - Set the unit exactly for the desired user settings. Press the SAVE button. Then select the preset number you want to save it to. Press ENTER to save the settings. To recall a preset, press the preset number, then ENTER.

Saving a Preset

The following steps detail the procedure that is used to setup and save a preset. The procedure references the SR10.1 Remote Control that came with the Reference 50 Series 2 preamplifier.

Step 1

First, setup the preamplifier for the desired speaker selection, input, volume level and/or EQ. The Z1 or Z2 Operation Menu is helpful when setting up system parameters. It is accessed from the first page of the On Screen Setup menu.

Step 2

From the SR10.1 remote, press the B&K button in the upper left corner of the remote screen. Then press the PAGE button two times. In the lower left corner of Page 3, you will see the SAVE button. Press the SAVE button one time. Pressing the SAVE button will activate the on screen display. The on screen display will show the settings of the preset that is about to be saved. If a preset is saved from the front panel, pressing ENTER and PRESET at the same time acts like the SAVE button.

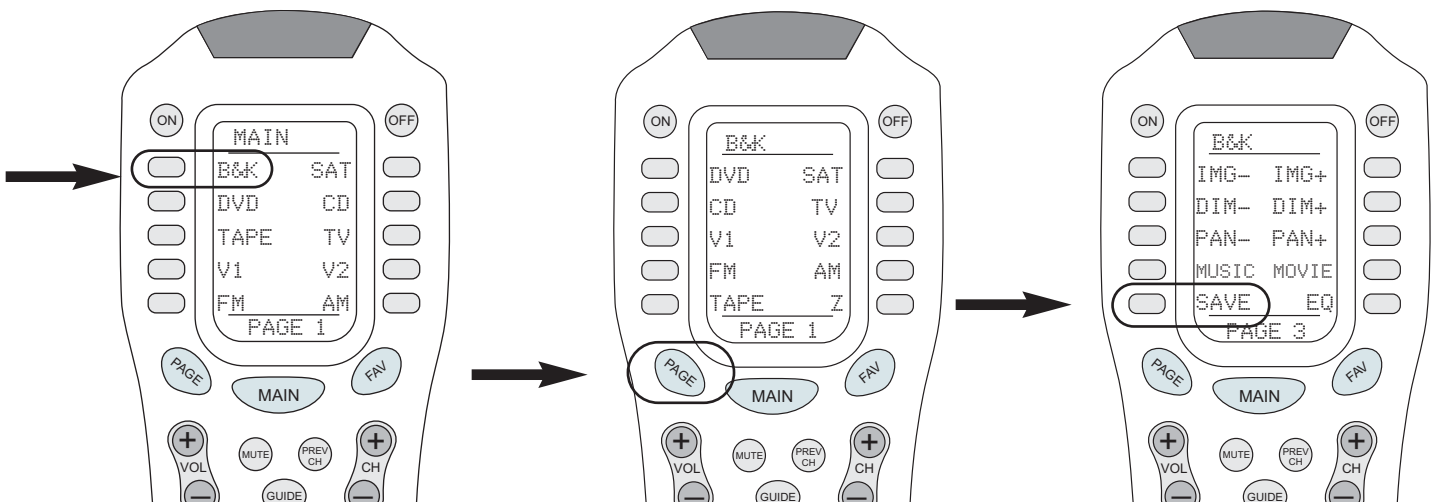

Step 3

Select the preset number. If you wish to save the preset to a particular number, you can directly select the preset number from the number pad on the remote control. Use the +10 button to choose presets above the number 10. For example: 12 is selected as +10 button then the number 2 button (+10 - 2).

Use the left and right arrows from the thumb pad to select the preset number to save. If a preset number is not chosen, the preset will saved to the next un-used favorite preset number.

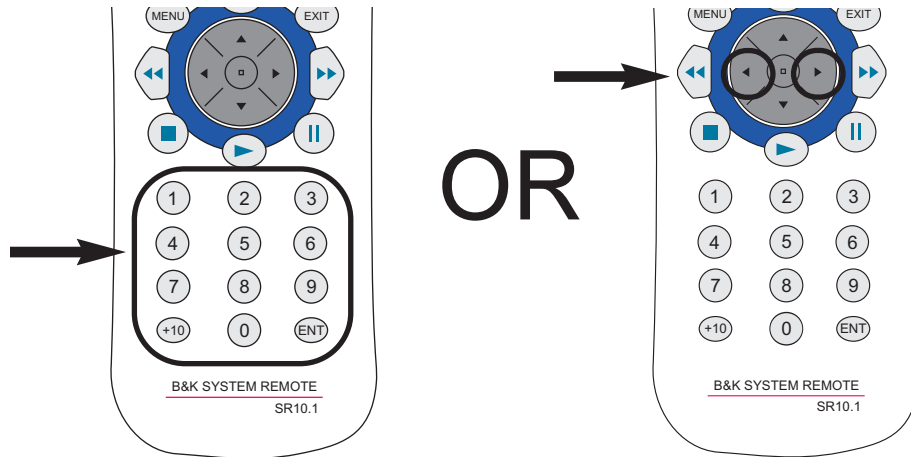

Step 4

Press the ENTER button or the center of the thumb pad when you are satisfied with the preset settings. Once the ENTER button is pressed, SAVING SETTINGS will be displayed.

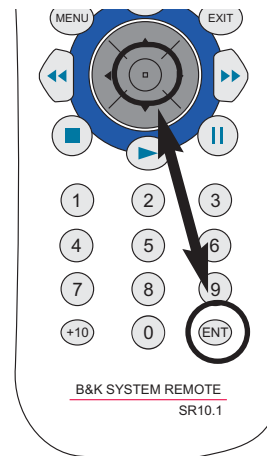

Step 5

Once the settings have been saved, the preset can be named or re-named with a custom title. If Preset Auto Naming is ON, then the processor will automatically assign a generic name to the preset (see [page 30](#)). Use the thumb pad UP or DOWN to change the blinking character. Use left/right to move to a different character. Press ENTER again to save the name. From the front panel use UP or DOWN buttons to change the character and the volume knob to mode to a different character.

To save the preset name from the front panel, press the PRESET and ENTER buttons simultaneously to save preset settings. The PRESET and ENTER buttons operate the same as the SAVE button would from the remote.

| | |
|-----------------|--------------|
| SAVE PRESET 1 | DVD SUR |
| New Name | DVD -56 dB |
| Source DVD | Record DVD |
| Video DVD | Volume -56.0 |
| Mode Surround | Center 0.0 |
| PLIIX Movie | Rear 0.0 |
| Spkrs 7 | Sub 0.0 |
| EQ 1 Variable | |
| 0..9 +10 preset | preset ←→ |
| ENT save preset | cancel menu |

Recalling a Preset

To recall a preset from the SR10.1 remote control, press the preset number, then the ENTER button. For example, to recall preset number 2, press 2 - ENTER. Three steps are necessary in the case of a preset above the number 10, (preset 12 = +10 - 2 - ENTER).

To recall a preset from the front panel, press the PRESET button to scroll through the saved favorite presets. Once the desired preset is found, press the ENTER button to recall the preset.

If a preset is recalled in zone two, then the zone code for Zone B (002 default) must be used to recall the preset.

Favorite Presets

The preamplifier saves a list of favorite presets which can be quickly accessed using the channel up/down button on the remote, or the PRESET button on the front panel. The preamplifier can be setup to recall the chosen favorites instantly or only after an ENTER command. When a preset is saved it is automatically added to the favorites list. The list can be edited in the favorites menu (page 30). If there are no favorites in the list, then CHANNEL or PRESET will step through all 40 presets.

SR10.1 REMOTE EDITOR SOFTWARE

The SR10.1 is supplied with a CD-ROM containing the setup program. This software can also be obtained from the B&K website. **After SR10.1 editor program has been installed, be sure to do a LIVE UPDATE.** The live update is found under Help ->Live Update. A live update ensures that you have the latest version of setup software. Your PC will need to be connected to the internet to execute the update. The editor software can be used to program your SR10.1 to control other source devices your system may contain. The SR10.1 can be programmed to control devices such as DVD players, CD players, music servers, satellite set top boxes, TVs, and more. You can customize particular devices so frequently used commands are readily accessible.

SR10.1 Editor

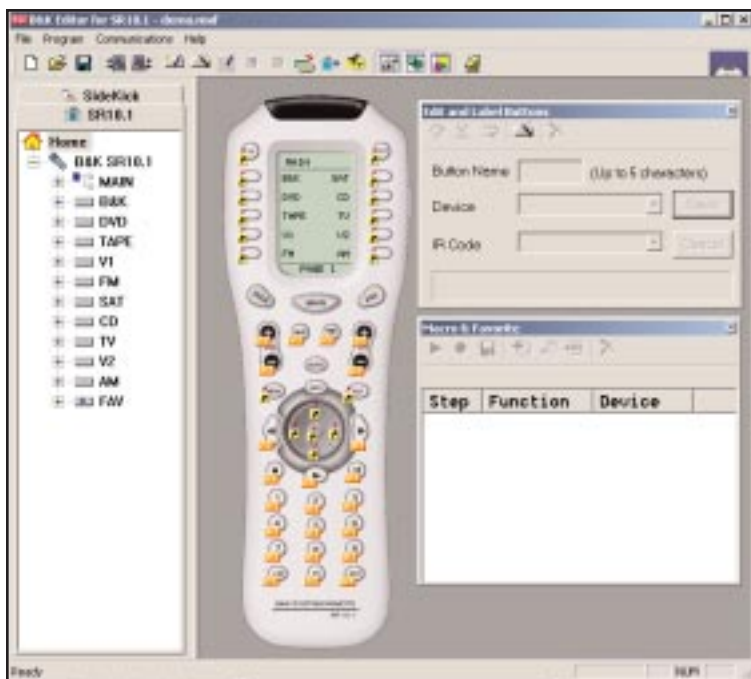

The following pages summarize some key points of the programming software. The full version of the programming manual is found under Help -> User Guide or go to www.bkcomp.com.

The SR10.1 comes pre-programmed with 10 devices. Each device is pre-programmed on the Main Page 1 of the SR10.1. Each device button is labeled to match the inputs on the back panel of the preamplifier. Pressing a device button will change the input on the preamplifier. Once a device button is pressed, the remote will automatically flip to page one to display device functions. Page one of the device can contain specific commands to control the source component. For example, pressing DVD will change the preamplifier to the DVD input and then show the controls for the DVD player.

The editor software can also be used to program macros to further simplify the operation of your system. A macro is a series of recorded IR steps that can be executed with one button press. A simple macro might execute a preset recall, a more complex macro can be setup to turn ON all source devices or turn OFF all source devices.



Blank - A button with no flag will not do anything when pressed. It is empty and has no programming.



IR Command - A red dot indicates that the button is programmed with an IR database command. An IR database command can be pressed or pressed and held for a scrollable command (such as volume). All buttons except the MAIN and FAV devices can be programmed with IR database codes (you cannot program the navigation buttons-PAGE, MAIN or FAV either). To program IR database commands, goto PROGRAM -> IR DATABASE. Program IR devices according to make and model.



Shortcut - A black arrow on yellow square indicates that the button is programmed with a shortcut. A shortcut is a pointer to a IR database command. A shortcut can be made to various commands within any device. To make a shortcut, choose the button on the virtual remote, then click the DEVICE drop down in the Edit and Label buttons window and select the device to shortcut to. Click the IR CODE drop down. The drop down displays the list of commands within a device. Once you select the command you want to shortcut to, click SAVE. The diagram below illustrates putting the B&K command for the NEO:6 decoder in the DVD device as a shortcut.

Creating a Shortcut

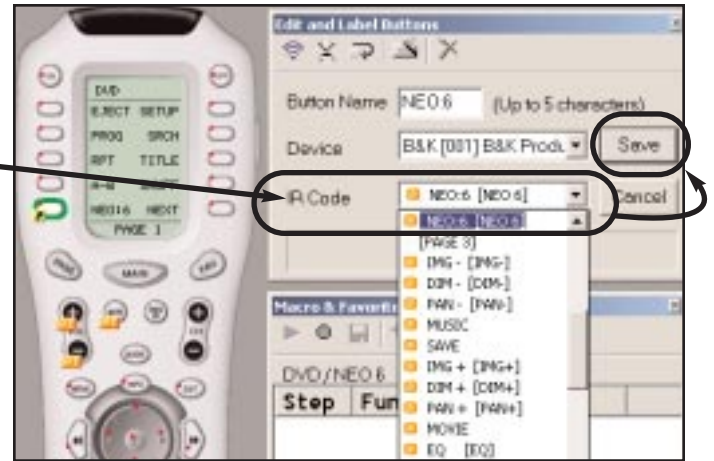
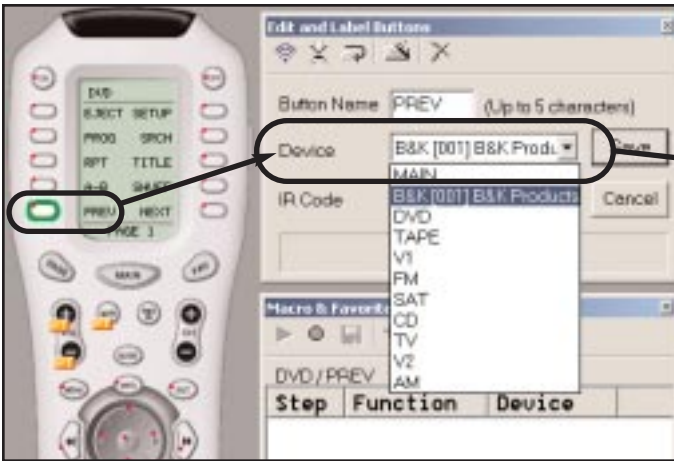

Punch Through - A PT flag indicates that the button is programmed to "Punch Through" to another device. Punch throughs are used for programming multiple devices for volume, channel, numbers, play stop and pause. Punch throughs can eliminate the need to navigate the remote control for simple functions such as volume. The Punch through window is a fast way to assign multiple Punch throughs quickly.

To set up a punch through, goto PROGRAM -> PUNCH THROUGH. The 'Punch To' column defines the devices that will have control from a different device assigned to certain buttons within the device. In the 'Punch From' column, select the device from where the IR codes will source from. For example, devices such as DVD players do not usually control volume, the punch through for volume will Punch From B&K for the DVD device. This way, the B&K volume will be controlled when the DVD is selected.

Once the punch throughs are set, click SAVE.

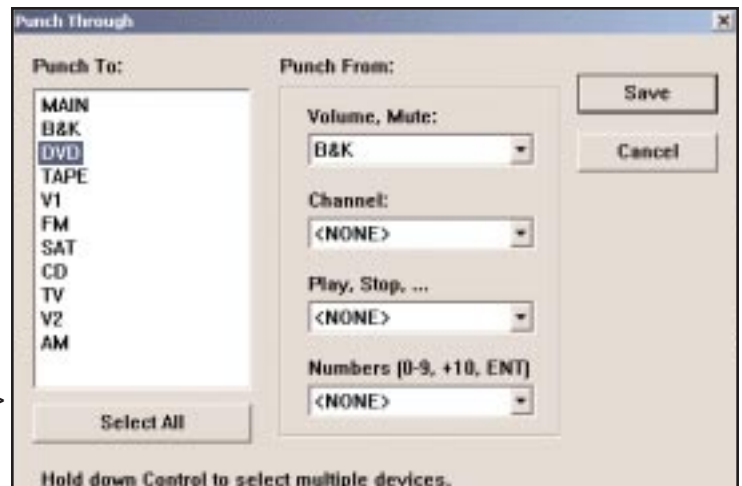

M **Macro** - An 'M' or 'F' flag indicates that the button is programmed with a Macro (the F flag indicates the Macro is on one of the Favorites pages). Only the LCD buttons and the Power ON and Power OFF buttons can be programmed with MACROS. Hard buttons cannot be programmed with MACROS directly. A macro with a single step cannot be pressed and held for a sustained burst. In order to make a macro, you must make a recording of the steps you want to execute. To start a macro recording, click the RECORD icon in the Macro & Favorite window. Once the macro has begun recording, navigate through virtual keypad within the software and find the command(s) you wish to execute with the macro. Once the macro is complete, click the SAVE icon located right next to the Record icon. The macro in this example shows how a power-on macro can also recall a preset, in this case preset one. There are three steps involved in order to turn power on and recall a preset: The button press for power on, the button press for the preset number and the button press for ENTER. See Presets, [page 49](#).

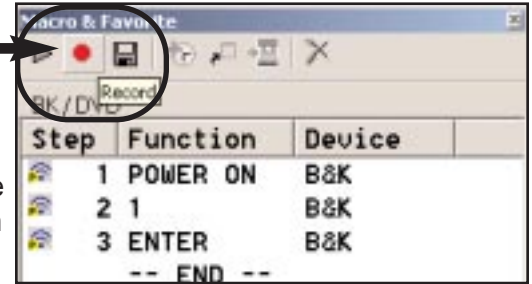

Learning IR Codes

L **Learned** - An L flag indicates that the button is programmed with a learned IR code. A learned code can be pressed or pressed and held for a sustained burst. All buttons can be programmed with learned codes (including all MAIN buttons, hard and LCD) except the buttons on FAV pages and the navigation buttons themselves.

To program a learned command, the PC must be connected to the remote control with the supplied programming cable. Once the cable is connected, click the learn icon located in the Edit and label buttons window. 'Learning Ready' will appear in the lower portion of the window. Then point the source remote at the head end of the SR10.1. Press and hold the original IR command button until you see 'GOOD' appear in the lower portion of the Edit and Label Buttons window. Click SAVE to complete and confirm the learning process.

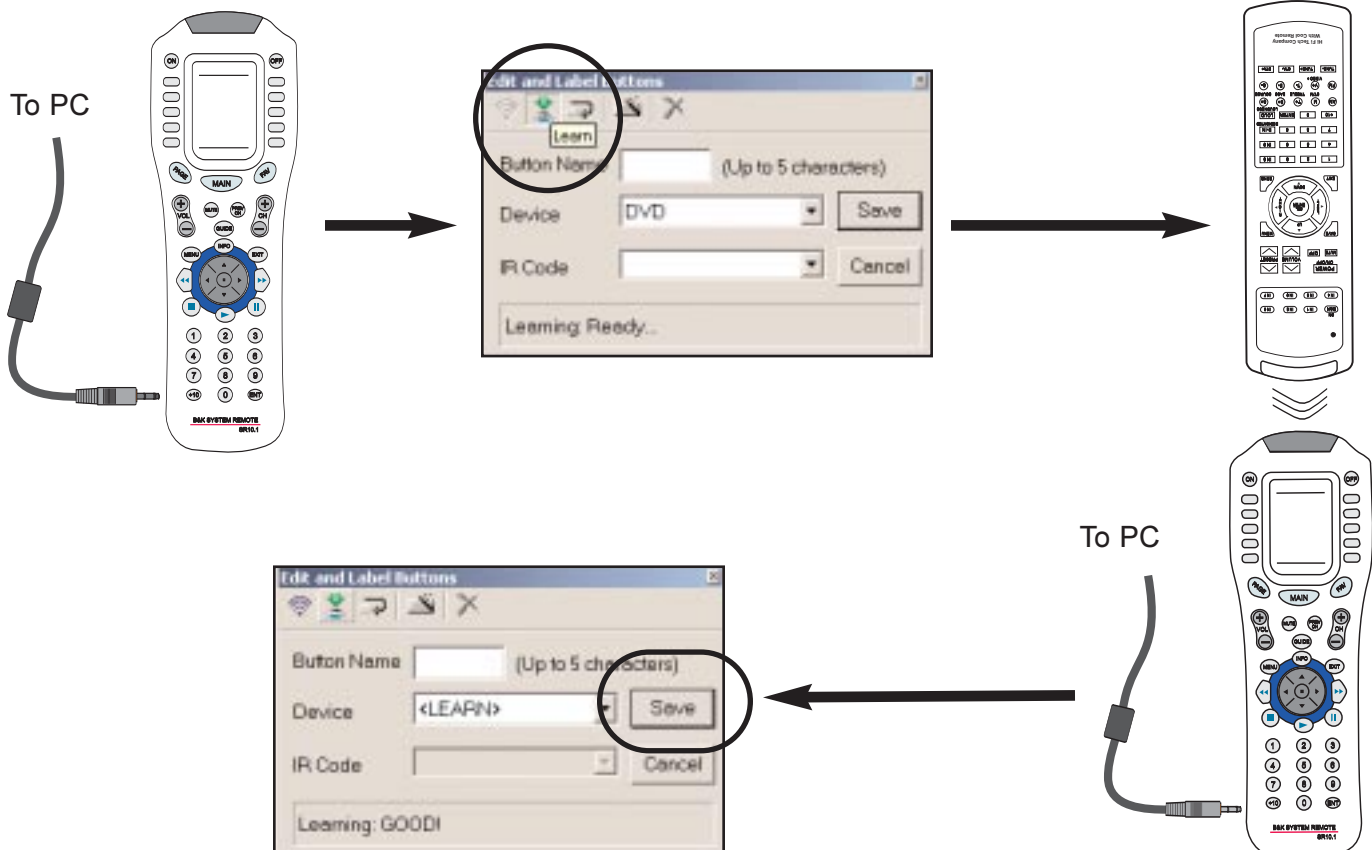

BKcSuite SETUP software

BKcSuite setup software can be downloaded from the B&K website at www.bkcomp.com. Instructions for installation are provided online. Once the software has been installed, download and install the appropriate user manuals separately. BKcSuite automatically installs a shortcut icon on the desktop [BKTask icon (grey)]. Make sure all other applications which use the serial port are closed before opening the taskbar. BKcSuite has the capability to connect in real-time (live) to any of B&K's receivers or preamplifiers. However, it is recommended that all setup be done virtually (not live) to avoid system errors. Once the setup files have been created, establish a connection to the unit and open the saved files. Typical PC setup should follow the described procedure:



1. Open BKcSuite A/V Setup from BKTask. DO NOT CONNECT UNIT TO COMPUTER. Without a connection to the preamplifier is considered virtual mode.

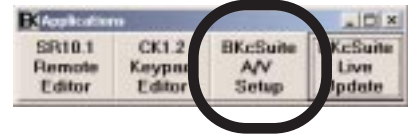

2. When BKcSuite is first opened, the Device Investigator automatically scans to find a connected B&K product. After you have created your setup files, this is how you can establish a connection to the unit. First, choose "select product for operation without a connected device."



3. Choose the product you wish to work with.

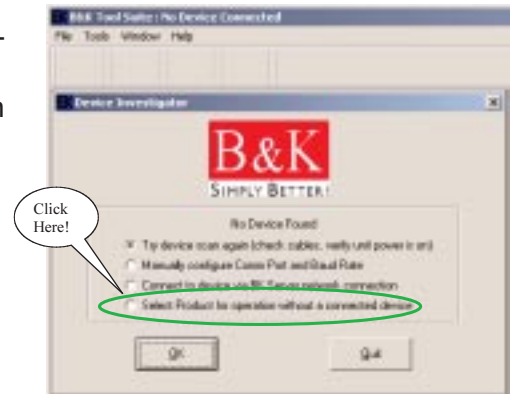

4. The first screen that will appear is a blank grey screen with a toolbar at the top. To access the system setup menu, click the Advanced System Setup icon.



5. The BKcSuite will open directly to the Preset Editor page. You can edit and save preset using this menu. If you desire to setup system parameters, click SYSTEM tab located at the bottom of the page. The system setup outlines the features available in the On Screen Menu.

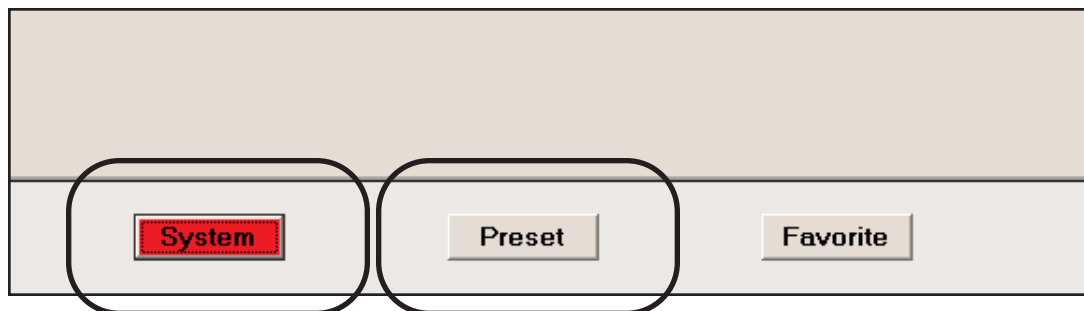

6. Once you have configured the settings for your system, **save the BKcSuite file**. Goto *File->Save settings To File*. Both the system settings and presets for zone A and zone B will be saved together in one file (.bkd extension). Once the settings have been saved to file, you are ready to establish a live connection to the preamplifier.

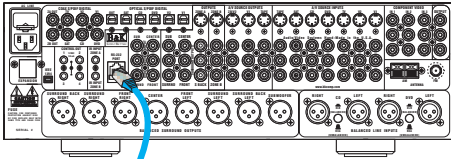

CAT5 Network Cable

7. Connect a straight through CAT5 network cable between the RJ-45 jack and the serial port of the PC (pictured at left). If the PC does not have a DB-9 type serial port, a serial to USB adapter can be used. To

USB to Serial adapter



establish a live connection, close and re-open BKcSuite. BKcSuite will search all com ports for a connected device. While a live connection is established, BKcSuite will operate the same way as when in virtual mode, however any changes made in BKcSuite will immediately update inside the unit itself. To upload a saved file, goto *File->Open* and open the saved system setting file while a live connection is established.

Troubleshooting Guide For BKcSuite

1. PC requirements - 128MB RAM, Pentium grade or better processor, Windows 98SE operating system or greater. (Exception- BKcSuite not supported on Windows NT) ***
2. Make sure the CT/CK/SR product is connected to the PC's *serial* port. **(DB-9, nine pin or USB)**
3. Be sure to select "Local Com" in the BKcSuite software, as "Network" is not currently supported.
4. If the unit will not communicate through RS-232, perform a factory reset. (See Factory Reset Section)
5. Know how to properly set the COM port protocol in your version of Windows:

Window 9x/Me - Go to your system's "Control Panel." Double click the icon labeled "System." Click the Device Manager button. Scroll down until the section labeled "Ports." Click the small "+" located next to "Ports" to expand the tree and view the installed communication ports. Double click the COM port that corresponds to the port on the PC that the CT/CK/SR product will be physically connected to. Locate the tab in the Window labeled "Port Settings," click it and go to section 6 below.

Windows 2000/XP - Go to your system's "Control Panel." Click the icon labeled "System." In the Hardware tab, click the Device Manager button. Double click on the icon labeled "Ports" to expand the tree and view the installed communication ports. Double click the COM port corresponding to the port the CT/CK/SR product is physically connected to and go to section 6 below.

6. Set the proper communication properties. The parameters for Port Settings should be entered as follows:

| | |
|-----------------|--------|
| Bits per second | - 9600 |
| Data Bits | - 8 |
| Parity | - None |
| Stop Bits | - 1 |
| Flow Control | - None |

In the advanced section of the Communication properties window is the "FIFO Buffer" configuration. Most modern laptops have the ability to take full advantage of these buffers, so it is recommended to enable them and drag their slider to the "max" setting. Once you have finished making the selections, click "OK" to all windows and prompt to return to the Control Panel. At that point you can close the Control Panel.

7. Disable any and all power management services including any Uninterrupted Power Supplies (UPS).
8. Disable any handheld computer / PDA syncing software and services.
9. Disable any other RS-232 / Serial protocol programs that may be using a COM port. i.e CK1.2 Keypad Editor, SR10.1 Remote Editor or serial controller.
10. In case you encounter an "Out of Memory" or "Out of Resources" error, be sure your PC meets the minimum requirements outlined in the BKcSuite section of this manual. Close all unnecessary programs that may be running. It is recommended to let Windows manage your virtual memory, however, if you manually set the virtual memory size, set it at least to 1.5 times your actual RAM size.

TROUBLESHOOTING

| PROBLEM | POSSIBLE CAUSE | POSSIBLE SOLUTION |
|--|---|--|
| No sound Display will not illuminate. | <ol style="list-style-type: none"> 1. Power cord not plugged in. 2. Power off at AC source. 3. AC power inlet fuse blown or faulty. 4. Power switch in off position (out). | <ol style="list-style-type: none"> 1. Reconnect power cord. 2. Check AC switch or fuse. 3. Check AC line fuse, replace line fuse with .5A 250V Fast Blow fuse. 4. Push in the main power switch. |
| No sound Unit display will illuminate. | <ol style="list-style-type: none"> 1. Preamplifier is in mute. 2. Volume control to a minimum. 3. Un-used source selected. 4. Line stage or source not correctly connected. 5. Speaker fuse blown. | <ol style="list-style-type: none"> 1. Un-mute the preamplifier . 2. Turn up volume. 3. Select an active source. 4. Check ALL connections. Try substituting cables. 5. Check all speaker fuses and replace if blown. Replace fuse with same type and value. |
| Loud hum or buzz on one or more channels. Channel sounds "bad." | <ol style="list-style-type: none"> 1. Poor ground connection in the interconnect cables. 2. Poor AC ground in main AC supply 3. Audio cables installed across AC power. | <ol style="list-style-type: none"> 1. Check all connections making sure that cables are connected (+) to (+) and (-) to (-). 2. Check all cables and repair where necessary. 3. Reposition cables, bundle like cables together. 4. Try substituting cables. |
| Remote / Keypad / IR sensor(s) will not work. | <ol style="list-style-type: none"> 1. Batteries dead, missing, installed wrong. 2. IR lock is enabled 3. IR inference. 4. Using the wrong IR code-set. 5. Wires are crossed | <ol style="list-style-type: none"> 1. Check and replace batteries. 2. Unlock IR sensor, see Advanced Security menu. 3. Check for nearby sunlight, plasma TV's or fluorescent light. Block where needed. 4. Check zone assigned IR code-set. 5. Check wiring diagram on page 21. |
| Surround speakers are not very loud in SURROUND mode. | <ol style="list-style-type: none"> 1. Normal operation. 2. Speaker channels may not be turned on. | <ol style="list-style-type: none"> 1. When in SURROUND Mode, most audio information is directed to the center channel. Surround and back channels are used for "effects" scenes. 2. Check speaker setup page 25. |
| Unit is locked | <ol style="list-style-type: none"> 1. Poor power supply 2. Processor lockup | <ol style="list-style-type: none"> 1. Check AC power. 2. Cold boot (power switch) or reset the unit. |
| No component video | <ol style="list-style-type: none"> 1. Component video input is not assigned. | <ol style="list-style-type: none"> 1. Assign the component video to the appropriate source input. |
| S-Video and Composite video not visible when using DVD player. | <ol style="list-style-type: none"> 1. DVD player set to progressive scan. | <ol style="list-style-type: none"> 1. Progressive scan (480p) can only be viewed using component video. 2. Reset DVD player to interlaced (480i). |
| Preamplifier is not recognizing multi-channel bitstreams. | <ol style="list-style-type: none"> 1. DVD player needs to be configured for digital output. | <ol style="list-style-type: none"> 1. Go into the DVD players setup menu and turn on the appropriate digital output. |

Reference 50 Series 2

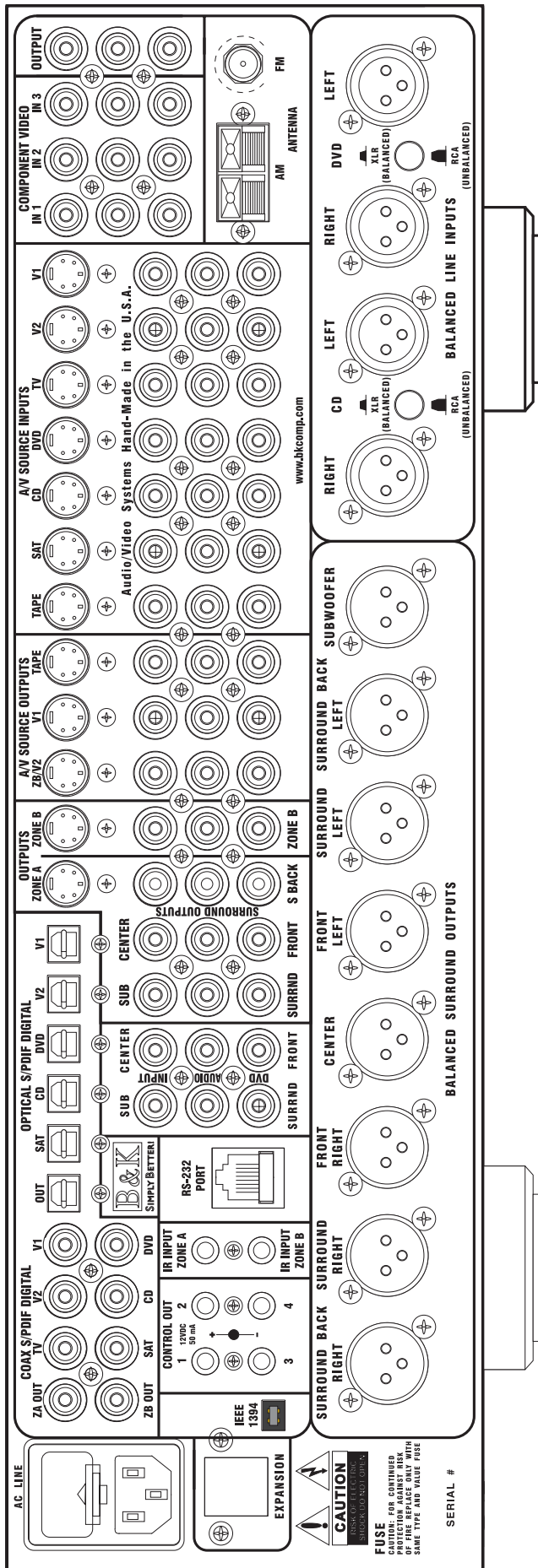

Reference 50 Series 2 Menu System

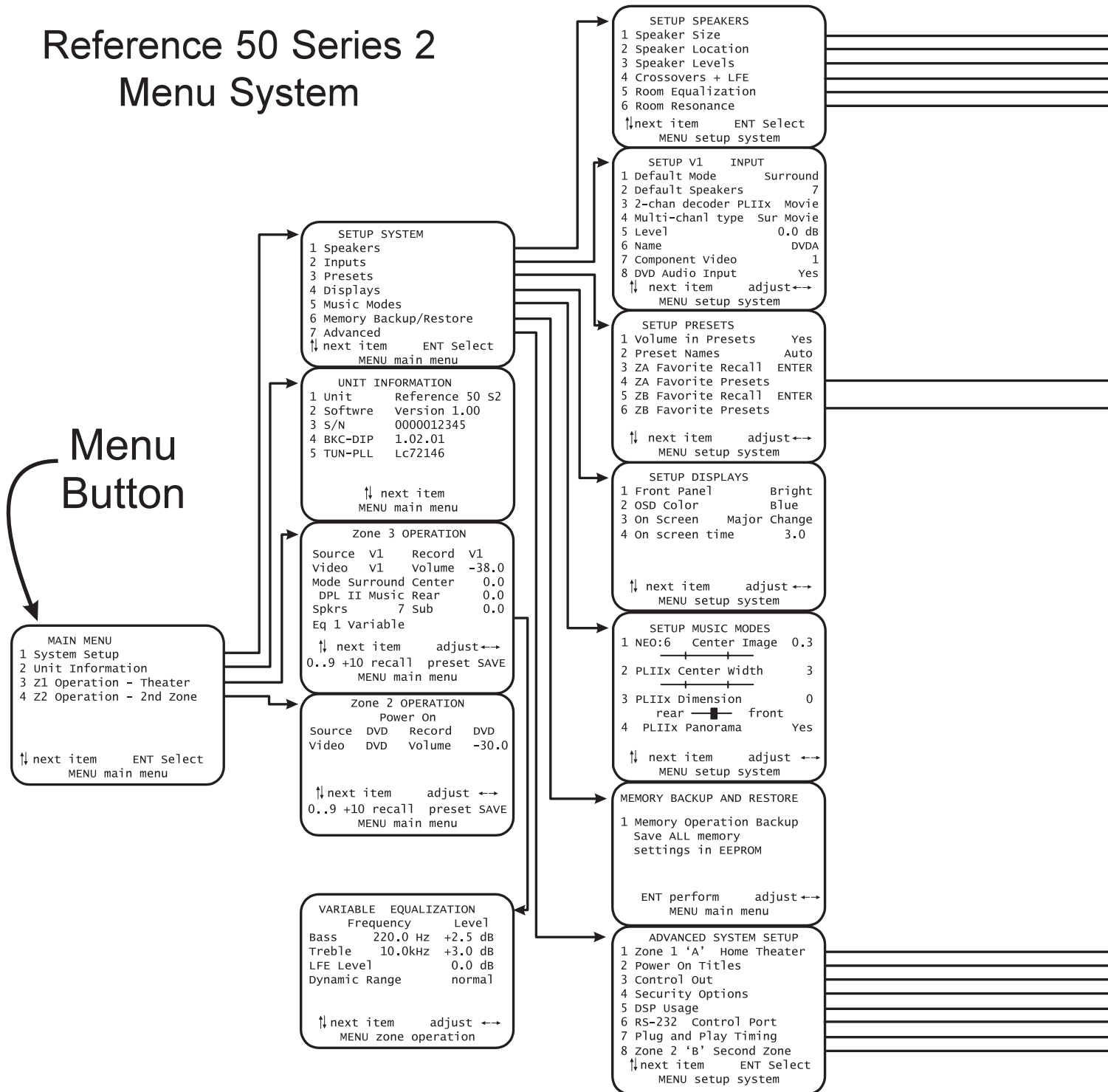

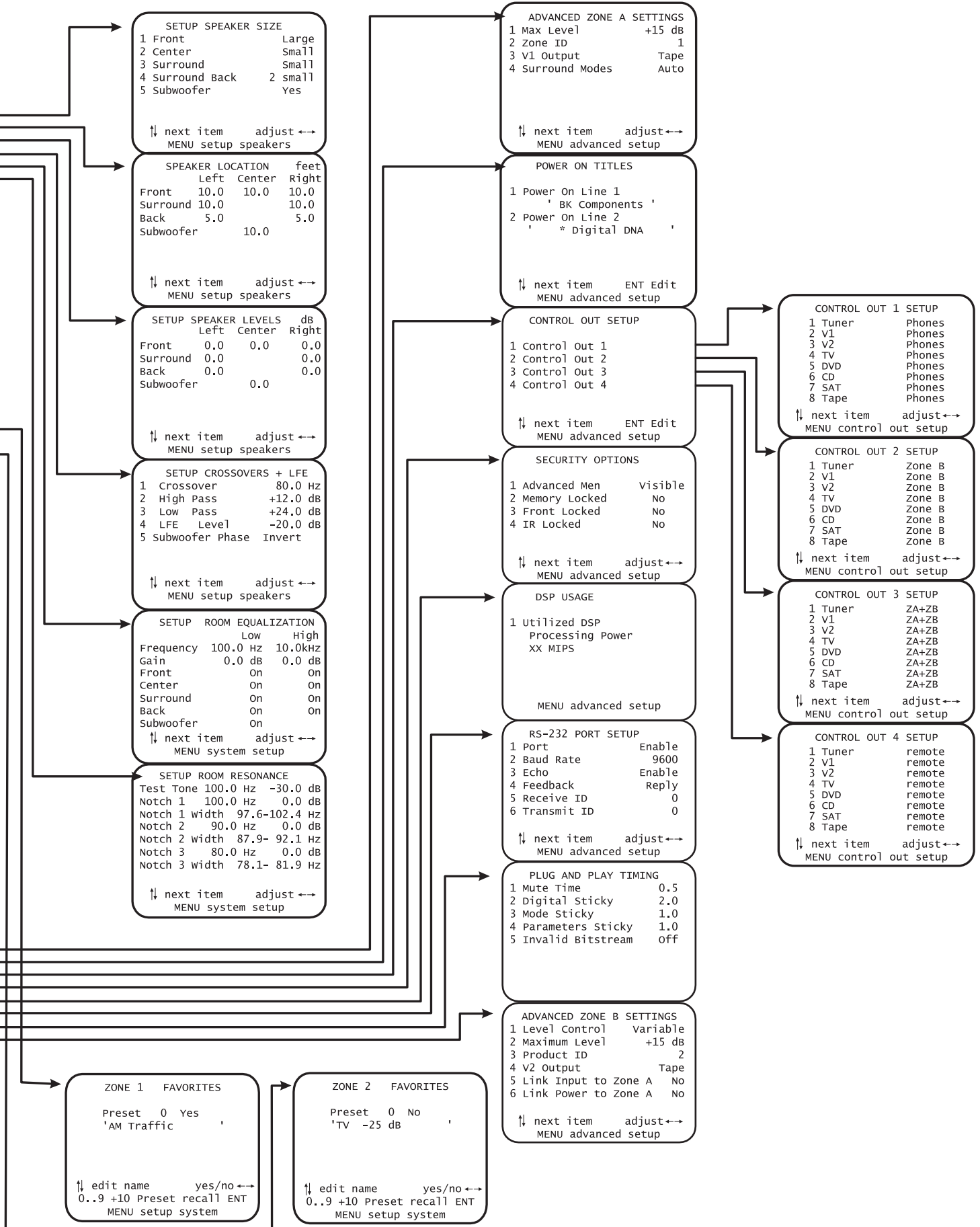

SPECIFICATIONS

Reference 50 Series 2 Preamplifier Processor

| Specification | Reference 50 Series 2 | |
|---|--|--|
| Preamplifier Surround Outputs | 7.1 RCA Type | 7.1 Balanced (XLR) |
| Surround Sound Processing | Dolby Digital / Dolby Pro Logic IIx / Dolby Digital Surround-EX DTS / DTS-ES Discrete / NEO:6 | |
| Frequency Response | 5 - 45kHz | |
| Processor Type | Motorola 371 (180 MIPS) | |
| Input Sensitivity | 90 mV | |
| Signal to Noise Ratio | 89 dB | |
| Input Impedance | 50 K Ω | |
| Output Impedance | 221 Ω | |
| Maximum Output Level | 8V | |
| User Presets | 40 | |
| Audio / Video Source Inputs | 7 | |
| Balanced (XLR) Source Inputs | 2 | |
| Digital Audio Inputs | 5 Optical / 6 Coaxial | |
| CK1.2 Keypad Compatible | Yes | |
| DVD-Audio Inputs | 5.1 (assignable) | |
| Tape Record Loop Outputs | 3 Analog / 3 Digital (2 Coax - 1 Optical) | |
| RS-232 Controllable | Yes | |
| Number of zones | 2 | |
| AC Line Voltage | 120 / 220 / 240 VAC (optional / switchable) | |
| Control Outputs | Four 10 - 12VDC triggers @ 50mA | |
| Dimensions in Inches (Cutout Dimensions) | Width Height Depth | 17.00 (17.12) 5.75 (7.87) 13.5 (14.62) |
| Shipping Weight | 20 lbs | |
| Power Consumption | 30 watts max | |
| Replacement Fuses | AC Line - .5 Amp / 250 Volt Fast Blow | |

| Tuner Specifications | | |
|-----------------------------|------------------|----------------|
| Spec | FM Section | AM Section |
| Frequency Range | 87.5 - 107.9 MHz | 520 - 1670 kHz |
| Total Harmonic Distortion | Less than 0.25% | Less than .3% |
| Frequency Response | 20 Hz - 15 kHz | 300 - 3 kHz |
| IHF (Usable) Sensitivity | 12 dBf | 28 dBf |
| Alternate Chan. Selectivity | 65 dB | 30 dB |
| Signal to Noise Ratio | 70 dB | 50 dB |
| Antenna Input Impedance | 75 Ω | 300 Ω |
| Mono/Stereo Sensitivity | 15 / 35 dBf | N/A |
| Capture Ratio | 2 dB | N/A |

| Video Specifications | |
|-------------------------------------|-----------------|
| Freq. Response Composite / S-Video | 20 Hz - 10 MHz |
| Freq. Response Component Video | 10 Hz - 100 MHz |
| Input & Output Impedance | 75 Ω |
| Composite & S-Vid Inputs / Outputs | 7 / 5 |
| Component Video Inputs / Outputs | 3 / 1 |
| Max. Input / Output Level (RCA & S) | 2 V P-P |

Reference 50_S2_UM_13790.pdf

Free Manuals Download Website

<http://myh66.com>

<http://usermanuals.us>

<http://www.somanuals.com>

<http://www.4manuals.cc>

<http://www.manual-lib.com>

<http://www.404manual.com>

<http://www.luxmanual.com>

<http://aubethermostatmanual.com>

Golf course search by state

<http://golfingnear.com>

Email search by domain

<http://emailbydomain.com>

Auto manuals search

<http://auto.somanuals.com>

TV manuals search

<http://tv.somanuals.com>