

USERS GUIDE EAGLE HM MOTION SENSOR

DESCRIPTION

The High Mounting Eagle Motion Detector (PN: 10EAGLE1HM) nd technology combined with digital processing to assure a sharp, stable activation pattern with outstanding adjustability. Some of the adjustments include unidirectional sensing capabilities, 3-dimensional angle adjustment, and heightened immunity to highly sensitive motion settings. These adjustments can be made with BEA's universal remote control. Other accessories available for the Eagle include the false ceiling adapter (ECA), and the rain protection cover (ERA).

PRELIMINARY

TECHNICAL SPECIFICATIONS

Frequency:	24.125 GHz
Supply voltage:	12 to 24 V AC : $\pm 10\%$: 12 to 24 V DC : -10% / $+30\%$:
Mounting height:	16.5 feet
Tilt angle:	0° to 90° vertical -30° to +30° lateral
Detection area:	13.1 ft x 8.2 ft
Minimum detection speed:	2in/sec. (measured in axis)
Power consumption:	< 2 W
Standard output relay:	
Max contact voltage	60 VDC / 125 VAC
Max contact current	1 A (resistive)
Max switching power	30W (DC) / 60VA (AC)
Hold time:	0.5 sec. to 9 sec. (adjustable)
Temperature range:	-4°F to 131°F
Dimensions:	4.75in (W) x 3.15in (H) x 2.0in (D)
Weight:	0.5lbs
Material:	ABS
Housing color:	Black. Can be painted with non-metallic paint
Cable length:	30ft

DESCRIPTION OF THE SENSOR

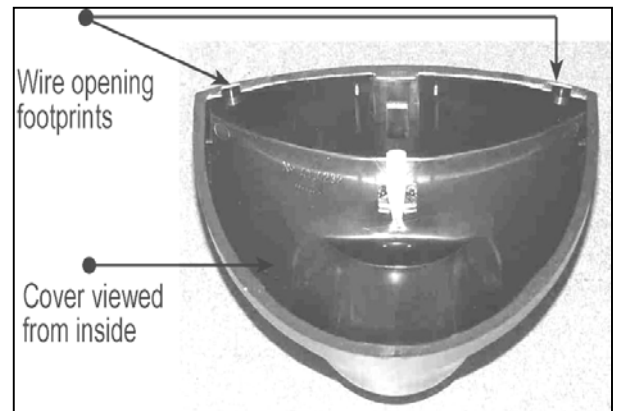
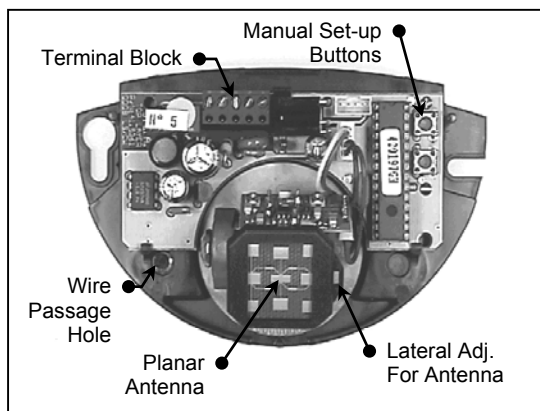

INSTALLATION TIPS

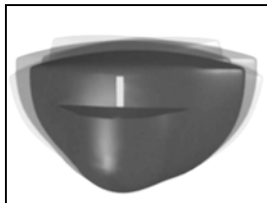

- The sensor must be firmly fastened in order not to vibrate.

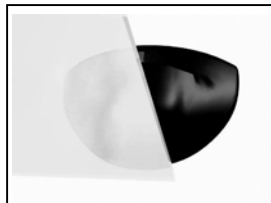

- The sensor must not be placed directly behind a panel or any kind of material.



- The sensor must not have any object likely to move or vibrate in its sensing field.



- The sensor must not have any fluorescent lighting in its sensing field.

SAFETY PRECAUTIONS



- Shut off all power going to the header before attempting any wiring procedures.
- Maintain a clean & safe environment when working in public areas.
- Constantly be aware of pedestrian traffic around the door area.
- Always stop pedestrian traffic through the doorway when performing tests that may result in unexpected reactions by the door.
- Always check placement of all wiring and components before powering up to insure that moving door parts will not catch any wires and cause damage to equipment.
- Ensure compliance with all applicable safety standards upon completion of installation

MECHANICAL INSTALLATION - OPENING THE SENSOR

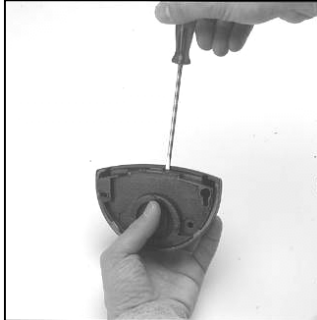

From behind, before installation

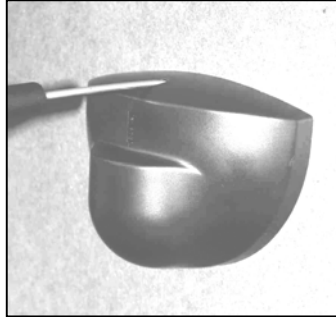

From the front, after installation

MECHANICAL INSTALLATION - PREPARATION FOR MOUNTING THE SENSOR

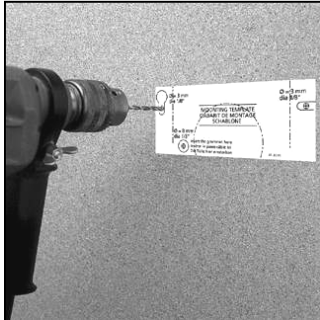

- Paste the template at desired location.
- Drill as instructed.

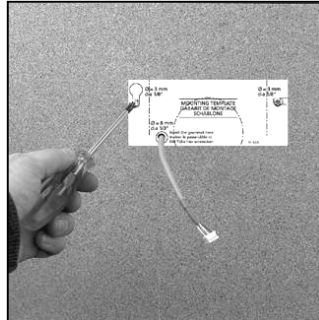

- Insert screws but do not screw them fully in.
- If possible, pass the cable where it is supposed to go through.

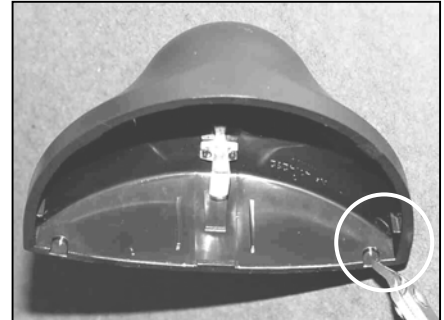

- If you don't want to drill your profile for the cable, you can cut the wire opening footprint as shown in the picture.

ELECTRICAL INSTALLATION - CABLING & CONNECTION

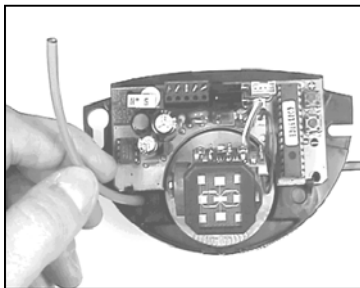

- Run the cable through the wire passage hole just below PCB.

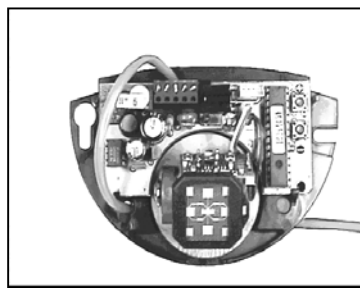

- Position the sensor and tighten the two screws. Make sure you leave enough cable to reach the terminal block.

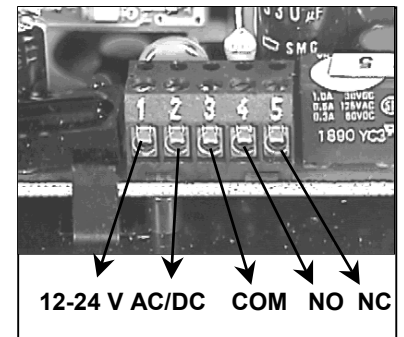

A. WIDTH OF THE SENSING FIELD

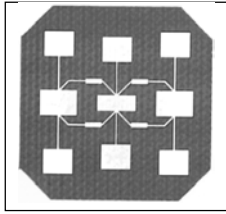

The antenna for the Eagle HM is identified by its 9 elements. There is no narrow or wide antenna. Only the 9 element antenna is utilized for the Eagle HM.

B. THE POSITION OF THE SENSING FIELD IS DETERMINED BY THE VERTICAL TILT ANGLE OF THE ANTENNA

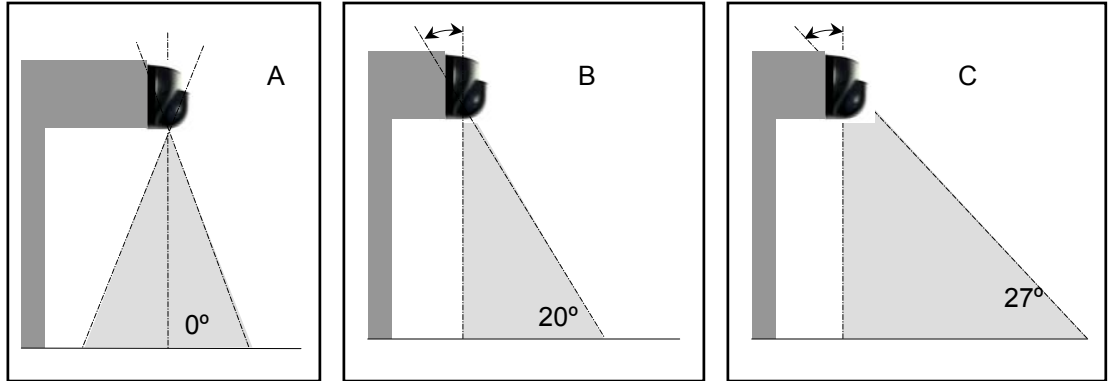

- To obtain a sensing field **as close to the door as possible** : the tilt angle of the antenna must be set at the position (**0°**).
- Example of use with a very deep operator.
- To obtain a sensing field close to the door: the tilt angle of the antenna must be set at the position (**20°**)
- Example of use with a normal operator. Shown in Picture B above.
- To obtain a sensing field far from the door: the tilt angle of the antenna must be set at the maximum position (**27°**).
- Example of use with a normal operator. Shown in picture C above.

SENSING FIELDS ACCORDING TO THE VERTICAL TILT ANGLE OF THE ANTENNA

The sensing fields on the right correspond to the following adjustments :

- vertical angle of the antenna : 0°, 20°, 27° ;
- sensitivity : 9
- Mounting height: 16'

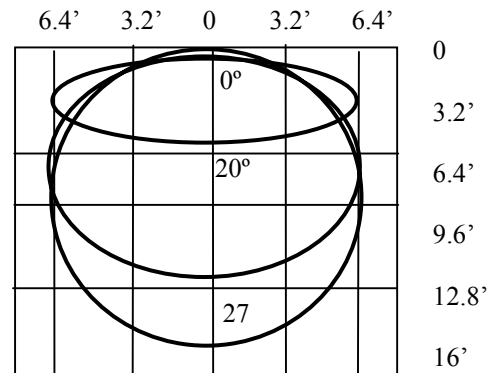

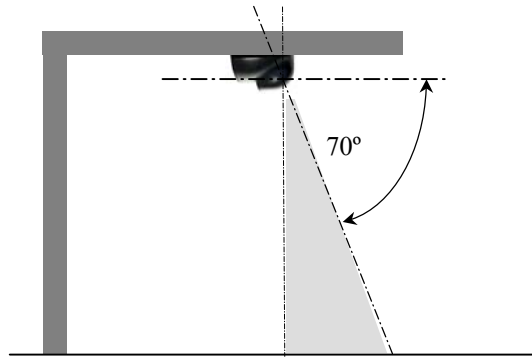

- ❑ For **ceiling** mounting, the vertical tilt angle of the antenna must be set at the maximum position of **70-75°** and the spherical part of the sensor must be oriented in the opposite direction to the door.

C. THE LATERAL POSITION OF THE SENSING FIELD IN FRONT OF THE DOOR IS DETERMINED BY THE LATERAL TILT ANGLE OF THE ANTENNA.

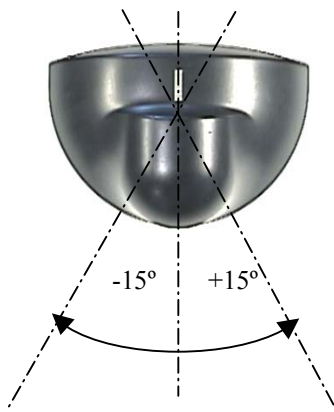

The sensing fields on the right correspond to the following adjustments :

- ❑ lateral angle of the antenna : 15°, -15° ;
- ❑ sensitivity : 6 (middle), 9 (max.)
- ❑ Mounting height : 16'
- ❑ 20° Angle

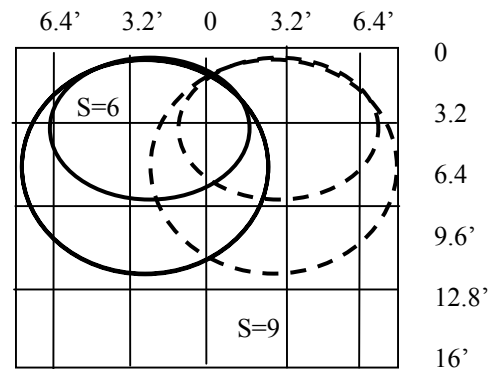

D. THE DIMENSIONS (WIDTH, DEPTH) OF THE SENSING FIELD DEPEND ON THE SENSITIVITY SETTING.

The sensing fields on the right correspond to the following adjustments :

- ❑ vertical angle of the antenna : 20°
- ❑ Mounting height : 16'

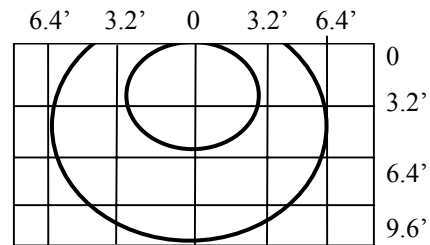

- The Eagle SMR is fully compatible with BEA's Remote Control as shown below. Use of the remote control should be conducted within 10' – 15' of the sensor, and the remote should be pointed directly at the sensor when used. Refer to the "Programming Guide" in the following section for each parameter and it's values.

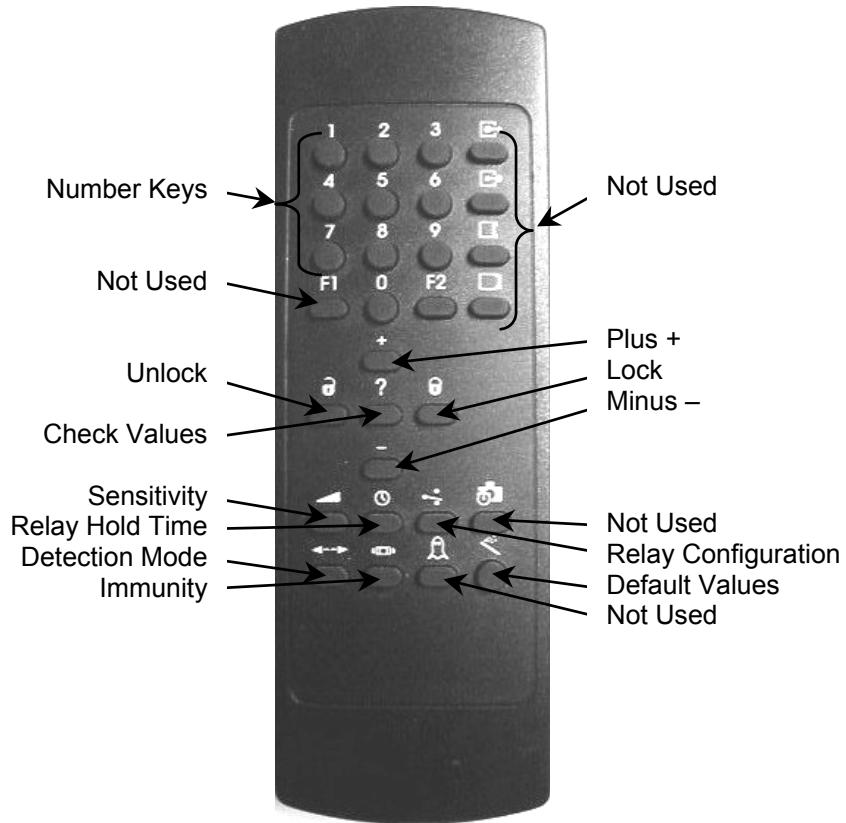

* Every adjustment, when using the infrared remote control, must start with the unlocking function, and end with the locking function.

- The Eagle is SMR ready out of the box. The SMR (Self-Monitored Ready) function enables the sensor to communicate with BEA's Door Control Unit (DCU), which allows for monitoring of the sensor, and interfacing with the door control.
- The Eagle SMR is equipped with a Motion Tracking Feature (MTF). The MTF is available when the Eagle is used in the uni-directional mode. The Eagle is factory preset with the MTF ON. MTF is recommended for use in short vestibule areas to help reduce unwanted door hold-open time. Refer to the Programming Guide to alter this setting. BEA recommends keeping the MTF enabled for all applications. The detection capabilities perform as follows:

BI-DIRECTIONAL MODE:

- Detection of all motion towards or away from the sensor.























UNI-DIRECTIONAL MODE:







- The detector will work in a uni-directional mode at all times regardless of traffic patterns - detecting only motion moving toward the sensor.

OR

UNI-DIRECTIONAL MODE WITH MTF: The principle is as follows:

- The detector does NOT activate its relay as long as it detects movement exclusively moving away from the detector. It acts like the classic unidirectional detector.
- As soon as the Eagle detects movement toward the sensor, it automatically switches to bi-directional mode.
- The Eagle maintains the bi-directional function for approximately 2 seconds following the last detection of motion toward the door.
- At the end of the 2-second time frame, if the Eagle does not detect any further motion, it switches back to the unidirectional mode.

KEY	USER'S ACTIONS	DEFAULT	LED STATUS
<p>UNLOCK</p> 	<p>Press the UNLOCK key once, then enter your 4-digit code to unlock the Eagle.</p>     	0000	<p>The red LED will flash quickly after UNLOCK is pressed once. After entering the valid code, Eagle will flash red LED slowly.</p> <p>If access code is set to the factory default value of 0000, the Eagle will automatically unlock after the UNLOCK key is pressed once. The red LED will immediately begin to slowly flash red.</p>
<p>LOCK</p> 	<p>When all parameters have been set, press the LOCK key once. If you wish to enter a new access code, use the 0-9 number keys and enter the new 4-digit code within 10 seconds. The code must begin with the number 1.</p> <p>If you choose not to enter a new code, press the LOCK key once more, and the existing code will be retained.</p>   = Locked with existing code. <hr/>      = Locked with new code that is entered.	0000	<p>After locking, the red LED stops flashing and the sensor will no longer be in a program mode.</p>
<p>CHECK VALUES</p> 	<p>Press the function key that you desire to inquire about, followed by pressing the CHECK VALUES key.</p> <p>After pressing INQUIRY, count the number of LED flashes – this corresponds to the setting.</p> <p>EXAMPLE:</p>   7 = Default sensitivity value		<p>After pressing a function button, the red LED flashes quickly. After pressing the CHECK VALUES key, the LED flashes the number of the current setting. No LED flash will indicate a setting of 0.</p>
<p>SENSITIVITY</p> 	<p>Sensitivity alters the sensitivity of the motion field. Values range from 0 to 9, minimum to maximum respectively.</p>  0 = Minimum sensitivity 9 = Maximum sensitivity	7	<p>After pressing the SENSITIVITY key, the red LED flashes quickly. After pressing a number button, the red LED flashes slowly.</p>
<p>RELAY HOLD TIME</p> 	<p>Relay hold time refers to the hold time on the output relay of the Eagle. Values range from 0 to 9, .5 seconds to 9 seconds respectively.</p>  0 = .5 secs. 1 = 1 sec. to 9 = 9 seconds. 1 through 9 in 1 second increments.	0	<p>After pressing the RELAY HOLD TIME key, the red LED flashes quickly. After pressing a number button, the red LED flashes slowly.</p>
<p>RELAY CONFIGURATION</p> 	<p>The relay configuration has 4 possible output values:</p>  1 = Normally open relay 2 = Normally closed relay 3 = Continuous detection 4 = Continuous non-detection	1	<p>After pressing the RELAY CONFIGURATION key, the red LED flashes quickly. After pressing a number button, the red LED flashes slowly. (Normally Open relay indicates relay closes upon detection, and is open upon a power loss).</p>

KEY	USER'S ACTIONS	DEFAULT	LED STATUS
<p>DETECTION MODE</p> 	<p>Detection mode offers 3 different levels of detection: Bi-directional, Uni-directional and Uni-directional with MTF (motion tracking feature). MTF allows the Eagle to switch from uni-directional to bi-directional upon detection from the normal approach direction.</p>  <p>1 = Bi-directional 2 = Uni-directional 3 = Uni-directional with MTF</p>	3	After pressing the DETECTION MODE key, the red LED flashes quickly. After pressing a number button, the red LED flashes slowly.
<p>IMMUNITY</p> 	<p>Immunity alters the detection of unwanted disturbances within the field of motion detection.</p>  <p>1 = Extreme sensitivity 2 = Normal Sensitivity 3 = Reduced sensitivity</p>	2	After pressing the IMMUNITY key, the red LED flashes quickly. After pressing a number button, the red LED flashes slowly.
<p>DEFAULT VALUE</p> 	 <p>1 = Restores default values for all functions 2 = Boost Mode; Restores default values for all functions, and increases sensitivity for high-mount applications.</p>		After pressing the DEFAULT VALUE key, the red LED flashes quickly. After pressing a number button, the red LED flashes slowly.

MANUAL SET-UP

If a remote control is not available, you can adjust the sensitivity parameter ONLY, by means of the push buttons **+** (Plus) and **-** (Minus).

The sensor parameters that are not accessible manually will remain at the factory preset values. Pressing the two push buttons, located on the circuit board, simultaneously for at least two seconds, will restore all default values.

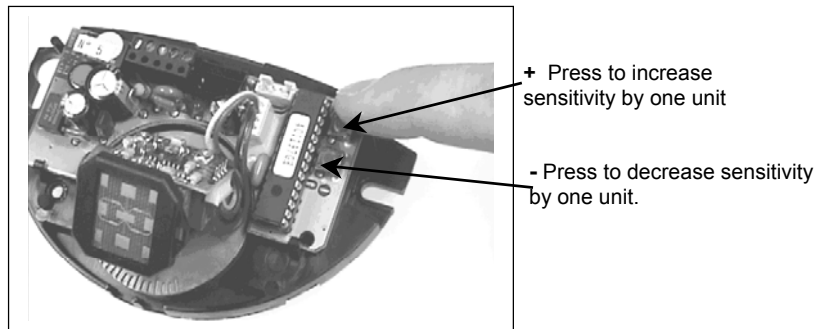

TROUBLE-SHOOTING

The door will not open & LED does not light up	<ol style="list-style-type: none"> 1. Check supply voltage: 12 to 24 VAC: $\pm 10\%$ 12 to 24 VDC: $-10\% / +30\%$ 2. Check power connector
The sensor does not respond to the remote control	<ol style="list-style-type: none"> 1. Check remote control battery insertion 2. Check remote control battery voltage
The sensor does not respond to the code entered with the remote control	<ol style="list-style-type: none"> 1. Remove the cover and press the 2 buttons simultaneously for at least two seconds. This will reset the lock code to 0000. Then press the unlock button to enable you to access the settings with the remote control.
The door open and closes constantly	<ol style="list-style-type: none"> 1. Increase the tilt angle of the antenna 2. Reduce sensitivity

OTHER
ACCESSORIES



PN: 10ECA
For mounting into the ceiling, use
the ECA embedding accessory.

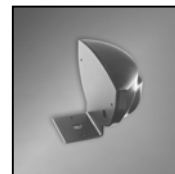

PN: 10EMB
Bracket for mounting on the
top of the door header.

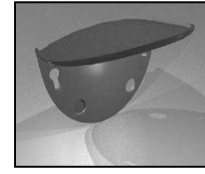

PN: 10ERA
Rain protection accessory.

COMPANY
CONTACT

If after troubleshooting a problem, a satisfactory solution cannot be achieved, please call B.E.A., Inc. for further assistance during **Eastern Standard Time at 1-800-523-2462 from 8am - 5pm.** For after-hours, call East Coast: 1-866-836-1863 or 1-800-407-4545 / Mid-West: 1-888-308-8843 / West Coast: 1-888-419-2564. **DO NOT leave any problem unresolved.** If you must wait for the following workday to call B.E.A., leave the door inoperable until satisfactory repairs can be made. **NEVER sacrifice the safe operation of the automatic door or gate for an incomplete solution.**
Web: www.beasensors.com

Free Manuals Download Website

<http://myh66.com>

<http://usermanuals.us>

<http://www.somanuals.com>

<http://www.4manuals.cc>

<http://www.manual-lib.com>

<http://www.404manual.com>

<http://www.luxmanual.com>

<http://aubethermostatmanual.com>

Golf course search by state

<http://golfingnear.com>

Email search by domain

<http://emailbydomain.com>

Auto manuals search

<http://auto.somanuals.com>

TV manuals search

<http://tv.somanuals.com>