

BenQ

MS510/MX511

Digital Projector

User Manual

Welcome

Table of contents

Important safety

instructions3

Introduction.....7

Projector features 7

Shipping contents 8

Projector exterior view 9

Controls and functions 10

Positioning your projector 14

Choosing a location..... 14

Obtaining a preferred projected image size 15

Connection 18

Connecting a computer or monitor... 19

Connecting Video source devices..... 20

Operation24

Starting up the projector 24

Adjusting the projected image 25

Using the menus 27

Securing the projector 28

Switching input signal..... 31

Magnifying and searching for details . 32

Selecting the aspect ratio 32

Optimizing the image..... 34

Creating your own startup screen 37

Setting the presentation timer 38

Remote paging operations 39

Hiding the image 39

Freezing the image..... 40

Utilizing FAQ function 40

Operating in a high altitude environment 41

Adjusting the sound.....41

Adjusting the sound level41

Personalizing the projector menu

display42

Shutting down the projector42

Menu operation43

Maintenance.....55

Care of the projector55

Lamp information.....56

Troubleshooting62

Specifications63

Dimensions.....64

Ceiling mount installation.....64

Timing chart.....65

Warranty and Copyright

information68

Regulation statements69

Important safety instructions

Your projector is designed and tested to meet the latest standards for safety of information technology equipment. However, to ensure safe use of this product, it is important that you follow the instructions mentioned in this manual and marked on the product.

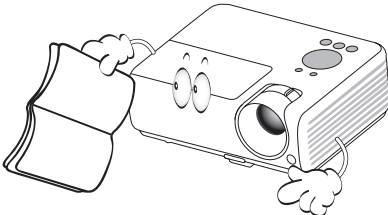
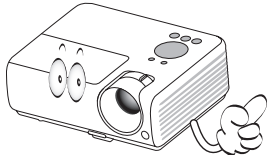
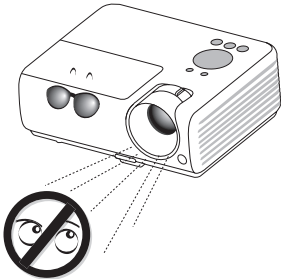
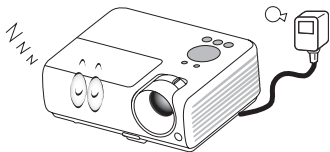
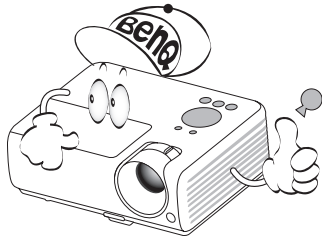
Safety Instructions	
<p>1. Please read this manual before you operate your projector. Save it for future reference.</p> 	<p>4. Always open the lens shutter or remove the lens cap when the projector lamp is on.</p> 
<p>2. Do not look straight at the projector lens during operation. The intense light beam may damage your eyes.</p> 	<p>5. In some countries, the line voltage is NOT stable. This projector is designed to operate safely within a mains voltage between 100 to 240 volts AC, but could fail if power cuts or surges of ± 10 volts occur. In areas where the mains voltage may fluctuate or cut out, it is recommended that you connect your projector through a power stabilizer, surge protector or uninterruptible power supply (UPS).</p> 
<p>3. Refer servicing to qualified service personnel.</p> 	<p>6. Do not block the projection lens with any objects when the projector is under operation as this could cause the objects to become heated and deformed or even cause a fire. To temporarily turn off the lamp, press BLANK on the projector or remote control.</p>

Safety Instructions (Continued)

7. The lamp becomes extremely hot during operation. Allow the projector to cool for approximately 45 minutes prior to removing the lamp assembly for replacement.

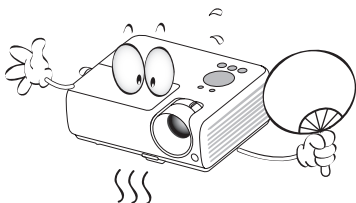

8. Do not operate lamps beyond the rated lamp life. Excessive operation of lamps beyond the rated life could cause them to break on rare occasions.

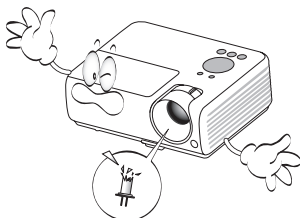

9. Never replace the lamp assembly or any electronic components unless the projector is unplugged.

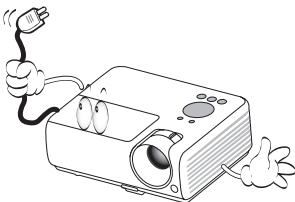

10. Do not place this product on an unstable cart, stand, or table. The product may fall, sustaining serious damage.

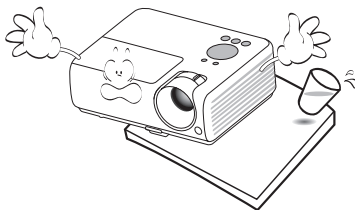

11. Do not attempt to disassemble this projector. There are dangerous high voltages inside which may cause death if you should come into contact with live parts. The only user serviceable part is the lamp which has its own removable cover. Under no circumstances should you ever undo or remove any other covers. Refer servicing only to suitably qualified professional service personnel.

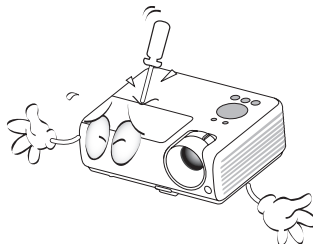

12. When the projector is under operation, you may sense some heated air and odor from its ventilation grill. It is a normal phenomenon and not a product defect.

Safety Instructions (Continued)

13. Do not place this projector in any of the following environments.
- Space that is poorly ventilated or confined. Allow at least 50 cm clearance from walls and free flow of air around the projector.
 - Locations where temperatures may become excessively high, such as the inside of a car with all windows rolled up.
 - Locations where excessive humidity, dust, or cigarette smoke may contaminate optical components, shortening the projector's life span and darkening the image.

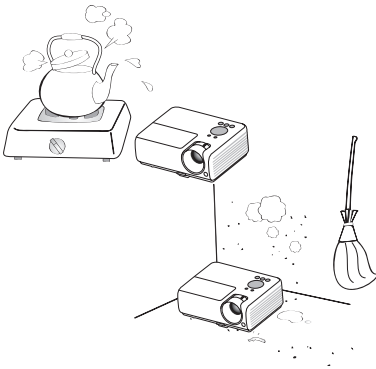

- Locations near fire alarms
- Locations with an ambient temperature above 40°C / 104°F
- Locations where the altitudes are higher than 3000 m (10000 feet).

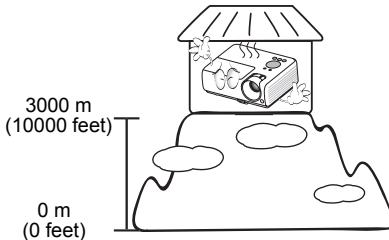

14. Do not block the ventilation holes.
- Do not place this projector on a blanket, bedding or any other soft surface.
 - Do not cover this projector with a cloth or any other item.
 - Do not place inflammables near the projector.

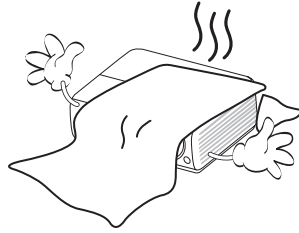

If the ventilation holes are seriously obstructed, overheating inside the projector may result in a fire.

15. Always place the projector on a level, horizontal surface during operation.
- Do not use if tilted at an angle of more than 10 degrees left to right, nor at angle of more than 15 degrees front to back. Using the projector when it is not fully horizontal may cause a malfunction of, or damage to, the lamp.

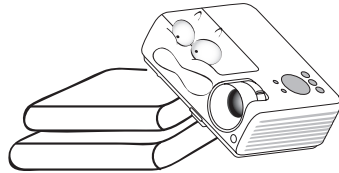

Safety Instructions (Continued)

16. Do not stand the projector on end vertically. Doing so may cause the projector to fall over, causing injury or resulting in damage to the projector.

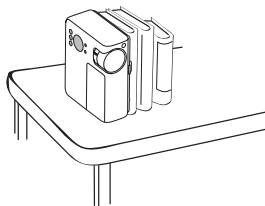

17. Do not step on the projector or place any objects upon it. Besides probable physical damage to the projector, doing so may result in accidents and possible injury.

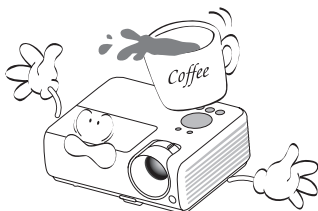

18. Do not place liquids near or on the projector. Liquids spilled into the projector may cause it to fail. If the projector does become wet, disconnect it from the power supply's wall socket and call BenQ to have the projector serviced.

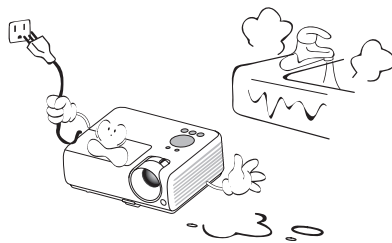

19. This product is capable of displaying inverted images for ceiling mount installation.

 **Use only BenQ's Ceiling Mount Kit for mounting the projector and ensure it is securely installed.**

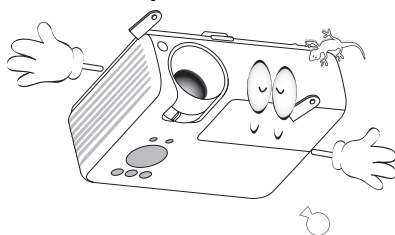

Introduction

Projector features

The projector integrates high-performance optical engine projection and a user-friendly design to deliver high reliability and ease of use.

The projector offers the following features.

- Wall color correction allowing projection on surfaces of several predefined colors
- Quick auto search speeding up the signal detecting process
- Selectable password protected function
- 3D color management allowing color adjustments to your liking
- Selectable quick cooling function makes the projector cool in a shorter time
- Presentation timer for better control of time during presentations
- One-key auto-adjustment to display the best picture quality
- Digital keystone correction to correct distorted images
- Adjustable color balance control for data/video display
- High brightness projection lamp
- Multi-language On-Screen Display (OSD) menus
- Switchable normal and economic modes to reduce the power consumption
- Component HDTV compatibility (YPbPr)
- Less than 1 W power consumption in standby mode
- Built-in speaker providing mixed mono audio when an audio input is connected
- HDMI compatibility



- **The apparent brightness of the projected image will vary depending on the ambient lighting conditions, selected input signal contrast/brightness settings, and is directly proportional to projection distance.**
- **The lamp brightness will decline over time and may vary within the lamp manufacturers specifications. This is normal and expected behavior.**

Shipping contents

Carefully unpack and verify that you have all of the items shown below. If any of these items are missing, please contact your place of purchase.

Standard accessories

 The supplied accessories will be suitable for your region, and may differ from those illustrated.

*The warranty card is only supplied in some specific regions. Please consult your dealer for detailed information.

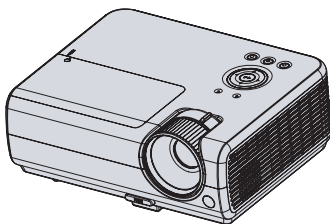

Projector

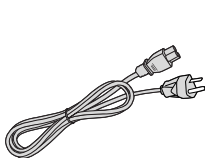

Power cord

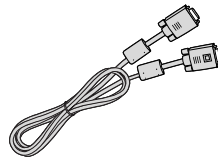

VGA cable



Quick start guide



User manual CD



Warranty card*



Pull the tab before using the remote control.



Remote control with battery



Optional accessories

1. Spare lamp kit
2. Ceiling mount kit
3. Soft carry case
4. RS232 cable

Projector exterior view

Front/upper side

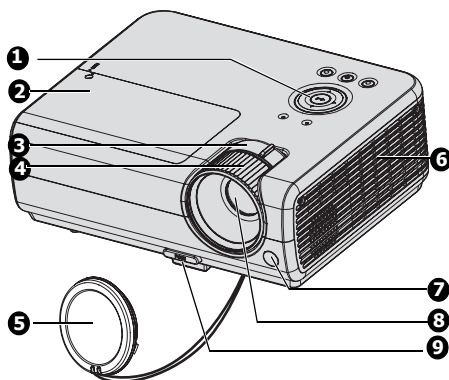

Rear/lower side

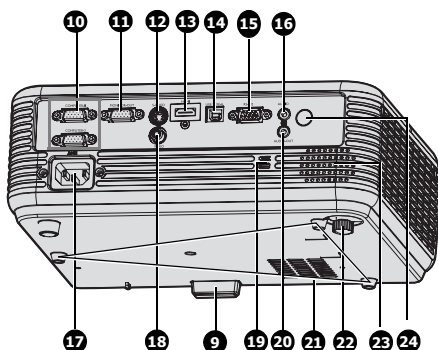

1. External control panel
(See "Projector" on page 10 for details.)
2. Lamp cover
3. Zoom ring
4. Focus ring
5. Lens cover
6. Vent (heated air exhaust)
7. Front IR remote sensor
8. Projection lens
9. Quick-release button
10. RGB (PC)/Component video (YPbPr/ YCbCr) signal input jack
11. RGB signal output jack
12. S-Video input jack
13. HDMI input jack
14. USB input jack
15. RS-232 control port
16. Audio input jack
17. AC power cord inlet
18. Video input jack
19. Kensington anti-theft lock slot
20. Audio output jack
21. Ceiling mount holes
22. Rear adjuster foot
23. Speaker
24. Rear IR remote sensor

Controls and functions

Projector

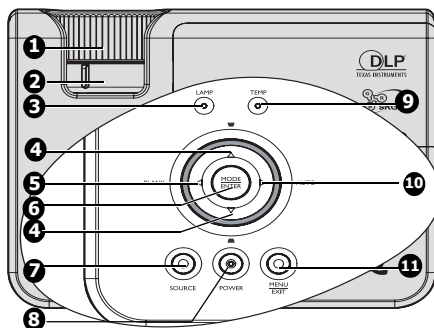

1. Focus ring

Adjusts the focus of the projected image. See ["Fine-tuning the image size and clarity" on page 26](#) for details.

2. Zoom ring

Adjusts the size of the image. See ["Fine-tuning the image size and clarity" on page 26](#) for details.

3. LAMP indicator light

Indicates the status of the lamp. Lights up or flashes when the lamp has developed a problem. See ["Indicators" on page 61](#) for details.

4. Keystone/Arrow keys (▾ / ▲ Up, ▸ / ▼ Down)

Manually corrects distorted images resulting from an angled projection. See ["Correcting keystone" on page 26](#) for details.

5. ◀ Left/Blank

Used to hide the screen picture. See ["Hiding the image" on page 39](#) for details.

6. Mode/Enter

Selects an available picture setup mode. See ["Selecting a picture mode" on page 34](#) for details.

Activates the selected On-Screen Display (OSD) menu item. See ["Using the menus" on page 27](#) for details.

7. Source

Displays the source selection bar. See ["Switching input signal" on page 31](#) for details.

8. ⏻ Power/POWER indicator light

Toggles the projector between standby mode and on. See ["Starting up the projector" on page 24](#) and ["Shutting down the projector" on page 42](#) for details.

Lights up or flashes when the projector is under operation. See ["Indicators" on page 61](#) for detail.

9. TEMPerature indicator light

Lights up red if the projector's temperature becomes too high. See ["Indicators" on page 61](#) for details.

10. ▶ Right/Auto

When the On-Screen Display (OSD) menu is activated, the #4, #5, and #10 keys are used as directional arrows to select the desired menu items and to make adjustments. See ["Using the menus" on page 27](#) for details.

Automatically determines the best picture timings for the displayed image. See ["Auto-adjusting the image" on page 25](#) for details.

11. Menu/Exit

Turns on the On-Screen Display (OSD) menu. Goes back to previous OSD menu, exits and saves menu settings.

Ceiling mounting the projector

We want you to have a pleasant experience using your BenQ projector, so we need to bring this safety matter to your attention to prevent possible damage to person and property.

If you intend to mount your projector on the ceiling, we strongly recommend that you use a proper fitting BenQ projector ceiling mount kit and that you ensure it is securely and safely installed.

If you use a non-BenQ brand projector ceiling mount kit, there is a safety risk that the projector may fall from the ceiling due to an improper attachment through the use of the wrong gauge or length screws.

You can purchase a BenQ projector ceiling mount kit from the place you purchased your BenQ projector. BenQ recommends that you also purchase a separate Kensington lock compatible security cable and attach it securely to both the Kensington lock slot on the projector and the base of the ceiling mount bracket. This will perform the secondary role of restraining the projector should its attachment to the mounting bracket become loose.

Remote control

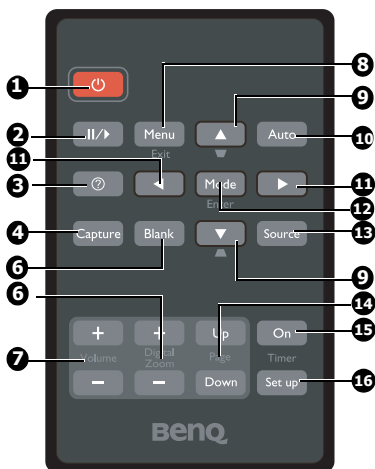

1. **Power**
Toggles the projector between standby mode and on. See "[Starting up the projector](#)" on page 24 and "[Shutting down the projector](#)" on page 42 for details.
2. **II/|> Freeze**
Freezes the projected image. See "[Freezing the image](#)" on page 40 for details.
3. **(?)**
Starts the FAQ function. See "[Utilizing FAQ function](#)" on page 40 for details.
4. **Capture**
Captures current displayed screen to be MyScreen. See "[Creating your own startup screen](#)" on page 37 for details.
5. **Blank**
Used to hide the screen picture. See "[Hiding the image](#)" on page 39 for details.
6. **Digital Zoom keys (+, -)**
Magnifies or reduces the projected picture size. See "[Magnifying and searching for details](#)" on page 32 for details.
7. **Volume +/-**
Adjusts the sound level. See "[Adjusting the sound](#)" on page 41 for details.
8. **Menu/Exit**
Turns on the On-Screen Display (OSD) menu. Goes back to previous OSD menu, exits and saves menu settings. See "[Using the menus](#)" on page 27 for details.
9. **Keystone/Arrow keys (▾ / ▲ Up, ▸ / ▼ Down)**
Manually corrects distorted images resulting from an angled projection. See "[Correcting keystone](#)" on page 26 for details.
10. **Auto**
Automatically determines the best picture timings for the displayed image. See "[Auto-adjusting the image](#)" on page 25 for details.
11. **◀ Left/▶ Right**
When the On-Screen Display (OSD) menu is activated, the #9 and #11 keys are used as directional arrows to select the desired menu items and to make adjustments. See "[Using the menus](#)" on page 27 for details.
12. **Mode/Enter**
Selects an available picture setup mode. See "[Selecting a picture mode](#)" on page 34 for details. Activates the selected On-Screen Display (OSD) menu item. See "[Using the menus](#)" on page 27 for details.
13. **Source**
Displays the source selection bar. See "[Switching input signal](#)" on page 31 for details.
14. **Page Up/Down**
Page up/down arrows when connected through USB to a PC. See "[Remote paging operations](#)" on page 39 for details.
15. **On/Timer**
Turns the projector on or sets a timer.
16. **Set up**
Accesses the factory default settings.

15. Timer On

Activates or displays an on-screen timer based on your own timer setting. See ["Setting the presentation timer" on page 38](#) for details.

16. Timer Setup

Enters presentation timer setting directly. See ["Setting the presentation timer" on page 38](#) for details.

Infra-Red (IR) remote control sensor is located on the front of the projector. The remote control must be held at an angle within 30 degrees perpendicular to the projector's IR remote control sensor to function correctly. The distance between the remote control and the sensor should not exceed 8 meters (~ 26 feet).

Make sure that there are no obstacles between the remote control and the IR sensor on the projector that might obstruct the infra-red beam.

- **Operating the projector from the front**
- **Operating the projector from the rear**

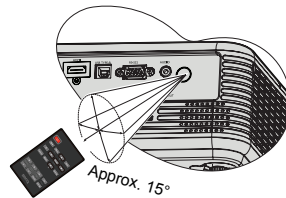
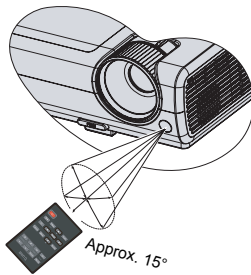

Replacing the remote control battery

1. Pull out the battery holder.

 **Please follow the illustrated instructions. Push and hold the locking arm while pulling out the battery holder.**

2. Insert the new battery in the holder. Note the positive polarity should face outward.
3. Push the holder into the remote control.



Avoid excessive heat and humidity.

- **There may be battery damage if the battery is incorrectly replaced.**
- **Replace only with the same or equivalent type recommended by the battery manufacturer.**
- **Dispose of the used battery according to the battery manufacturer's instructions.**
- **Never throw a battery into a fire. There may be danger of an explosion.**
- **If the battery is dead or if you will not be using the remote control for a long time, remove the battery to prevent damage to the remote control from possible battery leakage.**

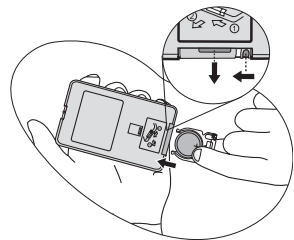

Positioning your projector

Choosing a location

Your room layout or personal preference will dictate which installation location you select. Take into consideration the size and position of your screen, the location of a suitable power outlet, as well as the location and distance between the projector and the rest of your equipment.

Your projector is designed to be installed in one of four possible installation locations:

1. Front Table

Select this location with the projector placed near the floor in front of the screen. This is the most common way to position the projector for quick setup and portability.

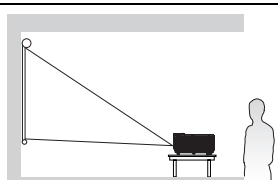

2. Front Ceiling

Select this location with the projector suspended upside-down from the ceiling in front of the screen.

Purchase the BenQ Projector Ceiling Mounting Kit from your dealer to mount your projector on the ceiling.

Set **Front Ceiling** in the **SYSTEM SETUP: Basic > Projector Position** menu after you turn the projector on.

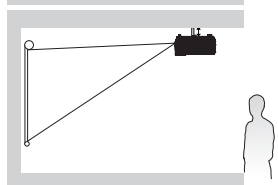

3. Rear Table

Select this location with the projector placed near the floor behind the screen.

Note that a special rear projection screen is required.

Set **Rear Table** in the **SYSTEM SETUP: Basic > Projector Position** menu after you turn the projector on.

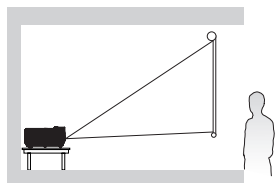



4. Rear Ceiling

Select this location with the projector suspended upside-down from the ceiling behind the screen.

Note that a special rear projection screen and the BenQ Projector Ceiling Mounting Kit are required for this installation location.

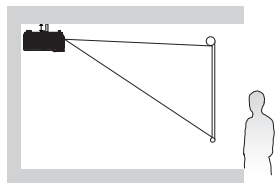
Set **Rear Ceiling** in the **SYSTEM SETUP: Basic > Projector Position** menu after you turn the projector on.



 Your room layout or personal preference will dictate which installation location you select. Take into consideration the size and position of your screen, the location of a suitable power outlet, as well as the location and distance between the projector and the rest of your equipment.

Obtaining a preferred projected image size

The distance from the projector lens to the screen, the zoom setting (if available), and the video format each factors in the projected image size.

4:3 is the native aspect ratio of this projector. To be able to project a complete 16:9 (widescreen) aspect ratio image, the projector can resize and scale a widescreen image to the projector's native aspect width. This will result in a proportionally smaller height equivalent to 75% of the projector's native aspect height.

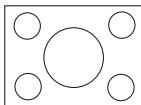

4:3 aspect image in a 4:3 aspect display area

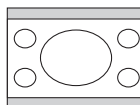

16:9 aspect image scaled to a 4:3 aspect display area

The projector should always be placed horizontally level (like flat on a table), and positioned directly perpendicular (90° right-angle square) to the horizontal center of the screen. This prevents image distortion caused by angled projections (or projecting onto angled surfaces).

If the projector is mounted on a ceiling, it must be mounted upside-down so that it projects at a slightly downward angle.

You can see from the diagram on page 17, that this type of projection causes the bottom edge of the projected image to be vertically offset from the horizontal plane of the projector. When ceiling mounted, this refers to the top edge of the projected image.

If the projector is positioned further away from the screen, the projected image size increases, and the vertical offset also increases proportionately.

When determining the position of the screen and projector, you will need to account for both the projected image size and the vertical offset dimension, which are directly proportional to the projection distance.

BenQ has provided a table of 4:3-aspect-ratio screen sizes to assist you in determining the ideal location for your projector. There are two dimensions to consider, the perpendicular horizontal distance from the center of the screen (projection distance), and the vertical offset height of the projector from the horizontal edge of the screen (offset).

How to determine the position of the projector for a given screen size

1. Select your screen size.
2. Refer to the table on page 17 and find the closest match to your screen size in the left columns labelled "Screen size". Using this value, look across this row to the right to find the corresponding average distance from screen value in the column labelled "Average". This is the projection distance.
3. On that same row, look across to the right column and make note of the "Vertical offset (mm)" value. This will determine the final vertical offset placement of the projector in relation to the edge of the screen.
4. The recommended position for the projector is aligned perpendicular to the horizontal center of the screen, at the distance from the screen determined in step 2 above, and offset by the value determined in step 3 above.

For example, if you are using a 120-inch screen, the average projection distance is 5040 mm and with a vertical offset of 274 mm.

How to determine the recommended screen size for a given distance

This method can be used for situations where you have purchased this projector and would like to know what screen size will fit in your room.

The maximum screen size is limited by the physical space available in your room.

1. Measure the distance between the projector and where you want to position the screen. This is the projection distance.
2. Refer to the table on page 17 and find the closest match to your measurement in the average distance from screen column labelled "Average". Check that your measured distance is between the min and max distances listed on either side of the average distance value.
3. Using this value, look across that row to the left to find the corresponding "Screen size" listed in that row. That is the projected image size of the projector at that projection distance.
4. On that same row, look across to the right column and make note of the "Vertical offset (mm)" value. This will determine the final placement of the screen in relation to the horizontal plane of the projector.

For example, if your measured projection distance was 5.0 m (5000 mm), the closest match in the "Average" column is 5040 mm. Looking across this row shows that a 120-inch screen is required.

If you place the projector in a different position (to that recommended), you will have to tilt it down or up to center the image on the screen. In these situations, some image distortion will occur. Use the Keystone function to correct the distortion. See "Correcting keystone" on page 26 on page for details.

Projection dimensions

Refer to "Dimensions" on page 64 for the center of lens dimensions of this projector before calculating the appropriate position.

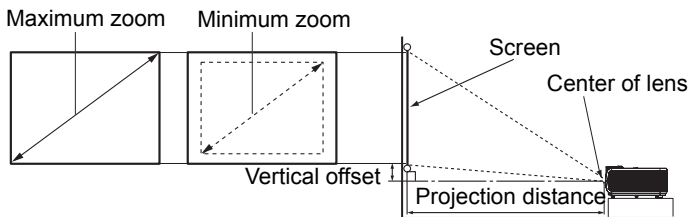

Screen size				Distance from screen (mm)			Vertical offset (mm)
Diagonal		W (mm)	H (mm)	Min length (max. zoom)	Average	Max length (min. zoom)	
Inch	mm						
30	762	610	457	1200	1260	1320	69
40	1016	813	610	1600	1680	1760	91
50	1270	1016	762	2000	2100	2200	114
60	1524	1219	914	2400	2520	2640	137
80	2032	1626	1219	3200	3360	3520	183
100	2540	2032	1524	4000	4200	4400	229
120	3048	2438	1829	4800	5040	5280	274
150	3810	3048	2286	6000	6300	6600	343
200	5080	4064	3048	8000	8400	8800	457
220	5588	4470	3353	8800	9240	9680	503
250	6350	5080	3810	10000	10500	11000	572
300	7620	6096	4572	12000	12600	13200	686

There is 3% tolerance among these numbers due to optical component variations. BenQ recommends that if you intend to permanently install the projector, you should physically test the projection size and distance using the actual projector in situ before you permanently install it, so as to make allowance for this projector's optical characteristics. This will help you determine the exact mounting position so that it best suits your installation location.

Connection

When connecting a signal source to the projector, be sure to:

1. Turn all equipment off before making any connections.
2. Use the correct signal cables for each source.
3. Ensure the cables are firmly inserted.

- ☞ • In the connections shown below, some cables may not be included with the projector (see **"Shipping contents"** on page 8). They are commercially available from electronics stores.
- For detailed connection methods, see pages 19-23.

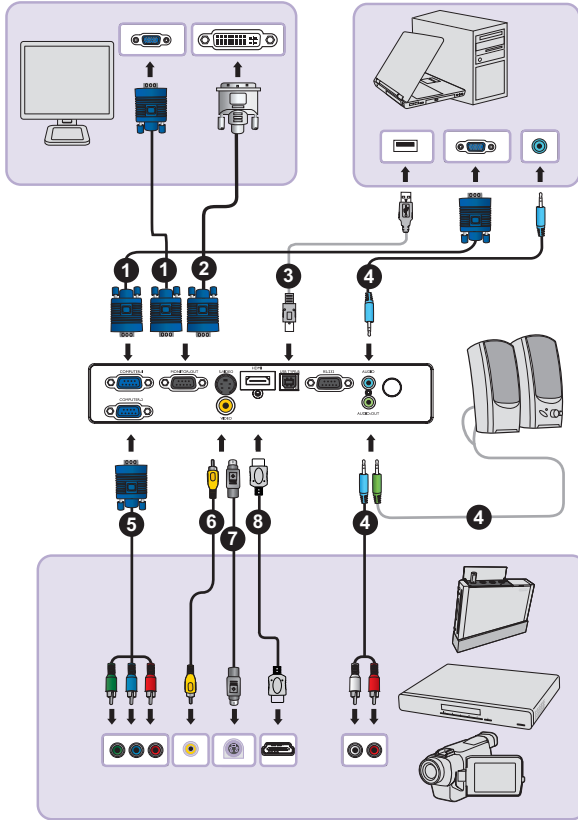

1. VGA cable	5. Component Video to VGA (DSub) adapter cable
2. VGA to DVI-A cable	6. Video cable
3. USB Cable	7. S-Video cable
4. Audio Cable	8. HDMI cable

Connecting a computer or monitor

Connecting a computer

The projector can connect to both IBM® compatibles and Macintosh® computers. A Mac adapter is needed if you are connecting legacy version Macintosh computers.

To connect the projector to a notebook or desktop computer:

1. Take the supplied VGA cable and connect one end to the D-Sub output socket of the computer.
2. Connect the other end of the VGA cable to the **COMPUTER 1** or **COMPUTER 2** signal input jack on the projector.
3. If you wish to make use of the projector (mixed mono) speaker(s) in your presentations, take a suitable audio cable and connect one end of the cable to the audio output jack of the computer, and the other end to the **AUDIO** jack of the projector. When you connect audio output signal from a computer, please balance out the volume control bar to obtain an optimal sound effects.
4. If you wish, you can use another suitable audio cable and connect one end of the cable to the **AUDIO OUT** jack of the projector, and the other end to your external speakers (not supplied).

Once connected, the audio can be controlled by the projector On-Screen Display (OSD) menus. See "[Audio Settings](#)" on page 52 for details.

The built-in speaker will be muted when the **AUDIO OUT** jack is connected.

 Many notebooks do not turn on their external video ports when connected to a projector. Usually a key combo like FN + F3 or CRT/LCD key turns the external display on/off. Locate a function key labeled CRT/LCD or a function key with a monitor symbol on the notebook. Press FN and the labeled function key simultaneously. Refer to your notebook's documentation to find your notebook's key combination.

Connecting a monitor

If you want to view your presentation close-up on a monitor as well as on the screen, you can connect the **MONITOR OUT** signal output jack on the projector to an external monitor following the instructions below:

To connect the projector to a monitor:





1. Connect the projector to a computer as described in "[Connecting a computer](#)" on page 19.
2. Take a suitable VGA cable (only one supplied) and connect one end of the cable to the D-Sub input jack of the video monitor.
Or if your monitor is equipped with a DVI input jack, take a VGA to DVI-A cable and connect the DVI end of the cable to the DVI input jack of the video monitor.
3. Connect the other end of the cable to the **MONITOR OUT** jack on the projector.

 • The output signal for **MONITOR OUT** jack only works when the input signal comes from **COMPUTER 1** or **COMPUTER 2** jack. When the projector is powered on, the output signal from **MONITOR OUT** jack varies depending on the input signal from **COMPUTER 1** or **COMPUTER 2** jack.

- If you wish to use this connection method when the projector is in standby mode, make sure the Standby Monitor Out function is turned on in the **SYSTEM SETUP: Advanced** menu. See "[Standby Monitor Out](#)" on page 53 for details.

Connecting Video source devices

You need only connect the projector to a Video source device using just one of the above connecting methods, however each provides a different level of video quality. The method you choose will most likely depend upon the availability of matching terminals on both the projector and the Video source device as described below:

Terminal name	Terminal appearance	Reference	Picture quality
HDMI	HDMI 	"Connecting an HDMI source device" on page 21	Best
Component Video	COMPUTER 	"Connecting a Component Video source device" on page 22	Better
S-Video	S-VIDEO 	"Connecting an S-Video/composite source device" on page 23	Good
Video	VIDEO 		Normal

Connecting audio

The projector has one built-in mono speaker which is designed to provide basic audio functionality accompanying data presentations for business purposes only. It is not designed for, nor intended for stereo audio reproduction use as might be expected in home theater or home cinema applications. Any stereo audio input (if provided), is mixed into a common mono audio output through the projector speaker.

When you connect audio output signal from a video source device, please set the audio output in dual track to obtain an optimal sound effects.

If you have a separate sound system, you will most likely want to connect the audio output of your Video source device to that sound system, instead of to the mono audio projector. The audio connections illustrated on page 18 are provided for informational purposes only. You need not connect audio to the projector if there is an alternate sound system available, or if audio is not required.

Connecting an HDMI source device

The projector provides a HDMI input jack that allows you to connect it to an HDMI source device like a DVD player, a DTV tuner or a display.

HDMI (High-Definition Multimedia Interface) supports uncompressed video data transmission between compatible devices like DTV tuners, DVD players and displays over a single cable. It provides pure digital viewing and listening experience.

Examine your Video source device to determine if it has a set of unused HDMI output jacks available:

- If so, you can continue with this procedure.
- If not, you will need to reassess which method you can use to connect to the device.

To connect the projector to an HDMI source device:

1. Take an HDMI cable and connect one end to the HDMI output jack of the HDMI source device. Connect the other end of the cable to the HDMI signal input jack on the projector. Once connected, the audio can be controlled by the projector On-Screen Display (OSD) menus. See "[Audio Settings](#)" on [page 52](#) for details..
2. Connect the other end of the HDMI cable to the **HDMI** jack on the projector.



- **If the selected video image is not displayed after the projector is turned on and the correct video source has been selected, check that the Video source device is turned on and operating correctly. Also check that the signal cables have been connected correctly.**
- **In the unlikely event that you connect the projector to a DVD player via the projector's HDMI input and the projected picture displays wrong colors, please change the color space to YUV. See "[Changing Color Space](#)" on [page 31](#) for details.**
- **The projector is only capable of playing mixed mono audio, even if a stereo audio input is connected. See "[Connecting audio](#)" on [page 20](#) for details.**

Connecting a Component Video source device

Examine your Video source device to determine if it has a set of unused Component Video output jacks available:

- If so, you can continue with this procedure.
- If not, you will need to reassess which method you can use to connect to the device.

To connect the projector to a Component Video source device:

1. Take a Component Video to VGA (D-Sub) adaptor cable and connect the end with 3 RCA type connectors to the Component Video output jacks of the Video source device. Match the color of the plugs to the color of the jacks; green to green, blue to blue, and red to red.
2. Connect the other end of the Component Video to VGA (D-Sub) adaptor cable (with a D-Sub type connector) to the **COMPUTER 1** or **COMPUTER 2** jack on the projector.
3. If you wish to make use of the projector (mixed mono) speaker(s) in your presentations, take a suitable audio cable and connect one end of the cable to the audio output jack of the device, and the other end to the **AUDIO** jack of the projector.
4. If you wish, you can use another suitable audio cable and connect one end of the cable to the **AUDIO OUT** jack of the projector, and the other end to your external speakers (not supplied).

Once connected, the audio can be controlled by the projector On-Screen Display (OSD) menus. See "[Audio Settings](#)" on [page 52](#) for details.

The built-in speaker will be muted when the **AUDIO OUT** jack is connected.



- **The projector is only capable of playing mixed mono audio, even if a stereo audio input is connected. See "[Connecting audio](#)" on [page 20](#) for details.**
- **If the selected video image is not displayed after the projector is turned on and the correct video source has been selected, check that the Video source device is turned on and operating correctly. Also check that the signal cables have been connected correctly.**

Connecting an S-Video/composite source device

Examine your Video source device to determine if it has an unused S-Video/composite output jack available:

- If it has both jacks, use the S-Video output jack for connection as the S-Video terminal provides better picture quality than the Video terminal.
- If it has either of the output jacks, you can also continue with this procedure.
- If not, you will need to reassess which method you can use to connect to the device.

To connect the projector to an S-Video/Video source device:

1. Take an S-Video/Video cable and connect one end to the S-Video/Video output jack of the Video source device.
2. Connect the other end of the S-Video/Video cable to the **S-VIDEO/VIDEO** jack on the projector.
3. If you wish to make use of the projector (mixed mono) speaker(s) in your presentations, take a suitable audio cable and connect one end of the cable to the audio output jack of the device, and the other end to the **AUDIO** jack of the projector.
4. If you wish, you can use another suitable audio cable and connect one end of the cable to the **AUDIO OUT** jack of the projector, and the other end to your external speakers (not supplied).

Once connected, the audio can be controlled by the projector On-Screen Display (OSD) menus. See "[Audio Settings](#)" on page 52 for details.

The built-in speaker will be muted when the **AUDIO OUT** jack is connected.



- **The projector is only capable of playing mixed mono audio, even if a stereo audio input is connected. See "[Connecting audio](#)" on page 20 for details.**
- **If the selected video image is not displayed after the projector is turned on and the correct video source has been selected, check that the Video source device is turned on and operating correctly. Also check that the signal cables have been connected correctly.**

Operation

Starting up the projector

1. Plug the power cord into the projector and into a power outlet. Turn on the power outlet switch (where fitted). Check that the **POWER indicator light** on the projector lights orange after power has been applied.

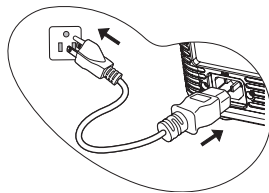

- ☞ **Please use the original accessories (e.g. power cable) only with the device to avoid possible dangers such as electric shock and fire.**
- **If Direct power on function is activated in the SYSTEM SETUP: Basic> Operation Settings menu, the projector will turn on automatically after the power cord has been connected and power has been applied. See "Direct power on" on page 51 for details.**

2. Remove the lens cap. If it is closed, it could become deformed due to the heat produced by the projection lamp.

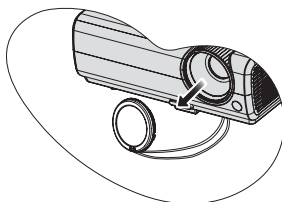

3. Press **Power** on the projector or remote control to start the projector. The **POWER indicator light** flashes and stays green when the projector is on.

The start up procedure takes about 30 seconds. In the later stage of start up, a startup logo is projected.

(If necessary) Rotate the focus ring to adjust the image clearness.

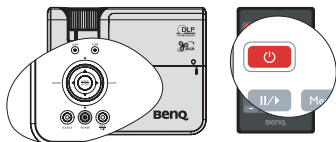

- ☞ **If the projector is still hot from previous activity, it will run the cooling fan for approximately 90 seconds before energizing the lamp.**

4. If the projector is activated for the first time, select your OSD language following the on-screen instructions.
5. If you are prompted for a password, press the arrow keys to enter a six digit password. See "Utilizing the password function" on page 28 for details.
6. Switch all of the connected equipment on.
7. The projector will start to search for input signals. The current input signal being scanned displays in the screen. If the projector doesn't detect a valid signal, the message 'No Signal' will continue displaying until an input signal is found.



You can also press **Source** on the projector or remote control to select your desired input signal. See "[Switching input signal](#)" on page 31 for details.

 If the frequency/resolution of the input signal exceeds the projector's operating range, you will see the message 'Out of Range' displayed on a blank screen. Please change to an input signal which is compatible with the projector's resolution or set the input signal to a lower setting. See "[Timing chart](#)" on page 65 for details.

Adjusting the projected image

Adjusting the projection angle

The projector is equipped with 1 quick-release adjuster foot and 1 rear adjuster foot. These adjusters change the image height and projection angle. To adjust the projector:

1. Press the quick-release button and lift the front of the projector. Once the image is positioned where you want it, release the quick-release button to lock the foot in position.
2. Screw the rear adjuster foot to fine tune the horizontal angle.

To retract the foot, hold up the projector while pressing the quick-release button, then slowly lower the projector. Screw the rear adjuster foot in a reverse direction.

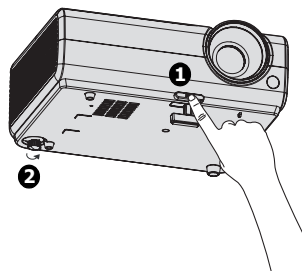

If the projector is not placed on a flat surface or the screen and the projector are not perpendicular to each other, the projected image becomes trapezoidal. To correct this situation, see "[Magnifying and searching for details](#)" on page 32 for details.

-  Do not look into the lens while the lamp is on. The strong light from the lamp may cause damage to your eyes.
- Be careful when you press the adjuster button as it is close to the exhaust vent where hot air comes from.

Auto-adjusting the image

In some cases, you may need to optimize the picture quality. To do this, press **Auto** on the projector or remote control. Within 3 seconds, the built-in Intelligent Auto Adjustment function will re-adjust the values of Frequency and Clock to provide the best picture quality.

-  • The screen will be blank while Auto is functioning.
- This function is only available when PC signal (analog RGB) is selected.

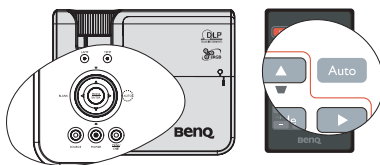

Fine-tuning the image size and clarity

1. Adjust the projected image to the size that you need using the zoom ring.

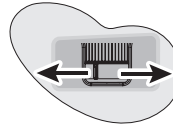

2. Then sharpen the image by rotating the focus ring.

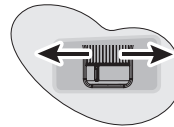

Correcting keystone

Keystoning refers to the situation where the projected image is noticeably wider at either the top or bottom. It occurs when the projector is not perpendicular to the screen.

To correct this, besides adjusting the height of the projector, you will need to manually correct it following one of these steps.

- Using the remote control

Press **▼** / **▲** on the projector or remote control to display the Keystone correction page. Press **▲** to correct keystone at the top of the image. Press **▼** to correct keystone at the bottom of the image.

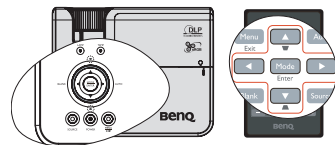

- Using the OSD menu

1. Press **Menu/Exit** and then press **◀** / **▶** until the **DISPLAY** menu is highlighted.
2. Press **▼** to highlight **Keystone** and press **Mode/Enter**. The **Keystone** correction page displays.
3. Press **▲** to correct keystone at the top of the image or press **▼** to correct keystone at the bottom of the image.



Press **▲** / **▼**.

Press **▼** / **▲**.

Using the menus

The projector is equipped with On-Screen Display (OSD) menus for making various adjustments and settings.

Below is the overview of the OSD menu.



The following example describes how to set the OSD language.

1. Press **Menu/Exit** on the projector or remote control to turn the OSD menu on.



3. Press **▼** to highlight **Language** and press **◀/▶** to select a preferred language.



2. Use **◀/▶** to highlight the **SYSTEM SETUP: Basic** menu.



4. Press **Menu/Exit** twice* on the projector or remote control to leave and save the settings.

*The first press leads you back to the main menu and the second press closes the OSD menu.

Securing the projector

Using a security cable lock

The projector has to be installed in a safe place to prevent theft. Otherwise, purchase a lock, such as the Kensington lock, to secure the projector. You can locate a Kensington lock slot on the rear side of the projector. See item 19 on page 9 for details.

A Kensington security cable lock is usually a combination of key(s) and the lock. Refer to the lock's documentation for finding out how to use it.

Utilizing the password function

For security purposes and to help prevent unauthorized use, the projector includes an option for setting up password security. The password can be set through the On-Screen Display (OSD) menu.

 **WARNING:** You will be inconvenienced if you activate the power-on lock functionality and subsequently forget the password. Print out this manual (if necessary) and write the password you used in this manual, and keep the manual in a safe place for later recall.

Setting a password

 Once a password has been set, the projector cannot be used unless the correct password is entered every time the projector is started.

1. Open the OSD menu and go to the **SYSTEM SETUP: Advanced > Security Settings** menu. Press **Mode/Enter**. The **Security Settings** page displays.
2. Highlight **Change Security Settings** and press **Mode/Enter**.
3. Highlight **Power on Lock** and select **On** by pressing **◀/▶**.
4. As pictured to the right, the four arrow keys (**▲**, **▶**, **▼**, **◀**) respectively represent 4 digits (1, 2, 3, 4). According to the password you desire to set, press the arrow keys to enter six digits for the password.
5. Confirm the new password by re-entering the new password.



Once the password is set, the OSD menu returns to the **Security Settings** page.

 **IMPORTANT:** The digits being input will display as asterisks on-screen. Write your selected password down here in this manual in advance or right after the password is entered so that it is available to you should you ever forget it.

Password: _____

Keep this manual in a safe place.

6. To leave the OSD menu, press **Menu/Exit**.

If you forget the password

If the password function is activated, you will be asked to enter the six-digit password every time you turn on the projector. If you enter the wrong password, the password error message as pictured to the right displays lasting for three seconds, and the message 'INPUT PASSWORD' follows. You can retry by entering another

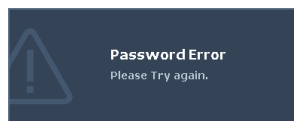

six-digit password, or if you did not record the password in this manual, and you absolutely do not remember it, you can use the password recall procedure. See "Entering the password recall procedure" on page 29 for details.

If you enter an incorrect password 5 times in succession, the projector will automatically shut down in a short time.

Entering the password recall procedure

1. Press and hold **Auto** on the projector or remote control for 3 seconds. The projector will display a coded number on the screen.
2. Write down the number and turn off your projector.
3. Seek help from the local BenQ service center to decode the number. You may be required to provide proof of purchase documentation to verify that you are an authorized user of the projector.

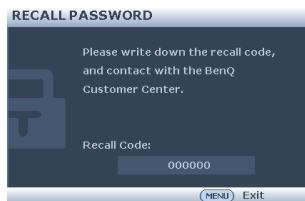

Changing the password

1. Open the OSD menu and go to the **SYSTEM SETUP: Advanced > Security Settings > Change password** menu.
2. Press **Mode/Enter**. The message 'INPUT CURRENT PASSWORD' displays.
3. Enter the old password.
 - If the password is correct, another message 'INPUT NEW PASSWORD' displays.
 - If the password is incorrect, the password error message displays lasting for three seconds, and the message 'INPUT CURRENT PASSWORD' displays for your retry. You can press **Menu/Exit** to cancel the change or try another password.
4. Enter a new password.



IMPORTANT: The digits being input will display as asterisks on-screen. Write your selected password down here in this manual in advance or right after the password is entered so that it is available to you should you ever forget it.

Password: _ _ _ _ _

Keep this manual in a safe place.

5. Confirm the new password by re-entering the new password.
6. You have successfully assigned a new password to the projector. Remember to enter the new password next time the projector is started.
7. To leave the OSD menu, press **Menu/Exit**.

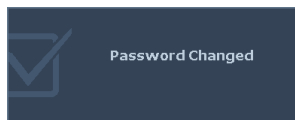

Disabling the password function

To disable password protection, go back to the **SYSTEM SETUP: Advanced > Security Settings > Change Security Settings > Power on lock** menu after opening the OSD menu system. Select **Off** by pressing **◀ / ▶**. The message 'INPUT PASSWORD' displays. Enter the current password.

- If the password is correct, the OSD menu returns to the **Security Settings** page with **'Off'** shown in the row of **Power on lock**. You will not have to enter the password next time you turn on the projector.
- If the password is incorrect, the password error message displays lasting for three seconds, and the message **'INPUT PASSWORD'** displays for your retry. You can press **Menu/Exit** to cancel the change or try another password.

 **Though the password function is disabled, you need to keep the old password in hand should you ever need to re-activate the password function by entering the old password.**

Switching input signal

The projector can be connected to multiple devices at the same time. However, it can only display one full screen at a time. When starting up, the projector automatically searches for the available signals.

Be sure the **Quick Auto Search** function in the **SOURCE** menu is **On** (which is the default of this projector) if you want the projector to automatically search for the signals.

You can also manually cycle through the available input signals.

1. Press **Source** on the projector or remote control. A source selection bar displays.
2. Press **▲/▼** until your desired signal is selected and press **Mode/Enter**.

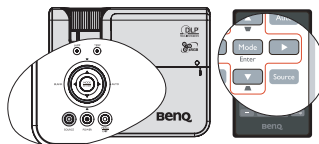

Once detected, the selected source information will display on the screen for seconds. If there is multiple equipment connected to the projector, repeat steps 1-2 to search for another signal.

- ☞ **The brightness level of the projected image will change accordingly when you switch between different input signals. Data (graphic) "PC" presentations using mostly static images are generally brighter than "Video" using mostly moving images (movies).**
- **The input signal type effects the options available for the Picture Mode. See ["Selecting a picture mode" on page 34](#) for details.**
- **The native display resolution of this projector is in a 4:3 aspect ratio. For best display picture results, you should select and use an input signal which outputs at this resolution. Any other resolutions will be scaled by the projector depending upon the 'aspect ratio' setting, which may cause some image distortion or loss of picture clarity. See ["Selecting the aspect ratio" on page 32](#) for details.**

Changing Color Space

In the unlikely event that you connect the projector to a DVD player via the projector's HDMI input and the projected picture displays wrong colors, please change the color space to YUV.

1. Press **Menu/Exit** and then press **◀/▶** until the **SOURCE** menu is highlighted.
2. Press **▼** to highlight **Color Space Conversion** and press **◀/▶** to select a suitable color space.

☞ **This function is only available when the HDMI input port is in use.**

Magnifying and searching for details

If you need to find the details on the projected picture, magnify the picture. Use the direction arrow keys for navigating the picture.

- Using the remote control
 1. Press **Digital Zoom +/-** to display the Zoom bar.
 2. Press **Digital Zoom +** to magnify the center of the picture. Press the key repeatedly until the picture size is suitable for your need.
 3. Use the directional arrows (**▲**, **▼**, **◀**, **▶**) on the projector or remote control to navigate the picture.
 4. To restore the picture to its original size, press **Auto**. You can also press **Digital Zoom -**. When the key is pressed again, the picture is further reduced until it is restored to the original size.
- Using the OSD menu
 1. Press **Menu/Exit** and then press **◀ / ▶** until the **DISPLAY** menu is highlighted.
 2. Press **▼** to highlight **Digital Zoom** and press **Mode/Enter**. The Zoom bar displays.
 3. Repeat steps 2-4 in the section of "[Using the remote control](#)" above. Or if you are using the projector control panel, continue to the following steps.
 4. Press **▲** on the projector repeatedly to magnify the picture to a desired size.
 5. To navigate the picture, press **Mode/Enter** to switch to the panning mode and press the directional arrows (**▲**, **▼**, **◀**, **▶**) to navigate the picture.
 6. Use the directional arrows (**▲**, **▼**, **◀**, **▶**) on the projector or remote control to navigate the picture.
 7. To reduce size of the picture, press **Mode/Enter** to switch back to the zoom in/out functionality, and press **Auto** to restore the picture to its original size. You can also press **▼** repeatedly until it is restored to the original size.

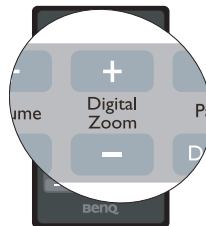

 **The picture can only be navigated after the picture is magnified. You can further magnify the picture while searching for details.**

Selecting the aspect ratio

The 'aspect ratio' is the ratio of the image width to the image height. Most analog TV and computers are in 4:3 ratio, which is the default for this projector, and digital TV and DVDs are usually in 16:9 ratio.

With the advent of digital signal processing, digital display devices like this projector can dynamically stretch and scale the image output to a different aspect than that of the image input signal.

To change the projected image ratio (no matter what aspect the source is):

1. Press **Menu/Exit** and then press **◀ / ▶** until the **DISPLAY** menu is highlighted.
2. Press **▼** to highlight **Aspect Ratio**.
3. Press **◀ / ▶** to select an aspect ratio to suit the format of the video signal and your display requirements.

About the aspect ratio

 In the pictures below, the black portions are inactive areas and the white portions are active areas. OSD menus can be displayed on those unused black areas.

1. **Auto:** Scales an image proportionally to fit the projector's native resolution in its horizontal or vertical width. This is suitable for the incoming image which is neither in 4:3 nor 16:9 and you want to make most use of the screen without altering the image's aspect ratio.

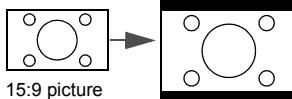
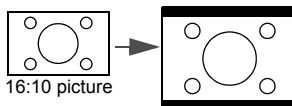

2. **Real:** The image is projected as its original resolution, and resized to fit within the display area. For input signals with lower resolutions, the projected image will display smaller than if resized to full screen. You could adjust the zoom setting or move the projector towards the screen to increase the image size if necessary. You may also need to refocus the projector after making these adjustments.

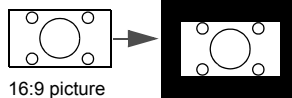

3. **4:3:** Scales an image so that it is displayed in the center of the screen with a 4:3 aspect ratio. This is most suitable for 4:3 images like computer monitors, standard definition TV and 4:3 aspect DVD movies, as it displays them without aspect alteration.

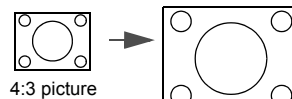

4. **16:9:** Scales an image so that it is displayed in the center of the screen with a 16:9 aspect ratio. This is most suitable for images which are already in a 16:9 aspect, like high definition TV, as it displays them without aspect alteration.

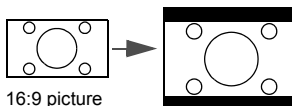

5. **16:10:** Scales an image so that it is displayed in the center of the screen with a 16:10 aspect ratio. This is most suitable for images which are already in a 16:10 aspect, like high definition TV, as it displays them without aspect alteration.

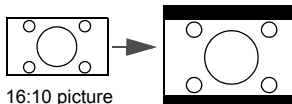

Optimizing the image

Selecting a picture mode

The projector is preset with several predefined picture modes so that you can choose one to suit your operating environment and input signal picture type.

To select an operation mode that suits your need, you can follow one of the following steps.

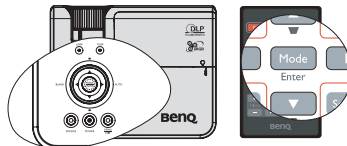

- Press **Mode/Enter** on the remote control or projector repeatedly until your desired mode is selected.
- Go to the **PICTURE > Picture Mode** menu and press **◀/▶** to select a desired mode.

The picture modes are listed below.

1. **Dynamic mode:** Maximizes the brightness of the projected image. This mode is suitable for environments where extra-high brightness is required, such as using the projector in well lit rooms.
2. **Presentation mode (Default):** Is designed for presentations. The brightness is emphasized in this mode.
3. **sRGB mode:** Maximizes the purity of RGB colors to provide true-to-life images regardless of brightness setting. It is most suitable for viewing photos taken with an sRGB compatible and properly calibrated camera, and for viewing PC graphic and drawing applications such as AutoCAD.
4. **Cinema mode:** Is appropriate for playing colorful movies, video clips from digital cameras or DVs through the PC input for best viewing in a blackened (little light) environment.
5. **User 1/User 2 mode:** Recalls the settings customized based on the current available picture modes. See "[Setting the User 1/User 2 mode](#)" on page 34 for details.

Setting the User 1/User 2 mode

There are two user-definable modes if the current available picture modes are not suitable for your need. You can use one of the picture modes (except the **User 1/User 2**) as a starting point and customize the settings.

1. Press **Menu/Exit** to open the On-Screen Display (OSD) menu.
2. Go to the **PICTURE > Picture Mode** menu.
3. Press **◀/▶** to select **User 1** to **User 2**.
4. Press **▼** to highlight **Reference Mode**.

 **This function is only available when User 1 or User 2 mode is selected up in the Picture Mode sub-menu item.**

5. Press **◀/▶** to select a picture mode that is closest to your need.
6. Press **▼** to select a sub-menu item to be changed and adjust the value with **◀/▶**. See "[Fine-tuning the image quality in user modes](#)" below for details.
7. When all settings have been done, highlight **Save Settings** and press **Mode/Enter** to store the settings.
8. The confirmation message '**Setting Saved**' displays.

Using Wall Color

In the situation where you are projecting onto a colored surface such as a painted wall which may not be white, the **Wall Color** feature can help correct the projected picture's color to prevent possible color difference between the source and projected pictures.

To use this function, go to the **DISPLAY > Wall Color** menu and press ◀/▶ to select a color which is the closest to the color of the projection surface. There are several precalibrated colors to choose from: **Light Yellow, Pink, Light Green, Blue, and Blackboard.**

Fine-tuning the image quality in user modes

According to the detected signal type, there are some user-definable functions available when **User 1** or **User 2** mode is selected. Based on your needs, you can make adjustments to these functions by highlighting them and pressing ◀ / ▶ on the projector or remote control

Adjusting Brightness

The higher the value, the brighter the image. And the lower the setting, the darker the image. Adjust this control so the black areas of the image appear just as black and that detail in the dark areas is visible.



Adjusting Contrast

The higher the value, the greater the contrast. Use this to set the peak white level after you have previously adjusted the **Brightness** setting to suit your selected input and viewing environment.



Adjusting Color

Lower setting produces less saturated colors. If the setting is too high, colors on the image will be overpowering, which makes the image unrealistic.

Adjusting Tint

The higher the value, the more reddish the picture becomes. The lower the value, the more greenish the picture becomes.

Adjusting Sharpness

The higher the value, the sharper the picture becomes. The lower the value, the softer the picture becomes.

Adjusting Brilliant Color

This feature utilizes a new color-processing algorithm and system level enhancements to enable higher brightness while providing truer, more vibrant colors in picture. It enables a greater than 50% brightness increase in mid-tone images, which are common in video and natural scenes, so the projector reproduces images in realistic and true colors. If you prefer images with that quality, select **On**. If you don't need it, select **Off**.

On is the default and recommended selection for this projector. When **Off** is selected, the **Color Temperature** function is not available.

Selecting a Color Temperature

The options available for color temperature* settings vary according to the signal type selected.

1. **T1:** With the highest color temperature, T1 makes the image appear the most bluish white than other settings.

2. **T2:** Makes images appear bluish white.
3. **T3:** Maintains normal colorings for white.
4. **T4:** Makes images appear reddish white.

***About color temperatures:**

There are many different shades that are considered to be "white" for various purposes. One of the common methods of representing white color is known as the "color temperature". A white color with a low color temperature appears to be reddish white. A white color with a high color temperature appears to have more blue in it.

3D Color Management

In most installation situations, color management will not be necessary, such as in classroom, meeting room, or lounge room situations where lights remain on, or where building external windows allow daylight into the room.

Only in permanent installations with controlled lighting levels such as boardrooms, lecture theaters, or home theaters, should color management be considered. Color management provides fine color control adjustment to allow for more accurate color reproduction, should you require it.

Proper color management can only be achieved under controlled and reproducible viewing conditions. You will need to use a colorimeter (color light meter), and provide a set of suitable source images to measure color reproduction. These tools are not provided with the projector, however, your projector supplier should be able to provide you with suitable guidance, or even an experienced professional installer.

The Color Management provides six sets (RGBCMY) of colors to be adjusted. When you select each color, you can independently adjust its range and saturation according to your preference.

If you have purchased a test disc which contains various color test patterns and can be used to test the color presentation on monitors, TVs, projectors, etc. You can project any image from the disc on the screen and enter the **3D Color Management** menu to make adjustments.

To adjust the settings:

1. Go to the **PICTURE** menu and highlight **3D Color Management**.
2. Press **Mode/Enter** and the **3D Color Management** page displays.
3. Highlight **Primary Color** and press ◀/▶ to select a color from among Red, Yellow, Green, Cyan, Blue, or Magenta.
4. Press ▼ to highlight **Hue** and press ◀/▶ to select its range. Increase in the range will include colors consisted of more proportions of its two adjacent colors.

Please refer to the illustration to the right for how the colors relate to each other.

For example, if you select Red and set its range at 0, only pure red in the projected picture will be selected. Increasing its range will include red close to yellow and red close to magenta.

5. Press ▼ to highlight **Saturation** and adjust its values to your preference by pressing ◀/▶. Every adjustment made will reflect to the image immediately.

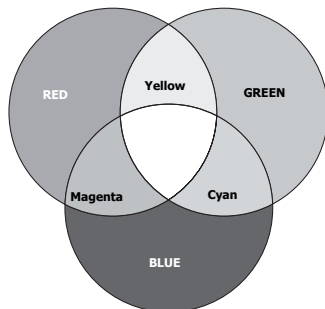

For example, if you select Red and set its value at 0, only the saturation of pure red will be affected.



Saturation is the amount of that color in a video picture. Lower settings produce less saturated colors; a setting of “0” removes that color from the image entirely. If the saturation is too high, that color will be overpowering and unrealistic.

6. Press ▼ to highlight **Gain** and adjust its values to your preference by pressing ◀/▶. The contrast level of the primary color you select will be affected. Every adjustment made will reflect to the image immediately.
7. Repeat steps 3 to 6 for other color adjustments.
8. Make sure you have made all of the desired adjustments.
9. Press **Menu/Exit** to exit and save the settings.

Creating your own startup screen

In addition to selecting the projector preset startup screen from among BenQ logo, Black or Blue screen, you can make your own startup screen that is an image projected from your computer or video source.

1. Project the image you want to use as your startup screen from either a computer or video source.
2. Press **CAPTURE** on the remote control or go to the **SYSTEM SETUP: Basic > MyScreen** menu, press **Mode/Enter**.
3. A confirmation message displays. Press **CAPTURE** or **Mode/Enter** again.
4. The message '**Screen Capturing...**' displays while the projector is processing the image. Please wait.
5. If the action is successful, you see the message '**Captured Succeeded**' on the screen. The captured image is saved as **MyScreen**.
6. To view the captured image displayed as the startup screen, set **MyScreen** in the **SYSTEM SETUP: Basic > Splash Screen** menu and restart the projector.

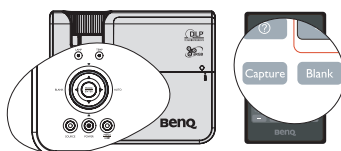

In the unlikely event, the capturing action failed. If so, change your target image.

Setting the presentation timer

The presentation timer can indicate the presentation time on the screen to help you achieve better time management when giving presentations. Follow these steps to utilize this function:

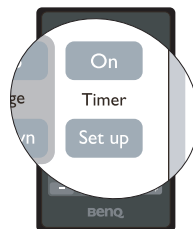

1. Press **Timer Set up** on the remote control or go to the **SYSTEM SETUP: Basic > Presentation Timer** menu and press **Mode/Enter** to display the **Presentation Timer** page.
2. Highlight **Timer period** and decide the timer period by pressing **◀/▶**. The length of time can be set from 1 to 5 minutes in 1-minute increments and 5 to 240 minutes in 5-minute increments.
3. Press **▼** to highlight **Timer display** and choose if you want the timer to show up on the screen by pressing **◀/▶**.

Selection	Description
Always	Displays the timer on screen throughout the presentation time.
Last 1 min/Last 2 min/Last 3 min	Displays the timer on screen in the last 1/2/3 minute(s).
Never	Hides the timer throughout the presentation time.

4. Press **▼** to highlight **Timer position** and set the timer position by pressing **◀/▶**.
Top-Left → Bottom-Left → Top-Right → Bottom-Right
5. Press **▼** to highlight **Timer counting direction** and select your desired counting direction by pressing **◀/▶**.

Selection	Description
Count Up	Increases from 0 to the preset time.
Count Down	Decrease from the preset time to 0.

6. To activate the presentation timer, press **▼** and press **◀/▶** to select **On** and press **Mode/Enter**.
7. A confirmation message displays. Highlight **Yes** and press **Mode/Enter** to confirm. You will see the message "**Timer is On**" displaying on the screen. The timer starts counting at the time the timer is on.

To cancel the timer, perform the following steps.

- Using the remote control.

Press **Timer On** and press **◀/▶** to highlight **Off** and press **Mode/Enter**.

- Using the OSD menu.

1. Go to the **SYSTEM SETUP: Basic > Presentation Timer** menu and highlight **Off**. Press **Mode/Enter**. A confirmation message displays.

- Highlight **Yes** and press **Mode/Enter** to confirm. You will see the message “Timer is Off!” displaying on the screen.

How to use the Timer On key?

Timer On is a multi-functional key.

- If the presentation timer is off, pressing this key displays a confirmation message. You can decide whether to activate the timer or not by following the on-screen instruction.
- If the timer is already on, pressing this key displays a confirmation message. You can decide whether to restart, continue or turn off the timer by following the on-screen instruction.

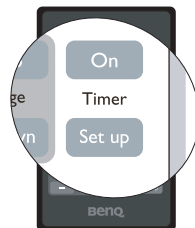

Remote paging operations

Connect the projector to your PC or notebook with a USB cable prior to using the paging function. See ["Connecting a computer" on page 19](#) for details.

You can operate your display software program (on a connected PC) which responds to page up/down commands (like Microsoft PowerPoint) by pressing **Page Up/Down** on the remote control.

If remote paging function doesn't work, check if the USB connection is correctly made and the mouse driver on your computer is updated to the latest version.

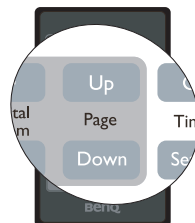

Hiding the image

In order to draw the audience's full attention to the presenter, you can use **BLANK** on the projector or remote control to hide the screen image. Press any key on the projector or remote control to restore the image. The word '**BLANK**' appears at the screen while the image is hidden. When this function is activated with an audio input connected, the audio can still be heard.

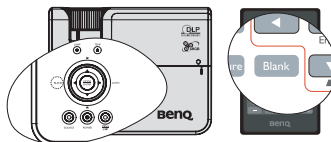

You can set the blank time in the **SYSTEM SETUP:**

Basic > Operation Settings > Blank Timer menu to let the projector return the image automatically after a period of time when there is no action taken on the blank screen. The length of time can be set from 5 to 30 minutes in 5-minute increments.

 **Do not block the projection lens from projecting as this could cause the blocking object to become heated.**

No matter Blank Timer is activated or not, you can press any key (except the Page Up/Down key) on the projector or remote control to restore the picture.

Freezing the image

Press **||/▶** on the remote control to freeze the image. The word **'FREEZE'** will display in the screen. To release the function, press any key (except the **Page Up/Down** key) on the projector or remote control.

Even if an image is frozen on the screen, the pictures are running on the video or other device. If the connected devices have active audio output, you will still hear the audio even though the image is frozen on screen.

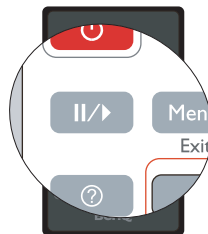

Utilizing FAQ function

The **INFORMATION** menu contains possible solutions to problems encountered by users regarding image quality, installation, special feature operation and service information.

To get the FAQ information:

1. Press **?** on the remote control or press **Menu/Exit** to open the OSD menu and press **◀/▶** to highlight the **INFORMATION** menu.
2. Press **▼** to highlight **FAQ-Image and Installation** or **FAQ-Features and Service** based on the information you want to know.
3. Press **Mode/Enter**.
4. Press **▲/▼** to select a problem and press **Mode/Enter** for possible solutions.
5. Press **Menu/Exit** to exit the OSD.



Operating in a high altitude environment

We recommend you use the **High Altitude Mode** when your environment is between 1500 m –3000 m above sea level, and ambient temperature is between 0°C–35°C.

 **Do not use the High Altitude Mode if your altitude is between 0 m and 1500 m and ambient temperature is between 0°C and 35°C. The projector will be over cooled, if you turn the mode on under such a condition.**

To activate the **High Altitude Mode**:

1. Press **Menu/Exit** and then press ◀ / ▶ until the **SYSTEM SETUP: Advanced** menu is highlighted.
2. Press ▼ to highlight **High Altitude Mode** and press ◀ / ▶ to select **On**. A confirmation message displays.
3. Highlight **Yes** and press **Mode/Enter**.

Operation under "**High Altitude Mode**" may cause a higher decibel operating noise level because of increased fan speed necessary to improve overall system cooling and performance.

If you use this projector under other extreme conditions excluding the above, it may display auto shut-down symptoms, which is designed to protect your projector from over-heating. In cases like this, you should switch to High Altitude mode to solve these symptoms. However, this is not to state that this projector can operate under any and all harsh or extreme conditions.

Adjusting the sound

The sound adjustments made as below will have an effect on the projector speaker(s). Be sure you have made a correct connection to the projector audio input. See "[Connection](#)" on [page 18](#) for how the audio input is connected.

Muting the sound

To temporarily turn off the sound:

1. Press **Menu/Exit** and then press ◀ / ▶ until the **SYSTEM SETUP: Advanced** menu is highlighted.
2. Press ▼ to highlight **Audio Settings** and press **Mode/Enter**. The Audio Settings page displays.
3. Highlight **Mute** and press ◀ / ▶ to select **On**.

Adjusting the sound level

To adjust the sound level, press **Volume +/-** on the remote control, or:

1. Repeat steps 1-2 above.
2. Press ▼ to highlight **Volume** and press ◀ / ▶ to select a desired sound level.

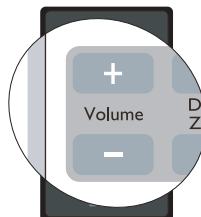

Personalizing the projector menu display

The On-Screen Display (OSD) menus can be set according to your preferences. The following settings do not affect the projection settings, operation, or performance.

- **Menu display time** in the **SYSTEM SETUP: Basic > Menu Settings** menu sets the length of time the OSD will remain active after your last key press. The time length ranges from 5 to 30 seconds in 5-second increments. Use ◀/▶ to select a suitable time frame.
- **Menu position** in the **SYSTEM SETUP: Basic > Menu Settings** menu sets the OSD position in five locations. Use ◀/▶ to select a preferred position.
- **Language** in the **SYSTEM SETUP: Basic** menu sets your familiar language for the OSD menus. Use ◀/▶ to select your language.
- **Reminder Message** in the **SYSTEM SETUP: Basic > Menu Settings** menu sets whether to display reminder messages on screen. Use ◀/▶ to select your desired setting.
- **Splash Screen** in the **SYSTEM SETUP: Basic** menu sets a preferred logo screen to be displayed during projector start-up. Use ◀/▶ to select a screen.

Shutting down the projector

1. Press **Power** and a confirmation message displays prompting you.
If you don't respond in a few seconds, the message will disappear.
2. Press **Power** a second time. The **POWER indicator light** flashes orange, the projection lamp shuts down, and the fans will continue to run for approximately 90 seconds to cool down the projector.

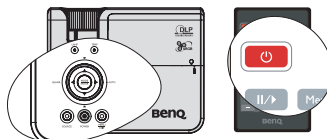

- **To protect the lamp, the projector will not respond to any commands during the cooling process.**
- **To shorten the cooling time, you can also activate the Quick Cooling function. See "Quick Cooling" on page 45 for details.**

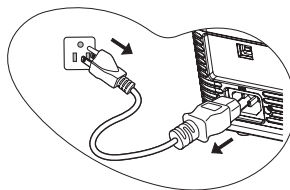

3. Once the cooling process finishes, the **POWER indicator light** is a steady orange and fans stop.
4. Disconnect the power cord from the power outlet if the projector will not be used in an extended period of time.



- **If the projector is not properly shut down, to protect the lamp, when you attempt to re-start the projector, the fans will run for a few minutes to cool down. Press Power again to start the projector after the fans stop and the POWER indicator light turns orange.**
- **Actual lamp life may vary due to different environmental conditions and usage.**

Menu operation

Menu system

Please note that the on-screen display (OSD) menus vary according to the signal type selected.

Main menu	Sub-menu	Options	
1. DISPLAY	Wall Color	Off/Light Yellow/Pink/Light Green/Blue/Blackboard	
	Aspect Ratio	Auto/Real/4:3/16:9/16:10	
	Keystone		
	Position		
	Phase		
	H. Size		
	Digital Zoom		
	3D Sync	On/Off	
	3D Sync Invert	Disable/Invert	
	Teaching Template	Blackboard	Letter Formation/Musical Staff/Worksheet/Coordinate Chart
		Whiteboard	Letter Formation/Musical Staff/Worksheet/Coordinate Chart
	2. PICTURE	Picture Mode	Dynamic/Presentation/sRGB/Cinema/User 1/User 2
		Reference Mode	Dynamic/Presentation/sRGB/Cinema
Brightness			
Contrast			
Color			
Tint			
Sharpness			
Brilliant Color		On/Off	
Color Temperature		T1/T2/T3/T4	
3D Color Management		Primary Color	R/G/B/C/M/Y
		Hue	
		Saturation	
		Gain	
Save Settings			
3. SOURCE	Quick Auto Search	On/Off	
	Color Space Conversion	Auto/RGB/YUV	

Presentation Timer	Timer period	1~240 minutes
	Timer display	Always/Last 1 min/Last 2 min/Last 3 min/Never
	Timer position	Top-Left/Bottom-Left/Top-Right/Bottom-Right
	Timer counting direction	Count Down/Count Up
	On/Off	
Language		English/ Français/ Deutsch/ Italiano/ Español/ Русский / 繁體中文/ 简体中文/ 日本語/ 한국어/ Svenska/ Nederlands/ Türkçe/ Čeština/ Português/ Телугу/ Polski Magyar/ Hrvatski/ Română/ Norsk/ Dansk/ Български / Suomi / Ελληνικά Bahasa Indonesia
Projector Position		Front Table/Rear Table/Rear Ceiling/Front Ceiling
Menu Settings	Menu display time	5 sec/10 sec/15 sec/20 sec/25 sec/30 sec
	Menu position	Center/Top-left/Top-right/Bottom-right/Bottom-left
	Reminder message	On/Off
Operation Settings	Direct power on	On/Off
	Auto Power Off	Disable /5 min/10 min/15 min/20 min/25 min/30 min
	Blank Timer	Disable /5 min/10 min/15 min/20 min/25 min/30 min
	Sleep Timer	Disable /30 min/1 hr/2 hr/3 hr/4 hr/8 hr/12 hr
Remote Receiver		Front+Rear/Front/Rear
Background Color		BenQ/Black/Blue/Purple
Splash Screen		BenQ/Black/Blue/MyScreen
MyScreen	Capture	Yes/No

4. SYSTEM SETUP: Basic



5. SYSTEM SETUP: Advanced	Quick Cooling	On/Off	
	High Altitude Mode	On/Off	
	Audio Settings	Mute	On/Off
		Volume	
	Lamp Settings	Lamp mode	Normal/Economic
		Reset lamp timer	
		Equivalent lamp hour	
	Security Settings	Change password	
		Change Security Settings	Power on lock Splash Screen on Lock
	Baud Rate	2400/4800/9600/14400/19200/ 38400/57600/115200	
	Test Pattern	On/Off	
	Closed Caption	Closed Caption Enable	On/Off
		Caption Version	
	Standby Monitor Out	On/Off	
	Reset All Settings		
6. INFORMATION	FAQ-Image and Installation		
	FAQ-Features and Service		
ON	Current System Status	<ul style="list-style-type: none"> • Source • Picture Mode • Resolution • Color System • Equivalent Lamp Hour • Firmware Version 	









Note that the menu items are available when the projector detects at least one valid signal. If there is no equipment connected to the projector or no signal detected, limited menu items are accessible.





Description of each menu

- ☞ • The default values listed in this manual, especially on pages 46-54, are for reference only. They may vary between the projectors due to the continuous improvement to the products.

FUNCTION (default setting/ value)	DESCRIPTION (default setting/value)
Wall Color	Corrects the projected picture's color when the projection surface is not white. See " Using Wall Color " on page 35 for details.
Aspect Ratio	There are four options to set the image's aspect ratio depending on your input signal source. See " Selecting the aspect ratio " on page 32 for details.
Keystone	Corrects any keystoneing of the image. See " Magnifying and searching for details " on page 32 for details.
1. DISPLAY menu	<p>Displays the position adjustment page. To move the projected image, use the directional arrow keys. The values shown on the lower position of the page change with every key press you made until they reach their maximum or minimum.</p> <p>☞ This function is only available when a PC signal (analog RGB) is selected.</p>
	<p>Phase (depends on the selected input signal)</p> <p>Adjusts the clock phase to reduce image distortion.</p> <p>☞ This function is only available when a PC signal (analog RGB) is selected.</p> 
	<p>H. Size</p> <p>Adjusts the horizontal width of the image.</p> <p>☞ This function is only available when a PC signal (analog RGB) is selected.</p>
Digital Zoom	Magnifies or reduces the projected image. See " Magnifying and searching for details " on page 32 for details.

FUNCTION (default setting/ value)	DESCRIPTION (default setting/value)
1. DISPLAY menu 3D Sync	<p>This projector features a 3D function which enables you to enjoy the 3D movies, videos, and sporting events in a more realistic way by presenting the depth of the images. You need to wear a pair of 3D glasses to view the 3D images.</p> <ul style="list-style-type: none"> For a PC type signal: When the vertical frequency is 120Hz, and the content being projected is made with 3D technology, selecting On will present the 3D images. <p>When the input signal is PC@120Hz, 3D sync will be enabled automatically.</p> <ul style="list-style-type: none"> For a video type signal: When the content being projected is made with 3D technology, selecting On will present the 3D images. <p>When 3D Sync function is enabled, the projector will enter a special picture mode and the current picture mode adjustment will be disabled.</p> <p> This function is only enabled when the input signal is PC@120Hz, 60Hz@Video and S-video.</p>
3D Sync Invert	<p>When you discover the inversion of the image depth, enable this function to correct the problem.</p> <p> This function is only enabled when the input signal is PC@120Hz, Video and S-video.</p>
Teaching Template	<p>Provides some templates as teaching aids. Teachers can use them for teaching.</p>



FUNCTION (default setting/ value)	DESCRIPTION (default setting/value)
Picture Mode	Pre-defined picture modes are provided so you can optimize your projector image set-up to suit your program type. See "Selecting a picture mode" on page 34 for details.
Reference Mode	Selects a picture mode that best suits your need for the image quality and further fine-tune the image based on the selections listed on the same page below. See "Setting the User 1/User 2 mode" on page 34 for details.  This function is only available when User 1/2 is selected.
Brightness	Adjusts the brightness of the image. See "Adjusting Brightness" on page 35 for details.  This function is only available when User 1/2 is selected.
Contrast	Adjusts the degree of difference between dark and light in the image. See "Adjusting Contrast" on page 35 for details.  This function is only available when User 1/2 is selected.
Color	Adjusts the color saturation level -- the amount of each color in a video image. See "Adjusting Color" on page 35 for details.  This function is only available when User 1/2 is selected.  This function is only available when a Video or S-Video signal is selected and the system format is NTSC or PAL.
Tint	Adjusts the red and green color tones of the image. See "Adjusting Tint" on page 35 for details.  This function is only available when User 1/2 is selected.  This function is only available when a Video or S-Video signal is selected and the system format is NTSC or PAL..
Sharpness	Adjusts the image to make it look sharper or softer. See "Adjusting Sharpness" on page 35 for details.  This function is only available when User 1/2 is selected.  This function is only available when a Video or S-Video signal is selected and the system format is NTSC or PAL.

FUNCTION (default setting/ value)		DESCRIPTION (default setting/value)
2. PICTURE menu	Brilliant Color	Adjusts white peaking while maintaining correct color presentation. See " Adjusting Brilliant Color " on page 35 for details.  This function is only available when User 1/2 is selected.
	Color Temperature	See " Selecting a Color Temperature " on page 35 for details.  This function is only available when User 1/2 is selected.
	3D Color Management	See " 3D Color Management " on page 36 for details.  This function is only available when User 1/2 is selected.
	Save Settings	Saves the settings made for User 1 or User 2 mode.  This function is only available when User 1/2 is selected.
3. SOURCE menu	Quick Auto Search	See " Switching input signal " on page 31 for details.
	Color Space Conversion (depends on the selected input signal)	See " Changing Color Space " on page 31 for details.

FUNCTION (default setting/ value)		DESCRIPTION (default setting/value)
4. SYSTEM SETUP: Basic menu	Presentation Timer	<p>Reminds the presenter to finish the presentation within a certain time frame. See "Setting the presentation timer" on page 38 for details.</p> <p>Timer period Sets a preferred length of time for presentation.</p> <p>Timer display Sets whether to display the timer on screen.</p> <p>Timer position Sets the position where the timer displays on screen.</p> <p>Timer counting direction Sets the timer counting direction.</p>
	Language	<p>Sets the language for the On-Screen Display (OSD) menus. See "Using the menus" on page 27 for details.</p>
	Projector Position	<p>The projector can be installed on a ceiling or behind a screen, or with one or more mirrors. See "Choosing a location" on page 14 for details.</p>
	Menu Settings	<p>Menu display time Sets the length of time the OSD will remain active after your last key press. The range is from 5 to 30 seconds in 5-second increments.</p> <p>Menu position Sets the On-Screen Display (OSD) menu position.</p> <p>Reminder message Sets whether to display the reminder message.</p>

FUNCTION (default setting/ value)	DESCRIPTION (default setting/value)
4. SYSTEM SETUP: Basic menu Operation Settings	<p>Direct Power On</p> <p>Selecting On enables the function. See "Starting up the projector" on page 24 for details.</p> <p>Auto Power Off</p> <p>Allows the projector to turn off automatically if no input signal is detected after a set period of time. See "Setting Auto Power Off" on page 56 for details.</p> <p>Blank Timer</p> <p>Sets the image blank time when the Blank feature is activated, once elapsed the image will return to the screen. See "Hiding the image" on page 39 for details.</p> <p>Sleep Timer</p> <p>Sets the auto-shutdown timer. The timer can be set to a value between 30 minutes and 12 hours.</p>
	<p>Remote Receiver</p> <p>Sets which IR remote sensor of the projector will receive the signal from the remote control.</p>
	<p>Background Color</p> <p>Allows you to select which background color will display when no signal is input into the projector. Four options are available: BenQ logo, Black, Blue, or Purple.</p>
	<p>Splash Screen</p> <p>Allows you to select which logo screen will display during projector start-up. Three options are available: BenQ logo, Black screen, or Blue screen.</p>
	<p>MyScreen</p> <p>Allows you to capture the current projected picture to save as Splash Screen.</p>

FUNCTION (default setting/ value)	DESCRIPTION (default setting/value)
Quick Cooling	<p>Selecting On enables the function and the projector cooling time will be shortened to a few seconds.</p> <p> If you attempt to restart the projector right after the quick cooling process, it may not be turned on successfully and will rerun its cooling fans.</p>
High Altitude Mode	<p>A mode for operation in high altitude areas. See "Operating in a high altitude environment" on page 41 for details.</p>
Audio Settings	<p>Allows you to enter the audio setting menu.</p> <p>Mute Sets the mute function.</p> <p>Volume Adjusts the audio volume level.</p>
Lamp Settings	<p>Lamp mode See "Setting Lamp mode as Economic" on page 56 for details.</p> <p>Reset lamp timer See "Resetting the lamp timer" on page 60 for details.</p> <p>Equivalent lamp hour See "Getting to know the lamp hour" on page 56 for details on how the total lamp hour is calculated.</p>
Security Settings	<p>Change password You will be asked to enter the current password before changing to a new one.</p> <p>Change Security Settings</p> <p>Power on lock See "Securing the projector" on page 28 for details.</p> <p>Splash Sscreen On Lock When Splash screen lock is activated, My Screen cannot be used unless the correct password is entered every time when you attempt to capture screen.</p>
Baud Rate	<p>Selects a baud rate that is identical with your computer's so that you can connect the projector using a suitable RS-232 cable and update or download the projector's firmware. This function is intended for qualified service personnel.</p>
Test Pattern	<p>Selecting On enables the function and the projector displays the grid test pattern. It helps you adjust the image size and focus and check that the projected image is free from distortion.</p>

FUNCTION (default setting/ value)	DESCRIPTION (default setting/value)
5. SYSTEM SETUP: Advanced menu	<p>Closed Caption Enable Activates the function by selecting On when the selected input signal carries closed captions.</p> <ul style="list-style-type: none"> • Captions: An on-screen display of the dialogue, narration, and sound effects of TV programs and videos that are closed captioned (usually marked as "CC" in TV listings). <p>Caption Version Selects a preferred closed captioning mode.</p>
	<p>Selecting On enables the function. The projector can output a VGA signal when it is in standby mode and the COMPUTER 1 and MONITOR OUT jacks are correctly connected to devices. See "Connecting a monitor" on page 19 for how to make the connection.</p> <p> Enabling this function slightly increases the standby power consumption.</p> <p> The Standby Monitor Out only works when an appropriate D-Sub input is made to the COMPUTER 1 jack.</p>
	<p>Returns all settings to the factory preset values.</p> <p> The following settings will still remain: Position, Phase, H. Size, User 1, User 2, Language, Projector Position, High Altitude Mode, Security Settings, Baud Rate.</p>

FUNCTION (default setting/ value)		DESCRIPTION (default setting/value)
6. INFORMATION menu	FAQ-Image and Installation	Displays possible solutions to problems you may encounter.
	FAQ-Features and Service	
	Current System Status	<p>Source Shows the current signal source.</p> <p>Picture Mode Shows the selected mode in the PICTURE menu.</p> <p>Resolution Shows the native resolution of the input signal.</p> <p>Color System Shows input system format, NTSC, PAL, SECAM, or RGB.</p> <p>Equivalent Lamp Hour Displays the number of hours the lamp has been used.</p> <p>Firmware Version Shows firmware version.</p>

Maintenance

Care of the projector

Your projector needs little maintenance. The only thing you need to do on a regular basis is to keep the lens and case clean.

Never remove any parts of the projector except the lamp. Contact your dealer if other parts need replacing.

Cleaning the lens

Clean the lens whenever you notice dirt or dust on the surface.

- Use a canister of compressed air to remove dust.
- If there is dirt or smears, use lens-cleaning paper or moisten a soft cloth with lens cleaner and gently wipe the lens surface.
- Never use any type of abrasive pad, alkaline/acid cleaner, scouring powder, or volatile solvent, such as alcohol, benzene, thinner or insecticide. Using such materials or maintaining prolonged contact with rubber or vinyl materials may result in damage to the projector surface and cabinet material.

 **Never rub the lens with abrasive materials.**

Cleaning the projector case

Before you clean the case, turn the projector off using the proper shutdown procedure as described in "[Shutting down the projector](#)" on [page 42](#) and unplug the power cord.

- To remove dirt or dust, wipe the case with a soft, lint-free cloth.
- To remove stubborn dirt or stains, moisten a soft cloth with water and a neutral pH detergent. Then wipe the case.

 **Never use wax, alcohol, benzene, thinner or other chemical detergents. These can damage the case.**

Storing the projector

If you need to store the projector for an extended time, please follow the instructions below:

- Make sure the temperature and humidity of the storage area are within the recommended range for the projector. Please refer to "[Specifications](#)" on [page 63](#) or consult your dealer about the range.
- Retract the adjuster feet.
- Remove the battery from the remote control.
- Pack the projector in its original packing or equivalent.

Transporting the projector

It is recommended that you ship the projector with its original packing or equivalent.

Lamp information

Getting to know the lamp hour

When the projector is in operation, the duration (in hours) of lamp usage is automatically calculated by the built-in timer. The method of calculating the equivalent lamp hour is as follows:

Total (equivalent) lamp hour
= 1 (hours used in Economic mode) + 4/3 (hours used in normal mode)

 See "**Setting Lamp mode as Economic**" below for more information on **Economic mode**.

The lamp hour in **Economic** mode is calculated as 3/4 of that in **Normal** mode. That is, using the projector in **Economic** mode helps to extend the lamp hour by 1/3.

To obtain the lamp hour information:

1. Press **Menu/Exit** and then press **◀/▶** until the **SYSTEM SETUP: Advanced** menu is highlighted.
2. Press **▼** to highlight **Lamp Settings** and press **Mode/Enter**. The **Lamp Settings** page displays.
3. You will see the **Equivalent lamp hour** information displaying on the menu.
4. To leave the menu, press **Menu/Exit**.

You can also get the lamp hour information on the **INFORMATION** menu.

Extending lamp life

The projection lamp is a consumable item. To keep the lamp life as long as possible, you can do the following settings via the OSD menu.

Setting Lamp mode as Economic

Using **Economic** mode reduces system noise and power consumption by 20%. If the **Economic** mode is selected, the light output will be reduced and result in darker projected pictures.

Setting the projector in **Economic** mode also extends the lamp operation life. To set **Economic** mode, go into the **SYSTEM SETUP: Advanced** > **Lamp Settings** > **Lamp mode** menu and press **◀/▶**.

Setting Auto Power Off

This function allows the projector to turn off automatically if no input source is detected after a set period of time to prevent unnecessary waste of lamp life.

To set **Auto Power Off**, go into the **SYSTEM SETUP: Basic** > **Auto Power Off** menu and press **◀/▶**. The time period can be set from 5 to 30 minutes in 5-minute increments. If the preset time lengths are not suitable for your presentation, select **Disable**. The projector will not automatically shut down in a certain time period.

Timing of replacing the lamp

When the **Lamp indicator** lights up red or a message appears suggesting it is time to replace the lamp, please install a new lamp or consult your dealer. An old lamp may cause a malfunction in the projector and in some instances the lamp may explode.

 **The Lamp indicator light and Temperature warning light will light up if the lamp becomes too hot. See "Indicators" on page 61 for details.**

The following lamp warning displays will remind you to change the lamp.

 **The warning messages below are for reference only. Please follow the actual on-screen instructions to prepare and replace the lamp.**

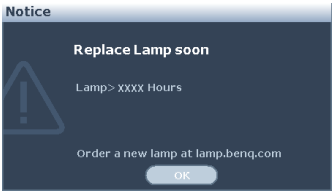
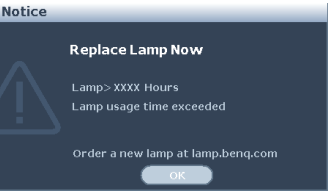
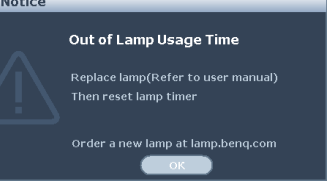
Status	Message
Install a new lamp for optimal performance. If the projector is normally run with Economic selected ("Setting Lamp mode as Economic" on page 56), you may continue to operate the projector until the next lamp warning appears.	
A new lamp should be fitted to avoid the inconvenience when the projector runs out of lamp time.	
It is strongly recommended that you replace the lamp at this stage. The lamp is a consumable item. The lamp brightness diminishes with use. This is normal lamp behavior. You can replace the lamp whenever you notice that the brightness level has significantly diminished.	
The lamp MUST be replaced before the projector will operate normally.	

 **"XXXX" shown in the above messages are numbers that vary depending on different models.**

Replacing the lamp



- **Hg - Lamp contains mercury. Manage in accordance with local disposal laws. See www.lamprecycle.org.**
 - **If lamp replacement is performed while the projector is suspended upside-down from the ceiling, make sure that no one is underneath the lamp socket to avoid any possible injury or damage to the human eyes caused by fractured lamp.**
 - **To reduce the risk of electrical shock, always turn the projector off and disconnect the power cord before changing the lamp.**
 - **To reduce the risk of severe burns, allow the projector to cool for at least 45 minutes before replacing the lamp.**
 - **To reduce the risk of injuries to fingers and damage to internal components, use caution when removing lamp glass that has shattered into sharp pieces.**
 - **To reduce the risk of injuries to fingers and/or compromising image quality by touching the lens, do not touch the empty lamp compartment when the lamp is removed.**
 - **This lamp contains mercury. Consult your local hazardous waste regulations to dispose of this lamp in a proper manner.**
 - **To assure optimal performance from the projector, it is recommended that you purchase a BenQ projector lamp for lamp replacement.**
1. Turn the power off and disconnect the projector from the power outlet. If the lamp is hot, avoid burns by waiting for approximately 45 minutes until the lamp has cooled.
 2. Loosen the screw on the lamp cover.

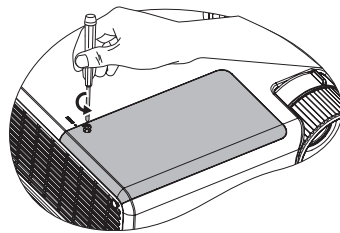

- Remove the lamp cover by (a) sliding the cover toward the side of the projector and (b) lifting it off.



- **Do not turn the power on with the lamp cover removed.**
- **Do not insert your fingers between the lamp and the projector. The sharp edges inside the projector may cause injuries.**

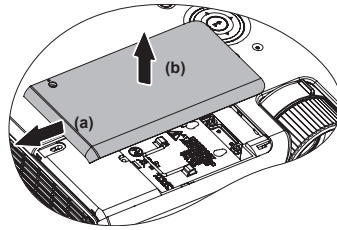

- Loosen the screws that secure the lamp.

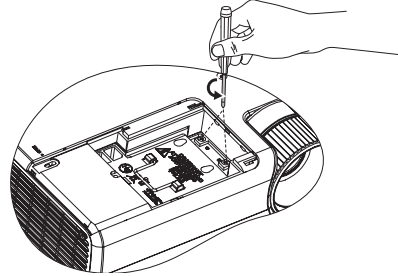

- Lift the handle so that it stands up. Use the handle to slowly pull the lamp out of the projector.



- **Pulling it too quickly may cause the lamp to break and scatter broken glass in the projector.**
- **Do not place the lamp in locations where water might splash on it, children can reach it, or near flammable materials.**
- **Do not insert your hands into the projector after the lamp is removed. If you touch the optical components inside, it could cause color unevenness and distortion of the projected images.**

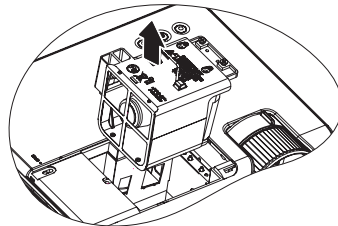

- Insert the new lamp into the lamp compartment and make sure it fits in the projector.

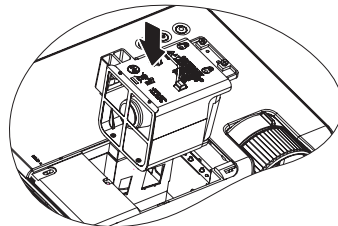

7. Tighten the screws that secure the lamp.



• **Loose screw may cause a bad connection, which could result in malfunction.**

• **Do not over tighten the screws.**

8. Ensure the handle is fully laid flat and locked in place.

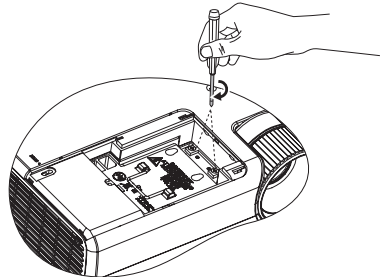

9. Replace the lamp cover by sliding it into place.

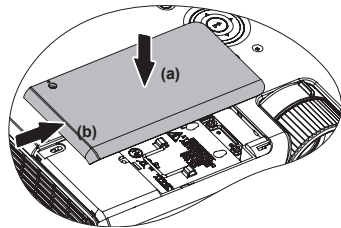

10. Tighten the screw that secures the lamp cover.



• **Loose screw may cause a bad connection, which could result in malfunction.**

• **Do not over tighten the screw.**

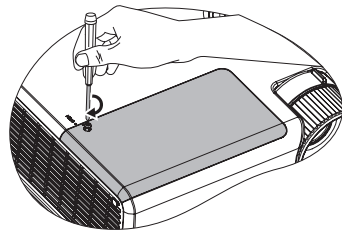

11. Restart the projector.



• **Do not turn the power on with the lamp cover removed.**

Resetting the lamp timer

12. After the startup logo, open the On-Screen Display (OSD) menu. Go to the **SYSTEM SETUP: Advanced > Lamp Settings** menu. Press **Mode/Enter**. The **Lamp Settings** page displays. Press **▼** to highlight **Reset lamp timer** and press **Mode/Enter**. A warning message displays asking if you want to reset the lamp timer. Highlight **Reset** and press **Mode/Enter**. The lamp time will be reset to '0'.

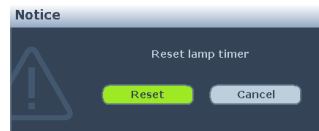

• **Do not reset if the lamp is not new or replaced as this could cause damage.**

Indicators

Light			Status & Description
POWER	TEMP	LAMP	
Power events			
Orange	Off	Off	Stand-by mode
Green Flashing	Off	Off	Powering up
Green	Off	Off	Normal operation
Orange Flashing	Off	Off	<ol style="list-style-type: none"> The projector needs 90 seconds to cool down as it was abnormally shut down without the normal cooling down process. Or The projector needs to cool for 90 seconds after the power is turned off. Or The projector has shutdown automatically. If you try to re-start the projector, it will shutdown again. Please contact your dealer for assistance.
Lamp events			
Off	Off	Red	The projector has shutdown automatically. If you try to re-start the projector, it will shutdown again. Please contact your dealer for assistance.
Off	Off	Red Flashing	<ol style="list-style-type: none"> The projector needs 90 seconds to cool down. Or Please contact your dealer for assistance.
Thermal events			
Off	Red Flashing	Off	The projector has shutdown automatically. If you try to re-start the projector, it will shutdown again. Please contact your dealer for assistance.
Off	Red	Off	
Orange Flashing	Off	Off	

Troubleshooting

? The projector does not turn on.

Cause	Remedy
There is no power from the power cable.	Plug the power cord into the AC inlet on the projector, and plug the power cord into the power outlet. If the power outlet has a switch, make sure that it is switched on.
Attempting to turn the projector on again during the cooling process.	Wait until the cooling down process has completed.

? No picture

Cause	Remedy
The video source is not turned on or connected correctly.	Turn the video source on and check that the signal cable is connected correctly.
The projector is not correctly connected to the input signal device.	Check the connection.
The input signal has not been correctly selected.	Select the correct input signal with the SOURCE key on the projector or remote control.
The lens cover is still closed.	Open the lens cover.

? Blurred image

Cause	Remedy
The projection lens is not correctly focused.	Adjust the focus of the lens using the focus ring.
The projector and the screen are not aligned properly.	Adjust the projection angle and direction as well as the height of the unit if necessary.
The lens cover is still closed.	Open the lens cover.

? Remote control does not work

Cause	Remedy
The battery is out of power.	Replace the battery with new one.
There is an obstacle between the remote control and the projector.	Remove the obstacle.
You are too far away from the projector.	Stand within 8 meters (26 feet) of the projector.

? The password is incorrect

Cause	Remedy
You do not remember the password.	Please see "Entering the password recall procedure" on page 29 for details.

Specifications

 All specifications are subject to change without notice.

Optical

Resolution
(MX511)
1024 x 768 XGA

(MS510)
800 x 600 SVGA

Display system
1-CHIP DMD

Lens F/Number
F = 2.51 to 2.69,
f = 21.95 to 24.18 mm

Lamp
185 W lamp

Electrical

Power supply
AC100–240V, 2.9 A,
50-60 Hz (Automatic)

Power consumption
260 W (Max); < 1 W (Standby)

Mechanical

Weight
2.5 Kg (5.5 lbs)

Output terminals

RGB output
D-Sub 15-pin (female) x 1

Speaker
(Stereo) 2 watt x 1

Audio signal output
PC audio jack x 1

Control

RS-232 serial control
9 pin x 1
IR receiver x 1
USB Type B x 1

Input terminals

Computer input
RGB input
D-Sub 15-pin (female) x 2

Video signal input
S-VIDEO
Mini DIN 4-pin port x 1
VIDEO
RCA jack x 1
SD/HDTV signal input
Analog - Component RCA jack x 3
(through RGB input)
Digital-HDMI x 1
Audio signal input
Audio in
PC audio jack x 1

Environmental Requirements

Operating temperature
0°C-40°C at sea level
Operating relative humidity
10%-90% (without condensation)
Operating altitude
0-1499 m at 0°C-35°C
1500-3000 m at 0°C-30°C (with High
Altitude Mode on)

Dimensions

264 mm (W) x 108.8 mm (H) x 211.4 mm (D)

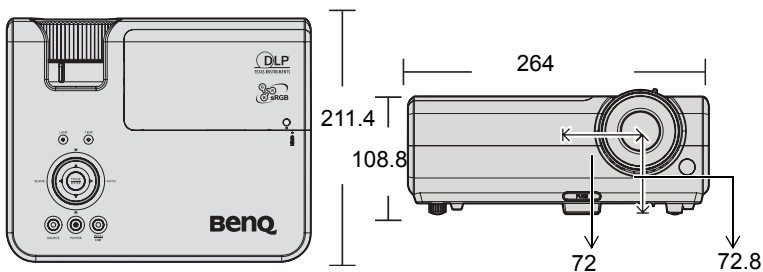

Ceiling mount installation

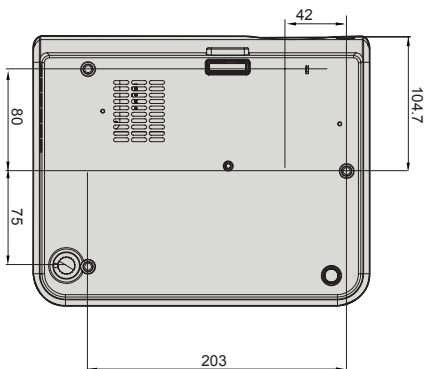

Ceiling mount screws:
M4 x 8 (Max. L = 8 mm)

Unit: mm

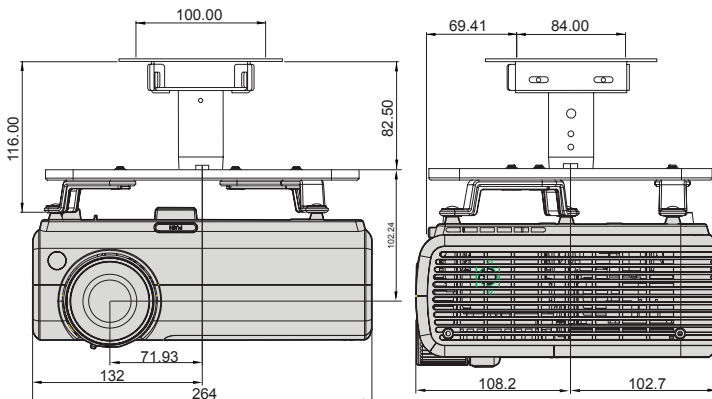

Timing chart

Supported timing for PC input

Resolution	Horizontal Frequency (kHz)	Vertical Frequency (Hz)	Pixel Frequency (MHz)	Mode
720 x 400	31.469	70.087	28.322	720 x 400_70
640 x 480	31.469	59.940	25.175	VGA_60
	37.861	72.809	31.500	VGA_72
	37.500	75.000	31.500	VGA_75
	43.269	85.008	36.000	VGA_85
800 x 600	37.879	60.317	40.000	SVGA_60
	48.077	72.188	50.000	SVGA_72
	46.875	75.000	49.500	SVGA_75
	53.674	85.061	56.250	SVGA_85
1024 x 768	48.363	60.004	65.000	XGA_60
	56.476	70.069	75.000	XGA_70
	60.023	75.029	78.750	XGA_75
	68.677	84.997	94.500	XGA_85
1024 x 576	35.820	60.0	46.996	Netbook_1
1024 x 600	37.5	60.0	45.000	Netbook_2
1024 x 600	41.467	64.995	51.419	Netbook_3
1280 x 800	49.702	59.810	83.500	WXGA_60
	62.795	74.934	106.500	WXGA_75
	71.554	84.880	122.500	WXGA_85
1280 x 1024	63.981	60.020	108.000	SXGA_60
	79.976	75.025	135.000	SXGA_75
	91.146	85.024	157.500	SXGA_85
1280 x 960	60.000	60.000	108	1280 x 960_60
	85.938	85.002	148.500	1280 x 960_85
1440 x 900	55.935	59.887	106.500	WXGA+_60
1400 x 1050	65.317	59.978	121.750	SXGA+_60
1600 x 1200	75.000	60.000	162.000	UXGA
640 x 480@67Hz	35.000	66.667	30.240	MAC13
832 x 624@75Hz	49.722	74.546	57.280	MAC16
1024 x 768@75Hz	60.241	75.020	80.000	MAC19
1152 x 870@75Hz	68.680	75.060	100.000	MAC21

Supported timing for HDMI input

Resolution	Horizontal Frequency (kHz)	Vertical Frequency (Hz)	Pixel Frequency (MHz)	Mode
720 x 400	31.469	70.087	28.322	720 x 400_70
640 x 480	31.469	59.940	25.175	VGA_60
	37.861	72.809	31.500	VGA_72
	37.500	75.000	31.500	VGA_75
	43.269	85.008	36.000	VGA_85
800 x 600	37.879	60.317	40.000	SVGA_60
	48.077	72.188	50.000	SVGA_72
	46.875	75.000	49.500	SVGA_75
	53.674	85.061	56.250	SVGA_85
1024 x 768	48.363	60.004	65.000	XGA_60
	56.476	70.069	75.000	XGA_70
	60.023	75.029	78.750	XGA_75
	68.677	84.997	94.500	XGA_85
1280 x 800	49.702	59.810	83.500	WXGA_60
	62.795	74.934	106.500	WXGA_75
	71.554	84.880	122.500	WXGA_85
1280 x 1024	63.981	60.020	108.000	SXGA_60
	79.976	75.025	135.000	SXGA_75
	91.146	85.024	157.500	SXGA_85
1280 x 960	60.000	60.000	108	1280 x 960_60
	85.938	85.002	148.500	1280 x 960_85
1440 x 900	55.935	59.887	106.500	WXGA+_60
1400 x 1050	65.317	59.978	121.750	SXGA+_60
1600 x 1200	75.000	60.000	162.000	UXGA
640 x 480@67Hz	35.000	66.667	30.240	MAC13
832 x 624@75Hz	49.722	74.546	57.280	MAC16
1024 x 768@75Hz	60.241	75.020	80.000	MAC19
1152 x 870@75Hz	68.680	75.060	100.000	MAC21
VIDEO (HDCP)	31.47	60	27	480p
	31.25	50	27	576p
	45.00	60	74.25	720p_60
	37.50	50	74.25	720_50
	33.75	60	74.25	1080i_60
	28.13	50	74.25	1080i_50
	67.5	60	148.5	1080p
	56.25	50	148.5	1080p

 Displaying a 1080i(1125i)@60Hz or 1080i(1125i)@50Hz signal may result in slight image vibration.

Supported timing for Component-YPbPr input

Signal Format	Horizontal Frequency (kHz)	Vertical Frequency (Hz)
480i(525i)@60Hz	15.73	59.94
480p(525p)@60Hz	31.47	59.94
576i(625i)@50Hz	15.63	50.00
576p(625p)@50Hz	31.25	50.00
720p(750p)@60Hz	45.00	60.00
720p(750p)@50Hz	37.50	50.00
1080i(1125i)@60Hz	33.75	60.00
1080i(1125i)@50Hz	28.13	50.00
1080p@60Hz	67.5	60.00
1080p@50Hz	56.25	50.00

 Displaying a 1080i@60Hz or 1080i@50Hz signal may result in slight image vibration.

Supported timing for Video and S-Video inputs

Video mode	Horizontal Frequency (kHz)	Vertical Frequency (Hz)	Color sub-carrier Frequency (MHz)
NTSC	15.73	60	3.58
PAL	15.63	50	4.43
SECAM	15.63	50	4.25 or 4.41
PAL-M	15.73	60	3.58
PAL-N	15.63	50	3.58
PAL-60	15.73	60	4.43
NTSC4.43	15.73	60	4.43

Warranty and Copyright information

Limited warranty

BenQ warrants this product against any defects in material and workmanship, under normal usage and storage.

Proof of purchase date will be required with any warranty claim. In the event this product is found to be defective within the warranty period, BenQ's only obligation and your exclusive remedy shall be replacement of any defective parts (labor included). To obtain warranty service, immediately notify the dealer from which you purchased the product of any defects.

Important: The above warranty shall be void if the customer fails to operate the product in accordance with BenQ's written instructions, especially the ambient humidity must be in-between 10% and 90%, temperature in-between 0°C and 35°C, altitude lower than 4920 feet, and avoiding to operate the projector in a dusty environment. This warranty gives you specific legal rights, and you may have other rights which vary from country to country.

For other information, please visit www.BenQ.com.

Copyright

Copyright 2010 by BenQ Corporation. All rights reserved. No part of this publication may be reproduced, transmitted, transcribed, stored in a retrieval system or translated into any language or computer language, in any form or by any means, electronic, mechanical, magnetic, optical, chemical, manual or otherwise, without the prior written permission of BenQ Corporation.

Disclaimer

BenQ Corporation makes no representations or warranties, either expressed or implied, with respect to the contents hereof and specifically disclaims any warranties, merchantability or fitness for any particular purpose. Further, BenQ Corporation reserves the right to revise this publication and to make changes from time to time in the contents hereof without obligation to notify any person of such revision or changes.

*DLP, Digital Micromirror Device and DMD are trademarks of Texas Instruments. Others are copyrights of their respective companies or organizations.

Regulation statements

FCC statement

CLASS B: This equipment generates, uses and can radiate radio frequency energy and, if not installed and used in accordance with the instructions, may cause harmful interference to radio communications. However, there is no guarantee that interference will not occur in a particular installation. If this equipment does cause harmful interference to radio or television reception, which can be determined by turning the equipment off and on, the user is encouraged to try to correct the interference by one or more of the following measures:

- Reorient or relocate the receiving antenna.
- Increase the distance between the equipment and receiver.
- Connect the equipment into an outlet on a circuit different from that to which the receiver is connected.
- Consult the dealer or an experienced radio/TV technician for help.

EEC statement (for European users)

This device complies with the requirements set out in the Council Directives on the Approximation of the Laws of the Member States relating Electromagnetic Compatibility (2004/108/EC), Low Voltage Directive (2006/95/EC), the Restriction of The Use of Certain Hazardous Substances in Electrical And Electronic Equipment Directive (2002/95/EC), Turkish EEE Directive, Commission Regulation (EC) No 1275/2008 implementing Directive 2005/32/EC of the European Parliament and of the Council with regard to ecodesign requirements for standby and off mode electric power consumption of electrical and electronic household and office equipment, and the Directive 2009/125/EC of the European parliament and of the council establishing a framework for the setting of ecodesign requirements for energy-related products.

WEEE directive

Disposal of Waste Electrical and Electronic Equipment by users in private households in the European Union.

This symbol on the product or on the packaging indicates that this can not be disposed of as household waste. You must dispose of your waste equipment by handing it over to the applicable take-back scheme for the recycling of electrical and electronic equipment. For more information about recycling of this equipment, please contact your city office, the shop where you purchased the equipment or your household waste disposal service. The recycling of materials will help to conserve natural resources and ensure that it is recycled in a manner that protects human health and environment.



Accessibility Requirements for Rehabilitation Act of 1973, Section 508

BenQ's commitment to accessible products allows us to support government in making accessible technology choices BenQ's LCD monitors and projectors are compliant with Section 508 guidelines by including the assistive features as below:

- BenQ's monitors have colored "Power" indicators. While the indicator shows green, it means that the monitor is using the full power. While the indicator shows yellow or amber, it means that the monitor is in suspend or sleep mode and is using less than 2 watts of electricity.
- BenQ's monitors have a variety of settings of pre-programmed flicker-free timing to make the screen shown on the monitor readily accessible. The default timing setting is automatically turned on every time the monitor is powered up, and thus reduces the hassle of user intervention.
- BenQ's monitors and projectors have options for brightness and contrast adjustments that text and images could be displayed differently to meet the demands of the visually impaired. Other similar adjustments are also available by using the On-Screen Display (OSD) controls on the products.
- BenQ's monitors and projectors include user-selectable color controls, such as color temperature selections (Monitor: 5800K, 6500K and 9300K, Projector: 5500K, 6500K, 7500K and 9300K), with a wide range of contrast levels.
- BenQ's multimedia monitors and projectors usually have one or two speakers for audio performance which allow users (including hearing impaired) to interact with the computer systems connected. Speaker controls are typically located on the front-panel.
- Firmware of BenQ's monitors and projectors contain unique product information that helps computer systems to identify BenQ products and activate their Plug-and-Play function when connected.
- All BenQ's monitors and projectors are compatible with the PC99 standard. For example, connectors are color-coded to help users easily connecting products to computer systems correctly.
- Some models of BenQ's monitors and projectors contain additional USB and DVI ports for connection to more devices such as a special headphone to assist the hearing impaired.
- All BenQ monitors and projectors come with user manuals on compact discs which could be easily read by commercial software such as Adobe Reader via a connected computer system. These documents are also available on the BenQ's web site (www.BenQ.com <<http://www.BenQ.com>>). Other types of documents may be available upon requests.
- BenQ's customer service provides answers and assistance to all our customers through phone calls, facsimiles, e-mails, or web sites.

Free Manuals Download Website

<http://myh66.com>

<http://usermanuals.us>

<http://www.somanuals.com>

<http://www.4manuals.cc>

<http://www.manual-lib.com>

<http://www.404manual.com>

<http://www.luxmanual.com>

<http://aubethermostatmanual.com>

Golf course search by state

<http://golfingnear.com>

Email search by domain

<http://emailbydomain.com>

Auto manuals search

<http://auto.somanuals.com>

TV manuals search

<http://tv.somanuals.com>