

BenQ

W10000/W9000 Digital Projector

Home Cinema Series

User Manual

Welcome

Copyright

Copyright © 2006-2007 by BenQ Corporation. All rights reserved. No part of this publication may be reproduced, transmitted, transcribed, stored in a retrieval system or translated into any language or computer language, in any form or by any means, electronic, mechanical, magnetic, optical, chemical, manual or otherwise, without the prior written permission of BenQ Corporation.

Disclaimer

BenQ Corporation makes no representations or warranties, either expressed or implied, with respect to the contents hereof and specifically disclaims any warranties, merchantability or fitness for any particular purpose. Further, BenQ Corporation reserves the right to revise this publication and to make changes from time to time in the contents hereof without obligation of BenQ Corporation to notify any person of such revision or changes.

*DLP, Digital Micromirror Device and DMD are trademarks of Texas Instruments. Others are copyrights of their respective companies or organizations.

Warranty

BenQ warrants this product against any defects in material and workmanship, under normal usage and storage.

Proof of purchase date will be required with any warranty claim. In the event this product is found to be defective within the warranty period, BenQ's only obligation and your exclusive remedy shall be replacement of any defective parts (labor included). To obtain warranty service, immediately notify the dealer from which you purchased the product of any defects.

Important: The above warranty shall be void if the customer fails to operate the product in accordance with BenQ's written instructions, especially the ambient humidity must be in-between 10% and 90%, temperature in-between 0°C and 40°C, altitude lower than 10000 feet, and avoiding to operate the projector in a dusty environment. This warranty gives you specific legal rights, and you may have other rights which vary from country to country.

For other information, please visit www.BenQ.com.

iv Table of contents

Safety, regulatory and legal information	5
FCC statement (for United States users)	5
EEC statement (for European users)	5
MIC statement	5
Moisture condensation	5
Avoid volatile liquid	5
Disposal	5
Safety instructions	6
Overview	9
Shipping contents	9
Remote control batteries	9
BenQ W10000/W9000 projector features	10
Projector exterior view	11
Front and upper side view	11
Rear view	11
Under and side view	11
Connector panel	11
Controls and functions	12
Control panel	12
Remote control	13
Positioning your projector	14
Choosing a location	14
Obtaining a preferred projected image size	15
Installation for a 16:9 ratio screen	15
Installation for a 4:3 ratio screen	16
Shifting the projection lens vertically	16
Connecting with video equipment	17
Connecting a computer	17
Connecting video inputs	18
Connecting HDMI devices	18
Connecting component-video devices	18
Connecting S-video or video devices	18
Using the projector	19
Preparations	19
Turning the projector on	19
Selecting an input video source	19
Adjusting the projected image	19
Adjusting the projection angle	19

Fine-tuning the image size and clarity	20
Optimizing the image	20
1. Selecting a preset mode	20
2. Selecting the aspect ratio	20
3. Adjusting contrast ratio	21
4. Other adjustments	22
Displaying more than one image source simultaneously	22
Personalizing the projector menu display	23
Saving and loading the video memory	23
Turning the power off	23
Menus	24
On Screen Display (OSD) structure	24
Using the menus	25
Picture menu	26
Display menu	27
Options menu	27
Setup menu	28
Advance menu	28
Additional information	30
Care of the projector	30
Cleaning the lens	30
Cleaning the projector case	30
Storing the projector	30
Transporting the projector	30
Cleaning and replacing the dust filter	30
Installing the cable connector-panel cover	32
Replacing the lamp	33
Indicators	34
Troubleshooting	35
Specifications	36
Optical	36
Electrical	36
Terminals	36
General characteristics	36
Dimensions	36

1 Safety, regulatory and legal information

Thank you for your purchase of this quality BenQ video projector! It has been designed to provide you with an enjoyable home theater viewing experience. For the best results, please read this manual through carefully as it is your guide through the control menus and operation.

FCC statement (for United States users)

This equipment has been tested and found to comply with the limits for a Class B digital device, pursuant to Part 15 of the FCC Rules. These limits are designed to provide reasonable protection against harmful interference in a residential installation.

CLASS B: This equipment generates, uses and can radiate radio frequency energy and, if not installed and used in accordance with the instructions, may cause harmful interference to radio communications. However, there is no guarantee that interference will not occur in a particular installation. If this equipment does cause harmful interference to radio or television reception, which can be determined by turning the equipment off and on, the user is encouraged to try to correct the interference by one or more of the following measures:

- Reorient or relocate the receiving antenna.
- Increase the distance between the equipment and receiver.
- Connect the equipment into an outlet on a circuit different from that to which the receiver is connected.
- Consult the dealer or an experienced radio/TV technician for help.

EEC statement (for European users)

This machine was tested against the 89/336/EEC (European Economic Community) for EMC (Electro Magnetic Compatibility) and fulfills these requirements.

MIC statement

B class equipment (Household purpose info/telecommunications equipment)

As this equipment has undergone EMC registration for household purpose, this product can be used in any area including residential areas.

Moisture condensation

Never operate the projector immediately after moving it from a cold location to a hot location. When the projector is exposed to such a change in temperature, moisture may condense on the crucial internal parts. To prevent the projector from possible damage, do not use the projector for at least 2 hours when there is a sudden change in temperature.

Avoid volatile liquid

Do not use volatile liquids, such as insecticide or some types of cleaner, near the projector. Do not have rubber or plastic products touching the projector for a long time. They will leave marks on the finish. If cleaning with a chemically treated cloth, be sure to follow the cleaning product's safety instructions.

Disposal

This product contains the following materials which are harmful to human bodies and environment.

- Lead, which is contained in solder.
- Mercury, which is used in the lamp.

To dispose of the product or used lamps, consult your local environment authorities for regulations.

Safety instructions

Your BenQ projector is designed and tested to meet the latest standards for safety of information technology equipment. However, to ensure safe use of this product, it is important that you follow the instructions mentioned in this manual and marked on the product.

Safety instructions

1. Please read this user's manual before you operate your projector. Keep this manual in a safe place for future reference.

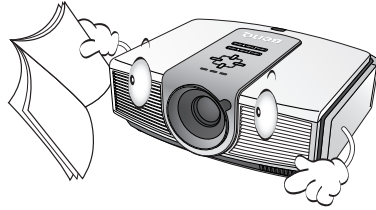

2. Always place the projector on a level, horizontal surface during operation.
 - Do not place the projector on an unstable cart, stand, or table as it may fall and be damaged;

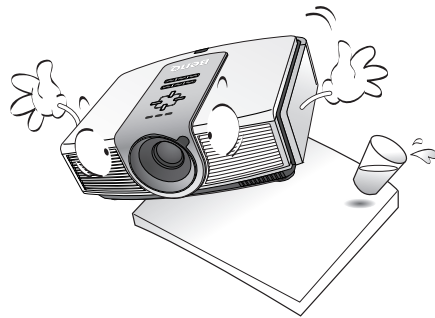

- Do not place inflammables near the projector;
- Do not use if tilted at an angle of more than 10 degrees left to right, nor at angle of more than 15 degrees front to back.

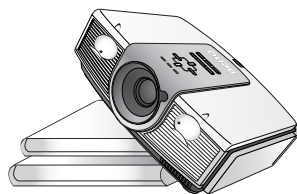

3. This projector is capable of displaying inverted images for ceiling mount installation. Use only BenQ's Ceiling Mounting Kit for mounting.

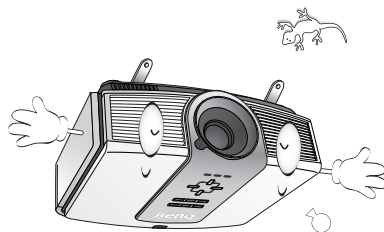

4. Do not place the projector in any of the following environments:

- space that is poorly ventilated or confined. Allow at least 50 cm clearance from walls and free flow of air around the projector;
- locations where temperatures may become excessively high, such as the inside of a car with all windows closed;
- locations where excessive humidity, dust, or cigarette smoke may contaminate optical components, shortening the projector's lifespan and darkening the screen;

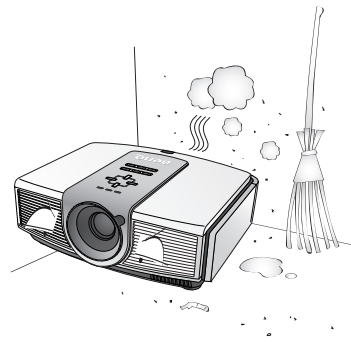

- locations near fire alarms;
- locations with an ambient temperature above 40°C / 104°F;
- locations where altitude is higher than 3050 metres / 10000 feet above sea level.

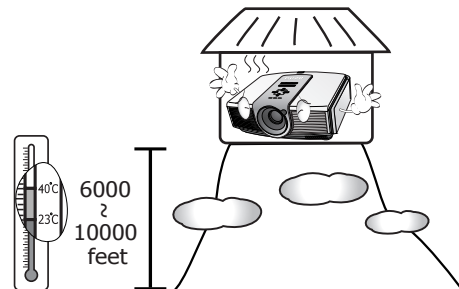

Safety instructions (continued)

5. Do not block the ventilation holes whilst the projector is on (even in standby mode):
- Do not cover the projector with any item;
 - Do not place the projector on a blanket, bedding or any other soft surface.
9. Do not look straight into the projector lens during operation. It may harm your sight.

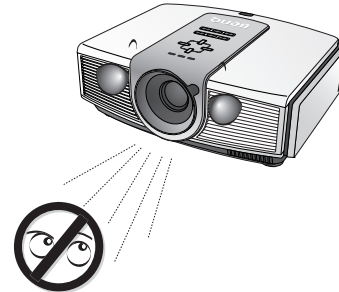
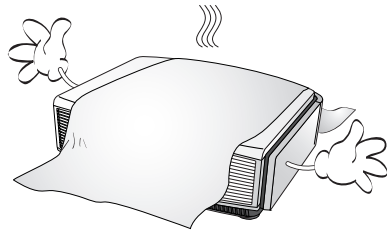

6. In areas where the mains power supply voltage may fluctuate by ± 10 volts, it is recommended that you connect your projector through a power stabilizer, surge protector or uninterruptible power supply (UPS) as appropriate to your situation.

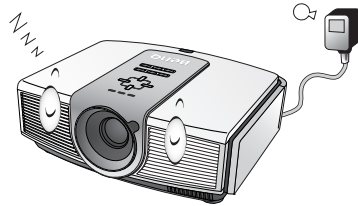

10. Do not operate the projector lamp beyond the rated lamp life. Excessive operation of lamps beyond the rated life could cause a lamp to break on rare occasions.

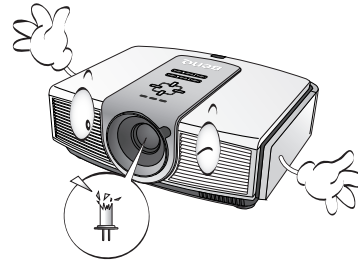

7. Do not step on the projector or place any objects upon it.



11. The lamp becomes extremely hot during operation. Allow the projector to cool for approximately 45 minutes prior to removing the lamp assembly for replacement.

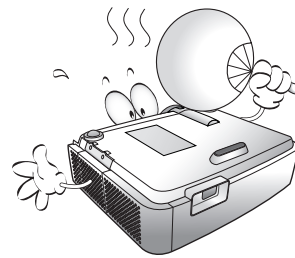

8. Do not place liquids near or on the projector. Liquids spilled into the projector will void your warranty. If the projector does become wet, disconnect it from the power point and call BenQ to have the projector repaired.

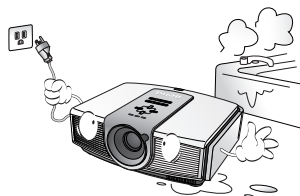

Safety instructions (continued)

12. Never attempt to replace the lamp assembly until the projector has cooled down and is unplugged from the power supply.
15. Do not store the projector on end vertically. Doing so may cause the projector to fall over, causing injury or resulting in damage.

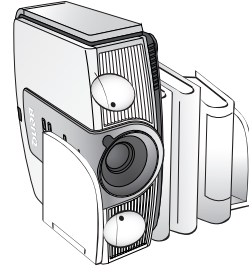
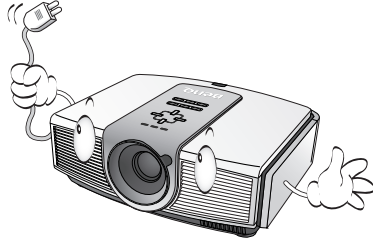

13. When you think service or repair is required, take the projector only to a suitably qualified technician.

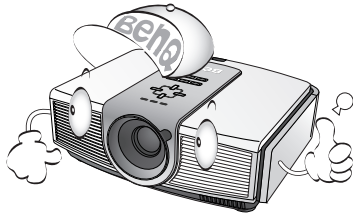

14. Do not attempt to disassemble this projector. There are dangerous high voltages inside which may cause death if you should come into contact with live parts. The only user serviceable parts are the lamp and air filters which have their own removable covers or access panels. See page 33. Under no circumstances should you ever undo or remove any other covers. Refer servicing only to suitably qualified professional service personnel.

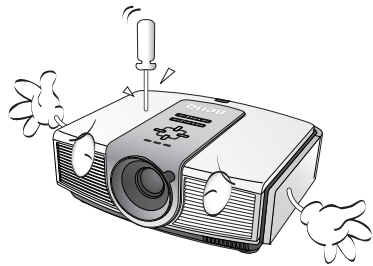

2 Overview

Shipping contents

The projector is shipped with the cables required for connection to a video and PC equipment. Some of the items may not be available depending on your region of purchase. Please check with your place of purchase.

 **Some of the accessories may vary from region to region.**

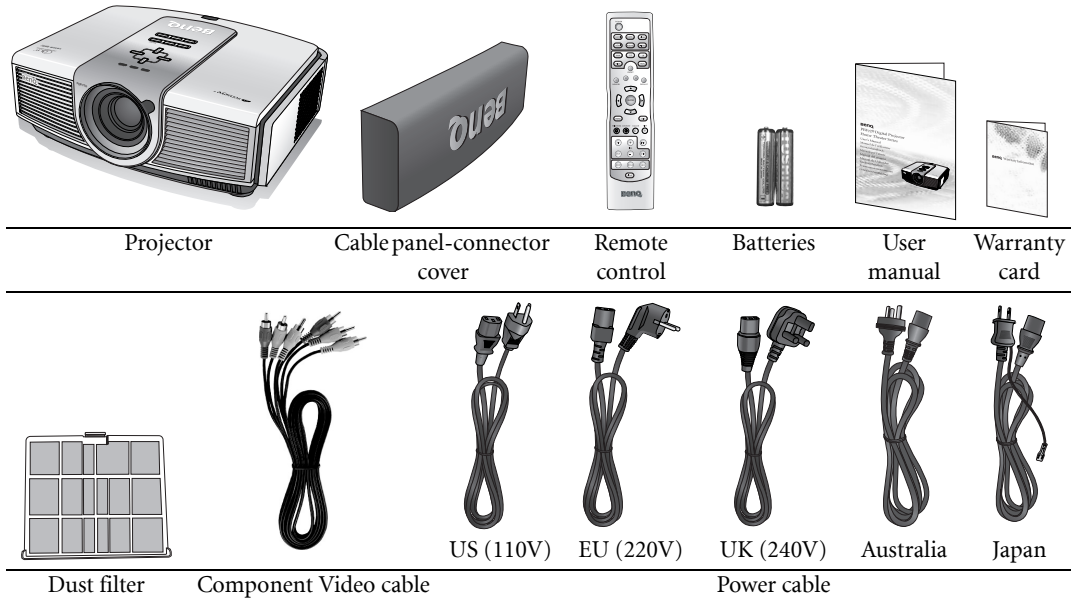

Remote control batteries

- To open the battery cover, turn the remote control over to view its back, push on the finger grip on the cover and slide it down in the direction of the arrow as illustrated. The cover will slide off.
- Remove any existing batteries (if necessary) and install two new AAA batteries observing the battery polarities as indicated in the base of the battery compartment. Positive (+) goes to positive and negative (-) goes to negative.
- Refit the cover by aligning it with the case and sliding it back up into position. Stop when it clicks into place.

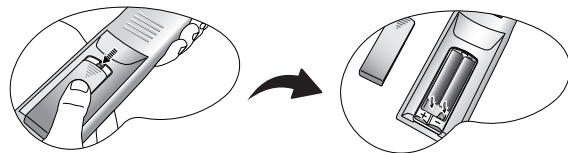

Notes on handling batteries

- Do not mix old batteries with new ones, or mix different types of batteries.
- Avoid leaving the remote control and batteries in an excessive heat or humid environment like the kitchen, bathroom, sauna, sunroom, or in a closed car.
- Dispose of used batteries according to the battery manufacturer's instructions and local environment regulations for your region.
- If the remote control will not be used for an extended period of time, remove the batteries to avoid damage to the control from possible battery leakage.

BenQ W10000/W9000 projector features

- **Full HD compatible**

The projector is compatible with Standard Definition TV (SDTV) 480i, 480p, 576i, and High Definition TV (HDTV) 576p, 720p, 1080i and 1080p formats, with the 1080p format providing a true 1:1 image reproduction.

- **Highest picture quality**

This single Dark Chip 3 DLP™ projector provides excellent picture quality due to its high resolution, excellent home theatre brightness, super high contrast ratio, vivid color and rich gray-scale reproduction.

- **Super-high contrast ratio**

This projector utilizes a motorized aperture C.A.T. lens to achieve a contrast ratio of at least 4400:1 (and up to 10000:1 in High Contrast mode).

- **Vivid color reproduction**

This projector features an 8-segment color wheel to produce realistic color depth and range unattainable with lesser segment color wheels.

- **Rich gray-scale**

When viewed in a darkened environment, the automatic gamma control provides excellent gray-scale display which reveals details in shadows and in night or darkened scenes.

- **Dynamic performance**

This model projector features a refresh rate of up to 300 Hz which provides excellent dynamic performance and eliminates the 'color flicker' or 'rainbow effect' associated with DLP projectors.

- **Extra-low noise operation**

This projector's unique cooling system design prevents unnecessary fan noise, and is rated at less than 25dB in normal mode and a low 23 dB when in Whisper mode.

- **Sealed optical engine**

The optical engine uses a high-quality 1:1.35x lens for maximizing optical performance. The sealed light path prevents light leakage, enhancing your viewing experience in darkened viewing environments, and prevents the dirtying of the optical path which can cause annoying blurring or spots in the projected image.

- **Motorized lens shift, focus and zoom**

The remote control can be used to adjust vertical lens shift, picture focus, and picture zoom size, all from the comfort of your armchair, which is particularly useful if the projector has been ceiling mounted and accessibility to its panel controls is difficult or awkward.

- **Wide variety of inputs and video formats**

The projector supports a wide variety of inputs for connection to your video and PC equipment, including component video, S-Video, and composite video, as well as HDMI, RGBHD, and an output trigger for connection to automated screen and environment lighting systems.

- **De-interlacing (with NTSC 3:2 pull-down)**

Using BenQ's proprietary de-interlacing technology utilizing Farouda DCDi processing, this projector provides excellent scaling and film-to-video (NTSC 3:2 pull-down) conversion for the most artifact-free images possible.

- **PIP/POP function**

The Picture-In-Picture (PIP) and Picture-On-Picture (POP) functions allow you to display two inputs on the screen at the same time.

Projector exterior view

Front and upper side view

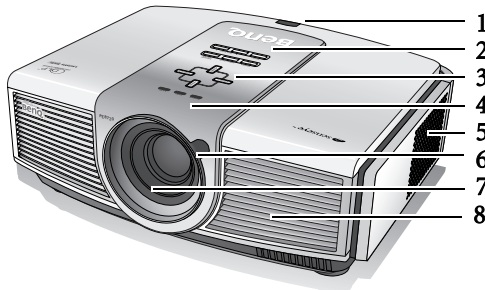

1. Rear IR sensor
2. Control panel (See page 12 for detailed information.)
3. Focus and Zoom adjustment
4. Indicator lights
5. Dust filter grill (cool air intake)
6. Front IR sensor
7. Projection lens
8. Vent (heated air exhaust)

Rear view

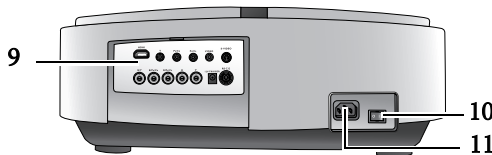

9. Connector panel (see below for detail)
10. Main AC power switch
11. Power cable socket

Under and side view

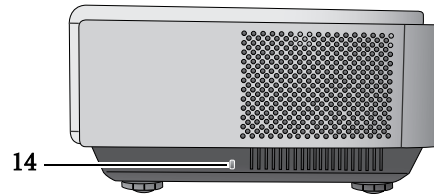
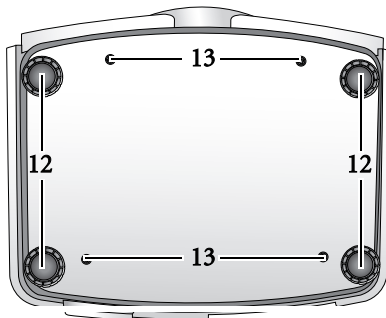

12. Adjustable feet
13. Ceiling mounting holes
14. Kensington lock slot

Connector panel

See page 18 for connection details.

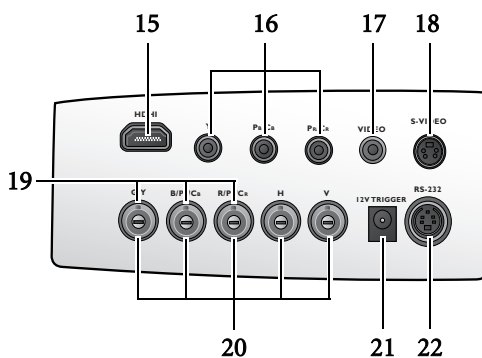

15. HDMI port
16. Component Video inputs (RCA) support Y/PB/PR or Y/Cb/CR video signal
17. Composite Video input (RCA)
18. S-Video input (mini 4-pin DIN)
19. Component video inputs (BNC) support Y/PB/PR, Y/Cb/CR, or RGB video signal
20. RGB High Definition inputs (BNC) supports RGBHV video or PC signal
21. 12VDC output terminal
Used by the service personnel of the accessories you purchased like electric screen or others.
22. RS-232C port for wired remote control

Controls and functions

Control panel

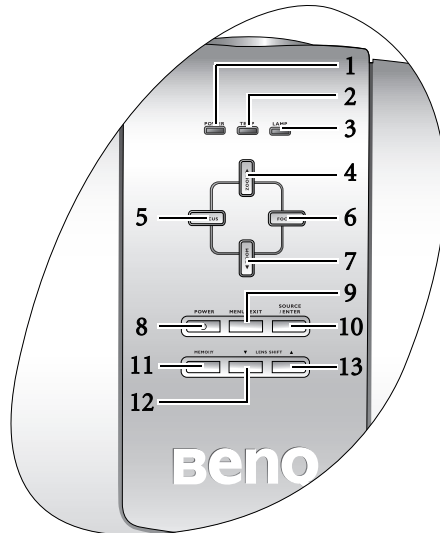

1. **POWER indicator light**
Lights up or flashes when the projector is operating.
[See page 34](#) for details.
2. **TEMPerature warning light**
Lights up or flashes if the projector's temperature becomes too high. [See page 34](#) for details.
3. **LAMP indicator light**
Lights up or flashes when the projector lamp has developed a problem. [See page 34](#) for details.
4. **ZOOM-In / Up-arrow (▲) button**
Performs the same action as the Zoom and right-arrow buttons on the remote control.
Enlarges the size of the projected image.
When the on-screen menu is activated, moves the selection upwards.
5. **FOCUS-In / Left-arrow (◀) button**
Performs the same action as the Focus and Left-arrow buttons on the remote control.
Adjusts the focus of the projected image.
Moves the focal point closer to the projector.
When the on-screen menu is activated, moves the selection to the left.
6. **FOCUS-Out / Right-arrow (▶) button**
Performs the same action as the Focus and Right-arrow buttons on the remote control.
Adjusts the focus of the projected image.
Moves the focal point farther from the projector.
When the on-screen menu is activated, moves the selection to the right.
7. **ZOOM Out / Down-arrow (▼) button**
Performs the same action as the Zoom and Left-arrow buttons on the remote control.
Reduces the size of the projected image.
When the on-screen menu is activated, moves the selection downwards.
8. **POWER button**
Performs the same action as the Power button on the remote control.
Toggles the projector between standby and on.
When the projector is in standby, press once to turn the projector on.
When the projector is on, press twice to turn the projector to standby.
[See pages 19, 23 and 34](#) for details.
9. **MENU / EXIT button**
Performs the same action as the Menu and Exit buttons on the remote control.
Turns on the On-Screen Display (OSD) menu.
When the on-screen menu is activated, exits and saves the menu settings.
10. **SOURCE / ENTER button**
Performs the same action as the source selection (COMP1, COMP2, VIDEO, HDMI, RGB HD, SVIDEO) and Enter buttons on the remote control.
Switches sequentially through input sources.
When the on-screen menu is activated, opens the currently selected menu item.
[See page 25](#) for details.
11. **MEMORY button**
Performs the same action as the memory buttons (1, 2, 3, default) on the remote control.
Sequentially recalls default and user settings 1–3 previously saved to memory.
[See page 23](#) for details.
12. **LENS SHIFT (-) down**
Performs the same action as the Lens and Down-arrow buttons on the remote control.
Adjusts the motorised vertical lens by moving the image downwards on the screen in relation to the orientation of the projector.
13. **LENS SHIFT (+) up**
Performs the same action as the Lens and Up-arrow buttons on the remote control.
Adjusts the motorised vertical lens shift by moving the image upwards on the screen in relation to the orientation of the projector.

Remote control

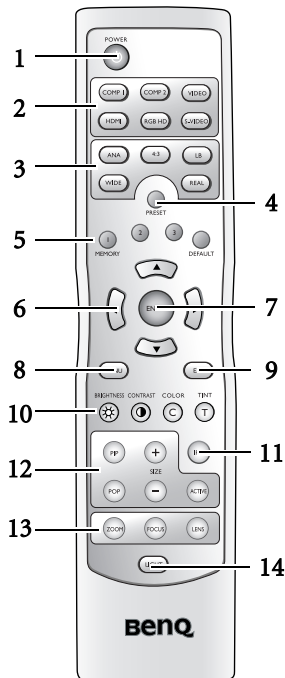

1. **POWER button**
Toggles the projector between standby mode and on.
When the projector is in standby, press once to turn the projector on.
When the projector is on, press twice to turn the projector to standby.
[See pages 19, 23 and 34](#) for details.
2. **Source selection buttons (COMP1, COMP2, VIDEO, HDMI, RGB HD, S-VIDEO)**
Selects an input source for display. [See page 27](#) for details.
3. **Aspect buttons (ANA, 4:3, LB, WIDE, REAL)**
Selects the display aspect ratio. [See page 27](#) for details.
4. **PRESET button**
Selects one of the preset program modes (Cinema, Home Theater, Family Room, Photo, Gaming). [See page 20](#) for details.
5. **MEMORY buttons (1, 2, 3 and DEFAULT)**
Restores picture settings saved in Memory locations 1, 2, 3 or Default for the current input source. [See page 26](#) for details.
6. **Arrow buttons (Left ◀, Up ▲, Right ▶, Down ▼)**
Moves the current On-Screen Display (OSD) menu selection in the direction of the arrow being pressed. [See page 25](#) for details.
7. **ENTER button**
Enacts the selected On-Screen Display (OSD) menu item. [See page 25](#).
8. **MENU button**
Toggles the On-Screen Display (OSD) menu on and off. [See page 25](#).
9. **EXIT button**
Exits and saves any changes made using the On-Screen Display (OSD) menu. [See page 25](#) for details.
10. **Picture quality adjustment buttons (BRIGHTNESS, COLOR, CONTRAST, TINT):**
Displays the setting bars for adjustment of the appropriate picture quality values. [See page 26](#) for details.
11. **IRIS button**
Displays the setting bar for the adjustment of the motorised aperture lens iris.
12. **Picture window control buttons (PIP, POP, +, -, ACTIVE)**
Displays the Picture In Picture (PIP) or Picture On Picture (POP) windows with the PIP and POP buttons respectively, toggles between the main window and sub-window, or left window and right window with the ACTIVE button, and adjusts the size of the currently active window with the + or - buttons. [See page 22](#).
13. **Picture enhancement buttons (ZOOM, FOCUS, LENS)**
Displays the setting bars for the adjustment of the motorised Zoom, Focus, and vertical Lens shift values respectively.
14. **LIGHT button**
Turns on the remote control backlight for about 10 seconds. Pressing any other button while the backlight is on keeps the backlight on for a further 10 seconds. Press the Light button again to turn the backlight off.

Remote control operation

- Make sure that there is nothing positioned between the remote control and the infrared (IR) sensor on the projector that might obstruct the IR beam from the remote control reaching the projector.
- The effective range of the remote control is up to 8 meters, and at an angle within 45 degrees of the IR beam.

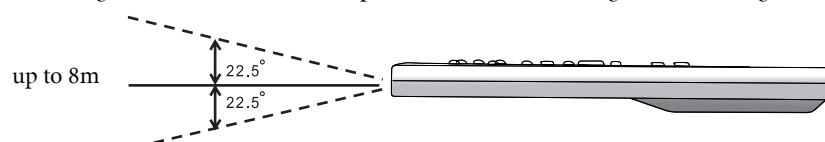

- Always aim straight at the projector, however most screens will also reflect the IR beam to the projector.

3 Positioning your projector

Choosing a location

Your projector is designed to be installed in one of four possible installation locations:

1. Floor in front of screen;
2. Ceiling in front of screen;
3. Floor at rear of screen; or
4. Ceiling at rear of screen.

Your room layout or personal preference will dictate which installation location you select. Take into consideration the size and position of your screen, the location of a suitable power outlet, as well as the location and distance between the projector and the rest of your equipment.

1. Floor front:

Select this location with the projector placed near the floor in front of the screen. This is the most common way to position the projector for quick setup and portability.

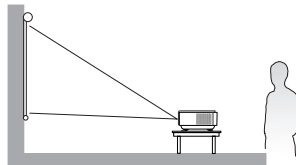

2. Ceiling front:

Select this location with the projector suspended from the ceiling in front of the screen.

Purchase the BenQ Projector Ceiling Mounting Kit from your dealer to mount your projector on the ceiling.

Set **Ceiling Front** in the **Setup > Mirror** menu after you turn the projector on.

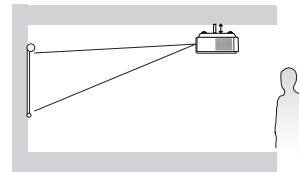

3. Floor rear:

Select this location with the projector placed near the floor behind the screen.

Note that a special rear projection screen is required.

Set **Floor Rear** in the **Setup > Mirror** menu after you turn the projector on.

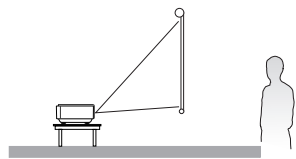

4. Ceiling rear:

Select this location with the projector suspended from the ceiling behind the screen.

Note that a special rear projection screen and the BenQ Projector Ceiling Mounting Kit are required for this installation location.

Set **Ceiling Rear** in the **Setup > Mirror** menu after you turn the projector on.

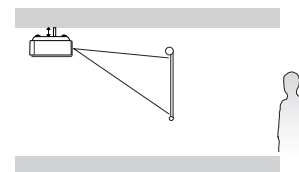

Obtaining a preferred projected image size

The distance from the projector lens to the screen, the zoom setting, and the video format each factors in the projected image size. BenQ has provided separate tables of dimensions for both 16:9 and 4:3 screen ratios to assist you in determining the ideal location for your projector.

1. Determine the aspect ratio of your screen, (16:9 or 4:3)?
2. Select the **Screen Size** you desire from the 16:9 ratio screen dimension table or 4:3 ratio screen dimension table below, according to which screen aspect you have. Install the projector at a distance from the screen corresponding to between the **Min.** and **Max. Projection Distance** values in the table.
3. Decide the exact height of your projector.

Installation for a 16:9 ratio screen

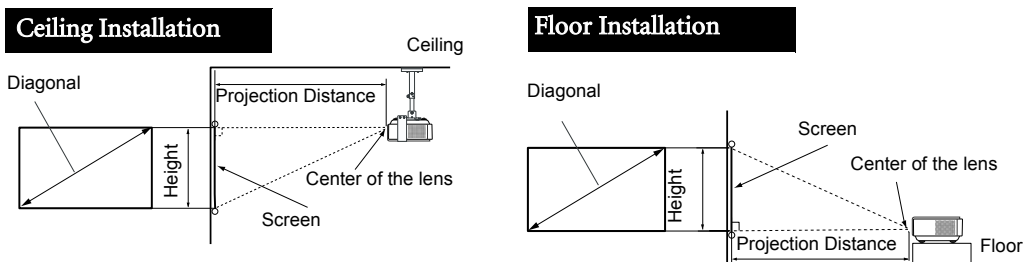

16:9 (widescreen) ratio screen dimension table

Screen Dimensions (inch / cm)			Projection Distance (inch / cm)	
Diagonal	Width	Height	Min distance (with max zoom)	Max distance (with min zoom)
50 / 127	44 / 111	25 / 62	78 / 199	106 / 270
60 / 152	52 / 133	29 / 75	94 / 239	128 / 324
70 / 178	61 / 155	34 / 87	110 / 279	149 / 379
80 / 203	70 / 177	39 / 100	126 / 319	171 / 433
90 / 229	78 / 199	44 / 112	141 / 359	192 / 487
100 / 254	87 / 221	49 / 125	156 / 400	213 / 541
110 / 279	96 / 244	54 / 137	172 / 438	234 / 595
120 / 305	105 / 266	59 / 149	188 / 478	256 / 649
130 / 325	113 / 288	64 / 162	204 / 518	277 / 703
140 / 356	122 / 310	69 / 174	220 / 558	298 / 757
150 / 381	131 / 332	74 / 187	235 / 598	319 / 811
160 / 406	139 / 354	78 / 199	251 / 638	341 / 865
170 / 432	148 / 376	83 / 212	267 / 677	362 / 919
180 / 457	157 / 398	88 / 224	282 / 717	383 / 973
190 / 483	166 / 421	93 / 237	298 / 757	405 / 1028
200 / 508	174 / 443	98 / 249	314 / 797	426 / 1082
250 / 635	218 / 553	123 / 311	392 / 996	532 / 1352
300 / 762	261 / 664	147 / 374	471 / 1195	639 / 1622

The above numbers are approximate and may be slightly different from the actual measurements. Only the recommended screen sizes are listed. If the your screen size is not in the table above, please contact your BenQ dealer for assistance.

An examination of the table reveals that you can place the projector lens in the range from 2 to 16.22m distance from the screen, which will give you a projected image from 50" (1.11 x 0.62m) to 300" (6.64 x 3.74m) full screen.

Installation for a 4:3 ratio screen

The illustrations and table below are provided for those users who already have 4:3 aspect ratio screens or intend to purchase 4:3 aspect ratio screens to view 16:9 ratio projected images.

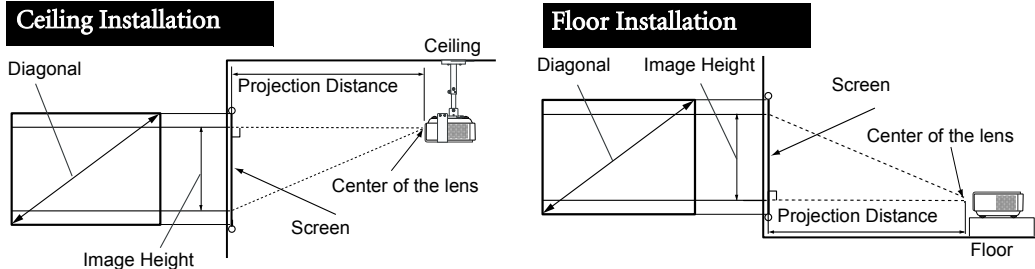

4:3 (standard) ratio screen dimension table:

Screen Dimensions (inch / cm)			Projection Distance (inch / cm)	
Diagonal	Width	Height	Min distance (with max zoom)	Max distance (with min zoom)
50 / 127	40 / 102	30 / 76	72 / 184	98 / 249
60 / 152	48 / 122	36 / 91	87 / 221	117 / 298
70 / 178	56 / 142	42 / 107	102 / 258	137 / 348
80 / 203	64 / 163	48 / 122	116 / 294	157 / 398
90 / 229	72 / 183	54 / 137	130 / 331	176 / 448
100 / 254	80 / 203	60 / 152	145 / 368	196 / 497
110 / 279	88 / 224	66 / 168	159 / 405	215 / 547
120 / 305	96 / 244	72 / 183	174 / 442	235 / 597
130 / 325	104 / 264	78 / 198	188 / 478	254 / 646
140 / 356	112 / 284	84 / 213	203 / 515	274 / 696
150 / 381	120 / 305	90 / 229	217 / 552	294 / 746
160 / 406	128 / 325	96 / 244	232 / 589	313 / 796
170 / 432	136 / 345	102 / 259	247 / 626	333 / 845
180 / 457	144 / 366	108 / 274	261 / 662	352 / 895
190 / 483	152 / 386	114 / 290	275 / 699	372 / 945
200 / 508	160 / 406	120 / 305	290 / 736	392 / 995
250 / 635	200 / 508	150 / 381	362 / 920	489 / 1243
300 / 762	239 / 610	180 / 457	435 / 1104	587 / 1492

The above numbers are approximate and may be slightly different from the actual measurements. Only the recommended screen sizes are listed. If the your screen size is not in the table above, please contact your BenQ dealer for assistance.

An examination of the table reveals that you can place the projector lens in the range from 1.84 to 14.92m distance from the screen, which will give you a projected image from 50" (1.02 x 0.76m) to 300" (6.1 x 4.57m).

Shifting the projection lens vertically

The vertical lens shift control provides flexibility for installing your projector. It allows the projector to be positioned slightly above or below the top level of the projected images.

The lens shift (offset) is expressed as a percentage of the projected image height. It is measured as an offset from the projected image's vertical center.

The projector is equipped with $\pm 100\%$ vertical lens shift. You can shift the projection lens upwards or downwards within the allowable range depending on your desired image position.

When the **LENS** button on the remote control or **LENS SHIFT** buttons (\blacktriangle or \blacktriangledown) on the projector is pressed, an adjustment bar displays on the screen.

To raise the projected image, press the **Lens Shift** \blacktriangle button on the projector or the \blacktriangle button on the remote control.

To lower the projected image, press the **Lens Shift** \blacktriangledown button on the projector or the \blacktriangledown button on the remote control.

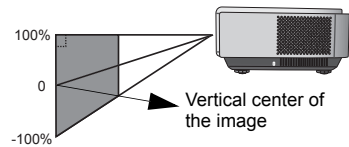

4 Connecting with video equipment

You can connect the projector to any type of video equipment, such as a VCR, DVD player, digital tuner, cable or satellite decoder, video game console or digital camera. You can also connect it to a desktop or laptop PC or Apple Macintosh system. However, it has no built-in speakers and cannot be connected to audio equipment.

The projector can be connected to multiple video equipment at the same time by using different cables. All you need to do is select the appropriate input for the projector to display.

When connecting a signal source to the projector, be sure to:

1. Turn off all equipment before making any connections.
2. Use only the correct type cables for each source with proper type plugs.
3. Ensure that all cable plugs are firmly fitted to the equipment sockets.

Note that all cables shown in the following connection diagrams may not be supplied with the projector (See page 9 for the shipping contents). Most cables are commercially available from electronics stores.

Connecting a computer

Connect the projector to a computer with a VGA-BNC cable.

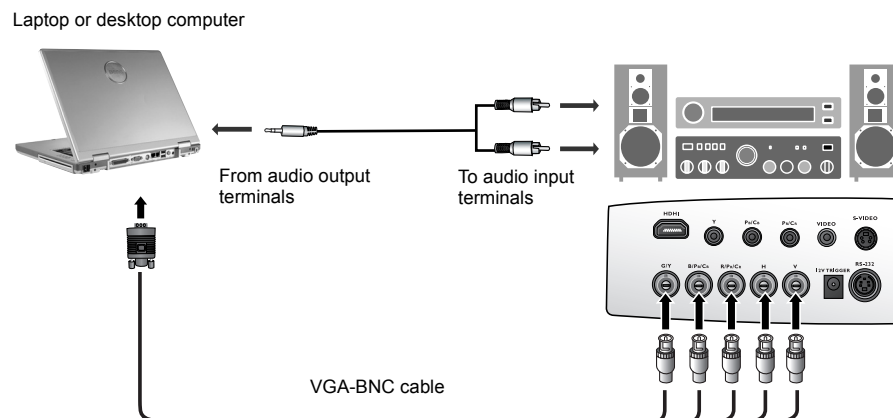

If the selected video image is not displayed after the projector is turned on and the correct video source has been selected, please check that the video source device is turned on and operating correctly. Also check that the signal cables have been connected correctly.

Many laptops do not turn on their external video ports when connected to a projector. Usually a key combination like Fn + F3 or CRT/LCD key turns the external display on/off. Locate a function key labeled CRT/LCD or a function key with a monitor symbol on the laptop. Press Fn and the labeled function key simultaneously. Refer to your laptop's documentation to discover your laptop's key combination.

Connecting video inputs

Connecting HDMI devices

You should use an HDMI cable when making connection between the projector and HDMI devices. HDMI (High-Definition Multimedia Interface) supports uncompressed video data transmission between compatible devices like DTV tuners, DVD players and displays over a single cable. It provides pure digital viewing and listening experience.

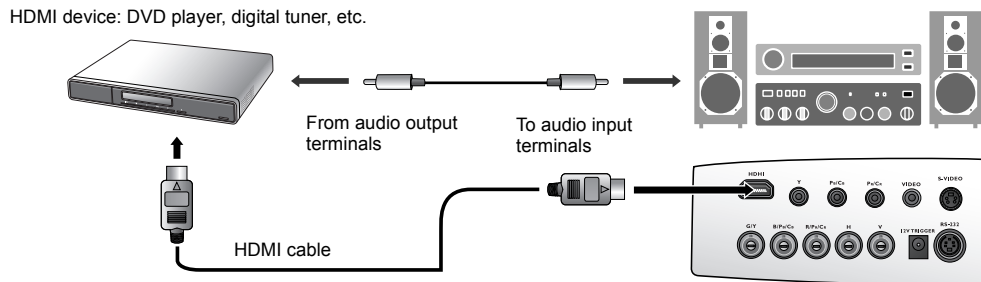

You should also connect the separate audio cable to a suitable audio amplifier.

Connecting component-video devices

Be sure to match the corresponding colors between the cables and the terminals.

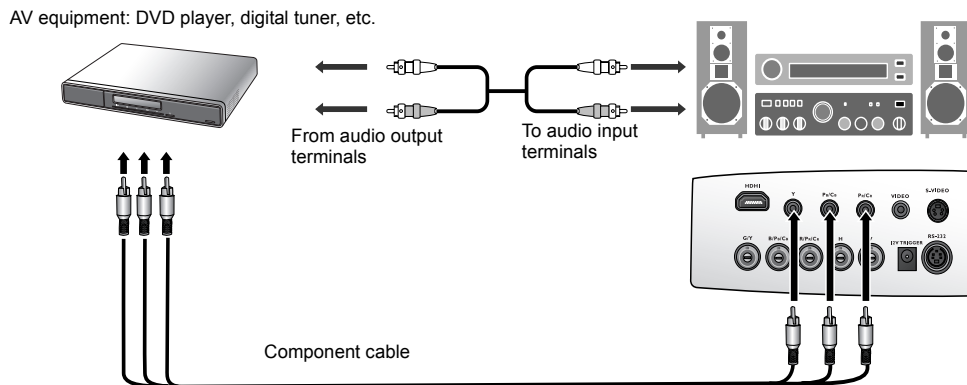

The RCA type component video sockets are provided for connection to video output devices. If you have a BNC type component video cable, you can alternatively connect through the BNC component video sockets.

You should also connect the separate audio cable to a suitable audio amplifier.

Connecting S-video or video devices

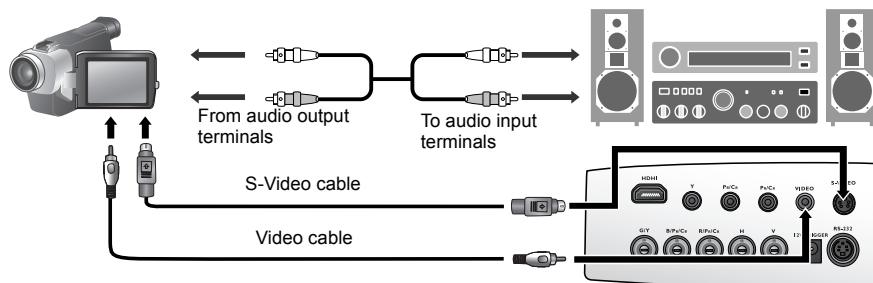

You need only connect one or other of S-Video or composite Video cables from the same device, never both at the same time. You should also connect the separate audio cable to a suitable audio amplifier.

5 Using the projector

Preparations

1. Plug in and turn all of the connected equipment on.
2. If not already in, plug the supplied power cable into the AC inlet on the rear of the projector and turn on the power switch.
3. Plug the power cable into a wall socket and turn the wall switch on.

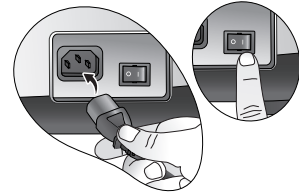

Turning the projector on

Follow the steps below.

1. Make sure the Power light is orange after power has been applied and the main AC power switch is turned on.
2. Press and hold the **POWER** button on the projector or remote control to turn the projector on.

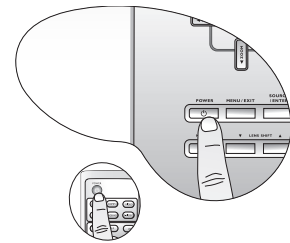

The projector will not respond to further commands whilst it is warming up.

3. The fans will be start operating, and a start-up image displays on the screen for a few seconds whilst it warms up.
4. "Searching...." will be displayed on the screen before the projector identifies the input signal. This message will remain on the screen until a valid signal is detected.
5. If the horizontal frequency of the input signal exceeds the range of the projector, the message "Unsupported timing" will be displayed on the screen. This message will remain on-screen until you change the input signal to an appropriate source.

Selecting an input video source

The projector can be connected to multiple equipment at the same time. To select an individual input signal, press one of the Source buttons on the remote control, or to sequentially cycle through all possible sources, press the **SOURCE/ENTER** button on the projector.

- When the projector is first turned on, it will attempt to reconnect with the input source which was in use when the projector was last shut down.
- If you want to use the PIP or POP function. [See page 22](#) for details.

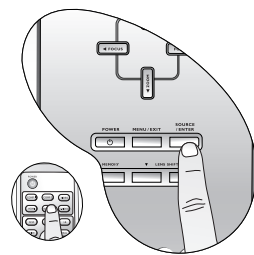

Adjusting the projected image

Adjusting the projection angle

There are four adjuster feet on the bottom of the projector. These can be used if necessary to change the projection angle. Screw the feet in or out as appropriate to aim and level the projection angle.

If the screen and the projector are not perpendicular to each other, the projected image becomes vertical trapezoidal. To correct this problem, you can adjust the value of Keystone in the Setup menu.

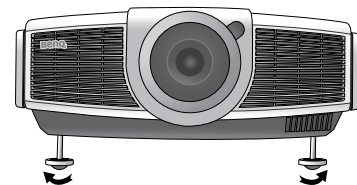

Fine-tuning the image size and clarity

1. Adjust the projected image to the size that you need using the zoom buttons. When the **ZOOM** button is pressed, an adjustment bar "**◀ Zoom ▶**" displays on the screen.

To enlarge the image size, press the **▲** button on the projector or the **▶** button on the remote control.

To reduce the image size, press the **▼** button on the projector or the **◀** button on the remote control.

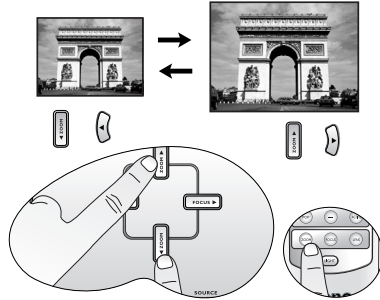

2. Then sharpen the image by using the focus buttons. When the **FOCUS** button is pressed, an adjustment bar "**◀ Focus ▶**" displays on the screen. To further adjust the image clarity, press the **◀** or **▶** button on the projector or remote control.

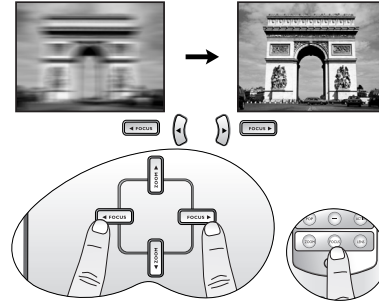

Optimizing the image

To optimize the image, use the remote control or on-screen menus. For the operation of on-screen menus, please refer to page 25.

The following steps are optional. You do not need to follow every step. It depends on the image quality you desire.

1. Selecting a preset mode

Select a preset mode on the remote control, or in **Picture > Preset Mode** menu. There are 5 modes available for each input. These modes consist of preset values suitable for various projection situations as described below:

- Preset Cinema Mode: with well-balanced color saturation and contrast with a low brightness level. This is most suitable for enjoying movies in a totally dark environment (as you would find in a commercial cinema).
- Preset Home Theater Mode: is slightly brighter than Cinema Mode, and suitable for use in rooms where there is a small amount of ambient light.
- Preset Family Room Mode: Brightness is emphasized in this mode and is best suited for use in rooms with normal lighting levels. It is good for watching TV programs, playing games or seeing bright movies.
- Preset Photo Mode: designed for viewing digital pictures in a living room.
- Preset Gaming Mode: is suitable for playing video games in a bright living room.

2. Selecting the aspect ratio

The "aspect ratio" is the ratio of the image width to the image height. Digital TV is usually in 16:9 ratio, which is the default for this projector, and most analog TV signals and DVDs are in 4:3 ratio.

With the advent of digital signal processing, digital display devices like this projector can dynamically stretch and scale the image output to a different aspect than that of the image input source. Images can be stretched in a linear manner so the whole of the image is stretched equally, or non-linearly, which distorts the image.

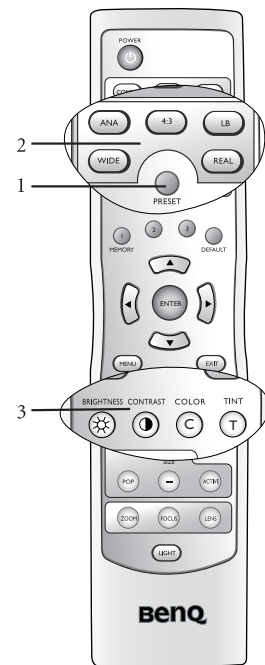

You can change the projected image ratio (no matter what aspect the source is) by using the Aspect buttons on the remote control or in the **Display > Aspect Ratio** OSD menu. Select an aspect ratio to suit the format of the video signal and your display requirements. There are five aspect ratios available:

 In the pictures below, the black portions are inactive areas and the white portions are active areas.

1. **Anamorphic:** Scales an image so that it is displayed in the center of the screen with a 16:9 aspect ratio.

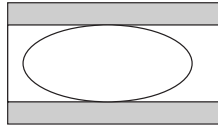

2. **4:3:** Scales an image so that it is displayed in the center of the screen with a 4:3 aspect ratio.

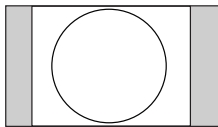

3. **Letterbox:** Enlarges an image with letterbox format to display it in full-screen format with a 16:9 aspect ratio. The upper and lower portions of the image are cropped.

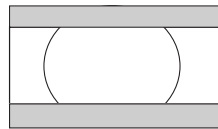

4. **Wide:** A 4:3 aspect ratio image is enlarged NON-linearly in horizontal direction to accommodate 16:9 full-screen display. This stretches only the right and left sides of the image; the central part is unchanged.

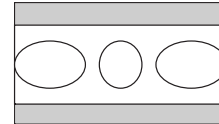

5. **Real:** One-to-one mapping is performed on the input signal without any scaling with the image displayed at the center of the screen.

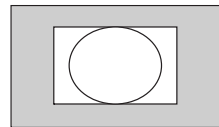

The **Anamorphic** setting stretches and resizes linearly, except that it treats the vertical and horizontal dimensions independently. It stretches the height of the source image until it reaches the full projected height, and stretches the width of the source image until it reaches the full projected width. This may alter the projected aspect, depending upon the original aspect of the source image. Anamorphic is most suitable for images which are already in a 16:9 aspect, like high definition TV, as it displays them without aspect alteration.

The **4:3** setting is most suitable for 4:3 images like standard definition TV and 4:3 aspect DVD movies, as it displays them without aspect alteration.

The **Letterbox** setting resizes an image proportionately both vertically and horizontally from the width of a 4:3 aspect to the width of a 16:9 aspect and centers it onscreen. This produces an image greater in height than can be displayed, so part of the image is lost (not displayed) along the top and bottom edges of the projection. This is suitable for the display of movies which are presented in letterbox format (with black bars top and bottom).

The **Wide** setting stretches the image horizontally in a non-linear manner, that is, the edges of the image are stretched more than the centre of the image, to prevent distortion of the central part of the image. This is suitable for occasions where you want to stretch the width of a 4:3 aspect image to the width of a 16:9 aspect screen. It does not alter the height. Some widescreen movies have been produced with their width squashed down to the width of a 4:3 aspect, and are best viewed when restretched back to their original width using the Wide setting.

The **Real** setting displays the image in a one-to-one pixel mapping without alteration or resize in the centre of the projection. This is most suitable for use with PC and RGBHD source inputs.

3. Adjusting contrast ratio

The contrast ratio is the measurement of the difference between the brightest whites and the darkest blacks a display can show. This projector has a very high contrast ratio which can reveal subtle color detail not possible with projectors which have a lower contrast ratio. You can adjust the contrast level to allow for ambient lighting levels within the room which may affect color detail. To manually adjust the contrast ratio, press the **IRIS** button on the remote control. When the button is pressed, an adjustment bar

"  " displays on the screen. To lower the contrast and increase brightness, press the ◀ button on the remote control or in the **Advanced --> Advanced - 30 step IRIS** menu. To raise the contrast and decrease brightness, press the ▶ button on the remote control or in the **Advanced --> Advanced - 30 step IRIS** menu.

4. Other adjustments

You can adjust Brightness, Contrast, Color, and Tint settings using the **Picture** menu or with the remote control.

 **Some picture adjustments are available only when certain input sources are in use. Unavailable adjustments are not shown on the screen.**

Displaying more than one image source simultaneously

There are two groups of inputs classified according to their display modes:

Video Group: Video, and S-Video inputs.

Graphic Group: Component 1 and 2, RGBHD, and HDMI inputs.

The PIP function allows the projector to display one input from the Graphic Group within one input from the Video Group (**G in V**), or display one input from Video Group within one input from the Graphic Group (**V in G**).

The POP function allows the projector to display one input from the Graphic Group and one input from the Video Group side by side (**G <=> V** or **V <=> G**).

If you want to view two images from 2 different input signals at the same time, refer to the following steps to display the second image.

1. Select one input source by pressing one of the Source buttons on the remote control.
2. Press **PIP** or **POP** button on the remote control.
3. Select the second signal input on the remote control.
4. You may press PIP or POP button repeatedly to choose the corresponding positions (G in V or V in G, G <=> V or V <=> G) of the images.
5. Toggle the **ACTIVE** button on the remote control to switch the active window between the two windows. In the active window, you are allowed to change the input signal settings.
6. To adjust the size of the PIP window, press + or -.
7. To adjust the position of the PIP window, press the ARROW buttons (▲/◀/▼/▶).
8. To turn off the PIP or POP function, select **PIP Off** or **POP Off**.

PIP ---

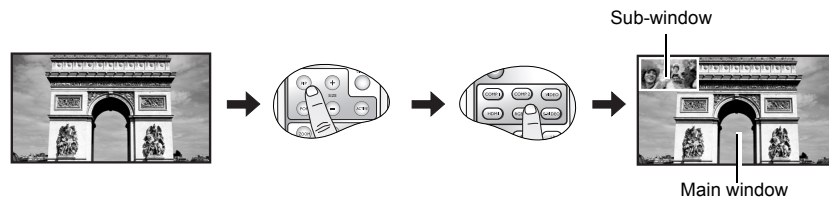

POP ---

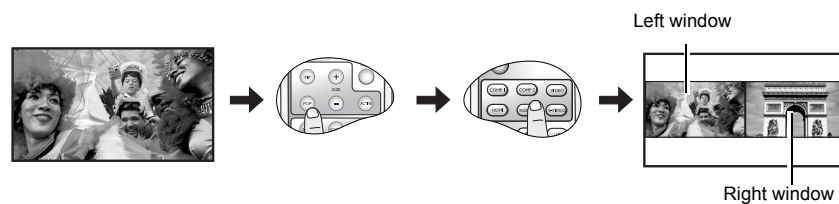

Personalizing the projector menu display

The On Screen Display (OSD) menus can be set according to your preferences. These settings do not affect the projection settings, operation, or performance.

- **Language** in **Setup** menu sets your familiar language for the on-screen menus.
- You can select the projector's **Background Color** from purple, black or white in **Options** menu.
- **OSD Off (Secs)** in **Options** Menu sets the length of time the OSD will remain active after the last button press.
- **Sleep Timer (Min)** in **Options** menu sets the length of time the projector will auto shutdown.
- **OSD Position H** and **OSD Position V** in **Options** menu adjust the OSD position on the screen.

Saving and loading the video memory

- Press the video memory buttons on the remote control or **MEMORY ▲** on the projector to recall the settings directly.
- There are four video settings: MEMORY 1, MEMORY 2, MEMORY 3, and DEFAULT. The DEFAULT button can be used to restore the default settings for the current input source.
- See page 29 for information about saving user memories.

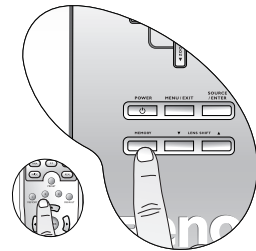

Turning the power off

To turn the projector off, press the **POWER** button on the projector or remote control and a warning message appears. Press **POWER** again.

- The Power indicator light flashes green and the fans run for about two minutes to cool the lamp. The projector will not respond to any commands until the cooling process is complete.
- Then, the Power indicator light is a steady orange once the cooling process has finished and fans stop.
- If the projector will not be used for an extended period, turn the main power switch off and unplug the power cable from the power outlet.

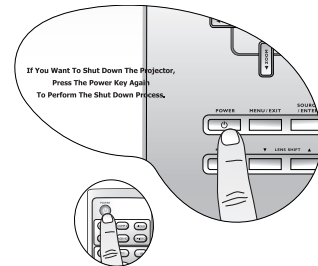

6 Menus

On Screen Display (OSD) structure

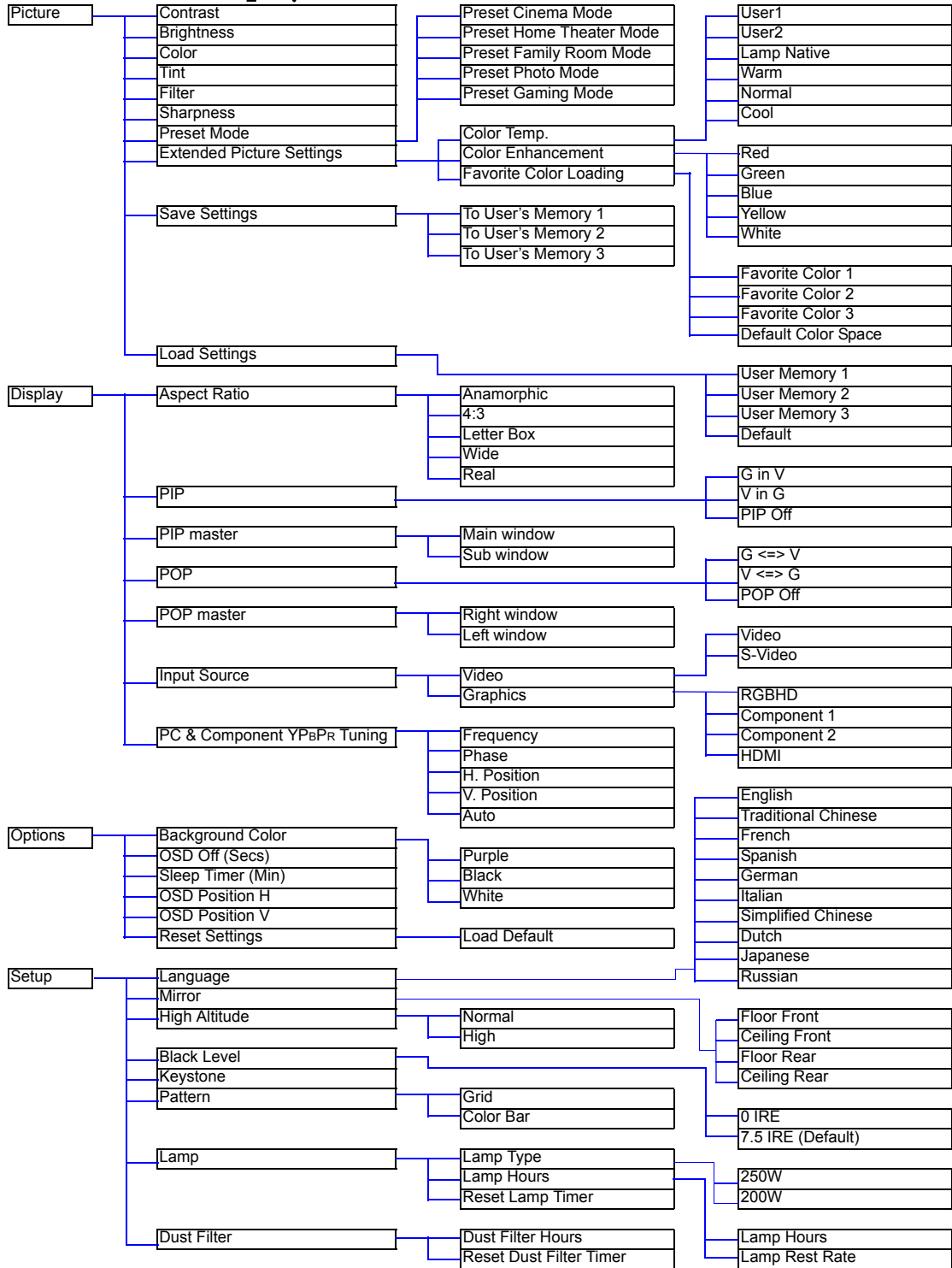

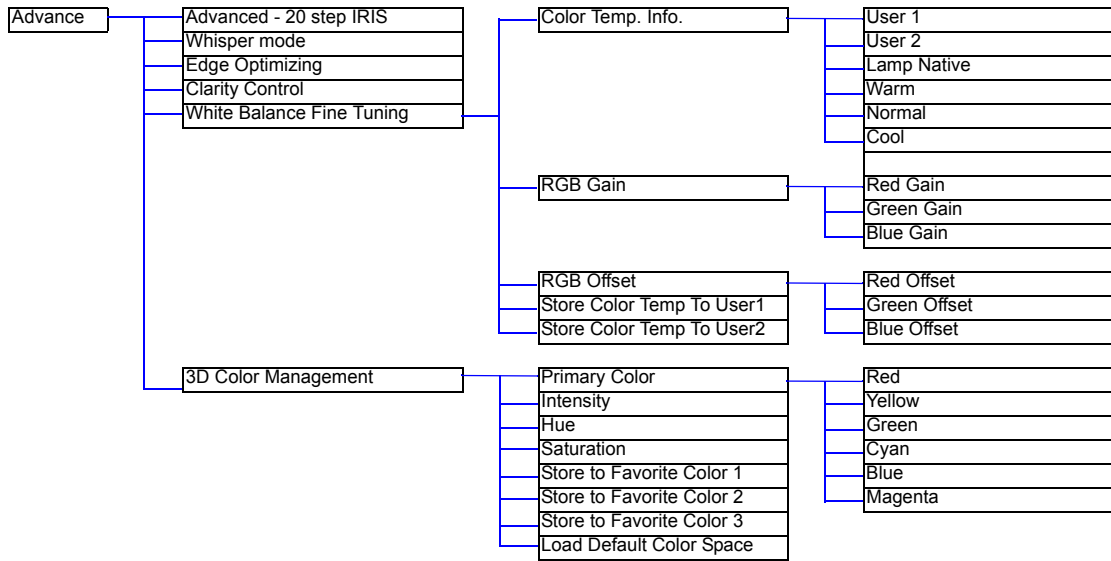

Using the menus

The projector is equipped with on-screen display (OSD) menus for making various adjustments and settings.

There are eight different menu languages. See page 24 for more details.

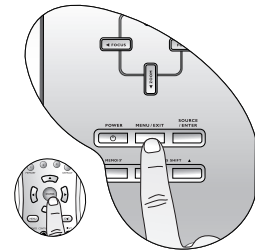

The following example describes the adjustment of the keystone.

1. Press the **MENU/EXIT** button to display the OSD menu.
4. Adjust keystone values by pressing ◀ or ▶.

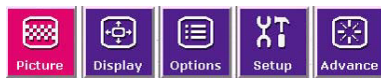

2. Use ◀ or ▶ to select **Setup** and press **SOURCE/ENTER**.

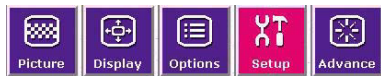

3. Use ▲ or ▼ to select **Keystone**.





5. Press the **MENU/EXIT** button twice* to leave and save the settings.

*The first press leads you back to the submenu and the second press closes the on-screen menu.

Picture menu

The Picture menu allows you to adjust the finer details of the projected image quality.

Before making adjustments, you are suggested to choose a desired preset mode in this menu which has set some certain values in order to meet different lighting environment and presentation purposes.

1. **Contrast:** Adjusts the degree of difference between dark and light in the image. The higher the value, the greater the contrast.
 
2. **Brightness:** Adjusts the brightness of the image. The higher the value, the brighter the image. And lower the value, the darker the image. Adjust this control so the black areas of the image appear as black and that detail in the dark areas is visible.
 
3. **Color:** Increase or decrease the color intensity of the image. The higher the value, the more vivid and brighter the color.
4. **Tint:** Adjusts the color tones of the image. The higher the value, the more greenish the picture becomes. The lower the value, the more purplish the picture becomes.
5. **Filter:** Turn the video and data filters on or off. Filters can reduce noise in the picture to produce a sharper image. The higher the setting, the less the noise.
6. **Sharpness:** Adjusts the picture sharpness. The higher the value, the sharper the picture.
7. **Preset Mode:** Preset modes are provided so you can optimize your projector image set-up to suit your program type. [See page 20](#) for more information.
8. **Extended Picture Settings**
 - **Color Temp.:** You can choose a preferred color temperature from among User 1, User 2, Lamp Native, Warm, Normal, and Cool. [See page 29](#) for details about storing the Color Temperature User 1 and 2.
 - **Color Enhancement**
 - Red:** Adjusts red hues independently.
The higher the setting, the greater the intensity of red color in the image.
 - Green:** Adjusts green hues independently.
The higher the setting, the greater the intensity of green color in the image.
 - Blue:** Adjusts blue hues independently.
The higher the setting, the greater the intensity of blue color in the image.
 - Yellow:** Adjusts yellow hues independently.
The higher the setting, the greater the intensity of yellow color in the image.
 - White:** Adjusts white peaking.
 - **Favorite Color Loading:** Loads your favorite color from Favorite Color 1, 2, 3 or Default Color Space. The settings for Favorite Color 1, 2, or 3 are made in the **Advance > 3D Color Management** menu. [See page 29](#) for details about operation on setting the picture color quality.
9. **Save Settings:** There are three video memories in which users can store settings, including all of the items in the **Picture** menu. Each input source can store up to 3 sets of user memories.
 - To store the settings:
 - i.) Adjusts the items in the **Picture** menu to desired values.
 - ii.) Select **Save Settings**, press **ENTER**.
 - iii.) Select **To User's Memory 1**, **To User's Memory 2**, or **To User's Memory 3**, and press **ENTER** to store the settings.
 - iv.) To leave the OSD, press **EXIT**.
10. **Load Settings:** Loads the settings from one of three User Memories or the default setting.

Display menu

Use this menu to set the way that the projector displays the picture.

1. **Aspect Ratio:** There are a few aspect ratios that can be selected for different video signals. See page 20 for details.
 2. **PIP**
 - G in V: Displays one input from the Graphic Group within one input from the Video Group.
 - V in G: Displays one input from the Video Group within one input from the Graphic Group
 - PIP off: Turns the PIP function off.
 3. **PIP Master:** Sets the main window or sub-window as the active window in order to make any adjustments for it.
 4. **POP**
 - G <=> V: Displays the input from Graphic Group at the left side and Video Group at the right side of the screen.
 - V <=> G: Displays the input from Video Group at the left side and Graphic Group at the right side of the screen.
 - POP Off: Turns the POP function off.
 5. **POP Master:** Sets the right window or left window as the active window in order to make any adjustments for it.
 6. **Input Source:** Selects the input signal that will be displayed as the PIP or POP image.
 - Video**
 - Video: Composite video signal.
 - S-Video: S-Video video signal.
 - Graphics**
 - RGBHD: DTV RGBHD signal input
 - Component 1 and 2: Component Y/CB/CR and Y/Pb/PR input
 - HDMI
-  **In the unlikely event that the image shakes when PIP or POP function is activated, we suggest you to change the input signals. The shaking image may be caused by the combination of Y/CB/CR and Video, or Y/CB/CR and S-Video.**
7. **PC & Component YPBPR Tuning:** The following settings are only available with a PC or DTV RGB signal selected.
 - Frequency: Adjusts the frequency of the sampling clock that captures the input signal.
 - Phase: Adjusts the phase of the clock.
 - H. Position: Adjusts the horizontal position of the image.
 - V. Position: Adjusts the vertical position of the image.
 - Auto: Adjusts the phase, and frequency automatically.

Options menu

In this menu, global settings for the projector can be made.

1. **Background Color:** Allows you to choose the color of the background screen that will be displayed when there is no input signal detected.
2. **OSD Off (Secs):** Sets the length of time the OSD will remain active after your last button press. The range is from 5 to 60 seconds.
3. **Sleep Timer (Min):** Sets the auto-shutdown timer. The timer can be set to a value between 10 minutes and 3 hours.

4. **OSD Position H:** Adjusts the horizontal position of the OSD.
5. **OSD Position V:** Adjusts the vertical position of the OSD.
6. **Reset Settings:** Returns all image settings of the current source to the factory preset values.

Setup menu

This menu contains items necessary for basic image setup.

1. **Language:** Sets the language for the OSD menus.
2. **Mirror:** The projector can be installed on a ceiling or behind a screen, or with one or more mirrors. There are four settings for choice. Contact your dealer for the ceiling mount bracket if you need to install the projector on a ceiling. [See page 14](#) for more information.
3. **High Altitude:** This item is designed for those who use the projector in extreme environments, like high temperature or high altitude. We recommend you select **Yes** when your environment is higher than 3000 feet, or is hotter than 40°C.

Operation with **Yes** selected may caused a higher decibel operating noise level because of increased fan speed necessary to improve over-all cooling system and performance.

If you use the projector under other extreme environments excluding the above, it may display auto shut-down symptoms, which is designed to protect your projector from over-heating. In cases like this, you should switch to Yes to solve these symptoms. However, this is not to state that this projector can operate under any and all harsh and extreme environments.
4. **Black Level:** The grayscale video signal is measured in IRE units. In some areas which use NTSC TV standard, the grayscale is measured from 7.5 IRE (black) to 100 IRE (white); however, in other areas which use PAL equipment or Japanese NTSC standard, the grayscale is measured from 0 IRE (black) to 100 IRE (white). We suggest that you check the input source if it is with 0 IRE or 7.5 IRE, then select accordingly.
5. **Keystone:** Corrects for trapezoidal distortion resulting from the angle of projection. It can provide correction of up to ± 12 degrees.
6. **Pattern:** It will be displayed with the aspect ratio setting made using the **Aspect Ratio** function of the **DISPLAY** menu. Use this pattern when installing the projector, even if there is no input signal. Use it to adjust the image size and the focus.
7. **Lamp**
 - Lamp Type: Sets **250W** or **200W** as the power type of your projection.
 - Lamp Hours:
 - i. Lamp Hours: Shows the total time of the lamp has been used.
 - ii. Lamp Rest Rate: Shows the percentage of the rest lamp life.
 - Reset Lamp Timer: Resets the lamp timer. This should only be done after the lamp has been replaced.
8. **Dust Filter**
 - Dust Filter Hours: Shows the total time of the filter has been used.
 - Reset Dust Filter Timer: Reset the dust filter timer. This should only be done after the filter has been replaced.

Advance menu

1. **Advanced - 20 step IRIS:** Adjusts the contrast ratio toward Low or High. [See page 21](#) for more information.
2. **Whisper mode:** This projector features a whisper mode which achieves an astonishing low 23dB of emitted noise during operation—the same level of noise as someone whispering in your ear. Even normal operating noise of 25dB is little more than a whisper. To switch the whisper mode on or off, press the ◀ or ▶ button on the remote control or projector repeatedly.
3. **Edge Optimizing:** Sharpens the edges on an image. It helps highlight the details on an image or restore details that have been blurred. To enhance the picture edges, press the ◀ or ▶ button on the remote control or projector. The higher the setting, the greater the edge performance.

4. **Clarity Control:** Adjusts the picture clarity. The higher the setting, the greater the clarity.
5. **White Balance Fine Tuning:** Adjusts the white color.
 - Color Temp. Info.: shows the current color temperature.

 **About color temperatures:**

There are many different shades that are considered to be “white” for various purposes. One of the common methods of representing white color is known as the “color temperature”. A white color with a low color temperature appears to be reddish white. A white color with a high color temperature appears to have more blue in it.

- RGB Gain: Adjusts the contrast levels of Red, Green, and Blue.
- RGB Offset: Adjusts the brightness levels of Red, Green, and Blue.

To store Color Temperature to User 1 and 2:

- i.) Open the **Advanced** menu and select **White Balance Fine Tuning > RGB Gain**, press **ENTER**.
- ii.) Press **▲** or **▼** to select the item to be changed and adjust the value with the **◀** or **▶** button.
- iii.) Press **EXIT** to leave and save the settings.
- iv.) Repeat steps ii and iii to set RGB Offset values.
- v.) Select and enter “Store Color Temperature to User 1” or “Store Color Temperature to User 2” to save the settings which are made above.
- vi.) Press **EXIT** to leave and save the settings.

 **To make the color temperature higher**

Set the value of Blue Gain greater, and the value of Red Gain smaller.

 **To make the color temperature lower**

Set the value of Red Gain greater, and the value of Blue Gain smaller.

6. **3D Color Management:** The 3D Color Management provides six sets (RGBCMY) of colors to be adjusted to favorite colors. When you select each color, you can independently adjust its hue, intensity, and saturation according to your preference. Store those settings to Favorite Color 1, 2, or 3.

To adjust and store the settings:

- i.) Open the **Advanced** menu and select **3D Color Management > Primary Color**.
- ii.) Choose a color among Red, Yellow, Green, Cyan, Blue, or Magenta with the **◀** or **▶** button.
- iii.) Press **▼** to go to the Intensity, Hue, and Saturation menus and respectively adjust their values to your preference with the **◀** or **▶** button. Every adjustment made will reflect to the image immediately.
- iv.) Repeat steps ii and iii for other color adjustments.
- v.) Make sure you have made all of the desired adjustments. If you are not satisfied with the result, you may select the **Load Default Color Space** menu, enter it for returning to the factory preset values.
- vi.) If you are satisfied with the result shown on the screen, select and enter “Store to Favorite Color 1”, “Store to Favorite Color 2” or “Store to Favorite Color 3” to save the settings which were made above.
- vii.) **EXIT** the OSD menu.

Unlike the Picture menu that can store up to 3 sets of User Memory for each input, the 3D Color Management contains only 3 user-definable Favorite Color settings and one Default Color Space setting system wide, not associated with any particular input. You can select one of the four Favorite Colors when storing to User's Memory 1, 2, or 3.

If you are using multiple inputs, you can store and recall a separate 3D Color scheme as a Favorite Color in each of the three User Memory settings. You should store Favorite Color 1 to User Memory 1, Favorite Color 2 to User Memory 2, and Favorite Color 3 to User Memory 3. Whenever you change input, you need only select the appropriate User Memory you've calibrated and saved for that input. To recall Favorite Color 1 settings, you select User Memory 1, etc., etc.

If you are using a single input, you can store and recall a separate 3D Color scheme as a Favorite Color in each of the three User Memory settings for up to three separate viewing scenarios. Whenever you change scenario, you need only select the appropriate User Memory you've saved the 3D Color scheme to for that scenario.

7 Additional information

Care of the projector

Your projector needs little maintenance. The only thing you have to do on a regular basis is keep the lens clean and clean or replace the air filter. Never remove any parts of the projector except the lamp or the air filter. Contact your dealer or local BenQ Customer Service Centre if the projector fails to operate as expected.

Cleaning the lens

Clean the lens whenever you notice dirt or dust on the surface. Before you attempt to clean the lens, turn the projector off, unplug the power cable, and leave it several minutes to cool completely.

1. Use a canister of compressed air to remove dust. (Available from building hardware or photographic suppliers.)
2. If there is stubborn dirt or smudge marks, use a proper photographic lens brush or moisten a clean soft lens cloth with lens cleaner to gently wipe the lens surface.

 **Never touch the lens with your finger or rub the lens with abrasive materials. Even paper towels can damage the lens coating. Only ever use a proper photographic lens brush, cloth, and cleaning solution. Do not attempt to clean the lens whilst the projector is switched on or is still hot from previous use.**

Cleaning the projector case

Before you attempt to clean the case, turn the projector off, unplug the power cable, and leave it several minutes to cool completely.

1. To remove dirt or dust, wipe the case with a soft, dry, lint-free cloth.
2. To remove stubborn dirt or stains, moisten a soft cloth with water and a neutral detergent. Then wipe the case.

 **Never use wax, alcohol, benzene, thinner or other chemical detergents. These can damage the case.**

Storing the projector

If you need to store the projector for an extended time, please:

1. Make sure the temperature and humidity of the storage area are within the recommended range for the projector. Please refer to the Spec. page in this manual or consult your dealer about the range.
2. Retract the adjuster feet.
3. Remove the batteries from the remote control.
4. Pack the projector in its original packing or equivalent.

Transporting the projector

It is recommended that you ship the projector with its original packing or equivalent. When you carry the projector yourself, please use a soft carry case.

Cleaning and replacing the dust filter

It is necessary to clean the dust filter periodically every 1000 hours use. You can use the menu **Setup> Dust Filter Hours** to check how long the filter has been used. If the filter is not cleaned, it can become clogged with dust and prevent proper ventilation. This can cause overheating and a malfunction of the projector.

Should the projector filter become seriously clogged with dust, it can cause over-heating inside of the projector. You will see the message pictured to the right before the projector shuts down and powers off.

**Please install a new filter.
The projector will turn off in 1 min.**

To clean the filter:

1. Shut down the projector if turned on and wait until the fans stop running.
2. Release the bottom edge of the filter cover (right side of projector) by gently pulling the tabs on the lower ends of the panel (as illustrated).

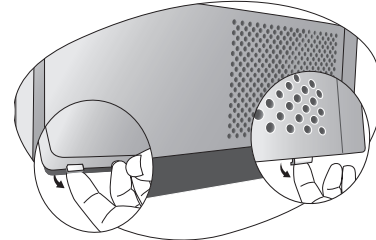
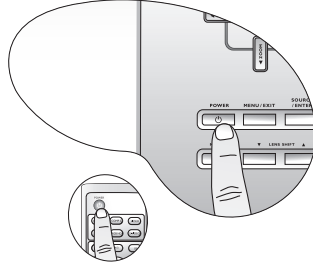

3. Remove the filter cover by gently lifting the loosened cover vertically upwards and then away from the projector body.
4. Remove the dust filter grill by pulling the tab outwards and away from the projector.

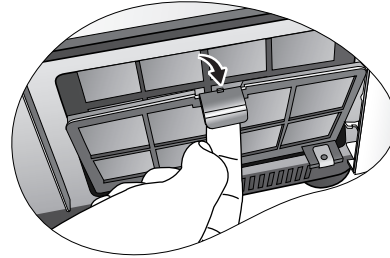
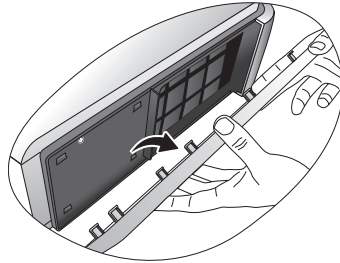

5. Use a small vacuum cleaner (designed for computers and other office equipment) or use a soft brush (such as a clean artist's paintbrush) to vacuum or sweep the dust away.
6. Re-install the filter grill and cover securely.

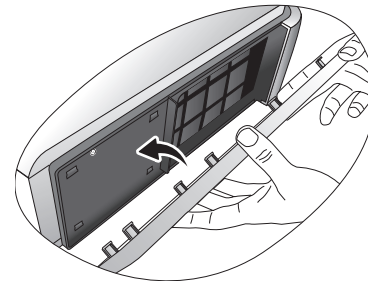
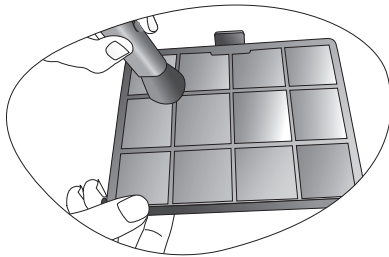

- If the dirt is difficult to remove or the filter is broken, you should replace it.
7. Reapply power and turn the projector on.
 - If the filter grill is not correctly seated in place, you will be reminded by a message displayed on the screen every three minutes until **MENU/EXIT** on the projector or **EXIT** on the remote control is pressed. **Please check if the filter is well attached.**
 - The projector will automatically shut down within minutes if there has been no further action taken. Re-install the filter and cover securely, then turn on the power again.
 8. Go to **Setup > Reset Dust Filter Timer** to reset the filter timer. See page 28 for details.

Installing the cable connector-panel cover

The cable connector-panel cover is used to cover those unsightly cables and connections in the rear of the projector after all of the cable connections have been done.

Important Notice: The following instructions are only for the projector which is intended to be installed near the floor or in a reachable location. If your projector is ceiling-mounted or out of your reach, it is a must to install or un-install the cable cover through a qualified technician's help.

To install the cover:

1. Repeat Step 1~Step 3 in the "To clean the filter:" section. [See page 31](#) for details.
2. Place a soft item on the desk for padding. Turn the projector upside-down so that you can locate the screws that hold the rear cover to the projector on both sides. Loosen the screws.

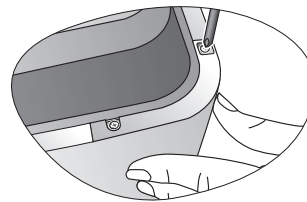

3. Turn the projector topside-up. Remove the rear cover.
4. Manage all the connected cables within the indentation of the cable connector-panel cover and attach it to the projector securely.

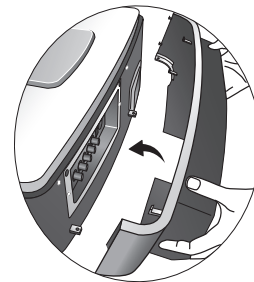
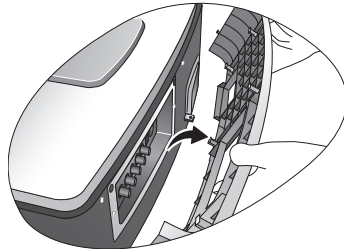

5. Turn the projector over again. Tighten the screws to hold the cable connector-panel cover and the projector on both sides.
6. Re-install the filter cover securely.

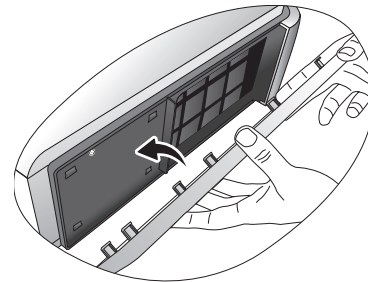
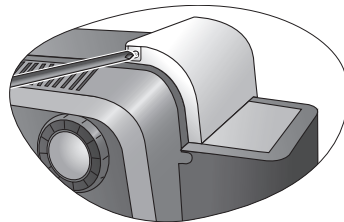

7. The installation is finished.

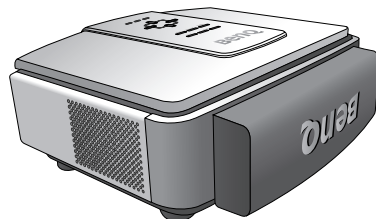

Replacing the lamp

- ⚠ The lamp may be very hot. Allow the projector to cool for at least 45 minutes before replacing the lamp. This lamp contains mercury. Consult your local hazardous waste regulations to dispose of this lamp in a proper manner.**

1. Turn the power off and disconnect the projector from the wall socket. Turn off all connected equipment and disconnect all other cables.
2. Slightly lift the projector up. Loosen the screws on the lamp cover (located on the left side).

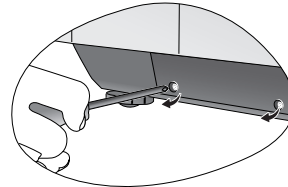

3. Remove the lamp cover.

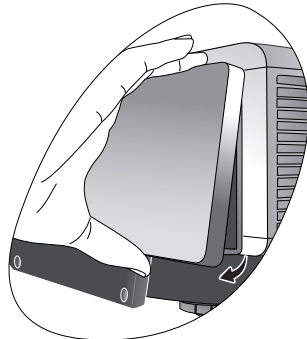

4. Loosen the screws that hold the lamp to the projector. If the screws are not loosened completely, they could injure your fingers. It is strongly recommended that you use a magnetic-head screwdriver to retain the screw should it come loose.

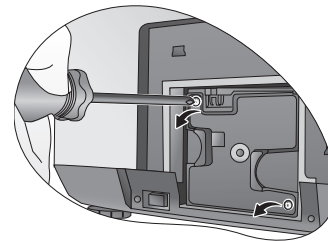

5. Slowly pull the lamp out of the projector.

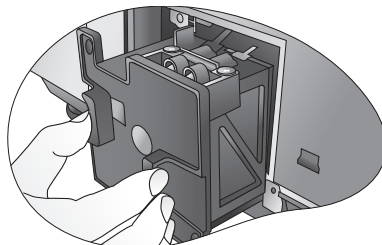

6. Insert the replacement lamp. Make sure it is pushed fully and firmly in place.
7. Tighten the screws securing the lamp box.

Please be careful to not over-tighten the screws. Loose screws may cause a bad connection, which could result in malfunction.

8. Re-install the lamp cover.

☞ Pulling it too quickly may cause the lamp to break and scatter broken glass in the projector. To reduce the risk of injuries to fingers and damage to internal components, use caution when removing lamp glass that has shattered.

☞ Do not place the lamp in locations where water might splash on it, children can reach it, near or above heat sources, or near flammable materials.

☞ Do not insert your hand into the projector when the lamp is removed. If you touch the optical components inside, it could cause blurred images.

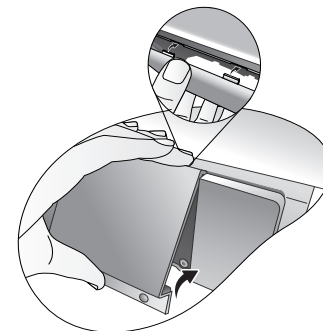

10. Turn the power on and go into **Setup > Lamp > Reset Lamp Timer** menu to reset the lamp time.

9. Tighten the screws on the lamp cover.

☞ Do not reset the lamp timer if the lamp has not been replaced as this could cause damage.

Indicators

There are three indicators which show the status of the projector. Check the following for information about the indicator lights. If there is anything wrong, turn the projector off and contact your dealer.

When the projector is in a normal state, ...

POWER	TEMP	LAMP	STATE	REMARK
Orange	Off	Off	Standby mode.	
Flashing orange			The projector is powering up.	Cannot turn the projector off.
Green			The projector is under normal operation.	
Flashing green			(1) The projector needs 110 seconds to cool down as it was abnormally shut down without the normal cooling down process. Or (2) The projector needs to cool for 110 seconds after the power is turned off.	Cannot turn the projector on.

When the projector is in an abnormal state, ...

POWER	TEMP	LAMP	STATE	REMARK
Orange	Off	Red	(1) The lamp has exceeded its usage life. Or (2) The lamp is not properly attached or is damaged.	Solution: • Install a new lamp. • Please contact your dealer for assistance.
Orange	Red	Off	The dust filter is seriously clogged with dust. The projector is going to shut down.	Solution: • Install a new filter.
Orange	Red	Off	The internal temperature is too high. • The intake ventilation or the exhaust ventilation is blocked. • The projector may be in a poorly ventilated location. • The ambient temperature may be too high.	Solution: • Make sure that the ventilation holes are not blocked. • Relocate the projector. • Stop using the projector until the ambient temperature falls within the specified range. The maximum operating temperature is specified as 40°C / 104°F.
Orange	Flashing red	Flashing red	The fans are not working.	Solution: • Check if the power supply is stable. • Check if there is object stuck in the fans. • Contact your dealer.

Troubleshooting

Problem	Cause	Remedy
The projector does not turn on.	There is no power from the power cable.	Plug the power cable into the AC inlet on the rear of the projector, and plug the power cable into to the power outlet. If the power outlet has a switch, make sure that it is switched on. (See page 19)
	The power switch is not in the on position.	Put the power switch in the on position. (See page 19)
	Attempting to turn the projector on again during the cooling process.	Wait until the cooling down process has completed.
	The lamp cover is not securely attached.	Correctly attach the lamp cover. (See page 33)
No picture.	The video source is not turned on or connected correctly.	Turn the video source on and check that the signal cable is connected correctly. (See page 17)
	The projector is not correctly connected to the input source device.	Check the connection. (See page 17)
	The input signal has not been correctly selected.	Select the correct input signal with the Source buttons on the remote control or SOURCE / ENTER on the projector. (See page 19)
Image is unstable.	The connection cables are not securely connected to the projector or the signal source.	Correctly connect the cables to the appropriate terminals. (See page 17)
Picture is blurred.	The projection lens is not correctly focused.	Adjust the focus of the lens using the focus ring. (See page 20)
	The projector and the screen are not aligned properly.	Adjust the projection angle and direction as well as the height of this unit if necessary. (See page 19)
Remote control does not work correctly	The batteries are out of power.	Replace both of the batteries with new ones. (See page 9)
	There is an obstacle between the remote control and the projector.	Remove the obstacle. (See page 13)
	You are too far away from the projector.	Stand within 8 meters (26.2 feet) of the projector. (See page 13)

Specifications

 All specifications are subject to change without notice.

Optical

Projection system	Single-chip DLP™ system.
DMD chip	0.95" DLP (1920 x 1080)
Lens	1.15x zoom
Projection screen size	23.5" ~ 300"
Lamp	250W

Electrical

Video Signal	NTSC / NTSC4.43 / PAL-M / PAL-N / SECAM / DTV
Data Signal	WXGA, SXGA, XGA, SVGA, VGA, VESA, Macintosh® 16"/13" and 21"/19"(in Advanced Intelligent Compression), HDTV compatible (1080p, 1080i, 720p, 576p, 576i, 480p, 480i)
Max. number of display colors	16,770,000 (full color display)

Terminals

Input	Video, S-Video, Component (Y/ CB/ CR, Y/ Pb/ PR) RS-232C, RGBHV, HDMI
Output	12VDC

General characteristics

Weight	20.9lbs / 9.5kg
Power	VAC 100 - 240V, 4.0 A, 50 / 60 Hz (Automatic)
Power consumption	Max 320W
Operating temperature	0 °C to 40 °C at sea level
Operating humidity	10% - 90% (without condensation)
Operating altitude	6000 feet at 30°C, 6000 - 10000 feet at max. 23°C
Storage temperature	-10°C- 60°C / 14°F to 140°F
Storage humidity	10% - 90%

Dimensions

492 x 195 x 444 mm (W x H x D) with the cable connector-panel cover attached

492 x 195 x 393 mm (W x H x D) without the cable connector-panel cover attached

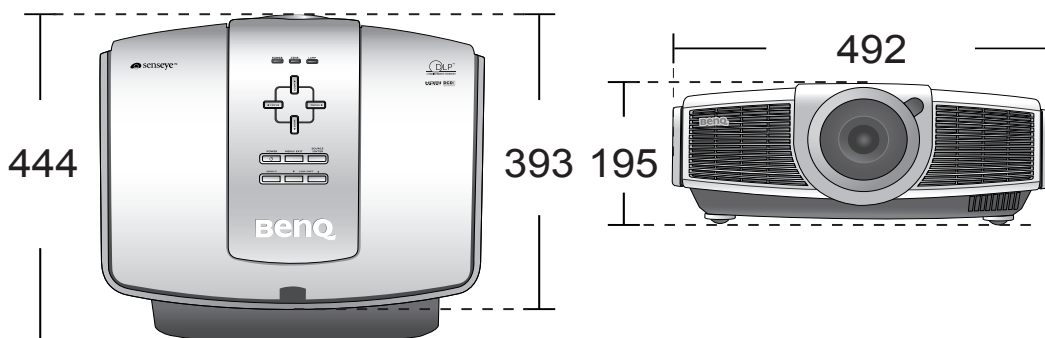

Unit: mm

Free Manuals Download Website

<http://myh66.com>

<http://usermanuals.us>

<http://www.somanuals.com>

<http://www.4manuals.cc>

<http://www.manual-lib.com>

<http://www.404manual.com>

<http://www.luxmanual.com>

<http://aubethermostatmanual.com>

Golf course search by state

<http://golfingnear.com>

Email search by domain

<http://emailbydomain.com>

Auto manuals search

<http://auto.somanuals.com>

TV manuals search

<http://tv.somanuals.com>