

Bissell®

WE MEAN CLEAN

Little Green®

USER'S GUIDE

1720-1725 SERIES



3 Safety Instructions

4 Product view

5-6 Product features

7-9 Operations

9 Storage

10 Troubleshooting

11 Consumer Services

11 Replacement Parts

12 Warranty



Thanks for buying a BISSELL Little Green Portable Deep Cleaner

We're glad you purchased a BISSELL Little Green® Portable Deep Cleaner. Everything we know about floor care went into the design and construction of this handy, high-tech home cleaning system.

Your Little Green is well made, and we back it with a full one-year warranty. We also stand behind it with a knowledgeable, dedicated Consumer Services department, so, should you ever have a problem, you'll receive fast, considerate assistance.

My great-grandfather invented the floor sweeper in 1876. Today, BISSELL is a global leader in the design, manufacture, and service of high quality homecare products like your Little Green.

Thanks again, from all of us at BISSELL.

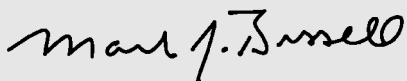

Mark J. Bissell
President and Chief Executive Officer

IMPORTANT SAFETY INSTRUCTIONS

When using an electrical appliance, basic precautions should be observed, including the following:

READ ALL INSTRUCTIONS BEFORE USING YOUR VACUUM.

Always connect to a polarized outlet (left slot is wider than right). Unplug from outlet when not in use and before conducting maintenance.

⚠ WARNING: To reduce the risk of fire, electric shock, or injury:

- Do not modify the polarized plug to fit a non-polarized outlet or extension cord.
- Do not leave deep cleaner unattended when it is plugged in.
- Unplug from outlet when not in use and before servicing.
- Do not use outdoors or on wet surfaces.
- Do not allow children to operate deep cleaner or use as a toy.
- Close attention is necessary when used by or near children.
- Do not use for any purpose other than described in this User's Guide.
- Use only manufacturer's recommended attachments.
- Do not use with damaged cord or plug.
- If appliance is not working as it should, has been dropped, damaged, left outdoors, or dropped into water, return it to a service center.
- Do not pull or carry by cord, use cord as a handle, close a door on cord, or pull cord around sharp edges or corners. Do not run appliance over cord. Keep cord away from heated surfaces.
- Do not unplug by pulling on cord. To unplug, grasp the plug, not the cord.
- Do not handle deep cleaner or plug with wet hands.
- Do not put any object into openings. Do not use with any opening blocked; keep openings free of dust, lint, hair, and anything that may reduce air flow.
- Always turn off deep cleaner before connecting or disconnecting motorized nozzle.
- Keep hair, loose clothing, fingers, and all parts of body away from openings and moving parts.
- Turn off all controls before plugging or unplugging deep cleaner.
- Use extra care when cleaning stairs.
- Do not pick up flammable materials (lighter fluid, gasoline, kerosene, etc.) or use in the presence of explosive liquids or vapors.
- Do not pick up toxic material (chlorine bleach, ammonia, drain cleaner, etc.).
- Do not use deep cleaner in an enclosed space filled with vapors given off by oil base paint, paint thinner, some moth proofing substances, flammable dust, or other explosive or toxic vapors.
- Do not pick up hard or sharp objects such as glass, nails, screws, coins, etc.
- Do not pick up anything that is burning or smoking, such as cigarettes, matches, or hot ashes.
- Do not use without dust bag and/or filters in place.
- Use only on dry, indoor surfaces.
- Keep appliance on a level surface.

SAVE THESE INSTRUCTIONS FOR FUTURE USE.

THIS APPLIANCE HAS A POLARIZED PLUG.

To reduce the risk of electric shock, this appliance has a polarized plug (one blade is wider than the other). This plug will fit in a polarized outlet only one way. If the plug does not fit fully in the outlet, reverse the plug. If it still does not fit, contact a qualified electrician to install a proper outlet. Do not change the plug in any way.

This model is for household use only.



WARNING:

Do not use this product while on any type of a ladder. Do not place the product in a place where it will be stepped on or kicked while in use. Do not place the product on an elevated surface where it may be pulled off the surface while in use.



WARNING:

Do not use an extension cord with this product. The use of an extension cord may result in a severe electrical shock, particularly if the extension cord does not have an electrical rating higher than that of the product, if the extension cord does not have a three prong grounding plug and connector and if the extension cord is not plugged into a circuit box with a ground fault circuit interrupter. Safety precautions such as keeping all connections off the ground and dry will not eliminate the danger.

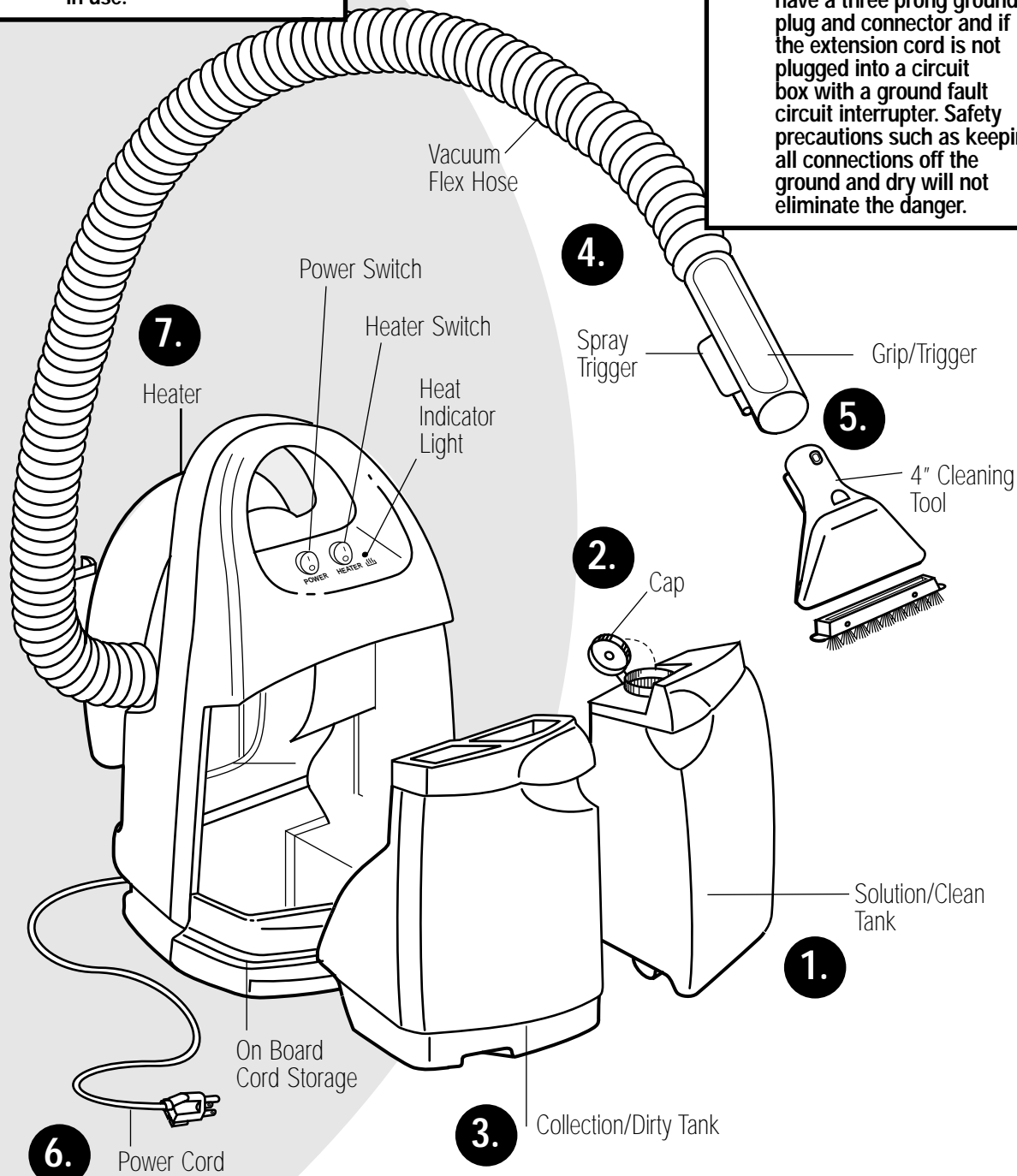

How to use this guide

This User's Guide has been designed to help you get the utmost satisfaction from your BISSELL Little Green Portable Deep Cleaner. You'll find assembly and operating instructions, safety precautions, as well as maintenance and troubleshooting instructions. Please read this Guide thoroughly before assembling your cleaner.

Pay particular attention to the product diagram, assembly instructions, and part names. Locate and organize all parts before assembly. Familiarize yourself with the parts and where they go. Following this User's Guide will greatly enhance your ability to get the most performance from your BISSELL Little Green for many years.



WARNING:

Do Not plug in your deep cleaner until you have completely assembled it per the following instructions and are familiar with all instructions and operating procedures.

Product Features

Refer to Assembly Diagram on page 4

Solution Tank

The Solution Tank is the translucent tank at your right as you face the Little Green. Remove the Tank by grasping the indented handle and pulling it toward you, then tilting out.

To Fill the Solution Tank

Open the Solution Tank by pulling up on the round cap. Add BISSELL Little Green Formula to the FORMULA fill line (8-oz.) on Solution Tank.

NOTE: Your Little Green is shipped with an 8 oz. starter bottle of formula.

Fill the Solution Tank with hot (NOT boiling) tap water to the WATER fill line.

Replace the cap before placing the Solution Tank back into the unit.

Replace the Solution Tank by pacing it bottom first into the cavity, then tilting it, pressing gently at top until it snaps closed.

Collection Tank

The Collection Tank is the translucent tank at your left as you face the Little Green. It is removed and replaced on the unit just like the Solution Tank. Empty the Collection Tank after each use, when dirty water reaches the indicated maximum fill line, or as instructed in this User's Guide.

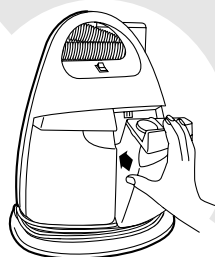
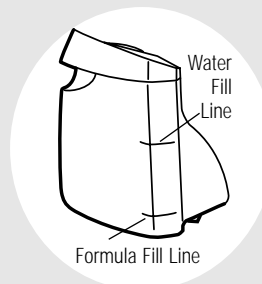
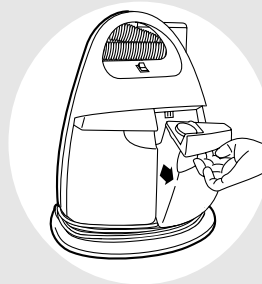

Product Features Continued

Vacuum Flex Hose with Grip/Trigger Unit

Store in the on-board hose storage on the back of the Little Green. Cleaning tools attach to the Grip/Trigger unit.

Power Cord

The cord, with a three-prong grounded plug, stores in the On Board Cord Storage at the bottom of the Little Green.

Note: Unwrap Power Cord completely before operating unit.

Built-in-heater

Not included with all models

With the Little Green ProHeat, you have the ability to turn on, or leave off, the built-in heater, based on your cleaning needs.

The Little Green ProHeats' built-in heater will raise the water temperature for improved cleaning performance. To use Little Greens' built-in heater, first turn the Power Switch ON and then turn the Heater Switch ON. Within 30 seconds, the Heat Indicator Light will illuminate, indicating the heater has reached the correct temperature.

Begin using by depressing the Spray Trigger. Wait 5-10 seconds for non-heated water and solution mixture to travel through the Flex Hose. After 5-10 seconds, the heated water and solution mixture is ready to be applied to carpet or upholstery.

See Page 8 for cleaning instructions.

Specialized Cleaning Tools

Depending on which model you purchased, your Little Green may be equipped with one or more of these tools:

1. 4" wide Cleaning Tool (included with all models)-For cleaning carpet, upholstery and spot cleaning
2. Spraying Crevice Tool-For cleaning in tight areas
3. 6" wide Cleaning Tool-For larger areas
4. TurboBrush Cleaning Tool-Rotating brush for extra cleaning action for small areas, upholstery and stairs

To order optional tools not originally included with your Little Green see "Part Numbers and Descriptions," page 9

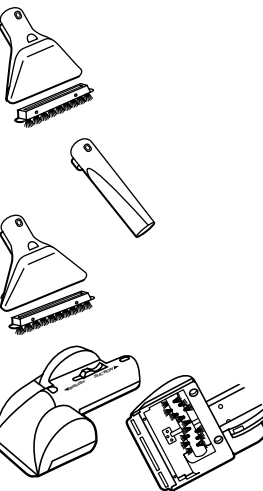

⚠ WARNING:
Use only BISSELL Little Green formula in your cleaner. Use of cleaning formulas which contain lemon or pine oil may damage this appliance and void warranty. Chemical spot cleaners or solvent-based soil removers should not be used. These products may react with the plastic materials used in your cleaner, causing cracking or pitting.

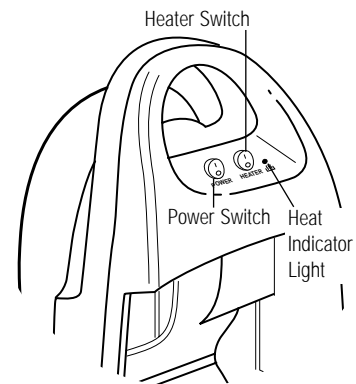

How To Deep Clean Carpet or Upholstery

Getting Ready

1. Remove Vacuum Flex Hose completely from On Board Hose Storage.
 2. Attach 4" Tool, TurboBrush* or Crevice Tool* to Grip Trigger Unit by pressing Tool onto Grip/Trigger Unit firmly, until button snaps into hole. Make certain Tool is securely attached.
 3. Unwrap Power Cord completely from On Board Cord Storage and plug into 1230 Volt, 60 Hz grounded outlet as described in Important Safety Instructions, page 3.
 4. Turn Power switch to ON Position.
- Note: If your Little Green has a built-in heater, refer to instructions on page 7.**
5. Press and hold Spray Trigger on Grip/Trigger unit. Spray will start in a few seconds.
 6. Raise the Tool slightly to check for spray. If spray does not start, press firmly on the front of the Solution Tank while depressing Spray Trigger.

***Optional on some Little Green models. To order optional parts not originally included in your Little Green model, call BISSELL Consumer Services at the telephone number listed on page 9.**

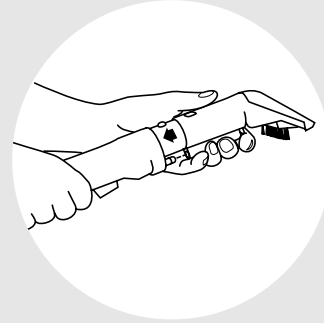

⚠ WARNING:
Be sure to unplug the cord before attaching the Turbobrush.

Pre-treating

1. Pre-treat stained or highly soiled areas: Hold the flex hose with tool attached above carpet or upholstery, and pull trigger to spray cleaning solution.
2. Wait 3-5 minutes before cleaning.

Deep Cleaning

1. Place the tool directly on soiled surface at arms length. Apply downward pressure on the tool and pull toward you, while pulling trigger to spray cleaning solution.

Note: If using the TurboBrush, the switch should be in the "BRUSH" position. This activates the brush only.

2. Repeat, keeping the tool firmly against the surface. Continue until no more dirt can be removed. **Do not overwet.**

Note: If using the Turbobrush, move the switch to the "SUCTION" position. This activates the suction to remove the dirt and cleaning solution. Move the switch back to the "BRUSH" position for additional brushing action.

Do not overwet.

3. Release spray trigger. Vacuum area until no more cleaning solution can be removed.

Note: If using the Turbobrush, move the switch to the "SUCTION" position. This activates the suction to remove the dirt and cleaning solution.

4. If the tool stops spraying, turn OFF Power Switch and check cleaning solution level. Refill if needed. Never run dry.

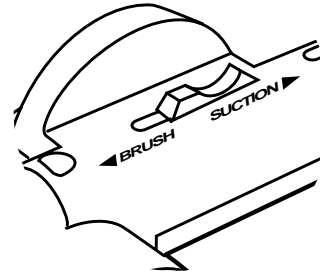

Deep Cleaning Upholstery

1. Check the manufacturer's tag before cleaning. "W" or "WS" on the tag means you can use your Little Green. If tag is coded with an "S" (with diagonal strike-through), or says "Dry Clean Only," do not proceed.

2. If manufacturer's tag is missing or not coded, check with your furniture dealer.

3. If possible, check upholstery stuffing. Colored stuffing may bleed through fabric when wet.

Tip:

Deep cleaning stairs and high traffic areas on a regular basis can prolong carpet life.

Tip:

Check upholstery stuffing before cleaning. Colored stuffing may bleed through fabric when wet.

When You're Done

1. Turn Power Switch to OFF position.
2. Unplug Power Cord from outlet.
3. Remove and rinse Solution Tank, then replace.
Note: If a significant amount of Little Green formula/water remains, you may leave it in the Solution Tank for your next cleaning task.
4. Remove Collection Tank, fill with clean water, rinse thoroughly and discard, then replace.
5. Disconnect the tool from Grip/Trigger unit by pushing down on button lock and pulling straight off (Do NOT twist tools to remove them).
6. Once removed from the Vacuum/Flex Hose, the tools can be cleaned:
4", 6", or Crevice tool-Rinse under clean running water. TurboBrush tool-Switch must be in "SUCTION" position. Rinse under clean running water.
7. Check Spray Nozzle for accumulated dirt or debris. If necessary, clean with soft bristle brush.

Tip:

Before turning off Little Green, vacuum up clean water to thoroughly rinse the Vacuum Hose. Then, lift the tool and point upwards. This allows any water still in the Hose to flow into the Collection Tank.



WARNING:

Keep face away from spray. Failure to do so may result in personal injury.

Storage

1. Wipe all surfaces with a soft cloth.
2. Wrap Power Cord around Onboard Cord Storage at the bottom of Little Green.
3. Wrap Vacuum Flex Hose around Onboard Hose Storage and secure Grip/Trigger.
4. Store Cleaner in protected, dry area, at room temperature (40° to 110°F).

Note: For Little Green TurboBrush Models, on-board storage for the TurboBrush Tool has been provided on the back of the unit. Attach the TurboBrush to the unit by pressing onto holder firmly until button snaps into hole.

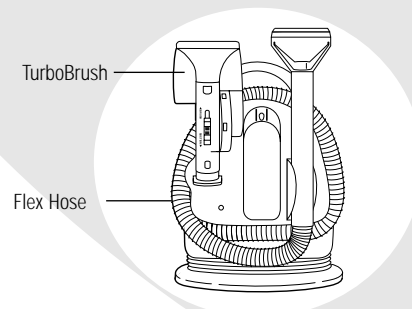
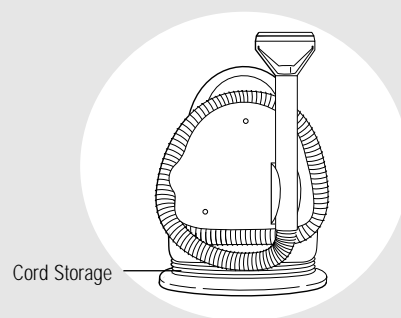



WARNING:

To reduce the risk of injury from moving parts and/or electrical shock, turn Power Switch OFF and disconnect polarized plug from electrical outlet before performing troubleshooting checks.

Cleaner won't run.

Possible Causes

Power Unit not plugged in
Blown fuse/tripped breaker

Remedies

Check electrical plug
Replace household fuse or Reset Breaker
Call BISSELL Customer Service

Reduced spray or no spray

Possible Causes

Spray Nozzle clogged
Solution Tank empty
Solution Tank outlet clogged
Pump needs priming

Remedies

Clean Spray Nozzle
Check/Refill Tank
Clean outlet at bottom of Solution Tank
Push firmly on Solution Tank front while depressing Spray Trigger

Vacuum won't pick up cleaning solution

Possible Causes

Poor Upholstery/Carpet Tool position

Collection Tank is full
Upholstery/Carpet Tool Brush worn
Excess solution in Vacuum Flex Hose

Incorrect switch position on TurboBrush

Remedies

Reposition Upholstery/Carpet Tool on surface, follow recommended cleaning procedures
Empty Collection Tank
Replace with new Brush
Lift Tool and point upwards to allow water in Hose to flow into the Collection Tank
Reposition switch to "Suction" Position

Excessive Foam in the Collection Tank

Possible Causes

Residue left in carpet or fabric form prior cleaning

Incorrect cleaning formula

Remedies

Flush carpet by using clear water in Solution Tank
Check Tank often/empty as necessary
Use BISSELL Little Green formula only

TurboBrush attachment-Brush will not turn

Possible Causes

Incorrect switch position on TurboBrush

Remedies

Reposition switch to "Brush" position

BISSELL Customer Service

For information about repairs or replacement parts, or questions about your warranty, call:

BISSELL Customer Service

1-800-263-2535

Monday - Friday 8 a.m. — 4:30 p.m. EST

Or write:

BISSELL Ltd.

ATTN: Consumer Services

Box 1003

Niagara Fall, Ontario, L2E 6W2

Or visit the BISSELL website - www.bissell.com

When contacting BISSELL, have model number of unit available.

Please record your Model Number: _____

Please record your Purchase Date: _____

NOTE: Please keep your original sales receipt. It provides proof of date of purchase in the event of a warranty claim. See "About Your Warranty" on page 14 for details.

Replacement parts - BISSELL Little Green

Item	Part No.	Part Name
1	203-0983	4" Upholstery/Carpet Tool w/Brush
2	203-0961	4" Window
3	203-0984	4" Removable Brush
4	203-0985	6" Upholstery/Carpet Tool w/Brush
5	603-0912	6" Window
6	203-0986	6" Removable Brush
7	203-0987	Spraying Crevice Tool
8	210-1183	TurboBrush
Solution/Clean Tank		
9	203-1200	Little Green
10	603-1224	Little Green TurboBrush
11	203-1209	Little Green ProHeat
12	203-1210	Little Green ProHeat TurboBrush
Collection/Dirty Tank		
13	203-1201	White

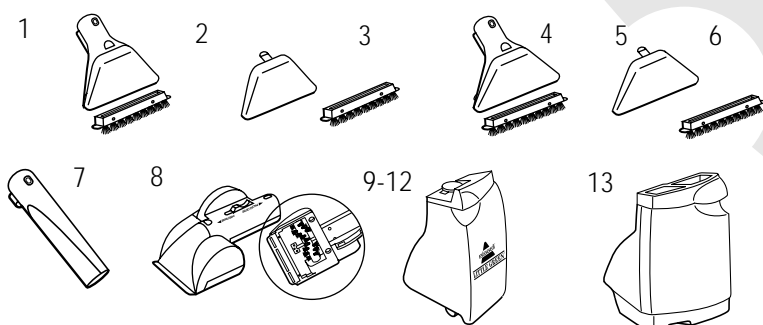

BISSELL
WE MEAN CLEAN

©2001 BISSELL Inc.
BISSELL Ltd.
Niagara Falls, Ont., L2E 6W2
All rights reserved. Printed in China
Part Number U.G. 1720/25
Rev 10/01

Visit our website at:
www.bissell.com

About Your Warranty

Limited **One** Year Warranty

BISSELL Ltd., or an authorized BISSELL Service Centre will repair or replace free of charge, any part which is defective or malfunctioning within 1 year of the purchase date, provided that it is used for personal, and not commercial or rental service.

Terms:

1. Return the unit and/or part with proof of purchase date, to your dealer, your nearest BISSELL Authorized service Centre, or return by mail to:

BISSELL Ltd.
6934 Kinsmen Court,
Niagara Fall, Ontario, L2E 6S5

2. Any defective or malfunctioning part will be repaired or and returned postage paid.
3. This warranty does not cover bags, belts, filters or light bulbs. Damages or malfunctions caused by negligence, abuse, or use not in accordance with the User's Guide will not be covered. This warranty does not cover parts of the unit that require replacement under normal use.

For your protection, you should always insure the unit and/or part when shipping or mailing. BISSELL will reimburse you for the parcel post, Canpar or UPS charge. Any charges for packaging or insurance are your responsibility.

Tip: Attach your sales receipt to this User's Guide for future reference.

Free Manuals Download Website

<http://myh66.com>

<http://usermanuals.us>

<http://www.somanuals.com>

<http://www.4manuals.cc>

<http://www.manual-lib.com>

<http://www.404manual.com>

<http://www.luxmanual.com>

<http://aubethermostatmanual.com>

Golf course search by state

<http://golfingnear.com>

Email search by domain

<http://emailbydomain.com>

Auto manuals search

<http://auto.somanuals.com>

TV manuals search

<http://tv.somanuals.com>