

# OWNER'S MANUAL

## 22" HI WHEEL ROTARY MOWER

Model Number  
113-500A

**Important:**  
**Read Safety Rules and**  
**Instructions Carefully**

Thank you for purchasing an  
American built product.

# INDEX

Safe Operation Practices .....	3	Maintenance .....	10
Assembly .....	4	Off-Season Storage .....	11
Controls .....	7	Illustrated Parts .....	14
Operation .....	8	Repair Parts List .....	15
Adjustments .....	9	Parts Information .....	Back Cover
Lubrication .....	10		

## LIMITED WARRANTY

For one year from the date of original retail purchase, MTD PRODUCTS INC will either repair or replace, at its option, free of charge, F.O.B. factory or authorized service firm, any part or parts found to be defective in material or workmanship. Transportation charges for the movement of any power equipment unit or attachment are the responsibility of the purchaser. Transportation charges for any parts submitted for replacement under this warranty must be paid by the purchaser unless such return is requested by MTD PRODUCTS INC.

This warranty will not apply to any part which has become inoperative due to misuse, excessive use, accident, neglect, improper maintenance, alterations, or unless the unit has been operated and maintained in accordance with the instructions furnished. This warranty does not apply to the engine, motor, battery, battery charger or component parts thereof. Please refer to the applicable manufacturer's warranty on these items.

This warranty will not apply where the unit has been used commercially.

Warranty service is available through your local authorized service dealer or distributor. If you do not know the dealer or distributor in your area, please write to the Customer Service Department of MTD.

The return of a complete unit will not be accepted by the factory unless prior written permission has been extended by MTD.

This warranty gives you specific legal rights. You may also have other rights which vary from state to state.



This unit is equipped with an internal combustion engine and should not be used on or near any unimproved forest-covered, brush-covered or grass-covered land unless the engine's exhaust system is equipped with a spark arrester meeting applicable local or state laws (if any). If a spark arrester is used, it should be maintained in effective working order by the operator.

In the State of California the above is required by law (Section 4442 of the California Public Resources Code). Other states may have similar laws. Federal laws apply on federal lands. A spark arrester muffler is available at your nearest engine authorized service center.



## WARNING

To reduce the potential for any injury, comply with the following safety instructions. Failure to comply with the instructions may result in personal injury.

# SAFE OPERATION PRACTICES FOR WALK-BEHIND MOWERS

## TRAINING

1. Read this owner's manual carefully in its entirety before attempting to assemble or operate this machine. Be completely familiar with the controls and the proper use of this machine before operating it. Keep this manual in a safe place for future and regular reference and for ordering replacement parts.
2. Your rotary mower is a precision piece of power equipment, not a plaything. Therefore, exercise extreme caution at all times.
3. Never allow children to operate a power mower. Only persons well acquainted with these rules of safe operation should be allowed to use your mower.
4. Keep the area of operation clear of all persons, particularly small children and pets. Stop engine when they are in the vicinity of your mower. Although the area of operation should be completely cleared of foreign objects, an object may have been overlooked and could be accidentally thrown by the mower in any direction and cause serious personal injury to the operator or any others allowed in the area.

## PREPARATION

1. Thoroughly inspect the area where the equipment is to be used. Remove all stones, sticks, wire, bones and other foreign objects which could be picked up and thrown by the mower in any direction and cause serious personal injury to the operator or any others allowed in the area.
2. Do not operate equipment when barefoot or wearing open sandals. Always wear substantial footwear.
3. Do not wear loose fitting clothing that could get caught on the mower.
4. Check the fuel before starting the engine. Gasoline is an extremely flammable fuel. Do not fill the gasoline tank indoors, while the engine is running, or while the engine is still hot. Wipe off any spilled gasoline before starting the engine as it may cause a fire or explosion.
5. Disengage the self-propelled mechanism or drive clutch on units so equipped before starting the engine.
6. The blade control handle is a safety device. Never attempt to bypass its operation. Doing so makes the safety device inoperative and may result in personal injury through contact with the rotating blade. The blade control handle must operate easily in both directions.
7. Never attempt to make a wheel or cutting height adjustment while the engine is running.
8. Mow only in daylight or in good artificial light.
9. Never operate the equipment in wet grass. Always be sure of your footing. A slip and fall can cause serious personal injury. Keep a firm hold on the handle and walk, never run.

## OPERATION

1. Do not change the engine governor settings or overspeed the engine. Excessive engine speeds are dangerous.
2. Do not put hands or feet near or under rotating parts. Keep clear of the discharge opening at all times as the rotating blade can cause injury.
3. Stop the blade when crossing gravel drives, walks or roads.
4. After striking a foreign object, stop the engine, remove the wire from the spark plug, and thoroughly inspect the mower for any damage. Repair the damage before restarting and operating the mower.
5. If the equipment should start to vibrate abnormally, stop the engine and check immediately for the cause. Vibration is generally a warning of trouble.
6. Shut the engine off and wait until the blade comes to a complete stop before removing the grass catcher or unclogging the chute. The cutting blade continues to rotate for a few seconds after the engine is shut off. Never place any part of the body in the blade area until you are sure the blade has stopped rotating.
7. Before cleaning, repairing or inspecting, make certain the blade and all moving parts have stopped. Disconnect the spark plug wire, and keep the wire away from the spark plug to prevent accidental starting.
8. Do not run the engine indoors.
9. Mow across the face of slopes, never up-and-down. Exercise extreme caution when changing direction on slopes. Do not mow excessively steep slopes. Always be sure of your footing. A slip and fall can cause serious personal injury.
10. Always disconnect electric mowers (line operated) before cleaning, repairing or adjusting.
11. Never operate mower without proper guards, plates or other safety protective devices in place.

## MAINTENANCE AND STORAGE

1. Check the blade and engine mounting bolts at frequent intervals for proper tightness.
2. Keep all nuts, bolts, and screws tight to be sure the equipment is in safe working condition.
3. Never store the equipment with gasoline in the tank inside of a building where fumes may reach an open flame or spark. Allow the engine to cool before storing in any enclosure.
4. To reduce fire hazard, keep the engine free of grass, leaves, or excessive grease.
5. Check the grass catcher bag frequently for wear or deterioration. For safety protection, replace only with new bag meeting original equipment specifications.



Reference to right or left hand side of the mower is observed from the operating position.

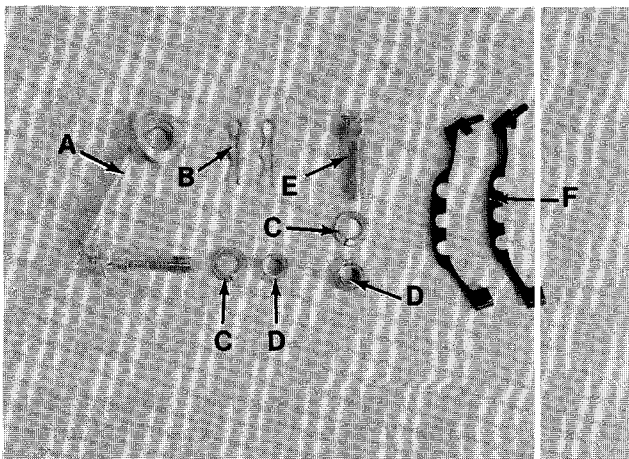

FIGURE 1.

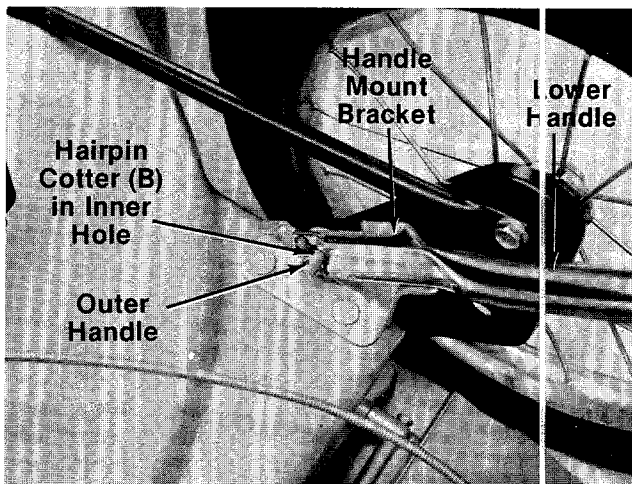

FIGURE 2.

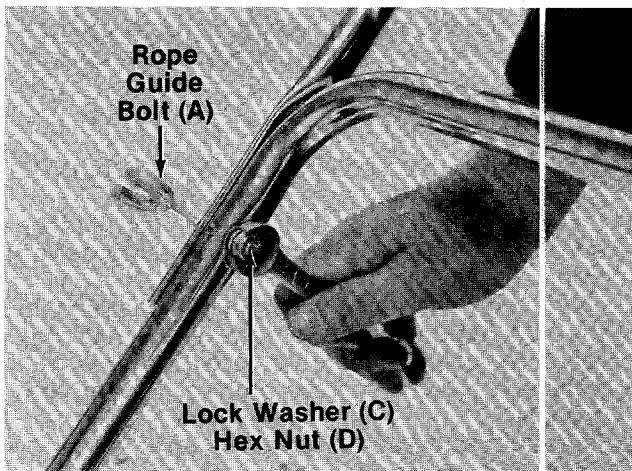

FIGURE 3.

## ASSEMBLY INSTRUCTIONS



This unit is shipped WITHOUT GASOLINE or OIL. After assembly, see separate engine manual for proper fuel and engine oil recommendations.

### ← Contents of hardware pack: (See figure 1)

- A (1) Rope Guide Bolt
- B (2) Hairpin Cotter
- C (2) Lock Washers 5/16" I.D.
- D (2) Hex Nuts 5/16-18 Thread
- E (1) Curved Head Carriage Bolt
- F (2) Cable Ties

1. Remove lawn mower and loose parts from carton. Make certain all parts and literature have been removed from the carton before the carton is discarded.
2. Extend the throttle control cable (attached to the upper handle) and the brake cable (attached to the engine) and place on the floor. Be careful not to bend or kink control cables.
3. Attach the lower handle by placing the bottom holes in the lower handle over the weld pins on the handle mount brackets. Make certain the instruction label on the lower handle can be read from the operating position. Secure with hairpin cotters (B) in inner holes on weld pins. See figure 2.



There are two (2) holes in the handle mount brackets. Place the hairpin cotter in the inner hole for operation. Outer hole is for storage.



It may be necessary to bend the ends of the lower handle outward slightly to obtain a tight fit against the handle mount brackets.

4. Place the upper handle in position over the lower handle. The throttle control must be on the right hand side of the handle. Secure the right hand side of upper handle using the rope guide bolt (A), lock washer (C) and hex nut (D) as shown in figure 3.



Left handed operators may assemble the rope guide bolt to the left hand side of the handle for easier starting.

5. Secure the other side of the handle with curved head bolt (E), lock washer (C) and hex nut (D).

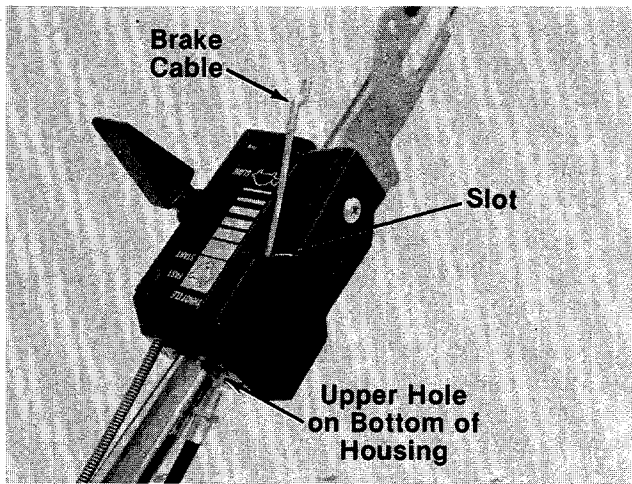
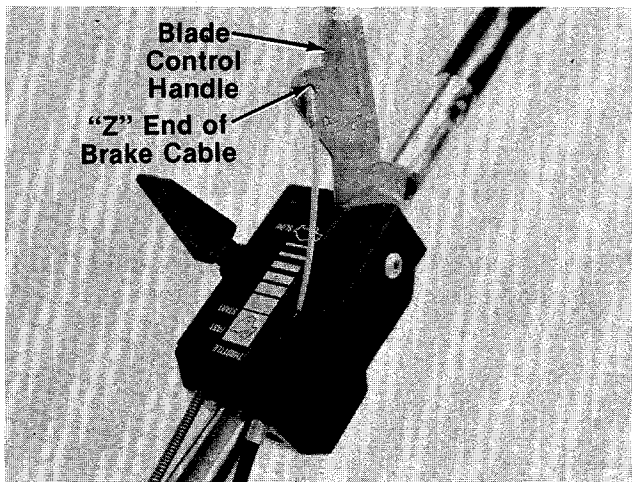

**FIGURE 4.**

6. Place the end of the brake cable into the upper hole on the bottom of the throttle control housing, and through the slot as shown in figure 4. Be careful not to bend or kink the cable.



The control cables should be assembled under the lower handle.



**FIGURE 5.**

7. Snap the end of the cable into the throttle control housing.
8. Hook the “Z” end of the brake cable into blade control handle. See figure 5.

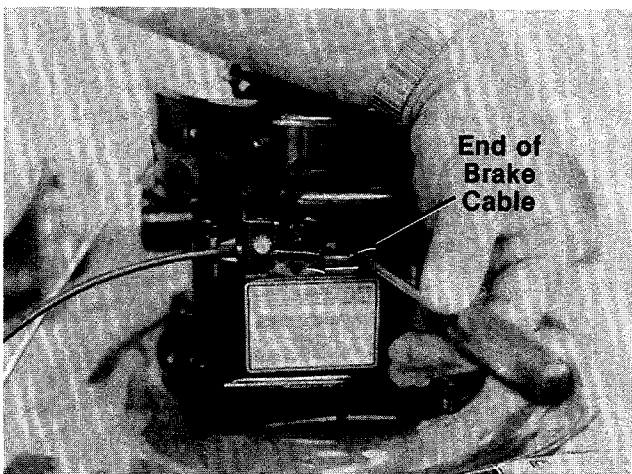

**FIGURE 6.**



It may be necessary to push the end of the brake cable using a screwdriver as shown in figure 6 to allow enough slack for the cable to be assembled to the blade control handle.

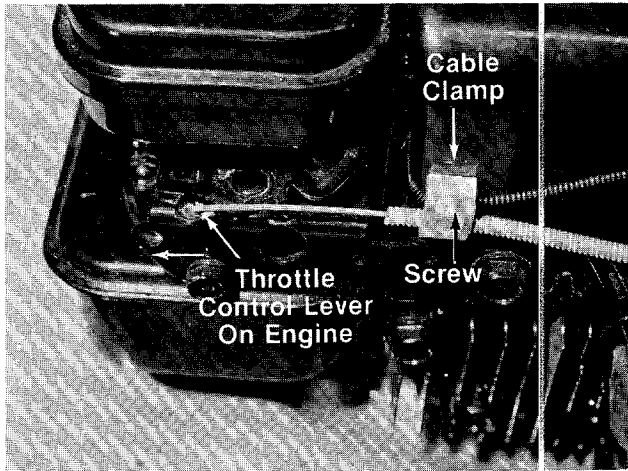

FIGURE 7.

9. Place the throttle control lever on the handle in "Fast" position. Refer to figure 7.
10. Push the throttle control lever on the engine to the full open position (as far toward the outside of the unit as it will go) as shown in figure 7.
11. Hook the "Z" end of the throttle control cable into the hole in the control lever on the engine.
12. Loosen (do not remove) the screw on the cable clamp shown in figure 7. Slip the control casing under the clamp. With the throttle lever on the engine still in the full open position, tighten the screw to secure the throttle control cable.

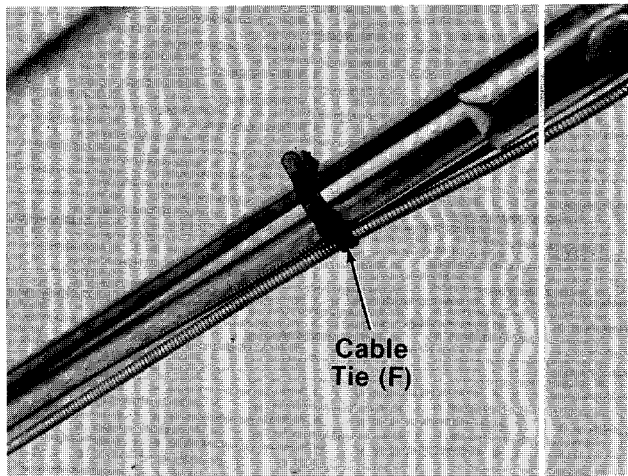

FIGURE 8.

13. Secure throttle control and brake cables to upper and lower handles with cable ties (F). See figure 8.

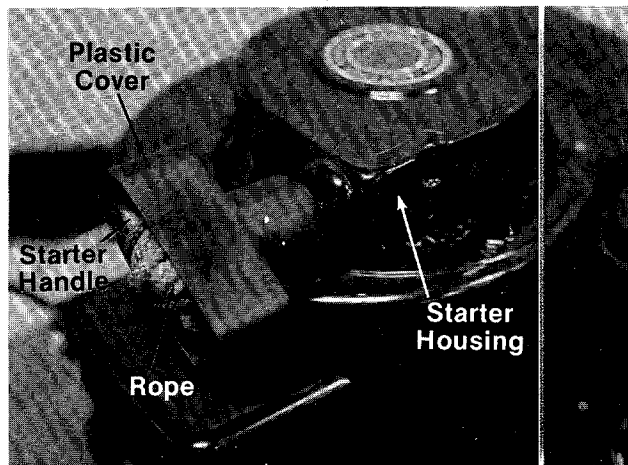

FIGURE 9.

14. The starter rope is pulled out from the engine, wrapped around the starter handle and secured with a plastic cover for shipping purposes. Hold the rope so that it does not retract into the starter housing on the engine. Remove the plastic cover and discard. See figure 9.

**NOTE**

If the rope should accidentally retract, disconnect and ground the spark plug wire. Depress the blade control handle and pull the starter rope out from the engine.



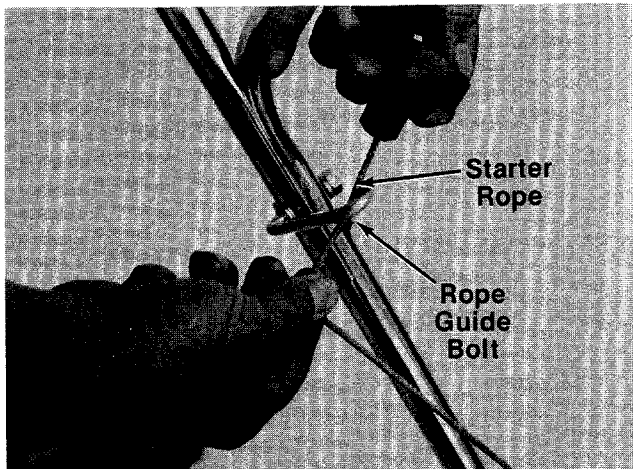

FIGURE 10.

15. Slip the starter rope into the rope guide bolt as shown in figure 10.
16. Check **all** nuts and bolts for correct tightness.

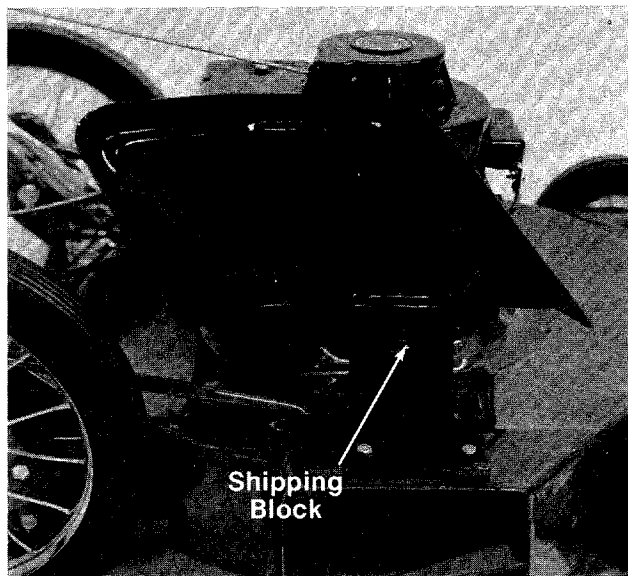

FIGURE 11.



**CAUTION**

Please note that the chute deflector on your mower is in an upright position. It is held in that position by a shipping block. This block is used for shipping purposes only. It must be removed and discarded before your mower is put into operation. See figure 11.

## CONTROLS

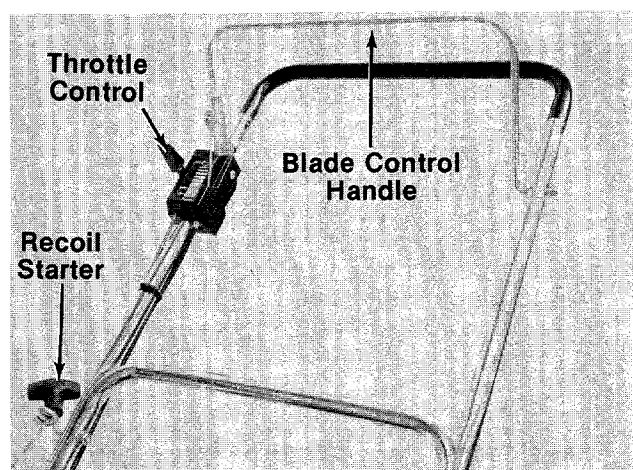

FIGURE 12.

### BLADE CONTROL HANDLE

#### WARNING

**THIS CONTROL MECHANISM IS A SAFETY DEVICE. NEVER ATTEMPT TO BYPASS ITS OPERATIONS**

The blade control handle is located on the upper handle of the mower. See figure 12. The blade control handle must be depressed in order to operate the unit. Release the blade control handle to stop the engine and blade.



**WARNING**

The blade will be rotating whenever the engine is running.

## THROTTLE CONTROL

The throttle control is located on the right side of the upper handle. It is used to regulate the engine speed. The engine should be started with the engine in the FAST or START position.



The throttle control cannot be used to stop the engine.

## RECOIL STARTER

The recoil starter handle is attached to the handle. See figure 12. Stand behind the unit in the operating position to start the unit.

## OPERATION

Keep hands and feet away from the chute area on cutting deck. See figure 13.



For shipping purposes your mower is set with the wheels in a low cutting height position. For best results raise the cutting position until it is determined which height is best for your lawn. See cutting height adjustment section.



FIGURE 13.

### BEFORE STARTING

1. Fill sump with oil as instructed in the separate engine manual packed with your unit.

2. Fill fuel tank, using clean, fresh, leaded **regular** grade automotive gasoline. Fill tank completely!

**DO NOT MIX OIL WITH GASOLINE.**

3. Attach spark plug wire to spark plug.

### TO START ENGINE AND ENGAGE BLADE

1. Move the throttle control lever to FAST or START position.
2. Standing behind the unit, depress the blade control handle and hold it against the upper handle as shown in figure 14.

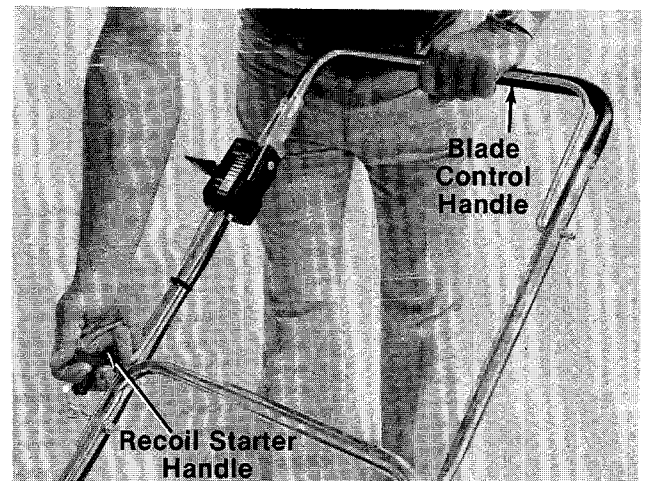

FIGURE 14.

3. Grasp the recoil starter handle as shown and pull up rapidly. Return it slowly to the rope guide bolt.
4. After engine starts, move throttle control to desired engine speed.

### TO STOP ENGINE AND BLADE

1. Release the blade control handle to stop the engine and blade.



The blade continues to rotate for a few seconds after the engine is shut off.

2. Disconnect the spark plug wire and ground it against the engine to prevent accidental starting while equipment is unattended.



## USING YOUR ROTARY MOWER

Be sure that lawn is clear of stones, sticks, wire, or other objects which could damage lawn mower or engine. Such objects could be accidentally thrown by the mower in any direction and cause serious personal injury to the operator and others.

Operate a new engine at intermediate speeds and light load for the first few hours as you would a new automotive engine.

For best results, do not cut wet grass because it tends to stick to the underside of the mower, preventing proper discharge of grass clippings, and could cause you to slip and fall. New grass, thick grass or wet grass may require a narrower cut. Blade speed should be adjusted to the condition of the lawn.

The best mowing pattern is one that allows the clippings to discharge towards the uncut part of the lawn. This permits recutting of the clippings to further pulverize them. When cutting high weeds, discharge towards cut portion, then recut at right angles to first direction.

For best results, cut off one-third or less of the total length of the grass. Lawn should be cut in the fall as long as there is growth.

This mower is designed to be operated at full throttle to give you the best cut and do the most effective job of bagging the cut grass.



### IMPORTANT

If you strike a foreign object, stop the engine. Remove wire from spark plug, thoroughly inspect the mower for any damage, and repair the damage before restarting and operating the mower. Extensive vibration of the mower during operation is an indication of damage. The unit should be promptly inspected and repaired.

## ADJUSTMENTS



### CAUTION

Do not at any time make any adjustment to lawn mower without first stopping engine and disconnecting spark plug wire.

### CUTTING HEIGHT ADJUSTMENT

Adjustment may be made by removing and moving axle bolts to desired position. Cutting heights will be raised as axle bolts are moved to a lower hole

and lowered as axle bolts are moved to a higher hole in the deck. All axle bolts must be mounted in the same relative position to the deck. Cupped side of belleville washers must be against the deck. See figures 15 and 16.

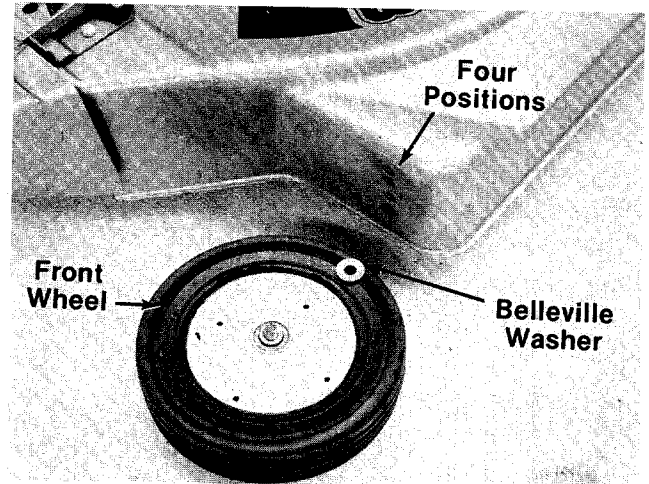

FIGURE 15.

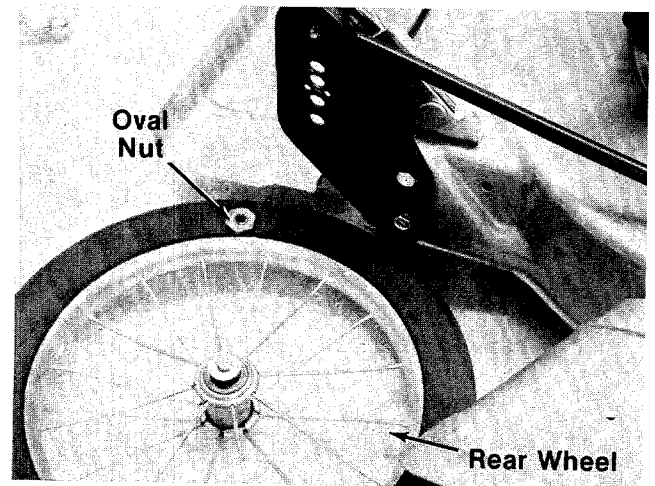

FIGURE 16.

### THROTTLE

If adjustment becomes necessary, the throttle control wire assembly can be reset as follows:

1. Loosen, but do not remove, screw securing throttle control wire assembly at engine. See figure 7.
2. Move throttle control lever on handle to "FAST" position.
3. Move control lever on engine to full open position. Retighten screw to secure throttle control wire assembly.

## CARBURETOR ADJUSTMENTS



If any adjustments are made to the engine while the engine is running (e.g. carburetor), keep clear of all moving parts. Be careful of heated surfaces and muffler.

Minor carburetor adjustment may be required to compensate for differences in fuel, temperature, altitude and load.

Refer to the separate engine manual packed with your mower for carburetor adjustment information.

## LUBRICATION



Always stop engine and disconnect spark plug wire before cleaning, lubricating or doing any kind of work on lawn mower.

**Blade Control**—Lubricate the pivot points on the blade control handle and the brake cable at least once a season with light oil. See figure 17. The blade control must operate freely in both directions.

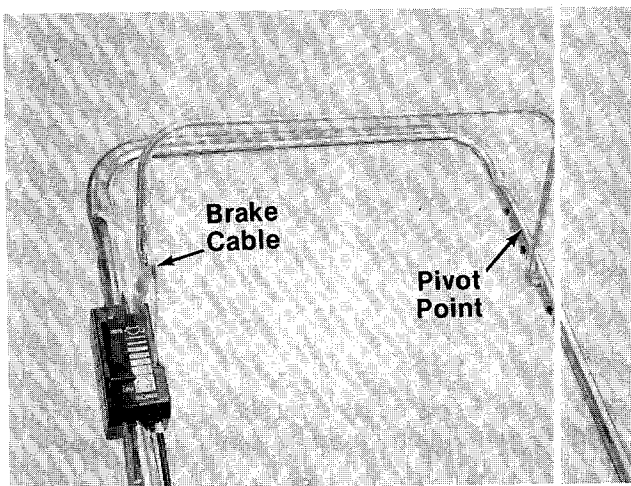

FIGURE 17.

**Chute Deflector**—The torsion spring and pivot point should be lubricated periodically with light oil to prevent any rust or binding. Deflector must work freely.

**Wheels**—Mower may be provided with ball bearing wheels. Lubricate at least once a season with light oil. Also, if the wheels are removed for any reason, lubricate the surface of the axle bolt and the inner surface of the wheel with light oil. A 4 oz. plastic bottle of light oil lubricant is available. Order part number 737-0170. Engine oil may also be used.

**Engine**—Follow engine manual for lubrication instructions.

**Throttle**—Periodically lubricate throttle control lever and throttle wire assembly with a few drops of light oil for ease of operation.

## MAINTENANCE



When tipping the unit, empty the fuel tank and keep engine spark plug side up.

### CUTTING BLADE

#### A. Removal for Sharpening or Replacement



Be sure to disconnect and ground the spark plug wire before working on the cutting blade to prevent accidental engine starting.

Remove the large bolt and lock washer which holds the blade and adapter to the engine crankshaft. See figure 18. Remove the blade and adapter from the crankshaft.

If the blade or blade adapter needs replacing, remove the two small bolts, lock washers and nuts which hold the blade to the adapter.

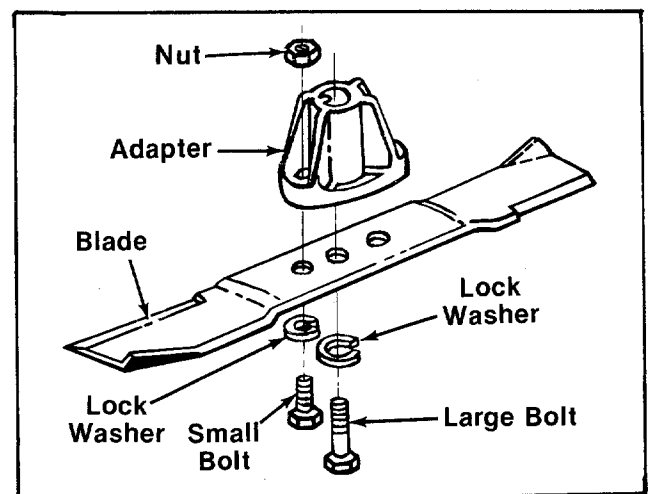

FIGURE 18.



## CAUTION

Periodically inspect the blade adapter for cracks, especially if you strike a foreign object. Replace when necessary.

### B. Sharpening

Remove the cutting blade by following the directions of the preceding section.

When sharpening the blade, follow the original angle of grind as a guide. It is **extremely important** that each cutting edge receives an equal amount of grinding to prevent an unbalanced blade. An unbalanced blade will cause excessive vibration when rotating at high speeds, may cause damage to the mower and could break, causing personal injury.

It is recommended that the blade always be removed from the adapter for the best test of balance. The blade can be tested by balancing it on a round shaft screwdriver. Remove metal from the heavy side until it balances evenly.

### C. Reassembly

Before reassembling the blade and the blade adapter to the unit, lubricate the engine crankshaft and the inner surface of the blade adapter with light oil. Lubricating the bolt holes, bolts and inner surface of the nuts with light oil is also recommended. A 4 oz. plastic bottle of light oil lubricant is available. Order part number 737-0170. Engine oil may also be used.

When replacing the blade, be sure to install the blade with the side of the blade marked "Bottom" (or with part number) facing the ground when the mower is in the operating position.

### Blade Mounting Torque

3/8" Dia. Bolt 375 in. lb. min., 450 in. lb. max.

5/16" Dia. Bolt 150 in. lb. min., 250 in. lb. max.

To insure safe operation of your unit, **all** nuts and bolts must be checked periodically for correct tightness.

### DECK

The underside of mower deck should be cleaned after each period of use as grass clippings, leaves, dirt and other matter will accumulate. This accumulation of grass clippings, etc., is undesirable as it will invite rust and corrosion and may cause an uneven discharge of grass clippings at the next cutting.

The deck may be cleaned by tilting the mower forward or on its side and scraping clean with a suitable tool or by washing with a stream of water from a garden hose.



## CAUTION

Do not direct the stream of water at a hot engine as damage to the engine may result.

### ENGINE OIL

Check oil level before starting engine and after every 5 hours of operation. ADD oil as necessary to keep level to full mark on dipstick. Before removing dipstick, clean area around dipstick to prevent dirt from entering oil fill tube. Engine should be in a level position when checking oil.

Change oil after first 5 hours of operation. Thereafter change every 25 hours. Change oil while engine is warm. Oil may be drained thru oil drain on bottom of the engine. Oil capacity 1-1/4 pints.

### AIR CLEANER

Service air cleaner every 25 hours under normal conditions. Clean every few hours under extremely dusty conditions. Poor engine performance and flooding usually indicates that the air cleaner should be serviced.

To service the air cleaner, refer to the separate engine manual packed with your unit.

### SPARK PLUG

The spark plug should be cleaned and the gap reset once a season. Spark plug replacement is recommended at the start of each mowing season; check engine manual for correct plug type and gap specifications.

## OFF-SEASON STORAGE

The following steps should be taken to prepare lawn mower for storage.

1. Clean and lubricate mower thoroughly as described in the lubrication instructions.
2. Refer to engine manual for correct engine storage instructions.
3. Coat mower's cutting blade with chassis grease to prevent rusting.
4. Store mower in a dry, clean area.

## HANDLE STORAGE

The handle may be placed in an upright position for storage.

Move hairpin cotters to outer hole on weld pins. See figure 2. Press outward on the bottom of the lower handle and push forward. The handle will lock in this position. See figure 19.

To place the handle in the operating position, remove the starter rope from the rope guide bolt.

Grasp the lower handle at the bottom, pull apart slightly and tip the handle backward. Place the cotter hairpins in the inner holes. With the spark plug wire disconnected and grounded, depress the blade control handle and pull the starter rope out from the engine. Slip the starter rope into the rope guide bolt.

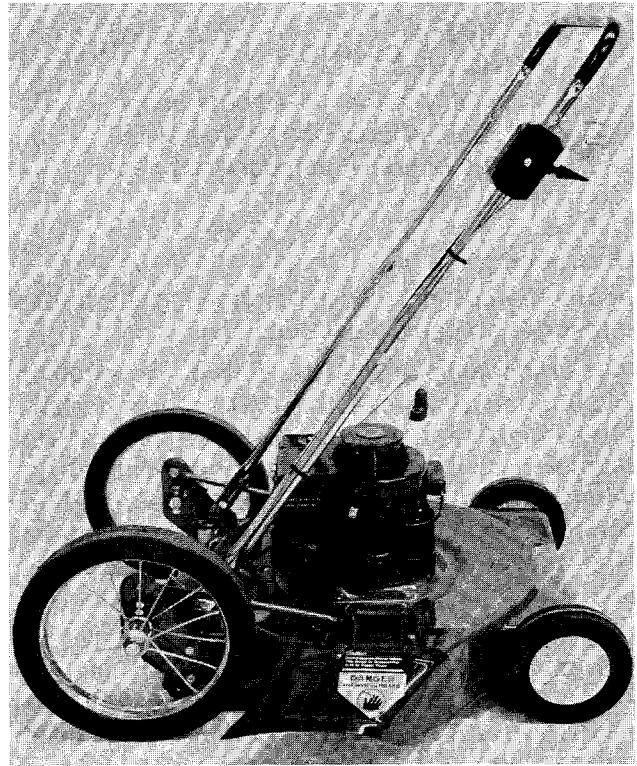

FIGURE 19.

 **NOTE**

The use of any accessory on this Rotary Mower other than those manufactured by the mower manufacturer is **not** recommended.

GRASS CATCHER Model 003 is available as optional equipment for the mower shown in this manual.



1. DO NOT operate the mower without the entire grass catcher or chute deflector in place.
2. DO NOT operate the mower without the protective shield on the rear of the deck in place.

 **NOTE**

Under normal usage bag material is subject to wear and should be checked periodically. Be sure any replacement bag complies with the mower manufacturer's recommendations.

For replacement bags, use only factory authorized replacement bag No. 764-0176.

# NOTES

A large, empty rectangular box with a black border, intended for taking notes. The interior of the box is completely blank.

# Model 500

Meets CPSC Blade Safety Requirements

Lot/Model

Mfg. Date

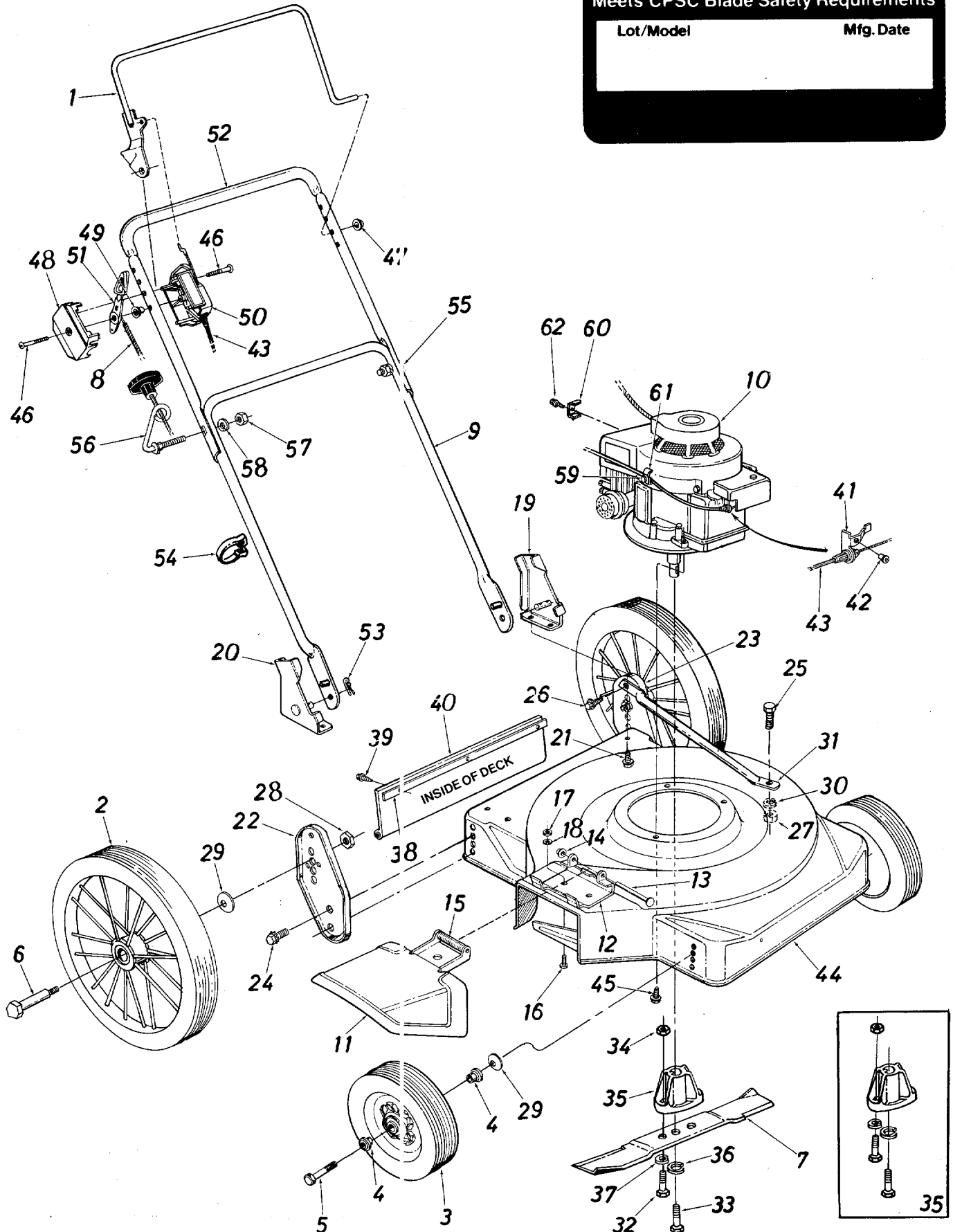



# Model 500

## PARTS LIST FOR MODEL 500 ROTARY MOWER

REF. NO.	PART NO.	COLOR CODE	DESCRIPTION	NEW PART	REF. NO.	PART NO.	COLOR CODE	DESCRIPTION	NEW PART
1	14320		Control Handle Ass'y.—R.H.	N	32	710-0117		Hex Bolt 5/16-24 x 1.00" Lg. (Grade 5)	
2	734-0244		Rear Wheel Ass'y.—Comp. 14.0 x 1.75		33	710-0331		Hex Bolt 3/8-24 x 2.25" Lg. (Grade 5)	
3	**		Front Wheel Ass'y.—Comp. 8.0 x 1.75		34	712-0123		Hex Nut 5/16-24 Thd.*	
4	**		Bearing		35	753-0348		Blade Adapter Kit	N
5	**		Axle Bolt—Front		36	736-0217		L-Wash. 3/8" I.D.—H.D.	
6	738-0481		Shoulder Bolt .50" Dia. x 2.62		37	736-0119		L-Wash. 5/16" I.D.*	
7	742-0125		22" Blade		38	14836		Retaining Strip	N
8	746-0417		Throttle Wire—43" Lg.		39	710-0776		Hex Wash. Hd. "AB"-Tap Scr. 1/4" x .62" Lg.	
9	749-0373		Lower Handle (Chrome)		40	731-0575		Rear Flap Ass'y.	
	749-0372		Lower Handle (Painted)		41	14924		Cable Bracket	N
10	—		Engine		42	728-0171		Pop Rivet .156 Dia. x .379	
11	11679	—462	Chute Deflector Ass'y. Comp.		43	746-0478		Control Cable—Brake	N
12	11130		Adapter Plate		44	14919	—462	22" Deck Ass'y.	
13	711-0555		Pivot Pin		45	710-0654		Hex Wash. Hd. TT-Tap Scr. 3/8-16 x 1.00" Lg.	
14	726-0106		Push Nut 1/4" Rod		46	710-0796		Truss Mach. "B"-Tap Scr. #12 x 1.50" Lg.	
15	732-0253		Torsion Spring		47	726-0135		Cap Speed Nut 5/16" Rod	
16	710-0289		Hex Bolt 1/4-20 x .50" Lg.*		48	731-0523		Control Panel Half	
17	712-0287		Hex Nut 1/4-20 Thd.*		49	731-0524		Control Disc Pin	
18	736-0329		L-Wash. 1/4" I.D.*		50	731-0526		Clutch Panel Half	N
19	12935		Handle Mount Brkt.—L.H.		51	731-0528		Throttle Control Lever	
20	12936		Handle Mount Brkt.—R.H.		52	749-0536		Upper Handle (Chrome)	N
21	710-0603		Hex Wash. Hd. "B" Tap Scr. 5/16-18 x .50" Lg.		53	749-0538		Upper Handle (Painted)	N
22	14068		Extension Brkt.—R.H.		54	714-0104		Intern. Cot. Pin 5/16" Dia.	
23	14069		Extension Brkt.—L.H.		55	726-0192		Cable Tie	
24	710-0209		Hex Sems Bolt 3/8-16 x .62" Lg.*		56	710-0671		Curved Carriage Bolt 5/16-18 x 1.38" Lg.	
25	710-0258		Hex Bolt 1/4-20 x .62" Lg.*		57	710-0842		Rope Guide Bolt	N
26	710-0603		Hex Wash. Hd. "B" Tap Scr. 5/16-18 x .50" Lg.		58	712-0267		Hex Nut 5/16-18 Thd.*	
27	712-0287		Hex Nut 1/4-20 Thd.*		59	736-0119		L-Wash. 5/16" I.D.*	
28	712-0297		Oval Nut 3/8-16 Thd.		60	710-0436		Hex B-Tap Scr. #10 x .62" Lg.	
29	736-0105		Bell-Wash. .400" I.D. x .88" O.D.		61	751-0333		Casing Clamp	N
30	736-0329		L-Wash. 1/4" I.D.*		62	12894		Casing Clamp	
31	749-0400		Stabilizing Strut			738-0873		Shld. Scr. #10 x .20 Dia.	N

\*For faster service obtain standard nuts, bolts, and washers locally. If these items cannot be obtained locally, order by part number and size as shown on parts list.

### \*\*FRONT WHEEL CHART

Type of Wheel	Part No.	Bearing Part No.	Axle Bolt
Plastic	734-0841	—	738-0213
Steel w/Fortiflex Bearings	734-0661	1/2" I.D.—741-0262 (2 per wheel)	738-0213
Steel w/Ball Bearings	734-0645	3/8" I.D.—741-0267, 1/2" I.D.—741-0484, Spacer—750-0434	710-0427

(462—Red Flake) When ordering parts if color or finish is important, use the appropriate color code shown at left. (e.g.—Red Flake Finish—14483 (462).)

**NOTE**  
This instruction manual covers various models and all specifications shown do not necessarily apply to your model. Specifications subject to change without notice or obligation.

NOTE: The engine is not under warranty by the mower manufacturer...If repairs or service is needed on the engine, please contact your nearest authorized engine service outlet. Check the "Yellow Pages" of your telephone book under "Engines—Gasoline."

**Find It Fast In The Yellow Pages**

# PARTS INFORMATION

## POWER EQUIPMENT PARTS AND SERVICE

Parts and service for all MTD manufactured power equipment are available through the authorized service firms listed below. All orders should specify the model number of your unit, part numbers, description of parts and the quantity of each part required.

## BRIGGS AND STRATTON, TECUMSEH AND PEERLESS PARTS AND SERVICE

Briggs & Stratton, Tecumseh and Peerless parts and service should be handled by your nearest authorized engine service firm. Check the yellow pages of your telephone directory under the listing **Engines—Gasoline**, Briggs & Stratton or Tecumseh Lauson.

**NOTE:** If any parts are found to be missing or defective upon assembly of this unit, write to advise the factory so that immediate replacement can be made.

<b>ALABAMA</b>	<b>BIRMINGHAM</b>	
Auto Electric & Carburetor Co. . . . .	2625 4th Ave. S. . . . .	35233
<b>ARKANSAS</b>	<b>NORTH LITTLE ROCK</b>	
Sutton's Lawn Mower Shop . . . . .	5301 Roundtop Drive Box 368, Rt. 4 . . . . .	72117
<b>CALIFORNIA</b>	<b>PORTERVILLE</b>	
Billious . . . . .	75 North D Street . . . . .	93257
<b>COLORADO</b>	<b>DENVER</b>	
Spitzer Industrial Products Co. . . . .	Box 29114, 6601 N. Washington St. . . . .	80229
<b>FLORIDA</b>	<b>JACKSONVILLE</b>	
Radco Distributors . . . . .	4909 Victor St. Box 5459 . . . . .	32207
	<b>OPA LOCKA</b>	
Small Eng. Dist. . . . .	2351 N.W. 147th St. . . . .	33054
<b>GEORGIA</b>	<b>EAST POINT</b>	
East Point Cycle & Key . . . . .	2834 Church St. . . . .	30344
<b>ILLINOIS</b>	<b>LYONS</b>	
Keen Edge Co. . . . .	8615 Ogden Ave. . . . .	60534
<b>INDIANA</b>	<b>ELKHART</b>	
Parts & Sales Inc. . . . .	2101 Industrial Pkwy. . . . .	46514
<b>IOWA</b>	<b>DUBUQUE</b>	
Power Lawn & Garden Equip. . . . .	2551 J.F. Kennedy . . . . .	52001
<b>LOUISIANA</b>	<b>MONROE</b>	
Mid-South Power . . . . .	700 Pine St. . . . .	71201
	<b>NEW ORLEANS</b>	
Suhren Engine Co. . . . .	8330 Earhart Blvd. . . . .	70118
<b>MARYLAND</b>	<b>TAKOMA PARK</b>	
Center Supply Co. . . . .	6867 New Hampshire Ave. . . . .	20912
<b>MASSACHUSETTS</b>	<b>SPRINGFIELD</b>	
Morton B. Collins Co. . . . .	300 Birnie Ave. . . . .	01107
<b>MICHIGAN</b>	<b>LANSING</b>	
Lorenz Service Co. . . . .	2500 S. Pennsylvania . . . . .	48910
	<b>MOUNT CLEMENS</b>	
Power Equipment Dist. . . . .	340 Hubbard . . . . .	48043
<b>MINNESOTA</b>	<b>HOPKINS</b>	
Hance Distributing Inc. . . . .	420 Excelsior Ave. W. . . . .	55343
<b>MISSISSIPPI</b>	<b>BILOXI</b>	
Biloxi Sales & Service, Inc. . . . .	506 Caillavet St. . . . .	39533
<b>MISSOURI</b>	<b>KANSAS CITY</b>	
Automotive Equip. Service . . . . .	3117 Holmes St. . . . .	64109
	<b>ST. JOSEPH</b>	
Ross-Frazier Supply Co. . . . .	8th and Monterey . . . . .	64503
	<b>ST. LOUIS</b>	
Henzler, Inc. . . . .	2015 Lemay Ferry Road . . . . .	63125
<b>NEW JERSEY</b>	<b>BELLMAWR</b>	
Lawnmower Parts Inc. . . . .	717 Creek Rd. . . . .	08030
<b>NEW MEXICO</b>	<b>ALBUQUERQUE</b>	
Spitzer Eng. & Parts . . . . .	1023 Third Ave. N.W. . . . .	87103
<b>NEW YORK</b>	<b>CARTHAGE</b>	
Gamble Dist., Inc. . . . .	West End Ave. . . . .	13619

<b>NORTH CAROLINA</b>	<b>GOLDSBORO</b>	
Smith Hardware Co. . . . .	515 N. George St. . . . .	27530
	<b>GREENSBORO</b>	
Dixie Sales Company . . . . .	335 N. Green . . . . .	27402
<b>OHIO</b>	<b>CARROLL</b>	
Stebe's Mid-State Mower Supply . . . . .	Box 366, 71 High St. . . . .	43112
	<b>CLEVELAND</b>	
Bleckrie, Inc. . . . .	7900 Lorain Ave. . . . .	44102
	<b>WADSWORTH</b>	
National Central . . . . .	687 Seville Rd. . . . .	44281
	<b>YOUNGSTOWN</b>	
Burton Supply Co. . . . .	1301 Logan Ave. Box 929 . . . . .	44501
<b>OKLAHOMA</b>	<b>MUSKOGEE</b>	
Victory Motors, Inc. . . . .	605 S. Cherokee . . . . .	74401
<b>OREGON</b>	<b>PORTLAND</b>	
Kenton Supply Co. . . . .	8216 N. Denver Ave. . . . .	97217
<b>PENNSYLVANIA</b>	<b>HARRISBURG</b>	
EECO Inc. . . . .	4021 N. 6th St. . . . .	17110
	<b>PHILADELPHIA</b>	
Thompson Rubber Co. . . . .	5222-24 N. Fifth St. . . . .	19120
	<b>PITTSBURGH</b>	
Bluemont Co. . . . .	11125 Frankstown Rd. . . . .	15235
	<b>PUNXSUTAWNEY</b>	
Frank Roberts & Sons . . . . .	R.D. 2 . . . . .	15767
<b>TENNESSEE</b>	<b>KNOXVILLE</b>	
Master Repair Service . . . . .	2000 Western Ave. . . . .	37921
	<b>MEMPHIS</b>	
American Sales & Service, Inc. . . . .	3035-43 Bellbrook . . . . .	38116
<b>TEXAS</b>	<b>DALLAS</b>	
Marr Brothers, Inc. . . . .	423 E. Jefferson . . . . .	75203
	<b>FORT WORTH</b>	
Woodson Sales Corp. . . . .	1702 N. Sylvania . . . . .	76111
	<b>HOUSTON</b>	
Bullard Supply Co. . . . .	2409 Commerce St. . . . .	77003
	<b>SAN ANTONIO</b>	
Engine House Inc. . . . .	8610 Botts Lane P.O. Box 17867 . . . . .	78217
<b>UTAH</b>	<b>SALT LAKE CITY</b>	
A-1 Engine & Mower Co. . . . .	439 E. 900 So. . . . .	84111
<b>VIRGINIA</b>	<b>ASHLAND</b>	
RBI Corp. . . . .	Lake Ridge Rd. 101 Cedar Run Dr. . . . .	23005
<b>WASHINGTON</b>	<b>SEATTLE</b>	
Bailey's Inc. . . . .	1414 14th Ave. . . . .	98122
<b>WISCONSIN</b>	<b>MARSHFIELD</b>	
Power Pac . . . . .	301 E. 29th St. . . . .	54449
	<b>APPLETON</b>	
Appleton Automotive Supply Co. . . . .	123 S. Linwood Ave. P.O. Box 798 . . . . .	54911
	<b>TWIN LAKES</b>	
E-K on Small Engine Spec. . . . .	122 Lance Dr. . . . .	53181

## WARRANTY PARTS AND SERVICE POLICY

(0782)

The purpose of warranty is to protect the customer from defects in workmanship and materials, defects which are NOT detected at the time of manufacture. It does not provide for the unlimited and unrestricted replacement of parts. Use and maintenance are the responsibility of the customer. The manufacturer cannot assume responsibility for conditions over which it has no control. Simply put, if it's the manufacturer's fault, it's the manufacturer's responsibility; if it's the customer's fault, it's the customer's responsibility.

### CLAIMS AGAINST THE MANUFACTURER'S WARRANTY INCLUDES:

1. Replacement of Missing Parts on new equipment.
2. Replacement of Defective Parts within the warranty period.
3. Repair of Defects within the warranty period.

All claims MUST be substantiated with the following information:

1. Model Number of unit involved.
2. Date unit was purchased or first put into service.
3. Date of failure.
4. Nature of failure.

## Free Manuals Download Website

<http://myh66.com>

<http://usermanuals.us>

<http://www.somanuals.com>

<http://www.4manuals.cc>

<http://www.manual-lib.com>

<http://www.404manual.com>

<http://www.luxmanual.com>

<http://aubethermostatmanual.com>

Golf course search by state

<http://golfingnear.com>

Email search by domain

<http://emailbydomain.com>

Auto manuals search

<http://auto.somanuals.com>

TV manuals search

<http://tv.somanuals.com>