

RAID Subsystem DVA-08K

DVA-08K SCSI Premium Series



BOSCH

en Installation Manual

Table of Contents

1	Warnings and Certifications	5
1.1	Warning	5
1.2	Safety Precautions	5
1.3	Certification	5
2	Introduction.	7
2.1	Product Overview	7
2.2	Enclosure Chassis	9
2.2.1	Chassis Overview	9
2.2.2	Physical Dimensions	9
2.2.3	Front Panel Overview	9
2.2.4	Hard Drive Numbering.	10
2.2.5	Rear Panel Overview	10
2.2.6	Backplane Board	11
2.3	Subsystem Components	12
2.3.1	LCD Panel	12
2.3.2	Drive Trays.	13
2.3.3	The RAID Controller Module	13
2.3.4	Battery Backup Unit	14
2.3.5	Power Supply Units	15
2.3.6	Cooling Fan Modules	15
2.4	Subsystem Monitoring.	17
2.4.1	I ² C Bus	17
2.4.2	LED Indicators.	17
2.4.3	Firmware and Bosch RAIDWatch GUI	17
2.4.4	Audible Alarms	17
2.5	Hot-Swappable Components.	18
2.5.1	Hot-Swap Capabilities.	18
2.5.2	Components	18
2.5.3	Normalized Airflow	18
3	Hardware Installation	19
3.1	Installation Prerequisites	19
3.2	Safety Precautions	20
3.2.1	Precautions and Instructions	20
3.2.2	Static-Free Installation	20
3.2.3	BBU Warnings and Precautions.	20
3.3	General Installation Procedure	22
3.3.1	Installation Procedure Flowchart	22
3.4	Unpacking the Subsystem.	22
3.5	Rackmounting	23
3.5.1	Considerations for Installation Site and Chassis	23
3.5.2	Mounting Holes Positions	23
3.6	Drive Tray Installation	24
4	Subsystem Monitoring.	26
4.1	Subsystem Monitoring Overview.	26
4.2	Status-indicating LEDs	27
4.2.1	Brief Overview of the LEDs	27
4.2.2	Drive Tray LEDs	28
4.2.3	Controller Module LEDs	28
4.2.4	Ethernet Port LEDs	29
4.2.5	BBU Module LED	30
4.2.6	PSU LED	30
4.2.7	LCD Keypad Panel.	30
4.2.8	Cooling Fan Module LED.	31
4.3	Audible Alarm	32
4.3.1	Default Threshold Values.	32
4.3.2	Failed Devices	33
4.4	I ² C Monitoring.	33

5	Subsystem Connection and Operation	34
5.1	Basic Configuration Rules	34
5.2	SCSI Connection Overview	35
5.2.1	SCSI Cables	35
5.2.2	SCSI Port on the Controller Rear Panel	35
5.2.3	SCSI Termination	36
5.3	Host Connection Topology	37
5.4	Power On	38
5.4.1	Power On Checklist	38
5.4.2	Power On Sequence	38
5.4.3	Power On Procedure	38
5.4.4	Power On Status Check	39
5.4.5	LCD Screen	39
5.5	Power Off Procedure	41
6	Subsystem Maintenance	42
6.1	Overview	42
6.1.1	General Notes on Component Replacement	42
6.2	Replacing Controller Module Components	43
6.2.1	Overview	43
6.2.2	Notes on Controller Module Maintenance	43
6.2.3	Removing the Controller Module	43
6.2.4	Replacing the Controller Module	44
6.3	Replacing or Upgrading Memory Modules	45
6.3.1	Memory Module Installation Overview	45
6.3.2	Selecting a Memory Module	45
6.3.3	DIMM Module Installation	45
6.4	Replacing a Faulty BBU	47
6.5	Replacing a Failed PSU Module	47
6.5.1	Notes on PSU Module Maintenance	47
6.5.2	Replacing the PSU Module	47
6.6	Replacing a Failed Cooling Fan Module	50
6.6.1	Notes on Cooling Fan Module Maintenance	50
6.6.2	Replacing a Cooling Fan Module	50
6.7	Drive Tray Maintenance	51
6.7.1	Notes on Hard Drive Maintenance	51
6.7.2	Replacing a Failed Hard Drive	51
7	Appendix: Technical Specifications	54
7.1	Controller Specifications	56
7.1.1	Configuration	56
7.1.2	Architecture	56
7.2	Drive Tray Specifications	57
7.3	Power Supply Specifications	57
7.4	Cooling Module Specifications	58
7.5	RAID Management	58
7.6	Fault Tolerance Management	59
8	Appendix: Spare Parts and Accessories	60
8.1	Spare Parts	60
8.1.1	Spare Parts Overview	60
8.1.2	Spare Parts List	60
8.1.3	Controller Modules	60
8.2	Accessories and Optional Items	61
9	Appendix: Pinouts	62
9.1	SCSI Port: VHDCI Connector Pinouts	62
9.2	COM1 Cable: DB9 and Audio Jack Pinouts	63
9.3	Null Modem	64
9.4	Ethernet Port Pinouts	64
9.5	Main Power	64
10	Index	65

1 Warnings and Certifications

1.1 Warning

A shielded power cord is required in order to meet FCC emission limits and also to prevent interference to nearby radio and television reception.

Use only shielded cables to connect I/O devices to this equipment. You are cautioned that changes or modifications not expressly approved by the party responsible for compliance could void your authority to operate the equipment.

1.2 Safety Precautions

Precautions and Instructions

- Prior to powering on the subsystem, ensure that the correct power range is being used.
- The RAID subsystems come with drive bays. Leaving any of these drive bays empty will seriously affect the efficiency of the airflow within the enclosure, and will consequently lead to the system overheating, which can cause irreparable damage.
- If a module fails, leave it in place until you have a replacement unit and you are ready to replace it.
- Airflow Consideration: The subsystem requires an airflow clearance, especially at the front and the rear side.
- Handle subsystem modules using the retention screws, extraction levers, and the metal frames/faceplates. Avoid touching PCB boards and connector pins.
- To comply with safety, emission, or thermal requirements, none of the covers or replaceable modules should be removed. Make sure that during operation, all enclosure modules and covers are securely in place.
- Be sure that the rack cabinet into which the subsystem chassis will be installed provides sufficient ventilation channels and airflow circulation around the subsystem.
- Provide a soft, clean surface to place your subsystem on before working on it. Servicing on a rough surface may damage the exterior of the chassis.
- If it is necessary to transport the subsystem, repackage all disk drives separately. If using the original package material, other replaceable modules can stay within the enclosure.

ESD Precautions

Observe all conventional anti-ESD methods while handling system modules. The use of a grounded wrist strap and an anti-static work pad are recommended. Avoid dust or debris in your work area.

1.3 Certification

FCC Class B Radio Frequency Interference Statement

FCC (applies in the U.S. and Canada)

This equipment has been tested and found to comply with the limits for a Class B digital device, pursuant to Part 15 of the FCC Rules (47 CFR, Part 2, Part 15 and CISPR PUB. 22 Class B). These limits are designed to provide reasonable protection against harmful interference when the equipment is operated in a residential installation. This equipment generates, uses, and can radiate radio frequency energy and, if not installed and used in accordance with this user's manual, may cause harmful interference to radio communications. However, there is no guarantee that interference will not occur in a particular installation. If this equipment does cause harmful interference to radio or television reception, which can be determined by

turning the equipment off and on, the user is encouraged to try to correct the interference by one or more of the following measures:

- Reorient or relocate the receiving antenna.
- Increase the separation between the equipment and receiver.
- Connect the equipment into an outlet on a circuit different from that to which the receiver is connected.
- Consult the dealer or an experienced radio/TV technician for help

This device complies with Part 15 of FCC Rules. Operation is subjected to the following two conditions: 1) this device may not cause harmful interference, and 2) this device must accept any interference received, including interference that may cause undesired operation.



This device is in conformity with the EMC.

CB (Certified Worldwide)

This device meets the requirements of the CB standard for electrical equipment with regard to establishing a satisfactory level of safety for persons using the device and for the area surrounding the apparatus. This standard covers only safety aspects of the above apparatus; it does not cover other matters, such as style or performance.

2 Introduction

This manual covers the DVA-08K series of RAID subsystems.

With its basic hardware redundancy and the capability of fast I/O transfer, the 2U RAID SATA subsystem is an ideal solution to meet the ever increasing demands for addition of storage capacity. Despite its ease of use, the subsystem does not compromise data protection for convenience. The subsystem's embedded firmware offers the same protection and maintenance functionalities as those designed for an enterprise-level RAID solution. The subsystems provide unprecedented configuration flexibility and allow for the customization of storage subsystems to meet specific demands. It is a rigorous and durable subsystem that can be easily configured and operated.

Fully featured RAID redundancy (which provides advanced data protection) ensures that the complete range of RAID levels (RAID 0, 1(0+1), 3, 5, 10, 30 and 50) is supported by the controller head. A long list of sophisticated firmware functions (dedicated/global hot-spares, battery protected disk cache, configurable reaction schemes against drive errors, remote and real-time array monitoring, and more) further guarantees the overall availability of valuable data.

IT managers using the RAID subsystems will be able to rapidly develop a comprehensive storage array. And the modular nature of the subsystem minimizes the maintenance effort to use the RAID appliance.

2.1 Product Overview

The subsystem comes with two (2) SCSI-320 host channels interfaced through four (4) VHDCI 68-pin SCSI ports. The subsystem comes in a 2U-profile rack-mountable chassis which houses a RAID controller module featuring complete RAID configuration and data protection functionality. The subsystem's operation is protected by redundant, hot-swappable power supplies and cooling fan modules. Designed for a high level availability, all major components are hot-replaceable including its Li-ION battery and the RAID-protected disk drives.

The subsystem supports high-density array capacity by its eight drive bays for SATA-II interface disk drives. The subsystem facilitates large I/O transfer, over its dual PCI-X buses architecture, and transmission of block I/Os over flexible caching and a dedicated XOR engine. The subsystem is ideal for direct-attached data storage, backup, and retrieval. It combines the capabilities and block-level performance of RAID storage with the reliable SCSI transfer technologies.

Configured arrays are easily combined with multiple ID/LUNs that appear to the host ports, turning massive capacity into manageable units for data-sharing in a heterogeneous environment.

The RAID 2U-profile, SCSI-to-SATA RAID storage comes in two different models. The only difference between the two models is the number of SATA-II drive bays.

SCSI Host Ports

Connectivity: The subsystem features a 320MB/s bandwidth from each of its SCSI host channels. The dual-stack VHDCI connectors on the rear panel facilitate the connection to multiple host computers and combining the storage capacities of multiple RAID subsystems. Its backward compatibility with older SCSI protocols requires minimum investment for upgrading equipment. Storage volumes are associated with SCSI ID/LUNs on the host channels. The subsystem firmware provides flexible configurations of storage volumes which include, logical drives in supported RAID 0, 1 (0+1), 3, and 5 levels, logical volumes that consist of one or more logical drives, and the logical partitions of the previously mentioned configurations. These volumes then appear as SCSI targets over the host links.

Channels: The SCSI ID/LUN mapping method enables users to associate a storage volume with multiple IDs or LUNs on the host channels. The mapping method can easily cope with host-side configurations such as clustered servers or high availability path redundancy. On the drive side, all of the eight (8) SATA-II drives are connected each through a dedicated SATA channel. Each drive channel is routed to an enclosure drive tray that is equipped with a standard SATA connector with hot-swap capability. The methods used for assembling physical drives, fault management, and status monitoring are identical to that used with Bosch's long line of RAID storage enclosures.

Active Components

The subsystem comes with:

- A single RAID controller module
- Two redundant, hot-swappable cooling modules
- Dual redundant, hot-swappable, load-sharing power supplies
- A module slot for a Li-ION battery module.
- The front section of the enclosure houses eight (8) hot-swap drive bays for SATA-II or backward compatible with SATA-I hard disk drives.

The subsystem is shown below:



Fig. 2.1 8-bay SATA RAID Subsystem



NOTICE!

On receiving and unpacking your subsystem, please check the package contents against the included unpacking checklist. If any modules appear to be missing, please contact your subsystem vendor immediately.

2.2 Enclosure Chassis

2.2.1 Chassis Overview

The RAID subsystem comes in a 2U metal chassis. A backplane board divides the enclosure internally into front and rear sections. The front section accommodates eight (8) drive trays (with their associated hard drives) and the rear section accommodates two (2) PSU modules, two (2) single-fan cooling modules, and a single RAID controller module. The two (2) forearm handles on the front of the subsystem enable you to easily insert/extract the chassis into/from a rack or cabinet. Pre-drilled mounting holes on the sides of the chassis allow you to attach separately purchased slide rails.

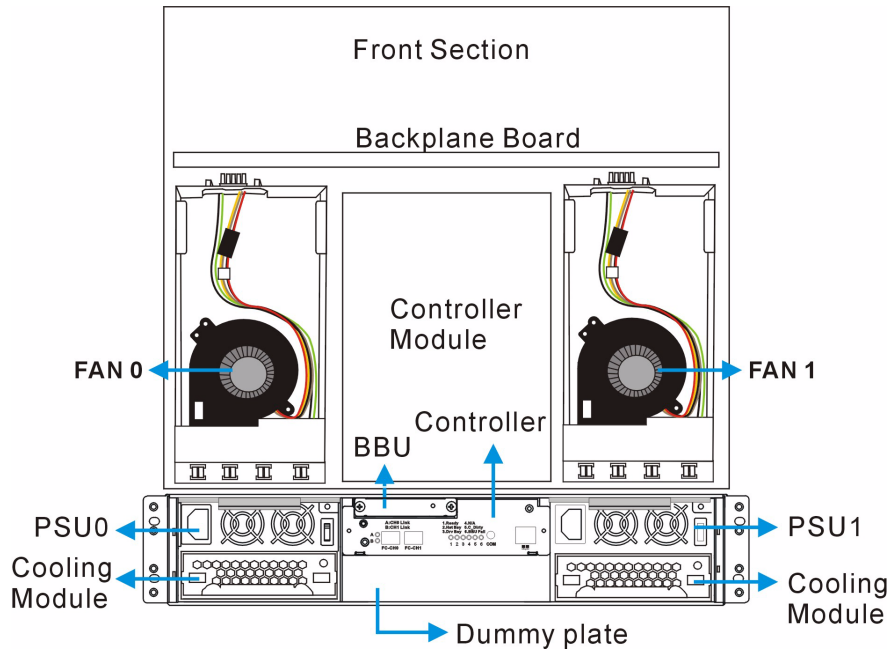

Fig. 2.2 Top View of the RAID subsystem

CAUTION!

When working with the subsystem, it is important to use tools with extreme care. Do not place tools or other items on top of the enclosure to help avoid damaging the chassis finish.

2.2.2 Physical Dimensions

The subsystem comes in a standard 2U, 19" chassis with the following dimensions:

- Measured with forearm handles: 482mm x 88mm x 505mm (width x height x depth)
- Measured without forearm handles: 446mm x 88mm x 490mm (width x height x depth)

2.2.3 Front Panel Overview

The front section of the subsystem features a 4 x 2 layout for eight (8) 3.5-inch disk drives and a foldable LCD keypad panel. The front panels of the RAID subsystems described in this manual are shown in *Figure 2.3*. A description of the front panel component is given below:

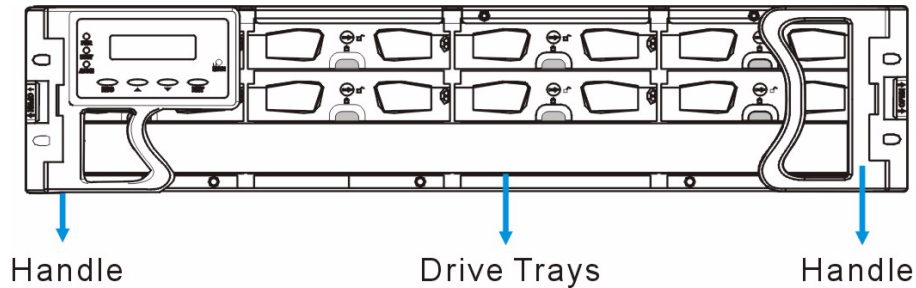

Fig. 2.3 Front View

The front panel is designed to accommodate the following components:

- Forearm handles with an LCD keypad panel: The LCD Panel mounted on the left handle shows system information and provides local access to the firmware-embedded configuration and monitoring utility.
- Drive bays with drive tray canisters: The drive bays are used to house the subsystem hard drives. The DVA-08K contains 8 drive bays with a blank plate covering the lower part of the front panel.

2.2.4

Hard Drive Numbering

The subsystem is housed in an enclosure that is 4 bays wide and 2 bays high. When viewed from the front, drive bays (slots) are numbered 1 to 8, from the left to the right, and then from the top to the bottom.

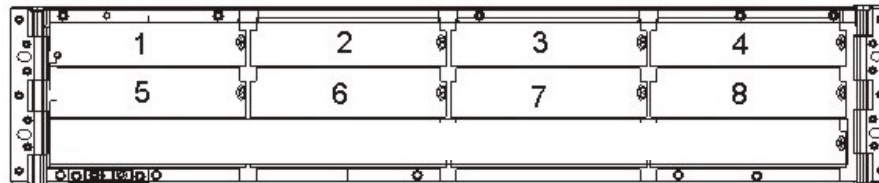

Fig. 2.4 Drive Bays Numbering Sequence

2.2.5

Rear Panel Overview

The rear section of the subsystems are accessed through the rear panel and is reserved for a single RAID controller module, one (1) battery backup unit (BBU), two (2) power supply units (PSUs), and two cooling fan modules.

The subsystem rear view is shown in *Figure 2.5*. A description of the rear panel component is given in the preceding discussions:

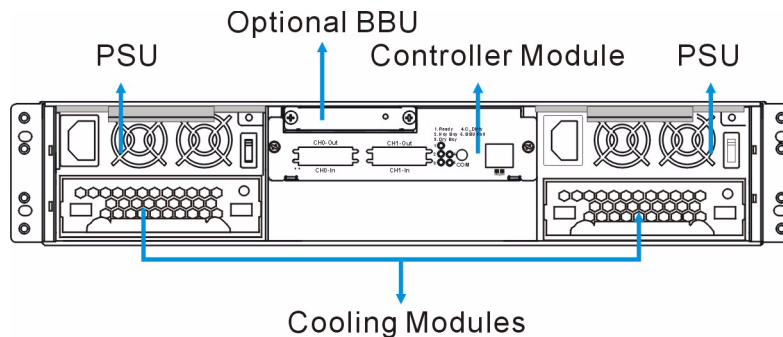

Fig. 2.5 Rear View

The rear panel shown above is designed to accommodate the following components:

- RAID controller module: The controller module contains a controller main board and a pre-installed DDR DIMM module.
- Power Supply Unit (PSU): The PSU is used to provide power to the subsystem.

- **BBU module:** A BBU provides the protective implementation to cached data; and, unless deselected when purchasing the subsystems, is installed into the module slot located at the upper left corner of the controller module.
- **Cooling fan module:** The redundant cooling fan module is used to ventilate the subsystem and to reduce the temperature within the subsystem.



NOTICE!

Each of the power supplies on the sides of the enclosure houses one cooling fan module in a removeable canister. When a power supply is removed, the cooling module is also removed. Therefore, replace the power supply unit as soon as possible whenever it becomes necessary. Cooling fan modules can be independently removed from the chassis without affecting PSU operation.

2.2.6

Backplane Board

An integrated backplane board separates the front and rear sections of the subsystem. The PCB board provides traces for logic level signal traces and low voltage power paths. It contains no user-serviceable components.

2.3 Subsystem Components

All the active components on the subsystem can be accessed through either the front or rear panel. The modular design of the active components facilitates their easy installation and removal. Hot-swap mechanisms are incorporated to eliminate power surges and signal glitches that might occur while removing or installing these modules.

2.3.1 LCD Panel

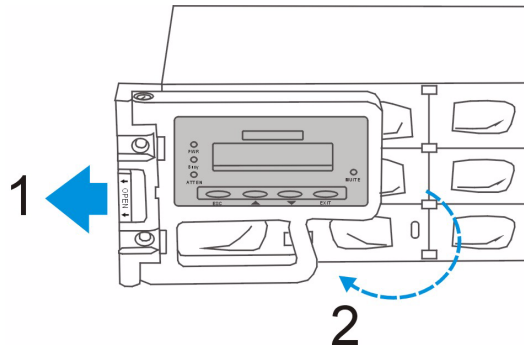

Fig. 2.6 Opening the Front Handle

The LCD panel shown in *Figure 2.6* consists of a 16 characters x 2 rows LCD screen with push buttons, a mute button, and LED status indicators. The LCD front panel provides full access to all array configurations and monitoring. After powering up the subsystem, the initial screen will show the subsystem model name. A different name can be manually assigned to the subsystem or different drive arrays. This will enable easier identification in a topology consisting of numerous arrays.

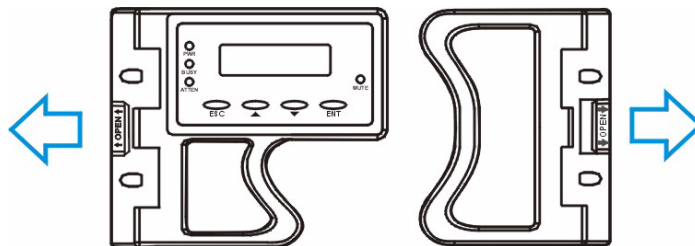

Fig. 2.7 Front Panel Retention Latch

To access drive bays in the left- or right-hand side column, first flip the retention latches (see *Figure 2.7*) on the enclosure front handles, and then swing the handles to the left- and right-hand sides. To close the handles (see *Figure 2.8*), swing the handles toward the system; gently press the handles until a click is heard. The latches will keep the handles in place.

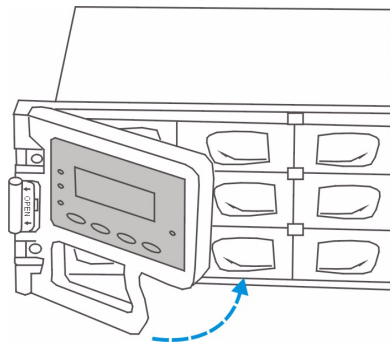

Fig. 2.8 Closing the Front Handles

2.3.2

Drive Trays

The subsystem comes with 8 drive trays (see *Figure 2.9*) designed to accommodate separately purchased standard 1-inch pitch, 3.5-inch disk drives. The drive bays are accessed from the enclosure front. Two LED's on the front of the tray are used to indicate the drive status. A key-lock on each drive tray secures the hard drive in place, while an easily accessible release button ensures fast and efficient drive hot-swapping.

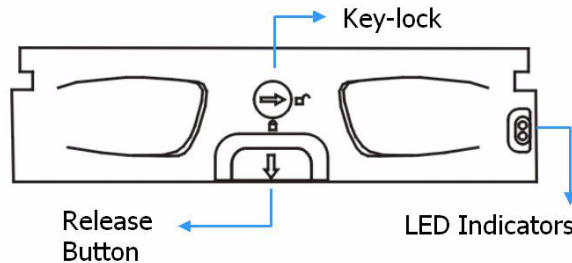

Fig. 2.9 Drive Tray Front View

CAUTION!

Be careful not to warp, twist, or contort the drive tray in any way (e.g., by dropping it or resting heavy objects on it). The drive tray has been customized to fit into the drive bays in the subsystem. If the drive bay superstructure is deformed or altered, the drive trays may not fit into the drive bay.

2.3.3

The RAID Controller Module

The RAID controller module contains a main circuit board, a preinstalled 256MB capacity or above DDR RAM DIMM module, and the necessary support interfaces. The controller module contains no user-serviceable components. Except when replacing a faulty unit or installing/upgrading the cache memory inside, the controller module should never be removed or opened.

CAUTION!

Although the RAID controller can be removed, the only time you should touch the controller itself is to replace the memory module or to install the memory module. The RAID controller is built of sensitive components and unnecessary tampering can damage the controller.

Controller Module Interfaces

The subsystems provide external interfaces to host computers and management station(s) through the RAID controller's rear-side faceplate as shown in *Figure 2.10*.

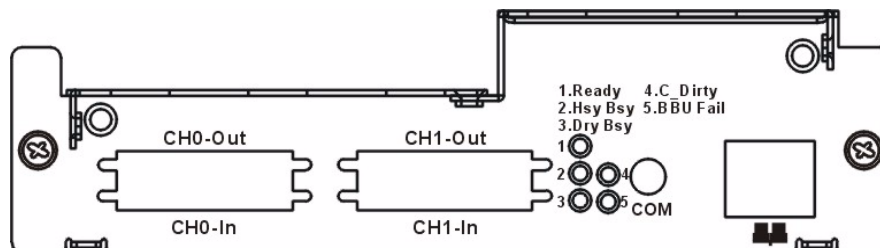

Fig. 2.10 Controller Module Faceplate

- **Host Ports**
SCSI-320 Host Ports: Two SCSI-320 host channels connect the subsystem to the host computers equipped with SCSI-320 compatible adapters through the dual-stack VHDCI connectors. The dual-stack connectors facilitate cascade connections for configurations such as host clustering or cascading with another RAID subsystem.

**NOTICE!**

This subsystems come with preset configurations for channel mode and channel ID settings, and should be sufficient for most applications.

- **Ethernet Port**
All controller modules on the subsystems come with a single 10/100BasedT RJ-45 Ethernet port. The Ethernet port is used for local or remote management through the network using the Bosch RAIDWatch GUI manager or Telnet protocol.
- **COM Port**
All controller modules come with one RS-232C (audio jack) serial port. The serial port is used for local access to the system-embedded configuration utility over the included serial port cable.

DIMM Module

The controller module comes with a preinstalled 256MB capacity or above DDR RAM DIMM module and can support a larger capacity up to 2GB. The DIMM module is mounted in an easily accessible location on the controller board. However, when the DIMM module is being changed, the controller module must be removed from the subsystem chassis.

2.3.4**Battery Backup Unit**

The Li-ION battery backup unit (BBU) module sustains cache memory for days after a power failure. It is installed on the upper left corner of the controller module in the rear of subsystem chassis. Please refer to *Section 3 Hardware Installation* for installation details.

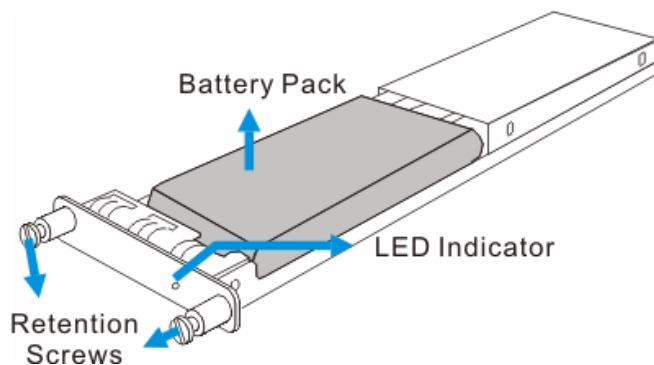

Fig. 2.11 BBU Module

In accordance with international transportation regulations, the BBU module is only charged to between 35% and 45% of its total capacity when shipped. Therefore, when powering on the subsystem for the first time the BBU will begin to charge its batteries to their full capacity. It normally requires approximately twelve (12) hours for the battery to be fully charged. If the battery is not fully charged after twelve (12) hours (its LED is still flashing), there is a problem with the BBU module and you should contact your subsystem vendor immediately. While the battery is being charged, the LED on the BBU rear panel and the fifth LED on the controller module will flash.

You can check the status of the battery's charge via Bosch RAIDWatch Manager or the firmware utility screen.

2.3.5 Power Supply Units

The SATA-based RAID subsystems are equipped with two (2) redundant, hot-swappable, 2U, 350W power supply unit (PSUs) modules. The PSU is permanently mounted into a 2U high (dual-level) bracket especially designed to house both the PSU and a cooling module mounted underneath. PSUs can be found on either side of the controller module.

Each PSU comes with a single power socket for power cord plug-in and a single power switch for you to turn the PSU on and off. Each PSU also comes with two embedded cooling fans to provide sufficient airflow to keep the PSU cool. A single LED is used to indicate the PSU status. A handle at the back of the PSU has been especially designed to enable you to remove the PSU from the subsystem while the system is still online. This should only be done if the PSU has failed and needs to be replaced.

NOTICE!

Hot-swapping the PSU also removes the cooling module at the lower slot.

A retention screw at the upper right corner of the PSU module is used to secure the PSU to the enclosure. If the PSU needs to be removed, the retention screw must be removed first. When installing a new PSU module, make sure that the retention screw has been firmly secured.

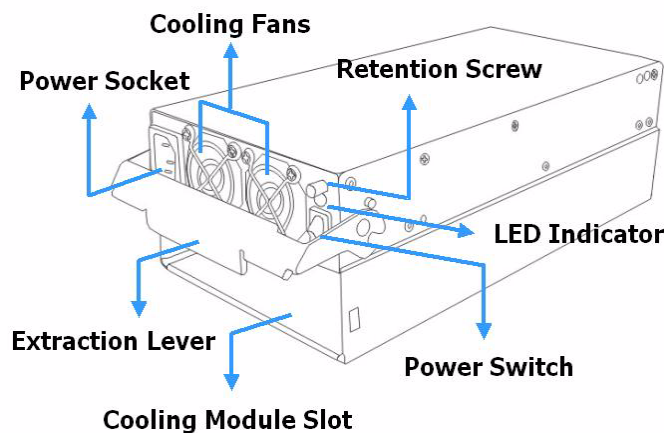

Fig. 2.12 PSU Module

2.3.6 Cooling Fan Modules

The SATA-based RAID subsystem is equipped with two 1U single-fan, redundant, hot-swappable cooling modules shown in *Figure 2.13*. One 9.7cm fan is housed in each cooling module. These modules have been designed to generate a cooling flow from the front to the rear of the subsystem to extract the heat generated by the SATA hard drives. Two of the cooling fan modules are installed directly beneath the PSUs.

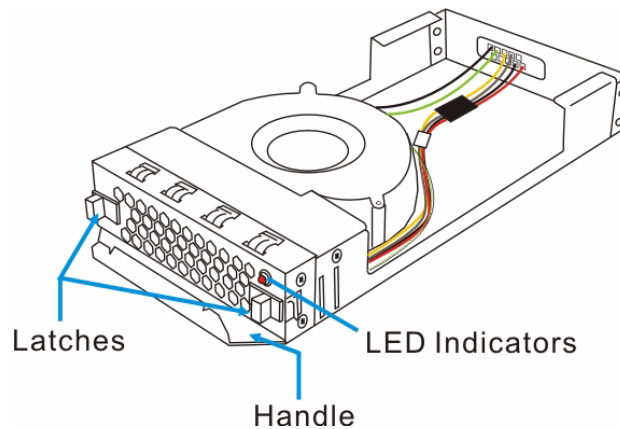

Fig. 2.13 Top View of a Cooling Fan Module

Advanced Fault-Preventative Operation

The cooling fan modules support dual-speed operation modes that help to protect the subsystem in the event of component failure or extreme working condition.

Intelligent Dual Speed Operation

The cooling fans operate with two rotation speeds. Under normal operating conditions, the cooling fans run at the low speed, which is sufficient for maintaining efficient airflow across components. Under the following conditions, cooling fans raise their rotation speed to increase the airflow:

1. Component Failure: if another cooling fan module, a PSU, or a temperature sensor fails, the remaining cooling fan(s) automatically raises its rotation speed.
2. Elevated Temperature: if the temperature breaches the upper threshold set for any of the interior temperature sensors, the cooling fans automatically raises its rotation speed.
3. During the subsystem initialization stage, the cooling fans operate at the high speed and return to lower speed once the initialization process is completed and no erroneous condition is detected.



NOTICE!

There are two values set for the upper temperature thresholds. One is set for event notification and the other triggering higher fan rotation speed. The preset value for event notification can be changed using the firmware-embedded configuration utility, while the fan speed trigger is not a user's option.

2.4 Subsystem Monitoring

The SATA-based RAID subsystem comes with a number of different monitoring methods that provide you with continual updates on the status of the system and individual components. The following monitoring features are included in the subsystem.

2.4.1 I²C Bus

The following subsystem elements are interfaced to the RAID controller over a non-user-serviceable I²C bus:

- Cooling fan modules
- PSUs
- Temperature sensors

2.4.2 LED Indicators

The following active components come with LEDs to indicate the status of the individual components:

- RAID controller
- LCD panel
- Cooling fan module
- PSU module
- BBU module
- Drive trays

2.4.3 Firmware and Bosch RAIDWatch GUI

Firmware: The firmware is pre-installed software that is used to configure the subsystem. The firmware can be accessed either through the LCD keypad panel or a terminal emulation program running on a management computer that is connected to the subsystem's serial port.

Bosch RAIDWatch: Bosch RAIDWatch is a premier Web-based graphical user interface (GUI) that can be installed on a remote computer and is used to access the array through LAN or the Internet. The manager communicates with the array via the connection of the existing host interface or Ethernet link to the RJ-45 LAN port.

2.4.4 Audible Alarms

The subsystems come with audible alarms that are triggered when certain active components fail or when certain (controller or subsystem) thresholds are exceeded. If you hear hastily repeated beep tones from the subsystems it is imperative that you immediately determine and rectify the problem.

Event notification messages indicate the completion of or the condition when proceeding with array configuration tasks and are always accompanied by two or three successive and prolonged beeps.

CAUTION!

Failing to respond when a critical alarm is heard can lead to permanent damage of the subsystem. When an audible alarm is heard, rectify the problem as soon as possible.

2.5 Hot-Swappable Components

2.5.1 Hot-Swap Capabilities

The subsystem comes with a number of hot-swappable components. A hot-swap component is one that can be exchanged while the subsystem is still online without affecting the operational integrity of the subsystem. These components should only be removed from the subsystem when they are being replaced. At no other time should these components be removed from the subsystem.

2.5.2 Components

The following components are all hot-swappable:

- Power supply units (PSUs)
- Cooling fan modules
- Hard drives
- BBU module

2.5.3 Normalized Airflow

Proper subsystem cooling is referred to as “normalized” airflow. Normalized airflow ensures the sufficient cooling of the subsystem and is only attained when all components are properly installed. Therefore, a failed component should only be hot-swapped when a replacement is available. If a failed component is removed but not replaced, permanent damage to the subsystem can result.

3 Hardware Installation

This chapter gives detailed instructions on how to install the subsystem. When installing the subsystem, it is necessary to mount the chassis into a rack or cabinet and to install hard drives and drive trays. Installation into a rack or cabinet should occur before the hard drives or drive trays are installed into the subsystem. Please confirm that you received all of the components listed on the Unpacking List that came with the subsystem before proceeding with the installation process.

CAUTION!

Please note that the installation instructions described in this chapter should be carefully followed to prevent any difficulties and damages to your system.

3.1 Installation Prerequisites

- **Static free installation environment:** The subsystems must be installed in a static-free environment to minimize the possibility of electrostatic discharge (ESD) damage. (See *Section 1 Warnings and Certifications*).
- **Component check:** Before installing the subsystems, you should first check to see that you have received all the required components. If any items appear damaged, contact your vendor for a replacement.
- **Hard drives:** Hard drives must be purchased separately prior to the subsystem installation.
- **Cabling:**
 - The subsystems requires an external VHDCI-to-VHDCI SCSI round cable to connect the subsystem to a host computer.
 - One (1) audio-jack-to-DB9 cable is provided to facilitate the connection of the COM1 port for local terminal emulation access to the array.
 - Two (2) power cords are provided for the power connections to the power sources.
 - The RJ-45 Ethernet cable for network management connection is a user-supplied item.
- **Memory module:** If you wish to change the pre-installed memory module, a separately purchased module must be installed. Please contact your vendor for a different memory module or consult the list of compatible modules.
- **Rack installation:** The enclosure chassis can be installed into a rack cabinet using self-purchased mounting rails. A printed copy of installation guide is provided with the slide rails package.

3.2 Safety Precautions

3.2.1 Precautions and Instructions

- Be sure the correct power range (100-120 or 220-240VAC) is supplied by your rack cabinet, UPS device, or power outlet.
- Thermal notice: All drive trays (even if they do not contain a hard drive) must be installed into the enclosure. Leaving a drive bay or module slot open will severely affect the airflow efficiency within the enclosure, and will consequently lead to system overheating. Keep a faulty module in place until you have a replacement unit and you are ready to replace it.
- An enclosure without disk drives can weigh over 25 kilograms. Two (2) people are required to install or relocate the subsystem. To avoid damage to disk drives, drives should be removed from the enclosure before moving the subsystem.
- Handle the system modules by the retention screws, extraction levers, or the modules metal frames/faceplates only. Avoid touching the PCB boards, connector pins, and soldered surfaces.
- Airflow considerations: The subsystem requires an airflow clearance especially on the front and rear. For proper ventilation, a minimum of 2.5cm is required between the front of the enclosure and rack cover; a minimum of 5cm is required between the enclosure and end of the rack.
- None of the covers or replaceable modules should be removed in order to maintain compliance with safety, emission, or thermal requirements.
- Always secure every enclosure module by its retaining screws or make sure it is held in place by its latches.
- Always make sure the subsystem has a safe electrical earth connection via power cords or chassis ground by the rack cabinet.
- Be sure that the rack cabinet in which the subsystem chassis is to be installed provides sufficient ventilation channels and airflow circulation around the subsystem.
- Provide a soft, clean surface to place your enclosure on before working on it. Servicing the enclosure on a rough surface may damage the finish of the chassis.
- If it is necessary to transport the subsystem, repackage all disk drives separately. If using the original package material, all other modules can stay within the enclosure.

3.2.2 Static-Free Installation

The subsystem contains static-sensitive electronic components that can be damaged by improper handling and electrostatic discharge (ESD). To prevent ESD damage to any of the components, follow these precautions before touching or handling them:

- Discharge the static electricity from your body by wearing an anti-static wristband or by touching a grounded metal surface.
- Avoid carpets, plastic, vinyl, and styrofoam in your work area.
- Handle all components by holding their edges or metal frame. Avoid touching PCB boards and connector pins.

3.2.3 BBU Warnings and Precautions

The BBU module sustains cache memory in the event of a power failure or in the unlikely event if both PSUs have failed. Having the protection to cached data by a BBU is highly recommended. The BBU provides additional data security and helps minimize the chance of data loss during power outage.

- Replace the BBU once it shows symptoms failing to hold the charge. Although the life expectancy of a BBU is determined by the times it has been charged or discharged, a BBU can approximately last for one year. If the battery recharge time is obviously longer than the suggested 12 hours, or if the fault LED is lit, replace the battery.

- Install or replace the BBU module only with a BBU module supplied by your subsystem vendor. Use of battery cells provided by another source will void our warranty.
- Always dispose of discharged or used batteries in an ecologically responsible manner. Dispose used BBUs at authorized battery disposal sites only.
- Do not use nor leave the BBU near a heat source or direct sunlight. Heat can melt the insulation and damage other safety features of battery cells, possibly leading it to acid leak and result in flames or explosion.
- Do not immerse the BBU in water nor allow it to get wet. Its protective features can be damaged. Abnormal chemical reactions may occur, possibly causing functional defects, acid leak, and other hazardous results.
- Do not disassemble or modify the BBU. If disassembled, the BBU could leak acid, over-heat, emit smoke, burst and/or ignite.
- Do not pierce the BBU with a sharp object, strike it with a hammer, step on it, or throw it. These actions could damage or deform it, internal short-circuiting can occur, possibly causing functional defects, acid leaks, and other hazardous results.
- If the BBU leaks, gives off a bad odor, generates heat, becomes discolored or deformed, or in any way appears abnormal during use, recharging or storage, immediately remove it from the subsystem and stop using it. If this is discovered when you first use the BBU, return it to Bosch or your system vendor.

3.3 General Installation Procedure

The following instructions can save installation time. Detailed, illustrated instructions for each component are given in the following sections.

CAUTION!

To ensure that your system is correctly installed, please follow the steps outlined below. If you follow these steps, installation will be fast and efficient. If you do not follow these steps, you may have incorrectly installed the hardware.

1. **Unpack:** Unpack the subsystem and confirm that all the components on the Unpacking Checklist have been included.
2. **Rack/Cabinet installation:** If the subsystem is going to be installed in a rack or cabinet, it should be installed prior to installing the hard drives. Installing the subsystem into a rack or cabinet requires at least two (2) people.
3. **Install drive trays:** After the hard drives have been installed into the drive trays, the drive trays must be installed into the enclosure itself. (See *Section 3.6 Drive Tray Installation*)
4. **Cable connection:** Use the power cords that came with the subsystem to connect the subsystem to the main power source. Use self-purchased SCSI cable to connect host ports to servers.
5. **Power up:** Once the components have been properly installed and all cables are properly connected, you can power up the subsystem and configure the RAID array. (See *Section 5.4 Power On*)

3.3.1 Installation Procedure Flowchart

Table 3.1 shows a flowchart of the installation procedure. As you complete each step, check off the “Done” box on the right. Please use this flowchart in conjunction with the instructions that follow.

Step	Installation Procedure	Done	
1	Unpack	<input type="checkbox"/>	See <i>Section 3.4 Unpacking the Subsystem</i>
3	Rack/Cabinet Installation	<input type="checkbox"/>	See <i>Section 3.5 Rackmounting</i>
5	Drive Tray Installation	<input type="checkbox"/>	See <i>Section 3.6 Drive Tray Installation</i>
6	Cable Connection	<input type="checkbox"/>	
7	Power On	<input type="checkbox"/>	See <i>Section 5.4 Power On</i>

Table 3.1 Installation Procedure Flowchart

3.4 Unpacking the Subsystem

Use the unpacking checklist in your package to check packing contents. Carefully check the items contained in each box before proceeding with installation.



NOTICE!

A detailed packing list can be found in your product shipping package or product CD.

3.5 Rackmounting

The subsystem is easily installed into a standard 19-inch rack cabinet using the mounting holes on the sides of chassis.

The enclosure chassis can be installed using self-purchased mounting rails.

3.5.1 Considerations for Installation Site and Chassis

- Make sure you have an appropriate site location and cables prepared with adequate lengths to connect to main power and other devices.
- At least two people will be required to install the chassis. Disk drives should only be installed after the chassis is properly mounted. The chassis can weigh about 24Kgs without disk drives.
- The following tools are necessary for mounting the chassis:
 - #4 Phillips-head screwdriver
 - Wrenches may be necessary, depending on the rack type
- Use the included M5 or M6 screws for securing the chassis through its front mounting ears.
- More details about the use of optional slide rails are given in the Installation Guide that came with the slide rail package.

3.5.2 Mounting Holes Positions

- Integrators may design their own brackets or slide rails using the twenty-two (22) mounting holes on the sides of chassis.
- There are six (6) mounting holes with six (6) M4 nuts near the end of the chassis on each side. Shown below are the locations of these mounting holes. (See the arrow marks in *Figure 3.2*). See the next diagram for another group of mounting holes on a horizontal line.

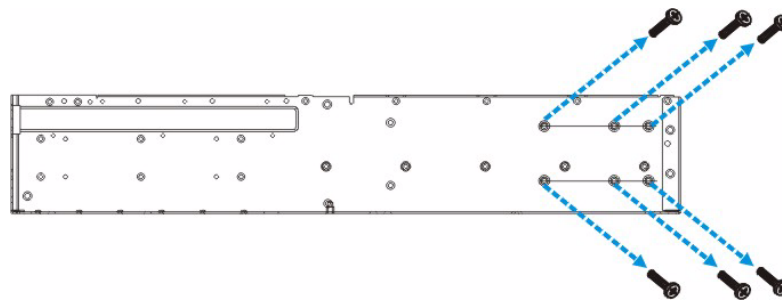

Fig. 3.1 Enclosure Side Mounting Holes (1)

- *Figure 3.2* shows holes that are designed for slide rail options. There are five (5) mounting holes for #6-32 screws on the sides of the enclosure for use with slide rails purchased separately from Bosch or other vendors.
- For information on installing the chassis using the slide rails, please refer to the Installation Manual that came with the kit.

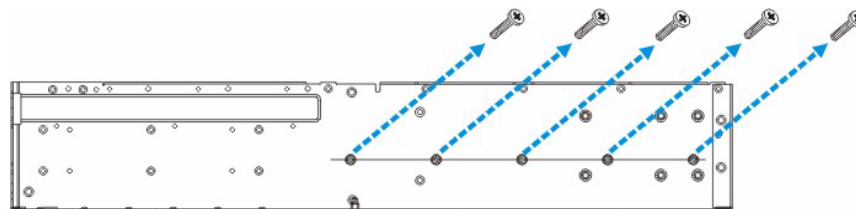

Fig. 3.2 Enclosure Side Mounting Holes (2)

- Use M5 or M6 pan-head screws to secure the chassis to the front cabinet posts.

3.6 Drive Tray Installation

Once the hard drives have been installed in the drive trays, the drive trays can be installed into the subsystem.

WARNING!

All drive trays must be installed into the enclosure even if they do not contain a hard drive. If the trays are not installed into the enclosure, the ventilation required for cooling will be disturbed and the subsystem will overheat.

1. Make sure that the hard drive is secured to the drive tray. Make sure the key-lock is in the unlocked position. The key-lock is unlocked if the groove on its face is in a horizontal orientation. If the groove is in a vertical position, as shown in *Figure 3.3*, then the key-lock is locked and the front flap on the drive tray cannot be opened.

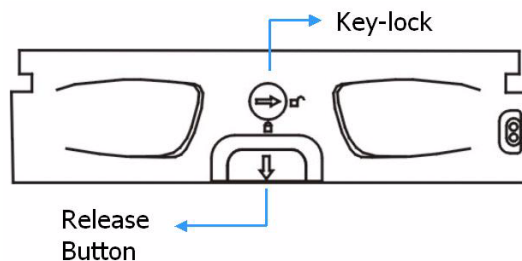

Fig. 3.3 Front View of an Individual Drive Tray

2. Open the front flap on the drive tray. (See *Figure 3.4*). To open the flap, push the release button on the front bezel. The front flap will open in an upward direction.

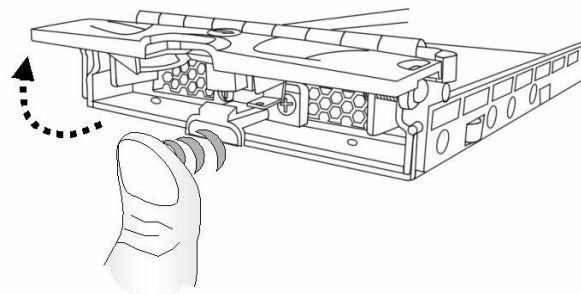

Fig. 3.4 Opening Drive Tray Front Flap

3. Align the drive tray with the slot in which you wish to insert it. Make sure that it is resting on the rails inside the module slot. Once the drive tray is lined up with the slot, gently slide it in. This should be done smoothly and gently.
4. Close the front flap on the drive tray. Make sure the front flap is closed properly. Closing the front flap ensures that the drive tray is firmly connected to the corresponding connector on the backplane board. If the front flap is not closed properly, the connection between the HDD and the subsystem will not be secure. **DO NOT** slam the drive tray into place! The connector pins might be damaged. If the front flap is not closed properly, the connection between the hard drive and the subsystem will not be secure.
5. Lock the flap into place by turning the key-lock until the groove on its face is pointing down (vertical orientation). (See *Figure 3.5*)

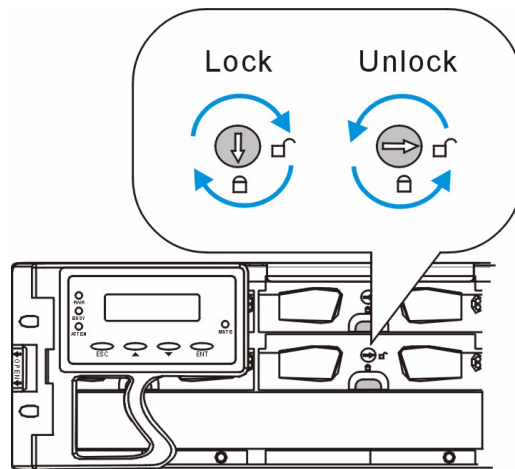

Fig. 3.5 Drive Tray Key-lock Rotation

6. Once all drive trays are installed, the RAID subsystem will poll the drive channels and recognize the drives and scan them in automatically.
7. When powered up, you should check the LEDs on drive bezels to ensure all drives are receiving power and are functional. All drive LEDs should be solid green after the initialization stage.

4 Subsystem Monitoring

This chapter provides information on how to monitor the subsystem.

4.1 Subsystem Monitoring Overview

The subsystem is equipped with a variety of self-monitoring features that help to keep subsystem managers informed of the subsystem operational status. These monitoring features provide vital feedback to help you maintain the operational integrity of the subsystem. Prompt response to warnings and subsystem component failure notifications will ensure safe operation of the subsystem and help ensure the longevity of the subsystems.

Self-monitoring features include:

- **Firmware (FW):** The RAID controllers in the subsystems come with pre-installed FW. The FW can be accessed using either the LCD keypad panel or a PC running terminal software through the RS-232C (audio jack) serial port. Device status information can be obtained from the FW.
- **Bosch RAIDWatch:** Bosch RAIDWatch is a fully integrated Java based Graphical User Interface (GUI) that came with the subsystem and can be used to monitor and maintain the subsystem using web browsers. Connection to a Bosch RAIDWatch station is made using the existing Ethernet ports.
- **The Bosch RAIDWatch Panel View** can be customized to show a direct, graphical representation of the subsystem in the content panel of the Bosch RAIDWatch screen. Panel View allows you to quickly determine the operational status of critical components.
- **Configuration Client:** The powerful Configuration Client sub-module can be used to keep you informed of system events via a variety of communication methods like email, LAN broadcast, fax, pager, MSN messenger, ICQ, and SMS. The sub-module runs as an independent program from Bosch RAIDWatch main program. The Configuration Client helps prevent blind time and keeps you constantly informed as to the status of the storage management subsystem.
- **LEDs:** Device-status-indicating LEDs are placed on all of the subsystems' active components. These LEDs inform you of the integrity of a given component or a given link. You should become familiar with the different LEDs on the subsystem and be aware of their functions. (See *Figure 4.2*)
- **Audible Alarm:** An audible alarm is present on the subsystem controller board and will be triggered if any of a number of threatening events occurred. These events usually jeopardize the functional and operational integrity of the controller board and must be heeded at all times. Events such as a breaching of the temperature threshold will trigger the alarm and if an onsite subsystem manager is present, the manager should, using either the LCD panel or the PC hyper-terminal, determine the cause of the alarm and take the appropriate corrective measures. (See *Figure 4.3*)
- **Inter-Integrated Circuit (I²C):** The I²C bus monitors the operational integrity of the cooling modules, sensors for RAID controller board/backplane temperature and voltage readings.

Subsystem monitoring is a necessary part of subsystem management. If failure events or other disruptive events are detected and reported, the subsystem managers must take the appropriate action to rectify the problem. Failure to act in a properly specified manner to a system event (like overheating) can cause severe and permanent damage to the subsystem.

4.2 Status-indicating LEDs

4.2.1 Brief Overview of the LEDs

The following devices come with LEDs that inform subsystem managers about the operational status of the component on which they are mounted. The RAID subsystem features status-indicating LEDs distributed over the active components in the following ways:

Component	LED(s) per Unit	Total LEDs	Definition
Drive Trays	2	16	See Section 4.2.2 Drive Tray LEDs
Controller Module	5	5	See Section 4.2.3 Controller Module LEDs
Ethernet Ports	2	2	See Section 4.2.4 Ethernet Port LEDs
BBU Module	1	1	See Section 4.2.5 BBU Module LED
PSU Module	1	2	See Section 4.2.6 PSU LED
LCD Keypad Panel	3	3	See Section 4.2.7 LCD Keypad Panel
Cooling Fan Module	1	2	See Section 4.2.8 Cooling Fan Module LED

Table 4.1 LED Distribution

4.2.2 Drive Tray LEDs

Two LED indicators are located on the right side of each drive tray. (See *Figure 4.1*) Refer to *Table 4.2* for LED definitions. When notified by a drive failure message, you should check the drive tray indicators to find the correct location of the failed drive. Replacing the wrong drive can cause fatal failure of a logical array.

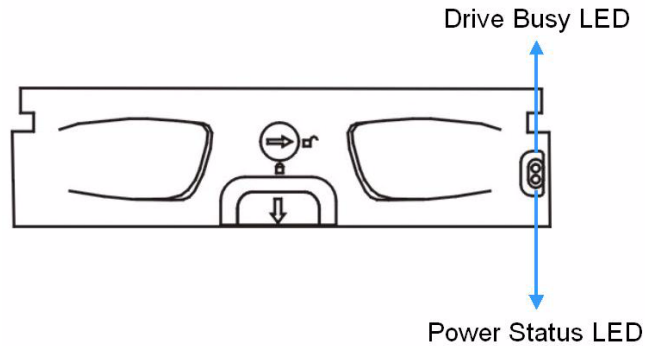

Fig. 4.1 Drive Tray LEDs

LED Name	Color	Status
Drive Busy	Blue	ON indicates read/write activity on the drive. OFF indicates there is no read/write activity on the drive.
Power Status	Red/ Green	GREEN indicates that power is being supplied to the drive. OFF indicates no power is being supplied to the drive or the drive tray is not properly installed. . RED indicates drive failure or faults have occurred.

Table 4.2 Drive Tray LED Definitions

4.2.3 Controller Module LEDs

The rear-facing faceplate of the RAID controller module is shown in *Figure 4.2*. The rear-facing faceplates on the two models look identical. The LEDs are numbered from 1 to 5. There are two more LEDs on the Ethernet port. The definitions are shown in *Table 4.3* below.

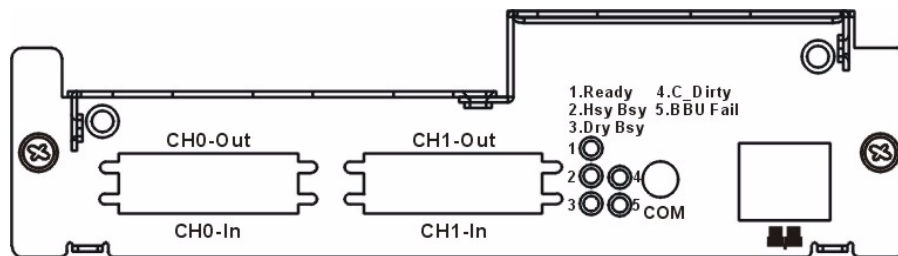

Fig. 4.2 Controller Faceplate

LED	Name	Color	Status
1	Controller Ready	Green	ON: Indicates controller is active and operating normally. FLASHING: Indicates controller initialization is taking place. OFF: Controller is not ready for operation.
2	Hst_Bsy (Host Ports Busy)	Green	FLASHING: Activities on the host ports. OFF: No activities on the host ports.
3	Drv_Bsy (Drive Busy)	Green	FLASHING: Activities on the drive side. OFF: No activities on the drive side.
4	C_Dirty (Cache Dirty)	Amber	ON: Indicates that data is currently being cached in memory or is being held up by the BBU during a system power loss.
5	BBU_Fail	Amber	ON: Indicates the BBU has failed and cannot sustain cached data. OFF: Indicates the BBU can sustain cached data in memory. FLASHING: The BBU is charging.

Table 4.3 Controller Module LED Definitions

4.2.4

Ethernet Port LEDs

The subsystem comes with a RS-232C audio jack serial port that can be used to assign a permanent IP to the subsystems. After a permanent IP address has been assigned, an Ethernet cable can be used to connect the RJ-45 Ethernet port to a network hub or router. This enables you to manage your subsystem locally or remotely over TCP/IP. See *Figure 4.3* for the locations of the two LED indicators on Ethernet port. Refer to *Table 4.4* for the LED definitions.

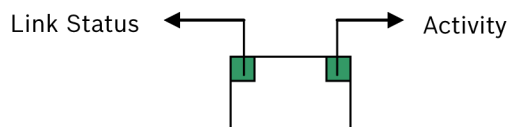

Fig. 4.3 Ethernet Port Indicators

Name	Color	Color
Link Status	Green	ON: Indicates a valid connection to network
LAN Activity	Green	BLINKING: Indicates active transmissions

Table 4.4 Ethernet Port LED Definitions

4.2.5 BBU Module LED

The BBU module has an LED on its faceplate. (See *Figure 4.4*) The function is the same as the fifth LED on the controller module. The LED is off when the BBU is functioning normally and is able to sustain the cache memory. The LED flashes to indicate the BBU is currently charging its battery cells. If the LED is illuminating amber, the unit may have failed. Please contact your system vendor to verify the problem.



Fig. 4.4 BBU Module LED

4.2.6 PSU LED

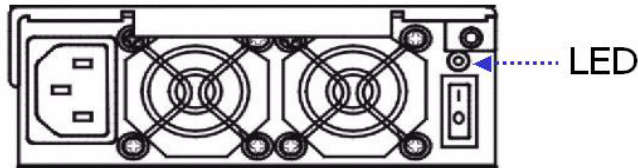

Fig. 4.5 PSU LED

Each PSU comes with a single LED located just above the power switch and just below the retention screw (see *Figure 4.5*). The LED is used to indicate the operational status of the PSU module. Please refer to the PSU LED definitions shown in *Table 4.5*.

Color	Status
Flashing Green	The power supply has not been turned on. The PSU module LED will blink when the subsystem is connected to a power source but has not been turned on.
Static Green	The PSU is operating normally and experiencing no problems
Static Red	The PSU has failed and is unable to continue providing power to the subsystem.
OFF	The power cord is unplugged or the power cord is plugged but no power is being supplied from the power source.

Table 4.5 PSU Module LED Definitions

4.2.7 LCD Keypad Panel

The LCD panel located on the front aluminum foldable handle comes with three status LEDs. The LEDs are marked from top to bottom “PWR,” “BUSY” and “ATTEN” and are clearly seen in *Figure 4.6* below. The definitions of these LEDs are shown in *Table 4.6*. The mute button can be used to stop the alarm until the next controller event occurs.

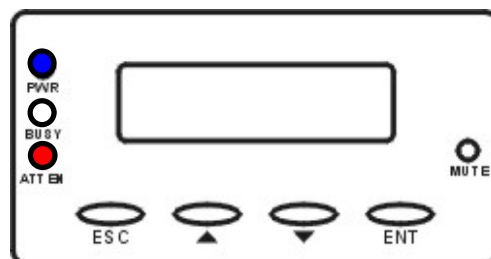

Fig. 4.6 LCD Keypad Panel

Name	Color	Status
POWER	Blue	ON indicates that power is being supplied to the subsystem. OFF indicates that no power is being supplied to the subsystem.
BUSY	White	Flashing indicates that there is activity on the host/drive channels. OFF indicates that there is no activity on the host/drive channels.
ATTENTION	Red	ON indicates that one or more component failure/critical events have occurred. OFF indicates that the subsystem and all its components are operating normally.

Table 4.6 LCD Panel LED Definitions



NOTICE!

The LCD panel ATTN LED will be turned on during the power up process. The ATTN LED will be turned off after the boot up procedure is completed correctly.

4.2.8

Cooling Fan Module LED

The cooling fan module comes with a single status-indicating red LED shown in *Figure 4.7*. LED definitions are given in *Figure 4.7*.

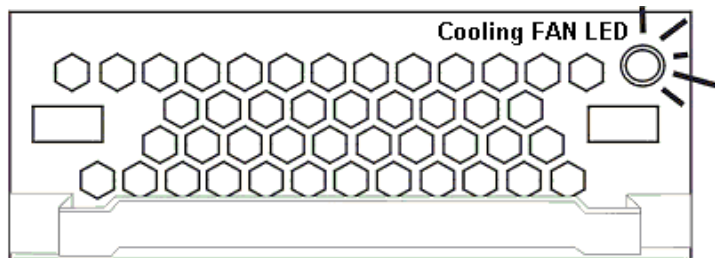

Fig. 4.7 Cooling Fan Module LED

RED	Status
OFF	The cooling fan module is operating normally.
ON	The cooling fan module has failed and must be replaced.

Table 4.7 Cooling Fan Module LED Definitions

The subsystem has a novel approach to stabilizing the temperature within the subsystem: When the sensors within the enclosure detect critical working conditions, such as high ambient temperature or the failure of any cooling or PSU module, the system will turn the cooling fans to high speed to extract more heat. Once the ambient temperature cools down to normal or the faulty module has been replaced, the cooling fans return to normal speed.

4.3 Audible Alarm

Different subsystem environmental and operational parameters (i.e., temperature, etc.) have been assigned a range of values between which they can fluctuate. If either the upper or lower thresholds are exceeded, an audible alarm will automatically be triggered. The alarm will also be triggered when an active component of the subsystem fails. If the subsystem manager is onsite and hears the alarm, the manager will have to read the error message on the LCD screen or the PC terminal in order to determine what has triggered the alarm. After determining what has occurred, the subsystem manager must take appropriate actions to rectify the problem.

CAUTION!

When an alarm is triggered, it is necessary for you to determine the problem. If the audible alarm is ignored and the problem is not rectified, unexpected damages may occur.

4.3.1 Default Threshold Values



NOTICE!

The threshold values listed below are used to trigger a warning event and sound the alarm. A different value set is reserved for triggering the cooling fans to operate at a high rotation speed. The fan speed value set is not user-configurable.

Table 4.8 shows the default threshold values for the subsystem. If any of these values are surpassed, the alarm will sound.

	Upper Threshold	Lower Threshold
+3.3V	+3.6V	+2.9V
+5V	+5.5V	+4.5V
+12V	+13.2V	+10.8V
CPU Temperature	90°C	5°C
Board Temperature	80°C	5°C
Enclosure Ambient Temperature	40°C	0°C

Table 4.8 Default Threshold Values

The controller self-monitoring thresholds in Table 4.8 are the default threshold values. The values set for the subsystem's ambient temperature are pre-configured before shipping and cannot be changed.

4.3.2

Failed Devices

The audible alarm will be triggered if any of the following devices fail:

- Cooling fan modules
- PSU modules
- BBU modules
- Hard drives
- Components on the RAID controller



NOTICE!

If the temperature exceeds a preset threshold, the BBU charger circuits will stop charging. You will then receive a message that says “Thermal Shutdown/Enter Sleep Mode.” When the temperature falls back within normal range, the battery will resume charging.

4.4

I²C Monitoring

Module presence detection and the general working status of cooling fan and other modules are monitored through an I²C serial bus. If any of these modules fails, the failure will be detected and you will be notified via the various methods described above.

5 Subsystem Connection and Operation

This chapter introduces sample topologies, configuration options and server connections for the RAID subsystems and discusses both the power on and power off procedures.

5.1 Basic Configuration Rules

When you are configuring your storage subsystem, follow these basic rules:

- Using a mix of LVD and legacy devices, such as devices using single-ended signaling, is not recommended. Use LVD terminators if all your devices support LVD signaling. Please refer to the documentation provided with your SCSI devices to avoid possible conflicts.
- When selecting the number of hard drives to be included in a logical configuration that should be presented through the host channels, the transfer rates and the mechanical performance of the hard disks should be considered. The combined bandwidth of the two SCSI host channels is 640MB/s, sufficient for most applications. If properly configured, combining subsystems or drive enclosures may increase the number of drives and help to bring out the most of IOPs performance.
- If you consider cascading multiple enclosures, considerations may include the characteristics of your I/O load. Select the correct combination of optimization mode and a specific RAID level.
- An optimal configuration is always a compromise among different factors. For instance, a large array with many drive members may be more efficient, but the chance of failing a member is also increased.
- The drives in the same logical array should have the same capacity; it is preferred that all the drives in the enclosure have the same capacity.
- A spare drive should have a minimum capacity equivalent to the largest drive that is to be replaced. If the capacity of the spare is less than the capacity of the drive to be replaced, then the controller will not proceed with the failed drive rebuild.

5.2 SCSI Connection Overview

The SCSI host ports connect to SCSI-320 host adapters (HBA) that comply with 320MB/s transfer rate and SCSI-3 protocol, best capable of 64-bit/133MHz PCI operation. Connection of the subsystem's SCSI ports is flexible. For example, you may use the two VHDCI ports of a dual-stacked connector to connect a host channel to two separate, clustered servers. If high availability or path redundancy software is applied, a total of 4 VHDCI ports are available for cross-linking to host adapters. As long as access contention is not of the concern, host connection can be very flexible. In the following sections, configuration diagrams will be provided to illustrate the possible uses of the subsystem in different application environments.

Note that these configurations are only recommendations and do not intend to impose limitations such as the use of high availability software or cascading multiple enclosures. The same configuration principles applies to the subsystem.

The RAID subsystems support 2 SCSI host channels and 2 dual-stack connectors featuring support for SCSI-320 protocol (also known as Ultra-320), the latest iteration of the SCSI drive interface standard. The SCSI-320 enables maximum data transfer rates up to 320MB/second per channel from host computers to the subsystems or expansion systems. This is twice the bandwidth as the Ultra160 standard, allowing you optimal performance and flexibility with configuring storage applications.

5.2.1 SCSI Cables

One SCSI cable is required with each subsystem for host connection. If you wish to connect the second host channel, a second cable is required. Use only high quality SCSI-320 cables from a reputable manufacturer. To ensure optimum performance, it is necessary to use proper, high quality SCSI-320 compatible cables. Failure to do so will result in downgraded performance.

5.2.2 SCSI Port on the Controller Rear Panel

- The SATA-based subsystem is equipped with two dual-stacked connectors on the back of the enclosure. Each dual-stacked connector comes with two 68-pin VHDCI ports that is specified as a "Channel # In" or "Channel # Out" port. The SCSI ports are specified as "In" or "Out" for ease of identification. As long as each device on a SCSI bus is assigned with a unique ID and the SCSI bus properly terminated, there are no limitations with connecting a specific SCSI port to the host- or drive-side devices.

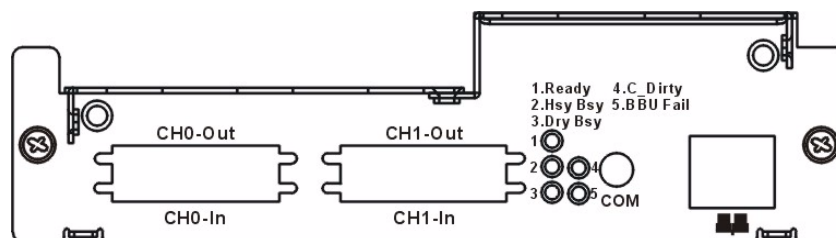

Fig. 5.1 Dual-stacked Connectors on the Controller Faceplate

- The subsystem requires an external VHDCI-to-VHDCI SCSI round cable to connect the subsystem to a host adapter.
- One (1) audio-jack-to-DB9 cable is provided to facilitate the connection of the COM1 port for local terminal emulation access to the array.
- Two (2) power cords are provided for the power connections to the power sources.
- The RJ-45 Ethernet cable for network management connection is a user-supplied item. Use straight-through Ethernet cables with RJ-45 plugs.

5.2.3

SCSI Termination

Correct SCSI termination procedures require that the last device on the SCSI bus be terminated. If the last device is not terminated or if devices other than the last are terminated, erratic SCSI bus behavior may occur.

An auto-detection, on-board terminator is built into the DVA-08K. You do not need to install an external terminator when a subsystem acts as the last device in the daisy chain configuration. The on-board terminator default is enabled. If the subsystem is not the last device in the daisy chain configuration, the terminator will be automatically disabled. Although it is not recommended, if you prefer to disable the firmware setting for the on-board terminator using the LCD keypad panel on the subsystem, RS232C terminal session, or Bosch RAIDWatch management software, the auto-detection function is also disabled.

Typically, the host computer or host adapter (SCSI card inside the PC) is the first device and some are already terminated. When installing the DVA-08K on a SCSI bus with other devices, be sure to observe the above rules regarding all devices on the SCSI bus. Consult your host computer and/or host adapter manual for additional information on correct termination procedures.



NOTICE!

It is recommended not to change the firmware default setting for the SCSI terminator so the auto-detection function can operate.

5.3 Host Connection Topology

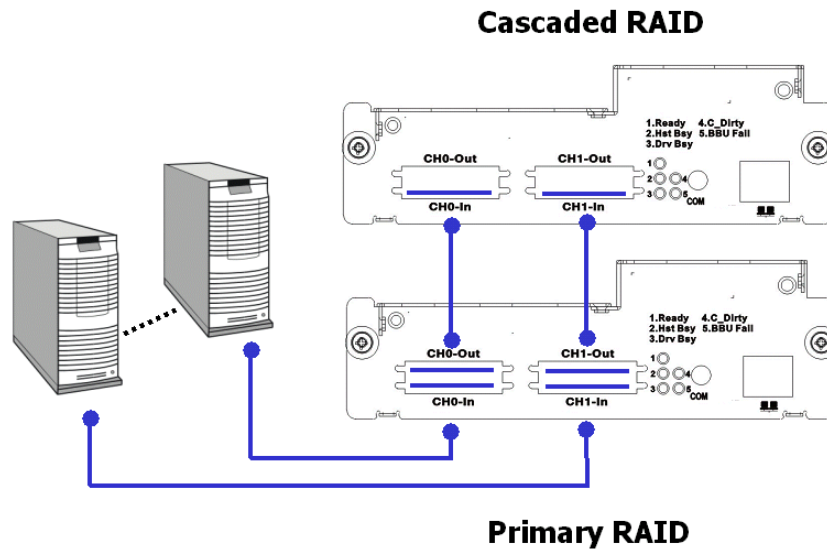

Fig. 5.2 Cascaded Subsystems Connected to Two Host Computers

In the example shown in *Figure 5.2*, the SCSI ports are connected to different host computers. This provides both path and host computer redundancy. If one of the host channels becomes disconnected, or if the cable connecting one of the host ports to the host computer is damaged, the second path can transmit data from the subsystem to one of the host computers. Similarly, in the clustered hosts configuration, the same array can be accessed through different data paths and downtime will be minimized.

To obtain more disk capacity, the “Out” ports are used to cascade another subsystem.

The host-side connection can be made as the following:

1. Directly to servers or workstations equipped with SCSI HBAs.
2. Connect two subsystems on the same host buses for a larger combined capacity.
3. Cross-link the host ports on subsystem(s) to clustered servers.

High availability configurations, such as clustering or redundant paths settings, can be applied with adequate software control. The same logical array can be associated with two or more different host IDs to facilitate access down through different HBAs.

Default Channel Settings

Model	Host Channels	Drive Channels
DVA-08K	Channel 0 and Channel 1	Channels 1 to 8, each dedicated to one connected drive

Table 5.1 Default Channel Settings

5.4 Power On

After installing all the components in the subsystem, connecting the host channels to the host, and connecting the expansion cables to the expansion enclosures, the subsystem is ready to be powered on.

5.4.1 Power On Checklist

BEFORE powering on the subsystem, please check the following:

- Memory module: Memory module has been correctly installed on the controller board.
- BBU modules: Ensure that the BBU modules have been installed correctly.
- Hard drives: Hard drives have been correctly installed on the drive trays.
- Drive trays: ALL the drive trays, whether or not they have a hard drive, have been installed into the subsystem.
- Cable connections: The host ports on the subsystem have been correctly connected to host computer(s).
- Power cables: The power cords have been connected to the PSU modules on the subsystem and plugged into main power.
- Ambient temperature: All the subsystem components have been acclimated to the surrounding temperature.

5.4.2 Power On Sequence

When powering on the subsystem, please follow the steps below:

1. Power on any expansion enclosures if applied
If you connect any expansion enclosures to the subsystem, power on those expansion enclosures before powering on the subsystem.
2. Power on the subsystem
The subsystem should be powered on before the host computers. The power on procedure for the subsystem is described in *Section 5.4.3 Power On Procedure*.
3. Host computers
Host computers should be the last devices that are turned on. Please refer to the documentation that came with your host computers to see its own power on procedure.

5.4.3 Power On Procedure

1. Plug in all power cords to the power connectors located at the rear of the subsystem. Use the power cables that came with the subsystem to connect the subsystem to the power outlet, separate power sources, or UPS devices.
2. Turn on the power supply switches for both power supply units.
3. The subsystem is now turned on and the self-test will start automatically.
4. The "Power" LED on the front LCD panel will turn blue.

CAUTION!

Although the PSUs are redundant and a single PSU can provide sufficient power to the system, it is advisable to turn both the power switches on. If only one PSU is operating and fails, the whole system will shut down.

5.4.4 Power On Status Check

Once the subsystem has been powered on, the status of the entire subsystem should be checked to ensure that everything is running smoothly and that there are no complications or malfunctions.

1. Controller module LEDs: The controller module LEDs should all flash green.
2. Drive tray LEDs: The LEDs of all the drive trays (that contain hard drives) should be constantly lit green to indicate that the drives have successfully spun up and are ready for I/Os.
3. LCD panel LEDs: The blue LED on the LCD panel should come on indicating that power is being supplied to the system.
4. Firmware and Bosch RAIDWatch: The overall status of the system may be checked using the terminal interface or the Bosch RAIDWatch GUI.
5. Audible alarm: If any errors occur during the initialization process, the onboard alarm will sound in a hastily repeated manner.

Drive tray LEDs should normally start flashing during the initialization stage, indicating the RAID controller unit is attempting to access the hard drives.



NOTICE!

The subsystem has been designed to run continuously. If a hot-replaceable component fails, the fault can be corrected online.

5.4.5 LCD Screen

LCD Screen

When powering on the subsystem, the following messages should appear on the front panel LCD screen. Wait for the front panel LCD to show “READY” or “No Host LUN” before turning on the host computer. Refer to *Figure 5.3* on how to read the screens.

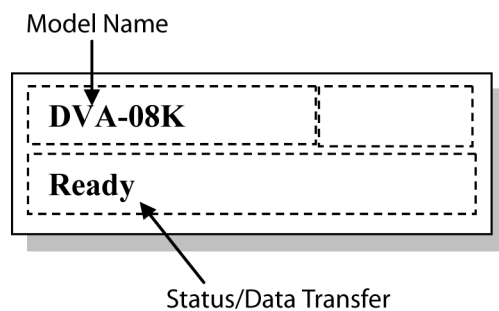

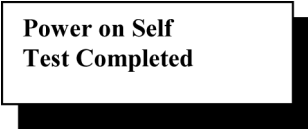
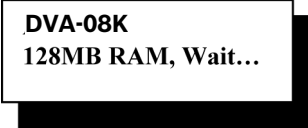
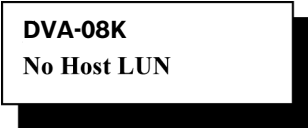

Fig. 5.3 The LCD Initial Screen

The LCD screen startup sequence is shown and described in the sequence below:

 <p>Initializing.... Please Wait...</p>	<p>This screen appears when the PSUs are turned on.</p>
 <p>Power on Self Test, Please Wait...</p>	<p>Proceeding with controller self-test.</p>
 <p>Power on Self Test Completed</p>	<p>Self-test completed.</p>
 <p>DVA-08K 128MB RAM, Wait...</p>	<p>Verifying installed cache memory.</p>
 <p>DVA-08K No Host LUN</p>	<p>System is ready. You can now start to configure the subsystem.</p>

5.5 Power Off Procedure

If you wish to power down the subsystem, please follow these steps:



NOTICE!

If you wish to power down the subsystem, please ensure that no time-consuming processes, like “Regenerate Logical Drive Parity” or a “Media Scan,” are running.

1. Stop I/O access to the system
Stop all I/O accesses from the host computers to the subsystem. Please refer to the related documentation of your host applications and operating system.
2. Disconnect the host
The host must be disconnected from the subsystem. To do this, disconnect the cables from both the host and the subsystem.
3. Flush the cache
Use the “Shutdown Controller” function to flush all cached data. This prepares the RAID subsystem to be powered down.
4. Turn off the power
Turn off the power switches at the power supply modules. Once the RAID subsystem has been powered down, other devices that are connected to the subsystem can be powered down.

6 Subsystem Maintenance

Constant monitoring and maintenance of your SATA-based subsystems will minimize the chance of system downtime and preserve the working integrity of the system for a longer period of time. If any of the subsystem plug-in modules fails, they must be replaced as soon as possible.

6.1 Overview

CAUTION!

Do not remove a failed component from the subsystem until you have a replacement on hand. If you remove a failed component without replacing it, the internal airflow will be disrupted and the system will overheat causing damage to the subsystem.

All of the following components can be replaced in case of failure:

1. Controller module – *Section 6.2 Replacing Controller Module Components*
2. Memory module – *Section 6.3 Replacing or Upgrading Memory Modules*
3. BBU module – *Section 6.4 Replacing a Faulty BBU*
4. PSU modules – *Section 6.5 Replacing a Failed PSU Module*
5. Cooling fan modules – *Section 6.6 Replacing a Failed Cooling Fan Module*
6. Hard drives – *Section 6.7.2 Replacing a Failed Hard Drive*

6.1.1

General Notes on Component Replacement

- With the exception of the RAID controller module, all the components on the subsystems, including the PSU modules, cooling fan modules, BBU, and drive trays are hot-swappable and can be changed while the subsystem is still in operation.
- Qualified technicians who are familiar with the subsystem should be the only ones who make component replacements. If you are not familiar with the subsystems and not familiar with RAID subsystem maintenance in general, it is strongly advised that you refer subsystem maintenance to a suitably qualified maintenance technician.
- Normalized airflow is directly dependent upon the presence of all subsystem components. Even if a subsystem component fails, it should not be removed from the subsystem until a replacement is readily at hand and can be quickly installed. Removing a subsystem component without a replacement can lead to permanent subsystem damage.
- When replacing any hot-swappable component, caution should be taken to ensure that the components are handled in an appropriate manner. Rough or improper handling of components can lead to irreparable damage.
- When removing a controller module from the subsystem, ensure that the power has been turned off and that all precautionary measures, without exception, are adhered to. The controller board contains very sensitive components and can be easily damaged.

CAUTION!

When inserting a removable module, DO NOT USE EXCESSIVE FORCE! Forcing or slamming a module can damage the pins on the module connectors either on the module itself or on the backplane. Gently push the module until it reaches the end of module slot. Feel the contact resistance and use slightly more force to ensure the module connectors are correctly mated. If the module comes with extraction levers or retention screws, use them to secure the module.

6.2 Replacing Controller Module Components

6.2.1 Overview

The controller module should never be removed unless the following replaceable components need to be accessed:

- Cache memory DIMM module: If a larger capacity DIMM module is required.
- Controller module itself: If the controller module in a single-controller model fails, it is necessary to power down the subsystem and replace the controller.

If a DIMM module or RAID controller fails, contact your vendor immediately for a replacement. To replace any of these components, the controller module must first be removed from the subsystem.

6.2.2 Notes on Controller Module Maintenance

- The controller module contains a DIMM module. It is not recommended to re-use the DIMM module extracted from a failed controller unless you have a similar RAID subsystem that can be used to test the module. You can contact your vendor for sending the failed controller in for repair.
- When replacing the controller module, it must be remembered that the controller board is one of the most sensitive components in the subsystem. All previously stipulated safety precautions must be strictly adhered to. Failure to adhere to these precautions can result in permanent damage to the controller board, resulting in lengthy delays.
- Prior to replacing the controller module, it is imperative for your own safety to be sure no power is being supplied to the system.

6.2.3 Removing the Controller Module

To remove the controller module:

1. Stop host I/Os or host applications to avoid losing data or causing data inconsistency.
2. Turn the subsystem power off: If possible power off the subsystem in the way described in Chapter 4. If it is not possible to do this turn off both PSU modules and disconnect the power cords.
3. Disconnect all cables: There may be a number of different cables attached to the controller module. These cables could include SCSI cables for host connections, an RS-232C (audio jack) cable for serial port connection, and an Ethernet cable for network connection. Prior to removing the controller module, all these cables should be removed.
4. Loosen the retention hand screws: Hand screws are located on both sides of the RAID controller's faceplate. Press these screws and use a Phillips screwdriver to loosen them so that the controller can be removed from chassis. (See *Figure 6.1*)

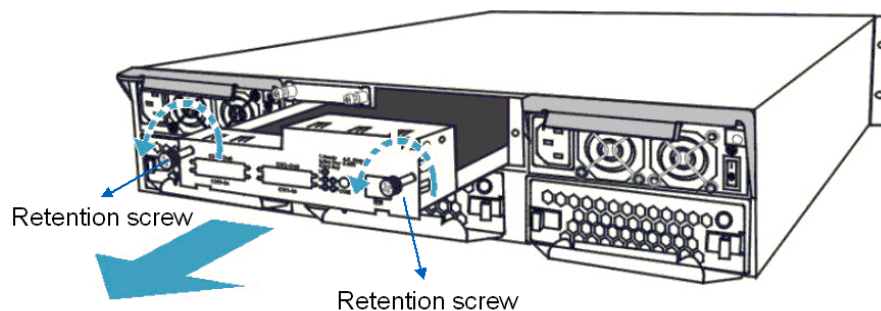

Fig. 6.1 Loosen Controller Module Retention Screws

5. Pull the controller module out: Once the retention screws have been removed; gently pull the controller module out of the subsystem chassis.

6.2.4

Replacing the Controller Module

1. Remove the failed controller module.
2. Install a DIMM module on the new controller module.
3. Insert the replacement controller. Align the controller module with the module bay at the rear of the subsystem. Gently slide the controller module in.
4. Fasten the hand screws. Once the controller module has been completely inserted into the subsystem chassis, secure the controller module to the chassis by tightening the hand screws at the sides of the controller rear panel.
5. Connect the controller module cables: Reconnect all of the cables that were previously disconnected from the controller module. These may include SCSI cables for host and expansion connections, an RS-232C (audio jack) cable for serial port connection, and an Ethernet cable for network connection.
6. Power on: Once the new controller module has been properly installed and the cables have been correctly connected, turn the subsystem power on.

6.3 Replacing or Upgrading Memory Modules

6.3.1 Memory Module Installation Overview

- The subsystems come with a pre-installed 256MB (or above) DDR RAM DIMM module on the controller. The controller supports one memory module for the capacity up to 1GB. If a DDR RAM DIMM modules with a different size is preferred or the original memory module has failed in some way, the pre-installed module must be removed and replaced by a new one. Replacement and installation instructions are described fully below.
- The DIMM module is located on the controller board. The controller board is a sensitive component and must be treated with care to avoid being damaged.

CAUTION!

The controller board in the module contains sensitive components. Please ensure that all anti-static precautions stipulated above are strictly adhered to. Only qualified technicians can replace a DIMM module.

6.3.2 Selecting a Memory Module

If the memory module mounted on the controller is going to be replaced, the following factors should be considered when purchasing replacement modules.

- Pre-installed DIMM module: The subsystem comes with a 256MB DDR RAM module pre-installed on the controller board. If you wish to change the size of the DIMM, then a new, separately purchased DIMM can be installed.
- DDR RAM DIMM modules supported. The subsystems support DDR RAM DIMM modules with the capacities ranging from 256MB to 1GB.
- Installation consideration: When installing the DIMM module, it is necessary to handle the controller module. The controller board is more susceptible to damage than the other components and must therefore be handled with extreme care. All anti-static precautions must be strictly adhered to.
- Secure installation: When replacing the DIMM module, make sure that the new DIMM module is firmly in place prior to installing the controller module. If the DIMM module is not firmly in place, the subsystem will not run and the controller will need to be removed and the DIMM module correctly installed.
- Purchasing consideration: When purchasing a DDR RAM DIMM to install on the controller board, contact your vendor for an updated list of certified modules.

6.3.3 DIMM Module Installation

CAUTION!

The pre-installed modules must be removed prior to installing new memory modules. Do this with care. Sensitive components can be damaged during the process.

If a DIMM module fails or a DIMM module with a higher memory capacity is required, the DIMM module must be replaced.

1. Remove the controller module.
2. Remove the previously installed DIMM module from the DIMM socket. To do this, push the white module clips on the sides of the DIMM module down together. By doing this, the previously installed modules will be ejected from the DIMM socket. (See *Figure 6.2*)

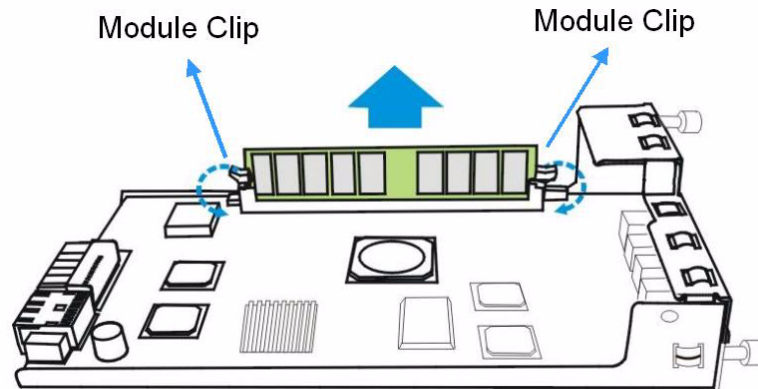

Fig. 6.2 Push Back the Module Clips on the Sides of the DIMM Socket

3. Gently retrieve the DIMM module out of the DIMM socket. (See *Figure 6.2*)
4. Insert the DIMM module into the DIMM socket. Align the DIMM module with the DIMM socket. Once aligned, gently push the DIMM module into the socket. The white clips on the sides of the socket will close automatically and secure the DIMM module into the socket.

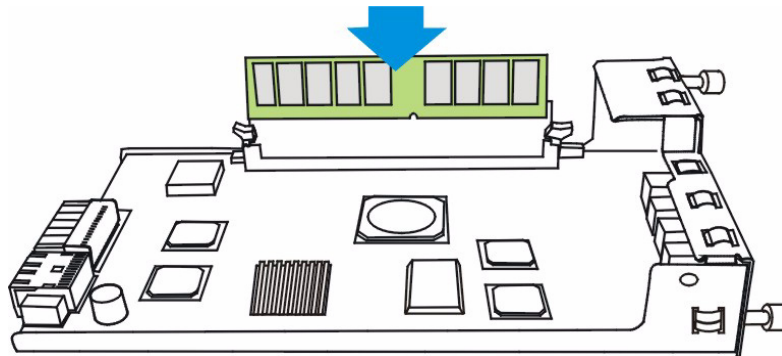

Fig. 6.3 Insert the DIMM Module

5. Reinstall the controller module. After the DIMM module has been properly installed, the controller module must be reinstalled. To do this, align the controller module with the controller module bay. Then gently push the controller module in the controller bay. Carefully push the controller until you feel the contact when the board edge connectors are mated to the backplane. Do not use force. If unusual contact resistance is felt, try it again. Next secure the controller module into the subsystem by fastening the hand screws on the sides.



NOTICE!

When replacing a DIMM, the whole subsystem needs to be powered down. Therefore, when replacing a DIMM, you should carefully select the time when the replacement will be made in order to minimize the overall disruption to service.

6.4 Replacing a Faulty BBU



NOTICE!

The BBU is hot-swappable and can be replaced while the subsystem is running. However, a new module will only be recognized after a subsystem reset. Carefully select the time when the reset will be made in order to minimize the overall disruption to service.

To replace a faulty BBU, please follow these steps:

1. Remove the faulty BBU module from the chassis. The BBU module is secured to the chassis with two (2) spring screws. These screws must be loosened. To loosen, turn the screws counterclockwise.
2. Install the new BBU module. After the faulty BBU module has been removed, the new BBU module can be installed. To do this, align the BBU module with the empty slot, and then gently push the BBU module into the slot.
3. Secure the BBU module to the enclosure. Tighten the two (2) spring screws on the back of the BBU module.
4. Once the new BBU module is correctly installed into the subsystem, the LED should start flashing, indicates the BBU is being charged. When the BBU is fully charged, the LED will go off.



NOTICE!

The life expectancy of a BBU is approximately 500 cycles. Follow the procedures above to replace an old BBU with a new BBU in order to maintain fault-tolerant subsystem functionalities.

6.5 Replacing a Failed PSU Module

6.5.1 Notes on PSU Module Maintenance

- Two redundant PSU modules: The subsystem comes with two 350W, fully redundant, hot-swappable PSU modules. These modules are accessed from the rear of the subsystem.
- Immediate replacement: When a PSU fails, it should ideally be replaced immediately. Do not remove the PSU module unless a replacement is readily available. Removing a PSU without a replacement will cause severe disruptions to the internal airflow and the subsystem will overheat, possibly causing irreparable damage to some of the subsystem components.
- PSU bracket: Each PSU module is permanently mounted in a two-level steel bracket, creating a single unit. The PSU is located in the upper level and a removable cooling fan module is mounted in the lower level.

CAUTION!

Although the subsystems can operate using single PSU module, it is not advisable to run the RAID subsystems with a single PSU module for an extended period of time.

6.5.2 Replacing the PSU Module

To replace a PSU, please follow these steps:

1. Turn off the PSU and remove the power cord: Turn of the power switches located on the right side of each power supply module.
2. Once the power switches have been turned off, remove the power cables that connect the subsystem to the main power. The power connector is found on the left side of each power supply module.
3. Remove the retention screw: After the power cable has been removed from the power connector, remove the retention screw at the upper right side of the PSU rear-end panel.

The screw is located below the extraction lever, beside the LED indicator, and can be hidden from sight.

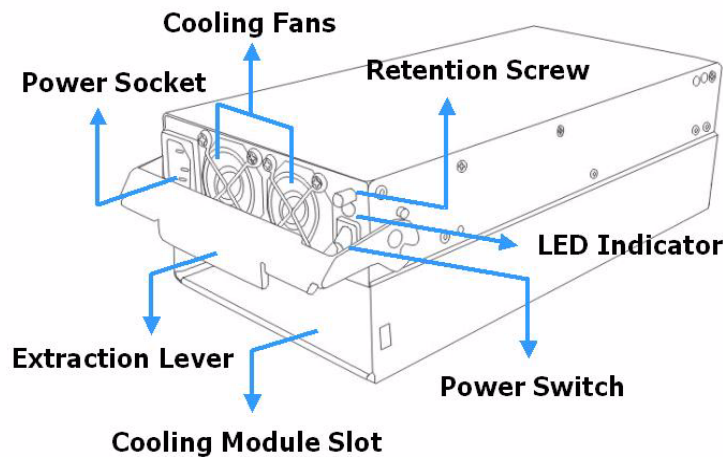

Fig. 6.4 PSU Parts Identification

4. Pull the extraction handle downward: Push the extraction lever at the back of the PSU module downwards. This will dislodge the PSU module from the subsystem. Once dislodged, gently pull the PSU module out of the subsystem.

CAUTION!

- When a PSU is pulled out of the chassis, the fan module beneath the PSU is removed from the chassis at the same time.
- Do not remove the PSU module unless a replacement is readily available. Removing a PSU without a replacement will cause severe disruptions to the internal airflow and the subsystem will overheat, possibly causing irreparable damage to some of the subsystem components.
- It is recommended that the replacement procedure is completed in less than five (5) minutes to prevent the subsystem from overheating.

5. Remove the cooling module: To do this, push the clips on either side of the module rear panel together. Then gently pull the cooling module out of the lower level of the PSU bracket. (See Figure 6.5)

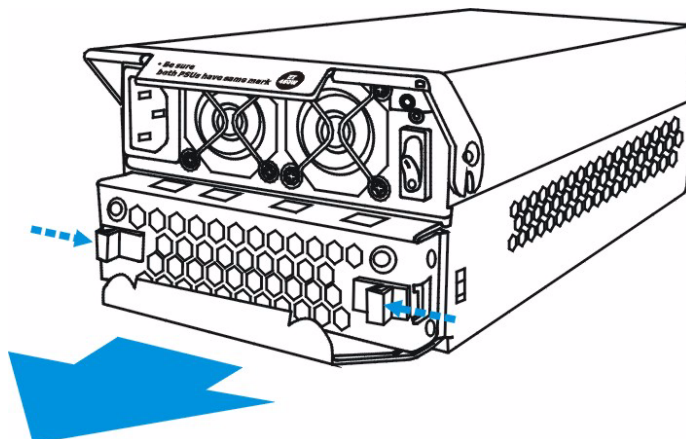

Fig. 6.5 Remove the Cooling Module

6. Reinstall the cooling module into the new PSU module: To do this, align the cooling module with the lower level of the PSU bracket and gently slide the cooling module in.

7. Insert the new PSU module into the subsystem: Once the previously removed cooling module has been installed, insert the new PSU module into the subsystem. Make sure the extraction lever is in its downright position so that the saddle notches on the lower edges of the handle can lock on to the edge metal brackets along the chassis inner walls. Push the PSU into the slot and pull the handle upwards to secure the module.
8. Reinsert the retention screw: If the PSU module is properly installed, the back end of the module should be aligned with the enclosure's rear panel. To firmly secure the PSUs into place, reinsert the retention screw.
9. Reconnect the power cord and turn the power on: Plug the power cord into the socket on the PSU module and turn the PSU module power switch on.

6.6 Replacing a Failed Cooling Fan Module

6.6.1 Notes on Cooling Fan Module Maintenance

- Redundant cooling fan modules: The subsystems are equipped with two redundant, hot-swappable, single-blower cooling fan modules located in the lower PSU module slot. These cooling fan modules control the internal operational temperature of the subsystem and therefore their working integrity should be maintained at all times.
- Detecting a failed cooling fan module: If a cooling fan module fails, you can be notified of the failure by the LED located at the back of the module, an audible alarm, the terminal event prompts, the Bosch RAIDWatch Panel View, or through the various methods by the Configuration Client utility.
- Replacing a cooling fan module: Once you are notified that a cooling fan module has failed, it should be replaced as soon as possible. A failed cooling fan module should only be removed from the subsystem when you have an immediately available replacement module that can be installed as soon as the failed cooling fan module has been removed.

CAUTION!

- The latches at the back of the cooling fan module secure the cooling fan module into the enclosure. If these latches are broken, the warranty on the cooling fan module will be void.
- Although the cooling fan modules are fully redundant, it is not advisable to run the subsystems with any of the cooling fan modules missing. Whenever a cooling fan module fails, the system is at risk of sustaining irreparable damage.
- Keep a failed module in its enclosure bay until a replacement unit is in hand.

6.6.2 Replacing a Cooling Fan Module

The cooling fan modules are secured to the chassis with two black latches located on the rear of the module. To replace the cooling fan module, please follow these steps:

1. To remove the cooling fan module: Squeeze both side latches towards the center of the cooling fan module and gently withdraw the cooling fan module from the subsystem by gently pulling on the silver handle at the bottom. (See *Figure 6.6*).

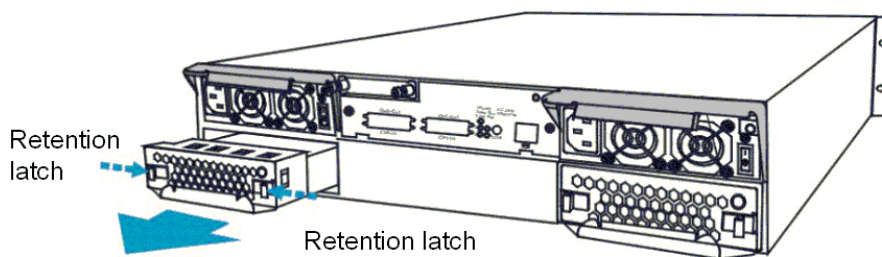

Fig. 6.6 Removing the Cooling Fan Module

CAUTION!

Forcing or slamming a module into place can damage the connector pins on the module itself or that on the subsystem backplane.

2. Install the new cooling fan module: Line the new module up with the slot into which it will be inserted and then gently push it into the chassis. The latches will hold the module in place.

6.7 Drive Tray Maintenance

6.7.1 Notes on Hard Drive Maintenance

- Hot-swappable drive trays: The drive trays are all hot-swappable. If a hard drive fails, it can be replaced while the subsystem is still running.
- Forearm handles: If the hard drive is behind either the left or right forearm handle, make sure that the locking mechanism on the side of the handle is first released prior to opening the handle itself. (See *Figure 6.7*) The locking mechanism must also be released in order to close the handle. Therefore, after the new drive has been installed, it will be necessary to release the locking mechanism on the handle prior to closing it.

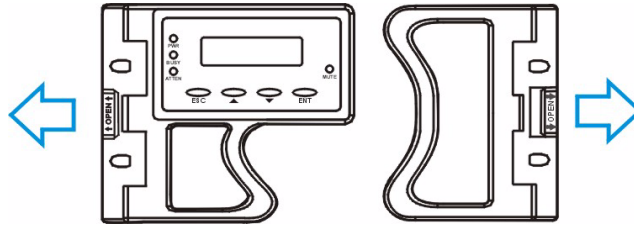

Fig. 6.7 Forearm Handle Locking Mechanism

- Front flap mechanism: Do not leave a drive tray's front flap open. The front flap and its key-lock secure a drive tray to chassis slot. A disk drive operating with the half-open front bezel may result in signal glitches and Data Compare Errors might ensue.
- Remove drives slowly: Although the drive trays are designed to be hot-swappable, when removing a drive tray from the subsystem, withdraw it from the chassis slowly. Removing the drive tray too quickly may cause a drive I/O timeout.
- Replacement on hand: If a hard drive has failed, make sure you have a replacement hard drive readily available before removing the failed drive from the subsystem. Do not leave the drive tray slot open for an extended period of time. If the drive tray slot is left unoccupied for an extended period of time, the airflow will be disrupted and subsystem components will overheat and may be permanently damaged.

6.7.2 Replacing a Failed Hard Drive

To replace a hard drive, please follow these steps:

CAUTION!

- Handle hard drives with extreme care. Hard drives are very delicate. Dropping a drive onto a hard surface (even from a short distance) and hitting or touching the circuits on the drives with your tools may all cause damage to drives.
 - Observe all ESD prevention methods when handling hard drives.
 - Only use screws supplied with the drive canisters. Longer screws may damage the drive.
-

CAUTION!

The hard drives and drive trays should only be installed into the subsystem once the subsystem has been mounted into a rack cabinet. If the hard drives are installed first, the subsystem will be too heavy to place into position and the possible impact during installation may damage your drives.

Hard drives for the subsystem can be purchased separately. When purchasing the hard drives, the following factors should be considered:

- Capacity (MB/GB): Use drives with the same capacity. RAID arrays use a “least-common-denominator” approach. The maximum capacity of each drive used in the array is the maximum capacity of the smallest drive. Use drives of the same capacity.
- Profile: The drive trays and bays of the system are designed for 3.5-inch wide x 1-inch high hard drives. It is highly recommended that you do not try to use drives of any other size.
- Drive type: The subsystem can use either SATA-II or SATA-I hard drives.

1. Identify the drive tray that contains the hard drive that needs to be replaced.

CAUTION!

Replacing the wrong drive in an array can fatally fail a RAID configuration. You should identify a failed drive from the Bosch RAIDWatch GUI screen, by checking the drive slot ID in the terminal screen, by checking the LEDs on the drive tray panel, and/or use the identify/flash drive function in firmware.

2. Open the front flap: Once the drive tray has been identified, push the release button at the drive bezel. (See *Figure 6.8*) The front bezel will automatically be lifted and the drive tray should be easily dislodged from the chassis.

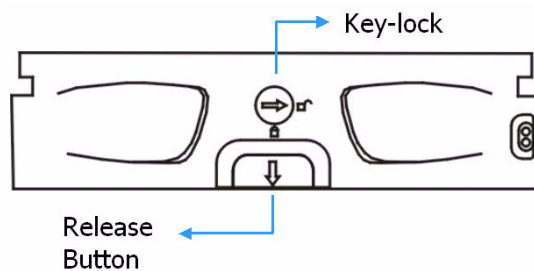

Fig. 6.8 Front View of an Individual Drive Tray

3. Remove the drive tray. To remove the drive tray from the enclosure, the key-lock must be unlocked. (See *Figure 6.9*) To do this, turn the key-lock on the front of the drive tray until the groove on its face is in a horizontal orientation.

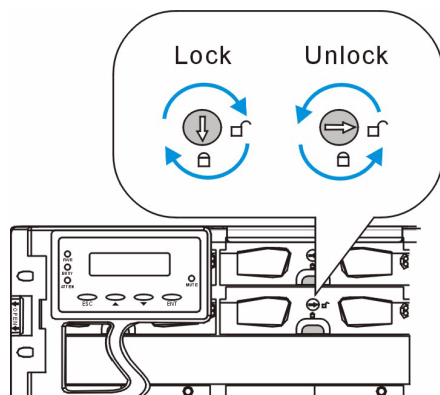

Fig. 6.9 Drive Tray Key-Lock Rotation

4. Remove the drive tray along with the hard drive in it. Once the drive tray is dislodged from the chassis, gently and carefully withdraw the drive tray from the chassis.
5. Remove the hard drive from the drive tray: Loosen the four retention screws (two on each side) to remove the hard drive from the drive tray.
6. Install the new hard drive:

7. Place the SATA hard drive into the drive tray (as shown in *Figure 6.10*) making sure that the hard drive is oriented in such a way that the drive's SATA connector is facing the back of the drive tray.

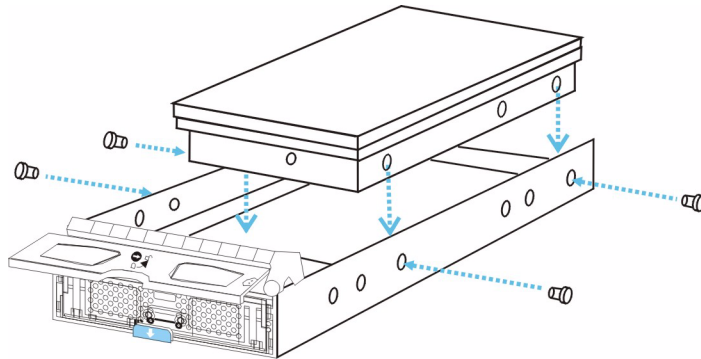

Fig. 6.10 Installing a SATA Hard Drive

8. Adjust the drive's location until the mounting holes in the drive canister are aligned with those on the hard drive. Secure the drive with four supplied 6/32 flathead screws. (See *Figure 6.10*)

CAUTION!

Only use screws supplied with the drive canisters. Longer screws may damage the drive.

9. If the failed drive is a member of a RAID 1, 3, or 5 array, once it is replaced the subsystem should immediately start to rebuild the array. The drive activity LEDs should start to flash.

7

Appendix: Technical Specifications

Environmental Specifications	
Humidity	5 to 95% (non condensing – operating and non-operating)
Temperature	Operating: 0° to 40°C Non-operating: -40° to 60°C
Altitude	Sea level to 12,000ft – operating Sea level to 20,000ft – non-operating

Power Requirements	
Input Voltage	115VAC @ 6A 240VAC @ 3A with PFC (auto-switching)
Frequency	47-63Hz
Power Consumption	350W

Dimensions	w/o front handles	w/ front handles
Height	88mm	88mm
Width	446mm	482mm
Length	490mm	505mm
Package dimensions: 344H x 600W x 670D mm		

System Weight
Net weight: 23.5kg Gross weight: 25.0kg (without disk drives)

EMI/EMC
FCC Class-B CE

Safety Requirements	
UL CB	

Shock	
Half-sine	Operating: 5G peak, 11ms duration Non-operating: 15G, 11ms, half-sine

Vibration	
Operating	0.5oct/min
Non-operating	0.5oct/min

Warning Alarms	
<ul style="list-style-type: none"> • LCD screen messages • Audible alarms • System LEDs • Event notification via the Bosch RAIDWatch Manager (LAN broadcast, email, fax, MSN, ICQ, SMS, and SNMP traps) and RS-232C terminal display 	

7.1 Controller Specifications

7.1.1 Configuration

Specifications	
RAID Levels	0, 1(0 + 1), 3, 5, 10, 30, 50, JBOD, and non-RAID disk spanning
Host OS Compatibility	Host OS independent; supports all major platforms
Host Interface	2 SCSI-320 channels via 2 dual-stacked VHDCI connectors
Host Channels	2 pre-configured SCSI-320 host channels
Drive Interface	Supports 8 channel connection to 3Gbps SATA-II disk drives, SATA-I backward compatible
Drive Channels	All drive channels are pre-configured, routed through a back-end PCB and cannot be changed
Caching Mode	Write-through or Write-back
Cache Memory	Pre-installed 256MB (or above) DDR RAM DIMM with/without ECC, in one DIMM socket
Number of LUN's	Up to 32 per host ID
Multiple Target IDs/ Host Channel	Yes
Firmware on Flash Memory	Yes

7.1.2 Architecture

Specifications	
CPU	IBM PowerPC 750CXr
Gigabit Ethernet	One 10/100BasedT for local or remote management access
DIMM Slot	One 184-pin DDR DIMM module
ASIC	64-bit chipset (ASIC266)
Flash ROM	32Mbit (4MB)
NVRAM	32KB with RTC
Hardware XOR	Yes
Real-time Clock	For event messages with time record tracking and scheduled maintenance tasks, e.g., Media Scan.

7.2 Drive Tray Specifications

Specifications	
Height	28mm
Width	110mm
Depth	218.92mm
Key Lock	Yes

7.3 Power Supply Specifications

Specifications	
Nominal Power	350W
DC Output	12.0V: 25A 5.0V: 25A 3.3V: 20A
Input Frequency	47 to 63Hz
AC Input	115VAC @ 6A or 240VAC @ 3A with PFC
Power Factor Correction	Yes
Hold-up Time	At least 16ms at 115/230VAC full load after a loss of AC input
Over-temperature Protection	Auto shutdown when cooling is lost or elevated temperature is detected; over-voltage protection is also available.
Cooling Fans	Two fans for each unit (inside PSU)

7.4 Cooling Module Specifications

Specifications	
Speed	High or low rotation speed controlled by firmware
Max. Air Flow (each module)	High speed: 31.8 CFM Low speed: 20.1 CFM
Input Power	9/3.12W max.
Rated Voltage	DC 12V
Temperature	Operating: -10 to +60°C Storage: -20 to +70°C

7.5 RAID Management

Specifications	
Configuration	LCD keypad panel Text-based firmware-embedded utility over RS-232C connection through the included audio jack-to-DB-9 serial cable The Bosch RAIDWatch Manager program using Ethernet connection
Performance Monitoring	Yes
Remote Control and Monitoring	Yes
Event Notification	Yes (via Bosch RAIDWatch's sub-modules, Configuration Client or NPC)
Management Connection	In-band over Ethernet, or RS-232C
Configuration on Disk	Configuration data stored on disk drives for logical drive assemblies to exist after controller replacement; basic settings, e.g., channel mode settings, are stored on NVRAM
Failure Indicator	Via audible alarm, LCD keypad panel, Bosch RAIDWatch Manager session, event notifications, or event prompts on terminal emulation

7.6 Fault Tolerance Management

Specifications	
SATA drive SMART support	Yes
Battery Back-up Option	Yes
ISEMS (Bosch Simple Enclosure Management Service) via I ² C Interface	Yes
Automatic Drive Failure Detection	Yes
Regenerate Logical Drive Parity	Yes
Bad Block Reassignment	Yes
Automatic Rebuild upon Failed Drive Replacement	Yes
Automatic Rebuild on Spare Drives	Yes
Manual Clone of Suspected Failed Drive	Yes
Concurrent rebuild on Multiple Drives in a RAID (0 + 1) Logical Drive	Yes
Salvage the 2 nd Temporarily Failed Drive in a RAID 1, 3 or 5 Logical Drive	Yes
Salvage the 1 st Temporarily Failed Drive in a RAID 0 Logical Drive	Yes

8 Appendix: Spare Parts and Accessories

8.1 Spare Parts

8.1.1 Spare Parts Overview

Except the RAID controller module, all the active components in the subsystems can be replaced while the system is running. If any of these components fails then it can, if configured in a fully redundant mode, be hot-swapped. Spare parts for the subsystems can be ordered separately. This section lists the model names for the different spare parts.

8.1.2 Spare Parts List

Table 8.1 lists the spare parts.

Model Name	Description
DVA-ADTK-000A	Drive tray, type-III bezel and type-II LED lightpipe.
DVA-ADTK-050A	Drive tray including 500 GB Hitachi SATA drive
DVA-ADTK-075A	Drive tray including 750 GB Hitachi SATA drive
DVA-SPKK-08A	Power supply module, E2U DDR-interface subsystems, 350W capacity.
DVA-SFAK-08A	Dual-speed version of cooling fan module: r 2U subsystems
DVA-SBBK-00A	Battery cell pack, Li-ION battery cells

Table 8.1 Spare Parts List

8.1.3 Controller Modules

Table 8.2 lists the control modules.

Model Name	Description
DVA-SCDK-08A	SCSI-to-SATA RAID controller module, 2 x SCSI-320 host channels, 8 x SATA II drive channels, 256MB DDR RAM.

Table 8.2 Controller Module List

8.2 Accessories and Optional Items

A number of accessory items are available for the RAID subsystem. Some of these accessory items come with the subsystem; but if damaged or if more accessory items are needed, they can be ordered separately. Available accessory items are listed below:

Model Name	Description
DVA-ACON-HD68A	SCSI external round cable, DB68-to-VHDCI
DVA-ACON-VD68A	External SCSI round cable, VHDCI-to-VHDCI * One included in the shipping package
DVA-ACON-VD680A	External SCSI round cable, VHDCI-to-VHDCI (0,5 m) * One included in the shipping package
DVA-ASRK-28A	Slide rails for 21"~28.5" deep racks
DVA-ASRK-36A	Slide rails for 23"~36" deep racks

Table 8.3 Accessories List

9 Appendix: Pinouts

9.1 SCSI Port: VHDCI Connector Pinouts

The SCSI port connector pinouts comply with specifications in T10 Working Draft, Project 1365D, SCSI Parallel Interface-4.

* NC = No Connection, * GND = Ground,

* TPWR = Terminator Power

Pin	Name	Pin	Name
1	SD12+	35	SD12-
2	SD13+	36	SD13-
3	SD14+	37	SD14-
4	SD15+	38	SD15-
5	SDP1+	39	SDP1-
6	SD0+	40	SD0-
7	SD1+	41	SD1-
8	SD2+	42	SD2-
9	SD3+	43	SD3-
10	SD4+	44	SD4-
11	SD5+	45	SD5-
12	SD6+	46	SD6-
13	SD7+	47	SD7-
14	SDP0+	48	SDP0-
15	GND	49	GND
16	DIFSENS	50	GND
17	TPWR	51	TPWR
18	TPWR	52	TPWR
19	NC	53	NC
20	GND	54	GND
21	SATN+	55	SATN-
22	GND	56	GND
23	SBSY+	57	SBSY-
24	SACK+	58	SACK-
25	SRST+	59	SRST-
26	SMSG+	60	SMSG-
27	SSEL+	61	SSEL-
28	SC_D+	62	SC_D-
29	SREQ+	63	SREQ-
30	SI_O+	64	SI_O-
31	SD8+	65	SD8-

Table 9.1 VHDCI Connector Pinouts

Pin	Name	Pin	Name
32	SD9+	66	SD9-
33	SD10+	67	SD10-
34	SD11+	68	SD11-

Table 9.1 VHDCI Connector Pinouts (Cont.)

9.2 COM1 Cable: DB9 and Audio Jack Pinouts

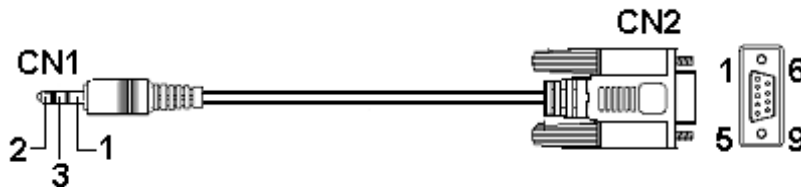

Fig. 9.1 Serial Port Cable CN1 and CN2 Connectors

CN1 Pin Number	Pin Name
1	Ground
2	TXD
3	RXD

CN2 Pin Number	Pin Name
1	NC
2	RXD
3	TXD
4	DTR
5	GND
6	DSR
7	RTS
8	CTS
9	NC
Pin 4 and Pin 6 are shorted	
Pin 7 and Pin 8 are shorted	

Table 9.2 COM 1 Cable, RS-232C (Audio Jack) Pin Out Definitions



NOTICE!

A null modem is used for wire-swap and is necessary for connecting in between COM1CN2 and a PC serial port.

9.3 Null Modem

Swap Pin 2 and Pin 3
Swap Pin 4 and Pin 6
Swap Pin 7 and Pin 8

Table 9.3 Null Modem Pinouts

9.4 Ethernet Port Pinouts

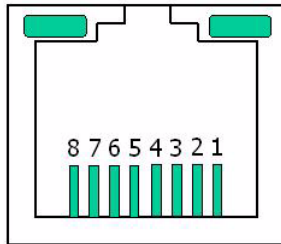

Fig. 9.2 LAN Port Pinouts

Pin	Pin Name	Pin	Pin Name
1	LAN_TXP	5	N2
2	LAN_TXN	6	LAN_RXN
3	LAN_RXP	7	N1
4	N2	8	N1

Table 9.4 Ethernet Port Pinouts

9.5 Main Power

IEC-type receptacle.

10 Index

A

airflow 20, 58
airflow clearance 20
ambient Temperature 38
array identification 12
audible alarm 17, 26, 32
audio jack 63
authorized battery disposal sites 21

B

backplane 11
BBU 10, 13, 38, 43
BBU module 14, 30
BBU Module LED 20
BBU Warnings 20
blower 15
Bosch RAIDWatch 17

C

cabinet installation 22
cabling 19
cached data 29
capacity 52
charge 14
component check 19
controller module 10, 13, 27, 42, 43
controller specifications 56
cooling fan module 10, 11, 15, 27, 31, 42
cooling module specifications 58
CPU 56

D

DB9 63
DIMM 43
DIMM module 43, 46
DIMM socket 45
drive bay 10, 52
drive IO timeout 51
drive tray 22, 24, 38, 52
drive trays 27

E

ejection handle 48
electrostatic discharge 19
Ethernet link 17
Ethernet port 14, 27, 64

F

firmware 17
front cabinet posts 23
front flap 24
front panel 9, 12
fully charged 47

G

GUI 17

H

handles 51
hard drive 38, 42, 52
host connection 35, 37
host redundancy 37
hot-swap mechanism 12
hot-swappable 42

components 18

I

I2C 26, 33
I2C bus 17
input voltage 54
international transportation regulation 14
Internet SCSI 7
iSCSI initiators 35

K

Key-Lock 52

L

LAN Port LED 29
LCD 39
LCD Panel 10
LCD Screen 39
LED 17

M

media scan 41
memory module 38
mini-SCSI connector 13

N

normalized airflow 18, 42
null modem 63

P

package dimensions 54
path redundancy 37
power cable 38
power cord 15
power down 41
power on 38
power socket 15
power supply specifications 57
power switch 15
PSU 10, 15, 42, 47
PSU Bracket 47
PSU Module 27

R

rack installation 19
rackmounting 23
rear brackets 23
rear panel 10, 12
regenerating logical drive parity 41
retention screws 47
RJ-45 35
RJ-45 port 14
RS-232C (Audio Jack) serial port 14

S

SATA drives 52
SCSI cable 35
sensors 31
shutdown controller 41
startup sequence 39
static free 19
status check 39
straight-through 35
system dimensions 54
system weight 54

T

terminal emulation program 17
terminal management 14
threshold values 32

U

under charge 29

V

ventilation clearance 20

W

warning alarms 55

X

XOR 56

Bosch Security Systems

Robert-Koch-Straße 100

D-85521 Ottobrunn

Germany

Telefon +49 (89) 6290-0

Fax +49 (89) 6290-1020

www.bosch-securitysystems.com

© Bosch Security Systems, 2008

Free Manuals Download Website

<http://myh66.com>

<http://usermanuals.us>

<http://www.somanuals.com>

<http://www.4manuals.cc>

<http://www.manual-lib.com>

<http://www.404manual.com>

<http://www.luxmanual.com>

<http://aubethermostatmanual.com>

Golf course search by state

<http://golfingnear.com>

Email search by domain

<http://emailbydomain.com>

Auto manuals search

<http://auto.somanuals.com>

TV manuals search

<http://tv.somanuals.com>