

LTC 9213/01, LTC 9225/00



Security Systems

EN | Instruction Manual
Pole Mount Adaptors

BOSCH

Important Safeguards

1. **Read, Follow, and Retain Instructions** - All safety and operating instructions should be read and followed before operating the unit. Retain instructions for future reference.
2. **Heed Warnings** - Adhere to all warnings on the unit and in the operating instructions.
3. **Attachments** - Attachments not recommended by the product manufacturer should not be used, as they may cause hazards.
4. **Installation Cautions** - Do not place this unit on an unstable stand, tripod, bracket, or mount. The unit may fall, causing serious injury to a person and serious damage to the unit. Use only manufacturer-recommended accessories, or those sold with the product. Mount the unit per the manufacturer's instructions. Appliance and cart combination should be moved with care. Quick stops, excessive force, or uneven surfaces may cause the appliance and cart combination to overturn.
5. **Cleaning** - Unplug the unit from the outlet before cleaning. Follow any instructions provided with the unit. Generally, using a damp cloth for cleaning is sufficient. Do not use liquid cleaners or aerosol cleaners.
6. **Servicing** - Do not attempt to service this unit yourself. Opening or removing covers may expose you to dangerous voltage or other hazards. Refer all servicing to qualified service personnel.
7. **Damage Requiring Service** - Unplug the unit from the main AC power source and refer servicing to qualified service personnel under the following conditions:
 - When the power supply cord or plug is damaged.
 - If liquid has been spilled or an object has fallen into the unit.
 - If the unit has been exposed to water and/or inclement weather (rain, snow, etc.).
 - If the unit does not operate normally, when following the operating instructions. Adjust only those controls specified in the operating instructions. Improper adjustment of other controls may result in damage, and require extensive work by a qualified technician to restore the unit to normal operation.
 - If the unit has been dropped or the cabinet damaged.
 - If the unit exhibits a distinct change in performance, this indicates that service is needed.
8. **Replacement Parts** - When replacement parts are required, the service technician should use replacement parts specified by the manufacturer or that have the same characteristics as the original part. Unauthorized substitutions may result in fire, electrical shock or other hazards.
9. **Safety Check** - Upon completion of servicing or repairs to the unit, ask the service technician to perform safety checks to ensure proper operating condition.
10. **Power Sources** - Operate the unit only from the type of power source indicated on the label. If unsure of the type of power supply to use, contact your dealer or local power company.
 - For units intended to operate from battery power, refer to the operating instructions.
 - For units intended to operate **with External Power Supplies**, use only the recommended approved power supplies.
 - For units intended to operate with a limited power source, this power source must comply with EN60950. Substitutions may damage the unit or cause fire or shock.
 - For units intended to operate at 24VAC, normal input voltage is **24VAC**. Voltage applied to the unit's power input should not exceed 30VAC. User-supplied wiring, from the 24VAC supply to unit, must be in compliance with electrical codes (Class 2 power levels). Do not ground the 24VAC supply at the terminals or at the unit's power supply terminals.
11. **Coax Grounding** - If an outside cable system is connected to the unit, ensure that the cable system is grounded. U.S.A. models only - Section 810 of the National Electrical Code, ANSI/NFPA No.70, provides information regarding proper grounding of the mount and supporting structure, grounding of the coax to a discharge unit, size of grounding conductors, location of discharge unit, connection to grounding electrodes, and requirements for the grounding electrode.
12. **Grounding** - This unit may be equipped with a 3-wire grounding plug (a plug with a third pin, for grounding). This safety feature allows the plug to fit into a grounding power outlet only. If unable to insert the plug into the outlet, contact an electrician to arrange replacement of the obsolete outlet. Do not defeat the safety purpose of the grounding plug.
 - Outdoor equipment should only be connected to the unit's inputs after this unit has had its grounding plug connected to a grounded outlet or its ground terminal properly connected to a ground source.
 - The unit's input connectors must be disconnected from outdoor equipment before disconnecting the grounding plug or grounding terminal.
 - Proper safety precautions such as grounding should be followed for any outdoor device connected to this unit.
13. **Lightning** - For added protection during a lightning storm, or when this unit is left unattended and unused for long periods of time, unplug the unit from the wall outlet and disconnect the cable system. This will prevent damage to the unit due to lightning and power line surges.

For Indoor Product

1. **Water and Moisture** - Do not use this unit near water - for example, in a wet basement, in an unprotected outdoor installation or in any area classified as a wet location.
2. **Object and Liquid Entry** - Never push objects of any kind into this unit through openings, as they might touch dangerous voltage points or create short circuits, resulting in a fire or electrical shock. Never spill liquid of any kind on the unit.
3. **Power Cord and Power Cord Protection** - For units intended to operate with 230VAC, 50Hz, the input and output power cord must comply with the latest versions of IEC Publication 227 or IEC Publication 245.
Power supply cords should be routed so they are not likely to be walked on or pinched. Pay particular attention to location of cords and plugs, convenience receptacles, and the point of exit from the appliance.
4. **Overloading** - Do not overload outlets and extension cords; this can result in a risk of fire or electrical shock.

For Outdoor Product

Power Lines - An outdoor system should not be located in the vicinity of overhead power lines, electric lights or power circuits, or where it may contact such power lines or circuits. When installing an outdoor system, extreme care should be taken to keep from touching power lines or circuits, as this contact might be fatal. U.S.A. models only - refer to the National Electrical Code Article 820 regarding installation of CATV systems.

For Rack-mount Product

1. **Ventilation** - Do not place this equipment in a built-in installation or rack, unless proper ventilation is provided, or the manufacturer's instructions were followed. The equipment must not exceed its maximum operating temperature requirements.
2. **Mechanical Loading** - When rack-mounting the equipment, ensure that a hazardous condition is not created by uneven mechanical loading.

Safety Precautions



CAUTION: TO REDUCE THE RISK OF ELECTRIC SHOCK, DO NOT REMOVE COVER (OR BACK). NO USER SERVICEABLE PARTS INSIDE. REFER SERVICING TO QUALIFIED SERVICE PERSONNEL.



This symbol indicates the presence of uninsulated dangerous voltage within the product's enclosure that can cause an electric shock.



This symbol indicates the presence of important operating and maintenance (servicing) instructions in the literature accompanying the appliance.



Installation should be performed by qualified service personnel only in accordance with the National Electrical Code or applicable local codes.



Power Disconnect. Units with or without ON-OFF switches have power supplied to the unit whenever the power cord is inserted into the power source; however, the unit is operational only when the ON-OFF switch is in the ON position. The power cord is the main power disconnect for all units.

Securite

Attention : l'installation doit exclusivement être réalisée par du

	ATTENTION RISQUE D'ÉLECTROCUTION. NE PAS OUVRIE!	
ATTENTION : POUR VITER TOUT RISQUE D'LECTROCUTION, N'ESSAYEZ PAS DE RETIRER LE CAPOT (OU LE PANNEAU ARR'ERE). CET APPAREIL NE CONTIENT AUCUN COMPOSANT SUSCEPTIBLE D'ÊTRE REPARÉ PAR L'UTILISATEUR. CONFIEZ LA REPARATION DE L'APPAREIL AU PERSONNEL QUALIFIÉ.		
	Ce symbole signale que le produit renferme une « tension potentiellement dangereuse » non isolée susceptible de provoquer une électrocution.	
	Ce symbole invite l'utilisateur à consulter les instructions d'utilisation et d'entretien (d'opération) reprises dans la documentation qui accompagne l'appareil.	
	personnel qualifié, conformément au code national d'électricité américain (NEC) ou au code d'électricité local en vigueur.	
	Coupure de l'alimentation. Qu'ils soient pourvus ou non d'un commutateur ON/OFF, tous les appareils reçoivent de l'énergie une fois le cordon branché sur la source d'alimentation. Toutefois, l'appareil ne fonctionne réellement que lorsque le commutateur est réglé sur ON. Le débranchement du cordon d'alimentation permet de couper l'alimentation des appareils.	

Precauciones de Seguridad

	ATTENZIONE PERICOLO DI SCARICA ELETTRICA. NON APRIE.	
PRECAUCI N: PARA DISMINUIR EL RIESGO DE DESCARGA ELCTRICA, NO RETIRE LA CUBIERTA (NI LA PARTE POSTERIOR). NO EXISTEN PIEZAS DE RECAMBIO EN EL INTERIOR DEL EQUIPO. EL PERSONAL DE SERVICIO CUALIFICADO SE ENCARGA DE REALIZAR LAS REPARACIONES.		
	Este símbolo indica que existen puntos de tensión peligrosos sin aislamiento dentro de la cubierta de la unidad. Estos puntos pueden constituir un riesgo de descarga eléctrica.	
	El usuario debe consultar las instrucciones de funcionamiento y mantenimiento (reparación) en la documentación que se suministra con el aparato.	
	Atención: la instalación la debe realizar únicamente personal cualificado de conformidad con el National Electric Code o las normas aplicables en su país.	
	Desconexión de la alimentación. Las unidades con o sin interruptores de encendido/apagado reciben alimentación eléctrica siempre que el cable de alimentación está conectado a la fuente de alimentación. Sin embargo, la unidad solo funciona cuando el interruptor está en la posición de encendido. El cable de alimentación es la principal fuente de desconexión de todas las unidades.	

Sicherheitshinweise

	VORSICHT ELEKTRISCHE SPANNUNG. NICHT ÖFFNE!	
VORSICHT: UM EINEN ELEKTRISCHEN SCHLAG ZU VERMEIDEN, IST DIE ABDECKUNG (ODER RÜCKSEITE) NICHT ZU ENTFERNEN. ES BEFINDEN SICH KEINE TEILE IN DIESEM BEREICH, DIE VOM BENUTZER GEWARTET WERDEN KÖNNEN. LASSEN SIE WARTUNGSARBEITEN NUR VON QUALIFIZIERTEM WARTUNGSPERSONAL AUSFÜHREN.		
	Das Symbol macht auf nicht isolierte gefährliche Spannung im Gehäuse aufmerksam. Dies kann zu einem elektrischen Schlag führen.	
	Der Benutzer sollte sich ausführlich über Anweisungen für die Bedienung und Instandhaltung (Wartung) in den begleitenden Unterlagen informieren.	
	Achtung! Die Installation sollte nur von qualifiziertem Kundendienstpersonal gemäß jeweils zutreffender Elektrovorschriften ausgeführt werden.	
	Unterbrechung des Netzanschlusses. Geräte mit oder ohne Netzschalter haben Spannung am Gerät anliegen, sobald der Netzstecker in die Steckdose gesteckt wird. Das Gerät ist jedoch nur betriebsbereit, wenn der Netzschalter (EIN/AUS) auf EIN steht. Wenn das Netzkabel aus der Steckdose gezogen wird, ist die Spannungszuführung zum Gerät vollkommen unterbrochen.	

Veiligheidsmaatregelen

	VOORZICHTIG GEVAAR VOOR ELEKTRISCHE SCHOK. NIET OPENEN	
VOORZICHTIG: OPEN DE BEHUIZING OF DE ACHTERKANT VAN HET APPARAAT NIET. ZO VERMINDERT U HET RISICO OP ELEKTRISCHE SCHOKKEN. IN HET APPARAAT BEVINDEN ZICH GEEN ONDERDELEN DIE U ZELF KUNT REPAREREN. LAAT SERVICE EN ONDERHOUD UITVOEREN DOOR GEKWALIFICEERD PERSONEEL.		
	Dit symbool geeft aan dat er binnen in het apparaat ongeïsoleerde, gevaarlijke spanning aanwezig is die mogelijk elektrische schokken kan veroorzaken.	
	De gebruiker dient de bedienings- en onderhoudsvorschriften te raadplegen in de documentatie die werd meegeleverd met het apparaat.	
	Attentie: het apparaat mag alleen door gekwalificeerd personeel worden geïnstalleerd. De installatie dient in overeenstemming met de nationale elektrische richtlijnen of de van toepassing zijnde lokale richtlijnen te worden uitgevoerd.	
	Spanning uitschakelen. Apparatuur met of zonder aan-uitschakelaar staat onder spanning zolang de stekker is aangesloten op de wandcontactdoos. De apparatuur is uitsluitend in werking als de aan-uitschakelaar aan staat. Het netsnoer is de "hoofdschakelaar" voor alle apparatuur.	



Sicurezza

	ATTENZIONE RISCHIO DI SCOSSE ELETTRICHE. NON APRIRE.	
ATTENZIONE: PER RIDURRE IL RISCHIO DI SCOSSE ELETTRICHE NON RIMUOVERE LA COPERTURA (O IL PANNELLO POSTERIORE). L'UNIT NON CONTIENE COMPONENTI INTERNI RIPARABILI DALL'UTENTE. PER QUALSIASI INTERVENTO, RIVOLGERSI A PERSONALE TECNICO QUALIFICATO.		
	Questo simbolo indica la presenza di "tensione pericolosa" non isolata all'interno del contenitore del prodotto. Ci comporta un potenziale rischio di scosse elettriche.	
	Si consiglia di consultare le istruzioni operative e di manutenzione (interventi tecnici) contenute nella documentazione fornita con il dispositivo.	
	Attenzione: l'installazione deve essere effettuata esclusivamente da personale tecnico qualificato in conformità con il National Electrical Code o con le normative locali vigenti.	
	Scollamento dell'alimentazione. Le unit dotate o sprovviste di interruttori ON-OFF vengono alimentate quando si inserisce il cavo nella presa dell'alimentazione. L'unit tuttavia in funzione solo quando l'interruttore ON-OFF si trova nella posizione ON. Il cavo di alimentazione costituisce il dispositivo di scollamento dell'alimentazione principale per tutte le unit.	

安全预防措施

	CAUTION RISK OF ELECTRIC SHOCK. DO NOT OPEN.	
注意：为避免受到电击，不要拆除机盖（或后盖），用户不得擅自维修里面的部件。有关维修事项，请咨询合格的维修人员。		
	此符号表示产品机壳内存在未绝缘的“危险电压”。这可能导致电击。	
	用户应参照设备附带的操作和维护（维修）说明。	
	注意：安装须由合格的维修人员遵照英国国家电工标准或相关电气规则进行。	
	断开电源。在电源线插入电源时，配备或未配备 ON OFF 开关的设备都已通电。但设备只有在 ON OFF 开关处于 ON 位置时才能工作。对于所有设备，电源线是断开电源的主要方式。	

Medidas de Seguridad

	CUIDADO RISCO DE CHOQUE ELÉCTRICO. NÃO ABRIRE.	
CUIDADO: PARA REDUZIR O RISCO DE CHOQUE ELÉCTRICO, N'O RETIRE A TAMPA (OU A PARTE POSTERIOR). NO INTERIOR, N'O EXISTEM PE AS QUE POSSAM SER REPARADAS PELO UTILIZADOR. REMETA A ASSISTÊNCIA PARA OS TÉCNICOS QUALIFICADOS.		
	Este símbolo indica a presença de "tensão perigosa" não isolada dentro da estrutura do produto, o que pode constituir risco de choque elétrico.	
	O utilizador deve consultar as instruções de funcionamento e manutenção (assistência) nos documentos que acompanham o aparelho.	
	Atenção: a instalação deve ser executada apenas por técnicos qualificados da assistência, de acordo com o código elétrico nacional ou os códigos locais aplicáveis.	
	Corte de corrente. As unidades com ou sem interruptores ON-OFF (ligar/desligar) recebem corrente sempre que o fio de alimentação está introduzido na fonte de alimentação; contudo, a unidade apenas está operacional quando o interruptor ON-OFF está na posição ON. O fio de alimentação destina-se a desligar a corrente em todas as unidades.	

1.0 UNPACKING

This equipment should be unpacked and handled with care. If an item appears to have been damaged in shipment, notify the shipper.

Verify that all parts shown in the *Parts List* have been included. If any items are missing, notify your Bosch Security Systems Sales or Customer Service Representative.

The original packing carton is the safest container in which to transport the unit. Save it for possible future use.

1.1 Parts List

Qty	Item
1	Unit (verify model number)
1	This installation manual
1	BAND-IT ^{fi} Tool instruction chart
1	Mounting bracket
	LTC 9213/01 Hardware kit
1	Structural band strap, 3 m (10 ft)
4	Screw, hex head, M8 x 25
4	Washer, spiral lock, M8
4	Screw, oval head, # 6-32
	LTC 9225/00 Hardware kit
1	Structural band strap, 3 m (10 ft), that must be cut into two (2) 1.5 m (5 ft) lengths
2	Band buckle
6	Screw, hex head, M12 x 35
6	Nut, hex, M12
6	Washer, spiral lock, M2
6	Washer, plain, M12

2.0 SERVICE

If the unit needs servicing, contact the nearest Bosch Security Systems Service Center for authorization to return and shipping instructions.

Service Centers

USA

Phone: 800-366-2283 or 717-735-6638

Fax: 800-366-1329 or 717-735-6639

CCTV Spare Parts

Phone: 800-894-5215 or 408-956-3853 or 3854

Fax: 408-957-3198

E-mail: BoschCCTVparts@ca.slr.com

Canada

Phone: 514-738-2434

Europe, Middle East & Asia Pacific Region

Phone: 32-1-440-0711

For additional information, see

www.boschsecurity.com.

3.0 DESCRIPTION

The LTC 9213/00 and LTC 9225/00 Pole Mount Adapters are designed to permit the installation of indoor/outdoor wall mounts to a pole capable of supporting the total weight of equipment installed. The pole can range from 76 mm (3 in.) to 381 mm (15 in.) in diameter.

4.0 INSTALLATION



WARNING: This installation should be made by a qualified service person and conform to all local codes.

4.1 Mount Compatibility

Pole Mount Adapter	Suggested Wall Mounts	Maximum Rated Load
LTC 9213/01	LTC 9212/00	9 kg (20 lb)
	LTC 9215/00	9 kg (20 lb)
	LTC 9215/00S	9 kg (20 lb)
LTC 9225/00	LTC 9216/00	45 kg (100 lb)
	LTC 9222/00	90 kg (200 lb)

4.2 Tools Required

4.2.1 LTC 9213/01 Pole Mount Adapter

8 mm Hex wrench

Banding tool (TC9311PM3T is recommended)

4.2.2 LTC 9225/00 Pole Mount Adapter

12 mm Hex wrench

Banding tool (TC9311PM3T is recommended)

4.3 Mounting

1. Cut the structural band strap into two (2) 1.5 m (5 ft) straps.
2. Attach the bracket to the pole at the band desired height using the two (2) straps and the two (2) buckles provided.
3. Tension the straps according to the instructions for the banding tool used. Banding tool, TC9311PM3T, is recommended and may be purchased separately. A BAND-IT^{fi} Tool instruction chart is provided with each pole mount. The ends of the bands are bent around the buckle (see *Figure 1*).

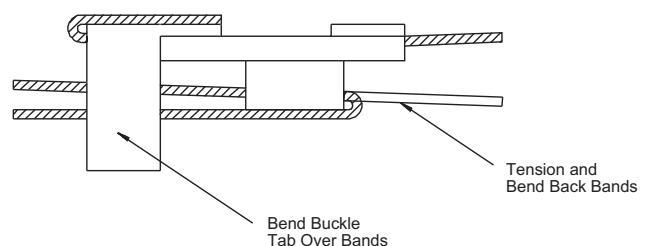

Figure 1: Bending Method

- For model LTC 9213/01 with an LTC 9212/00, LTC 9215/00, or an LTC 9215/00S, secure the wall mount to the pole mount using the four (4) 8 mm screws and lock washers provided. Use the four larger holes that are in a square pattern around the center (see *Figure 2*).

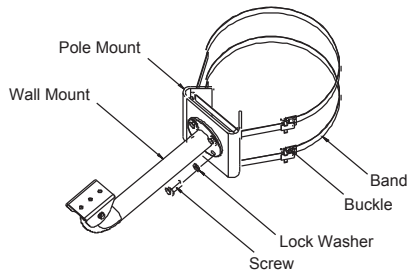

Figure 2: Securing the LTC 9213/01 with an LTC 9212/00, LTC 9215/00 or an LTC 9215/00S

- For model LTC 9213/01 with an LTC 1348/00, secure the wall mount to the pole mount using the four (4) No. 6 screws provided. Use the four (4) smaller holes that are in a rectangular pattern.
- For model LTC 9225/00 with an LTC 9216/00 or an LTC 9222/00, secure the wall mount to the pole mount using the six (6) 12 mm screws, plain washers, lock washers and nuts provided (see *Figure 3*).

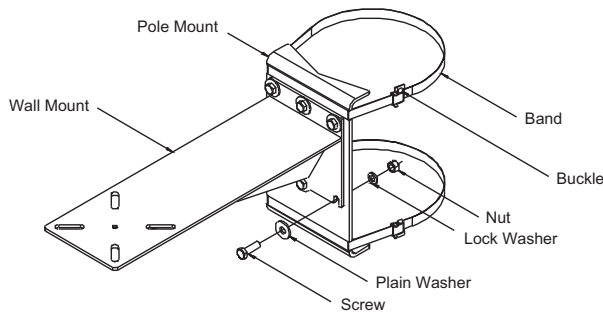

Figure 3: Securing the LTC 9225/00 with an LTC 9216/00 or an LTC 9222/00

5.0 SPECIFICATIONS

5.1 LTC 9213/01, LTC 9225/00 Pole Mount Adapters

Construction: Formed aluminum plate

Finish: Light gray

Weight:

LTC 9213/01: 0.5 kg (1 lb)

LTC 9225/00: 1.4 kg (3 lb)

LTC 9213/01 Pole Mount Adaptor

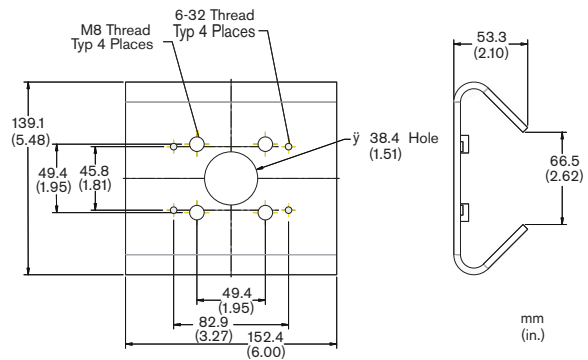

LTC 9225/00 Pole Mount Adaptor

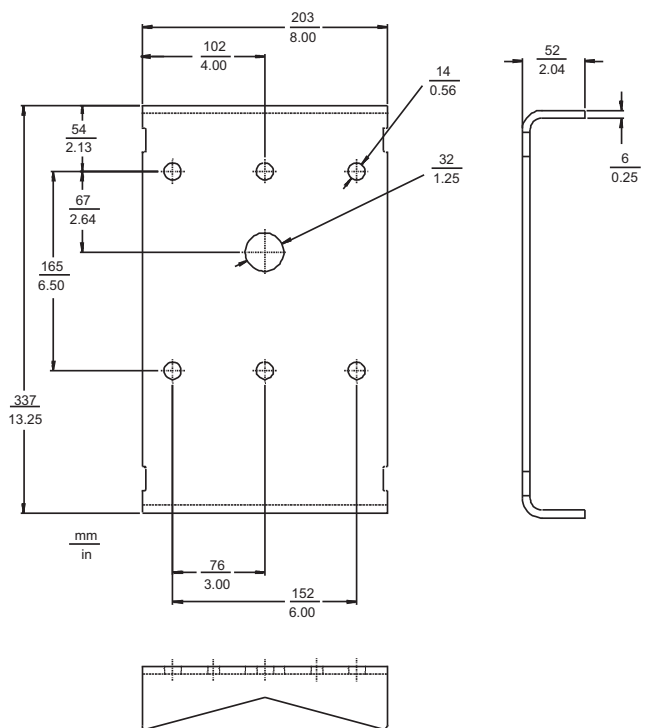

Americas

Bosch Security Systems
130 Perinton Parkway
Fairport, New York, 14450, USA
Phone: +1 (585) 223 4060
+1 800 289 0096
security.sales@us.bosch.com
<http://www.boschsecurity.us>

Europe, Middle East, Africa

Bosch Security Systems B.V.
P.O. Box 80002
5600 JB Eindhoven, The Netherlands
Phone: +31 (0) 40 27 83955
Fax: +31 (0) 40 27 86668
emea.securitysystems@bosch.com
<http://www.boschsecurity.com>

Asia-Pacific

Bosch Security Systems Pte Ltd
38C Jalan Pemimpin
Singapore 577180
Phone: +65 6319 3450
Fax: +65 6319 3499
apr.securitysystems@bosch.com
<http://www.boschsecurity.com>

© 2008 Bosch Security Systems GmbH
F01U122758 | Updated December 23, 2008 | Data subject to change without notice.

BAND-ITfi is a registered trademark of IDEX Corporation.

BOSCH

Free Manuals Download Website

<http://myh66.com>

<http://usermanuals.us>

<http://www.somanuals.com>

<http://www.4manuals.cc>

<http://www.manual-lib.com>

<http://www.404manual.com>

<http://www.luxmanual.com>

<http://aubethermostatmanual.com>

Golf course search by state

<http://golfingnear.com>

Email search by domain

<http://emailbydomain.com>

Auto manuals search

<http://auto.somanuals.com>

TV manuals search

<http://tv.somanuals.com>