



# Integrated IR Bullet Camera

## WZ18



**BOSCH**

en Installation Manual



## Table of Contents

|          |                                     |           |
|----------|-------------------------------------|-----------|
| <b>1</b> | <b>Safety</b>                       | <b>5</b>  |
| 1.1      | Important safety instructions       | 5         |
| 1.2      | Important safety instructions       | 6         |
| 1.3      | Important notices                   | 7         |
| 1.4      | Customer Support and Service        | 14        |
| <b>2</b> | <b>Features</b>                     | <b>16</b> |
| <b>3</b> | <b>Box Contents</b>                 | <b>17</b> |
| <b>4</b> | <b>Camera Parts and Adjustments</b> | <b>18</b> |
| <b>5</b> | <b>Installation</b>                 | <b>19</b> |
| 5.1      | Mounting Position                   | 19        |
| 5.2      | Monitor Connection                  | 20        |
| <b>6</b> | <b>Dimensions</b>                   | <b>21</b> |
| <b>7</b> | <b>Specifications</b>               | <b>22</b> |

|          |                          |           |
|----------|--------------------------|-----------|
| <b>8</b> | <b>OSD Manual</b>        | <b>23</b> |
| 8.1      | Lens Menu                | 23        |
| 8.2      | Exposure Menu            | 23        |
| 8.3      | White Balance Menu       | 24        |
| 8.4      | Day & Night Menu         | 24        |
| 8.5      | Image Menu               | 24        |
| 8.6      | 3DNR Balance Menu        | 25        |
| 8.7      | Special Menu             | 25        |
| 8.8      | Reset Menu               | 25        |
| 8.9      | OSD Function Description | 26        |
| 8.9.1    | Lens                     | 26        |
| 8.9.2    | Exposure                 | 26        |
| 8.9.3    | White Balance            | 27        |
| 8.9.4    | Day and Night            | 27        |
| 8.9.5    | Image                    | 28        |
| 8.9.6    | 3DNR                     | 28        |
| 8.9.7    | Special                  | 29        |
| 8.9.8    | Reset                    | 30        |

# 1 Safety

## 1.1 Important safety instructions

---

**WARNING!**

TO REDUCE THE RISK OF ELECTRIC SHOCK, DO NOT REMOVE COVER (OR BACK). NO USER SERVICEABLE PARTS INSIDE. REFER SERVICING TO QUALIFIED SERVICE PERSONELL.

---

**WARNING!**

This is a class A product. In a domestic environment this product may cause radio interference in which case the user may be required to take adequate measures.

---

**CAUTION!**

Any changes or modifications in construction of this device which are not expressly approved by the party responsible for compliance could void the user's authority to operate the equipment.

---

**CAUTION!**

These servicing instructions are for use by qualified service personnel only.  
To reduce the risk of electric shock do not perform any servicing other than that contained in the operating instructions unless you are qualified to do so.  
In USA and Canada, use a Class 2 power supply only.

---

**NOTICE!**

After adjusting zoom and focus, to prevent water infiltration, firmly tighten the zoom and focus lever. (Rep: 10) When you install the camera, please glue up the end of cable to keep it stable in order to protect the camera from the humidity problems. (Rep: 11)

---

## 1.2 Important Safety Instructions

1. Read these instructions.
2. Keep this instruction.
3. Heed all warnings.
4. Follow all instructions.
5. Do not use this apparatus near water.
6. Clean only with dry cloth.
7. Do not block any ventilation openings. Install in accordance with manufacturer instructions.
8. Do not install near any heat sources such as radiators, heat registers, stoves or other apparatus (including amplifiers) that produce heat.
9. Do not defeat the safety purpose of the polarized or grounding-type plug. A polarized plug has two blades with one wider than the other. A grounding type plug has two blades and a third grounding prong. The wide blade or the third prong is provided for your safety. If the provided plug does not fit into your outlet, consult an electrician for replacement of the obsolete outlet.
10. Protect the power cord from being walked on or pinched particularly at plugs, convenience receptacles, and the power where they exit from the apparatus.
11. Only use attachments/accessories specified by the manufacturer.
12. Use only with the cart, stand, tripod, bracket, or table specified by the manufacturer, or sold with the apparatus. When a cart is used, use caution when moving the cart/apparatus combination to avoid injury from tip-over.



13. Unplug this apparatus during lightning storms or when unused for long periods of time.

14. Refer all servicing to qualified service personnel. Servicing is required when the apparatus has been damaged in a way, such as power-supply cord or plug is damaged, liquid has been spilled or objects have fallen into the apparatus, the apparatus has been exposed to rain or moisture, does not operate normally, or has been dropped.

## 1.3 Important Safety Instructions

---

### CAUTION!



1. A regulated DC12V 1A power supply is recommended for use with this camera for the best picture and the most stable operation. An unregulated power supply can cause damage to the camera. When unregulated power supply is applied, product warranty will be out of subject.
2. It is recommended that the camera is used with a monitor that has a CCTV quality 75 Ohm video impedance level. If your monitor is switched to high impedance then please adjust accordingly.
3. Do not attempt to disassemble the camera to gain access to the internal compounds. Refer servicing to your dealer.
4. Never face the camera towards the sun or any bright or reflective light, which may cause smear on the picture and possible damage to the CCD.
5. Do not remove the serial sticker for the warranty service.

---

**All-pole power switch** - Incorporate an all-pole power switch, with a contact separation of at least 3 mm in each pole, into the electrical installation of the building. If it is needed to open the housing for servicing and/or other activities, use this all-pole switch as the main disconnect device for switching off the voltage to the unit.

**Camera grounding** - For mounting the camera in potentially damp environments, ensure to ground the system using the ground connection of the power supply connector (see section: Connecting external power supply).

**Camera lens** - An assembled camera lens in the outdoor housing must comply and be tested in accordance with UL/IEC60065. Any output or signal lines from the camera must be SELV or Limited Power Source. For safety reasons the environmental specification of the camera lens assembly must be within the environmental specification of -10 °C (14 °F) to 50 °C (122 °F).

**Camera signal** - Protect the cable with a primary protector if the camera signal is beyond 140 feet, in accordance with NEC800 (CEC Section 60).

**Coax grounding:**

- Ground the cable system if connecting an outside cable system to the unit.
- Connect outdoor equipment to the unit's inputs only after this unit has had its grounding plug connected to a grounded outlet or its ground terminal is properly connected to a ground source.
- Disconnect the unit's input connectors from outdoor equipment before disconnecting the grounding plug or grounding terminal.
- Follow proper safety precautions such as grounding for any outdoor device connected to this unit.

**U.S.A. models only** - Section 810 of the National Electrical Code, ANSI/NFPA No.70, provides information regarding proper grounding of the mount and supporting structure, grounding of the coax to a discharge unit, size of grounding conductors, location of discharge unit, connection to grounding electrodes, and requirements for the grounding electrode.



Disposal - Your Bosch product was developed and manufactured with high-quality material and components that can be recycled and reused. This symbol means that electronic and electrical appliances, which have reached the end of their working life, must be collected and disposed of separately from household waste material. Separate collecting systems are usually in place for disused electronic and electrical products. Please dispose of these units at an environmentally compatible recycling facility, per European Directive 2002/96/EC.



**Electronic Surveillance** - This device is intended for use in public areas only. U.S. federal law strictly prohibits surreptitious recording of oral communications.

**Environmental statement** - Bosch has a strong commitment towards the environment. This unit has been designed to respect the environment as much as possible.

**Electrostatic-sensitive device** - Use proper CMOS/MOS-FET handling precautions to avoid electrostatic discharge.

NOTE: Wear required grounded wrist straps and observe proper ESD safety precautions when handling the electrostaticsensitive printed circuit boards.

**Fuse rating** - For security protection of the device, the branch circuit protection must be secured with a maximum fuse rating of 16A. This must be in accordance with NEC800 (CEC Section 60).

**Moving** - Disconnect the power before moving the unit. Move the unit with care. Excessive force or shock may damage the unit and the hard disk drives.

**Outdoor signals** - The installation for outdoor signals, especially regarding clearance from power and lightning conductors and transient protection, must be in accordance with NEC725 and NEC800 (CEC Rule 16-224 and CEC Section 60).

**Permanently connected equipment** - Incorporate a readily accessible disconnect device in the building installation wiring.

**Pluggable equipment** - Install the socket outlet near the equipment so it is easily accessible.

**Power resupply** - If the unit is forced to power down due to exceeding the specified operating temperatures, disconnect the power cord, wait for at least 30 seconds, and then reconnect the power cord.

**Power lines** - Do not locate the camera near overhead power lines, power circuits, or electrical lights, nor where it may contact such power lines, circuits, or lights.

**Rack-mount**

- Ventilation - Do not place this unit in a built-in installation or rack without proper ventilation or adhering to the manufacturer's instructions. The equipment must not exceed its maximum operating temperature requirements.
- Mechanical loading - Properly mount the equipment in a rack to prevent a hazardous condition due to uneven mechanical loading.

**SELV**

All the input/output ports are Safety Extra Low Voltage (SELV) circuits. SELV circuits should only be connected to other SELV circuits.

Because the ISDN circuits are treated like telephone-network voltage, avoid connecting the SELV circuit to the Telephone Network Voltage (TNV) circuits.

The system ground is only used to comply with safety standards or installation practices in certain countries. Bosch does not recommend connecting system ground to safety ground unless it is explicitly required. However, if the system ground and safety ground are connected and grounding loops are causing interference in the video signal, use an isolation transformer (available separately from Bosch).

**CAUTION!**

Connecting System ground to Safety ground may result in ground loops that can disrupt the CCTV system.

---

**Video loss** - Video loss is inherent to digital video recording; therefore, Bosch Security Systems cannot be held liable for any damage that results from missing video information. To minimize the risk of lost digital information, Bosch Security Systems recommends multiple, redundant recording systems, and a procedure to back up all analog and digital information.

## FCC & ICES Information

(U.S.A. and Canadian Models Only)

This equipment has been tested and found to comply with the limits for a **Class A** digital device, pursuant to part 15 of the FCC Rules. These limits are designed to provide reasonable protection against harmful interference in a **commercial environment**. This equipment generates, uses, and can radiate radio frequency energy and, if not installed and used in accordance with the instructions, may cause harmful interference to radio communications. However, there is no guarantee that interference will not occur in a particular installation. If this equipment does cause harmful interference to radio or television reception, which can be determined by turning the equipment off and on, the user is encouraged to try to correct the interference by one or more of the following measures:

- reorient or relocate the receiving antenna;
- increase the separation between the equipment and receiver;
- connect the equipment into an outlet on a circuit different from that to which the receiver is connected;
- consult the dealer or an experienced radio/TV technician for help.

Intentional or unintentional modifications, not expressly approved by the party responsible for compliance, shall not be made. Any such modifications could void the user's authority to operate the equipment. If necessary, the user should consult the dealer or an experienced radio/television technician for corrective action.

The user may find the following booklet, prepared by the Federal Communications Commission, helpful: How to Identify and Resolve Radio-TV Interference Problems. This booklet is available from the U.S. Government Printing Office, Washington, DC 20402, Stock No. 004-000-00345-4.

## INFORMATIONS FCC ET ICES

(modèles utilisés aux États-Unis et au Canada uniquement)

Suite à différents tests, cet appareil s'est révélé conforme aux exigences imposées aux appareils numériques de **classe A**, en vertu de la section 15 du règlement de la Commission fédérale des communications des États-Unis (FCC), et en vertu de la norme ICES-003 d'Industrie Canada. Ces exigences visent à fournir une protection raisonnable contre les interférences nuisibles lorsque l'appareil est utilisé dans le cadre d'un **environnement commercial**. Cet appareil génère, utilise et émet de l'énergie de radiofréquences et peut, en cas d'installation ou d'utilisation non conforme aux instructions, engendrer des interférences nuisibles au niveau des radiocommunications. Toutefois, rien ne garantit l'absence d'interférences dans une installation particulière. Il est possible de déterminer la production d'interférences en mettant l'appareil successivement hors et sous tension, tout en contrôlant la réception radio ou télévision. L'utilisateur peut parvenir à éliminer les interférences éventuelles en prenant une ou plusieurs des mesures suivantes:

- Modifier l'orientation ou l'emplacement de l'antenne réceptrice;
- Éloigner l'appareil du récepteur;
- Brancher l'appareil sur une prise située sur un circuit différent de celui du récepteur;
- Consulter le revendeur ou un technicien qualifié en radio/télévision pour obtenir de l'aide.

Toute modification apportée au produit, non expressément approuvée par la partie responsable de l'appareil, est strictement interdite. Une telle modification est susceptible d'entraîner la révocation du droit d'utilisation de l'appareil. La brochure suivante, publiée par la Commission fédérale des communications (FCC), peut s'avérer utile : How to Identify and Resolve Radio-TV Interference Problems (Comment identifier et résoudre les problèmes d'interférences de radio et de télévision). Cette brochure est disponible auprès du U.S. Government Printing Office, Washington, DC 20402, États-Unis, sous la référence n° 004-000-00345-4.

**Disclaimer**

Underwriter Laboratories Inc. ("UL") has not tested the performance or reliability of the security or signaling aspects of this product. UL has only tested fire, shock and/or casualty hazards as outlined in UL's Standard(s) for Safety for Audio, Video and Similar Electronic Apparatus. Safety Requirements UL 60065. UL Certification does not cover the performance or reliability of the security or signaling aspects of this product. UL MAKES NO REPRESENTATIONS, WARRANTIES, OR CERTIFICATIONS WHATSOEVER REGARDING THE PERFORMANCE OR RELIABILITY OF ANY SECURITY OR SIGNALING RELATED FUNCTIONS OF THIS PRODUCT.

**Copyright**

This manual is the intellectual property of Bosch Security Systems and is protected by copyright.  
All rights reserved.

**Trademarks**

All hardware and software product names used in this document are likely to be registered trademarks and must be treated accordingly.

**NOTE!**

This manual has been compiled with great care and the information it contains has been thoroughly verified. The text was complete and correct at the time of printing. The ongoing development of the products may mean that the content of the user guide can change without notice. Bosch Security Systems accepts no liability for damage resulting directly or indirectly from faults, incompleteness or discrepancies between the user guide and the product described.

**More information**

For additional information, please contact the Bosch Security Systems location nearest you or visit our web site at [www.boschsecurity.com](http://www.boschsecurity.com)

## 1.4 Customer Support and Service

---

If this unit needs service, contact the nearest Bosch Security Systems Service Center for authorization to return and shipping instructions.

### **Service Centers**

#### **USA**

##### **Repair Center-**

Telephone: 800-566-2283

Fax: 800-366-1329

E-mail: [repair@us.bosch.com](mailto:repair@us.bosch.com)

##### **Customer Service**

Telephone: 888-289-0096

Fax: 585-223-9180

E-mail: [security.sales@us.bosch.com](mailto:security.sales@us.bosch.com)

##### **Technical Support**

Telephone: 800-326-1450

Fax: 585-223-3508 or 717-735-6560

E-mail: [technical.support@us.bosch.com](mailto:technical.support@us.bosch.com)

#### **Canada**

Telephone: 514-738-2434

Fax: 514-738-8480

Europe, Middle East, Africa Region

##### **Repair Center**

Telephone: 31 (0) 76-5721500

Fax: 31 (0) 76-5721413

E-mail: [RMADesk.STService@nl.bosch.com](mailto:RMADesk.STService@nl.bosch.com)

#### **Asia Region**

##### **Repair Center**

Telephone: 65 63522776

Fax: 65 63521776

E-mail: [rmahelpdesk@sg.bosch.com](mailto:rmahelpdesk@sg.bosch.com)

##### **Customer Service**

Telephone: 86 (0) 756 7633117 or

86 (0) 756 7633121

Fax: 86 (0) 756 7631710

E-mail: [customer.service@cn.bosch.com](mailto:customer.service@cn.bosch.com)

**Warranty and more information**

For additional information and warranty queries, please contact your Bosch Security Systems representative or visit our website at [www.boschsecurity.com](http://www.boschsecurity.com).

## 2 Features

### **Excellent image quality under all conditions**

- High resolution 540 TVL image
- Dual window design, eliminating IR glare
- Suitable for indoor and outdoor use (IP66 rated)

### **Designed for day and night vision**

- 1/3-in. Super-HAD CCD II sensor
- 20 IR LED's providing 20 meters of vision in complete

### **darkness and with adjustable output power**

- Day/Night function, automatically switching between day (color) mode and night (black/white with IR) modes

### **Advanced digital video processing**

- 10-bit image processing
- Digital Noise Reduction (DNR) for optimum night time images
- Privacy mask function allows blanking of specific areas of the scene
- Multi language On-screen Display (OSD) control, allowing camera configuration on the monitor screen

### **Easy to install**

- Mounting bracket included with cable feed-through
- External focus and zoom control (no need to dismantle the camera)
- Universal 12 VDC or 24 VAC power input



### 3 Box Contents

#### WZ18 Bullet Camera

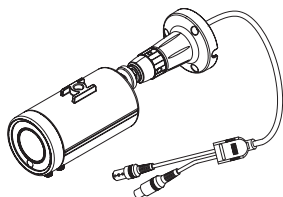

#### Sunshield



#### Video Output Test Cable



#### L-Wrench Screws (3) Sunshield Fixing Bolt



#### Operation Manual (this book)

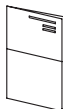

## 4 Camera Parts and Adjustments

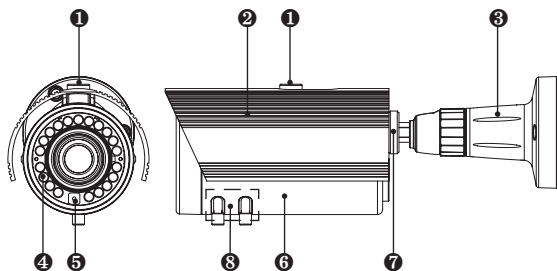

|   |                       |   |                                    |
|---|-----------------------|---|------------------------------------|
| 1 | Sunshield Fixing Bolt | 5 | Photo cell                         |
| 2 | Sunshield             | 6 | Body                               |
| 3 | Mounting Bracket      | 7 | Body Fixing Ring                   |
| 4 | LEDs (20)             | 8 | External Zoom and Focus Adjustment |

### External Zoom and Focus Controls

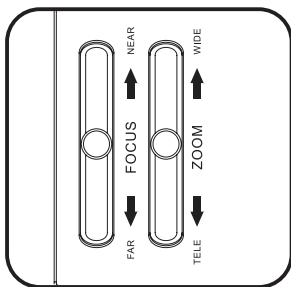

## 5 Installation

### 5.1 Mounting Position

**WARNING!**

To prevent injury, this apparatus must be securely attached to the floor/wall in accordance with the installation instructions.

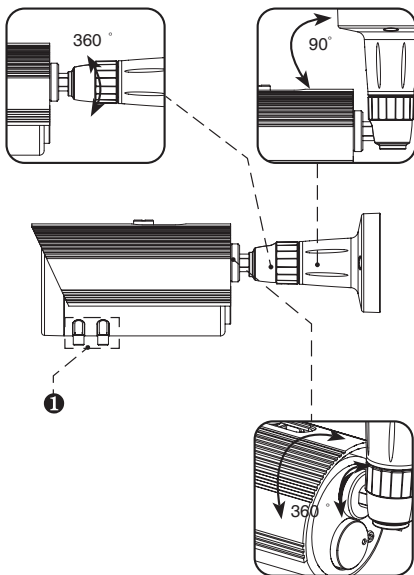
**CAUTION!**

After adjusting the zoom and focus, firmly tighten the zoom and focus lever to seal the camera against water ingress.

## 5.2 Mounting Connection



### CAUTION!

To prevent humidity problems, the camera must be installed in dry conditions, and the cable leads should be sealed once connected.

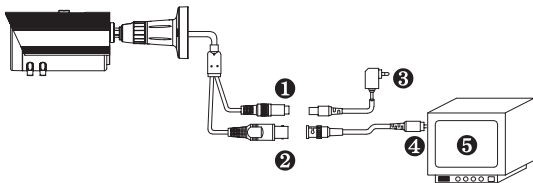

|   |                              |
|---|------------------------------|
| 1 | DC 12V / AC 24V              |
| 2 | BNC Female                   |
| 3 | DC 12V / AC 24V Power Supply |
| 4 | Video In                     |
| 5 | TV Monitor                   |

## 6 Dimensions

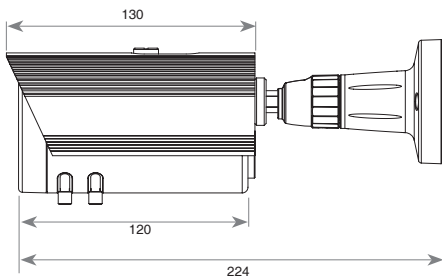
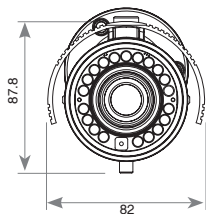

mm  
(in.)

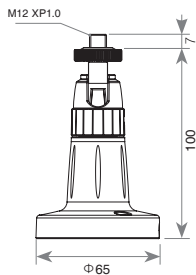

## 7 Specifications

|                          | NTSC   | PAL               |
|--------------------------|--|-------------------|
| Image Sensor             | 1/3 in. Super HAD CCD II   |                   |
| Total Pixels (H x V)     | 811 x 508  | 795 x 596         |
| Effective Pixels (H x V) | 768 x 494  | 752 x 582         |
| Inter. H/V (H, V)        | 15.734 KHz, 59.94 Hz   | 15.625 KHz, 50 Hz |
| Horizontal Resolution    | 540 TV Lines   |                   |
| S/N Ration               | > 50 dB (AGC Off)  |                   |
| Sync. System             | Internal   |                   |
| Gamma                    | r=0.05 ~ 1.0 Adjustable / USER   |                   |
| Video Output             | 1.0 Vp-p Composite (75 Ohm)  |                   |
| Lens                     | Varifocal  |                   |
| Electronic Shutter       | 1/60 sec.  | 1/50 sec.         |
| Manual Shutter           | 1/60(50), FLK, 1/250, 1/500, 1/2K, 1/5K, 1/10K, 1/100K X2, X4, X8, X16, X32, X64, X128, X256 |                   |
| Sense-up                 | Off / Auto (X2, X4, X8, X16, X32, X64, X128, X256)   |                   |
| AGC                      | Off / Low / Middle / High  |                   |
| BLC                      | Off / BLC / HSBLC  |                   |
| White Balance            | ATW / PUSH / PUSH-LOCK / MANUAL / INDOOR / OUTDOOR   |                   |
| Day and Night            | True Day and Night With ICR Mechanism  |                   |
| Motion Detection         | Zone 4ea (Mask On / Off)   |                   |
| Privacy Zone             | Zone 8ea (Mask On / Off)   |                   |
| 3-DNR                    | Off / On (0~100 Level Adjustable)  |                   |
| D-WDR                    | Off / Indoor / Outdoor   |                   |
| Image                    | Freeze / Mirror / D-zoom / Sharpness / Color gain / Gamma / NEG.Image                        |                   |
| IR LED                   | 850 nm, 20 each, Up to 30 m (98.4 ft)  |                   |
| IR LED Operation         | Adjustable(4 step)   |                   |
| IP Rating                | IP66 (Waterproof)  |                   |
| Operating Temperature    | -10°C ~ +50°C (14°F~122°F)   |                   |
| Storage Temperature      | -20°C ~ +60°C (-4°F~140°F)   |                   |
| Power Consumption        | AC24V ±10% Max 6.7W, DC12V ±10% Max 570mA  |                   |
| Weight                   | Approx. 1000g (2.2 lbs)  |                   |

## 8 OSD Manual

### 8.1 Lens Menu



### 8.2 Exposure Menu

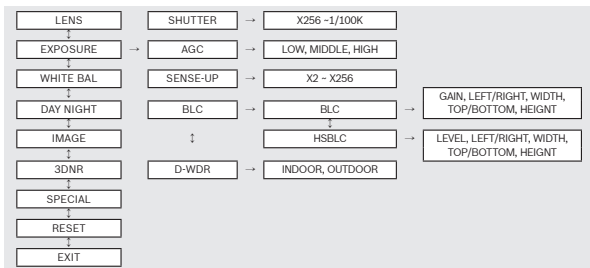

## 8.3 White Balance Menu

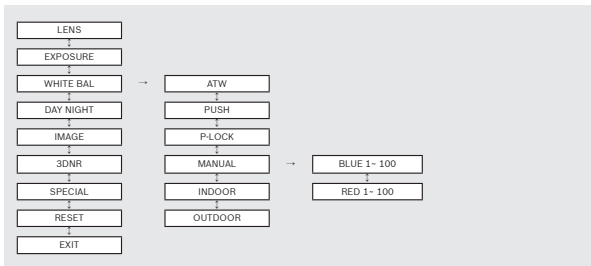

## 8.4 Day & Night Menu

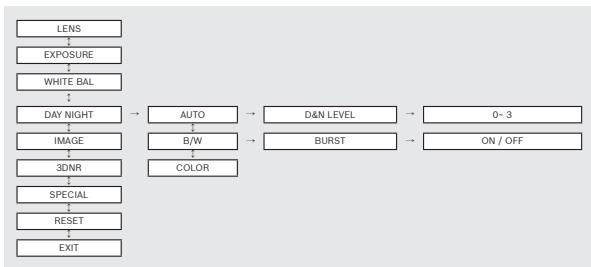

## 8.5 Image Menu

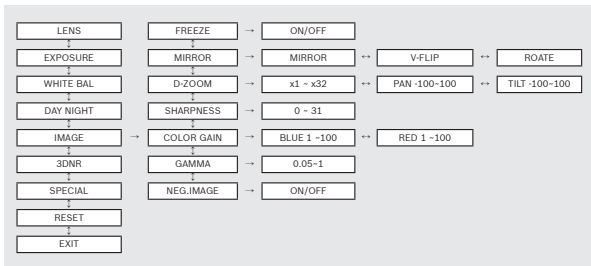



## 8.6 3DNR Balance Menu

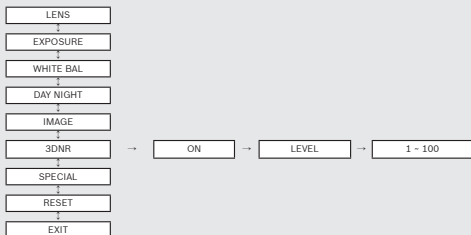

## 8.7 Special Menu

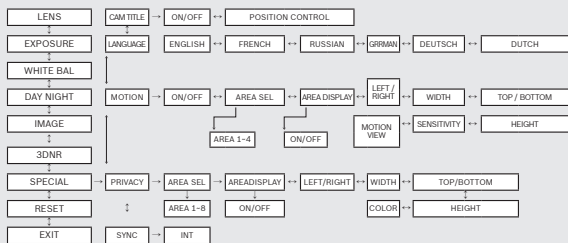

## 8.8 Reset Menu

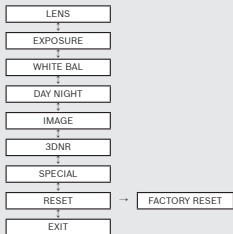

## 8.9 OSD Function Description

### 8.9.1 Lens

- BRIGHTNESS: Adjusts the image brightness (1~100).

| LENS       |       |
|------------|-------|
| BRIGHTNESS | 60    |
| RETURN     | RET-↓ |

### 8.9.1 Exposure

| EXPOSURE |        |
|----------|--------|
| SHUTTER  | 1/60   |
| AGC      | MIDDLE |
| SENSE-UP | OFF    |
| BLC      | OFF    |
| D-WDR    | OFF    |
| RETURN   | RET-↓  |

- SHUTTER
  - FLK: Adjusts FLICKERLESS setting.  
(NTSC: 1/100, PAL: 1/120)
  - FIXED: Adjusts the Shutter Speed.  
> 1/60(50), 1/250, 1/500, 1/2K, 1/5K, 1/10K, 1/100K.  
\* ( ) is for PAL TYPE.
- BRIGHTNESS: Adjusts the MANUAL Electronic Shutter value.
- AGC: Adjusts the Automatic Gain Control.
- SENSE-UP: Low-speed shutter control.
- BLC: Back Light Compensation.
- HSBLC: Highlight Suppression BLC (darkens parts of the image to enhance the scene).
- D-WDR: Dynamic-wide Dynamic Range allows every detail to be captured accurately even if one portion is bright while other portions are dark.

### 8.9.3 White Balance

Adjust to display accurate white color by controlling the RGB level.

| WHITE BAL MANUAL |      |
|------------------|------|
| BLUE             | 24   |
| RED              | 32   |
| RETURN           | RET↵ |

- ATW: Traces the White Balance automatically.  
(2,500K ~ 9,500K)
- PUSH: Traces the White Balance automatically.
- P-LOCK: Automatically readjusted at the request of the user.
- MANUAL: Sets the RED GAIN or BLUE GAIN.
- INDOOR: Sets base mode to 3,200K.
- OUTDOOR: Sets base mode to 5,400K.

### 8.9.4 Day and Night

Determines the switching moment between Color and B/W mode.

| DAY & NIGHT AUTO |           |
|------------------|-----------|
| D&N LEVEL        | -- ---- 1 |
| RETURN           | RET↵      |

- AUTO: Sensor mode auto change.
  - \* Adjustable for variable D&N change timing.
  - D&N Level "1": Turn LED on with B/W mode @ 4Lux /  
Turn LED Off with Color Mode @ 7Lux
  - The Higher D&N Level turns into Black & White mode  
at higher luminous intensity and vice versa.
  - \* The D&N change timing could be affected by installation circumstances.
- B/W: Fixes the output image in B/W.
- BURST ON/OFF: Select the burst signal ON/OFF when  
Night condition.
- COLOR: Fixes the output image in COLOR.

### 8.9.5 Image

Sets the FREEZE, MIRROR, D-ZOOM, SHARPNESS, COLOR GAIN, GAMMA, NEGATIVE IMAGE.

| IMAGE      |      |
|------------|------|
| FREEZE     | OFF  |
| MIRROR     | OFF  |
| D-ZOOM     | OFF  |
| SHARPNESS  | 17   |
| COLOR GAIN | ┘    |
| GAMMA      | 0.45 |
| NEG.IMAGE  | OFF  |
| RETURN     | RET┘ |

- FREEZE: Sets moving images in freeze-frame mode.
- MIRROR
  - MIRROR: Sets reversed LEFT and RIGHT image.
  - V-FLIP: Sets vertically flipped video.
  - ROTATION: Sets rotation up to 180 degrees.
- D-ZOOM: Expands one part of the monitor screen for viewing.
- SHARPNESS: Sets sharpness control.
- COLOR GAIN: Sets the RED GAIN or BLUE GAIN.
- GAMMA: Sets compensation according to the gamma value.
- NEG.IMAGE: Sets negative image ON/OFF.

### 8.9.6 3DNR

Sets three-dimensional noise reduction.

- LEVEL: Sets noise reduction level.

| 3DNR   |      |
|--------|------|
| LEVEL  | 50   |
| RETURN | RET┘ |

## 8.9.7 Special

Sets the CAM TITLE, LANGUAGE, MOTION, PRIVACY, SYNC.

| SPECIAL   |         |
|-----------|---------|
| CAM TITLE | OFF     |
| LANGUAGE  | ENGLISH |
| MOTION    | OFF     |
| PRIVACY   | OFF     |
| SYNC      | INT     |
| RETURN    | RET↵    |

- CAMERA TITLE: Displays the title editing menu.
- LANGUAGE: Sets language for the OSD.
- MOTION: The camera monitors the movement of image, and it sends an alarm signal or OSD icon.
  - AREA SELECT: Select one of the four (4) motion areas.
  - AREA DISPLAY: Turns display ON/OFF in the selected area.
  - LEFT/RIGHT: Sets LEFT/RIGHT position in the selected area.
  - WIDTH: Sets the width in the selected area.
  - TOP/BOTTOM: Sets TOP/BOTTOM position in the selected area.
  - HEIGHT: Sets the height in the selected area.
  - SENSITIVITY: Sets the movement detection threshold value.
  - MOTION VIEW: Displays the motion area on the screen.
- PRIVACY: Masks user-defined areas of the view.
  - AREA SELECT: Select the mask area from 1 to 8.
  - AREA DISPLAY: Toggle mask ON/OFF in selected area.
  - LEFT/RIGHT: Sets LEFT/RIGHT position in selected area.
  - WIDTH: Sets width in selected area.
  - TOP/BOTTOM: Sets TOP/BOTTOM position in selected area.
  - HEIGHT: Sets the height in selected area.
  - COLOR: Select mask color.
  - SYNC: Synchronizes the image from the camera and the monitor.
  - INT: Internal synchronization system.

### 8.9.8 Reset

Resets all settings to the factory default.

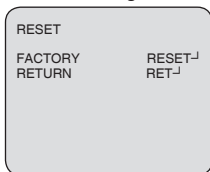



**Bosch Security Systems, Inc.**

850 Greenfield Road  
Lancaster, PA 17601  
U.S.A.

**[www.boschsecurity.com](http://www.boschsecurity.com)**

© Bosch Security Systems, Inc., 2011



## Free Manuals Download Website

<http://myh66.com>

<http://usermanuals.us>

<http://www.somanuals.com>

<http://www.4manuals.cc>

<http://www.manual-lib.com>

<http://www.404manual.com>

<http://www.luxmanual.com>

<http://aubethermostatmanual.com>

Golf course search by state

<http://golfingnear.com>

Email search by domain

<http://emailbydomain.com>

Auto manuals search

<http://auto.somanuals.com>

TV manuals search

<http://tv.somanuals.com>