

Boston

BostonAcoustics.com

ProSeries 12.5LF
10.5LF
8.5LF

Competitor Series 1500
1200
1000
800

Generator Series GS1500
GS1200
GS1000

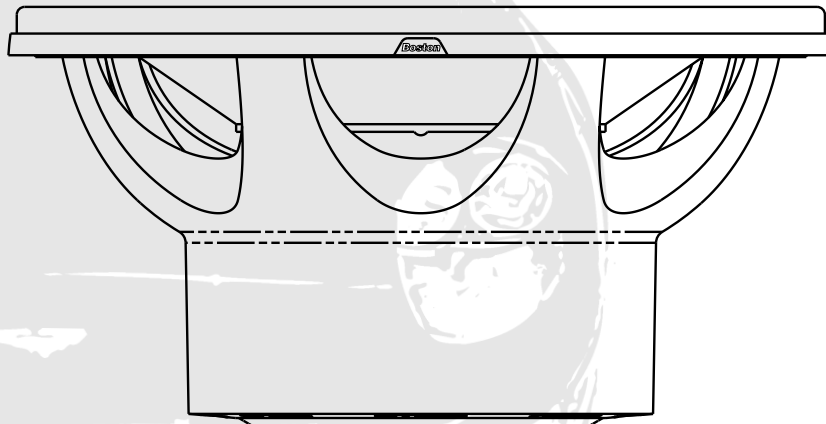

Boston Acoustics Subwoofer
Installation Manual

Boston

Table of Contents

Enclosure Recommendations	3
Building an Enclosure	5
Locating Subwoofer Enclosure In Vehicle	6
Hatchbacks/Sport Utility Vehicles	6
Sedans	7
Wiring	8
2 ohm subwoofers	8
4 ohm subwoofers	9
Specifications	10
Theile/Small Parameters	10

Congratulations!

You have purchased the finest automotive subwoofer the industry has to offer. Installed correctly, the ProSeries subwoofers will offer unprecedented performance for many years to come.

Warning

This manual explains only the basic installation of the subwoofers—not the techniques required to perform the installation. If you do not have the experience that these procedures require, we strongly suggest you consult your Boston Acoustics dealer about professional installation.

Enclosure Recommendations

The ProSeries and Competitor Series subwoofers are designed to deliver optimum performance in small sealed enclosures. The Generator Series subwoofers are designed for either sealed or ported enclosures. The following are the recommended enclosure volumes:

	ProSeries			Competitor Series				Generator Series		
Sealed Enclosures	12.5LF	10.5LF	8.5LF	1500	1200	1000	800	GS1500	GS1200	GS1000
Gross Internal Volume	1.0ft ³	0.5ft ³	0.3ft ³	1.5ft ³	1.0ft ³	0.5ft ³	0.3ft ³	2.5ft ³	1.5ft ³	.75ft ³
-3dB Down Point—In Car	20Hz	20Hz	20Hz	20Hz	20Hz	20Hz	20Hz	20Hz	20Hz	20Hz
System "Q" (2Ω)	0.9	0.8	0.6	1.36	1.03	0.92	0.69	1.63	1.38	1.18
(4Ω)	1.1	0.95	0.7	1.56	1.12	0.98	0.73	1.5	1.29	1.09
Recommended Enclosure Dimensions (Internal)										
Height	10.5"	7.5"	6.5"	10"	10.5"	7.5"	6.5"	20"	16"	12"
Width	13.0"	11.0"	9.0"	16"	13.0"	11.0"	9.0"	16"	14"	11"
Depth	13.0"	11.0"	9.0"	16"	13.0"	11.0"	9.0"	13.5"	12"	9.75"

Ported Enclosures (Generator Series only)	GS1500	GS1200	GS1000
Gross Internal Volume	2.5ft ³	1.5ft ³	1.25ft ³
Tuning Frequency	35Hz	35Hz	33Hz
Port Diameter	4"D	3"D	3"D
Port Length	11"L	7.3"L	11"L
Recommended Enclosure Dimensions (Internal)			
Height	20"	16"	14"
Width	16"	14"	11.5"
Depth	13.5"	12"	14"

Calculating your enclosure volume:

Internal dimensions

Height (inches) x Width (inches) x Depth (inches) = Gross Internal Volume (cubic inches)

$$\frac{\text{Gross Internal Volume (cubic inches)}}{1728} = \text{Gross Internal Volume (cubic feet)}$$

or:

$$\frac{\text{Height (cm) x Width (cm) x Depth (cm)}}{1000} = \text{Gross Internal Volume (liters)}$$

Conversion Formulas

1" = 2.54cm

1ft³ = 28.32 liters

1ft³ = 1,728in³

Remember to account for material thickness when determining external dimensions.

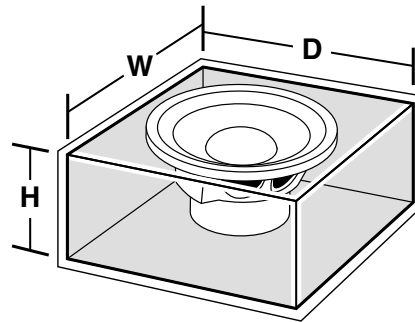

Building an Enclosure

Use at least $\frac{3}{4}$ -inch MDF to build the enclosure (1-inch is preferable). The joints should be liberally glued with carpenter's wood glue and screwed together with wood screws and sealed internally with a bead of silicone rubber or hot melt glue.

Drill pilot holes to prevent the wood from splitting and tighten the screws as much as possible. Excess glue can be wiped off with a damp sponge or paper towel.

Warning

It is extremely important to completely seal the enclosure. Even small leaks can have a dramatic effect on subwoofer performance. Look, listen, and test for leaks at all joints, around the subwoofer perimeter, and at the wire entrance location.

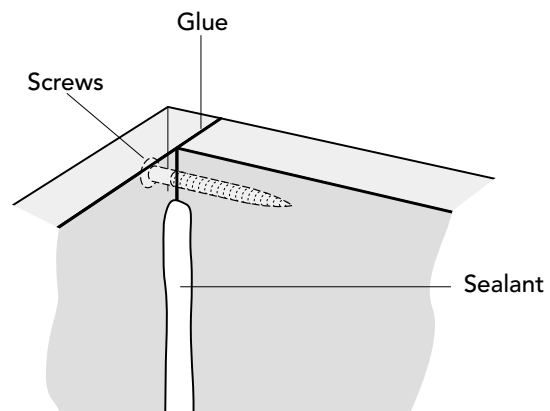

Locating Subwoofer Enclosure in Vehicle

The placement of the enclosure is one of the most important factors concerning installation. As each vehicle's interior acoustics are different, experimentation is the key to optimizing performance.

Hatchbacks/Sport Utility Vehicles

Locate the enclosure in a rear corner for maximum output. Experiment with the subwoofer's placement.

Hatchback Installation

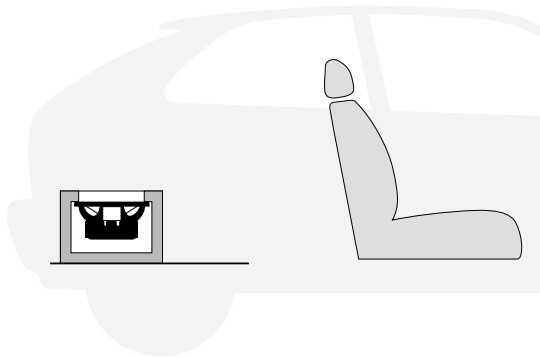

Warning

Make sure the enclosure is securely mounted in such a way as to not shift or fly forward in the event of an accident or sudden stop.

Sedans

Provide as clear a path as possible into the cabin by venting through a folded-down arm rest, venting through the rear deck, or venting through an unused speaker opening in the rear deck. Keep any restrictive materials such as wood, hard plastic or metal from directly blocking the subwoofer.

Sedan Installation

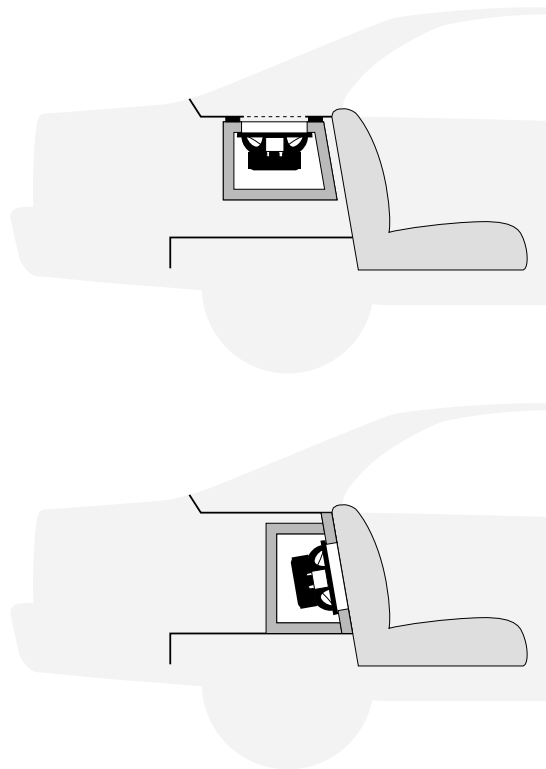

Wiring

2 ohm subwoofers

One 2Ω sub

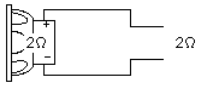

Two 2Ω subs, series

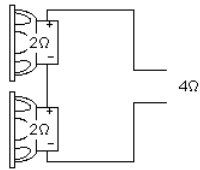

Two 2Ω subs, parallel

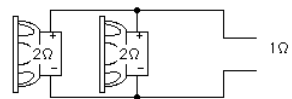

Three 2Ω subs, series

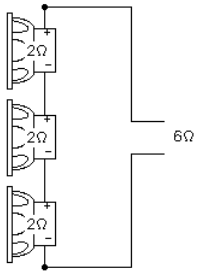

Four 2Ω subs, series/parallel

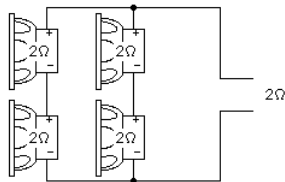

Wiring

4 ohm subwoofers

One 4Ω sub

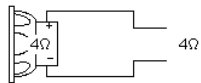

Two 4Ω subs, parallel

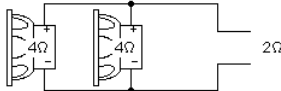

Three 4Ω subs, parallel

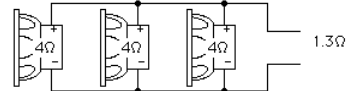

Four 4Ω subs, series/parallel

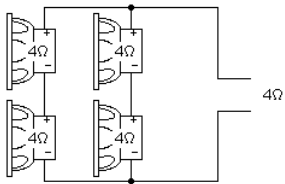

Four 4Ω subs, parallel

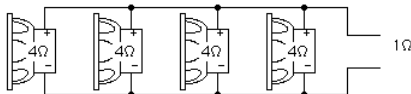

Specifications	ProSeries			Competitor Series
	12.5LF	10.5LF	8.5LF	1500
Nominal Size	12" (30cm)	10" (25cm)	8" (20cm)	15" (38cm)
Mounting Cutout Diameter	11" (280mm)	9 $\frac{1}{2}$ " (232mm)	7 $\frac{3}{8}$ " (183mm)	13 $\frac{1}{8}$ " (353mm)
Mounting Depth—Front Mounted	5 $\frac{1}{2}$ " (143mm)	4 $\frac{1}{4}$ " (121mm)	4 $\frac{1}{8}$ " (104mm)	7 $\frac{3}{8}$ " (197mm)
Mounting Depth—Rear Mounted	6 $\frac{3}{8}$ " (162mm)	5" (127mm)	4 $\frac{1}{8}$ " (119mm)	8 $\frac{1}{4}$ " (210mm)
Recommended Amplifier Power	50–1200 watts	50–1100 watts	50–750 watts	50–1000 watts
Nominal Impedance	2 Ω /4 Ω	2 Ω /4 Ω	2 Ω /4 Ω	2 Ω /4 Ω

Theile/Small Parameters	ProSeries						Competitor Series	
	12.5LF	12.5LF	10.5LF	10.5LF	8.5LF	8.5LF	1500	1500
	(2 Ω)	(4 Ω)	(2 Ω)	(4 Ω)	(2 Ω)	(4 Ω)	(2 Ω)	(4 Ω)
Resonant Frequency (F_s)	30Hz	31Hz	33Hz	34Hz	35Hz	36Hz	34Hz	35Hz
Equivalent Volume (V_{as})	84 liters	84 liters	35 liters	35 liters	21 liters	21 liters	155 liters	155 liters
	2.97ft ³	2.97ft ³	1.24ft ³	1.24ft ³	0.74ft ³	0.74ft ³	5.47ft ³	5.47ft ³
Total Q (Q_{ts})	0.45	0.57	0.44	0.53	0.33	0.40	0.72	0.85
Electrical Q (Q_{es})	0.47	0.61	0.47	0.57	0.35	0.42	0.81	0.97
Mechanical Q (Q_{ms})	9.8	9.6	8.0	7.8	9.0	9.0	8.3	8.3
Compliance (C_{ms})	230 μ m/N	230 μ m/N	255 μ m/N	255 μ m/N	330 μ m/N	330 μ m/N	142 μ m/N	142 μ m/N
Moving Mass (M_{ms})	121g	117g	90g	86g	63g	60g	148g	145g
Cone Area (S_d)	510cm ²	510cm ²	315cm ²	315cm ²	215cm ²	215cm ²	876cm ²	876cm ²
Voice Coil Diameter	51mm	51mm	51mm	51mm	51mm	51mm	51mm	51mm
Voice Coil DCR (R_e)	1.6 Ω	3.1 Ω	1.6 Ω	3.1 Ω	1.6 Ω	3.1 Ω	1.6 Ω	3.2 Ω
Voice Coil Inductance @ 1kHz (L_e)	0.40mH	0.55mH	0.40mH	0.55mH	0.40mH	0.55mH	0.45mH	0.62mH
Linear Excursion—One Way (X_{max})	8.5mm	8.5mm	8.5mm	8.5mm	8.5mm	8.5mm	5.5mm	5.5mm
Peak-to-Peak Maximum Excursion	40mm	40mm	35mm	35mm	35mm	35mm	40mm	40mm
Reference Efficiency (η_o)	0.46	0.39	0.26	0.25	0.25	0.22	0.73	0.64

We provide Theile/Small Parameters for those interested in studying subwoofers further. We do not recommend you use computer software to determine enclosure sizes or type. While high-end enclosure design software may be useful for engineering purposes, it cannot completely predict performance in a given vehicle and should not replace a real enclosure that has been tested and listened to in a car. Please use our recommended enclosures for optimum performance.

Competitor Series (continued)			Generator Series		
1200	1000	800	GS1500	GS1200	GS1000
12" (30cm)	10" (25cm)	8" (20cm)	10" (25cm)	10" (25cm)	10" (25cm)
11" (280mm)	9 ⁵ / ₁₆ " (234mm)	7 ¹ / ₂ " (181mm)	13 ³ / ₈ " (353mm)	11" (280mm)	9 ⁵ / ₁₆ " (234mm)
6 ⁵ / ₈ " (169mm)	6" (153mm)	5 ³ / ₈ " (137mm)	6 ⁵ / ₈ " (172mm)	5 ³ / ₈ " (146mm)	5" (127mm)
7 ¹ / ₂ " (181mm)	6 ⁵ / ₈ " (169mm)	5 ³ / ₈ " (150mm)	7 ¹ / ₂ " (185mm)	6 ¹ / ₄ " (159mm)	5 ¹ / ₂ " (140mm)
50–1000 watts	50–850 watts	50–500 watts	50–500 watts	50–500 watts	50–400 watts
2Ω/4Ω	2Ω/4Ω	2Ω/4Ω	2Ω/4Ω	2Ω/4Ω	2Ω/4Ω

Competitor Series (continued)						Generator Series					
1200	1200	1000	1000	800	800	GS1500	GS1500	GS1200	GS1200	GS1000	GS1000
(2Ω)	(4Ω)	(2Ω)	(4Ω)	(2Ω)	(4Ω)	(2Ω)	(4Ω)	(2Ω)	(4Ω)	(2Ω)	(4Ω)
30Hz	31Hz	33Hz	34Hz	35Hz	36Hz	29Hz	29Hz	31Hz	31Hz	33Hz	33Hz
84 liters	84 liters	35 liters	35 liters	21 liters	21 liters	215 liters	215 liters	97 liters	97 liters	37 liters	37 liters
2.97ft ³	2.97ft ³	1.24ft ³	1.24ft ³	0.74ft ³	0.74ft ³	7.58ft ³	7.58ft ³	3.43ft ³	3.43ft ³	1.31ft ³	1.31ft ³
0.45	0.57	0.44	0.53	0.33	0.40	0.81	0.75	0.76	0.71	0.71	0.66
0.47	0.61	0.47	0.57	0.35	0.42	0.9	0.84	0.85	0.79	0.79	0.74
9.8	9.6	8.0	7.8	9.0	9.0	7.6	7.5	7.2	7.1	6.6	6.7
230μm/N	230μm/N	255μm/N	255μm/N	330μm/N	330μm/N	200μm/N	200μm/N	200μm/N	200μm/N	200μm/N	200μm/N
121g	117g	90g	86g	63g	60g	150g	147g	134g	130g	118g	114g
510cm ²	510cm ²	315cm ²	315cm ²	215cm ²	215cm ²	874.7cm ²	874.7cm ²	588.4cm ²	588.4cm ²	365cm ²	365cm ²
51mm	51mm	51mm	51mm	51mm	51mm	51mm	51mm	51mm	51mm	51mm	51mm
1.6Ω	3.1Ω	1.6Ω	3.1Ω	1.6Ω	3.1Ω	1.7Ω	3.6Ω	1.7Ω	3.6Ω	1.7Ω	3.6Ω
0.40mH	0.55mH	0.40mH	0.55mH	0.40mH	0.55mH	0.98mH	1.9mH	0.98mH	1.9mH	0.98mH	1.9mH
8.5mm	8.5mm	8.5mm	8.5mm	8.5mm	8.5mm	4.4mm	5.3mm	4.4mm	5.3mm	4.4mm	5.3mm
40mm	40mm	35mm	35mm	35mm	35mm	37mm	37mm	37mm	37mm	33mm	33mm
0.46	0.39	0.26	0.25	0.25	0.22	0.56	0.63	0.32	0.36	0.16	0.18

Boston

BostonAcoustics.com

300 Jubilee Drive
Peabody, MA 01960 U.S.A.
978.538.5000

Boston and Boston Acoustics are
registered trademarks of Boston
Acoustics, Inc. ©1999

Covered by patents issued and/or
pending.

42-001034-0

Free Manuals Download Website

<http://myh66.com>

<http://usermanuals.us>

<http://www.somanuals.com>

<http://www.4manuals.cc>

<http://www.manual-lib.com>

<http://www.404manual.com>

<http://www.luxmanual.com>

<http://aubethermostatmanual.com>

Golf course search by state

<http://golfingnear.com>

Email search by domain

<http://emailbydomain.com>

Auto manuals search

<http://auto.somanuals.com>

TV manuals search

<http://tv.somanuals.com>