

Boston PV350

Powered Subwoofer



Boston
Boston Acoustics

Important Safety Instructions



This symbol found on the apparatus indicates hazards arising from dangerous voltages.



This symbol found on the apparatus indicates the user should read all safety statements found in the user manual.



This symbol found on the apparatus indicates double insulation.



Warning! To reduce the risk of fire or electric shock, do not expose this product to rain or moisture.

1. Read these instructions.
2. Keep these instructions.
3. Heed all warnings.
4. Follow all instructions.
5. Do not use this apparatus near water.
6. Clean only with dry cloth.
7. Do not block any ventilation openings. Install in accordance with the manufacturer's instructions.
8. Do not install near any heat sources such as radiators, heat registers, stoves, or other apparatus (including amplifiers) that produce heat.
9. Do not defeat the safety purpose of the polarized or grounding-type plug. A polarized plug has two blades with one wider than the other. A grounding type plug has two blades and a third grounding prong. The wide blade or the third prong are provided for your safety. If the provided plug does not fit into your outlet, consult an electrician for replacement of the obsolete outlet.
10. Protect the power cord from being walked on or pinched particularly at plugs, convenience receptacles, and the point where they exit from the apparatus.
11. Only use attachments/accessories specified by the manufacturer.
12. Unplug this apparatus during lightning storms or when unused for long periods of time.
13. Refer all servicing to qualified service personnel. Servicing is required when the apparatus has been damaged in any way, such as power-supply cord or plug is damaged, liquid has been spilled or objects have fallen into the apparatus, the apparatus has been exposed to rain or moisture, does not operate normally, or has been dropped.
14. Maintain a minimum distance of 50 mm around the front, rear and sides of the apparatus for sufficient ventilation. The ventilation should not be impeded by covering the ventilation openings or placing on or around the apparatus items such as newspapers, table-cloths, curtains, etc.
15. No naked flame sources, such as lighted candles, should be placed on the apparatus.
16. The apparatus shall not be exposed to dripping or splashing. No objects filled with liquids, such as vases, shall be placed on the apparatus.
17. Either the power inlet connector on the rear of the apparatus or the power plug at the wall must remain accessible, to be able to disconnect power from the apparatus.

Specifications

Frequency Response ($\pm 3\text{dB}$)	45Hz–200Hz
Subwoofer Amplifier Power	FTC Rated Power: 50 watts @ 50 Hz into 4 ohms at less than 1% THD+N
Subwoofer Crossover	75Hz–200Hz 24dB/octave low-pass
Crossover Bypass	Yes
Bass Unit	8" (203mm) DCD down-firing
Enclosure Type	Ported
Dimensions (HxWxD) (with feet and rear connectors)	13 x 11 ¹ / ₄ x 15 ¹ / ₂ " (330.5 x 287 x 393mm)
Weight	18 lbs (8.1kg)

Description

Boston's PV350 subwoofer delivers the dynamic bass foundation that is essential for lifelike reproduction of movie soundtracks and music in the home. This attractive, powered subwoofer will complement any stereo or home theater surround sound system with its impressive bass output and compact size.

This subwoofer utilizes our rugged DCD™ (Deep Channel Design) bass unit designed in Boston's state-of-the-art engineering facility in Peabody, Massachusetts. Every one is tested as it comes off the line to be within $\pm 1\text{dB}$ of the lab reference unit, an incredibly tight tolerance. The amplifier has a built-in variable crossover that makes it easy to achieve a seamless blend with the front/main speakers, while a 24dB/octave low-pass filter prevents the subwoofer from being easily localized by ear, increasing placement flexibility. A crossover bypass function is provided for use with home theater electronics that perform their own bass management.

Because of its strong amplifier and computer-optimized tuning, the PV350 is capable of impressive deep bass and high output from a remarkably compact enclosure. In addition, it features BassTrac®, a proprietary Boston-designed circuit that tracks the input signal to the subwoofer and prevents its amplifier from being driven into audible distortion. The benefit: The bass stays clean and strong at almost any listening level.

Connections

Line level: Use the jack labeled "line level in" with most systems. These inputs accept the line level signal from your receiver's subwoofer output. The subwoofer's circuitry filters out the high frequencies and sends the remaining low frequencies to the subwoofer power amplifier.

Speaker level: Use these high-level terminals with receivers that do not have a subwoofer output. The speaker inputs accept both left and right channel speaker signals from your receiver.

How to Connect Using the Speaker Terminals

We recommend 18-gauge wire or thicker for runs up to 15 feet (4.5m), and 16-gauge wire or thicker for longer runs. Separate the first few inches of the wire conductors. Strip off 1/2-inch (12mm) of insulation from the ends of each speaker wire to expose the two conductors and tightly twist the wire strands.

WARNING: To prevent electrical shock hazard, always switch off the amplifier or receiver when making connections to the speaker.

When making all connections, be sure to connect the + (red) on the speaker to the + (red) on the amplifier, and the - (black) on the speaker to the - (black) on the amplifier.

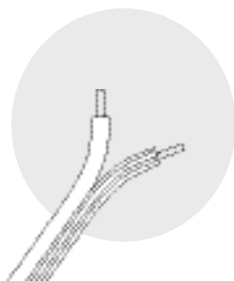

IMPORTANT: Typically, one side of the wire is smooth. Connect this side to the - (black) connection. The other side has a rib or stripe. Connect this to the + (red) connection.

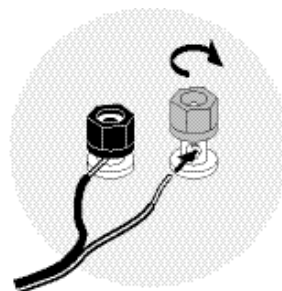

Using the five-way binding posts: The binding posts permit easy connection to banana plugs, spade lugs, and bare wire. Insert the wire in the hole and tighten.

Connecting the Subwoofer to Digital Home Theater Systems

Digital 5.1, 6.1 and 7.1 home theater electronics dedicate one channel (the “.1”) to reproduce the special low-frequency information (such as explosions and thunder) contained in digitally-encoded soundtracks.

Select “subwoofer-yes” from your receiver’s set-up menu. Hooked up this way, the receiver’s amplifier is relieved of having to reproduce the difficult low bass signals that can drive the receiver into audible distortion.

Use an RCA cable (not included), as shown, to connect your digital receiver’s subwoofer output to the subwoofer. Set the crossover to the *bypass* position and connect to *line level in*.

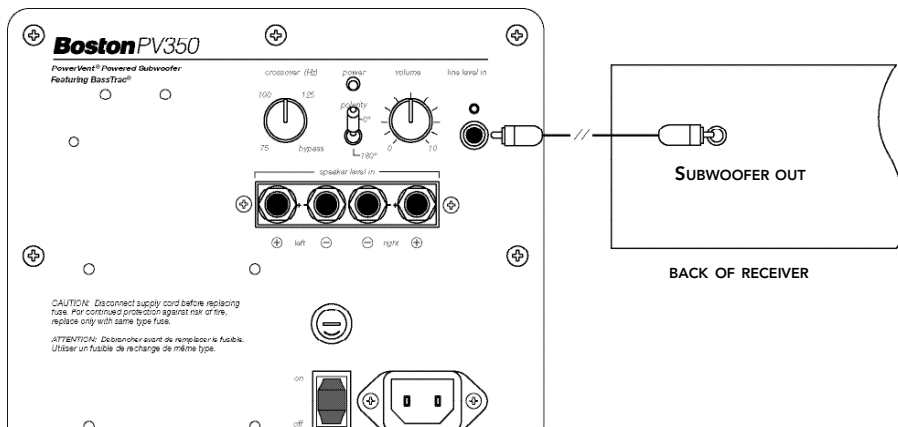

If you do not wish to run RCA cables to your subwoofer, you may use speaker wire to connect the subwoofer in parallel with your front/main speakers (see diagram below). The subwoofer does not present any additional load to your receiver.

Select "subwoofer-no" from your receiver's set-up menu. This sends the subwoofer signal to the front/main left and right speakers, and thus, to the subwoofer. Consult your receiver's owner's manual for more details.

When using the speaker wire hookup, the subwoofer's built-in crossover is engaged. As a starting point, set the crossover control on the subwoofer about at roughly the lower limit of your front/main speakers' bass response. Fine-tune the crossover setting by ear for the smoothest blend with your front/main speakers. The best setting of the crossover control will depend on speaker placement and personal preference.

Connecting the Subwoofer to Stereo or Dolby® Pro Logic® Systems

For stereo or Dolby Pro Logic systems, the easiest method is to use speaker wire connections as shown.

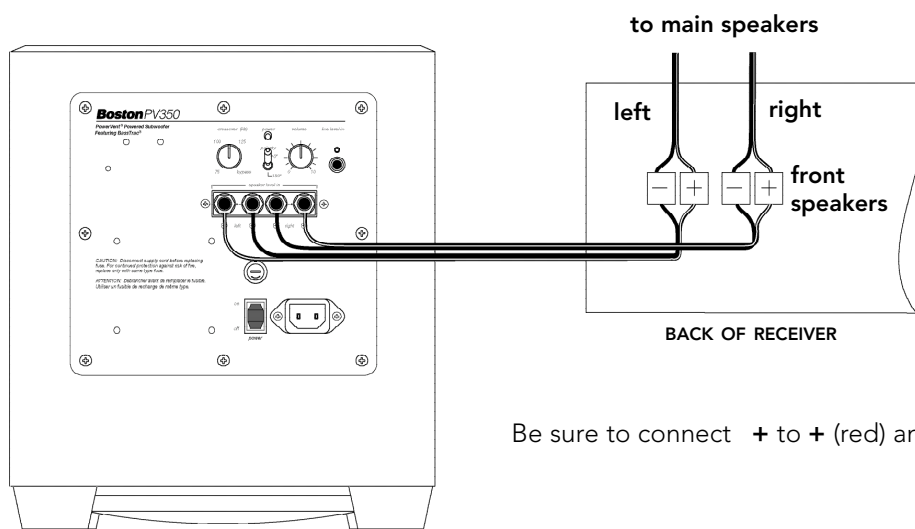

When using the speaker wire hookup, the subwoofer's built-in crossover is engaged. As a starting point, set the crossover control on the subwoofer at roughly the lower limit of your front/main speakers' bass response. Fine-tune the crossover setting by ear for the smoothest blend with your front/main speakers. The best setting of the crossover control will depend on speaker placement and personal preference.

Controls

Volume: Adjusts the sound level of the subwoofer. A typical setting is around 10 o'clock.

Crossover (Hz): Adjusts the frequency of the low-pass filter for the subwoofer.

Polarity (0° or 180°): Selects regular (0°) or inverted (180°) polarity for the subwoofer. Set this switch to provide the fullest, most dynamic bass. The effect of phase will be most audible on low-frequency percussion instruments or music with a continuously repeating bass line.

Power off/on: Switches the amplifier on and off. Once switched to the "on" position, the PV350's auto-on circuitry turns the subwoofer on when a signal is presented, and turns it off after no signal is detected for several minutes.

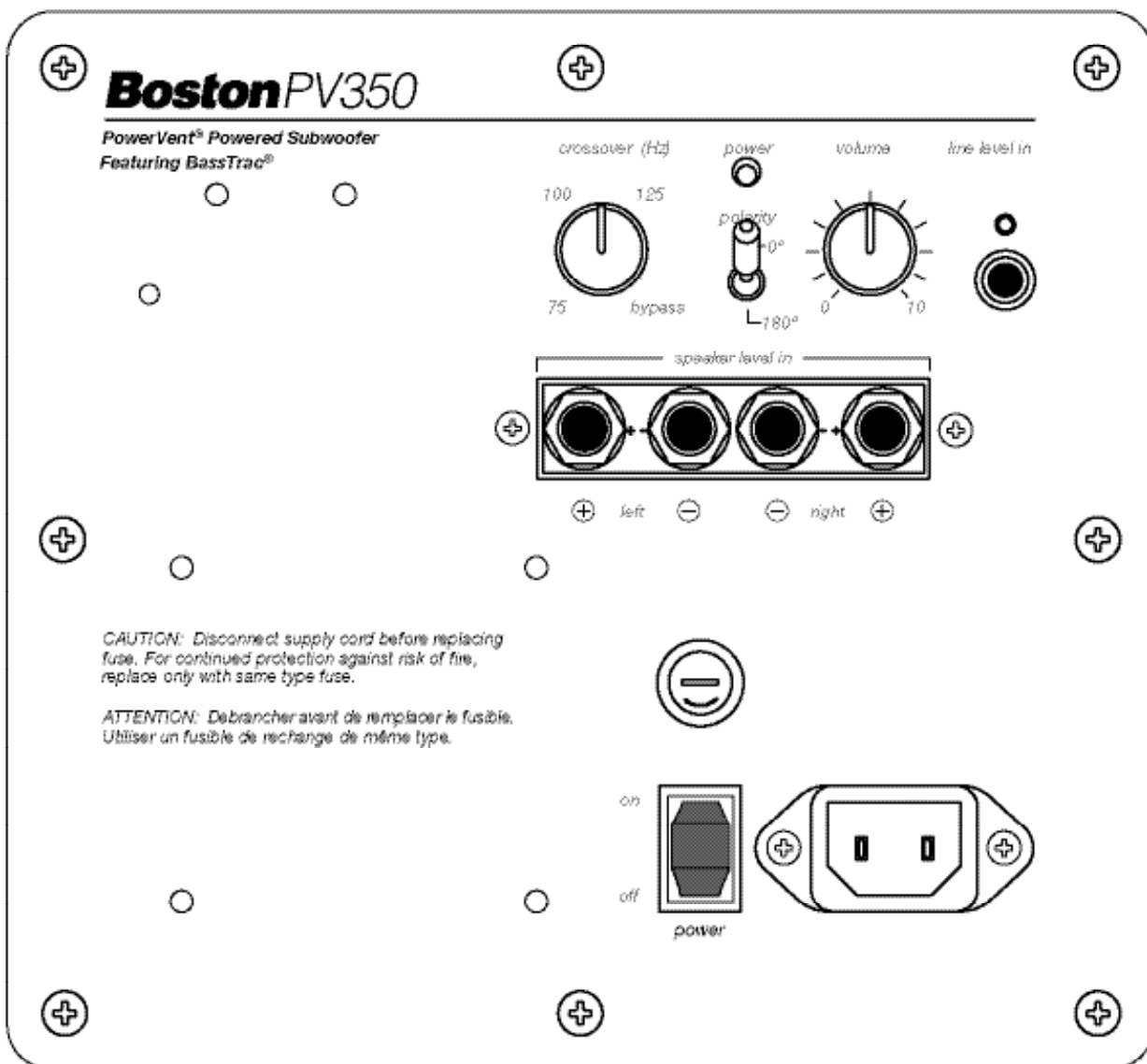

Placement

Place the subwoofer next to a wall or in a corner near your front/main speakers. Typically, the sound is best when the subwoofer is within 15 feet (5m) of the front/main speakers. However, the sharp 24dB/octave crossover roll-off permits placement farther from the front/main speakers if necessary. Since the ear is unable to localize the low frequencies of the subwoofer, the bass still appears to come from the front/main speakers. In most cases, the subwoofer may be placed anywhere in the listening room.

The level of bass output from the subwoofer will vary at different positions in a room. When placed near walls, its loudness is emphasized. Corner placement provides the most bass output, while placement near only one wall will provide somewhat less bass. Placement completely away from walls may produce too little bass. Regardless of how you place the subwoofer, you can adjust the subwoofer's level with its rear panel level controls. If you move the subwoofer, recheck the setting of the polarity switch. Use the setting that yields the louder and more dynamic sound.

IMPORTANT: Do not place the subwoofer where there is a chance of contact between the rear panel and drapes or furniture. Avoid obstructing air flow to the back of the PV350.

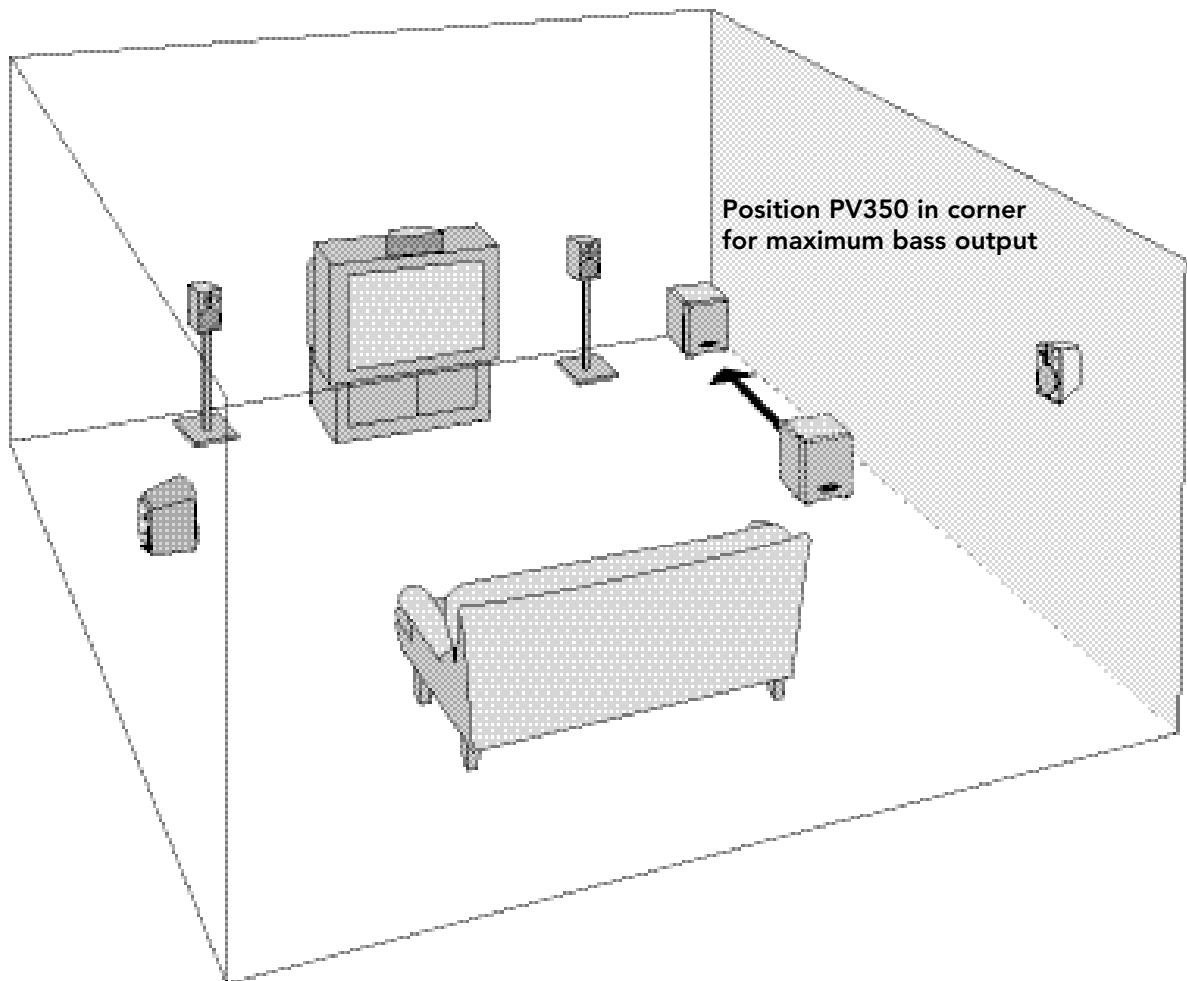

If Service Seems Necessary

First, contact the dealer from whom you purchased the PV350. If that is not possible, write to:

Customer Service
Boston Acoustics, Inc.
300 Jubilee Drive
Peabody, MA 01960 U.S.A.

Or contact us via e-mail at:
support@bostona.com

We will promptly advise you of what action to take. If it is necessary to return your subwoofer to the factory, please ship it prepaid. After it has been repaired, we will return it freight prepaid in the U.S. and Canada.

If Speaker Wire Connections Cause the Subwoofer to Hum

Certain receivers use speaker grounding circuits that may be incompatible with the speaker level inputs of external powered audio products, such as powered subwoofers. When speaker wire is used instead of line level cables, this incompatibility can result in an audible hum when the receiver is turned off or switched to a different speaker channel.

If this should happen with your Boston Acoustics subwoofer, you will need to make a ground cable and connect it to the RCA line input on the subwoofer and any unused RCA line input or output on your receiver (see diagram). The proper ground cable for this application should consist of two male RCA plugs that have their negative outside terminals (or "sleeve") connected to each other by any length of single conductor copper cable. The inside positive (or "pin") terminals should not be wired or removed in either plug.

If you do not wish to make your own grounding cable, please contact the Boston Acoustics Customer Service Department directly (see below) and we will promptly ship one to you of suitable length at no charge.

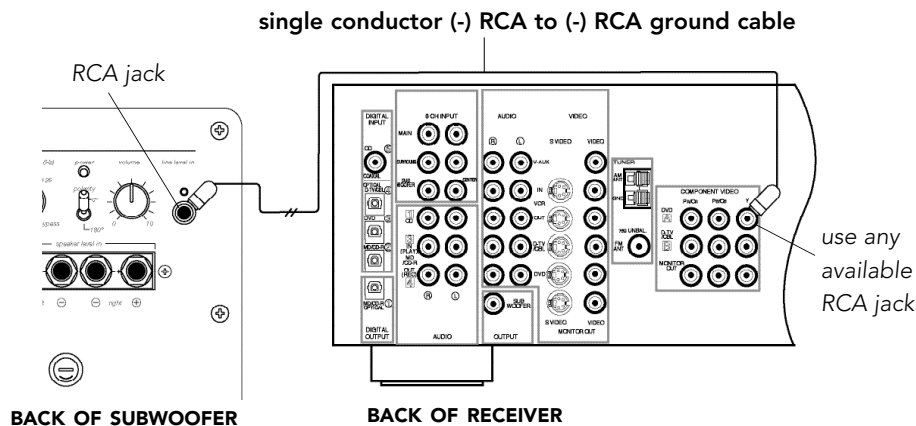

Boston
Boston Acoustics

300 Jubilee Drive
Peabody, MA 01960 U.S.A.
978.538.5000
bostonacoustics.com

BassTrac, Boston, Boston Acoustics are registered trademarks of Boston Acoustics, Inc. Dolby and Dolby Pro Logic are registered trademarks of Dolby Laboratories Licensing Corporation.

© 2004 Boston Acoustics, Inc. All rights reserved.
Specifications subject to change without notice.

Boston Acoustics, Inc.	
David Jaques, Project Manager: 978/538-5126	
Owners Manual: PV350-US	
Date: 7/12/04	Scale: 100%
BA P/N: 042-002025-2	ECO# 3451
Colors:	grayscale
Note:	Dimensions in millimeter Keylines not to print
Revisions:	Rev-1: Fixed image Rev-2: P.8 text "contact us via"

Free Manuals Download Website

<http://myh66.com>

<http://usermanuals.us>

<http://www.somanuals.com>

<http://www.4manuals.cc>

<http://www.manual-lib.com>

<http://www.404manual.com>

<http://www.luxmanual.com>

<http://aubethermostatmanual.com>

Golf course search by state

<http://golfingnear.com>

Email search by domain

<http://emailbydomain.com>

Auto manuals search

<http://auto.somanuals.com>

TV manuals search

<http://tv.somanuals.com>