

Breville

Breville Customer Service Centre

Australian Customers

Mail: PO Box 22
Botany NSW 2019
AUSTRALIA

Phone: 1300 139 798

Fax: (02) 9384 9601

Email: Customer Service:
askus@breville.com.au

New Zealand Customers

Mail: Private Bag 94411
Botany Manukau 2163
Auckland NEW ZEALAND

Phone: 0800 273 845

Fax: 0800 288 513

Email: Customer Service:
askus@breville.com.au

www.breville.com.au

Breville is a registered trademark of Breville Pty. Ltd. A.B.N. 98 000 092 928.
Copyright Breville Pty. Ltd. 2013.

Due to continued product improvement, the products illustrated/photographed
in this brochure may vary slightly from the actual product.

BES980 Issue - E13

Breville

the Oracle™

Instruction Booklet



BES980

CONGRATULATIONS

on the purchase of your Breville product

CONTENTS

- 4** Breville recommends safety first
- 7** Know your Breville product
- 12** Operating your Breville product
- 28** Coffee making tips & preparation
- 33** Care & cleaning
- 42** Troubleshooting
- 48** Coffees to try

At Breville we are very safety conscious. We design and manufacture consumer products with the safety of you, our valued customer, foremost in mind. In addition we ask that you exercise a degree of care when using any electrical appliance and adhere to the following precautions.

IMPORTANT SAFEGUARDS

FOR ALL ELECTRICAL APPLIANCES

- Carefully read all instructions before operating and save for future reference.
- Remove any packaging material and promotional labels or stickers before using the Oracle™ for the first time.
- To eliminate a choking hazard for young children, remove and safely discard the protective cover fitted to the power plug of this appliance.
- Do not place the product near the edge of a bench or table during operation. Ensure the surface is level, clean and free of water and other substances.
- Do not let the cord hang over the edge of a bench or table, or become knotted. Keep away from hot gas or electric burner, or where it could touch a heated oven.
- This appliance can be used by children aged from 8 years and above if they have been given supervision or instruction concerning use of the appliance in a safe way and understand the hazards involved. Cleaning and user maintenance shall not be made by children unless they are aged from 8 years and above and supervised. Keep the appliance and its cord out of reach of children aged less than 3 years.

- Appliances can be used by persons with reduced physical, sensory or mental capabilities or lack of experience and knowledge if they have been given supervision or instruction concerning use of the appliance in a safe way and understand the hazards involved.
- Children shall not play with the appliance.
- Regularly inspect the supply cord, plug and actual appliance for any damage. If found damaged in any way, immediately cease use of the appliance and return the entire appliance to the nearest authorised Breville Service Centre for examination, replacement or repair.
- Keep the appliance and accessories clean. Follow the cleaning instructions provided in this book. Any procedure not listed in this instruction booklet should be performed at an authorised Breville Service Centre.
- The installation of a residual current device (safety switch) is recommended to provide additional safety protection when using electrical appliances. It is advisable that a safety switch with a rated residual operating current not exceeding 30mA be installed in the electrical circuit supplying the appliance. See your electrician for professional advice.

SPECIFIC INSTRUCTIONS FOR BES980 THE ORACLE

- This appliance is recommended for household use only. Do not use this appliance for any purpose other than its intended use. Do not use in moving vehicles or boats. Do not use outdoors.
- If the appliance is to be:
 - left unattended
 - cleaned
 - moved
 - assembled; or
 - storedAlways switch Off the espresso machine by pressing the POWER button to Off, switch Off at the power outlet and unplug.
- Ensure the product is properly assembled before first use.
- Do not use any other liquid apart from cold mains/town water. We do not recommend the use of highly filtered, de-mineralized or distilled water as this may affect the taste of the coffee and how the espresso machine is designed to function.
- Ensure the portafilter is firmly inserted and secured into the group head before starting an extraction. Never remove the portafilter during the extraction process.
- Do not touch hot surfaces. Allow the product to cool down before moving or cleaning any parts.
- Use caution after milk texturing as the 'Auto Purge' function may purge hot steam when the steam wand is lowered.
- Use caution when operating machine as metal surfaces are liable to get hot during use.
- Use caution when using the de-scale feature as hot steam may be released. Before de-scaling, ensure drip tray is empty and inserted. Refer to page 35 for further instructions.

SAVE THESE INSTRUCTIONS

KNOW

your Breville product

KNOW YOUR BREVILLE PRODUCT

- A. **Integrated conical burr grinder**
With removable 280g bean hopper.
- B. **Top-fill 2.5L removable water tank**
With integrated water filter and backlit level indicator.
- C. **Grind Size dial**
Select the desired espresso grind size to suit your coffee beans.
- D. **Grind LCD**
Displays current grind settings.
- E. **Main LCD**
Displays current settings and simplifies programming.
- F. **1 CUP & 2 CUP buttons**
With preset shot durations, manual override or reprogrammable durations/volumes.
- G. **Grind outlet**
With auto grind, dose & tamp function.
- H. **Heated 58mm group head with embedded element**
- I. **58mm full stainless steel portafilter**
- J. **Drop down swivel foot**
Lifts the machine upwards for easy maneuverability.
- K. **Heated cup warming tray**
- L. **HOT WATER button**
Press to start and stop the flow of hot water from the hot water outlet.
- M. **LONG BLACK dial**
With preset and customisable settings.
- N. **Steam lever**
With one touch auto milk texturing (down position) and manual milk texturing (up position).
- O. **Steam LCD**
Displays current milk temperature and texture settings.
- P. **SELECT dial**
Select the desired milk temperature & texture. Also use this dial in conjunction with the MENU button to set the programmable functions.
- Q. **Cool touch steam wand**
With integrated temperature sensor.
- R. **Dedicated hot water outlet**
Delivers hot water for Long Black and pre-heating cups.
- S. **Descal access point**
- T. **Tool storage tray**
Houses accessories when not in use.
- U. **Removable drip tray**
With Empty Me! indicator.

KNOW YOUR BREVILLE PRODUCT

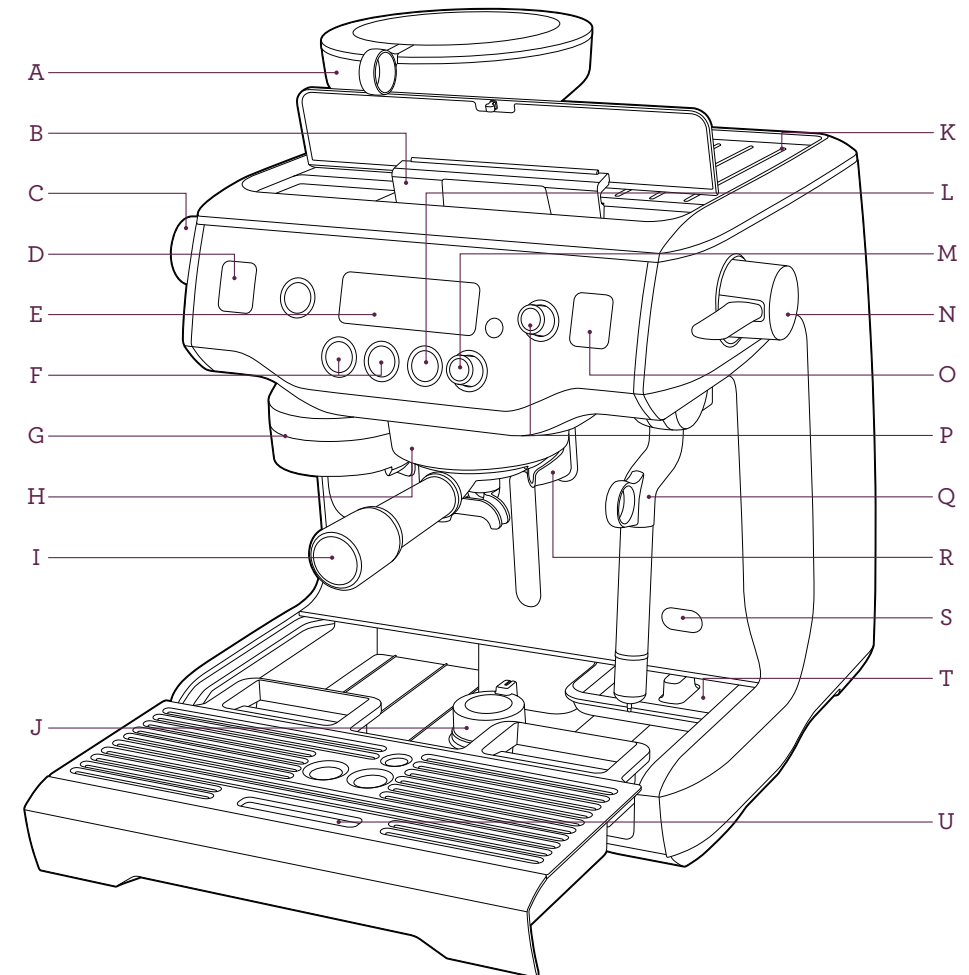

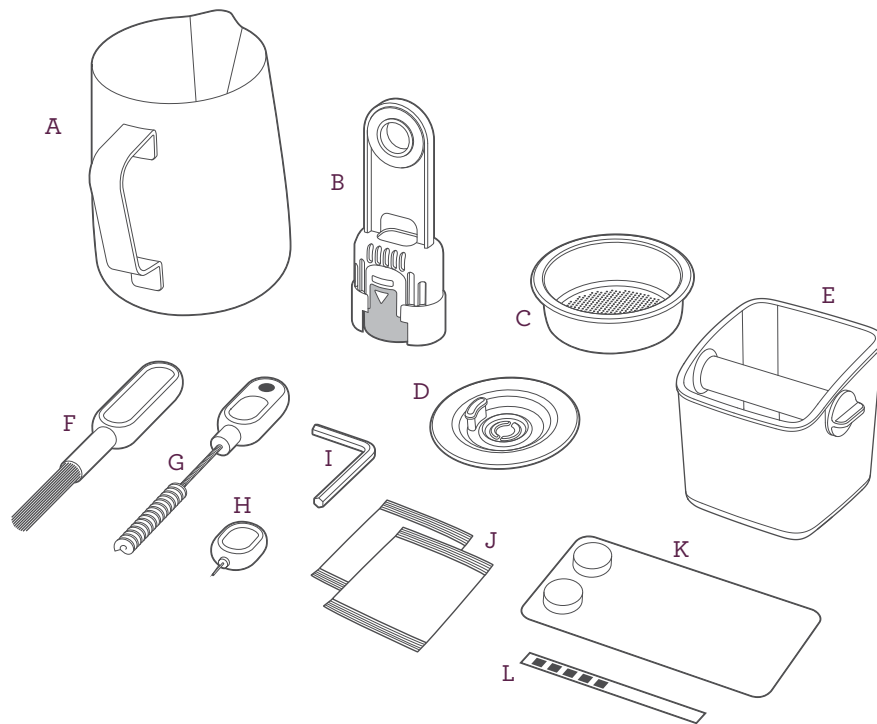

ACCESSORIES

- A. Stainless steel milk jug
- B. Water filter holder with filter
- C. Filter basket
- D. Cleaning disc
- E. Mini grinds bin
- F. Burr brush
- G. Grind outlet brush & tamp removal magnet

- H. Cleaning tool for steam wand tip
- I. Allen key
- J. Steam wand cleaning powder
- K. Espresso cleaning tablets
- L. Water hardness test strip

NOT SHOWN

Steam wand spare parts - steam wand tip, gasket, 'O' ring

HANDS FREE AUTOMATIC GRIND, DOSE & TAMP

Automatically grinds, doses and tamps the required amount of coffee, mess free.

GRIND SIZE DIAL

Adjustable grind settings from fine to coarse for optimal espresso extraction.

STAINLESS STEEL CONICAL BURRS

Maximize ground coffee surface area for a full espresso flavour.

AUTOMATIC HANDS FREE MILK TEXTURING

Automatically textures milk to the selected temperature and style from silky smooth latté to creamy cappuccino. Automatic purge removes residual milk from the steam wand when returned to the downward position.

SIMULTANEOUS COFFEE & STEAM

Dedicated stainless steel espresso and steam boilers for simultaneous milk texturing and espresso extraction.

PRECISION CONTROL

Electronic PID Temperature Control

Electronic temperature control delivers precise water temperature for optimum espresso flavour. Programmable.

Actively Heated Group Head

Commercial size 58mm group head with embedded element for thermal stability during extraction.

Regulated Extraction Pressure

Over pressure valve (OPV) limits maximum pressure for optimal espresso flavour.

Low Pressure Pre-Infusion

Gradually increases water pressure to gently expand grinds for an even extraction. Programmable.

Dual Pumps

Dedicated espresso and steam boiler pumps.

Programmable Shot Temperature

Adjust water temperature to achieve optimal espresso flavour depending on coffee origin and degree of roast.

ADDITIONAL FEATURES

One Touch Long Black

Delivers hot water directly into the cup after espresso extraction. Preset and customizable settings.

Shot Clock

Displays duration of the espresso shot being extracted.

Auto Start

Switches machine on at a specified time.

Auto Off

Switches machine off after a specified time from 10mins to 8 hours.

OPERATING

your Breville product

OPERATING YOUR BREVILLE PRODUCT

BEFORE FIRST USE

Machine Preparation

Remove and discard all labels and packaging materials attached to your espresso machine. Ensure you have removed all parts and accessories before discarding the packaging.

Remove the water tank located at the back of the machine by pulling down the water tank handle. Remove the plastic bag containing the water filter and water filter holder. Clean parts and accessories (water tank, portafilter, filter basket, jug) using warm water and a gentle dish washing liquid. Rinse well then dry thoroughly.

TIP

To easily maneuver your machine, use the drop down swivel foot located under the drip tray. When turned to UNLOCK, the swivel foot drops down & lifts the machine upwards, making it easier to access the removable water tank or reposition the machine to another location.

INSTALLING THE WATER FILTER

- Remove the water filter and water filter holder from the plastic bag.
- Soak the filter in a cup of water for 5 minutes then rinse under cold running water.
- Wash the filter holder with cold water, taking specific care to rinse the stainless steel mesh.

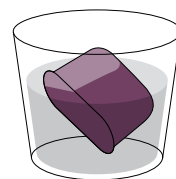

Soak filter for 5 minutes

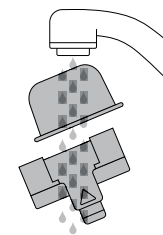

Rinse filter & mesh

- Insert the filter into the two parts of the filter holder.

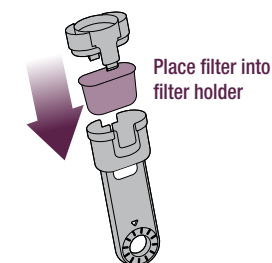

- To install the assembled filter holder into the water tank, align the base of the filter holder with the adapter inside the water tank. Push down to lock into place.

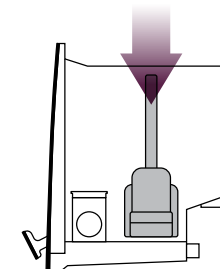

- Fill the water tank with cold water before sliding back into position at the back of the machine and locking into place.

NOTE

DO NOT use highly filtered, demineralized or distilled water in this machine. This may affect the taste of the coffee and how the machine operates.

NOTE

To purchase water filters, visit www.breville.com.au or call Breville Customer Service Centre.

FIRST USE

1. Ensure tank is filled with cold water. You can do this by either opening the top-fill water tank lid (push to open), or by removing the water tank at the back of the machine.
2. Press POWER button to turn machine on.
3. The main LCD will display 'Hrd3', prompting you to set the water hardness level. Programming this will determine the regularity of the 'CHANGE FILTER' alert which indicates when the water filter in the water tank needs to be replaced.

Setting Water Hardness

- Remove the supplied water hardness test strip from the wrapper.
 - Dip the test strip into a sample of the water you have filled the tank with. Wait for one minute. The water hardness setting is indicated by the number of red squares displayed on the test strip eg. 3 red squares indicates a water hardness setting of 3.
 - Rotate SELECT dial to the required setting from 'Hrd1' (softest water) to 'Hrd5' (hardest water). Press SELECT dial to set. Machine will beep once to confirm selection.
4. A pumping/vibrating sound will be heard indicating empty boilers are being filled with water for the first time. The main LCD will display the current boiler temperature and flash 'HEATING'.
 5. After approximately 5 minutes, the machine will reach the default operating temperature 93°C and all 6 buttons will illuminate. The machine is now in STANDBY mode, ready for the next step, 'Flushing The Machine'.

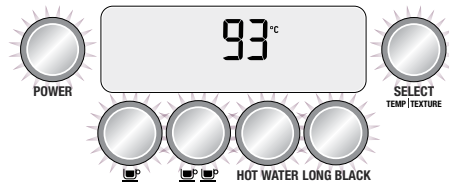

Flushing The Machine

When the machine has reached STANDBY mode:

1. Press 2 CUP button to run water through the group head for 30 seconds.
2. Press HOT WATER button to run water through the hot water outlet. After 30 seconds, press HOT WATER button again to stop the flow of water.
3. Lift steam lever to the MANUAL position to release steam through the steam wand. After 30 seconds, lower the steam lever to the centre OFF position.
4. Repeat steps 1-3 twice.
5. Re-fill water tank and empty drip tray, if required.

MANUAL will flash on LCD

The machine will not reach operating temperature (STANDBY mode) if the steam lever is in the MANUAL position. The steam LCD will display 'MANUAL'. Lower the steam lever to the centre OFF position.

Steam operation is ready when the SELECT dial illuminates.

NOTE

You will not be able to select the 1 CUP, 2 CUP or LONG BLACK functions; or access the cleaning cycle in the menu options until the machine has reached operating temperature (STANDBY mode). The machine will beep 3 times if one of these functions is selected.

GRINDING OPERATION

Insert bean hopper into position on-top of the machine. Turn knob to lock into place. Fill hopper with fresh beans.

TIP

We recommend quality 100% Arabica beans with a 'Roasted On' date stamped on the bag, not a 'Best Before' or 'Use By' date. Coffee beans are best consumed between 10-30 days after the 'Roasted On' date. Stale coffee may pour too quickly from the portafilter spouts and taste bitter and watery.

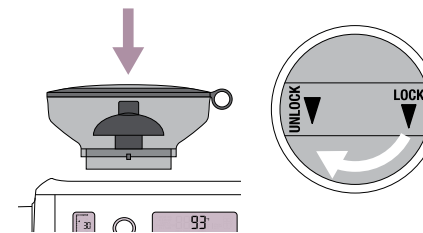

SELECTING GRIND SIZE

There are 45 espresso grind size settings (No.1 - finest, No. 45 - coarsest) to enable you to select the right grind size for your coffee beans and achieve the perfect espresso extraction.

To select grind size, rotate the grind size dial counter-clockwise to increase grind coarseness or clockwise to increase grind fineness.

We recommend you start at No. 30 and adjust as required to control espresso flow rate.

AUTO GRIND DOSE & TAMP

Align portafilter handle with the INSERT position on the grind outlet. Lift to insert portafilter into the grind outlet and rotate to the centre position.

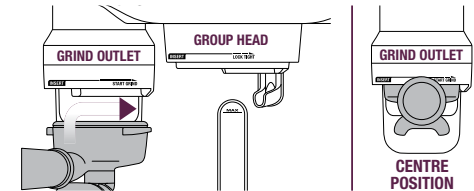

To start the auto grind, dose & tamp function, rotate the portafilter to the right then gently guide back to the centre position. Grinding will commence.

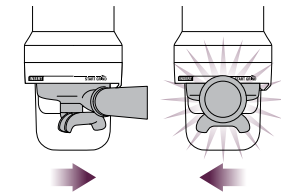

When the auto grind, dose & tamp function is complete, rotate the portafilter handle to the INSERT position and lower to remove.

ESPRESSO EXTRACTION

Align portafilter handle with the INSERT position on the group head. Lift to insert portafilter into the group head and rotate towards the LOCK TIGHT position until resistance is felt.

EXTRACTION GUIDE

The 1 CUP button ☕ & 2 CUP button ☕☕ use duration to control espresso volume. The duration times are preset, but can be reprogrammed (refer to 'Programming Shot Volume/Duration', page 19). Alternatively, access the Advanced Features if you wish to use volumetric controls instead of duration to determine espresso volume (refer to 'Flow Measurement Method (VoL)', page 25).

1 CUP BUTTON ☕

Press 1 CUP button once to extract a single shot of espresso at the preset duration (20 seconds). The extraction will start using the low pressure pre-infusion.

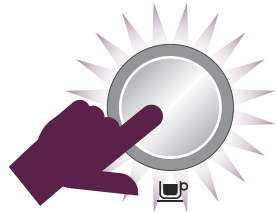

The machine will stop after 1 CUP duration has been extracted and will return to STANDBY mode.

2 CUP BUTTON ☕☕

Press 2 CUP button once to extract a double shot of espresso at the preset duration (30 seconds). The extraction will start using the low pressure pre-infusion.

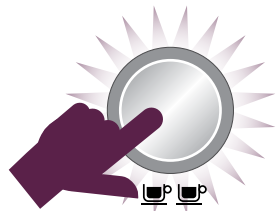

The machine will stop after 2 CUP duration has been extracted and will return to STANDBY mode.

MANUAL OVERRIDE

Press and hold either 1 CUP or 2 CUP button to commence pre-infusion. When the required pre-infusion duration is met, release button to begin full pump pressure.

Press button again to stop pour when required duration has been achieved.

TEXTURING MILK

The SELECT dial is used to select milk temperature and texture. Press the dial to toggle between milk temperature & texture. The flashing value (either temperature or texture triangle) can be changed by rotating the dial.

ADJUSTING MILK TEMPERATURE

Press the SELECT dial until the milk temperature flashes. Rotate dial to increase or decrease milk temperature. The selected temperature will be displayed on the steam LCD. The ideal temperature for milk is between 55°C–65°C as indicated by the smiley face icon.

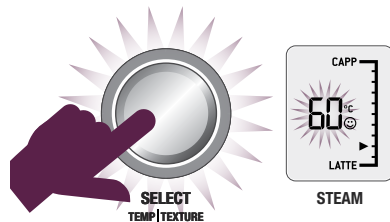

ADJUSTING MILK TEXTURE

Press the SELECT dial until the milk texture triangle flashes. Rotate dial towards 'CAPP' for more texture or 'LATTE' for less texture. The selected texture will be displayed on the steam LCD.

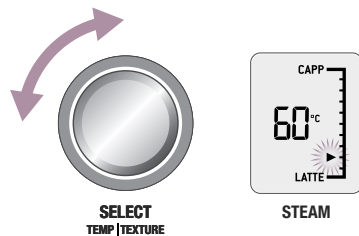

Different brands and types of milk and milk alternatives will texture differently. You may need to adjust the texture level accordingly.

NOTE

Prior to texturing milk, always purge steam wand by momentarily pressing down the steam lever.

AUTO MILK TEXTURING

Start with fresh cold milk. Fill milk jug to below the spout position. Lift steam wand and insert into milk jug. Lower steam wand, ensuring it is fully down. The milk jug should rest on the drip tray and milk should cover the steam wand seal.

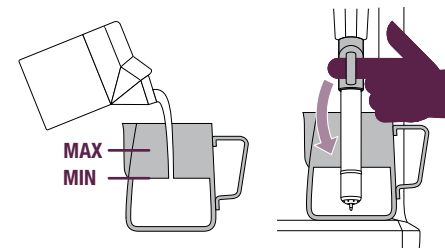

To start, press down and release steam lever. The LCD will display the temperature of the milk as it heats. Milk texturing will stop automatically when the selected milk temperature is reached. Lift steam wand to remove milk jug. **Wipe the wand & tip with a damp cloth.** Lower steam wand to the down position and the wand will automatically purge.

MANUAL MILK TEXTURING

Auto milk texturing and auto shut-off are disabled during manual milk texturing mode.

Insert steam wand into milk jug. Lift steam lever to activate manual steam mode. Once the desired milk texture and temperature are achieved, lower the steam lever to the centre OFF position. **Wipe the wand & tip with a damp cloth.** Lower steam wand to the down position and the wand will automatically purge.

CAUTION: BURN HAZARD

Pressurized steam can still be released, even after machine has been switched off.

Children must always be supervised.

PRESET LONG BLACK

There are 3 preset Long Black settings – small, medium and large. To use one of these settings:

1. Fill the portafilter using the auto grind, dose & tamp function.
2. Insert the portafilter into the group head.
3. Position your cup so the portafilter spouts and hot water outlet are directed inside the cup.

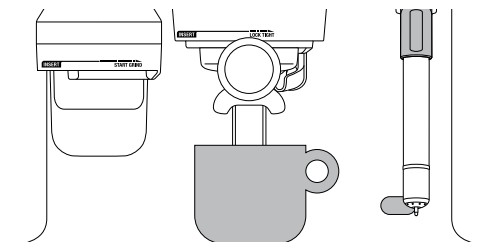

- Rotate the LONG BLACK dial to the desired cup size.

PRESET CUP SIZE	AMOUNT BREWED
Small	Approx. 180ml
Medium	Approx. 240ml
Large	Approx. 355ml

The brewed amounts are approximate only. Actual amounts may vary due to the coffee bean roast, blend and freshness as well as the selected grind size. These factors affect extraction rate and shot volume.

- To start extraction, press the LONG BLACK dial. Espresso will extract from the portafilter spouts, followed by hot water from the hot water outlet.

NOTE

To override the setting during operation, press the LONG BLACK dial. Pressing the LONG BLACK dial during the espresso extraction will stop the flow of espresso and start the flow of hot water. Pressing the LONG BLACK dial during the hot water delivery will stop the flow of hot water.

TIP

If the preset Long Black settings do not suit your cup size or strength preferences, there are 6 custom Long Black settings for you to program. Once programmed, your custom setting will appear after the 3 preset settings. Refer to 'Long Black Adjust - Programming Custom Settings', page 22.

MANUAL LONG BLACK

This allows you total control over the Long Black process: pre-infusion duration, espresso volume & hot water volume. During manual Long Black mode, the LCD will show a moving cup icon.

Press and hold LONG BLACK dial to activate pre-infusion. Release LONG BLACK dial to commence espresso pour.

Press the LONG BLACK dial to stop espresso pour and commence hot water pour.

Press the LONG BLACK dial again to stop the pour of hot water.

TIP

You can conduct a manual Long Black extraction each time, or program this as a custom setting. Once programmed, your custom setting will appear after the 3 preset settings. Refer to 'Long Black Adjust - Programming Custom Settings', page 22.

HOT WATER

The HOT WATER button can be used to pre-heat cups or add hot water manually.

To stop and start the pour of hot water, press the HOT WATER button.

To ensure water is dispensed at the correct temperature, hot water will cease to dispense after approx. 30 seconds. Depending on the size of your cup, you may need to press the HOT WATER button a second time.

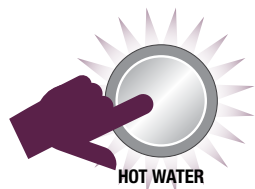

NOTE

You cannot run hot water and extract espresso at the same time.

PROGRAMMABLE FUNCTIONS

To enter program mode, press the MENU button. Rotate SELECT dial to the desired function.

Program mode allows you to program:

- Shot Volume
- Shot Temperature
- Clean Cycle
- Set Clock
- Auto Start
- Auto Off
- Tamp Set
- Pre-Infusion
- Long Black Adjust

To exit program mode, press MENU button.

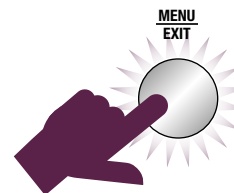

NOTE

The MENU button is disabled when the machine is in coffee making mode or dispensing hot water.

PROGRAMMING SHOT VOLUME/DURATION

Fill the portafilter using the auto grind, dose & tamp function. Insert the portafilter into the group head.

While 'SHOT VOL' is displayed on the LCD, rotate the SELECT dial to '1 CUP' to reprogram the 1 CUP button, or '2 CUP' to reprogram the 2 CUP button. Press the SELECT dial to start espresso extraction. When required espresso volume/duration has been extracted, press SELECT dial to stop extraction. Machine will beep once to confirm the new volume/duration.

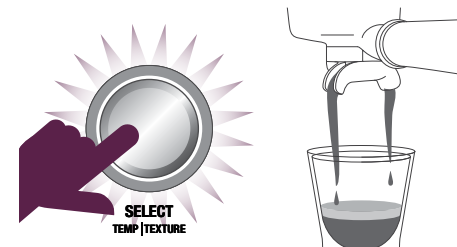

NOTE

The 1 CUP & 2 CUP buttons use duration to control espresso volume. Access the Advanced Features if you wish to use volumetric controls instead of duration to determine espresso volume. Refer to 'Flow Measurement Method (VoL)', page 25).

SHOT TEMPERATURE

While 'SHOT TEMP' is displayed on the LCD, press the SELECT dial. The current temperature will flash. Turn the SELECT dial to required temperature then press SELECT dial to set. Machine will beep once to confirm new temperature.

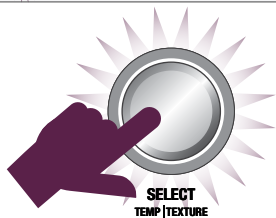
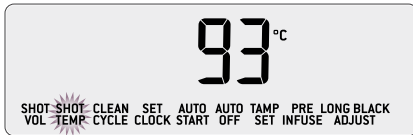

CLEANING CYCLE

The cleaning cycle cleans the shower screen and back-flushes the group head. Select this feature when the LCD displays 'CLEAN ME!' Refer to 'Cleaning Cycle', page 34.

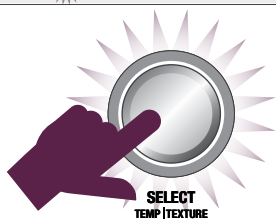

SET CLOCK

Setting the clock is optional. While 'SET CLOCK' is displayed on the LCD, press the SELECT dial. The current time will flash or default to 12.00AM if the time has not been set. Turn the SELECT dial to the left or right to adjust time. Turning the SELECT dial faster or slower will change the rate of adjustment. When required time has been reached, press the SELECT dial to set. Machine will beep once to confirm the clock has been set.

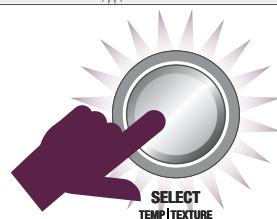

AUTO START

Auto Start is optional. It allows you to program the specific time when the machine will automatically turn on. By programming your machine, you will not have to wait for it to pre-heat. We recommend programming the machine to start 30 minutes before you plan to use it.

NOTE

The clock must be set before the Auto Start time can be programmed. If you try to turn Auto Start on without first setting the clock, the machine will beep 3 times.

Turn the SELECT dial to the left or right to select the desired Auto Start time. Turning the SELECT dial faster or slower will change the rate of adjustment. When required time has been reached, press the SELECT dial to set. A small clock icon will be displayed on the LCD when the Auto Start function has been programmed.



While 'AUTO START' is displayed on the LCD, press the SELECT dial. Turn the SELECT dial to on (On) or off (OFF). Press SELECT dial to set.

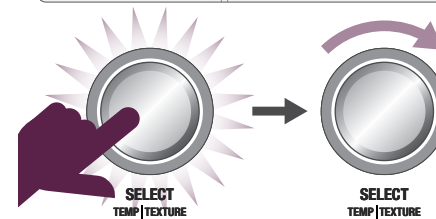

AUTO OFF

This function sets how long the machine will stay turned on before it automatically turns off. It can be set for 10mins, 30mins, 1hr, 2hrs, 3hrs, 4hrs, 5hrs, 6hrs, 7hrs or 8hrs until Auto Off activates.

While 'AUTO OFF' is displayed on the LCD, press the SELECT dial. Turn the SELECT dial to the desired time then press SELECT dial to set. Machine will beep once to confirm selection.

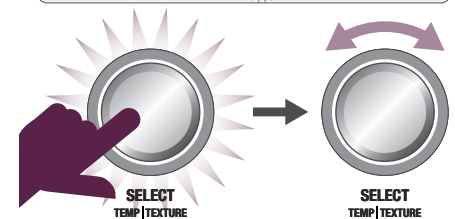

TAMP SET

This function is for advanced use only.

Adjusting tamp parameters allows for fine tuning of coffee tamping force & polishing duration. While 'TAMP SET' is displayed on the LCD, press the SELECT dial. The tamp force setting will flash. Turn SELECT dial to setting 1-9.

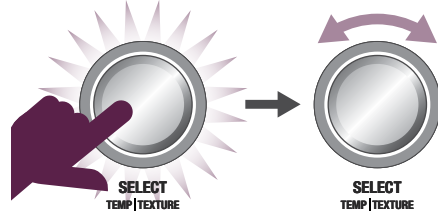
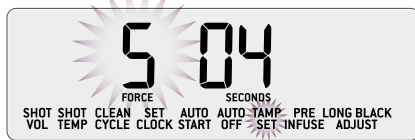

Press SELECT dial to set and the current polishing time will flash. Turn SELECT dial to select 2-7 seconds. Press SELECT dial to set. Machine will beep once to confirm settings.

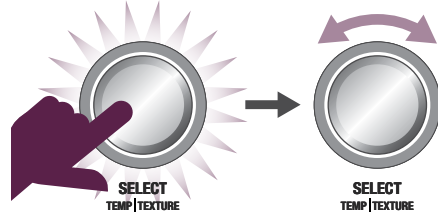
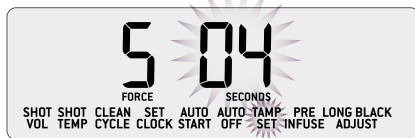

PRE-INFUSION

This function is for advanced use only.

Low pressure pre-infusion allows you to control the pressure & duration of the pre-infusion phase of the espresso extraction. While 'PRE INFUSE' is displayed on the LCD, press the SELECT dial. The pump power setting will flash. Turn SELECT dial to increase or decrease the pre-infusion pressure. Press SELECT dial to set and pre-infusion duration will flash. Turn SELECT dial to adjust seconds. Press SELECT dial to set. Machine will beep once to confirm settings.

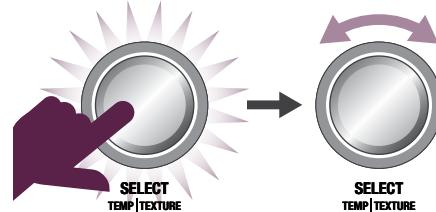

LONG BLACK ADJUST - PROGRAMMING CUSTOM SETTINGS

There are 6 custom Long Black settings for you to program to suit your cup size and strength preferences. To program your custom setting:

1. Fill the portafilter using the auto grind, dose & tamp function.
2. Insert the portafilter into the group head.
3. Position your cup so the portafilter spouts and hot water outlet are directed inside the cup.

4. Press the MENU button. Rotate the SELECT dial to 'LONG BLACK ADJUST' then press the SELECT dial.



PROGRAMMED

5. Rotate SELECT dial to the custom setting you'd like to program - 'Set 1' to 'Set 6'. Settings that have already been programmed will display a cup icon.



NOT PROGRAMMED

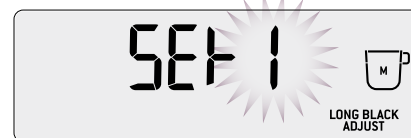

PROGRAMMED

6. To start programming, press the SELECT dial. The LCD will show a moving cup icon and espresso will extract from the portafilter spouts. When required amount has been extracted, press the SELECT dial to stop the flow of espresso and start the flow of hot water. When required amount of water has poured, press the SELECT dial to stop the flow of hot water. The LCD will show a cup icon and the machine will beep to confirm your custom Long Black setting has been programmed.

7. To use your custom Long Black setting, rotate the LONG BLACK dial. Your programmed custom Long Black setting will appear after the preset small, medium and large settings. Press the LONG BLACK dial and your programmed Long Black setting will dispense.

NOTE

Custom Long Black settings can be reprogrammed by following steps 1-6.

ADVANCED FEATURES

These features should only be accessed by experienced users.

To access Advanced Features, with the machine turned off, press and hold the 1 CUP button, then press and hold the POWER button together for 3 seconds. Rotate the SELECT dial to the desired feature. Press SELECT dial to access feature settings.

Press the MENU button at any time to exit Advanced Features.

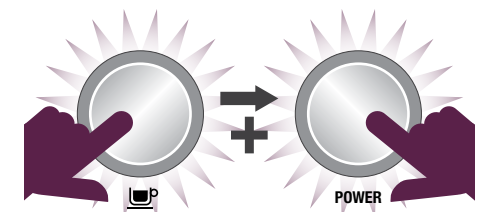

NOTE

The machine will exit Advanced Features if there is no user input for 30 seconds or the POWER button or MENU button is pressed.

Reset Default Settings (rSEt)

Use this function to reset all programmable values back to the default settings. The machine has the following default settings:

1. Shot Temperature: 93°C
2. Low Pressure Pre-infusion: PP60, PT7 seconds
3. Milk Temperature: 65°C
4. Auto Start: OFF (8:00am)
5. Auto Off: 1 Hour
6. Clock: 12:00am
7. 1 CUP Button Shot Duration: 20 seconds
8. 2 CUP Button Shot Duration: 30 seconds

While 'rSET' is displayed on the LCD, press the SELECT dial to reset all settings to factory defaults.

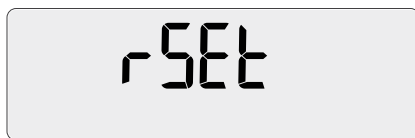

'Hrd3' will flash on screen. Machine is now in Water Hardness mode. See 'Water Hardness (Hrd3)' to set.

Descale (dESc)

Select this feature to access the step by step descale procedure on the LCD. Refer to page 38 for the accompanying instructions.

Water Hardness (Hrd3)

Determine water hardness with the supplied water hardness test strip. Refer to 'Setting Water Hardness', page 14.

Rotate SELECT dial to the required setting from 'Hrd1' (softest water) to 'Hrd5' (hardest water). Press SELECT dial to set. Machine will beep once to confirm selection.

Setting water hardness will determine the regularity of the 'CHANGE FILTER' alert which indicates when the water filter in the water tank needs to be replaced.

Units (SEt)

Set units to metric or imperial. Rotate SELECT dial to the desired unit. Press SELECT dial to set. Machine will beep once to confirm selection.

LCD Backlight (Lcd)

Adjust the LCD brightness/contrast. Rotate SELECT dial to the desired brightness. Press SELECT dial to set. Machine will beep once to confirm selection.

Spotlights (SPot)

Adjust the brightness of the LEDS lighting the drip tray area. Rotate SELECT dial to the desired brightness. Press SELECT dial to set. Machine will beep once to confirm selection.

Steam Temperature (StEA)

Adjust the steam boiler temperature, which in turn controls steam pressure. Rotate SELECT dial to the desired temperature. The default is 135°C. Press SELECT dial to set. Machine will beep once to confirm selection.

Air Pump Delay (Air)

This function is for advanced use only. Delay the operation of the air pump during automatic milk texturing. Rotate SELECT dial to the desired delay time. The default setting is 02 seconds. Press SELECT dial to set. The default temperature which the air pump turns off will be displayed. Rotate SELECT dial to the desired temperature. Press SELECT dial to set. Machine will beep once to confirm selection.

Sound (Snd)

Adjust the audible alerts. Rotate SELECT dial to the desired setting. Select between off (OFF), low (Lo) or high (Hi). Press SELECT dial to set. Depending on the selected setting, the machine may beep once to confirm selection.

Fan Control (FAn)

Adjust the speed of the internal cooling fan. Rotate SELECT dial to the desired fan speed. Select between Silent (SILt), Standard (StNd) or cool (CooL). Press SELECT dial to set. Machine will beep once to confirm selection.

Disable Clean Me! Alert (Cln)

Disables the 'CLEAN ME!' alert. Rotate SELECT dial to on (On) or off (OFF). The default setting is on. Press SELECT dial to set. Machine will beep once to confirm selection.

12h or 24h Clock (CLoC)

Display time in 12h or 24h format. Rotate SELECT dial to the desired unit. Press SELECT dial to set. Machine will beep once to confirm selection.

Flow Measurement Method (VoL)

Select between volume based (FLo) or time based (SEc) method for espresso dose measurement. Rotate SELECT dial to the desired method. Press SELECT dial to set. Machine will beep once to confirm selection.

ALERTS

MANUAL will flash on steam LCD

The machine will not reach operating temperature (STANDBY mode) if the steam lever is in the MANUAL position. The steam LCD will display 'MANUAL'. Lower the steam lever to the centre OFF position.

Steam operation is ready when the SELECT dial illuminates.

Fill Tank

The machine will detect a low water level. The LCD will display 'FILL TANK'.

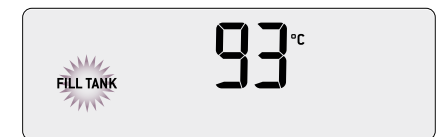

Fill tank with cold fresh water. The machine will not be able to make coffee or hot water while the tank is empty.

Clean Me!

Indicates when 200 extractions have been carried out since the last cleaning cycle.

The cleaning cycle cleans the shower screen and back-flushes the group head. For information on how to clean the machine, refer to 'Cleaning Cycle', page 34.

**Heating**

Indicates when the machine is heating up or if the temperature drops excessively during use.

Lock Hopper

Indicates if the bean hopper has not been properly inserted and locked into position. The auto grind, dose & tamp function cannot be used during this time and 3 beeps will sound if user attempts to activate.

Overheat Please Wait

Indicates if the grinder is used excessively and needs time to cool. The auto grind, dose & tamp function cannot be used during this time and 3 beeps will sound if user attempts to activate.

Change Filter

Indicates when the water filter in the water tank needs to be replaced. For information on changing the filter, refer to 'Installing The Water Filter', page 34.

The regularity of this alert is determined by the water hardness setting (Hrd1-Hrd5) selected. For information, refer to 'Setting Water Hardness', page 14 and 'Water Hardness (Hrd3)', page 24.

TRANSPORTING AND STORING

We recommend draining both boilers completely before transporting the machine or storing for an extended period of time.

This procedure is also intended as an anti-freeze measure in the event the machine is exposed to extreme cold temperatures.

CAUTION

Never open DESCALC ACCESS valves while machine is still hot. Always turn off the machine and allow to cool for at least 1 hour prior to starting descale process.

CAUTION

During descale process, water may flow through group head and the drip tray will fill with water.

Step 1 – Preparation

- a) Ensure the machine is off and has cooled for at least 1 hour.
- b) Empty water tank, remove water filter then replace and lock water tank back into position.
- c) Ensure drip tray is empty and fully inserted into position.

Step 2 – Empty Boilers

- a) Remove the grey silicone cover on the lower front panel marked DESCALC ACCESS. Place a cloth over the drip tray to stop steam escaping.

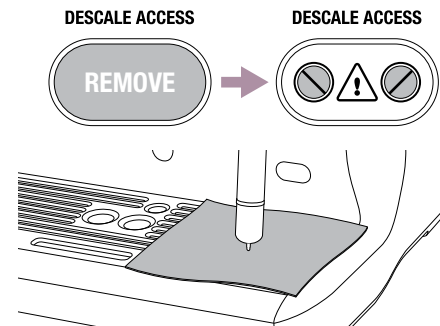

- b) Use a flat-head screwdriver to rotate the right screw counter-clockwise until the valve is fully open. As the valve opens, steam may be released.

CAUTION HOT WATER & STEAM

DESCALC ACCESS

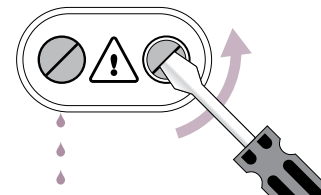

- c) Next, repeat the above process on the left screw. As the valve is opened, water may begin flowing into the drip tray.
- d) Allow valves to remain open until no more water or steam escapes.

- e) Close both valves by rotating screws clock-wise until seated. Do not overtighten screws to avoid damaging the valves. Replace the grey silicone cover over the valves.

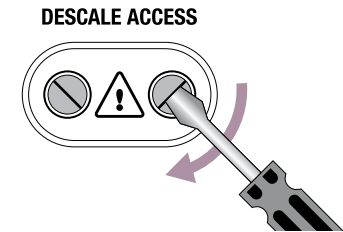

- f) Empty drip tray and reinsert into position. Use caution as the drip tray may be hot due to the water and steam from the boilers.

COFFEE MAKING TIPS & PREPARATION

COFFEE MAKING TIPS & PREPARATION

PRE-HEATING

Heating your cup or glass

A warm cup will help maintain the coffee's optimal temperature. Pre-heat your cup by rinsing with hot water from the hot water outlet and place on the cup warming tray.

Heating the portafilter and filter basket

A cold portafilter and filter basket can reduce the extraction temperature enough to significantly affect the quality of your espresso. Always ensure the portafilter and filter basket are pre-heated with hot water from the hot water outlet before initial use.

NOTE

Always wipe the filter basket and portafilter dry before dosing with ground coffee as moisture can encourage 'channeling' where water by-passes the ground coffee during extraction.

THE GRIND

When grinding coffee beans for espresso, the grind size should be fine but not too fine. The grind size will affect the rate at which the water flows through the ground coffee in the filter basket and the taste of the espresso.

If the grind is too fine (looks like powder and feels like flour when rubbed between fingers), the water will not flow through the coffee even when under pressure. The resulting espresso will be **OVER-EXTRACTED**, dark in color and bitter in flavour.

If the grind is too coarse the water will flow through the ground coffee in the filter basket too quickly. The resulting espresso will be **UNDER-EXTRACTED**, lacking in color and flavour.

AUTOMATIC GRINDING, DOSING & TAMPING

- Ensure hopper is filled with fresh coffee beans. We recommend quality 100% Arabica beans with a 'Roasted On' date stamped on the bag, not a 'Best Before' or 'Use By' date. Coffee beans are best consumed between 10-30 days after the 'Roasted On' date. Stale coffee may pour too quickly from the portafilter spouts and taste bitter and watery. Never put pre-ground coffee in the hopper.
- Align portafilter handle with the **INSERT** position on the grind outlet. Lift to insert portafilter into the grind outlet and rotate to the centre position.

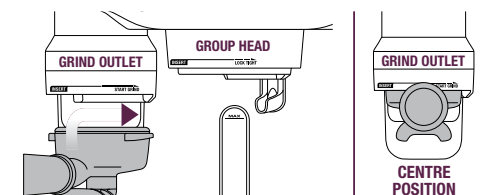

- To start the auto grind, dose & tamp function, rotate the portafilter to the right then gently guide back to the centre position. Grinding will commence.

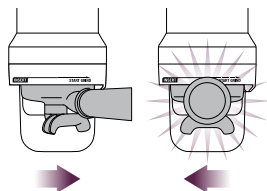

- When the auto grind, dose & tamp function is complete, rotate the portafilter handle to the INSERT position and lower to remove.
- Wipe any excess coffee from the rim of the filter basket to ensure a proper seal in the group head is achieved

PURGING THE GROUP HEAD

Before placing the portafilter into the group head, run a short flow of water through the group head by pressing the 1 CUP button. Allow water to flow for 5 seconds, then press the 1 CUP button again to stop the flow of water. This will purge any ground coffee residue from the group head and stabilize the water temperature prior to extraction.

INSERTING THE PORTAFILTER

Align portafilter handle with the INSERT position on the group head. Lift to insert portafilter into the group head and rotate towards the LOCK TIGHT position until resistance is felt.

EXTRACTING ESPRESSO

- Place pre-warmed cup(s) beneath the portafilter spouts and press the 1 CUP or 2 CUP button.
- As a guide, the espresso will start to flow after 9-14 seconds (this includes pre-infusion time) and should be the consistency of warm dripping honey.
- If the espresso starts to flow before 9 seconds, the grind is too coarse. This is an UNDER-EXTRACTED shot. Adjust the grind size slightly finer.
- If the espresso starts to drip or flow after 14 seconds, then the grind is too fine. This is an OVER-EXTRACTED shot. Adjust the grind size slightly coarser.

A great espresso is about achieving the perfect balance between sweetness, acidity and bitterness.

The flavour of your coffee will depend on many factors, such as the type of coffee beans, degree of roast, freshness, coarseness or fineness of the grind.

Experiment by adjusting these factors just one at a time to achieve the taste of your preference.

EXTRACTION GUIDE

EXTRACTION TYPES	GRIND	SHOT DURATION
OVER-EXTRACTED (bitter • astringent)	Too Fine	Over 45secs
BALANCED	Optimum	Between 15-40secs
UNDER-EXTRACTED (underdeveloped • sour)	Too Coarse	Less than 15secs

HINTS & TIPS

If machine is run continuously for 30 minutes, allow machine to cool for 3 minutes before each use.

TEXTURING MILK

The machine allows you to texture milk both automatically and manually.

Automatic Hands-Free Milk Texturing:

- Set Milk Temperature: Press the SELECT dial to toggle to the milk temperature function, as indicated by the flashing milk temperature. Rotate SELECT dial to the desired milk temperature, then press the dial to select.
- Set Milk Texture: Press the SELECT dial to toggle to the milk texture function, as indicated by the flashing milk texture triangle. Rotate SELECT dial towards 'CAPP' for more texture or 'LATTE' for less texture, then press the dial to select.
- Always start with fresh cold milk.
- Fill milk jug to below the spout position. At a minimum, there should be enough milk to cover the steam wand seal.
- To remove any condensed water from the system, ensure the steam wand is in the down position over the drip tray then momentarily lift the steam lever.
- Lift steam wand & insert into milk jug. Lower steam wand, ensuring it is fully down. The milk jug should rest on the drip tray.
- Press down & release steam lever to start automatic milk texturing.
- Steam LCD will display the temperature of the milk as it heats.
- Milk texturing will automatically stop when the selected temperature is reached.
- Lift & remove steam wand from the milk jug.
- Wipe the wand & tip with a damp cloth.** Lower steam wand to the down position and the wand will automatically purge.

HINTS & TIPS

For optimum milk texturing performance it is critical that the holes around the steam tip are clear. Even partially blocked holes may affect the ability of the steam wand to produce sufficient foam.

Always wipe the wand and tip with a damp cloth BEFORE returning the wand to the down position. Wiping the wand will remove the majority of milk and allow the automatic purge feature to more effectively remove any residual milk.

- Tap the jug on the counter-top to collapse any bubbles.
- Swirl the jug to polish and re-integrate the texture.
- Pour milk directly into the espresso.
- The key is to work quickly, before the milk begins to separate.

Manual Milk Texturing

Auto milk texturing and auto shut-off are disabled during manual milk texturing mode.

- Always start with fresh cold milk.
- Fill milk jug to below the spout position.
- To remove any condensed water from the system, ensure the steam wand is in the down position over the drip tray then momentarily lift the steam lever.
- Insert the steam tip 1-2cm below the surface of the milk close to the right hand side of the jug at the 3 o'clock position.
- Lift the steam lever to start the flow of steam.
- Keep the tip just under the surface of the milk until the milk is spinning clockwise, producing a vortex (whirlpool effect).

COFFEE MAKING TIPS & PREPARATION

- With the milk spinning, slowly lower the jug. This will bring the steam tip to the surface of the milk & start to introduce air into the milk. You may have to gently break the surface of the milk with the tip to get the milk spinning fast enough.
- Keep the tip at or slightly below the surface, continuing to maintain the vortex. Texture the milk until sufficient volume is obtained.
- Lift the handle of the jug to lower the tip beneath the surface, but keep the vortex of milk spinning. Use the steam LCD to monitor the milk temperature. We recommend 55°C–65°C.
- Move the steam lever to the centre OFF position BEFORE lowering the jug and taking the tip out of the milk.
- **Wipe the wand & tip with a damp cloth.** Lower steam wand to the down position and the wand will automatically purge.
- Tap the jug on the counter-top to collapse any bubbles.
- Swirl the jug to polish and re-integrate the texture.
- Pour milk directly into the espresso.
- The key is to work quickly, before the milk begins to separate.

COFFEE BEAN HINTS & TIPS

- Fresh, quality coffee beans will give you the best possible extraction.
- We recommend quality 100% Arabica beans with a 'Roasted On' date stamped on the bag, not a 'Best Before' or 'Use By' date.
- Coffee beans are best consumed between 10-30 days after the 'Roasted On' date. Ideally only grind directly before the extraction to maximize flavour.
- Buy coffee beans in small batches to reduce the storage time.
- Store coffee beans in a cool, dark and dry container. Vacuum seal if possible.

CARE & CLEANING

CARE & CLEANING

CLEANING CYCLE

- CLEAN ME! will be displayed on the LCD to indicate when a cleaning cycle is required (approx. 200 shots). The cleaning cycle cleans the shower screen and back-flushes the group head.



- Insert the supplied grey silicone cleaning disc, followed by 1 cleaning tablet into the filter basket.
- Lock the portafilter into the group head.
- Ensure the water tank is filled with cold water and the drip tray is empty.
- Press the MENU button and rotate SELECT dial until 'CLEAN CYCLE' and 'PUSH' are displayed on the LCD.

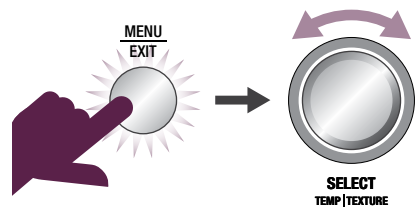
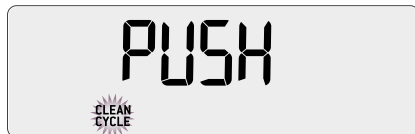

- Press the SELECT dial to start the cleaning cycle.

- The LCD will display a countdown timer showing remaining time for the cleaning cycle in seconds.

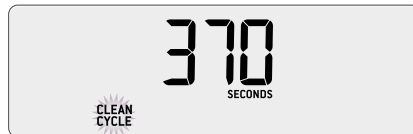

- When the cleaning cycle has finished, remove the portafilter and ensure the tablet has completely dissolved. If the tablet has not dissolved, repeat these steps, without inserting a new tablet.
- Rinse the filter basket and portafilter thoroughly before use.
- Extract an espresso to "season" the machine and purge the system of any remaining cleaner.

INSTALLING THE WATER FILTER

- Discard the used water filter. Soak a new filter in a cup of water for 5 minutes, then rinse under cold running water.
- Wash the filter holder with cold water, taking specific care to rinse the stainless steel mesh.
- Insert the filter into the two parts of the filter holder.
- To install the assembled filter holder into the water tank, align the base of the filter holder with the adapter inside the water tank. Push down to lock into place.
- Fill the water tank with cold water before sliding back into position at the back of the machine and locking into place.

NOTE

Visit www.breville.com.au or call Breville Customer Service Centre to purchase water filters.

CARE & CLEANING

CLEANING CONICAL BURRS

Regular cleaning helps the burrs achieve consistent grinding results which is especially important when grinding for espresso.

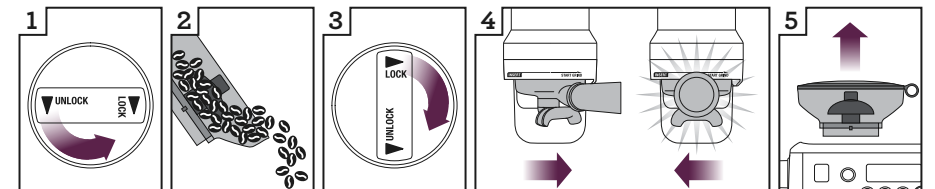

1 Unlock hopper 2 Remove beans 3 Replace & lock hopper 4 Run grinder until empty 5 Unlock & remove hopper

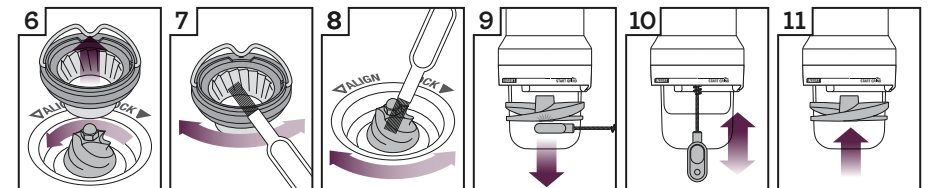

6 Remove upper burr 7 Clean upper burr with burr brush 8 Clean lower burr with burr brush 9 Remove tamping fan with tamp removal magnet 10 Clean grind outlet with grind outlet brush 11 Replace tamping fan by hand

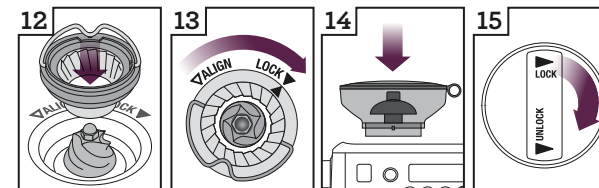

12 Push upper burr firmly into position 13 Lock upper burr 14 Insert hopper 15 Lock hopper

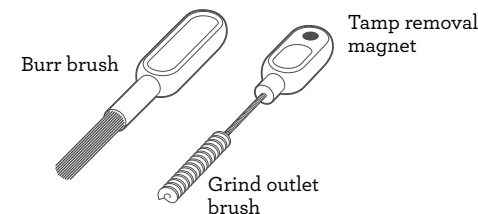

CLEANING THE STEAM WAND

! IMPORTANT

After every use, thoroughly wipe the steam wand and tip with a damp cloth & purge immediately. Failure to clean the steam wand may affect the milk texturing performance.

- If any of the holes in the tip of the steam wand become blocked, ensure the steam lever is in the centre OFF position and unblock using the steam tip cleaning tool. Even partially blocked holes may affect the ability of the steam wand to produce sufficient foam volume.
- If steam wand remains blocked, remove the tip and soak together with steam wand using the provided steam wand cleaning powder (instructions below). Screw tip back onto the steam wand after rinsing.
- The steam wand can be left immersed in the milk jug filled with water when not in use to reduce the risk of blockages.

Steam Wand Cleaning Powder

1. Add 1 packet into an empty milk jug.
2. Add 1 cup (240ml) hot water into milk jug.
3. Remove steam tip and place with steam wand into jug.
4. Leave to soak for 20 minutes.
5. Clean, rinse and replace steam tip. Place wand back into the jug and activate steam for 10 seconds.

6. Allow to soak for 5 minutes.
7. Activate steam several times to purge the steam wand, then rinse the wand thoroughly.
8. Wipe the steam wand dry with a clean cloth.
9. Discard solution & rinse jug thoroughly.

STEAM WAND SPARE PARTS

- Please exercise care when cleaning the steam wand to avoid damaging or losing the silicone seals.
- If the seals do become damaged however, replace them with the supplied steam wand tip, gasket and 'O' ring.
- For additional advice please contact Breville Consumer Support.

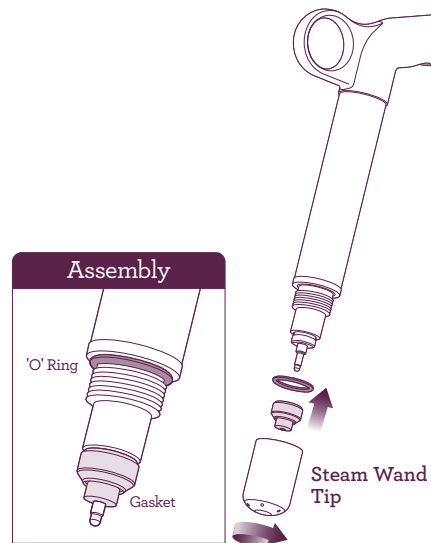
**CLEANING THE FILTER BASKET AND PORTAFILTER**

- The filter basket and portafilter should be rinsed under hot water after each coffee making session to remove all residual coffee oils.
- If the holes in the filter basket become blocked, dissolve a cleaning tablet in hot water and soak filter basket and portafilter in solution for approx. 20 minutes. Rinse thoroughly.

CLEAR WATER BACKFLUSH

- After each coffee making session we recommend doing a clear water backflush before you turn off the machine. Empty drip tray. Insert the cleaning disc into the filter basket then insert the portafilter into the group head. Press the 2 CUP button and allow pressure to build for 20secs, then press to stop & release pressure. Repeat this 5 times to purge any fine coffee grounds and residual coffee oils from the brew water paths.

CLEANING THE SHOWER SCREEN

- The group head interior and shower screen should be wiped with a damp cloth to remove any ground coffee particles.
- Periodically, run hot water through the group head with the filter basket and portafilter in place, but without ground coffee. This will remove any residual ground coffee particles from the shower screen.

CLEANING THE DRIP TRAY & STORAGE TRAY

- The drip tray should be removed, emptied and cleaned after each use or when the drip tray indicator is showing Empty Me!
- Remove grill from the drip tray. Wash the drip tray in warm soapy water. The Empty Me! indicator can also be removed from the drip tray.
- The storage tray can be removed and cleaned with a soft, damp cloth (do not use abrasive cleansers, pads or cloths which can scratch the surface).

CLEANING THE OUTER HOUSING & CUP WARMING TRAY

- The outer housing and cup warming tray can be cleaned with a soft, damp cloth. Polish with a soft, dry cloth. Do not use abrasive cleansers, pads or cloths which can scratch the surface.

NOTE

Do not clean any of the parts or accessories in the dishwasher.

DESCALE (dESc)

Use this function to access the step by step descale procedure on the grind LCD.

CAUTION

Never open **DESCALE ACCESS** valves while machine is still hot. Always turn off the machine and allow to cool for at least 1 hour prior to starting descale process.

CAUTION

During descale process, water may flow through group head and the drip tray will fill with water.

Step 1 – Prepare for Descale

- Ensure drip tray is empty and fully inserted into position.
- Ensure the machine is off and has cooled for at least 1 hour. With the machine off, press and hold the 1 CUP button, then press and hold the POWER button together for 3 seconds to access Advanced Features.
- Rotate SELECT dial to 'dESc' then press SELECT dial.

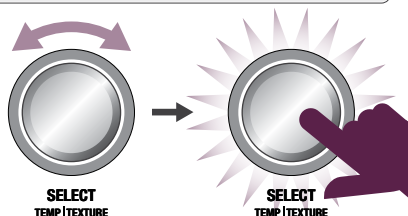

Step 2 – Empty Boilers

During Step 2 procedure, the grind LCD will display '02' and the main LCD will display 'PUSH'.

- Remove the grey silicone cover on the lower front panel marked **DESCALE ACCESS**. Place a cloth over the drip tray to stop steam escaping.

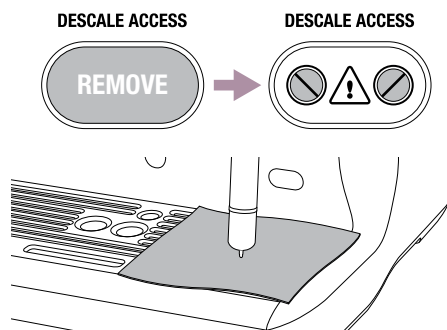

- Use a flat-head screwdriver to rotate the right screw counter-clockwise until the valve is fully open. As the valve opens, steam may be released.

CAUTION HOT WATER & STEAM

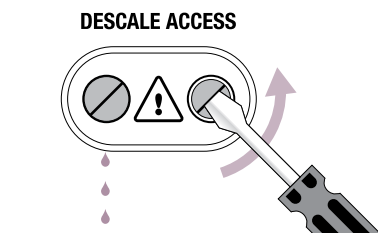

- Next, repeat the above process on the left screw. As the valve is opened, water may begin flowing into the drip tray.
- Allow valves to remain open until no more water or steam escapes.

- Close both valves by rotating screws clock-wise until seated. Do not overtighten screws to avoid damaging the valves.

DESCALE ACCESS

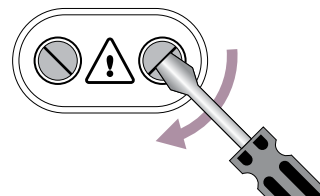

- Empty drip tray and reinsert into position. Use caution as the drip tray may be hot due to the water and steam from the boilers.
- Empty water tank, remove water filter.
- Empty descale solution into water tank, then top with cold water to MAX line, or as per manufacturer's instructions. Replace and lock water tank back into position at the back of the machine.

NOTE

If water tank has not been removed then replaced or is empty, water tank LED will flash 5 times, the machine will beep 3 times and 'FILL TANK' will be displayed on the LCD.

- Press SELECT dial to proceed to the next step.

NOTE

If boilers are not empty, the machine will beep 3 times, the downlights will flash 5 times and 'VALV' will be displayed on the LCD.

Step 3 – Begin Descale

During Step 3 procedure, the grind LCD will display '03'.

- 20 minute timer will begin. Machine will fill boilers with descale solution and heat to temperature. During this time, water may flow through the group head. Wait for countdown timer to reach 0:00. This allows solution to dissolve scale build-up.



Step 4 – Empty Descale Solution

During Step 4 procedure, the grind LCD will display '04' and the main LCD will display 'PUSH'.

- Empty water tank then rinse and fill with clean water to the MAX line. Replace and lock water tank back into position at the back of the machine.
- Place a cloth over the drip tray to stop steam escaping.
- Use a flat-head screwdriver to rotate the right screw counter-clockwise until the valve is fully open. As the valve opens, steam may be released.

CAUTION HOT WATER & STEAM

- Next, repeat the above process on the left screw. As the valve is opened, water may begin flowing into the drip tray.
- Allow valves to remain open until no more water or steam escapes.
- Close both valves by rotating screws clock-wise until seated. Do not overtighten screws to avoid damaging the valves.

- g) Empty drip tray and reinsert into position. Use caution as the drip tray may be hot due to the water and steam from the boilers.
- h) Press SELECT dial to proceed to next step.

Step 5 – Fill Boilers

During Step 5 procedure, the grind LCD will display '05'.

- a) 5 minute timer will begin. During this time, water may flow through the group head. Wait for countdown timer to reach 0:00. This allows any remaining solution to be removed from system.

5

Step 6 – Flush Boilers

During Step 6 procedure, the grind LCD will display '06' and the main LCD will display 'PUSH'.

- a) Empty and rinse water tank. Assemble new water filter into tank.
- b) Fill water tank with cold water to MAX line. Replace and lock water tank back into position at the back of the machine.
- c) Ensure drip tray is empty and fully inserted into position.
- d) Place a cloth over the drip tray to stop steam escaping.

- e) Use a flat-head screwdriver to rotate the right screw counter-clockwise until the valve is fully open. As the valve opens, steam may be released.



CAUTION **HOT WATER & STEAM**

- f) Next, repeat the above process on the left screw. As the valve is opened, water may begin flowing into the drip tray.
- g) Allow valves to remain open until no more water or steam escapes.
- h) Close both valves by rotating screws clock-wise until seated. Do not overtighten screws to avoid damaging the valves. Replace the grey silicone cover over the valves.
- i) Empty drip tray and reinsert into position. Use caution as the drip tray may be hot due to the water and steam from the boilers.
- j) Press SELECT dial to complete descale procedure. Machine will heat up and is ready to use once operating temperature (STANDBY mode) is reached.

TROUBLESHOOTING

TROUBLESHOOTING

PROBLEM	POSSIBLE CAUSE	WHAT TO DO
Motor starts but no ground coffee coming from grind outlet	<ul style="list-style-type: none"> No coffee beans in bean hopper. Grinder/bean hopper is blocked. Coffee bean may have become stuck in hopper. 	<ul style="list-style-type: none"> Fill bean hopper with fresh coffee beans. Remove bean hopper. Inspect bean hopper & grinding burrs for blockage. Replace parts and try again.
Motor starts but operates with a loud 'racket' noise	<ul style="list-style-type: none"> Grinder is blocked with foreign item or chute is blocked. Moisture clogging grinder. 	<ul style="list-style-type: none"> Remove bean hopper, inspect burrs & remove any foreign body. Clean the burrs and grind outlet, see page 35. Leave burrs to dry thoroughly before re-assembling. It is possible to use a hair dryer to blow air into the burr area to quicken the drying process.
Unable to lock bean hopper into position	<ul style="list-style-type: none"> Coffee beans obstructing bean hopper locking device. 	<ul style="list-style-type: none"> Remove bean hopper. Clear coffee beans from top of burrs. Re-lock bean hopper into position.
Portafilter overfills	<ul style="list-style-type: none"> Tamping fan was removed for cleaning and not replaced. 	<ul style="list-style-type: none"> Check that the tamping fan is in position and mounted correctly to the drive shaft, see page 35.
Emergency stop?		<ul style="list-style-type: none"> Rotate the portafilter to the left to stop the auto grind, dose & tamp function. Unplug power cord from power outlet.
There is an alert on the LCD eg. 'OVERHEAT PLEASE WAIT', 'HEATING' etc.		<p>See page 25 & 26 for list of alerts.</p> <p>If problem persists, contact Breville Customer Service Centre.</p>

TROUBLESHOOTING

PROBLEM	POSSIBLE CAUSE	WHAT TO DO
Grinder running continuously	<ul style="list-style-type: none"> No beans in hopper. 	<ul style="list-style-type: none"> Fill hopper with beans. Rotate the portafilter to the left to stop the auto grind, dose & tamp function.
	<ul style="list-style-type: none"> Tamping fan has been removed. 	<ul style="list-style-type: none"> Check that the tamping fan is in position and mounted correctly to the drive shaft, see page 35.
Espresso runs out around the edge of the portafilter and/or Portafilter comes out of the group head during an extraction	<ul style="list-style-type: none"> Portafilter not inserted in the group head correctly. 	Ensure portafilter is rotated to the right until the handle is past the centre and is securely locked in place. Rotating past the centre will not damage the silicone seal.
	<ul style="list-style-type: none"> There are coffee grounds around the filter basket rim. 	Clean excess coffee from the rim of the filter basket after grinding to ensure a proper seal in group head.
	<ul style="list-style-type: none"> Filter basket rim is wet or underside of portafilter lugs are wet. Wet surfaces reduce the friction required to hold the portafilter in place whilst under pressure during an extraction. 	Always ensure filter basket and portafilter are dried thoroughly before filling with coffee, tamping and inserting into the group head.
Issues with the Auto Start feature	<ul style="list-style-type: none"> Clock not set or clock is set with incorrect time. 	Check that the clock and Auto Start time have been programmed correctly. The LCD will display a clock icon when the Auto Start time is programmed.
ERR error message on LCD	<ul style="list-style-type: none"> A major fault has occurred and machine cannot operate. 	Contact Breville Customer Service Centre.

TROUBLESHOOTING

PROBLEM	POSSIBLE CAUSE	WHAT TO DO
Pumps continue to operate / Steam is very wet / Hot water outlet leaks	<ul style="list-style-type: none"> Using highly filtered, demineralized or distilled water which is affecting how the machine is designed to function. 	We recommend using cold, filtered water. We do not recommend using water with no/low mineral content such as highly filtered, demineralized or distilled water. If the problem persists, contact Breville Customer Service Centre.
Water does not flow from the group head	<ul style="list-style-type: none"> Machine has not reached operating temperature. 	Allow time for the machine to reach operating temperature. The POWER button will stop flashing when machine is ready.
	<ul style="list-style-type: none"> Water tank is empty. 	Fill tank. Prime the system by: <ol style="list-style-type: none"> Pressing 2 CUP button to run water through the group head for 30 seconds. Pressing HOT WATER button to run water through the hot water outlet for 30 seconds.
	<ul style="list-style-type: none"> Water tank not fully inserted & locked. 	Push water tank in fully and lock latch closed.
FILL TANK on LCD but water tank is full	<ul style="list-style-type: none"> Water tank not fully inserted & locked. 	Push water tank in fully and lock latch closed.
No steam or hot water	<ul style="list-style-type: none"> Machine is not turned on or up to operating temperature. 	Ensure the machine is plugged in and the POWER button is illuminated but not flashing.
No hot water	<ul style="list-style-type: none"> Water tank is empty. 	Fill water tank.
No steam	<ul style="list-style-type: none"> Steam wand is blocked. 	Refer to 'Cleaning the Steam Wand', page 36.

TROUBLESHOOTING

PROBLEM	POSSIBLE CAUSES	WHAT TO DO
The machine is 'On' but ceases to operate		Turn machine off. Wait for 60 minutes and turn machine back on. If problem persists, call Breville Customer Service Centre.
Steam pouring out of group head		Turn machine off. Wait for 60 minutes and turn machine back on. If problem persists, call Breville Customer Service Centre.
Espresso only drips from the portafilter spouts, restricted flow	<ul style="list-style-type: none"> Coffee is ground too finely. 	Adjust the grind size to a higher number to make the grind size slightly coarser.
Espresso flows out too quickly	<ul style="list-style-type: none"> The coffee is ground too coarsely. Coffee beans are stale. 	<ul style="list-style-type: none"> Adjust the grind size to a lower number to make the grind size slightly finer. Use freshly roasted coffee beans with a 'Roasted On' date and consume between 5-20 days after that date.
Coffee not hot enough	Cups not pre-heated.	Rinse cups under hot water outlet and place on cup warming tray.
	Milk not hot enough (if making a cappuccino or latté etc).	Increase the milk temperature. Refer to 'Adjusting Milk Temperature', page 16.
No crema	<ul style="list-style-type: none"> Coffee beans are stale. 	Use freshly roasted coffee beans with a 'Roasted On' date and consume between 5-20 days after that date.

TROUBLESHOOTING

PROBLEM	POSSIBLE CAUSES	WHAT TO DO
Not enough milk texture	<ul style="list-style-type: none"> Steam wand is blocked. 	Refer to 'Cleaning the Steam Wand', page 36.
		Different brands and types of milk and milk alternatives will texture differently. You may need to adjust the texture level accordingly. Refer to 'Adjusting Milk Texture', page 16.
Too much coffee extracted	<ul style="list-style-type: none"> Coffee is ground too coarsely. Shot duration/ volume needs to be reprogrammed. 	<ul style="list-style-type: none"> Adjust the grind size to a lower number to make the grind size slightly finer. Reprogram the shot duration/volume. Refer to 'Programming Shot Volume/Duration', page 19.
Not enough coffee extracted	<ul style="list-style-type: none"> Coffee is ground too finely. Shot duration/ volume needs to be reprogrammed. 	<ul style="list-style-type: none"> Adjust the grind size to a higher number to make the grind size slightly coarser. Reprogram the shot duration/volume. Refer to 'Programming Shot Volume/Duration', page 19.
Amount of coffee extracted has changed, but all settings are the same.	<ul style="list-style-type: none"> As coffee beans age, the extraction rate changes and can affect the shot volume. 	<ul style="list-style-type: none"> Adjust the grind size to a lower number to make the grind size slightly finer. Reprogram the shot duration/volume. Refer to 'Programming Shot Volume/Duration', page 19. Use freshly roasted coffee beans with a 'Roasted On' date and consume between 5-20 days after that date.

COFFEES TO TRY

COFFEES TO TRY



CAPPUCCINO

A single shot of espresso with textured milk and garnished with drinking chocolate.



ESPRESSO

Intense and aromatic, it is also known as a short black and is served in a small cup or glass.



LATTÉ

A latté consists of a single espresso with textured milk and approx. 10mm of foam.



MACCHIATO

Traditionally served short, the macchiato is also poured as a long black with a dash of milk or a dollop of textured milk.



LONG BLACK

A shot of espresso (single or double) with hot water. Also known as an Americano.



RISTRETTO

A ristretto is an extremely short espresso of approximately 15ml, distinguished by its intense flavour and aftertaste.

Free Manuals Download Website

<http://myh66.com>

<http://usermanuals.us>

<http://www.somanuals.com>

<http://www.4manuals.cc>

<http://www.manual-lib.com>

<http://www.404manual.com>

<http://www.luxmanual.com>

<http://aubethermostatmanual.com>

Golf course search by state

<http://golfingnear.com>

Email search by domain

<http://emailbydomain.com>

Auto manuals search

<http://auto.somanuals.com>

TV manuals search

<http://tv.somanuals.com>