

Models:

Dakota 42-B

Dakota 42H-B

GAS-FIRED



CAUTION



DO NOT DISCARD THIS MANUAL

Important operating and maintenance instructions included. • Read, understand and follow these instructions for safe installation and operation. • Leave this manual with party responsible for use and operation.



⚠ WARNING



If the information in these instructions is not followed exactly, a fire may result causing property damage, personal injury, or death.

- Do not store or use gasoline or other flammable vapors and liquids in the vicinity of this or any other appliance.
- **What to do if you smell gas:**
 - Do not try to light any appliance.
 - Do not touch any electrical switch. Do not use any phone in your building.
 - Immediately call your gas supplier from a neighbor's phone. Follow the gas supplier's instructions.
 - If you cannot reach your gas supplier, call the fire department.
- Installation and service must be performed by a qualified installer, service agency, or the gas supplier.

⚠ WARNING



HOT! DO NOT TOUCH. SEVERE BURNS MAY RESULT. CLOTHING IGNITION MAY RESULT.

Glass and other surfaces are hot during operation and cool down.

- Keep children away.
- CAREFULLY SUPERVISE children in same room as appliance.
- Alert children and adults to hazards of high temperatures.
- Keep clothing, furniture, draperies and other combustibles away.

This appliance must be installed outside.

Note: An arrow (➔) found in the text signifies change in content.



Installation and service of this appliance should be performed by qualified personnel. Hearth & Home Technologies suggests NFI certified or factory-trained professionals, or technicians supervised by an NFI certified professional.



**Read this manual before installing or operating this appliance.
Please retain this owner's manual for future reference.**

Congratulations

Congratulations on selecting a Heat & Glo LifeStyle Collection gas appliance—an elegant and clean alternative to wood burning appliances. The Heat & Glo LifeStyle Collection gas appliance you have selected is designed to provide the utmost in safety, reliability, and efficiency.

As the owner of a new appliance, you'll want to read and carefully follow all of the instructions contained in this owner's manual. Pay special attention to all cautions and warnings.

This owner's manual should be retained for future reference. We suggest you keep it with your other important documents and product manuals.

The information contained in this owner's manual, unless noted otherwise, applies to all models and gas control systems.

Your new Heat & Glo LifeStyle Collection gas appliance will give you years of durable use and trouble-free enjoyment. Welcome to the Heat & Glo LifeStyle Collection family of appliance products!

<p>Homeowner Reference Information</p> <p>Model Name: _____ Date purchased/installed: _____</p> <p>Serial Number: _____ Location on appliance: _____</p> <p>Dealership purchased from: _____ Dealer phone: _____</p> <p>Notes: _____</p> <p>_____</p> <p>_____</p>	<p><i>We recommend that you record the following pertinent information about your appliance:</i></p>
---	--

Listing Label Information/Location

The model information regarding your specific appliance can be found on the rating plate usually located in the control area of the appliance.

The diagram shows a rating plate for a Heat & Glo vented gas fireplace. Arrows point from labels to specific parts of the plate:

- Type of Gas:** Points to the 'Natural Gas' and 'Propane Gas' columns in the input adjustment table.
- Serial Number:** Points to the 'Serial (Serie):' field.
- Gas and Electric Information:** Points to the 'ANSI Z21.50-2003 - CSA 2.22-M2003' and the input adjustment table.
- Model Number:** Points to the 'Model (Modele):' field.

Rating Plate Content:

HEAT & GLO
LifeStyle Collection

Heat & Glo Lifestyle Products
Hearth & Home Technologies Inc.
20802 Kensington Blvd., Lakeville, MN 55044

Vented gas fireplace - for outdoor installation only. Not for use with solid fuel. (Foyer au gaz à évacuation - pour installation à l'extérieur seulement. Ne doit pas être utilisé avec un combustible solide.)

This product is covered by one or more of the following patents: (Nos produits sont couverts par un ou plusieurs des brevets suivants: (United States) 4,112,913; 4,408,594; 4,422,426; 4,424,792; 4,520,791; 4,793,322; 4,852,548; 4,875,464; 5,000,162; 5,016,609; 5,076,254; 5,191,877; 5,218,993; 5,328,356; 5,429,495; 5,452,708; 5,542,407; 5,613,487; (Australia) 543790; 586383; (Canada) 1,123,296; 1,227,746; 2,195,264; (Mexico) 97-0457; (New Zealand) 200285; or other U.S. and foreign patents pending (ou autres brevets américains et étrangers en attente).

This appliance must be installed in accordance with local codes, if any; if not, follow ANSI Z223.1 in the USA installation codes.

ANSI Z21.50-2003 - CSA 2.22-M2003

Minimum Permissible Gas Supply for Purposes of Input Adjustment.	Natural Gas	Propane Gas
Approved Minimum (De Gaz) Acceptable	7.0 in. w.c. (Po. Col. d'eau)	11.0 in. w.c. (Po. Col. d'eau)
Maximum Pressure (Pression)	10.0 in. w.c. (Po. Col. d'eau)	14.0 in. w.c. (Po. Col. d'eau)
Maximum Input BTUH:	60,000	53,000
Orifice Size:	#25DMS	#44DMS

Serial (Serie): _____
OD Mfg. Date: _____

Model (Modele):
 DAKOTA42-B
 DAKOTA42L-B

MADE IN USA

UL US LISTED **GAS-FIRED VENTED GAS FIREPLACE 8R54**

4036-994A

Table of Contents

1 Listing and Code Approvals		9 Appliance Setup	
A. Appliance Certification	4	A. Clean the Appliance	16
B. Glass Specifications	4	B. Grate Assembly Placement	16
C. BTU Specifications	4	C. Positioning the Logs	16
D. High Altitude Installations	4	D. Glass Assembly	18
2 Getting Started		E. Placing Lava Rock	18
A. Design and Installation Considerations	5	10 Operating Instructions	
B. Tools and Supplies Needed	5	A. Before Lighting Appliance	19
C. Inspect Appliance and Components	5	B. Lighting the Appliance	20
3 Framing and Clearances		C. After the Appliance is Lit	21
A. Select Appliance Location	6	D. Frequently Asked Questions	21
B. Clearances	7	11 Troubleshooting	
C. Mantel Projections	7	A. Intellifire Ignition System	22
4 Termination Locations		12 Maintaining and Servicing the Appliance	
A. Vent Termination Minimum Clearances	8	A. Valve Service and Replacement	24
5 Appliance Preparation		B. Battery Replacement	25
A. Remove Logs and Shipping Cover	9	B. Maintenance and Service Tasks:	26
B. Securing and Leveling Appliance	9	13 Reference Materials	
6 Gas Information		A. Appliance Dimension Diagram	27
A. Fuel Conversion	10	B. Service Parts List	28
B. Gas Pressure	10	C. Warranty	35
C. Gas Connection	10	D. Contact Information	36
D. High Altitude Installations	11		
E. Valve Access	12		
7 Electrical Information			
A. Recommendation for Wire	13		
B. Connecting to the Appliance	13		
C. Intellifire Ignition System Wiring	13		
8 Finishing			
A. Mantel Projections	14		
B. Facing Material	15		

1 Listing and Code Approvals

A. Appliance Certification

MODELS: Dakota 42-B, Dakota 42H-B
LABORATORY: Underwriters Laboratories, Inc. (UL)
TYPE: Vented Gas Appliance
STANDARD: **ANSI Z21.50-2003—CSA2.22-M2003**

This product is listed to ANSI standards for “Vented Gas Fireplaces” and applicable sections of “Gas Burning Heating Appliances for Manufactured Homes and Recreational Vehicles”, and “Gas Fired Appliances for Use at High Altitudes”.

B. Glass Specifications

Hearth & Home Technologies appliances manufactured with tempered glass may be installed in hazardous locations such as bathtub enclosures as defined by the Consumer Product Safety Commission (CPSC). The tempered glass has been tested and certified to the requirements of ANSI Z97.1 and CPSC 16 CFR 1202 (Safety Glazing Certification Council SGCC# 1595 and 1597. Architectural Testing, Inc. Reports 02-31919.01 and 02-31917.01).

This statement is in compliance with CPSC 16 CFR Section 1201.5 “Certification and labeling requirements” which refers to 15 U.S. Code (USC) 2063 stating “...Such certificate shall accompany the product or shall otherwise be furnished to any distributor or retailer to whom the product is delivered.”

Some local building codes require the use of tempered glass with permanent marking in such locations. Glass meeting this requirement is available from the factory. Please contact your dealer or distributor to order.

Note: This installation must conform with local codes. In the absence of local codes you must comply with the **National Fuel Gas Code, ANSI Z223.1-latest edition** in the U.S.A. and the **CAN/CGA B149 Installation Codes** in Canada.

C. BTU Specifications

Models	Maximum Input BTUH	Orifice Size (DMS)
Dakota 42-B (NG)	60,000	25
Dakota 42-B (LP)	53,000	44

D. High Altitude Installations

U.L. Listed gas appliances are tested and approved without requiring changes for elevations from 0 to 2000 feet in the U.S.A. and Canada.

When installing this appliance at an elevation above 2000 ft, it may be necessary to decrease the input rating by changing the existing burner orifice to a smaller size. Input rate should be reduced by 4% for each 1000 ft above a 2000 ft elevation in the U.S.A., or 10% for elevations between 2000 and 4500 ft in Canada. If the heating value of the gas has been reduced, these rules do not apply. To identify the proper orifice size, check with the local gas utility.

If installing this appliance at an elevation above 4500 ft (in Canada), check with local authorities.

WARNING

Do NOT use this appliance if any part has been under water. Immediately call a qualified service technician to inspect the appliance and to replace any part of the control system and any gas control which has been under water.

2 Getting Started

A. Design and Installation Considerations

Note: This appliance must be installed outside.

CAUTION

Check building codes prior to installation.

- Installation **MUST** comply with local, regional, state and national codes and regulations.
- Consult insurance carrier, local building, fire officials or authorities having jurisdiction about restrictions, installation inspection, and permits.

When planning an appliance installation, it's necessary to determine the following information before installing:

- Where the appliance is to be installed.
- Gas supply piping.
- Electrical wiring.
- Framing and finishing details.

➔ Moisture Resistance:

This outdoor fireplace will shed moderate amounts of water, but is not waterproof. Water and condensing water vapor may enter the chase under certain conditions.

The fireplace will not perform as an exterior wall. Moisture penetration must be considered for construction that places the fireplace in structure walls or on moisture sensitive surfaces.

When installed on exterior walls: Hearth & Home Technologies recommends that the fireplace chase be constructed outside the structure's weather envelope. Where the platform meets the wall, use a flashing detail similar to that required for attached decks. Chase platforms, including hearths should slope away from the structure at 1/8 in. to 1/4 in. per foot. The fireplace can be shimmed level.

When installed on surfaces where water may collect or cause damage: Hearth & Home Technologies recommends that a drainage pan be placed under the unit. This can be constructed of metal, adhesive polymer membrane (such as ice and water shield) or other suitable materials. A means of drainage out of the pan such as tubes or weep holes should be provided. A slope of 1/8 in. to 1/4 in. per foot towards the drain port is suggested. The fireplace can be shimmed level.

Hearths should slope away from the front of the fireplace and chase at 1/8 in. to 1/4 in. per foot. Spark strips must be on top of any combustible hearth materials used for moisture management.

B. Tools and Supplies Needed

Before beginning the installation be sure that the following tools and building supplies are available.

Reciprocating saw	Framing material
Pliers	Hi temp caulking material
Hammer	Gloves
Phillips screwdriver	Framing square
Flat blade screwdriver	Electric drill and bits (1/4 in.)
Plumb line	Safety glasses
Manometer	Voltmeter
Tape measure	Level
Non-corrosive leak check solution	
1/2 - 3/4 inch length, #6 or #8 Self-drilling screws	

C. Inspect Appliance and Components



⚠ WARNING

Inspect appliance and components for damage. Damaged parts may impair safe operation.



- Do NOT install damaged components.
- Do NOT install incomplete components.
- Do NOT install substitute components.

Report damaged parts to dealer.

- Carefully remove the appliance and components from the packaging.
- The gas logs may be packaged separately and must be field installed.
- Report to your dealer any parts damaged in shipment, particularly the condition of the glass.
- **Read all of the instructions before starting the installation. Follow these instructions carefully during the installation to ensure maximum safety and benefit.**



⚠ WARNING

Hearth & Home Technologies disclaims any responsibility for, and the warranty will be voided by, the following actions:

- Installation and use of any damaged appliance or vent system component.
- Modification of the appliance or vent system.
- Installation other than as instructed by Hearth & Home Technologies.
- Improper positioning of the gas logs or the glass door.
- Installation and/or use of any component part not approved by Hearth & Home Technologies.

Any such action may cause a fire hazard.

3 Framing and Clearances

Note:

- Illustrations reflect typical installations and are FOR DESIGN PURPOSES ONLY.
- Illustrations/diagrams are not drawn to scale.
- Actual installation may vary due to individual design preference.

A. Select Appliance Location

When selecting a location for your appliance it is important to consider the required clearances to walls (See Figure 3.1).

WARNING

Fire Risk

Provide adequate clearance:

- Around air openings.
- To combustibles.
- For service access.

Locate appliance away from traffic areas.

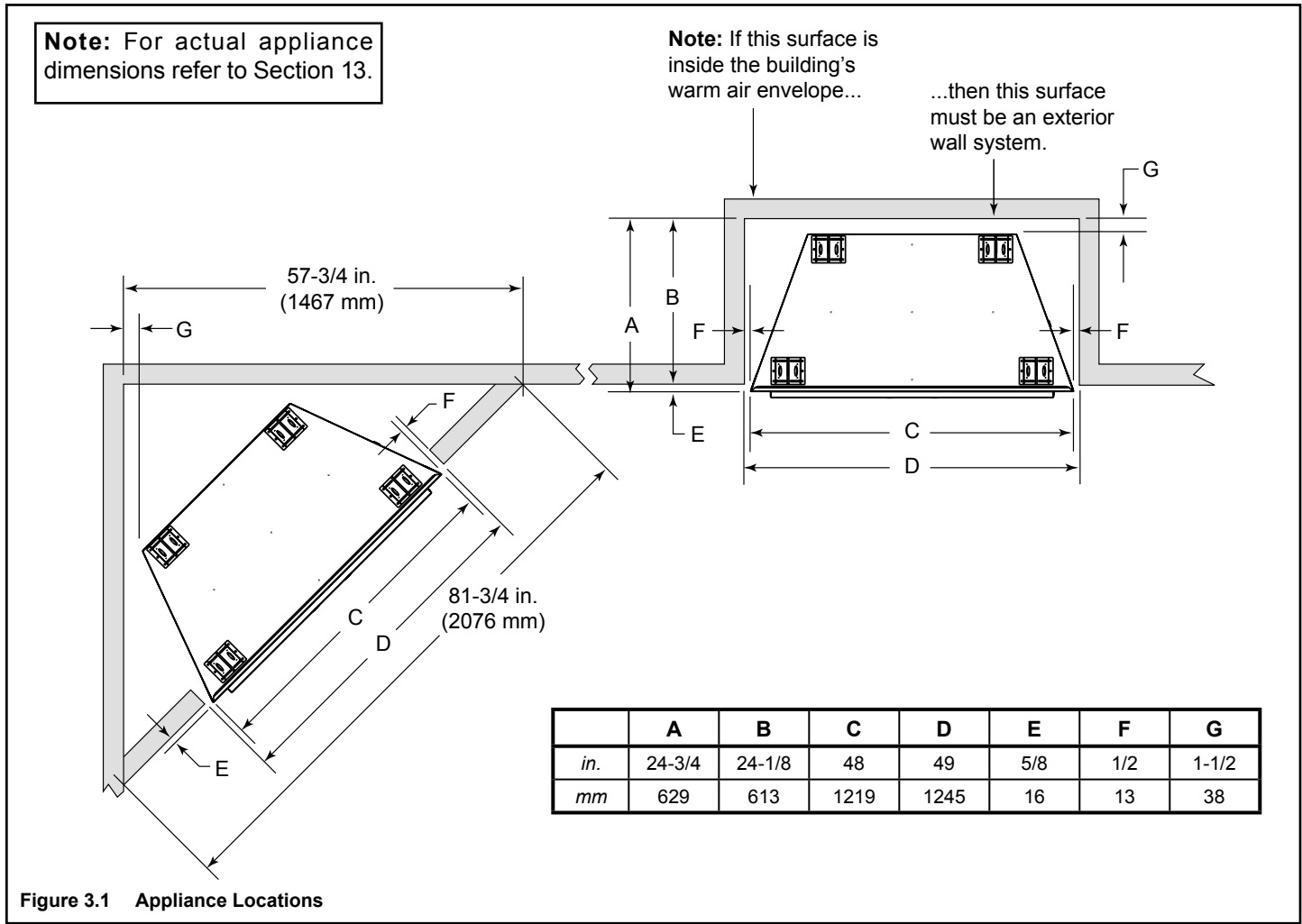

Figure 3.1 Appliance Locations

WARNING

Fire Risk
Odor Risk

- Install appliance on hard metal or wood surfaces extending full width and depth of appliance.
- Do NOT install appliance directly on carpeting, vinyl, tile or any combustible material other than wood.

WARNING

Fire Risk

- Locate and install appliance to all clearance specifications in manual.

B. Clearances

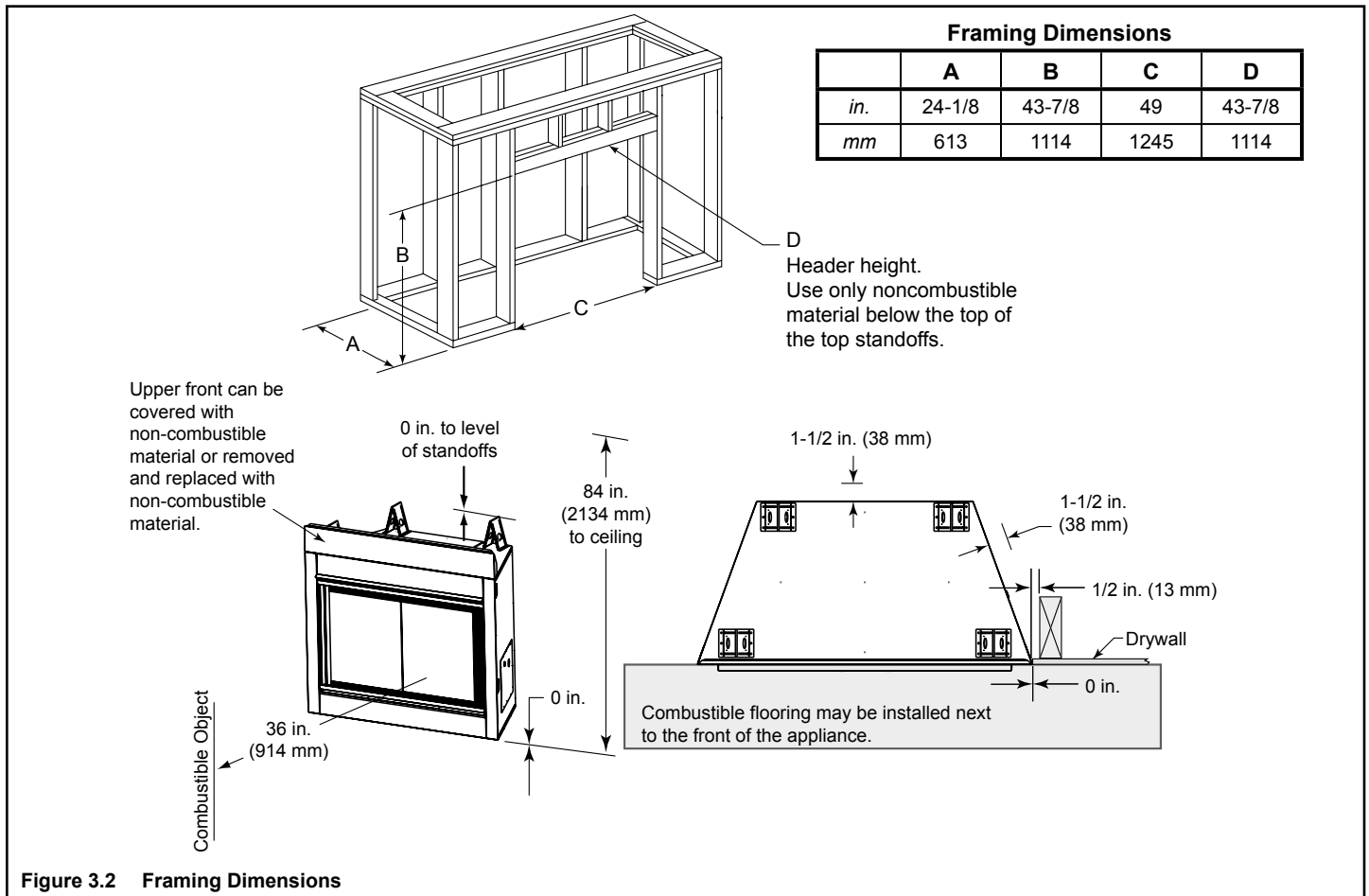

Figure 3.2 Framing Dimensions

C. Mantel Projections

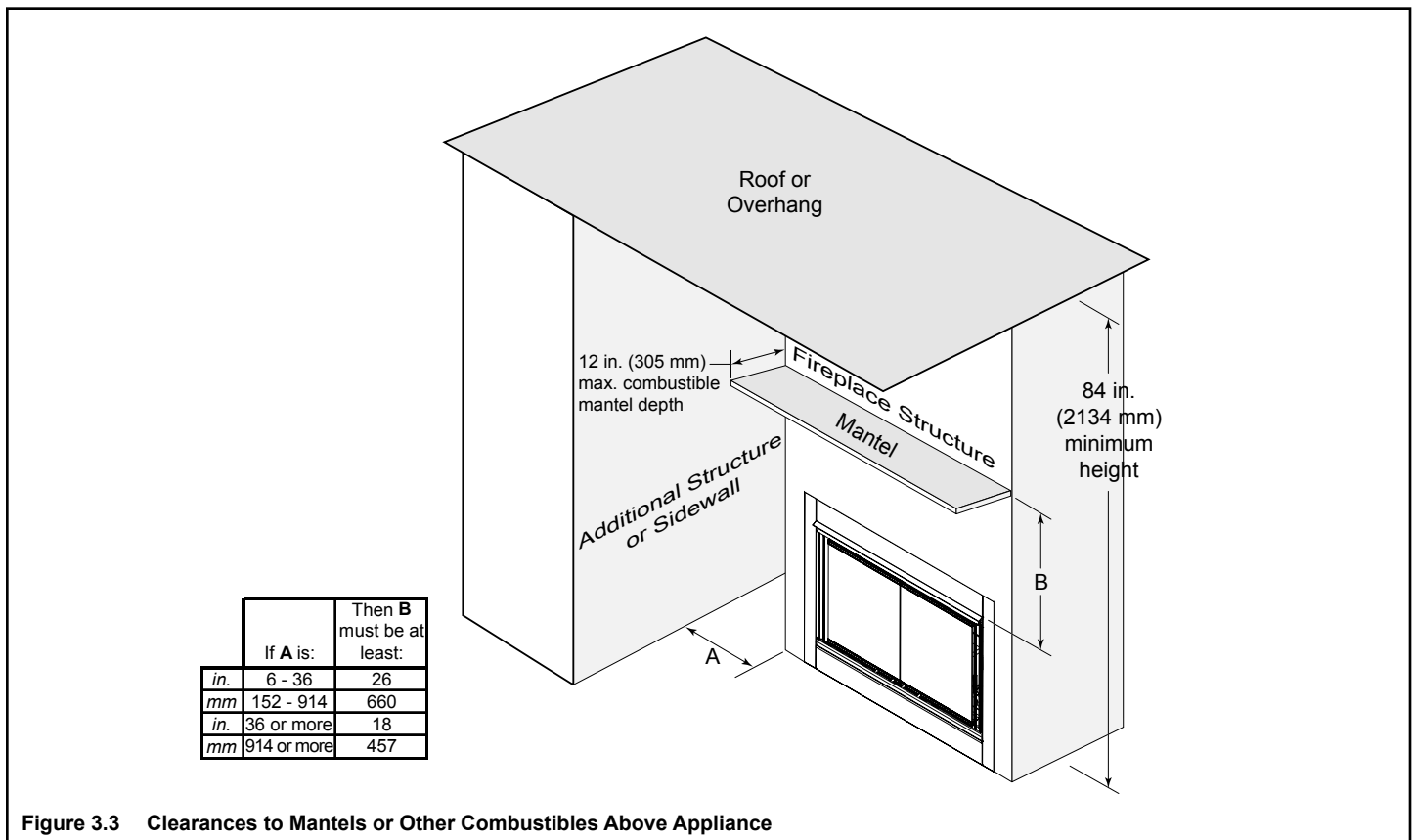
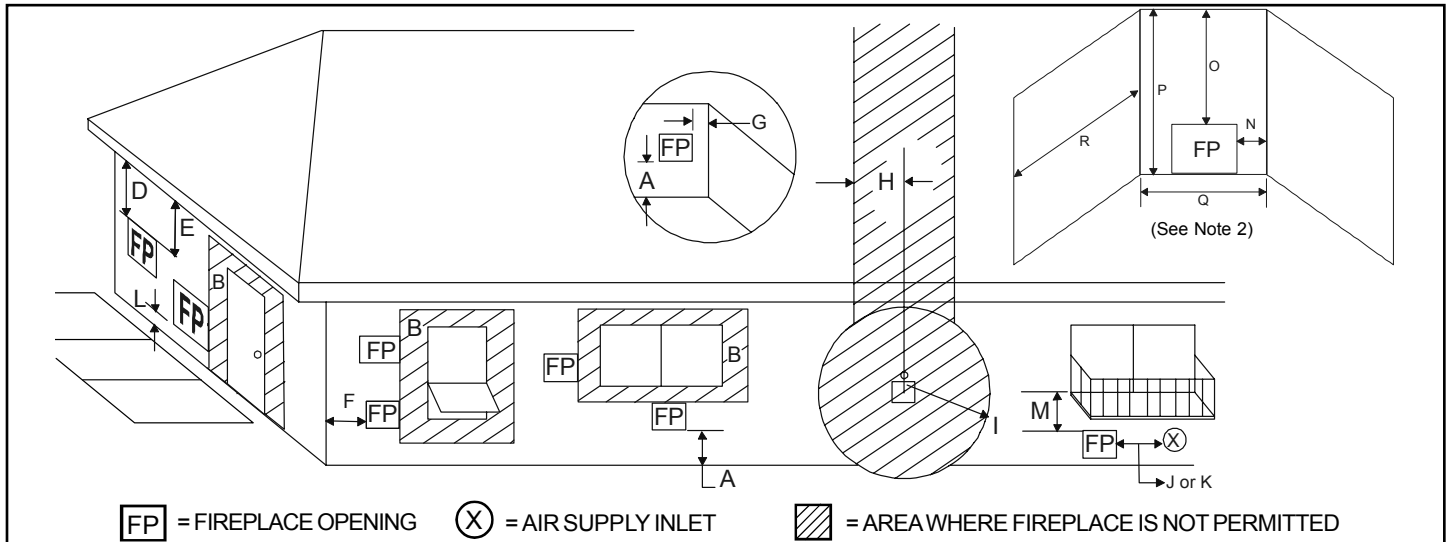

Figure 3.3 Clearances to Mantels or Other Combustibles Above Appliance

4 Termination Locations

A. Vent Termination Minimum Clearances



- | | |
|--|--|
| <p>A = 0 in. clearances above grade, veranda, porch, deck or balcony.</p> <p>B = 12 in. clearances to window or door that may be opened, or to permanently closed window.</p> <p>36 in. vinyl windows or siding.</p> <p>D** = 47 in. vertical clearance to unventilated soffit or to ventilated soffit located above the terminal.</p> <p>60 in. vinyl clad soffits.</p> <p>F = 9 in. clearance to outside corner.</p> <p>G* = 6 in. clearance to inside corner.</p> <p>48 in. vinyl windows or siding.</p> <p>H = 3 ft. (Canada) not to be installed above a gas meter/regulator assembly within 3 ft (914 mm) horizontally from the center line of the regulator.</p> <p>I = 3 ft. (USA)
6 ft. (Canada) clearance to service regulator vent outlet and electric service.</p> | <p>J = 9 in. (USA)
12 in. (Canada) clearance to non-mechanical air supply inlet to building or the combustion air inlet to any other appliance.</p> <p>K = 3 ft. (USA)
6 ft. (Canada) clearance to a mechanical air supply inlet.</p> <p>L*** = 54 in. clearance above paved sidewalk or a paved driveway located on public property.</p> <p>M****= 47 in. clearance under veranda, porch, deck, balcony or overhang.</p> <p>Not allowed: vinyl</p> <p>N = 6 in. non-vinyl siding.</p> <p>P = 84 in.</p> |
|--|--|

	Q _{MIN}	R _{MAX}
Dakota	10 feet	2 x Q _{ACTUAL}
1 additional termination cap	Q + 3 feet	1 x Q _{ACTUAL}
2 additional termination caps	Q + 6 feet	2/3 x Q _{ACTUAL}
3 additional termination caps	Q + 9 feet	1/2 x Q _{ACTUAL}
R _{MAX} = (2 / # caps plus fireplace) x Q _{ACTUAL}		

* 48 in. minimum for vinyl windows or vinyl siding.

** Not allowed for vinyl clad soffits.

*** a fireplace shall not open directly above a sidewalk or paved driveway which is located between two single family dwellings and services both dwellings.

**** only permitted if veranda, porch, deck or balcony is fully open on a minimum of 2 sides beneath the floor, or if the screened porch guidelines are followed.

Note 1: Local codes or regulations may require different clearances.

Note 2: Termination in an alcove space (spaces open only on one side and with an overhang) are permitted with the dimensions specified for vinyl or non-vinyl siding and soffits. **1)** There must be a 3 ft minimum between terminations or between the fireplace and termination. **2)** All mechanical air intakes within 10 ft of a termination must be a minimum of 3 ft below the fireplace hood. **3)** All gravity air intakes within 3 ft of the fireplace hood must be a minimum of 1 ft below the termination.

This fireplace is approved for installation onto screen porches with the following guidelines:

- Minimum porch area: 96 sq ft
- Minimum ceiling height: 92 in.
- Minimum of two walls must be screened
- Minimum top of screen height, side walls: 6 ft 8 in.
- Minimum screen area: 64 sq ft

Note 2: There may be some odor and small amounts of soot associated with burning the Dakota on a screened porch. Ensuring good cross draft ventilation and routine maintenance of the fireplace will maximize comfort and cleanliness.

Figure 4.1 Minimum Clearances

5 Appliance Preparation

CAUTION



Sharp Edges

- Wear protective gloves and safety glasses during installation.



A. Remove Logs and Shipping Cover

Open the doors by sliding the handles toward the outside edges of the doors (see Figure 5.1) Remove the cartons of logs from their shipping location in the appliance.

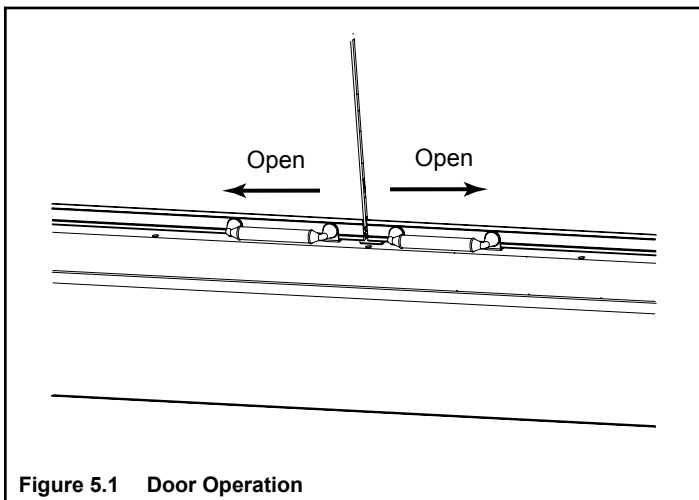

Figure 5.1 Door Operation

B. Securing and Leveling Appliance

WARNING



Fire Risk

- Prevent contact with sagging, loose insulation.
- Do NOT install against vapor barriers or exposed insulation.

The diagram shows how to properly position, level, and secure the appliance (see Figure 5.2). Nailing tabs are provided to secure the appliance to the framing members.

- Place the appliance into position on either a combustible or non-combustible continuous flat surface.
Note: Remove the top standoffs before sliding appliance into position if using an FPS prefab enclosure.
- Level the appliance from side to side and front to back.
- Shim the appliance with non-combustible material, such as sheet metal, as necessary.
- Bend out nailing tabs on each side.
- Keep nailing tabs flush with the framing.
- Secure the appliance to the framing by using nails or screws through the nailing tabs.

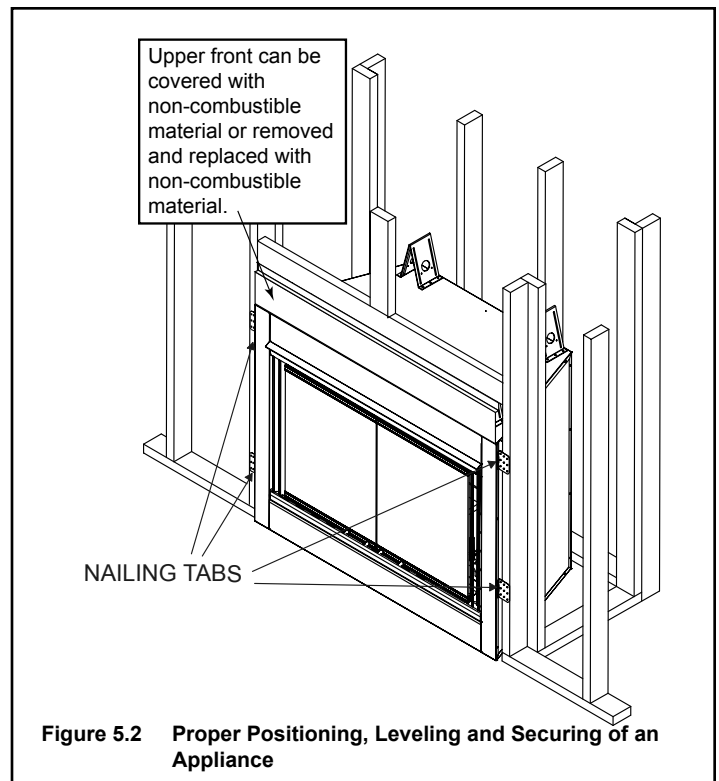

Figure 5.2 Proper Positioning, Leveling and Securing of an Appliance

CAUTION

Do NOT notch into the framing around the appliance spacers.

6 Gas Information

A. Fuel Conversion



Before making gas connections ensure appliance being installed is compatible with the available gas type.

Any natural or propane gas conversions necessary to meet the appliance and locality needs must be made by a qualified technician using Hearth & Home Technologies specified and approved parts.

B. Gas Pressure

Proper input pressures are required for optimum appliance performance. Gas line sizing requirements need to be made following **NFPA51**.

 **WARNING**





Fire Risk
Explosion Risk

High pressure will damage valve.

- Disconnect gas supply piping **BEFORE** pressure testing gas line at test pressures above 1/2 psig.
- Close the manual shutoff valve **BEFORE** pressure testing gas line at test pressures equal to or less than 1/2 psig.

 **WARNING**

Fire Risk
Explosion Risk

Verify inlet pressures.

- High pressure may cause overfire condition.
- Low pressure may cause explosion.

Install regulator upstream of valve if line pressure is greater than 1/2 psig.

Pressure requirements for appliance are shown in table below.

Pressure	Natural Gas	Propane
Minimum Inlet Pressure	5.0 inches w.c.	11.0 inches w.c.
Maximum Inlet Pressure	7.0 inches w.c.	14.0 inches w.c.
Manifold Pressure	3.5 inches w.c.	10.5 inches w.c.

These pressures can be verified through the internal valve access panels as shown in Section E. Valve Access.

C. Gas Connection

Note: Have the gas supply line installed in accordance with local building codes, if any. If not, follow **ANSI 223.1**. Installation should be done by a qualified installer approved and/or licensed as required by the locality. (In the Commonwealth of Massachusetts installation must be performed by a licensed plumber or gas fitter.)

Note: A listed (and Commonwealth of Massachusetts approved) 1/2 in. (13 mm) T-handle manual shut-off valve and flexible gas connector are connected to the 1/2 in. (13 mm) control valve inlet.

- **If substituting for these components, please consult local codes for compliance.**

Optional: A 5 ft flexible gas line is available to those regions which do not require black pipe to be used. See Service Parts List (Section 13).

Note: Gas line **MUST** be run from right side of appliance.

 **WARNING**





Gas Leak Risk

- Support control when attaching pipe to prevent bending gas line.

Note: The gap between supply piping and gas access hole may be plugged with non-combustible unfaced insulation to prevent cold air infiltration.

- Ensure that gas line does not come in contact with outer wrap of appliance. Follow local codes.
- Incoming gas line should be piped into the valve compartment and connected to the 1/2 in. connection on the manual shutoff valve.

 WARNING	
 	<p>Fire Risk Explosion Risk</p> <ul style="list-style-type: none"> • Gas build-up during line purge may ignite. • Purge should be performed by qualified technician. • Ensure adequate ventilation. • Ensure there are no ignition sources such as sparks or open flames.





- A small amount of air will be in the gas supply lines. When first lighting appliance it will take a short time for air to purge from lines. When purging is complete, the appliance will light and operate normally.



D. High Altitude Installations

U.L. listed gas appliances are tested and approved without requiring changes for elevations from 0 to 2000 ft in the USA and Canada.

When installing this appliance at an elevation above 2000 ft, it may be necessary to decrease the input rating by changing the existing burner orifice to a smaller size. Input rate should be reduced by 4% for each 1000 ft above a 2000 ft elevation in the U.S.A., or 10% for elevations between 2000 and 4500 ft in Canada. If the heating value of the gas has been reduced, these rules do not apply. To identify the proper orifice size, check with the local gas utility.

If installing this appliance at an elevation above 4500 ft (in Canada), check with local authorities.

 WARNING	
  	<p>CHECK FOR GAS LEAKS Fire Risk Explosion Risk Asphyxiation Risk</p> <ul style="list-style-type: none"> • Check all fittings and connections. • Do not use open flame. • After the gas line installation is complete, all connections must be tightened and checked for leaks with a commercially available, non-corrosive leak check solution. Be sure to rinse off all leak check solution following testing. <p>Fittings and connections may have loosened during shipping and handling.</p>

 WARNING	
 	<p>Fire Risk Explosion Risk</p> <p>Do NOT change the valve settings.</p> <ul style="list-style-type: none"> • This valve has been preset at the factory. • Changing valve settings may result in fire hazard or bodily injury.

E. Valve Access

- The gas valve can be accessed behind the cement refractory panel on the right side of the fireplace.
- Lift doors out and set aside. There is a washer under each door. Be careful not to lose those washers.

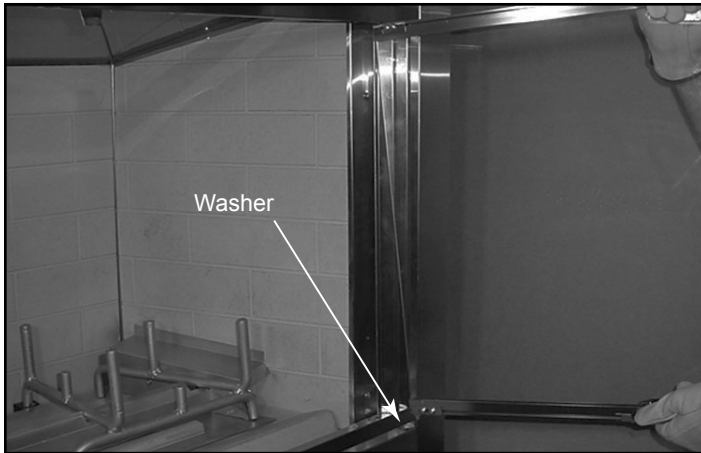

Figure 6.1 Lift Out Doors

- Remove logs if access is necessary after installation is complete. See Section 9.C. Remove logs in reverse order of set up.
- Remove grate if access is necessary after installation is complete. (Refer to Section 9.B.)
- Remove two screws on side of pilot shield and remove shield.



Figure 6.2 Remove Pilot Shield

- Use a Phillips screwdriver to remove the two screws securing the refractory retaining strip. Remove the refractory side panel and set aside.



Figure 6.3 Loosen Refractory Retaining Strip

- Remove the inside valve access panel by lifting it up and out.



Figure 6.4 Remove Valve Access Panel

- Use a Phillips screwdriver to remove the exterior valve access panel (remove four screws).

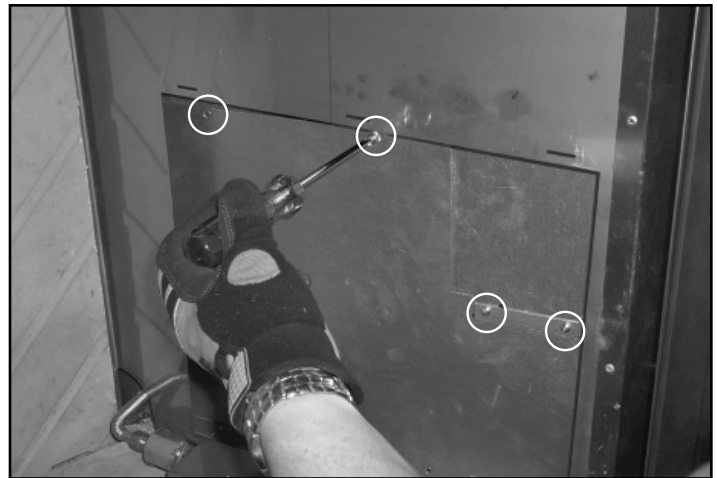

Figure 6.5 Remove Exterior Valve Access Panel

- Use a manometer on the lower out pressure tap. Start up the fireplace to verify the pressure and adjust as necessary. Reverse these steps to reassemble before log positioning.

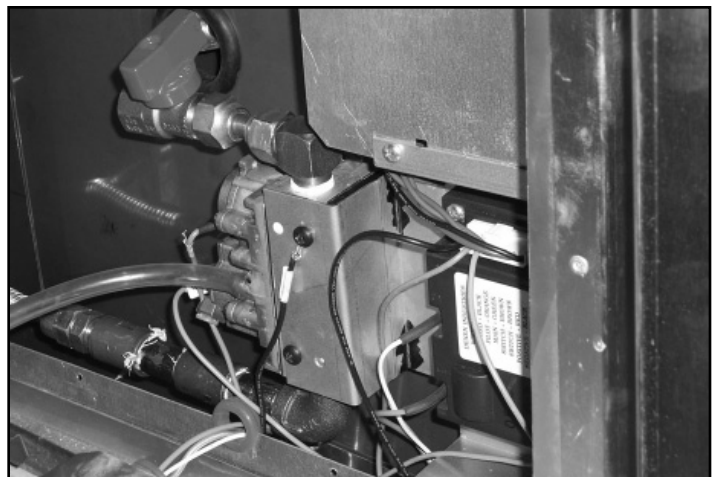

Figure 6.6 Connect Manometer

7 Electrical Information

A. Recommendation for Wire

Note: This appliance must be electrically wired and grounded in accordance with local codes or, in the absence of local codes, with **National Electric Code ANSI/NFPA 70-latest edition** or the **Canadian Electric Code, CSA C22.1**.

B. Connecting to the Appliance

⚠ WARNING

Shock Risk
Explosion Risk

Do NOT wire 110V to valve.
Do NOT wire 110V to wall switch

- Incorrect wiring will damage millivolt values.
- Incorrect wiring will override IPI safety lockout and may cause explosion.

- Keep wire lengths short as possible by removing any excess wire length, not to exceed 18 ft.
- Low voltage and 110 VAC voltage cannot be shared within the same wall box.

C. Intellifire Ignition System Wiring

- This appliance is equipped with an Intellifire control valve which operates on a 3 volt system.
- This appliance is supplied with a battery pack which is located in the ON/OFF switch terminal box. A wiring diagram is shown in Figure 7.1.
- The battery pack requires two D cell batteries (not included). See Section 12.B. for battery replacement.

CAUTION

Battery polarity must be correct or module damage will occur.

⚠ WARNING

Shock Risk

- Replace damaged wire with type 105° C rated wire.
- Wire must have high temperature insulation.

CAUTION

Label all wires prior to disconnection when servicing controls. Wiring errors can cause improper and dangerous operation. Verify proper operation after servicing.

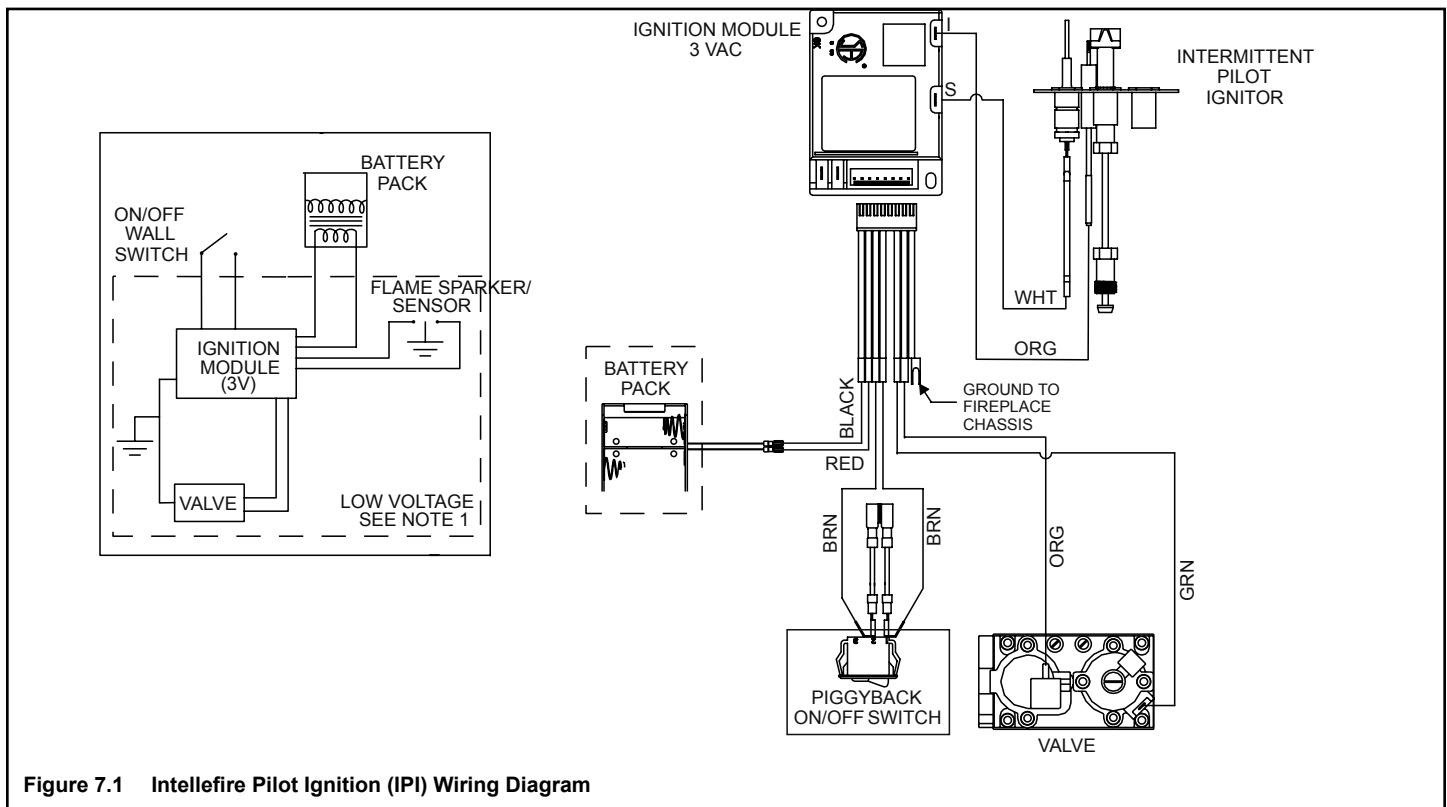

Figure 7.1 Intellifire Pilot Ignition (IPI) Wiring Diagram

8 Finishing

A. Mantel Projections

Figure 8.1 shows the minimum vertical dimension of appliance mantels or other combustible projections above the top front edge of the appliance.

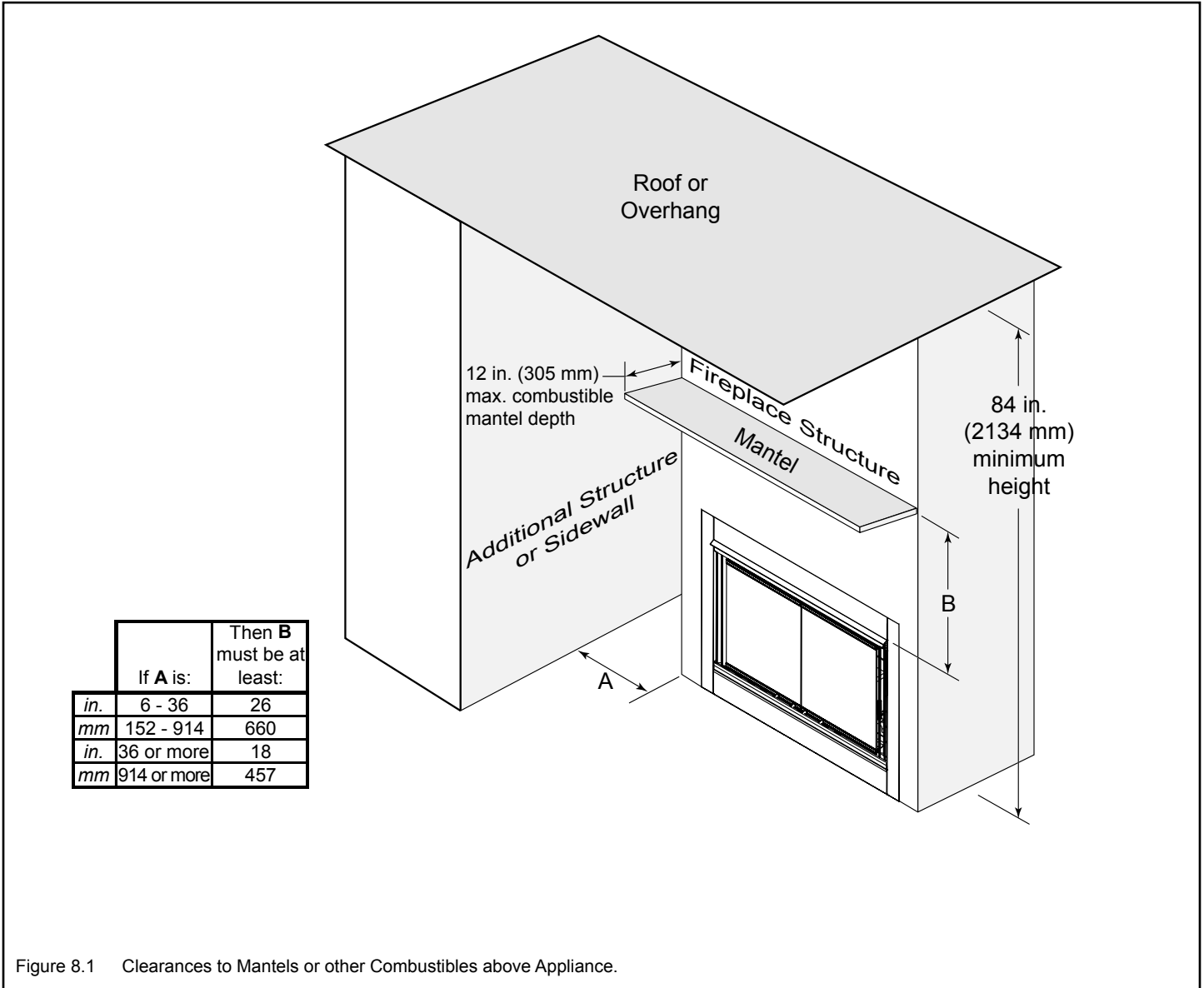



Figure 8.1 Clearances to Mantels or other Combustibles above Appliance.

B. Facing Material

 **WARNING**

 **Fire Risk**
Do NOT obstruct air inlet or outlet grilles.
Do NOT modify grilles.

- Modifying or covering grilles could cause temperature rise and fire hazard.

Finishing materials must not interfere with:

- Air flow through grilles or louvers.
- Operation of louvers or doors.
- Access for service.

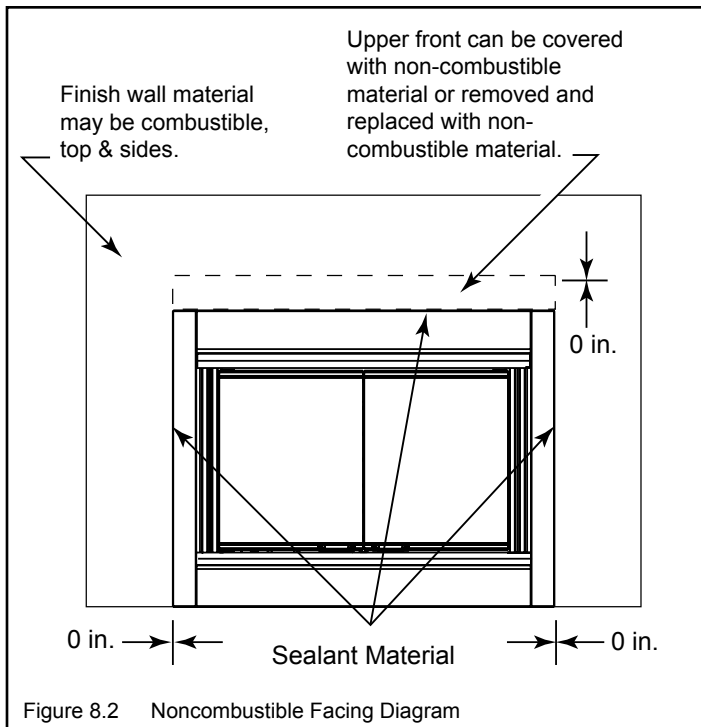

 **WARNING**

 **Fire Risk**
Finish all edges and fronts to clearances and specifications listed in manual.

- Metal appliance front may be covered with non-combustible material only.
- Do NOT overlap combustible materials onto appliance front.
- Install combustible materials up to specified clearances on top front and side edges.
- Seal joints between the finished wall and appliance top and sides using only a 300° F minimum sealant.

9 Appliance Setup

A. Clean the Appliance

Clean/vacuum any sawdust that may have accumulated inside the firebox or underneath in the control cavity.

⚠ WARNING



Shock Risk
Fire Risk

Use **ONLY** optional accessories approved for this appliance.

- Using non-listed accessories voids warranty.
- Using non-listed accessories may result in a safety hazard.
- Only Hearth & Home Technologies approved accessories may be used safely.

B. Grate Assembly Placement

- Ensure grate assembly is over burner assembly, centered from left to right, and back legs are in grate brackets (see Figure 9.1)

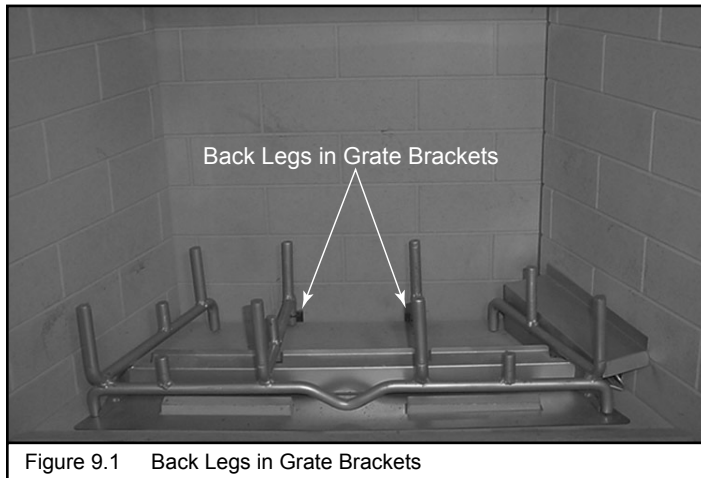

Figure 9.1 Back Legs in Grate Brackets

C. Positioning the Logs

- See Section 13.B. for log descriptions and illustrations.
- Place right rear log on the grate against the appliance right side wall.

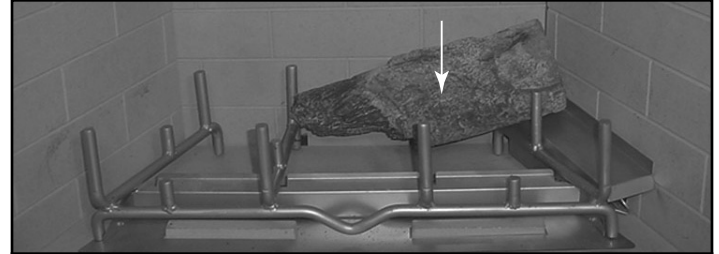

Figure 9.2 Right Rear Log (SRV720)

- Place the left rear log on the grate against the left wall and rest it on log.



Figure 9.3 Left Rear Log (SRV728)

- Place the fork of log onto the left front bar and rest its back on right rear log.



Figure 9.4 Left Side Log (SRV723)

- Place front log in front of the main grate with its left end resting on left rear log as shown.

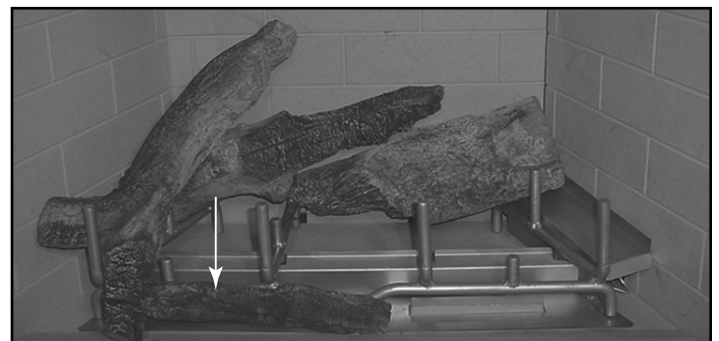

Figure 9.5 Front Log (SRV727)

- Place front left log between locating bars so it rests against log left side log and on top of front log.

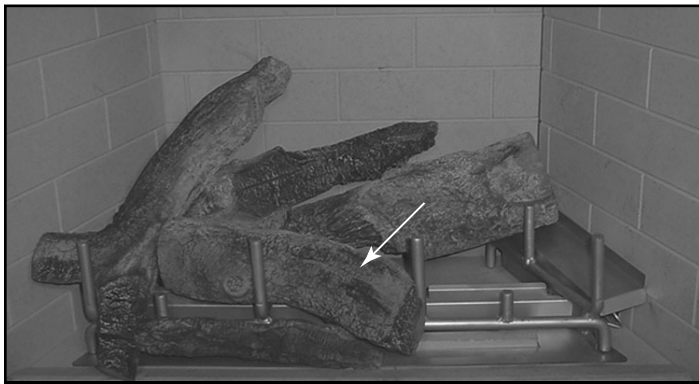

Figure 9.6 Front Left Log (SRV722)

- Place right front corner log between the right hand side wall and right hand side grate bar as shown.



Figure 9.9 Right Front Corner Log (SRV742)

- Place right center log between the 4th and 5th vertical bars on the log grate, resting the back on right rear log.

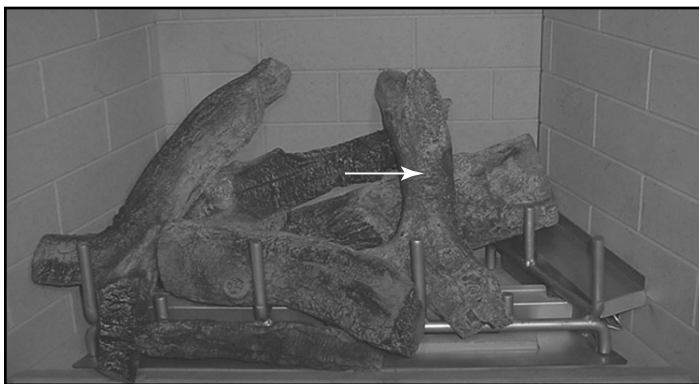

Figure 9.7 Front Right Log (SRV724)

- Place right log against the rightmost front grate bar and rest its rear on right rear log, angled towards the corner as shown.



Figure 9.8 Right Side Log (SRV740)

D. Glass Assembly



⚠ WARNING

Handle glass with care.

- Inspect the glass for cracks, chips or scratches.
- Do NOT strike, slam or scratch glass.
- Do NOT operate appliance with glass door removed, cracked, broken or scratched.
- Replace glass door assembly as a complete assembly.

- The glass doors are included with and pre-installed in the appliance.
- To adjust doors, open them and loosen screws on top and bottom pivot pins. Slide each door as necessary and tighten screws.
- To adjust handle, loosen screws to move handles as necessary and tighten screws.

Glass Specifications

Dakota42-B: Tempered
Dakota42L-B: Tempered
Dakota42H-B: Tempered
Dakota42HL-B: Tempered

E. Placing Lava Rock

- After logs have been placed spread part of the lava rock (included) between the rock pan and ashlip (see Figure 9.10).

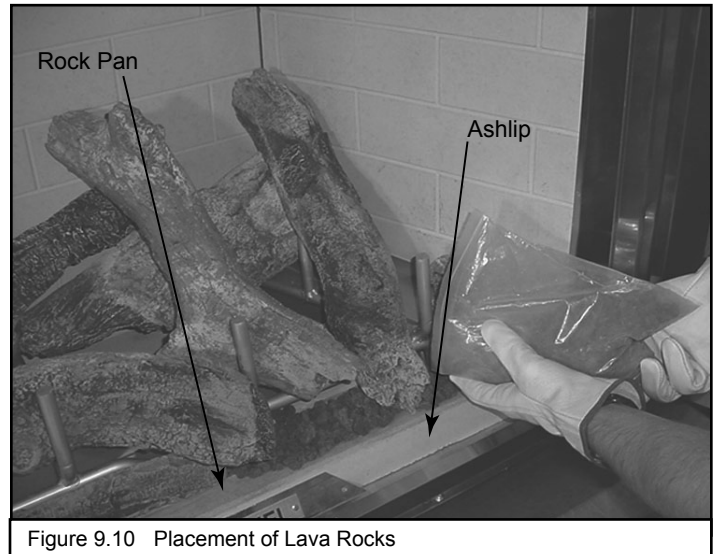





Figure 9.10 Placement of Lava Rocks

10 Operating Instructions

A. Before Lighting Appliance

Before operating this appliance, have a qualified technician:

- Remove all shipping materials from inside and/or underneath the firebox.
- Review proper placement of logs, rockwool, lava rock and vermiculite.
- Check the wiring.
- Check the air shutter adjustment.
- Ensure that there are no gas leaks.
- Ensure that the flow of combustion and ventilation air is not obstructed (front grilles).

	WARNING
	Fire Risk
	Burn Risk
	HOT! DO NOT TOUCH.
	SEVERE BURNS MAY RESULT.
	CLOTHING IGNITION MAY RESULT
	Glass and other surfaces are hot during operation and cool down.
	<ul style="list-style-type: none">• Keep children away.• CAREFULLY SUPERVISE children in same room as appliance.• Alert children and adults to hazards of high temperatures.• Do NOT operate with protective barriers open or removed.• Keep clothing, furniture, draperies and other combustibles away.

	WARNING
Improper installation, adjustment, alteration, service or maintenance can cause injury or property damage. Refer to the owner's information manual provided with this appliance. For assistance or additional information consult a qualified installer, service agency or the gas supplier.	

	WARNING
Do NOT use this appliance if any part has been under water. Immediately call a qualified service technician to inspect the appliance and to replace any part of the control system and any gas control which has been under water.	

B. Lighting the Appliance

Intellifire Ignition

FOR YOUR SAFETY READ BEFORE LIGHTING

WARNING: If you do not follow these instructions exactly, a fire or explosion may result causing property damage, personal injury or loss of life.

- A.** This appliance is equipped with an intermittent pilot ignition (IPI) device which automatically lights the burner. Do not try to light the burner by hand.
- B. BEFORE LIGHTING**, smell all around the appliance area for gas. Be sure to smell next to the floor because some gas is heavier than air and will settle on the floor.
- WHAT TO DO IF YOU SMELL GAS**
- Do not try to light any appliance.
 - Do not touch any electric switch; do not use any phone in your building.
 - Immediately call your gas supplier from a neighbor's phone. Follow the gas supplier's instructions.
 - If you cannot reach your gas supplier, call the fire department.
- C.** Do not use this appliance if any part has been under water. Immediately call a qualified service technician to inspect the appliance and to replace any part of the control system and any gas control which has been under water.

WARNING:

DO NOT CONNECT 110 VAC TO THE CONTROL VALVE.

Improper installation, adjustment, alteration, service or maintenance can cause injury or property damage. Refer to the owner's information manual provided with this appliance.

This appliance needs fresh air for safe operation and must be installed so there are provisions for adequate combustion and ventilation air.

If not installed, operated, and maintained in accordance with the manufacturer's instructions, this product could expose you to substances in fuel or fuel combustion which are known to the State of California to cause cancer, birth defects, or other reproductive harm.

Keep burner and control compartment clean. See installation and operating instructions accompanying appliance.

CAUTION:

Hot while in operation. Do not touch. Keep children, clothing, furniture, gasoline and other liquids having flammable vapors away.

Do not operate the appliance with panel(s) removed, cracked or broken. Replacement of the panel(s) should be done by a licensed or qualified service person.

NOT FOR USE WITH SOLID FUEL

For use with natural gas and propane. A conversion kit, as supplied by the manufacturer, shall be used to convert this appliance to the alternate fuel.

LIGHTING INSTRUCTIONS

1. Turn off wall switch.
2. This appliance is equipped with an ignition device which automatically lights the burner. Do not try to light the burner by hand.

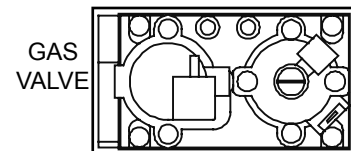

3. Wait five (5) minutes to clear out any gas. Then smell for gas, including near the floor. If you smell gas, STOP! Follow "B" in the Safety Information located on the left side of this label. If you don't smell gas, go to next step.
4. Turn on wall switch.
5. To light the burner, flip the ON/OFF switch to the "ON" position. (The ON/OFF switch may include a wall switch if so equipped).
6. If the appliance will not operate, check battery then follow the instructions "To Turn Off Gas to Appliance" and call your service technician or gas supplier.

TO TURN OFF GAS TO APPLIANCE

1. Turn off all electric power to the appliance if service is to be performed.
2. Flip ON/OFF switch to the "OFF" position.

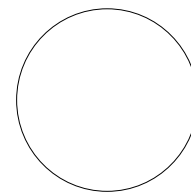

Final Inspection by _____

C. After the Appliance is Lit

Initial Break-in Procedure

When you light the appliance, you may notice that it produces heat which does have an associated odor or smell. If you feel this odor is excessive it may require the initial three to four hour continuous burn on high followed by a second burn up to 12 hours to fully drive off any odor from paint and lubricants used in the manufacturing process. Condensation of the glass is normal

Note: This appliance should be run three to four hours on the initial start-up. Turn it off and let it cool completely. Remove and clean the glass. Replace the glass and run the appliance for an additional 12 hours. This will help cure the products used in the paint and logs.

CAUTION

- Prevent accidental appliance operation when not attended.
- Unplug or remove batteries from remote switch if absent or if appliance will not be used for an extended period of time.
- Property damage possible from elevated temperatures.

CAUTION

Smoke and odors are released during initial operation.
Smoke and odors may be irritating to sensitive individuals.



WARNING

Fire Risk High Temperatures

Keep combustible household items away from appliance.

Do NOT obstruct combustion and ventilation air.

- Do NOT place combustible items on top of or in front of appliance.
- Keep furniture, draperies away from appliance.



WARNING

Fire Risk

Keep combustible materials, gasoline and other flammable vapors and liquids clear of appliance.

- Do NOT store flammable materials in the vicinity of the appliance.
- Do NOT use gasoline, lantern fuel, kerosene, charcoal lighter fluid or similar liquids in this appliance.

Combustible materials may ignite.

D. Frequently Asked Questions

Issue	Solutions
Condensation on the glass	This is a result of gas combustion and temperature variations. As the appliance warms, this condensation will disappear.
Blue flames	This is a result of normal operation and the flames will begin to yellow as the appliance is allowed to burn for 20 to 40 minutes.
Odor from appliance	When first operated, this appliance may release an odor for the first several hours. This is caused by the curing of the paint and the burning off of any oils remaining from manufacturing.
Film on the glass	This is a normal result of the curing process of the paint and logs. Glass should be cleaned within 3 to 4 hours of initial burning to remove deposits left by oils from the manufacturing process. A non-abrasive cleaner such as gas fireplace glass cleaner may be necessary. See your dealer.
Metallic noise	Noise is caused by metal expanding and contracting as it heats up and cools down, similar to the sound produced by a furnace or heating duct. This noise does not affect the operation or longevity of the fireplace.
Is it normal to see the pilot flame burn continually?	In an Intellifire ignition system it is normal to see the pilot flame, but it should turn off when ON/OFF is turned off. In a standing pilot system the pilot will always stay on.

11 Troubleshooting

With proper installation, operation and maintenance your gas appliance will provide years of trouble-free service. If you do experience a problem, this troubleshooting guide will assist a qualified service person in the diagnosis of a problem and the corrective action to be taken. This troubleshooting guide can only be used by a qualified service technician.

A. Intellifire Ignition System

Symptom	Possible Causes	Corrective Actions
1. The ignitor/module makes noise, but no spark.	A. Incorrect wiring.	Verify "S" wire (white) for sensor and "I" wire (orange) for ignitor are connected to the correct terminals on the module and the pilot assembly. Reversed wires at the module may cause the system to make a sparking noise, but the spark may not be present at pilot hood.
	B. Loose connections or electrical shorts in the wiring.	Verify there are no loose connections or electrical shorts in wiring from module to pilot assembly. The rod closest to the pilot hood should be ignitor. Verify connections underneath pilot assembly are tight; also verify the connections are not grounding out to the metal chassis, pilot burner, pilot enclosure, mesh screen if present, or any other metal object.
	C. Ignitor gap is too large.	Verify gap of ignitor to pilot hood. The gap should be approximately .17 in. or 1/8 in.
	D. Faulty module.	Turn ON/OFF rocker switch or wall switch to OFF position. Remove ignitor wire "I" from module. Place ON/OFF rocker switch or wall switch in ON position. Hold ground wire about 3/16 in. away from "I" terminal on module. If there is no spark at "I" terminal, module must be replaced. If there is a spark at "I" terminal, module is fine. Inspect pilot assembly for shorted sparker wire or cracked insulator around electrode.
2. Pilots won't light, there is no noise or spark.	A. Transformer installed incorrectly.	Verify that transformer is installed and plugged into module. Check voltage of transformer under load at space connection on module with ON/OFF switch in ON position. Acceptable readings of a good transformer are between 3.2 and 2.8 volts AC.
	B. A shorted or loose connection in wiring configuration or wiring harness.	Remove and reinstall the wiring harness that plugs into module. Verify there is a tight fit. Verify pilot assembly wiring to module. Remove and verify continuity of each wire in wiring harness.
	C. Improper wall switch wiring.	Verify wall switch is wired correctly.
	D. Module not grounded.	Verify black ground wire from module wire harness is grounded to metal chassis of appliance.
	E. Faulty module.	Turn ON/OFF rocker switch or wall switch to OFF position. Remove ignitor wire "I" from module. Place ON/OFF rocker switch or wall switch in ON position. Hold ground wire about 3/16 in. away from "I" terminal on module. If there is no spark at "I" terminal module must be replaced. If there is a spark at "I" terminal, module is fine. Inspect pilot assembly for shorted sparker wire or cracked insulator around electrode.
3. Pilot lights but continues to spark, and main burner will not ignite. (If the pilot continues to spark after the pilot flame has been lit, flame rectification has not occurred.)	A. A shorted or loose connection in sensor rod.	Verify all connections to wiring diagram in manual. Verify connections underneath pilot assembly are tight. Verify connections are not grounding out to metal chassis, pilot burner, pilot enclosure or screen if present, or any other metal object.
	B. Poor flame rectification or contaminated sensor rod.	Verify flame is engulfing sensor rod. If the pilot assembly does not have a ground strap, consider installing one to increase flame rectification. Verify correct pilot orifice is installed and inlet gas specifications are met. Flame carries rectification current, not the gas. If flame lifts from pilot hood, the circuit is broken. A wrong orifice or too high an inlet pressure can cause pilot flame to lift. The sensor rod may be contaminated. Clean sensor rod with emery cloth.
	C. Module is not grounded.	Verify that module is securely grounded to metal chassis of appliance. Verify that the wire harness is firmly connected to module.
	D. Damaged pilot assembly or dirty sensor rod.	Verify that ceramic insulator around the sensor rod is not cracked, damaged, or loose. Verify connection from sensor rod to white sensor wire. Clean sensor rod with emery cloth to remove any contaminants that may have accumulated on sensor rod. Verify continuity with a multimeter with ohms set at lowest range.
	E. Faulty module.	Turn ON/OFF rocker switch or wall switch to OFF position. Remove ignitor wire "I" from module. Place ON/OFF rocker switch or wall switch in ON position. Hold ground wire about 3/16 in. away from "I" terminal on module. If there is no spark at "I" terminal, module must be replaced. If there is a spark at "I" terminal, module is fine. Inspect pilot assembly for shorted sparker wire or cracked insulator around electrode.
4. Pilot sparks, but pilot will not light.	A. Correct gas supply.	Verify that incoming gas line ball valve is "open". Verify that inlet pressure reading is within acceptable limits, inlet pressure must not exceed 14 in. w.c.
	B. Ignitor gap is too large.	Verify that spark gap from ignitor to pilot hood is .17 in. or 1/8 in.
	C. Module is not grounded.	Verify module is securely grounded to metal chassis of appliance.
	D. Module voltage output/valve/pilot solenoid ohms readings.	Replace module.

12 Maintaining and Servicing the Appliance

Although the frequency of appliance servicing and maintenance will depend on use and the type of installation, a qualified service technician should perform an appliance check-up at the beginning of each heating season.

WARNING

Risk of injury or property damage

Before servicing:

- Turn off gas.
- Turn off electricity to appliance.
- Disable remote control, if one is present.
- Ensure appliance is completely cooled.

After Servicing:

- Replace any screen or barrier that was removed.
- Reseal and reinstall any venting removed for servicing.

WARNING



Annual inspection by qualified technician recommended.

Check:

- Condition of doors, surrounds and fronts.
- Condition of glass, glass assembly and glass seal.
- Obstructions of combustion and ventilation air.
- Condition of logs.
- Condition of firebox.
- Burner ignition and operation.
- Burner air shutter adjustment.
- Gas connections and fittings.
- Obstructions of termination cap.

Clean:

- Glass.
- Air passageways, grilles, control compartment.
- Burner, burner ports.

Risk of:

- Fire
- Delayed ignition or explosion
- Exposure to combustion fumes
- Odors



CAUTION

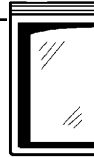

Handle glass assembly with care.

Note: Clean glass after initial 3-4 hours operation. **Longer operation without cleaning glass may cause a permanent white film on glass.**

When cleaning glass door:

- Avoid striking, scratching or slamming doors.
- Do NOT use abrasive cleaners.
- Use a hard water deposit glass cleaner on white film.
- Do NOT clean glass when it is hot.
- Turn off appliance after 3-4 hours of operation and ALLOW TO COOL.
- Remove and clean glass assembly.
- Replace glass assembly and operate appliance for an additional 12 hours.

Refer to maintenance instructions.

WARNING



Fire Risk

Explosion Risk

Inspect external vent cap regularly.

- Ensure no debris blocks cap.
- Combustible materials blocking cap may ignite.
- Restricted air flow affects burner operation.



A. Valve Service and Replacement

Tools Required

Phillips screwdriver

7/16 in., 5/8 in., 13/16 in., 15/16 in. wrenches



Figure 12.1 Tools Required

- The valve can be accessed through the valve access panel on the right side of the fireplace.
- Lift doors out and set aside.
- Remove grate and pilot shield (see Figure 6.2).

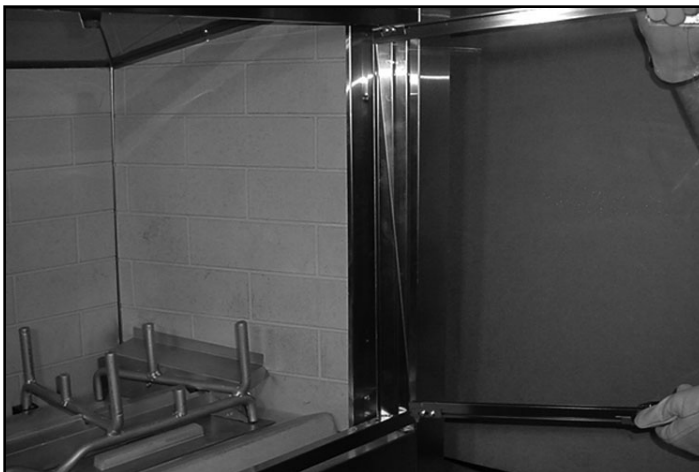

Figure 12.2 Lift Out Doors

- Use a phillips screwdriver to remove the right refractory by removing the two screws securing the refractory retaining strip. Remove the refractory side panel and set aside.



Figure 12.3 Loosen Refractory Retaining Strip

- Remove the inside valve access panel by lifting it up and out.



Figure 12.4 Remove Valve Access Panel

- Using a phillips screwdriver remove the exterior valve access panel.

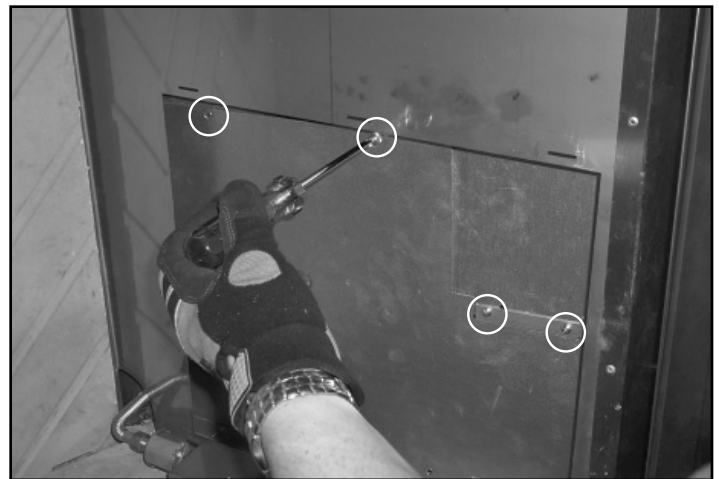

Figure 12.5 Remove Exterior Valve Access Panel

- Turn the gas ball valve off and disconnect the gas line after the ball valve by loosening the flare nut using a 13/16 in. and a 15/16 in. wrench.



Figure 12.6 Turn off Gas Valve

- Using two 3/4 in. wrenches, disconnect the burner supply tube.

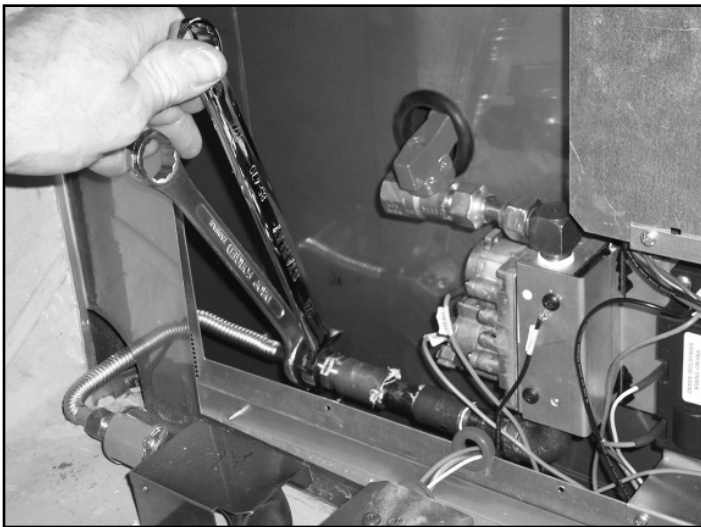

Figure 12.7 Disconnect Burner Supply Tube

- Remove the two screws securing the valve to the valve bracket.

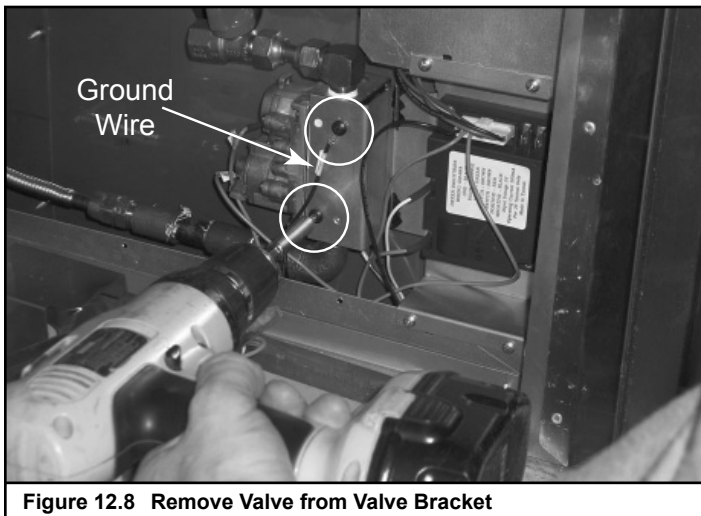

Figure 12.8 Remove Valve from Valve Bracket

- Disconnect the pilot and orifice tubes using a 7/16 in. and a 5/8 in. wrench.
- Reverse these steps to replace the gas valve. Make sure the ground wire is reattached as shown in Figure 12.8.

B. Battery Replacement

- Remove switch cover plate from the wall.

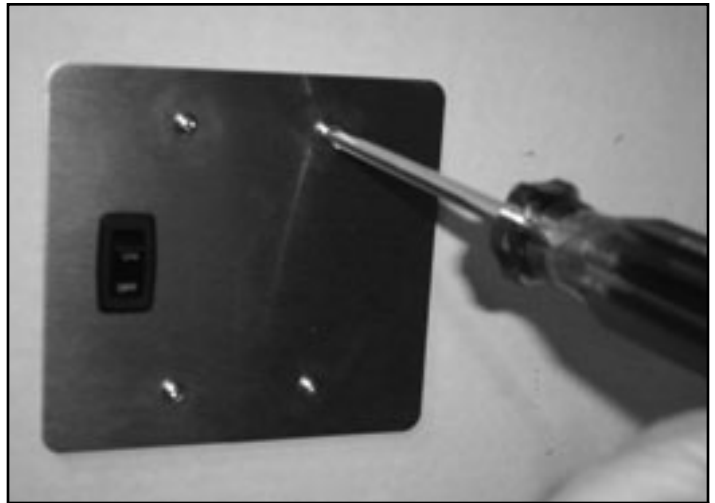

Figure 12.9 Switch Cover Plate

- Replace two D-cell batteries.



Figure 12.10 Batteries

- Replace switch cover plate.

B. Maintenance and Service Tasks:

Inspect	Maintenance Tasks
Doors, surrounds and fronts	1. Inspect for scratches and nicks that can lead to breakage when exposed to heat.
	2. Verify no obstructions to airflow through the louvers.
	3. Verify proper clearance to combustible household objects is maintained.
Glass assembly and glass	1. Inspect glass panels for scratches and nicks that can lead to breakage when exposed to heat.
	2. Confirm there is no damage to glass or glass frame. Replace as necessary.
	3. Verify that latches engage properly, clip studs are not stripped, and glass attachment components are intact and operating properly. Replace as necessary.
	4. Clean glass using a nonabrasive cleaner such as Brasso®. Replace glass assembly if severely coated with silicate deposits that cannot be removed.
Valve compartment and firebox top	1. Vacuum and wipe out dust, cobwebs, debris or pet hair. Use caution when cleaning these areas. Screw tips that have penetrated the sheet metal are sharp and should be avoided.
	2. Remove any foreign objects.
	3. Verify unobstructed air circulation.
Logs	1. Inspect for broken, damaged or missing logs. Replace as necessary.
	2. Verify correct log placement and no flame impingement causing sooting. Correct as necessary.
Firebox	1. Inspect for paint condition, warpage, corrosion or perforation. Sand and repaint as necessary.
	2. Replace appliance if firebox has been perforated.
Burner ignition and operation	1. Verify burner is properly secured and aligned with pilot or igniter.
	2. Clean off burner top, inspect for plugged ports, corrosion or deterioration. Replace burner if necessary.
	3. Replace rockwool with new dime-sized and shaped pieces. Do not block ports or obstruct lighting paths.
	4. Check for smooth lighting and ignition carryover to all ports. Verify there is no ignition delay.
	5. Inspect for lifting or other flame problems.
	6. Verify air shutter is clear of dust and debris.
	7. Inspect orifice for soot, dirt or corrosion.
	8. Verify manifold and inlet pressures. Adjust regulator as required.
	9. Inspect pilot flame strength. Clean or replace orifice as necessary.
	10. Inspect thermocouple/thermopile or IPI sensor rod for soot, corrosion and deterioration. Clean with emery cloth or replace as required.
	11. Verify millivolt output. Replace as necessary.
Remote controls	1. Verify operation of remote.
	2. Replace batteries in remote transmitters and battery-powered receivers.
	3. If appliance will not be used for a long period of time, verify batteries have been removed from battery back-up in IPI systems to prevent premature battery failure or leaking.

13 Reference Materials

A. Appliance Dimension Diagram

Dimensions are actual appliance dimensions. Use for reference only. For framing dimensions and clearances refer to Section 3.

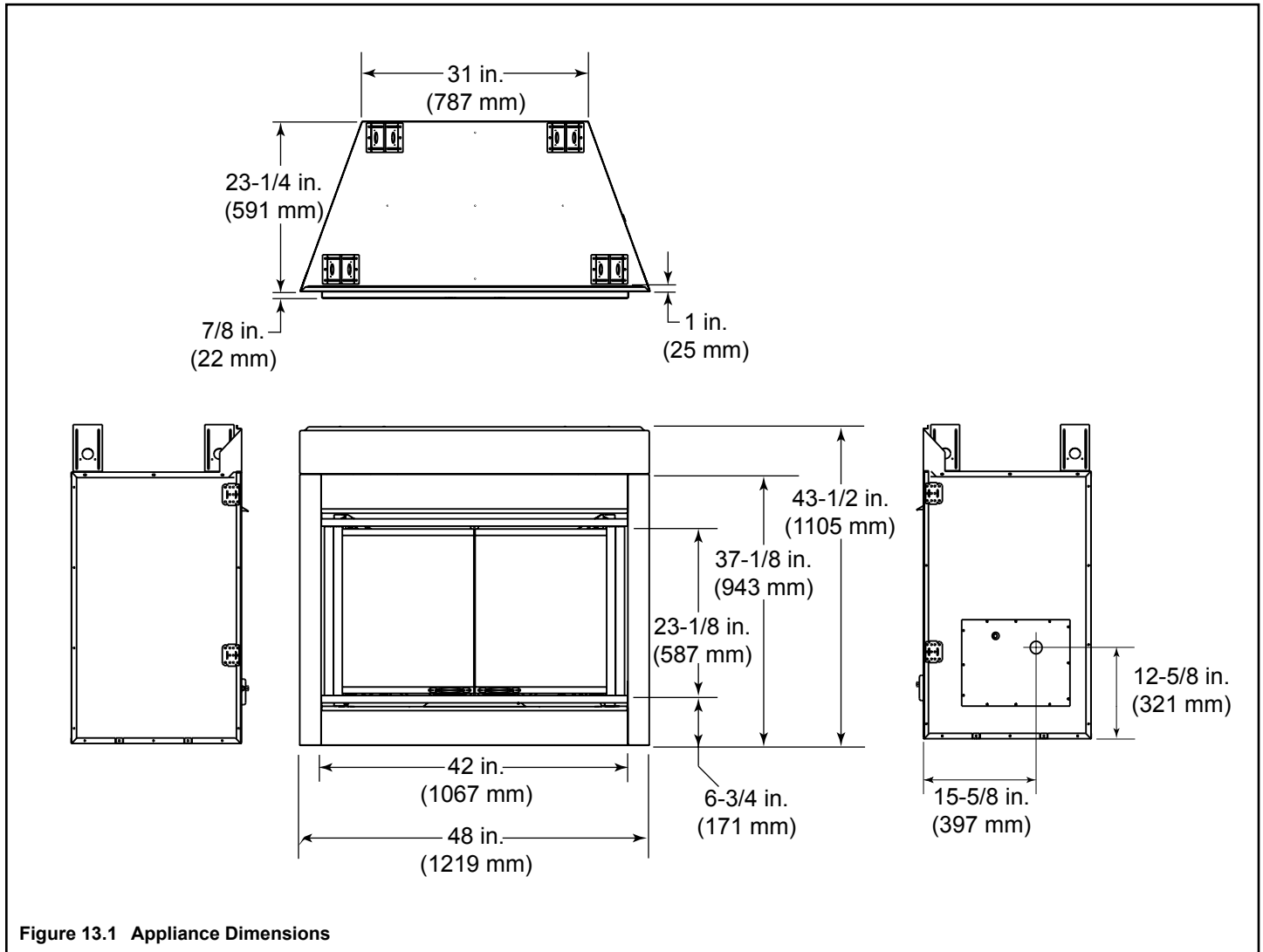

Figure 13.1 Appliance Dimensions

➔ B. Service Parts List

HEAT & GLO
LifeStyleCollection™

Service Parts

DAKOTA42-B SERIES

Exploded Parts Diagram
42 in. Outdoor Gas Fireplace

Beginning Manufacturing Date: 2/01/06
Ending Manufacturing Date: Active

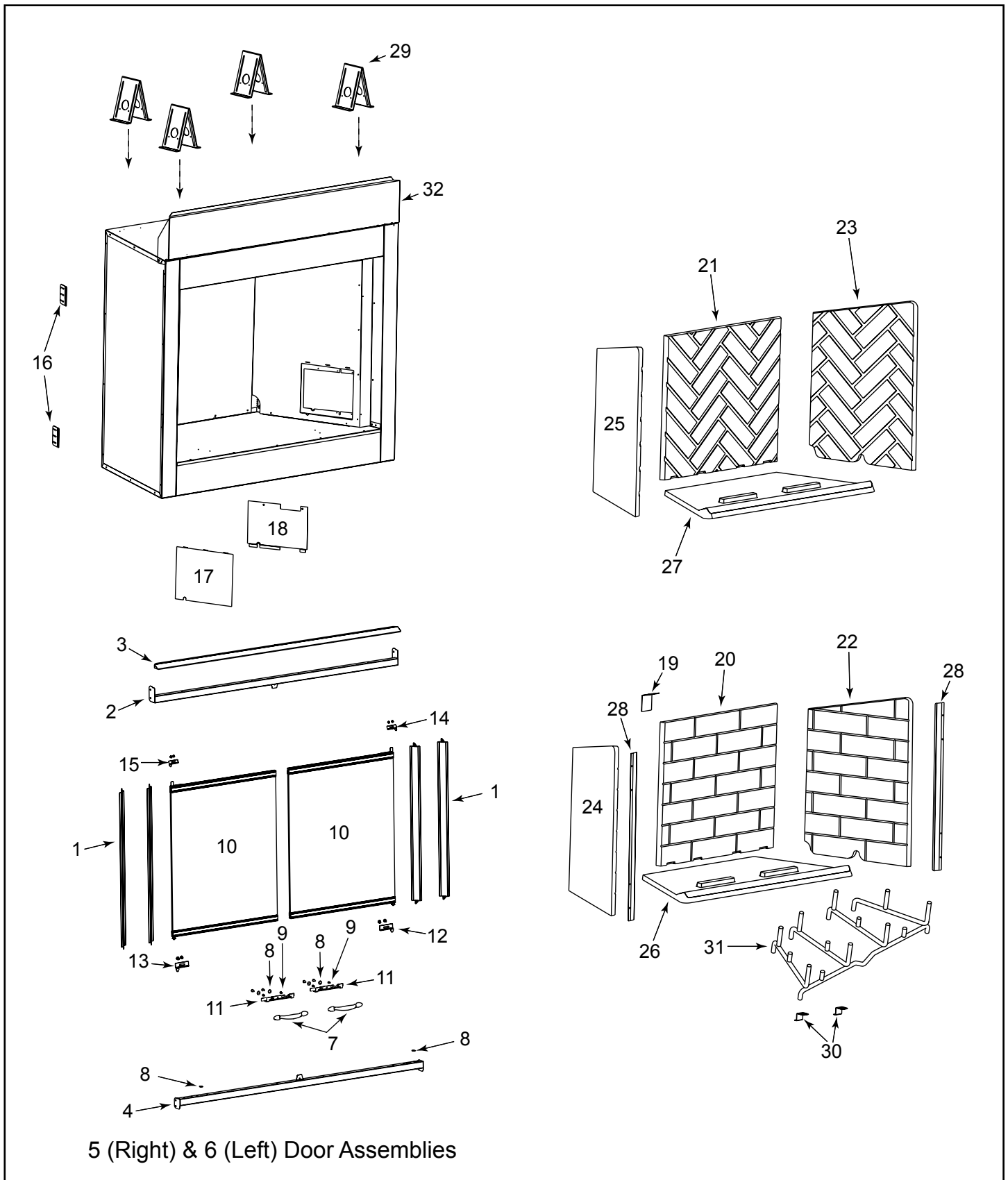

5 (Right) & 6 (Left) Door Assemblies

Service Parts List
 42 in. Outdoor Gas Fireplace
 (parts listed in bold italics are critical parts)

Beginning Manufacturing Date: 2/01/06
 Ending Manufacturing Date: Active

#	Description of Part	DAKOTA42-B	DAKOTA42H-B	DAKOTA42L-B	DAKOTA42LH-B	Qty. req.
1	Door Grille Bar	4036-177	4036-177	4036-177	4036-177	4
2	Top Door Support Assembly	4036-082	4036-082	4036-082	4036-082	1
3	Gas Hood	4036-195	4036-195	4036-195	4036-195	1
4	Bottom Door Support Assembly	4036-083	4036-083	4036-083	4036-083	1
5	Right Glass Door Assembly	4036-599	4036-599	4036-599	4036-599	1
6	Left Glass Door Assembly	4036-601	4036-601	4036-601	4036-601	1
7	Door Handle	4021-350	4021-350	4021-350	4021-350	1
8	Nylon Washer	34362	34362	34362	34362	2
9	#8 32x3/8 PH Flat Counter Sink	4021-345	4021-345	4021-345	4021-345	2
10	Glass Panel Assembly	4036-020	4036-020	4036-020	4036-020	1
11	Handle Bracket	4036-178	4036-178	4036-178	4036-178	1
12	Right Bottom Pivot Pin	4036-115	4036-115	4036-115	4036-115	1
13	Left Bottom Pivot Pin	4036-116	4036-116	4036-116	4036-116	1
14	Right Top Pivot Pin	4036-118	4036-118	4036-118	4036-118	1
15	Left Top Pivot Pin	4036-119	4036-119	4036-119	4036-119	1
16	Nailing Flange	31190	31190	31190	31190	4
17	Inner Shell Access Panel	4036-137	4036-137	4036-137	4036-137	1
18	Intermediate Shell Access Panel	4036-139	4036-139	4036-139	4036-139	1
	Outer Shell Access Panel	4036-186	4036-186	4036-186	4036-186	1
	Outer Shell Access Panel Fastener Pack	4025-007	4025-007	4025-007	4025-007	1
19	Back Refractory Bracket	4036-121	4036-121	4036-121	4036-121	1
20	Traditional Brick Back Refractory	28394		28394		1
21	Herringbone Back Refractory		4010-015		4010-015	1
22	Traditional Brick Right Side Refractory	4036-145		4036-145		1
23	Herringbone Right Side Refractory		4036-147		4036-147	1
24	Traditional Brick Left Side Refractory	4036-146		4036-146		1
25	Herringbone Left Side Refractory		4036-148		4036-148	1
26	Traditional Brick Hearth Refractory	4036-740		4036-740		1
27	Herringbone Hearth Refractory		4036-152		4036-152	1
28	Side Refractory Cover	4036-133	4036-133	4036-133	4036-133	2
29	Top Standoffs	13433	13433	13433	13433	4
	Installation Instructions & Owner's Manual	4036-909	4036-909	4036-909	4036-909	1
	Lava Rock	4021-296	4021-296	4021-296	4021-296	1
	Hearth Fiber Coal Bed	4036-730	4036-730	4036-730	4036-730	1
30	Grate Retainer Clip	28062	28062	28062	28062	2
31	Grate	4036-067	4036-067	4036-067	4036-067	1
32	Upper Face	4036-197	4036-197	4036-197	4036-197	1

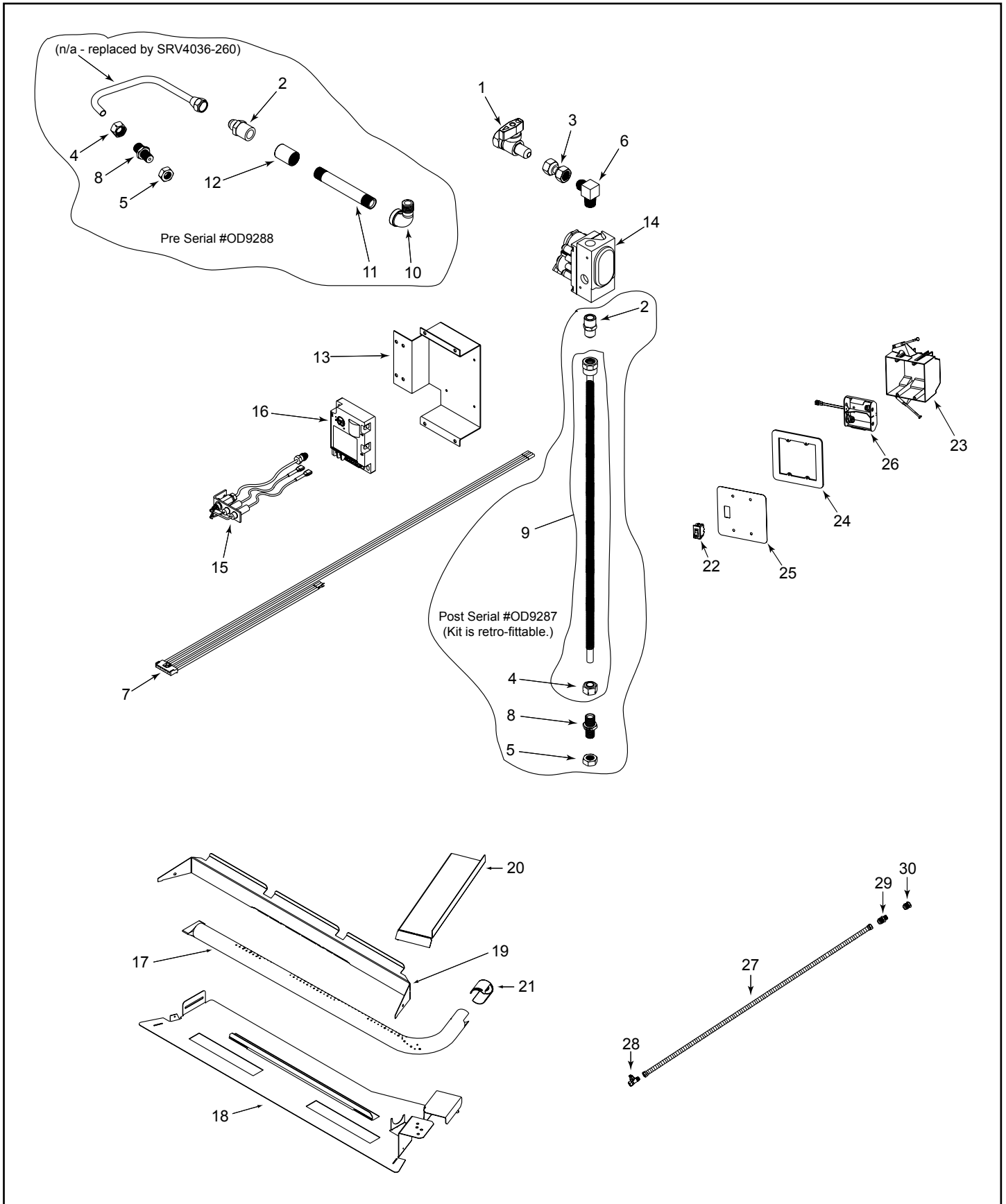

Service Parts List
42 in. Outdoor Gas Fireplace
(parts listed in bold italics are critical parts)

Beginning Manufacturing Date: 2/01/06
Ending Manufacturing Date: Active

#	Description of Part	DAKOTA42-B	DAKOTA42H-B	DAKOTA42L-B	DAKOTA42LH-B	Qty. req.
1	ON/OFF Valve	15697	15697	15697	15697	1
2	Brass Fitting (1/2-3/8)	19641	19641	19641	19641	1
3	3/8 Swivel Nut Connector	2090-109	2090-109	2090-109	2090-109	1
	Black Wire Tie	224-0300	224-0300	224-0300	224-0300	1
4	Compression Nut	32553	32553	32553	32553	1
5	Jam Nut (1/2-20)	32563	32563	32563	32563	1
6	Brass Elbow	4021-098	4021-098	4021-098	4021-098	1
7	IPI Wiring Harness (w/5 ft. Leads)	4021-116	4021-116	4021-116	4021-116	1
8	Burner Orifice	4021-134	4021-134	32562	32562	1
9	Flex Burner Line Kit - post Serial #OD9287	SRV4036-260	SRV4036-260	SRV4036-260	SRV4036-260	1
10	3/8 NPT Street L - pre Serial #OD9288	4021-347	4021-347	4021-347	4021-347	1
11	3/8 Male NPT x 4-1/2 in. Pipe - pre Serial #OD9288	4021-348	4021-348	4021-348	4021-348	1
12	3/8 in. NPT Pipe Coupler - pre Serial #OD9288	4021-349	4021-349	4021-349	4021-349	1
13	Valve Assembly Bracket	4036-179	4036-179	4036-179	4036-179	1
14	Valve	593-500	593-500	593-501	593-501	1
15	Pilot Assembly	593-512A	593-512A	593-513A	593-513A	1
16	Control Module	593-592	593-592	593-592	593-592	1
	Burner Tube Assembly	4036-068	4036-068	4036-069	4036-069	1
17	1-1/4 in. Burner Tube	4036-187	4036-187	4036-188	4036-188	1
18	Burner Tube Bracket	4036-189	4036-189	4036-189	4036-189	1
19	Rock Retainer	4036-190	4036-190	4036-190	4036-190	1
20	Pilot Shield	4036-191	4036-191	4036-191	4036-191	1
21	Air Shutter	4036-194	4036-194	4036-194	4036-194	1
	Switch Box Assembly	4036-040	4036-040	4036-040	4036-040	1
22	ON/OFF Rocker Switch	060-511	060-511	060-511	060-511	1
23	Switch Box	4021-117	4021-117	4021-117	4021-117	1
	Switch Box Screw Pack	4021-141	4021-141	4021-141	4021-141	1
24	Electrical Box Gasket	4021-153	4021-153	4021-153	4021-153	1
25	Switch Cover Plate	4036-157	4036-157	4036-157	4036-157	1
26	Battery Pack	593-594A	593-594A	593-594A	593-594A	1
Also available:						
	60 in. Flex Line Assembly	SRV4036-044	SRV4036-044	SRV4036-044	SRV4036-044	1
27	60 in. Flex Line 5/8 in. dia.	4021-133	4021-133	4021-133	4021-133	1
28	ON/OFF Valve	4021-115	4021-115	4021-115	4021-115	1
29	Coupler - 3/8 Male NPT / 7/8 SAE Flare	4021-114	4021-114	4021-114	4021-114	1
30	1/2 in. Male NPT to 3/8 in. Fem. NPT Bush	4021-030	4021-030	4021-030	4021-030	1
	Conversion Kit NG to LP	LPK-DAKOTA-B	LPK-DAKOTA-B			1
	Conversion Kit LP to NG			NGK-DAKOTA-B	NGK-DAKOTA-B	1



SRV720



SRV727



SRV722



SRV723



SRV724



SRV728



SRV740



SRV742

Service Parts List
42 in. Outdoor Gas Fireplace
(parts listed in bold italics are critical parts)

Beginning Manufacturing Date: 2/01/06
Ending Manufacturing Date: Active

#	Description of Part	DAKOTA42-B	DAKOTA42H-B	DAKOTA42L-B	DAKOTA42LH-B	Qty. req.
	Log Set - Box 1	4036-711	4036-711	4036-711	4036-711	1
	Left Front Log	SRV720	SRV720	SRV720	SRV720	1
	Log Set - Box 2	4036-712	4036-712	4036-712	4036-712	1
	Lower Middle Log	SRV727	SRV727	SRV727	SRV727	1
	Top Left Rear Log	SRV722	SRV722	SRV722	SRV722	1
	Top Middle Left Log	SRV740	SRV740	SRV740	SRV740	1
	Lower Right Log	SRV742	SRV742	SRV742	SRV742	1
	Log Set - Box 3	4036-713	4036-713	4036-713	4036-713	1
	Top Right Rear Log	SRV723	SRV723	SRV723	SRV723	1
	Upper Middle Log	SRV724	SRV724	SRV724	SRV724	1
	Top Middle Right Log	SRV728	SRV728	SRV728	SRV728	1

This page intentionally left blank.

HEAT & GLO

LifeStyleCollection™

WARRANTY FOR HEAT & GLO LIFESTYLE COLLECTION FIREPLACES

The limited warranty will not become effective until you have mailed the completed warranty card to:

**Hearth & Home Technologies Inc., A DIVISION OF HNI
20802 Kensington Blvd., Lakeville, MN 55044.**

This card must be mailed within sixty days of the fireplace installation.

Subject to the conditions set forth herein, HEARTH & HOME TECHNOLOGIES INC. (HHT) extends the following limited warranty with respect to your Heat & Glo LifeStyle Collection fireplace, excluding accessories, chimney components and glass doors.

If HHT is satisfied that any part or portion of the fireplace covered by this warranty is defective in material or workmanship under normal use and service as described in the operating instructions, HHT will take the following actions:

1. Within the first five (5) years from the date of installation, HHT shall, at its option, replace or repair any such defect in material or workmanship, at HHT's expense. HHT SHALL NOT BE RESPONSIBLE FOR ANY OTHER LABOR COSTS, OR EXPENSES, INCLUDING INDIRECT, INCIDENTAL OR CONSEQUENTIAL DAMAGES.
2. During the sixth (6th) through the tenth (10th) years after the date of installation, HHT shall supply replacement parts or parts at no charge, but SHALL NOT BE RESPONSIBLE FOR ANY LABOR, TRANSPORTATION, OR OTHER INDIRECT DAMAGES.
3. During the eleventh (11th) through the fifteenth (15th) years after date of installation, HHT will send to you, FOB its factory, replacement parts (if available) at the current minimum wholesale price, but HHT SHALL NOT BE RESPONSIBLE FOR ANY LABOR, TRANSPORTATION OR OTHER INDIRECT DAMAGES.
4. During the first six (6) months after installation, HHT shall, at its option, replace or repair the glass doors and any electrical components, if operation is faulty. (This does not include glass panels broken during shipment, misuse or careless handling.) After the first six (6) months, HHT will sell to you, FOB its factory, replacement parts at the current list price, but HHT SHALL NOT BE RESPONSIBLE FOR ANY LABOR, TRANSPORTATION OR OTHER INDIRECT DAMAGES. IF GLASS DOORS OTHER THAN FACTORY DOORS ARE USED ALL WARRANTY AND LIABILITY ON THE FIREPLACE IS VOIDED.

HHT may discharge its entire warranty liability by refunding the price of the product.

Products made by other manufacturers, sold with the fireplace or thereafter are not covered by this limited warranty.

This limited warranty will be void if the fireplace is not installed according to the installation instructions. The limited warranty also is void if the fireplace is not operated, at all times, according to the operating instructions furnished. The limited warranty will also be void if the fireplace is removed from the place originally installed.

EXCEPT TO THE EXTENT PROVIDED BY LAW, NO IMPLIED WARRANTIES OF MERCHANTABILITY OR FITNESS FOR A PARTICULAR PURPOSE, AND NO IMPLIED WARRANTIES SHALL APPLY TO THE FIREPLACE AFTER THE ABOVE LIMITED WARRANTY HAS EXPIRED.

In states that do not allow limitations on how long implied warranty lasts, or do not allow exclusion of indirect damages, those limitations or exclusions may not apply to you. You may also have additional rights not covered in this limited warranty.

HHT reserves the right to make changes at any time, without notice, in design, material, specifications and prices and the right to discontinue styles and products.

Feb 2006

D. Contact Information

HEAT & GLO

LifeStyleCollection™

Please contact your Heat & Glo LifeStyle Collection dealer with any questions or concerns.

For the number of your nearest Heat & Glo LifeStyle Collection dealer,
please call 1-888-427-3973

- NOTES -

CAUTION		
	DO NOT DISCARD THIS MANUAL	
	Important operating and maintenance instructions included.	Read, understand and follow these instructions for safe installation and operation.



This product may be covered by one or more of the following patents: (United States) 4593510, 4686807, 4766876, 4793322, 4811534, 5000162, 5016609, 5076254, 5113843, 5191877, 5218953, 5263471, 5328356, 5341794, 5347983, 5429495, 5452708, 5542407, 5601073, 5613487, 5647340, 5688568, 5762062, 5775408, 5890485, 5931661, 5941237, 5947112, 5996575, 6006743, 6019099, 6048195, 6053165, 6145502, 6170481, 6237588, 6296474, 6374822, 6413079, 6439226, 6484712, 6543698, 6550687, 6601579, 6672860, 6688302B2, 6715724B2, 6729551, 6736133, 6748940, 6748942, 6769426, 6774802, 6796302, 6840261, 6848441, 6863064, 6866205, 6869278, 6875012, 6880275, 6908039, 6919884, D320652, D445174, D462436; (Canada) 1297749, 2195264, 2225408, 2313972; (Australia) 780250, 780403, 1418504 or other U.S. and foreign patents pending.

Free Manuals Download Website

<http://myh66.com>

<http://usermanuals.us>

<http://www.somanuals.com>

<http://www.4manuals.cc>

<http://www.manual-lib.com>

<http://www.404manual.com>

<http://www.luxmanual.com>

<http://aubethermostatmanual.com>

Golf course search by state

<http://golfingnear.com>

Email search by domain

<http://emailbydomain.com>

Auto manuals search

<http://auto.somanuals.com>

TV manuals search

<http://tv.somanuals.com>