



Multi-Protocol On-board Ethernet Multi-function Print Server and Wireless Ethernet Multi-function Print Server

NETWORK USER'S GUIDE

This Network User's Guide provides useful information of wired and wireless network settings using your Brother machine. You can also find supported protocol information and detailed troubleshooting tips.

To find basic information about network and advanced network features of your Brother machine, see the *Network Glossary*.

To download the latest manual, please visit the Brother Solutions Center at (<http://solutions.brother.com/>). You can also download the latest drivers and utilities for your machine, read FAQs and troubleshooting tips or learn about special printing solutions from the Brother Solutions Center.



Applicable models

This User's Guide applies to the following models.

MFC-J280W/J430W/J432W/J625DW/J825DW/J835DW and DCP-J725DW/J925DW

Definitions of notes

We use the following icons throughout this User's Guide:

 IMPORTANT	IMPORTANT indicates a potentially hazardous situation which, if not avoided, may result in damage to property or loss of product functionality.
 Note	Notes tell you how you should respond to a situation that may arise or give tips about how the operation works with other features.

Compilation and publication notice

Under the supervision of Brother Industries, Ltd., this manual has been compiled and published, covering the latest product's descriptions and specifications.

The contents of this manual and the specifications of this product are subject to change without notice.

Brother reserves the right to make changes without notice in the specifications and materials contained herein and shall not be responsible for any damages (including consequential) caused by reliance on the materials presented, including but not limited to typographical and other errors relating to the publication.

©2011 Brother Industries, Ltd.

IMPORTANT NOTE

- This product is approved for use in the country of purchase only. Do not use this product outside the country of purchase as it may violate the wireless telecommunication and power regulations of that country.
- Windows® XP in this document represents Windows® XP Professional, Windows® XP Professional x64 Edition and Windows® XP Home Edition.
- Windows Server® 2003 in this document represents Windows Server® 2003, Windows Server® 2003 x64 Edition, Windows Server® 2003 R2 and Windows Server® 2003 R2 x64 Edition.
- Windows Server® 2008 in this document represents Windows Server® 2008 and Windows Server® 2008 R2.
- Not all models are available in all countries.
- In this manual, the LCD messages of the MFC-J825DW are used if not specified.

Table of Contents

1	Introduction	1
	Network features.....	1
	Other Network features	3
2	Changing your machine's network settings	4
	How to change your machine's network settings (IP address, Subnet mask and Gateway).....	4
	Using the control panel.....	4
	Using the BRAdmin Light utility	4
	Other Management Utilities	7
	BRAdmin Professional 3 utility (Windows®)	7
3	Configuring your machine for a wireless network	8
	Overview.....	8
	Confirm your network environment.....	9
	Connected to a computer with a WLAN access point/router in the network (Infrastructure mode).....	9
	Connected to a wireless capable computer without a WLAN access point/router in the network (Ad-hoc mode).....	10
	Wireless configuration temporarily using a USB cable	11
	For Windows® users (Recommended).....	11
	For Macintosh users	12
	Wireless configuration temporarily using an Ethernet cable (For MFC-J825DW/J835DW and DCP-J925DW)	14
	One push configuration using Wi-Fi Protected Setup or AOSS™	17
	One-push configuration using WPS (Wi-Fi Protected Setup) or AOSS™	17
	Configuration using the PIN Method of Wi-Fi Protected Setup	19
	Configuration using the machine's control panel Setup Wizard	23
	Manual configuration from the control panel	23
	Configuring your machine when the SSID is not broadcast	26
	Configuration in Ad-hoc Mode	30
	Configure the wireless settings.....	30
4	Control panel setup	34
	Network menu.....	34
	TCP/IP	34
	Setup Wizard	36
	WPS/AOSS™	36
	WPS w/PIN Code	36
	WLAN Status	37
	Ethernet (For MFC-J825DW/J835DW and DCP-J925DW)	37
	MAC Address	37
	Network I/F (For MFC-J825DW/J835DW and DCP-J925DW)	37
	Restoring the network settings to factory default.....	38
	Printing the Network Configuration Report	39
	Printing the WLAN Report	40
	Function table and default factory settings	41

5	Web Based Management	46
	IMPORTANT.....	46
	Overview.....	46
	How to configure the machine settings using Web Based Management (web browser).....	47
	Secure Function Lock 2.0.....	49
	How to configure the Secure Function Lock 2.0 settings using Web Based Management (web browser).....	49
	Changing the Scan to FTP configuration using a web browser.....	52
	Changing the Scan to Network configuration using a web browser.....	53
6	Internet fax	54
	IMPORTANT.....	54
	Internet fax Overview.....	54
	Important information on Internet fax.....	55
	How to Internet fax.....	56
	Sending an Internet fax.....	56
	Receiving E-mail or Internet fax.....	57
	Additional Internet Fax options.....	59
	Forwarding received E-mail and fax messages.....	59
	Relay broadcasting.....	59
	TX Verification Mail.....	61
	Error mail.....	62
7	Security features	63
	IMPORTANT.....	63
	Overview.....	63
	Sending an E-mail securely.....	64
	Configuration using Web Based Management (web browser).....	64
	Sending an E-mail with user authentication.....	65
	Secure Management using BRAdmin Professional 3 (Windows®).....	66
	To use the BRAdmin Professional 3 utility securely, you need to follow the points below.....	66
8	Troubleshooting	67
	Overview.....	67
A	Appendix A	73
	Supported protocols and security features.....	73
B	Index	74

Network features

Your Brother machine can be shared on a 10/100 MB wired ¹ or IEEE 802.11b/g/n wireless Ethernet network using the internal network print server. The print server supports various functions and methods of connection depending on the operating system you are running on a network supporting TCP/IP. The following chart shows what network features and connections are supported by each operating system.



Note

Although the Brother machine can be used in both a wired ¹ and wireless network, only one connection method can be used at a time.

¹ A wired network interface is available on the MFC-J825DW/J835DW and DCP-J925DW.

Operating Systems	Windows® XP Windows Vista® Windows® 7	Windows Server® 2003/2008	Mac OS X 10.4.11 - 10.5.x - 10.6.x
Printing	✓	✓	✓
Scanning <i>See Software User's Guide.</i>	✓		✓
PC Fax Send ¹ <i>See Software User's Guide.</i>	✓		✓
PC Fax Receive ¹ <i>See Software User's Guide.</i>	✓		
Network Photo Capture ² <i>See Software User's Guide.</i>	✓		✓
BRAdmin Light <i>See page 4.</i>	✓	✓	✓
BRAdmin Professional 3 ³ <i>See page 7.</i>	✓	✓	
Remote Setup <i>See Software User's Guide.</i>	✓		✓
Status Monitor <i>See Software User's Guide.</i>	✓		✓
Driver Deployment Wizard	✓	✓	
Vertical Pairing <i>See Network Glossary.</i>	✓ ⁴		

¹ Black and White only. Not available for DCP models.

² Not available for MFC-J280W/J430W/J432W.

³ BRAdmin Professional 3 is available as a download from <http://solutions.brother.com/>.

⁴ Windows® 7 only.

Other Network features

Brother Web Connect (MFC-J825DW/J835DW USA only)

Brother Web Connect allows you to download and print images and also to upload files by accessing services on the internet directly from your machine. For details, please refer to the *Web Connect Guide* located on the Manual download page for your model on the Brother Solutions Center (<http://solutions.brother.com/>).

How to change your machine's network settings (IP address, Subnet mask and Gateway)

Using the control panel

You can configure your machine for a network using the control panel `Network` menu. (See *Control panel setup* >> page 34.)

Using the BRAdmin Light utility

The BRAdmin Light utility is designed for initial setup of Brother network connected devices. It also can search for Brother products in a TCP/IP environment, view the status and configure basic network settings, such as IP address.

Installing BRAdmin Light

■ Windows®

- 1 Please make sure that your machine is ON.
- 2 Turn on your computer. Close any running applications before configuration.
- 3 Put the supplied CD-ROM into your CD-ROM drive. The opening screen will appear automatically. If the model name screen appears, choose your machine. If the language screen appears, choose your language.
- 4 The CD-ROM main menu will appear. Click **Advanced**, and then **Network Utilities**.
- 5 Click **BRAdmin Light** and follow the on-screen instructions.

■ Macintosh

The BRAdmin Light software will be installed automatically when you install the printer driver. If you have already installed the printer driver, you do not have to install BRAdmin Light again.

Setting the IP address, Subnet Mask and Gateway using BRAdmin Light

Note

- You can download the latest Brother BRAdmin Light utility version from <http://solutions.brother.com/>.
- If you require more advanced printer management, use the latest Brother BRAdmin Professional 3 utility that is available as a download from <http://solutions.brother.com/>. This utility is only available for Windows® users.
- If you are using a firewall function of anti-spyware or antivirus applications, temporarily disable them. Once you are sure that you can print, re-enable the application.
- Node Name: The Node Name appears in the current BRAdmin Light window. The default Node Name of the print server in the machine is "BRNxxxxxxxxxxxx" or "BRWxxxxxxxxxxxx". ("xxxxxxxxxxxx" is your machine's MAC Address / Ethernet Address.)

1 Start the BRAdmin Light utility.

- Windows®

Click **Start / All Programs / Brother / BRAdmin Light / BRAdmin Light**.

- Macintosh

Double-click **Macintosh HD (Startup Disk) / Library / Printers / Brother / Utilities / BRAdmin Light.jar** file.

2 BRAdmin Light will search for new devices automatically.

3 Double-click the unconfigured device.

Windows®

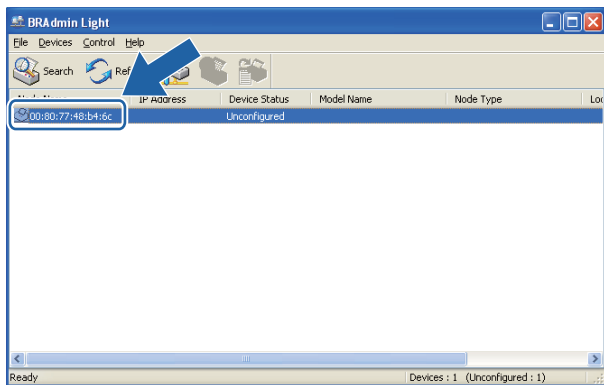

Macintosh

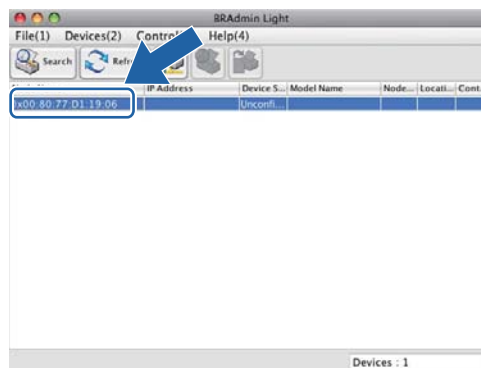



Note

- If the print server is set to its factory default settings (if you don't use a DHCP/BOOTP/RARP server), the device will appear as **Unconfigured** in the BRAdmin Light utility screen.
- You can find the Node Name and MAC Address (Ethernet Address) by printing the Network Configuration Report. (See *Printing the Network Configuration Report* >> page 39 for information on how to print the Network Configuration Report on your print server.) You can also find the Node Name and MAC Address from the control panel. (See *Control panel setup* >> page 34.)

- 4 Choose **STATIC** from **Boot Method**. Enter the **IP Address**, **Subnet Mask** and **Gateway** (if needed) of your print server.

Windows®

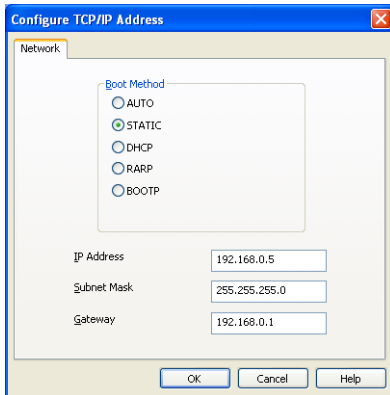

Macintosh

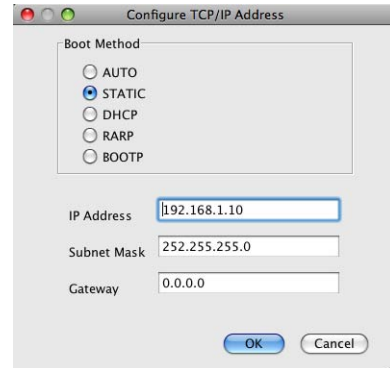

- 5 Click **OK**.
- 6 With the correctly programmed IP address, you will see the Brother print server in the device list.

Other Management Utilities

Your Brother machine has the following management utilities in addition to the BRAdmin Light utility. You can change your network settings using these utilities.

2

BRAdmin Professional 3 utility (Windows®)

BRAdmin Professional 3 is a utility for a more advanced management of network connected Brother devices. This utility can search for Brother products on your network and view the device status from an easy to read Explorer style window that changes color identifying the status of each device. You can configure network and device settings along with the ability to update device firmware from a Windows® computer on your LAN. BRAdmin Professional 3 can also log activity of Brother devices on your network and export the log data in an HTML, CSV, TXT or SQL format.

For more information and downloading, visit us at <http://solutions.brother.com/>.



Note

- Please use the latest version of the BRAdmin Professional 3 utility that is available as a download from <http://solutions.brother.com/>. This utility is only available for Windows® users.
 - If you are using a firewall function of anti-spyware or antivirus applications, temporarily disable them. Once you are sure that you can print, re-enable the application.
 - Node name: The node name appears in the current BRAdmin Professional 3 window. The default Node name is "BRNxxxxxxxxxxxx" or "BRWxxxxxxxxxxxx". ("xxxxxxxxxxxx" is your MAC Address / Ethernet Address.)
-

Overview

To connect your machine to your wireless network, you need to follow the steps in the *Quick Setup Guide*. Configuration using the CD-ROM installer and a USB cable is a recommended way for Windows® users. By using this method, you can easily connect your machine to your wireless network. Macintosh users should choose their preferred configuration method from the choices covered in the *Quick Setup Guide*.

For additional wireless configuration methods please read this chapter for more details on how to configure the wireless network settings. For information on TCP/IP settings, see *How to change your machine's network settings (IP address, Subnet mask and Gateway)* >> page 4.



Note

- To achieve optimum results with normal every day document printing, place the Brother machine as close to the WLAN access point/router as possible with minimal obstructions. Large objects and walls between the two devices as well as interference from other electronic devices can affect the data transfer speed of your documents.

Due to these factors, wireless may not be the best method of connection for all types of documents and applications. If you are printing large files, such as multi-page documents with mixed text and large graphics, you may want to consider choosing wired Ethernet for a faster data transfer¹, or USB for the fastest throughput speed.

- Although the Brother machine can be used in both a wired¹ and wireless network, only one connection method can be used at a time.
- Before configuring wireless settings, you will need to know your SSID and Network Key.

¹ A wired network interface is available on the MFC-J825DW/J835DW and DCP-J925DW.

Confirm your network environment

Connected to a computer with a WLAN access point/router in the network (Infrastructure mode)

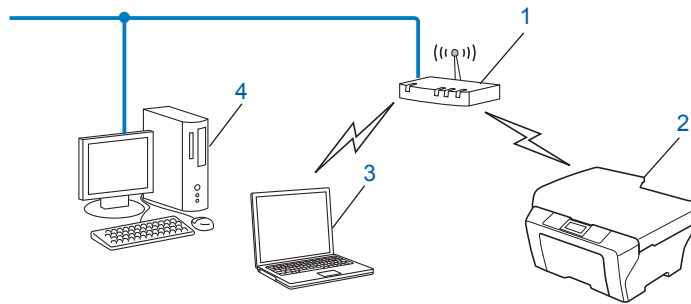

1 WLAN access point/router ¹

¹ If your computer supports Intel® My WiFi Technology (Intel® MWT), you can use your computer as a Wi-Fi Protected Setup supported access point.

2 Wireless network machine (your machine)

3 Wireless capable computer connected to the WLAN access point/router

4 Wired computer (which is not wireless capable) connected to the WLAN access point/router with an Ethernet cable

Install method

The following instructions will offer four methods for installing your Brother machine in a wireless network environment. Choose the method you prefer for your environment.

- Wireless configuration temporarily using a USB cable (Recommended for Windows® users)
See *Wireless configuration temporarily using a USB cable* >> page 11.
- Wireless configuration temporarily using an Ethernet cable
See *Wireless configuration temporarily using an Ethernet cable (For MFC-J825DW/J835DW and DCP-J925DW)* >> page 14.
- One push wireless configuration using WPS or AOSS™
See *One push configuration using Wi-Fi Protected Setup or AOSS™* >> page 17.
- Wireless configuration using the Setup Wizard from the control panel
See *Configuration using the machine's control panel Setup Wizard* >> page 23.

Connected to a wireless capable computer without a WLAN access point/router in the network (Ad-hoc mode)

This type of network does not have a central WLAN access point/router. Each wireless client communicates directly with each other. When the Brother wireless machine (your machine) is part of this network, it receives all print jobs directly from the computer sending the print data.

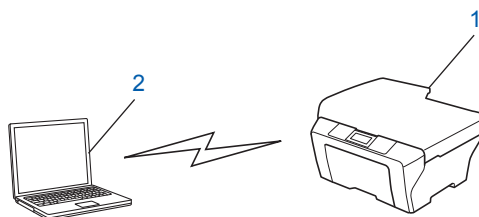

1 Wireless network machine (your machine)

2 Wireless capable computer

We do not guarantee the wireless network connection with Windows Server® products in Ad-hoc mode. To set up your machine in Ad-hoc mode, see *Configuration in Ad-hoc Mode* >> page 30.

Wireless configuration temporarily using a USB cable

It is recommended that you use a PC wirelessly connected to your network for this method.

You can remotely configure the machine from the computer on the network using a USB cable (A) ¹.

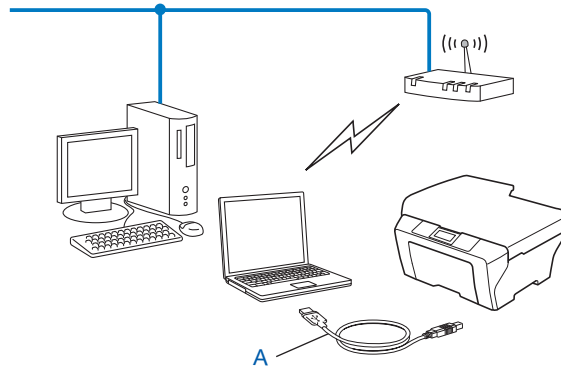

¹ You can configure the wireless settings of the machine using a USB cable temporarily connected to a wired or wireless computer.

For Windows[®] users (Recommended)

! IMPORTANT

- You need to temporarily use a USB cable during configuration (cable not included).
- If you are using Windows[®] XP, or using a network cable to configure your machine to connect with your wireless access point/router, you need to know the SSID and Network Key of your access point/router. Write them down in the area below, as they are required when configuring the machine's wireless settings.

Item	Record the current wireless network settings
SSID (Network Name):	
Network Key	

- 1 Turn on your computer.
- 2 Start the Brother installer application.
 - 1 Put the supplied CD-ROM into your CD-ROM drive. The opening screen will appear automatically. If the model name screen appears, choose your machine. If the language screen appears, choose your language.
 - 2 The CD-ROM main menu will appear.

Note

- If the Brother screen does not appear automatically, go to **My Computer (Computer)**, double-click the CD-ROM icon, and then double-click **start.exe**.
- The screen on your machine may vary depending on your region.

- 3 Click **Install MFL-Pro Suite** and click Yes if you accept the license agreements. Follow the on-screen instructions.
- 3 Choose **Wireless Network Connection**, and then click **Next**.
- 4 Choose **Change the Firewall port settings to enable network connection and continue with the installation. (Recommended)** and click **Next**.
- 5 Choose **Use your computer or the control panel directly.** and click **Next**.
- 6 Choose **Temporarily use a USB cable (Recommended)** and click **Next**.
- 7 Follow the on-screen instructions to configure the wireless settings.



Note

When the **Available Wireless Networks** screen appears, if your access point is set to not broadcast the SSID you can manually add it by clicking the **Advanced** button. Follow the on-screen instructions for entering the **Name (SSID)**.



(Windows®)

You have completed the wireless network setup. If you would like to continue installing drivers and software necessary for operating your device, please choose Install MFL-Pro Suite from the CD-ROM menu.

For Macintosh users

! IMPORTANT

- The following instructions will install your Brother machine in a network environment using the Brother installer application found on the CD-ROM we have provided with the machine.
- If you have previously configured the wireless settings of the machine, you must reset the LAN settings before you can configure the wireless settings again.
To reset the LAN settings, see *Restoring the network settings to factory default* ►► page 38.
- If you are using a firewall function of anti-spyware or antivirus applications, temporarily disable them. Once you are sure that you can print please re-enable your firewall.
- You need to temporarily use a USB cable (not included) during configuration.
- **You must know your wireless network settings before you proceed with this installation.**
If you are going to connect your Brother machine to your network, we recommend that you contact your system administrator prior to installation.
- If your router uses WEP encryption, enter the key used as the first WEP key. Your Brother machine supports the use of the first WEP key only.

- 1 Before configuring your machine we recommend you write down the SSID and Network Key (if required) for your wireless network. You will need this information before you continue with the configuration.

Item	Record the current wireless network settings
SSID (Network Name):	
Network Key	

- 2 Turn on your computer.
- 3 Start the Brother installer application.
 - 1 Put the supplied CD-ROM into your CD-ROM drive. Double-click the **MFL_PRO Suite** icon on your desktop.
 - 2 Double-click **Utilities**.
 - 3 Double-click the **Wireless Device Setup Wizard**.
- 4 Choose **Use your computer or the control panel directly**, and then click **Next**.
- 5 Read the **Important Notice**. Check the box after you confirm the SSID and Network Key, and then click **Next**.
- 6 Choose **Temporarily use a USB cable (Recommended)** and then click **Next**.
- 7 Follow the on-screen instructions to configure the wireless settings.



Note

When the **Available Wireless Networks** screen appears, if your access point is set to not broadcast the SSID you can manually add it by clicking the **Advanced** button. Follow the on-screen instructions for entering the **Name (SSID)**.



(Macintosh)

You have completed the wireless network setup. If you would like to continue installing drivers and software necessary for operating your device, please double-click Start Here OSX in the CD-ROM.



Note

If your wireless settings fail, the Wireless Device Setup Wizard will appear during the installation of MFL-Pro Suite. Confirm your settings by following the on-screen instructions.

Wireless configuration temporarily using an Ethernet cable (For MFC-J825DW/J835DW and DCP-J925DW)

If there is an Ethernet Hub or Router in the same network as the WLAN access point (A) of your machine, you can temporarily connect the Hub or Router to the machine using a network cable (B). You can then remotely configure the machine from a computer on the network.

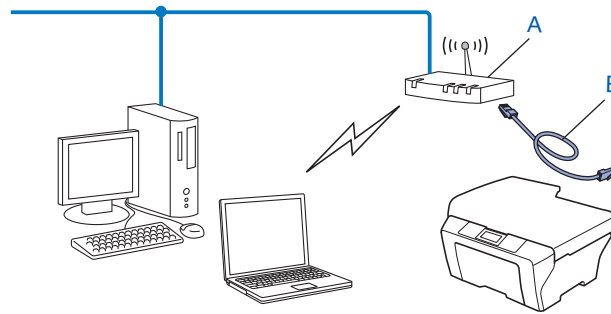

! IMPORTANT

- The following instructions will install your Brother machine in a network environment using the Brother installer application found on the CD-ROM we have provided with the machine.
- If you have previously configured the wireless settings of the machine, you must reset the LAN settings before you can configure the wireless settings again.
To reset the LAN settings, see *Restoring the network settings to factory default* >> page 38.
- If you are using a firewall function of anti-spyware or antivirus applications, temporarily disable them. Once you are sure that you can print please re-enable your firewall.
- You need to temporarily use an Ethernet cable (not included) during configuration.
- **You must know your wireless network settings before you proceed with this installation.**
If you are going to connect your Brother machine to your network, we recommend that you contact your system administrator prior to installation.
- If your router uses WEP encryption, enter the key used as the first WEP key. Your Brother machine supports the use of the first WEP key only.

- 1 Before configuring your machine we recommend you write down the SSID and Network Key (if required) for your wireless network. You will need this information before you continue with the configuration.

Item	Record the current wireless network settings
SSID (Network Name):	
Network Key	

- 2 Turn on your computer.

3 Start the Brother installer application.

■ **Windows®**

- 1 Put the supplied CD-ROM into your CD-ROM drive. The opening screen will appear automatically. If the model name screen appears, choose your machine. If the language screen appears, choose your language.
- 2 The CD-ROM main menu will appear. Click **Advanced**.



Note

- If the Brother screen does not appear automatically, go to **My Computer (Computer)**, double-click the CD-ROM icon, and then double-click **start.exe**.
- The screen on your machine may vary depending on your region.

3 Click **Wireless LAN Setup Wizard**.

■ **Macintosh**

- 1 Put the supplied CD-ROM into your CD-ROM drive. Double-click the **MFL_PRO Suite** icon on your desktop.
- 2 Double-click **Utilities**.
- 3 Double-click the **Wireless Device Setup Wizard**.

4 Choose **Use your computer or the control panel directly**. and then click **Next**.

5 Choose **Temporarily use an Ethernet (LAN) cable** and then click **Next**.
When the **Important Notice** screen appears, read the notice, check the box after you confirm the wireless setting is enabled and then click **Next**.

6 Follow the on-screen instructions to configure the wireless settings.



Note

When the **Available Wireless Networks** screen appears, if your access point is set to not broadcast the SSID you can manually add it by clicking the **Advanced** button. Follow the on-screen instructions for entering the **Name (SSID)**.



(Windows®)

You have completed the wireless network setup. If you would like to continue installing drivers and software necessary for operating your device, please choose Install MFL-Pro Suite from the CD-ROM menu.

(Macintosh)

You have completed the wireless network setup. If you would like to continue installing drivers and software necessary for operating your device, please double-click Start Here OSX in the CD-ROM.



Note

If your wireless settings fail, the Wireless Device Setup Wizard will appear during the installation of MFL-Pro Suite. Confirm your settings by following the on-screen instructions.

One push configuration using Wi-Fi Protected Setup or AOSS™

You can use WPS or AOSS™ from the control panel menu to configure your wireless network settings if your WLAN access point/router (A) supports either Wi-Fi Protected Setup (PBC¹) or AOSS™.

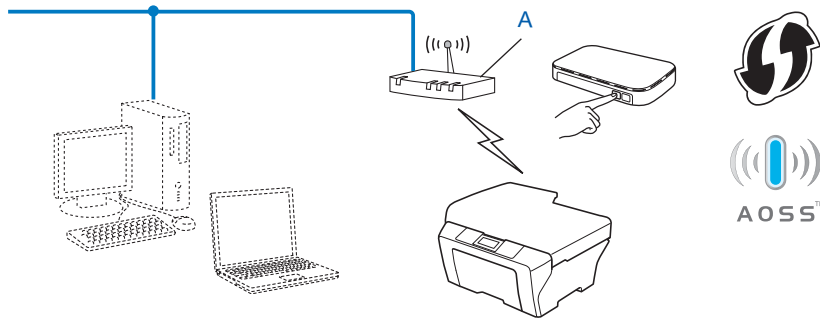

¹ Push Button Configuration

! IMPORTANT

- If you are going to connect your Brother machine to your network, we recommend that you contact your system administrator prior to installation. **You must know your wireless network settings before you proceed with this installation.**
- If you have previously configured the wireless settings of the machine, you must reset the LAN settings before you can configure the wireless settings again.

To reset the LAN settings, see *Restoring the network settings to factory default* ►► page 38.

One-push configuration using WPS (Wi-Fi Protected Setup) or AOSS™

For MFC-J430W/J432W

- 1 Press **Menu**.
- 2 Press **▲** or **▼** to choose `Network`.
Press **OK**.
- 3 Press **▲** or **▼** to choose `WPS/AOSS`.
Press **OK**.
- 4 When `Enable WLAN?` is displayed, press **OK** to accept.
This will start the wireless setup wizard.
To cancel, press **Stop/Exit**.

- 5 When the LCD shows `Start WPS` or `AOSS`, press the WPS or AOSS™ button on your wireless access point/router. See the user's guide for your wireless access point/router for instructions. Then press **OK** and your machine will now automatically detect which mode (WPS or AOSS™) your wireless access point/router uses and try to connect to your wireless network.
- 6 A connection result message appears for 60 seconds on the LCD and a wireless LAN report will automatically be printed. If the connection failed, check the error code on the printed report.
➤➤Quick Setup Guide: *Troubleshooting*



(Windows®)

You have completed the wireless network setup. If you would like to continue installing drivers and software necessary for operating your device, please choose Install MFL-Pro Suite from the CD-ROM menu.

(Macintosh)

You have completed the wireless network setup. If you would like to continue installing drivers and software necessary for operating your device, please double-click Start Here OSX in the CD-ROM.

For MFC-J280W/J625DW/J825DW/J835DW and DCP-J725DW/J925DW

- 1 Press `Menu`.
- 2 Press `Network`.
- 3 (MFC-J825DW/J835DW and DCP-J925DW only)
Press `WLAN`.
- 4 Press **▲** or **▼** to display `WPS/AOSS`, and press `WPS/AOSS`.
- 5 When `Enable WLAN?` or `Switch Network interface to wireless?` is displayed, press **Yes** to accept.
This will start the wireless setup wizard.
To cancel, press **Stop/Exit**.
- 6 When the LCD shows `Start WPS` or `AOSS`, press the WPS or AOSS™ button on your wireless access point/router. See the user's guide for your wireless access point/router for instructions. Then press **OK** and your machine will now automatically detect which mode (WPS or AOSS™) your wireless access point/router uses and try to connect to your wireless network.
- 7 A connection result message appears for 60 seconds on the LCD and a wireless LAN report will automatically be printed. If the connection failed, check the error code on the printed report.
➤➤Quick Setup Guide: *Troubleshooting*



(Windows®)

You have completed the wireless network setup. If you would like to continue installing drivers and software necessary for operating your device, please choose Install MFL-Pro Suite from the CD-ROM menu.

(Macintosh)

You have completed the wireless network setup. If you would like to continue installing drivers and software necessary for operating your device, please double-click Start Here OSX in the CD-ROM.

Configuration using the PIN Method of Wi-Fi Protected Setup

If your WLAN access point/router (A) supports Wi-Fi Protected Setup, you can also configure using the PIN Method of Wi-Fi Protected Setup. The PIN (Personal Identification Number) Method is one of the connection methods developed by the Wi-Fi Alliance®. By inputting a PIN which is created by an Enrollee (your machine) to the Registrar (a device that manages the wireless LAN), you can setup the wireless network and security settings. See the user's guide for your WLAN access point/router for instructions on how to access the Wi-Fi Protected Setup mode.

- Connection when the WLAN access point/router (A) doubles as a Registrar ¹.

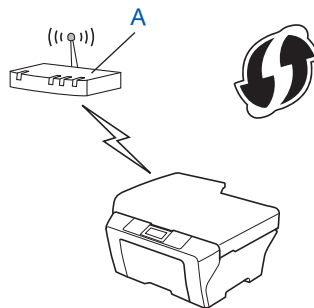

- Connection when another device (C), such as a computer is used as a Registrar ¹.

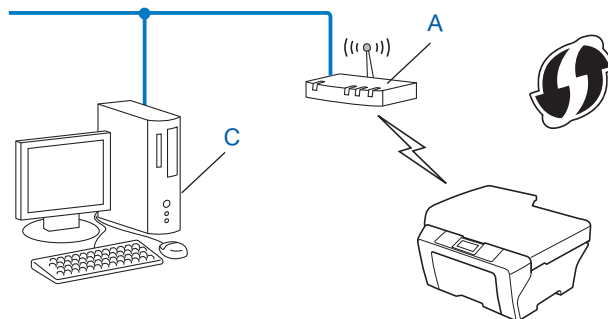

¹ The Registrar is a device that manages the wireless LAN.

 **Note**

Routers or access points that support Wi-Fi Protected Setup have a symbol as shown below.

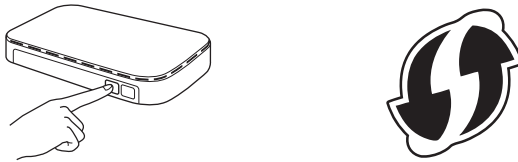

For MFC-J430W/J432W

- 1 Press **Menu**.
- 2 Press **▲** or **▼** to choose **Network**. Press **OK**.
- 3 Press **▲** or **▼** to choose **WPS w/PIN Code**. Press **OK**.
- 4 When **Enable WLAN?** is displayed, press **OK** to accept. This will start the wireless setup wizard. To cancel, press **Stop/Exit**.
- 5 The LCD will show an 8 digit PIN and the machine begins searching for a WLAN access point/router for up to 5 minutes.
- 6 Using a computer that is on the network, type “http://access point’s IP address/” into your browser. (Where “access point’s IP address” is the IP address of the device that is used as the Registrar ¹.) Go to the WPS (Wi-Fi Protected Setup) setting page and input the PIN which the LCD shows in 5 to the Registrar and follow the on-screen instructions.

¹ The Registrar is normally the WLAN access point/router.



 **Note**

The setting page is different, depending on the brand of WLAN access point/router. See the instruction manual that came with your WLAN access point/router.

If you are using your Windows Vista[®] or Windows[®] 7 computer as a Registrar, perform the following instructions.

 **Note**

To use a Windows Vista[®] or Windows[®] 7 computer as a Registrar, you need to register it to your network in advance. See the instruction manual that came with your WLAN access point/router.

- 1 (Windows Vista®)
Click , **Network**, and then **Add a wireless device**.
(Windows® 7)
Click , **Control Panel, Network and Internet**, and then **Add a wireless device to the network**.
- 2 Choose your machine and click **Next**.
- 3 Input the PIN from the printed page and then click **Next**.
- 4 Choose your network that you want to connect to, and then click **Next**.
- 5 Click **Close**.

- 7 A connection result message appears for 60 seconds on the LCD and a wireless LAN report will automatically be printed. If the connection failed, check the error code on the printed report.
➤➤Quick Setup Guide: *Troubleshooting*

-  **(Windows®)**
You have completed the wireless network setup. If you would like to continue installing drivers and software necessary for operating your device, please choose Install MFL-Pro Suite from the CD-ROM menu.
- (Macintosh)**
You have completed the wireless network setup. If you would like to continue installing drivers and software necessary for operating your device, please double-click Start Here OSX in the CD-ROM.

For MFC-J280W/J625DW/J825DW/J835DW and DCP-J725DW/J925DW

- 1 Press **Menu**.
- 2 Press **Network**.
- 3 (MFC-J825DW/J835DW and DCP-J925DW only)
Press **WLAN**.
- 4 Press **▲** or **▼** to display **WPS w/PIN Code**, and press **WPS w/PIN Code**.
- 5 When **Enable WLAN?** or **Switch Network interface to wireless?** is displayed, press **Yes** to accept.
This will start the wireless setup wizard.
To cancel, press **Stop/Exit**.
- 6 The LCD will show an 8 digit PIN and the machine starts searching for a WLAN access point/router for 5 minutes.

- 7 Using a computer that is on the network, type “http://access point’s IP address/” into your browser. (Where “access point’s IP address” is the IP address of the device that is used as the Registrar ¹.) Go to the WPS (Wi-Fi Protected Setup) setting page and input the PIN which the LCD shows in 6 to the Registrar and follow the on-screen instructions.

¹ The Registrar is normally the WLAN access point/router.



Note



The setting page is different, depending on the brand of WLAN access point/router. See the instruction manual that came with your WLAN access point/router.

If you are using your Windows Vista[®] or Windows[®] 7 computer as a Registrar, perform the following instructions.



Note

To use a Windows Vista[®] or Windows[®] 7 computer as a Registrar, you need to register it to your network in advance. See the instruction manual that came with your WLAN access point/router.

- 1 (Windows Vista[®])
Click , **Network**, and then **Add a wireless device**.
(Windows[®] 7)
Click , **Control Panel**, **Network and Internet**, and then **Add a wireless device to the network**.
- 2 Choose your machine and click **Next**.
- 3 Input the PIN from the printed page and then click **Next**.
- 4 Choose your network that you want to connect to, and then click **Next**.
- 5 Click **Close**.

- 8 A connection result message appears for 60 seconds on the LCD and a wireless LAN report will automatically be printed. If the connection failed, check the error code on the printed report.
➤➤Quick Setup Guide: *Troubleshooting*



(Windows[®])

You have completed the wireless network setup. If you would like to continue installing drivers and software necessary for operating your device, please choose Install MFL-Pro Suite from the CD-ROM menu.

(Macintosh)

You have completed the wireless network setup. If you would like to continue installing drivers and software necessary for operating your device, please double-click Start Here OSX in the CD-ROM.

Configuration using the machine's control panel Setup Wizard

You can use the machine's control panel to configure your wireless network settings. By using the control panel `Setup Wizard` function, you can easily connect your Brother machine to your wireless network. **You must know your wireless network settings before you proceed with this installation.**

! IMPORTANT

If you have previously configured the wireless settings of the machine, you must reset the LAN settings before you can configure the wireless settings again.

To reset the LAN settings, see *Restoring the network settings to factory default* >> page 38.

Manual configuration from the control panel

For MFC-J430W/J432W

- 1 Before configuring your machine we recommend you write down your wireless network settings. You will need this information before you continue with the configuration.

Item	Record the current wireless network settings
SSID (Network Name):	
Network Key	

- 2 Press **Menu**.
- 3 Press **▲** or **▼** to choose `Network`.
Press **OK**.
- 4 Press **▲** or **▼** to choose `Setup Wizard`.
Press **OK**.
- 5 When `Enable WLAN?` is displayed, press **OK** to accept.
This will start the wireless setup wizard.
To cancel, press **Stop/Exit**.
- 6 The machine will search for your network and display a list of available SSIDs.
If a list of SSIDs is displayed, press **▲** or **▼** to choose the SSID you wrote down in step 1. Select the SSID you want to connect with.
Press **OK**.
If the wireless access point/router of the selected SSID supports WPS and the machine asks to use WPS, go to 7.
If the machine asks you to enter a Network Key, go to 8.
Otherwise, go to 9.



Note

When the SSID is not broadcast, see *Configuring your machine when the SSID is not broadcast* >> page 26.

- 7 Press **1** for **Yes** to connect to your machine using WPS. (If you press **2** for **No** to continue manual setting, go to 8 to enter a Network Key.)
When the LCD shows **Start WPS**, press the WPS button on your wireless access point/router, and then press **1** for **Yes** to proceed. Go to 9.
- 8 Enter the Network Key you wrote down in step 1.
Press **OK** when you have entered all the characters, then press **1** for **Yes** to apply your settings.
- 9 The machine starts to connect to the wireless device you have chosen.
- 10 A connection result message appears for 60 seconds on the LCD and a wireless LAN report will automatically be printed. If the connection failed, check the error code on the printed report.
>>Quick Setup Guide: *Troubleshooting*



(Windows®)

You have completed the wireless network setup. If you would like to continue installing drivers and software necessary for operating your device, please choose Install MFL-Pro Suite from the CD-ROM menu.

(Macintosh)

You have completed the wireless network setup. If you would like to continue installing drivers and software necessary for operating your device, please double-click Start Here OSX in the CD-ROM.

For MFC-J280W/J625DW/J825DW/J835DW and DCP-J725DW/J925DW

- 1 Before configuring your machine we recommend you write down your wireless network settings. You will need this information before you continue with the configuration.

Item	Record the current wireless network settings
SSID (Network Name):	
Network Key	

- 2 Press **Menu**.
- 3 Press **Network**.
- 4 (MFC-J825DW/J835DW and DCP-J925DW only)
Press **WLAN**.
- 5 Press **Setup Wizard**.

- 6 When `Enable WLAN?` or `Switch Network interface to wireless?` is displayed, press `Yes` to accept.
This will start the wireless setup wizard.
To cancel, press **Stop/Exit**.
- 7 The machine will search for your network and display a list of available SSIDs.
If a list of SSIDs is displayed, press `▲` or `▼` to choose the SSID you wrote down in step 1. Select the SSID you want to connect with.
If the wireless access point/router of the selected SSID supports WPS and the machine asks to use WPS, go to 8.
If the machine asks you to enter a Network Key, go to 9.
Otherwise, go to 10.



Note

When the SSID is not broadcast, see *Configuring your machine when the SSID is not broadcast* >> page 26.

- 8 Press `Yes` to connect to your machine using WPS. (If you choose `No (Manual)` to continue manual setting, go to 9 to enter a Network Key.)
When the LCD shows `Start WPS`, press the WPS button on your wireless access point/router, and then press `Next` to proceed. Go to 10.
- 9 Enter the Network Key you wrote down in step 1.
Press `OK` when you have entered all the characters, then press `Yes` to apply your settings.
- 10 The machine starts to connect to the wireless device you have chosen.
- 11 A connection result message appears for 60 seconds on the LCD and a wireless LAN report will automatically be printed. If the connection failed, check the error code on the printed report.
>>Quick Setup Guide: *Troubleshooting*



(Windows®)

You have completed the wireless network setup. If you would like to continue installing drivers and software necessary for operating your device, please choose Install MFL-Pro Suite from the CD-ROM menu.

(Macintosh)

You have completed the wireless network setup. If you would like to continue installing drivers and software necessary for operating your device, please double-click Start Here OSX in the CD-ROM.

Configuring your machine when the SSID is not broadcast

For MFC-J430W/J432W

- 1 Before configuring your machine we recommend you write down your wireless network settings. You will need this information before you continue with the configuration.

Check and record the current wireless network settings.

SSID (Network Name):

Communication Mode	Authentication method	Encryption mode	Network key
Infrastructure	Open system	WEP	
		NONE	—
	Shared key	WEP	
		WPA/WPA2-PSK	AES
		TKIP ¹	

¹ TKIP is supported for WPA-PSK only.

For example:

SSID (Network Name):
HELLO

Communication Mode	Authentication method	Encryption mode	Network key
Infrastructure	WPA2-PSK	AES	12345678



Note

If your router uses WEP encryption, enter the key used as the first WEP key. Your Brother machine supports the use of the first WEP key only.

- 2 Press **Menu**.
- 3 Press **▲** or **▼** to choose **Network**. Press **OK**.
- 4 Press **▲** or **▼** to choose **Setup Wizard**. Press **OK**.
- 5 When **Enable WLAN?** is displayed, press **OK** to accept. This will start the wireless setup wizard. To cancel, press **Stop/Exit**.

- 6 The machine will search for your network and display a list of available SSIDs. Choose <New SSID> using ▲ or ▼. Press **OK**.
- 7 Enter the SSID name. (For information on how to enter text, see the *Quick Setup Guide*.) Press **OK**.
- 8 Using ▲ or ▼, choose *Infrastructure* when instructed. Press **OK**.
- 9 Choose the Authentication method using ▲ or ▼, and press **OK**. Do one of the following:
 - If you chose *Open System*, go to step 10.
 - If you chose *Shared Key*, go to step 11.
 - If you chose *WPA/WPA2-PSK*, go to step 12.
- 10 Choose the Encryption type *None* or *WEP* using ▲ or ▼, and press **OK**. Do one of the following:
 - If you chose *None*, go to step 14.
 - If you chose *WEP*, go to step 11.
- 11 Enter the WEP key you wrote down in step 1 on page 26. Press **OK**. Go to step 14. (For information on how to enter text, see the *Quick Setup Guide*.)
- 12 Choose the Encryption type, *TKIP* or *AES* using ▲ or ▼. Press **OK**. Go to step 13.
- 13 Enter the WPA key you wrote down in step 1 on page 26 and press **OK**. Go to step 14. (For information on how to enter text, see the *Quick Setup Guide*.)
- 14 To apply the settings, press **1** for *Yes*. To cancel, press **2** for *No*. Do one of the following:
 - If you chose *Yes*, go to step 15.
 - If you chose *No*, go back to step 6.
- 15 The machine starts to connect to the wireless device you have chosen.
- 16 A connection result message appears for 60 seconds on the LCD and a wireless LAN report will automatically be printed. If the connection failed, check the error code on the printed report.
➤➤Quick Setup Guide: *Troubleshooting*



(Windows®)

You have completed the wireless network setup. If you would like to continue installing drivers and software necessary for operating your device, please choose Install MFL-Pro Suite from the CD-ROM menu.

(Macintosh)

You have completed the wireless network setup. If you would like to continue installing drivers and software necessary for operating your device, please double-click Start Here OSX in the CD-ROM.

For MFC-J280W/J625DW/J825DW/J835DW and DCP-J725DW/J925DW

- 1 Before configuring your machine we recommend you write down your wireless network settings. You will need this information before you continue with the configuration.

Check and record the current wireless network settings.

SSID (Network Name):

Communication Mode	Authentication method	Encryption mode	Network key
Infrastructure	Open system	WEP	
		NONE	—
	Shared key	WEP	
		WPA/WPA2-PSK	AES
		TKIP ¹	

¹ TKIP is supported for WPA-PSK only.

For example:

SSID (Network Name):
HELLO

Communication Mode	Authentication method	Encryption mode	Network key
Infrastructure	WPA2-PSK	AES	12345678



Note

If your router uses WEP encryption, enter the key used as the first WEP key. Your Brother machine supports the use of the first WEP key only.

- 2 Press **Menu**.
- 3 Press **Network**.
- 4 (MFC-J825DW/J835DW and DCP-J925DW only)
Press **WLAN**.
- 5 Press **Setup Wizard**.
- 6 When **Enable WLAN?** or **Switch Network interface to wireless?** is displayed, press **Yes** to accept.
This will start the wireless setup wizard.
To cancel, press **Stop/Exit**.
- 7 The machine will search for your network and display a list of available SSIDs. Press **▲** or **▼** to display **<New SSID>**, and press **<New SSID>**.

- 8 Enter the SSID name. (For information on how to enter text, see the *Quick Setup Guide*.) Press **OK**.
- 9 Press **Infrastructure** when instructed.
- 10 Choose and press the Authentication method.
Do one of the following:
If you chose **Open System**, go to step 11.
If you chose **Shared Key**, go to step 12.
If you chose **WPA/WPA2-PSK**, go to step 13.
- 11 Choose and press the Encryption type **None** or **WEP**.
Do one of the following:
If you chose **None**, go to step 15.
If you chose **WEP**, go to step 12.
- 12 Enter the WEP key you wrote down in step 1 on page 28. Press **OK**. Go to step 15. (For information on how to enter text, see the *Quick Setup Guide*.)
- 13 Choose and press the Encryption type, **TKIP** or **AES**. Go to step 14.
- 14 Enter the WPA key you wrote down in step 1 on page 28 and press **OK**. Go to step 15. (For information on how to enter text, see the *Quick Setup Guide*.)
- 15 To apply the settings, press **Yes**. To cancel, press **No**.
Do one of the following:
If you chose **Yes**, go to step 16.
If you chose **No**, go back to step 7.
- 16 The machine starts to connect to the wireless device you have chosen.
- 17 A connection result message appears for 60 seconds on the LCD and a wireless LAN report will automatically be printed. If the connection failed, check the error code on the printed report.
➤➤Quick Setup Guide: *Troubleshooting*



(Windows®)

You have completed the wireless network setup. If you would like to continue installing drivers and software necessary for operating your device, please choose Install MFL-Pro Suite from the CD-ROM menu.

(Macintosh)

You have completed the wireless network setup. If you would like to continue installing drivers and software necessary for operating your device, please double-click Start Here OSX in the CD-ROM.

Configuration in Ad-hoc Mode

Configure the wireless settings

For MFC-J430W/J432W

- 1 Before configuring your machine we recommend you write down your wireless network settings. You will need this information before you continue with the configuration.

Check and record the current wireless network settings.



Note

The wireless network settings of the computer you are connecting with must be set to Ad-hoc mode with a SSID already configured. For instructions on how to configure your computer to Ad-hoc mode please see the information included with your computer or contact your network administrator.

SSID (Network Name):

Communication Mode	Encryption mode	Network key
Ad-hoc	WEP	
	NONE	—

For example:

SSID (Network Name):
HELLO

Communication Mode	Encryption mode	Network key
Ad-hoc	WEP	12345678

- 2 Press **Menu**.
- 3 Press **▲** or **▼** to choose `Network`. Press **OK**.
- 4 Press **▲** or **▼** to choose `Setup Wizard`. Press **OK**.
- 5 When `Enable WLAN?` is displayed, press **OK** to accept. This will start the wireless setup wizard. To cancel, press **Stop/Exit**.
- 6 The machine will search for your network and display a list of available SSIDs. Choose `<New SSID>` using **▲** or **▼**. Press **OK**.

- 7 Enter the SSID name. (For information on how to enter text, see the *Quick Setup Guide*.) Press **OK**.
- 8 Using **▲** or **▼**, choose *Ad-hoc* when instructed. Press **OK**.
- 9 Choose the Encryption type *None* or *WEP* using **▲** or **▼**, and press **OK**. Do one of the following:
If you chose *None*, go to step 11.
If you chose *WEP*, go to step 10.
- 10 Enter the WEP key you wrote down in step 1 on page 30. Press **OK**. Go to step 11. (For information on how to enter text, see the *Quick Setup Guide*.)
- 11 To apply the settings, press **1** for *Yes*. To cancel, press **2** for *No*. Do one of the following:
If you chose *Yes*, go to step 12.
If you chose *No*, go back to step 6.
- 12 The machine starts to connect to the wireless device you have chosen.
- 13 A connection result message appears for 60 seconds on the LCD and a wireless LAN report will automatically be printed. If the connection failed, check the error code on the printed report.
➤➤*Quick Setup Guide: Troubleshooting*

OK! **(Windows®)**
You have completed the wireless network setup. If you would like to continue installing drivers and software necessary for operating your device, please choose Install MFL-Pro Suite from the CD-ROM menu.

(Macintosh)
You have completed the wireless network setup. If you would like to continue installing drivers and software necessary for operating your device, please double-click Start Here OSX in the CD-ROM.

For MFC-J280W/J625DW/J825DW/J835DW and DCP-J725DW/J925DW

- 1 Before configuring your machine we recommend you write down your wireless network settings. You will need this information before you continue with the configuration.
Check and record the current wireless network settings.

 **Note**
The wireless network settings of the computer you are connecting with must be set to Ad-hoc mode with a SSID already configured. For instructions on how to configure your computer to Ad-hoc mode please see the information included with your computer or contact your network administrator.

SSID (Network Name):

Communication Mode	Encryption mode	Network key
Ad-hoc	WEP	
	NONE	—

For example:

SSID (Network Name):
HELLO

Communication Mode	Encryption mode	Network key
Ad-hoc	WEP	12345678

- 2 Press `Menu`.
- 3 Press `Network`.
- 4 (MFC-J825DW/J835DW and DCP-J925DW only)
Press `WLAN`.
- 5 Press `Setup Wizard`.
- 6 When `Enable WLAN?` or `Switch Network interface to wireless?` is displayed, press `Yes` to accept.
This will start the wireless setup wizard.
To cancel, press **Stop/Exit**.
- 7 The machine will search for your network and display a list of available SSIDs. Press `▲` or `▼` to display `<New SSID>`, and press `<New SSID>`.
- 8 Enter the SSID name. (For information on how to enter text, see the *Quick Setup Guide*.)
Press `OK`.
- 9 Press `Ad-hoc` when instructed.
- 10 Choose and press the Encryption type `None` or `WEP`.
Do one of the following:
If you chose `None`, go to step 12.
If you chose `WEP`, go to step 11.
- 11 Enter the WEP key you wrote down in step 1 on page 31. Press `OK`. Go to step 12. (For information on how to enter text, see the *Quick Setup Guide*.)
- 12 To apply the settings, press `Yes`. To cancel, press `No`.
Do one of the following:
If you chose `Yes`, go to step 13.
If you chose `No`, go back to step 7.

- 13 The machine starts to connect to the wireless device you have chosen.
- 14 A connection result message appears for 60 seconds on the LCD and a wireless LAN report will automatically be printed. If the connection failed, check the error code on the printed report.
➤➤Quick Setup Guide: *Troubleshooting*



(Windows®)

You have completed the wireless network setup. If you would like to continue installing drivers and software necessary for operating your device, please choose Install MFL-Pro Suite from the CD-ROM menu.

(Macintosh)

You have completed the wireless network setup. If you would like to continue installing drivers and software necessary for operating your device, please double-click Start Here OSX in the CD-ROM.

Network menu

The **Network** menu selections of the control panel allow you to set up the Brother machine for your network configuration. Press **Menu** or **Menu**, then press **▲** or **▼** to choose **Network**. Proceed to the menu selection you wish to configure. (See *Function table and default factory settings* >> page 41.)

Please note that the machine is supplied with the BRAdmin Light utility or Remote Setup applications, which also can be used to configure many aspects of the network. (See *Other Management Utilities* >> page 7.)

TCP/IP

For the MFC-J825DW/J835DW and DCP-J925DW, if you connect the machine with an Ethernet cable to your network, use the **Wired LAN** menu selections. If you connect the machine to a wireless Ethernet network, use the **WLAN** menu selections.

BOOT Method

This selection controls how the machine obtains an IP address.

Auto mode

In this mode the machine will scan the network for a DHCP server. If it can find one, and if the DHCP server is configured to allocate an IP address to the machine, then the IP address supplied by the DHCP server will be used. If no DHCP server is available, then the machine will scan for a BOOTP server. If a BOOTP server is available, and it is configured correctly, the machine will take its IP address from the BOOTP server. If a BOOTP server is not available, the machine will scan for a RARP server. If a RARP server also does not answer, the IP Address is set using the APIPA protocol. After the machine is initially powered ON, it may take a few minutes for the machine to scan the network for a server.

Static mode

In this mode the machine's IP address must be manually assigned. Once entered the IP address is locked to the assigned address.



Note

If you do not want your print server configured via DHCP, BOOTP or RARP, you must set the **BOOT Method** to **Static** so that the print server has a static IP address. This will prevent the print server from trying to obtain an IP address from any of these systems. To change the **BOOT Method**, use the machine's control panel, BRAdmin Light utility or Remote Setup.

IP Address

This field displays the current IP address of the machine. If you have chosen a `BOOT Method of Static`, enter the IP address that you wish to assign to the machine (check with your network administrator for a suitable IP address to use). If you have chosen a method other than `Static`, the machine will attempt to determine its IP address using the DHCP or BOOTP protocols. The default IP address of your machine will probably be incompatible with the IP address numbering scheme of your network. We recommend that you contact your network administrator for a suitable IP address for the network the unit will be connected on.

Subnet Mask

This field displays the current subnet mask used by the machine. If you are not using DHCP or BOOTP to obtain the subnet mask, enter the desired subnet mask. Check with your network administrator for the subnet mask to use.

Gateway

This field displays the current gateway or router address used by the machine. If you are not using DHCP or BOOTP to obtain the gateway or router address, enter the address you wish to assign. If you do not have a gateway or router, leave this field blank. Check with your network administrator if you are unsure.

Node Name

You can register the machine name on the Network. This name is often referred to as a NetBIOS name; it will be the name that is registered by the WINS server on your network. Brother recommends the name `BRNxxxxxxxxxxx` for a wired network or `BRWxxxxxxxxxxx` for a wireless network (where `xxxxxxxxxxx` is your machine's Ethernet address) (up to 15 characters).

WINS Config

This selection controls how the machine obtains the IP address of the WINS server.

Auto

Automatically uses a DHCP request to determine the IP addresses for the primary and secondary WINS servers. You must set the `BOOT Method to Auto` or `DHCP` for this feature to work.

Static

Uses a specified IP address for the primary and secondary WINS servers.

WINS Server

Primary WINS Server IP Address

This field specifies the IP address of the primary WINS (Windows[®] Internet Name Service) server. If set to a non-zero value, the machine will contact this server to register its name with the Windows[®] Internet Name Service.

Secondary WINS Server IP Address

This field specifies the IP address of the secondary WINS server. It is used as a backup to the Primary WINS server address. If the Primary server is unavailable, the machine can still register itself with a secondary server. If set to a non-zero value, the machine will contact this server to register its name with the Windows® Internet Name Service. If you have a primary WINS server, but no secondary WINS server, simply leave this field blank.

DNS Server

Primary DNS Server IP Address

This field specifies the IP address of the primary DNS (Domain Name System) server.

Secondary DNS Server IP Address

This field specifies the IP address of the secondary DNS server. It is used as a backup to the Primary DNS server address. If the Primary server is unavailable, the machine will contact the Secondary DNS server.

APIPA

The setting of `On` will cause the print server to automatically allocate a Link-Local IP address in the range (169.254.1.0 - 169.254.254.255) when the print server cannot obtain an IP address through the `BOOT Method` you have set (see *BOOT Method* >> page 34). Choosing `Off` means the IP address doesn't change, when the print server cannot obtain an IP address through the `BOOT Method` you have set.

Setup Wizard

The `Setup Wizard` guides you through the wireless network configuration. For more information, see the *Quick Setup Guide* or *Configuration using the machine's control panel Setup Wizard* >> page 23.

WPS/AOSS™

If your WLAN access point/router supports either Wi-Fi Protected Setup (PBC¹) or AOSS™, you can configure the machine easily without knowing your wireless network settings. (See the *Quick Setup Guide* or *One push configuration using Wi-Fi Protected Setup or AOSS™* >> page 17.)

¹ Push Button Configuration

WPS w/PIN Code

If your WLAN access point/router supports Wi-Fi Protected Setup (PIN Method), you can configure the machine easily without a computer. (See *Configuration using the PIN Method of Wi-Fi Protected Setup* >> page 19.)

WLAN Status

Status

This field displays the current wireless network status.

Signal

This field displays the current wireless network signal strength.

SSID

This field displays the current wireless network SSID. The display shows up to 32 characters of the SSID name.

Comm.Mode

This field displays the current wireless network communication mode.

Ethernet (For MFC-J825DW/J835DW and DCP-J925DW)

Ethernet link mode. Auto allows the print server to operate in 100BASE-TX full or half duplex, or in 10BASE-T full or half duplex mode by auto negotiation.



Note

If you set this value incorrectly, you may not be able to communicate with your print server.

MAC Address

The MAC address is a unique number assigned for the machine's network interface. You can check your machine's MAC address from the control panel.

Network I/F (For MFC-J825DW/J835DW and DCP-J925DW)

You can choose the network connection type, wired network connection or wireless network connection. If you want to use the wired network connection, choose `Wired LAN`, and if you want to use the wireless network connection, choose `WLAN`. You can only have one network connection type active at a time.

Restoring the network settings to factory default

You can reset the print server back to its default factory settings (resetting all information such as the password and IP address information).



Note

- For MFC-J825DW/J835DW and DCP-J925DW, this function restores all wired and wireless network settings to the factory default.
- You can also reset the print server back to its factory default settings using the BRAdmin applications. (For more information, see *Other Management Utilities* >> page 7.)

For MFC-J430W/J432W

- 1 Press **Menu**.
- 2 Press **▲** or **▼** to choose `Network`. Press **OK**.
- 3 Press **▲** or **▼** to choose `Network Reset`. Press **OK**.
- 4 Press **1** for `Reset`.
- 5 Press **1** for `Reboot`.
- 6 The machine will re-start.

For MFC-J280W/J625DW/J825DW/J835DW and DCP-J725DW/J925DW

- 1 Press `Menu`.
- 2 Press `Network`.
- 3 Press **▲** or **▼** to display `Network Reset` and then press `Network Reset`.
- 4 Press `Yes`.
- 5 Press `Yes` for 2 seconds to confirm.

Printing the Network Configuration Report



Note

Node Name: The Node Name appears in the Network Configuration Report. The default Node Name is “BRNxxxxxxxxxxxx” for a wired network or “BRWxxxxxxxxxxxx” for a wireless network (“xxxxxxxxxxxx” is your machine’s MAC Address / Ethernet Address).

The Network Configuration Report prints a report listing the current network configuration including the network print server settings.

For MFC-J430W/J432W

- 1 Press **Menu**.
- 2 Press **▲** or **▼** to choose `Print Reports`. Press **OK**.
- 3 Press **▲** or **▼** to choose `Network Config`. Press **OK**.
- 4 (For US) Press **Black Start** or **Color Start**.
(For UK) Press **Mono Start** or **Colour Start**.

For MFC-J280W/J625DW/J825DW/J835DW and DCP-J725DW/J925DW

- 1 Press `Menu`.
- 2 Press **▲** or **▼** to display `Print Reports` and then press `Print Reports`.
- 3 Press **▲** or **▼** to display `Network Config` and then press `Network Config`.
- 4 For MFC-J825DW/J835DW and DCP-J925DW
(For US) Press **Black Start** or **Color Start**.
(For UK) Press **Mono Start** or **Colour Start**.
For MFC-J280W/J625DW and DCP-J725DW, press `Start`.

Printing the WLAN Report

The `WLAN Report` prints your machine's wireless status report. If the wireless connection failed, check the error code on the printed report.

➤➤ Quick Setup Guide: *Troubleshooting*

For MFC-J430W/J432W

- 1 Press **Menu**.
- 2 Press **▲** or **▼** to choose `Print Reports`. Press **OK**.
- 3 Press **▲** or **▼** to choose `WLAN Report`. Press **OK**.
- 4 (For US) Press **Black Start** or **Color Start**.
(For UK) Press **Mono Start** or **Colour Start**.

For MFC-J280W/J625DW/J825DW/J835DW and DCP-J725DW/J925DW

- 1 Press `Menu`.
- 2 Press **▲** or **▼** to display `Print Reports` and then press `Print Reports`.
- 3 Press **▲** or **▼** to display `WLAN Report` and then press `WLAN Report`.
- 4 For MFC-J825DW/J835DW and DCP-J925DW
(For US) Press **Black Start** or **Color Start**.
(For UK) Press **Mono Start** or **Colour Start**.
For MFC-J280W/J625DW and DCP-J725DW, press `Start`.



Note

If the `WLAN Report` does not print, try starting step ❶ again after a while.

Function table and default factory settings

For MFC-J825DW/J835DW and DCP-J925DW

Main menu	Submenu	Menu Selections		Options
Network	Wired LAN	TCP/IP	BOOT Method	Auto/Static/RARP/BOOTP/DHCP
			IP Address	[000-255].[000-255]. [000-255].[000-255]. [000].[000].[000].[000] ¹
			Subnet Mask	[000-255].[000-255]. [000-255].[000-255]. [000].[000].[000].[000] ¹
			Gateway	[000-255].[000-255]. [000-255].[000-255]. [000].[000].[000].[000]
			Node Name	BRNXXXXXXXXXXXXX= (your machine's Ethernet address) (up to 15 characters)
			WINS Config	Auto/Static
			WINS Server	Primary/Secondary [000-255].[000-255]. [000-255].[000-255]. [000].[000].[000].[000]
			DNS Server	Primary/Secondary [000-255].[000-255]. [000-255].[000-255]. [000].[000].[000].[000]
		APIPA	On/Off	
		Ethernet		Auto/100B-FD/100B-HD/10B-FD/10B-HD
MAC Address				

Main menu	Submenu	Menu Selections		Options
Network (Continued)	WLAN	TCP/IP	BOOT Method	Auto/Static/RARP/BOOTP/DHCP
			IP Address	[000-255].[000-255]. [000-255].[000-255]. [000].[000].[000].[000] ¹
			Subnet Mask	[000-255].[000-255]. [000-255].[000-255]. [000].[000].[000].[000] ¹
			Gateway	[000-255].[000-255]. [000-255].[000-255]. [000].[000].[000].[000]
			Node Name	BRWXXXXXXXXXXXXX= (your machine's Ethernet address) (up to 15 characters)
			WINS Config	Auto/Static
			WINS Server	Primary/Secondary [000-255].[000-255]. [000-255].[000-255]. [000].[000].[000].[000]
			DNS Server	Primary/Secondary [000-255].[000-255]. [000-255].[000-255]. [000].[000].[000].[000]
			APIPA	On/Off
		Setup Wizard	—	(Choose SSID from list or manually add SSID)
		WPS/AOSS	—	
		WPS w/PIN Code	—	
		WLAN Status	Status	(Examples) Active (11b)/Active (11g)/Active (11n)/AOSS Active/Connection Fail
	Signal		Signal:Strong/Signal:Medium/ Signal:Weak/Signal:None	
	SSID		(Shows SSID with up to 32 digits)	
	Comm. Mode		Ad-hoc/Infrastructure	
	MAC Address			

Main menu	Submenu	Menu Selections		Options
Network (Continued)	Web Connect settings ² (MFC-J825DW/ J835DW USA only)	Proxy Settings	Proxy Connection	On/ Off
			Address	
			Port	
			User Name	
			Password	
	Network I/F			Wired LAN/WLAN
	Network Reset			

For MFC-J280W/J625DW and DCP-J725DW

Main menu	Submenu	Menu Selections	Options
Network	TCP/IP	BOOT Method	Auto /Static/RARP/BOOTP/DHCP
		IP Address	[000-255].[000-255].[000-255].[000-255]. [000].[000].[000].[000] ¹
		Subnet Mask	[000-255].[000-255].[000-255].[000-255]. [000].[000].[000].[000] ¹
		Gateway	[000-255].[000-255].[000-255].[000-255]. [000].[000].[000].[000]
		Node Name	BRWXXXXXXXXXXXX = (your machine's Ethernet address) (up to 15 characters)
		WINS Config	Auto /Static
		WINS Server	Primary/Secondary [000-255].[000-255].[000-255].[000-255]. [000].[000].[000].[000]
		DNS Server	Primary/Secondary [000-255].[000-255].[000-255].[000-255]. [000].[000].[000].[000]
		APIPA	On /Off
	Setup Wizard	—	(Choose SSID from list or manually add SSID)
	WPS/AOSS	—	
	WPS w/PIN Code	—	
	WLAN Status	Status	(Examples) Active (11b)/Active (11g)/Active (11n)/ AOSS Active/Connection Fail
		Signal	Signal:Strong/Signal:Medium/Signal:Weak/ Signal:None
		SSID	(Shows SSID with up to 32 digits)
		Comm. Mode	Ad-hoc/Infrastructure
	MAC Address		
	WLAN Enable		On / Off
	Network Reset		

For MFC-J430W/J432W

Main menu	Submenu	Menu Selections	Options
Network	TCP/IP	BOOT Method	Auto /Static/RARP/BOOTP/DHCP
		IP Address	[000-255].[000-255].[000-255].[000-255]. [000].[000].[000].[000] ¹
		Subnet Mask	[000-255].[000-255].[000-255].[000-255]. [000].[000].[000].[000] ¹
		Gateway	[000-255].[000-255].[000-255].[000-255]. [000].[000].[000].[000]
		Node Name	BRWXXXXXXXXXXXXX = (your machine's Ethernet address) (up to 15 characters)
		WINS Config	Auto /Static
		WINS Server	Primary/Secondary [000-255].[000-255].[000-255].[000-255]. [000].[000].[000].[000]
		DNS Server	Primary/Secondary [000-255].[000-255].[000-255].[000-255]. [000].[000].[000].[000]
		APIPA	On /Off
	Setup Wizard	—	(Choose SSID from list or manually add SSID)
	WPS/AOSS	—	
	WPS w/PIN Code	—	
	WLAN Status	Status	(Examples) Active (11b)/Active (11g)/Active (11n)/ AOSS Active/Connection Fail
		Signal	Signal:Strong/Signal:Medium/Signal:Weak/ Signal:None
		SSID	(Shows SSID with up to 32 digits)
		Comm. Mode	Ad-hoc/Infrastructure
	MAC Address		
WLAN Enable		On / Off	
Network Reset			

■ The factory settings are shown in bold.

- ¹ On connection to the network, the machine will automatically set the IP address and Subnet Mask to values appropriate for your network.
- ² For details, please refer to the *Web Connect Guide* located on the Manual download page for your model on the Brother Solutions Center (<http://solutions.brother.com/>).

IMPORTANT

Web Based Management is not available for MFC-J280W/J430W/J432W/J625DW/J825DW/J835DW and DCP-J725DW/J925DW.

Overview

A standard Web Browser can be used to manage your machine using the HTTP (Hyper Text Transfer Protocol). You can get the following information from a machine on your network using a web browser.

- Machine status information
- Change Fax configuration items, such as General Setup, Quick-Dial settings and Remote Fax
- Change network settings such as TCP/IP information
- Configure Secure Function Lock 2.0
- Configure Scan to FTP
- Configure Scan to Network
- Software version information of the machine and print server
- Change network and machine configuration details



Note

We recommend Microsoft® Internet Explorer® 7.0/8.0 or Firefox® 3.6 for Windows® and Safari 4.0/5.0 for Macintosh. Please also make sure that JavaScript and Cookies are always enabled in whichever browser you use.

You must use the TCP/IP protocol on your network and have a valid IP address programmed into the print server and your computer.

How to configure the machine settings using Web Based Management (web browser)

A standard web browser can be used to change your print server settings using the HTTP (Hyper Text Transfer Protocol).

- 1 Start your web browser.
- 2 Type "http://machine's IP address/" into your browser's address bar (where "machine's IP address" is the machine's IP address).

■ For example:

```
http://192.168.1.2/
```



Note

- If you are using a Domain Name System or enable a NetBIOS name, you can enter another name such as "Shared_Printer" instead of the IP address.

• For example:

```
http://Shared_Printer/
```

If you enable a NetBIOS name, you can also use the node name.

• For example:

```
http://brnxxxxxxxxxxxxx/
```

The NetBIOS name can be seen in the Network Configuration Report. (To learn how to print the Network Configuration Report, see *Printing the Network Configuration Report* >> page 39.)

- For Macintosh users, you can have easy access to the Web Based Management System by clicking the machine icon on the **Status Monitor** screen. For more information, see the *Software User's Guide*.

- 3 You can now change the print server settings.





Note

If you have changed the protocol settings, restart the machine after clicking **Submit** to activate the configuration.

Setting a password

We recommend setting a login password to prevent unauthorized access to the Web Based Management.

- 1 Click **Administrator**.
- 2 Enter the password you want to use (up to 32 characters).
- 3 Re-enter the password in **Confirm new password** box.
- 4 Click **Submit**.
From the next time you access the Web Based Management, enter the password in the **Login** box, and then click .
After configuring the settings, logout by clicking .



Note

You can also set a password by clicking **Please configure the password.** on the machine's web page if you are not setting a login password.

Secure Function Lock 2.0

Secure Function Lock 2.0 from Brother helps you to save money and increase security by restricting the functions available on your Brother machine.

Secure Function Lock allows you to configure passwords for selected users, granting them access to some, or all of these functions, or restricting them to a page limit. This means that only authorized people can use them.

You can configure and change the following Secure Function Lock 2.0 settings using BRAdmin Professional 3 or Web Based Management.

- **PC print**¹
- **PCC**
- **Copy**
- **Color Print**
- **Page Limit**
- **Fax TX**
- **Fax RX**
- **Scan**
- **Page Counter**

¹ If you register the PC user login names, you can restrict PC print without the user entering a password. For more detail, see *Restricting PC print by PC user login name* >> page 50.

How to configure the Secure Function Lock 2.0 settings using Web Based Management (web browser)

Basic configuration

- 1 Click **Administrator** on the machine's web page, and then click **Secure Function Lock**.
- 2 Choose **On** from **Function Lock**.



Note

To configure Secure Function Lock for the first time through the embedded web server, you have to enter the Administrator Password (four digit number).

- 3 Enter an alphanumeric group name or user name up to 15 digits in the **ID Number/Name** box and then enter a four-digit password in the **PIN** box.

- 4 Uncheck the functions that you want to restrict in the **Print** box or the **Others** box.
If you want to configure the maximum page count, check the **On** box in **Page Limit**, and then enter the number in the **Max** box.
- 5 Click **Submit**.
If you want to restrict the PC printing by PC login user name, click **PC Print Restriction by Login Name** and configure the settings. (See *Restricting PC print by PC user login name* >> page 50.)

Scanning when using Secure Function Lock 2.0

The Secure Function Lock 2.0 feature allows the administrator to restrict which users are allowed to scan. When the scan feature is set to off for public users, only users who have scan selected in the check box will be able to scan. To push scan from the control panel of the machine users must enter their PIN to access the scan mode. To pull scan from their computer, restricted users must also enter their PIN on the control panel of the machine before they can scan from their computer. If the PIN is not entered at the machine's control panel the user will get an error message on their computer when they attempt to pull scan.

Setting up public mode

You can set up the public mode to restrict what functions are available for public users. Public users do not need to enter a password to access the features made available through this setting.

- 1 Uncheck the check box for the function that you want to restrict in the **Public Mode** box.
- 2 Click **Submit**.

Restricting PC print by PC user login name

By configuring this setting, the machine can authenticate by PC user login name to allow a print job from a registered computer.

- 1 Click **PC Print Restriction by Login Name**.
- 2 Choose **On** from **PC Print Restriction**.
- 3 Choose the ID Number you set in the **ID Number/Name** in step ③ in *Basic configuration* >> page 49 from the **ID Number** pull-down list for each Login Name.
And then enter the PC user login name in the **Login Name** box.
- 4 Click **Submit**.



Note

If you want to restrict PC print per group, choose the same ID Number for each PC login name you want in the group.

Other features

You can set up the following features in Secure Function Lock 2.0:

■ All Counter Reset

You can reset the page counter by clicking **All Counter Reset**.

■ Export to CSV file

You can export the current page counter including **ID Number/Name** information as a CSV file.

■ Last Counter Record

The machine retains the page count after the counter has been reset.

■ Counter Auto Reset

You can automatically reset the page counters by configuring the time interval based on Daily, Weekly or Monthly settings, during the period the machine is turned on.

Changing the Scan to FTP configuration using a web browser

Scan to FTP allows you to scan a document directly to an FTP server on your local network or on the Internet. See the *Software User's Guide* for more details on Scan to FTP.

- 1 Click **Scan** on the machine's web page, and then click **Scan to FTP/Network**.
- 2 Choose **FTP** in the profile numbers (1 to 5) you want to use for Scan to FTP settings. You can also store two user defined file names that can be used for creating an FTP Server Profile in addition to the seven preset file names in **Create a User Defined File Name**. A maximum of 15 characters can be entered in each of the two fields.
- 3 Click **Submit**.
- 4 Click **Scan to FTP/Network Profile** on **Scan** page. Click the profile number you want to configure. Now you can configure and change the following Scan to FTP settings using a web browser.
 - **Profile Name** (Up to 15 characters)
 - **Host Address** (FTP server address)
 - **Username**
 - **Password**
 - **Store Directory**
 - **File Name**
 - **Quality**
 - **File Type**
 - **Glass Scan Size**
 - **Passive Mode**
 - **Port Number**

You can set **Passive Mode** to Off or On depending on your FTP server and network firewall configuration. You can also change the port number used to access the FTP server. The default for this setting is port 21. In most cases these two settings can remain as default.



Note

Scan to FTP is available when FTP server profiles are configured using Web Based Management.

- 5 After setting, click **Submit**.

Changing the Scan to Network configuration using a web browser

Scan to Network allows you to scan documents directly to a shared folder on a CIFS ¹ server located on your local network or the Internet. To enable the CIFS protocol, check the **Network** tab, click **Protocol** in the left-hand column, and select the **CIFS** checkbox.

¹ The Common Internet File System (CIFS) is the standard way that computer users share files and printers in Windows®.

See the *Software User's Guide* for more details on Scan to Network.

- 1 Click **Scan** on the machine's web page, and then click **Scan to FTP/Network**.
- 2 Choose **Network** in the profile numbers (1 to 5) you want to use for Scan to Network settings. You can also store two user defined file names that can be used for creating a Scan to Network Profile in addition to the seven preset file names in **Create a User Defined File Name**. A maximum of 15 characters can be entered in each of the two fields.
- 3 Click **Submit**.
- 4 Click **Scan to FTP/Network Profile** on **Scan** page. Click the profile number you want to configure. Now you can configure and change the following Scan to Network settings using a web browser.
 - **Profile Name** (Up to 15 characters)
 - **Host Address**
 - **Store Directory**
 - **File Name**
 - **Quality**
 - **File Type**
 - **Glass Scan Size**
 - **Use PIN for authentication**
 - **PIN Code**
 - **Username**
 - **Password**
- 5 After setting, click **Submit**.

IMPORTANT

Internet fax is not available for MFC-J280W/J430W/J432W/J625DW/J825DW/J835DW and DCP-J725DW/J925DW.

Internet fax Overview

Internet faxing (IFAX) allows you to send and receive fax documents using the Internet as the transport mechanism. Documents are transmitted in E-mail messages as attached TIFF-F files. This means that computers are also able to receive and send documents, providing that the computer has as an application that can generate and view TIFF-F files, you can use any TIFF-F viewer application. Any documents sent via the machine will automatically be converted into a TIFF-F format. If you wish to send and receive messages to and from your machine, your mail application on the computer must be able to support the MIME format.

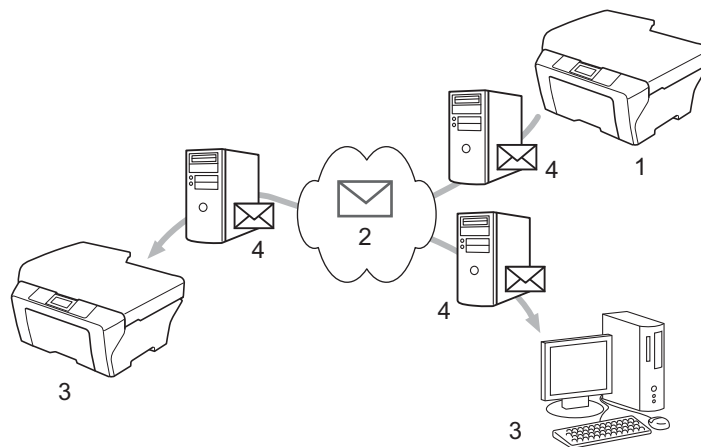

- 1 Sender
- 2 Internet
- 3 Receiver
- 4 E-mail server



Note

- In order to use this function, please download the necessary software from the Brother Solutions Center. (<http://solutions.brother.com/>)
- You can send/receive I-Fax documents in Letter or A4 format and in Black & White only.

■ Forwarding received E-mail and fax messages

You can forward received E-mail or standard fax messages to another E-mail address or fax machine. For more information see *Forwarding received E-mail and fax messages* >> page 59.

■ Relay broadcast

If you want to fax a document long distance (such as abroad), the "relay broadcast" function allows you to save the communication fee. This function allows the Brother machine to receive the document over the Internet, and then relay it to other fax machines through conventional telephone lines. For more information see *Relay broadcasting* >> page 59.

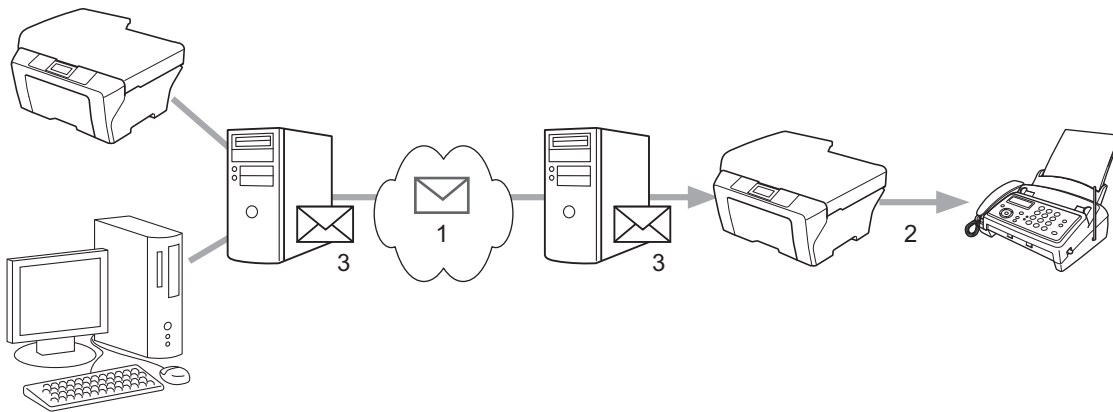

- 1 Internet**
- 2 Telephone line**
- 3 E-mail server**

Important information on Internet fax

Internet fax communication on a LAN system is basically the same as communication via E-mail; however, it is different from fax communication using standard phone lines. The following is important information for using Internet fax:

- Factors such as the receiver's location, structure of the LAN system, and how busy the network (such as the Internet) is, may cause the system to take a long time to send back an error mail (normally 20 sec. to 30 sec.).
- In the case of transmission through the Internet, due to its low level of security, we recommend that you use standard phone lines to send confidential documents.
- If the receiver's mail system is not compatible with the MIME format, you cannot transmit a document to the receiver. Depending on the receiver's server, there may be some cases in which the error mail will not be sent back.
- If the size of a document's image data is too large, there is a possibility of unsuccessful transmission.
- You cannot change the font or character size of Internet mail that you receive.

How to Internet fax

Before using an Internet fax you must configure your Brother machine to communicate with your network and mail server. You must ensure the following items of your machine. You can configure these items from the control panel, Web Based Management, Remote Setup or BRAdmin Professional 3. If you are unsure of any of these items, please contact your systems administrator.

- E-mail address
- SMTP, POP3 server address/port/Authentication method
- mailbox name and password

Sending an Internet fax

Before sending an Internet fax

To send the Internet fax, you can configure following items from the control panel, Web Based Management or Remote Setup.

- Sender Subject (if needed)
- Size Limit (if needed)
- Notification (if needed) (For more information, see *TX Verification Mail* >> page 61)

How to send an Internet fax

Sending an Internet fax is the same as sending a normal fax. (For more information, see the *Basic User's Guide*.) If you have already programmed the addresses of the destination Internet fax machines as Speed-Dial, you can send the Internet fax by loading the document into the machine.



Note

- If you wish to manually enter the Internet fax address, load the document into the machine and press . Press to choose numbers, characters or special characters. Enter the address and press **OK**, and then press **Black Start/Mono Start** or **Color Start/Colour Start**.
For more information on how to enter text, see the *Quick Setup Guide*.
- You can register the E-mail address information from Web Based Management or Remote Setup.

After the document is scanned, it is transmitted to the recipient Internet fax machine automatically via your SMTP server. You can cancel the send operation by pressing the **Stop/Exit** key during scanning. After the transmission is finished, the machine will return to standby mode.

**Note**

Some E-mail servers do not allow you to send large E-mail documents (the System Administrator will often place a limit on the maximum E-mail size). With this function enabled, the machine will display `Out of Memory` when trying to send E-mail documents over 1 Mbyte in size. The document will not be sent and an error report will be printed. The document you are sending should be separated into smaller documents that will be accepted by the mail server. (For your information, a 42 page document based on the ITU-T Test Chart #1 test chart is approximately 1 Mbyte in size.)

Receiving E-mail or Internet fax

Before receiving an Internet fax

To receive the Internet fax, you can configure following items from the control panel, Web Based Management or Remote Setup:

- Auto Polling (if needed)
- Poll Frequency (if needed)
- Header (if needed)
- Delete Error Mail (if needed)
- Notification (if needed) (For more information, see *TX Verification Mail* >> page 61)

How to receive an Internet fax

There are 2 ways you can receive E-mail messages:

- POP3 receiving at regular intervals
- POP3 receiving (manually initiated)

Using POP3 receiving the machine must poll the E-mail server to receive the data. This polling can occur at set intervals (for example, you can configure the machine to poll the E-mail server at 10 minute intervals) or you can manually poll the server by pressing the **Shift + Black Start/Mono Start** or **Color Start/Colour Start** keys.

If your machine starts to receive E-mail data, the LCD panel will reflect this activity. For example, you will see `Receiving` on the LCD panel followed by `xx E-mail(s)`. If you press the **Shift + Black Start/Mono Start** or **Color Start/Colour Start** keys to manually poll the E-mail server for E-mail data and there are no mail documents waiting to be printed, the machine will display `No Mail` on the LCD panel for two seconds.

**Note**

- If your machine is out of paper when receiving data, the received data will be held in the machine's memory. This data will be printed automatically after paper is re-inserted into the machine.
- If the received mail is not in a plain text format or an attached file is not in the TIFF-F format, the following error message will be printed: "**ATTACHED FILE FORMAT NOT SUPPORTED. FILE NAME:XXXXXX.doc**". If the received mail is too large, the following error message will be printed: "**E-MAIL FILE TOO LARGE.**". If Delete POP Receive Error Mail is ON (default) then the error mail is automatically deleted from the E-mail server.

Receiving an Internet fax to your computer

When a computer receives an Internet fax document, the document is attached to a mail message that informs the computer that it has received a document from an Internet fax. This is notified in the subject field of the received mail message.



Note

If the computer to which you wish to send a document is not running a Windows Server[®] 2003/2008, Windows Vista[®] or Windows[®] 7 operating system, please inform the computer's owner that they must install some software that can view TIFF-F files.

Additional Internet Fax options

Forwarding received E-mail and fax messages

You can forward received E-mail or standard fax messages to another E-mail address or fax machine. Received messages can be forwarded via E-mail to a computer or Internet fax. They can also be forwarded via standard phone lines to another machine.

The setting can be enabled using a web browser or through the control panel of the machine. The steps for configuring fax forward can be found in the *Advanced User's Guide*.

Please see the *Advanced User's Guide* to check that this feature is supported.

Relay broadcasting

This function allows the Brother machine to receive a document over the Internet, and then relay it to other fax machines through conventional telephone lines.

Before relaying broadcast

To relay broadcast, you must configure following items from the control panel, Web Based Management or Remote Setup:

- Relay Broadcast

You must enable the relay broadcast.

- Relay Domain

You must configure your machine's domain name on the machine that will broadcast the document to the conventional fax machine. If you wish to use your machine as a relay broadcast device, you must specify the domain name that you trust at the machine, in other words, the portion of the name after the "@" sign. Use care in selecting a trusted domain since any user on a trusted domain will be able to send a relay broadcast.

You can register up to 5 domain names.

- Relay Report

Relay broadcast from a machine

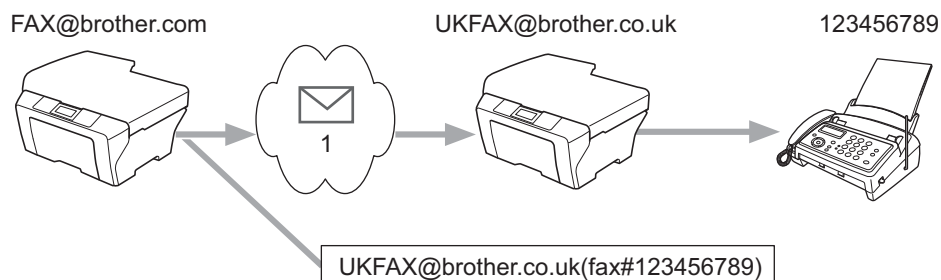

1 Internet



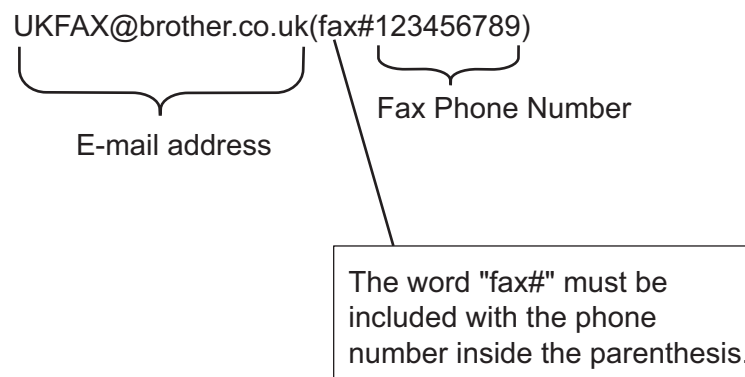

In this example, your machine has an E-mail address of FAX@brother.com, you wish to send a document from this machine to another machine in England with an E-mail address of UKFAX@brother.co.uk, this machine will then forward the document to a standard fax machine using a conventional telephone line. If your E-mail address is FAX@brother.com, you must configure a trusted domain name of brother.com on the machine in England that will broadcast the document to the conventional fax machine. If you do not enter the domain name information, then the machine in the middle (the machine that will broadcast the document) will not trust any Internet jobs that it receives from the machine in the @brother.com domain.

After the trusted domain is set you can send the document from your machine [e.g. FAX@brother.com] by entering the E-mail address of the machine [e.g. UKFAX@brother.co.uk] that will forward the document followed by the phone number of the fax that will receive the document. The following is an example of how to enter the E-mail address and phone number.



Sending to multiple phone numbers:

If you want to have the document relayed to more than one standard fax machine the destination can be entered using the following method:

- 1 Press  (FAX).
- 2 Press Options.
- 3 Press  or  to display Broadcasting.
- 4 Press Broadcasting.
- 5 Press Add number from SpeedDial.
Press  to search by Alphabetical Order or Numerical Order. Press the locations where you want to send a fax.
Press OK.
- 6 After you have entered all the fax numbers by repeating step 5, press OK.
- 7 (For US) Press **Black Start**.
(For UK) Press **Mono Start**.

Relay broadcast from a computer

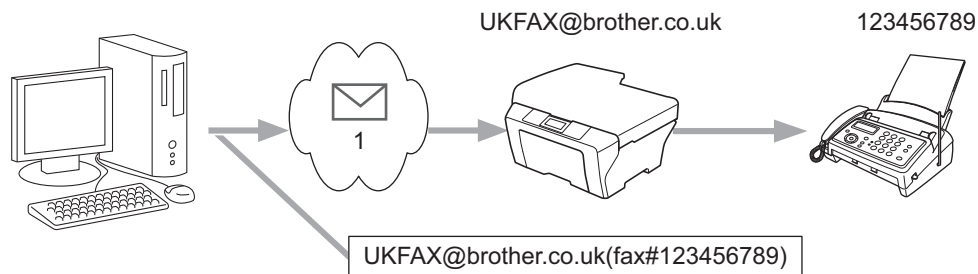

1 Internet

You can also send E-mail from your computer and have it relayed to a conventional fax machine. The method of entering the phone number of the conventional fax machine that will receive the relayed E-mail will vary depending on the mail application you are using. The following are some examples of different mail applications:

Some E-mail applications do not support sending to multiple phone numbers. If your E-mail application cannot support multiple phone numbers you will only be able to relay to one fax machine at a time.

Enter the address of the relay machine and phone number of the fax in the "TO" box using the same method used when sending from a machine.

UKFAX@brother.co.uk(fax#123456789)



Note

For Microsoft® Outlook® 97 or greater, the address information must be entered into the address book as follows:

Name: fax#123456789

E-mail address: UKFAX@brother.co.uk

TX Verification Mail

Transmission Verification Mail supports two separate functions. Verification Mail for sending allows you to request notification from the receiving station that the Internet Fax or E-mail was received and processed. Verification Mail for receiving allows you to transmit a default report back to the sending station after successfully receiving and processing an Internet Fax or E-mail.

To use this feature you must set the `Notification` option within the `Setup Mail RX` and `Setup Mail TX` options.

Setup Mail TX

You can set the `Notification` option in the `Setup Mail TX` option to either `On` or `Off`. When switched to `On` an additional field of information is sent with the image data. This field is named "MDN".

MDN (Message Disposition Notification):

This field requests the status of the Internet Fax/E-mail message after delivery through the SMTP (Simple Mail Transfer Protocol) transport system. Once the message has arrived at the receiver this data is used when the machine or user reads or prints the received Internet Fax or E-mail. For example, if the message is opened for reading or is printed the receiver sends back a notification to the original sending machine or user.

The receiver must support the MDN field in order to be able to send a notification report, otherwise the request will be ignored.

Setup Mail RX

There are three possible settings for this option `On`, `MDN` or `Off`.

Receive Notification "On"

When switched to "On" a fixed message is sent back to the sender to indicate successful reception and processing of the message. These fixed messages depend on the operation requested by the sender.

Report messages consist of:

```
SUCCESS: Received From <Mail Address>
```

Receive Notification "MDN"

When switched to "MDN" a report as described above is sent back to the sender if the originating station sent the "MDN" field to request confirmation.

Receive Notification "Off"

Off switches all forms of receive notification `Off`, no message are sent back to the sender regardless of the request.



Note

To receive the TX verification mail properly, you must configure the following settings.

- Sender
 - Switch Notification in the Setup Mail TX to on.
 - Switch Header in the Setup Mail RX to All or Subject+From+To.
- Receiver
 - Switch Notification in the Setup Mail RX to on.

Error mail

If there is a mail delivery error while sending an Internet fax, the mail server will send an error message back to the machine and the error message will be printed. If there is an error while receiving mail, an error message will be printed (Example: "The message being sent to the machine was not in a TIFF-F format.").

To receive the error mail properly, you must switch Header in the Setup Mail RX to All or Subject+From+To.

IMPORTANT

Security features is not available for MFC-J280W/J430W/J432W/J625DW/J825DW/J835DW and DCP-J725DW/J925DW.

Overview

In today's world there are many security threats to your network and the data that travels over it. Your Brother machine employs some of the latest network security and encryption protocols available today. These network features can be integrated into your overall network security plan to help protect your data and prevent unauthorized access to the machine. This chapter explains how to configure them.

You can configure the following security features:

- Sending an E-mail securely (See *Sending an E-mail securely* >> page 64.)
- Secure Management using BRAdmin Professional 3 (Windows®) (See *Secure Management using BRAdmin Professional 3 (Windows®)* >> page 66.)



Note

We recommend to disable the Telnet, FTP and TFTP protocols. Accessing the machine using these protocols is not secure. (For how to configure the protocol settings, see *How to configure the machine settings using Web Based Management (web browser)* >> page 47.) If you disable FTP, the Scan to FTP function will be disabled.

Sending an E-mail securely

Configuration using Web Based Management (web browser)

You can configure secured E-mail sending with user authentication on the Web Based Management screen.

- 1 Start your web browser.
- 2 Type "http://printer's IP address/" into your browser (where "printer's IP address" is the printer's IP address).
 - For example:
`http://192.168.1.2/`
- 3 Enter a password in the **Login** box, and then click .
- 4 Click **Network**.
- 5 Click **Protocol**.
- 6 Click **Advanced Setting** of **POP3/SMTP** and make sure that the status of **POP3/SMTP** is **Enable**.
- 7 You can configure the **POP3/SMTP** settings on this page.



Note

- For more information, see the Help text in Web Based Management.
 - You can also confirm whether the E-mail settings are correct after configuration by sending a test E-mail.
-

- 8 After configuring, click **Submit**. The Test E-mail Send/Receive Configuration dialog appears.
- 9 Follow the instructions on-screen if you want to test with the current settings.

Sending an E-mail with user authentication

This machine supports POP before SMTP and SMTP-AUTH methods to send an E-mail via an E-mail server that requires a user authentication. These methods prevent an unauthorized user from accessing the E-mail server. You can use Web Based Management and BRAdmin Professional 3 to configure these settings. You can use POP before SMTP and SMTP-AUTH methods for E-mail Notification, E-mail reports and Internet fax sending.

E-mail server settings

You need to match the settings of SMTP authentication method with the method used by your E-mail server. Contact your network administrator or your ISP (Internet Service Provider) about the E-mail server configuration.

You will also need to check **SMTP-AUTH** of **SMTP Server Authentication Method** to enable the SMTP server authentication.

SMTP settings

- You can change the SMTP port number using Web Based Management. This is useful if your ISP (Internet Service Provider) implements the “Outbound Port 25 Blocking (OP25B)” service.
- By changing the SMTP port number to a specific number which your ISP is using for the SMTP server (for example, port 587), you would then be able to send an E-mail via the SMTP server.
- If you can use both POP before SMTP and SMTP-AUTH, we recommend choosing SMTP-AUTH.
- If you choose POP before SMTP for the SMTP Server Authentication Method, you need to configure the POP3 settings. You can also use the APOP method if needed.

Secure Management using BRAdmin Professional 3 (Windows[®])

To use the BRAdmin Professional 3 utility securely, you need to follow the points below

- We strongly recommend to use the latest version of the BRAdmin Professional 3 utility that is available as a download from <http://solutions.brother.com/>. If you use an older version of BRAdmin¹ to manage your Brother machines the user authentication will not be secure.
- If you are managing a mixed group of older print servers² and the print servers with BRAdmin Professional 3, we recommend using a different password in each group. This will ensure security is maintained on the new print servers.

¹ BRAdmin Professional older than Ver. 2.80, BRAdmin Light for Macintosh older than Ver. 1.10

² NC-2000 series, NC-2100p, NC-3100h, NC-3100s, NC-4100h, NC-5100h, NC-5200h, NC-6100h, NC-6200h, NC-6300h, NC-6400h, NC-8000, NC-100h, NC-110h, NC-120w, NC-130h, NC-140w, NC-8100h, NC-9100h, NC-7100w, NC-7200w, NC-2200w

Overview

This chapter explains how to resolve typical network problems you may encounter when using your Brother machine. If, after reading this chapter, you are unable to resolve your problem, please visit the Brother Solutions Center at: <http://solutions.brother.com/>.

Make sure that the following items are configured before reading this chapter.

First check the following:
The power cord is connected properly and the Brother machine is turned on.
The access point (for wireless), router or hub is turned on and its link light is blinking.
All protective packaging has been removed from the machine.
The ink cartridges are installed properly.
The front and back covers are fully closed.
Paper is inserted properly in the paper tray.
(For wired networks) A network cable is securely connected to the Brother machine and the router or hub.

Go to the page for your solution from the lists below:

- I cannot complete the wireless network setup configuration. (See page 67.)
- The Brother machine is not found on the network during the MFL-Pro Suite installation. (See page 68.)
- The Brother machine cannot print or scan over the network. (See page 69.)
- The Brother machine is not found on the network even after successful installation. (See page 69.)
- I'm using security software. (See page 71.)
- I want to check my network devices are working properly. (See page 71.)

I cannot complete the wireless network setup configuration.

Question	Interface	Solution
Are your security settings (SSID/Network Key) correct?	wireless	<ul style="list-style-type: none"> ■ Reconfirm and choose the correct security settings. <ul style="list-style-type: none"> • The manufacturer's name or model no. of the WLAN access point/router may be used as the default security settings. • See the instructions supplied with your WLAN access point/router for information on how to find the security settings. • Ask the manufacturer of your WLAN access point/router or ask your Internet provider or network administrator. ■ For information on what the SSID and Network Key are, see SSID, Network Key and channels in the <i>Network Glossary</i>.
Are you using MAC address filtering?	wireless	Confirm that the MAC address of the Brother machine is allowed in the filter. You can find the MAC address from Brother machine's control panel. (See <i>Function table and default factory settings</i> ►► page 41.)

I cannot complete the wireless network setup configuration. (continued)

Question	Interface	Solution
Is your WLAN access point/router in stealth mode? (not broadcasting the SSID)	wireless	<ul style="list-style-type: none"> ■ You should type the correct SSID name or Network Key by hand. ■ Check the SSID name or the Network Key in the instructions supplied with your WLAN access point/router and reconfigure the wireless network setup. (For more information, see <i>Configuring your machine when the SSID is not broadcast</i> >> page 26.)
I have checked and tried all of the above, but still cannot complete the wireless configuration. Is there anything else I can do?	wireless	Use the Network Connection Repair Tool. (See <i>(Windows®) Confirming the IP address and the Subnet Mask using the Network Connection Repair Tool</i> . >> page 69.)





The Brother machine is not found on the network during the MFL-Pro Suite installation.

Question	Interface	Solution
Are you using security software?	wired/ wireless	<ul style="list-style-type: none"> ■ Confirm your settings on the installer dialog. ■ Allow access when the alert message of the security software appears during the MFL-Pro Suite installation. ■ For more information about security software, see <i>I'm using security software</i>. >> page 71.
Is your Brother machine placed too far from the WLAN access point/router?	wireless	Place your Brother machine within about 3.3 feet (1 meter) from the WLAN access point/router when you configure the wireless network settings.
Are there any obstructions (walls or furniture, for example) between your machine and the WLAN access point/router?	wireless	Move your Brother machine to an obstruction-free area, or closer to the WLAN access point/router.
Is there a wireless computer, Bluetooth supported device, microwave oven or digital cordless phone near the Brother machine or the WLAN access point/router?	wireless	Move all the devices away from Brother machine or WLAN access point/router.

**The Brother machine cannot print or scan over the network.
The Brother machine is not found on the network even after successful installation.**

Question	Interface	Solution
Are you using security software?	wired/ wireless	See <i>I'm using security software.</i> >> page 71.
Is your Brother machine assigned with an available IP address?	wired/ wireless	<ul style="list-style-type: none"> ■ Confirming the IP address and the Subnet Mask. Verify that both the IP addresses and Subnet Masks of your computer and the Brother machine are correct and located on the same network. For more information on how to verify the IP address and the Subnet Mask, ask the network administrator or visit the Brother Solutions Center at http://solutions.brother.com/. ■ (Windows®) Confirming the IP address and the Subnet Mask using the Network Connection Repair Tool. Use the Network Connection Repair Tool to fix the Brother machine's network settings. It will assign the correct IP address and Subnet Mask. To use the Network Connection Repair Tool follow the steps below: <p> Note</p> <ul style="list-style-type: none"> • (Windows® XP/Windows Vista®/Windows® 7) Login to the network with Administrator privileges. • Make sure that the Brother machine is turned on and is network-connected to your computer.

**The Brother machine cannot print or scan over the network.
The Brother machine is not found on the network even after successful installation. (continued)**

Question	Interface	Solution
<p>Is your Brother machine assigned with an available IP address? (Continued)</p>	<p>wired/ wireless</p>	<p>1 (Windows® XP, Windows Server® 2003/2008) Click the Start button, All Programs, Accessories and Windows Explorer, and then My Computer. (Windows Vista®/Windows® 7) Click the  button and Computer.</p> <p>2 Double-click Local Disk (C:), Program Files or Program Files (x86), Bronny02, Brother, BrotherNetTool.exe to run the program.</p> <p> Note</p> <hr/> <p>If the User Account Control screen appears, (Windows Vista®) Click Continue. (Windows® 7) Click Yes.</p> <hr/> <p>3 Follow the on screen instructions.</p> <p>4 Check the diagnosis by printing the Network Configuration Report.</p> <p> Note</p> <hr/> <p>The Network Connection Repair Tool will start automatically if you check the Enable Network Connection Repair Tool box using the Status Monitor. Right-click on the Status Monitor screen, click Options, Details and then click the Diagnostic tab. This is not recommended when your network administrator has set the IP address to static, since it will automatically change the IP address.</p> <hr/> <p>If the correct IP address and Subnet mask are still not assigned even after using the Network Connection Repair Tool, ask the network administrator for this information, or visit the Brother Solutions Center at http://solutions.brother.com/.</p>
<p>Did your previous printing job fail?</p>	<p>wired/ wireless</p>	<ul style="list-style-type: none"> ■ If the failed printing job is still in your computer's print queue, delete it. ■ Double-click the printer icon in the following folder and then choose the Cancel All Documents in the Printer menu: (Windows® XP) Start and Printers and Faxes. (Windows Vista®) , Control Panel, Hardware and Sound and then Printers. (Windows® 7) , Control Panel, Hardware and Sound, Devices and Printers and then Printers and Faxes.

The Brother machine cannot print or scan over the network.

The Brother machine is not found on the network even after successful installation. (continued)

Question	Interface	Solution
Are you connecting the Brother machine to the network using wireless capabilities?	wireless	<ul style="list-style-type: none"> ■ Print the WLAN Report to confirm the state of a wireless connection. (For how to print, see <i>Printing the WLAN Report</i> >> page 40.) If the printed WLAN report shows the connection failed, check the error code on the printed report. >>Quick Setup Guide: <i>Troubleshooting</i> ■ See <i>The Brother machine is not found on the network during the MFL-Pro Suite installation.</i> >> page 68.
I have checked and tried all of above, however the Brother machine does not print/scan. Is there anything else I can do?	wired/ wireless	Uninstall the MFL-Pro Suite and reinstall it.

I'm using security software.

Question	Interface	Solution
Did you choose to accept the security alert dialog during the MFL-Pro Suite or BRAdmin Light installation or when using the printing/scanning features?	wired/ wireless	If you did not choose to accept the security alert dialog, the firewall function of your security software may be rejecting access. Some security software might block access without showing a security alert dialog. To allow access, see the instructions of your security software or ask the manufacturer.
I want to know the necessary port number for the security software settings.	wired/ wireless	<p>The following port numbers are used for Brother network features:</p> <ul style="list-style-type: none"> ■ Network scanning → Port number 54925 / Protocol UDP ■ PC-FAX RX → Port number 54926 / Protocol UDP ■ Network scanning/printing, PC-FAX RX, Remote Setup → Port number 137 and 161 / Protocol UDP ■ BRAdmin Light → Port number 161 / Protocol UDP <p>For details on how to open the port, see the instructions of the security software or ask the manufacturer.</p>

I want to check my network devices are working properly.

Question	Interface	Solution
Is your Brother machine, access point/router or network hub turned on?	wired/ wireless	Make sure you have confirmed all instructions in <i>Make sure that the following items are configured before reading this chapter.</i> >> page 67.
Where can I find the Brother machine's network settings, such as IP address?	wired/ wireless	Printing the Network Configuration Report. See <i>Printing the Network Configuration Report</i> >> page 39.

I want to check my network devices are working properly. (continued)

Question	Interface	Solution
Check the Link Status in the Network Configuration Report.	wired/ wireless	Print the Network Configuration Report and check that Ethernet Link Status or Wireless Link Status is showing Link OK . If the Link Status shows Link DOWN or Failed To Associate , start again from the <i>Make sure that the following items are configured before reading this chapter.</i> >> page 67.
Can you “ping” the Brother machine from your computer?	wired/ wireless	Ping the Brother machine from your computer using the IP address or the node name. <ul style="list-style-type: none"> ■ Successful – Your Brother machine is working correctly and connected to the same network as your computer. ■ Unsuccessful – Your Brother machine is not connected to the same network as your computer. (Windows®) Ask the network administrator and use the Network Connection Repair Tool to fix the IP address and the subnet mask automatically. For the detail of the Network Connection Repair Tool, see <i>(Windows®) Confirming the IP address and the Subnet Mask using the Network Connection Repair Tool.</i> >> page 69. (Macintosh) Confirm the IP address and the Subnet Mask are set correctly. See <i>Confirming the IP address and the Subnet Mask.</i> >> page 69.
Is the Brother machine connected to the wireless network?	wireless	Print the WLAN Report to confirm the state of a wireless connection. (For how to print, see <i>Printing the WLAN Report</i> >> page 40.) If the printed WLAN report shows the connection failed, check the error code on the printed report. >>Quick Setup Guide: <i>Troubleshooting</i>
I have checked and tried all of the above, however, I'm still having problems. Is there anything else I can do?	wired/ wireless	See the instructions supplied with your WLAN access point/router to find the SSID and the Network Key information and set them correctly. For details of the SSID and the Network Key, see <i>Are your security settings (SSID/Network Key) correct?</i> >> page 67.

Supported protocols and security features

Interface	Ethernet	10/100BASE-TX
	Wireless	IEEE 802.11b/g/n (Infrastructure Mode / Ad-hoc Mode)
Network (common)	Protocol (IPv4)	ARP, RARP, BOOTP, DHCP, APIPA (Auto IP), WINS/NetBIOS name resolution, DNS Resolver, mDNS, LLMNR responder, LPR/LPD, Custom Raw Port/Port9100, FTP Server, TFTP server, SNMPv1/v2c, ICMP, Web Services (Print/Scan)
Network (Security)	Wireless	SSID (32 chr), WEP 64/128 bit, WPA-PSK (TKIP/AES), WPA2-PSK (AES)

B Index

A

AOSS™ 17, 36
APIPA 36

B

BRAdmin Light 2, 4
BRAdmin Professional 3 2, 7, 66
Brother installer application 11, 14
Brother Solutions Center 5, 7

C

Control Panel 34

D

DNS Server 36
Driver Deployment Wizard 2

E

Ethernet 37

F

Factory Default 38

G

Gateway 35

I

Infrastructure mode 9
IP Address 35

M

MAC Address 37

N

Network Configuration Report 39
Network Connection Repair Tool 69
Network Photo Capture 2
Node Name 35

O

Operating systems 2

P

PBC 17, 36
PIN Method 19, 36
POP before SMTP 65

R

Remote Setup 2
Restoring the network settings 38

S

SMTP-AUTH 65
Status Monitor 2
Subnet Mask 35

T

TCP/IP 34

V

Vertical Pairing 2

W

Wi-Fi Protected Setup 17, 19, 36
WINS Config 35
WINS Server 35
Wireless network 8
WLAN Report 40

Free Manuals Download Website

<http://myh66.com>

<http://usermanuals.us>

<http://www.somanuals.com>

<http://www.4manuals.cc>

<http://www.manual-lib.com>

<http://www.404manual.com>

<http://www.luxmanual.com>

<http://aubethermostatmanual.com>

Golf course search by state

<http://golfingnear.com>

Email search by domain

<http://emailbydomain.com>

Auto manuals search

<http://auto.somanuals.com>

TV manuals search

<http://tv.somanuals.com>