



Vipersat CDM-570/570L

Satellite Network Modem Router



User Guide

Part Number 22125 Revision 2.0

Vipersat CDM-570/570L

Version 1.5.3

User Guide

Part number 22125
Document Revision 2.0

Firmware Version 1.5.3

May 12, 2006

Comtech VIPERSAT Networks, Inc.

3215 Skyway Court
Fremont, CA 94539
USA

Phone: (510) 252-1462

Fax: (510) 252-1695

www.vipersat.com

Part Number 22125

Manual Revision 2.0

Firmware Version 1.5.3

©2006 by Comtech VIPERSAT Networks, Inc. All rights reserved. No part of this manual may be copied or reproduced without prior written permission of Comtech VIPERSAT Networks, Inc.

All products, names, and services are trademarks or registered trademarks of their respective companies.

Printed in the United States of America

Document Revision Status

Document Revision	Date	Description	Affected Pages
Rev. 1.0	10/06/05	Initial release of document	N/A
Rev. 2.0	5/12/06	Modifications for Firmware version 1.5.3	All

The information contained in this document is subject to change without notice or obligation. Although CVNI has made every effort to verify the content of this document, CVNI assumes no responsibility for liability due to errors that may appear in this document.

{ *This Page Intentionally Blank* }

Table of Contents

General

How to Use This Manual	1-1
Manual Organization	1-1
Chapter 1 — General	1-1
Chapter 2 — Quick Start Configuration	1-1
Chapter 3 — Using the Command Line	1-2
Interface (CLI)	1-2
Appendix A — Network Addressing	1-2
Appendix B — Automatic Switching	1-2
Appendix C — Dynamic Power Control	1-2
Appendix D — Network Migration	1-2
Conventions and References	1-2
Product Description	1-4
Introduction	1-4
Modem Features	1-4
Router Features	1-4
Network and Bandwidth Management	1-5
Dynamic SCPC (dSCPC)	1-5
Turbo Product Coding	1-6
Header Compression	1-6
Payload Compression	1-6
Quality of Service	1-6
Data Encryption	1-6
New in this Release	1-6
1.5.3 Release	1-7
New Redundancy Features	1-7
New QoS Features	1-7
Burst Fast Acquisition Timing (BFAT)	1-7
STDMA Slot Quantization	1-7
RTP Inactivity Timeout	1-7
Parameter File Consolidation	1-7
Vipersat File Streaming (VFS)	1-8
Automatic Home State Control (Remote Unit)	1-8
ECM User Defined Switch Type	1-8
Customer Support	1-9
Contact Information	1-9
Return Material Authorization	1-9
Reader Comments / Corrections	1-9

Quick Start Configuration

Introduction	2-1
Initial Configuration	2-3
Terminal Connection	2-3
Network Role	2-3

Setting Vipersat CDM-570/570L Operating

Parameters	2-4
Set the Feature Configuration	2-4
Set the IP Address	2-7
Configure the Route Table	2-8
Routing in a Vipersat Network	2-8
Creating the Routes	2-8
Set the Satellite Modem Configuration	2-10
Set the Vipersat Configuration	2-11

Using the Command Line Interface (CLI)

General	3-1
Common Screen Commands	3-1
Save Parameters to Permanent Storage	3-1
Exit	3-2
Telnet Logout	3-2
Menu Descriptions	3-3
Main menu	3-3
Administration	3-3
Feature Configuration	3-4
Vipersat Feature Codes menu	3-5
Vipersat Management	3-5
Vipersat STDMA	3-6
Vipersat Auto Switching	3-6
Vipersat File Streamer	3-6
Vipersat Configuration	3-7
STDMA Mode	3-7
STDMA	3-8
STDMA Tx Rate	3-9
Hub Type	3-9
1 -- Fixed	3-10
2 -- Dynamic Slot	3-10
3 -- Dynamic Cycle	3-10
4 -- GIR	3-10
5 -- Entry Channel	3-10
Group ID	3-11
Low Data Rate Fast Acquisition	3-11
Burstmap Multicast IP	3-11
Outbound IP	3-12
Cycles Per Burst Map	3-12
Slot Guardband	3-13
Slot Preamble Length	3-13
Slot Data Length	3-14
Slot Cycle Length	3-14

Load Switching	B-2
Bandwidth Allocation and Load Switching by the STDMA Controller:	B-2
Load Switching Process	B-6
Load Switching by a Remote	B-6
Determining Need-for-Change.	B-7
Load Switch Example	B-8
Reduced data flow in switched mode (SCPC)	B-10
Application switching	B-11
Type of Service (ToS) Switching	B-13
Entry Channel Mode (ECM) Switching	B-14
Applications Switching.	B-14

Dynamic Power Control

Introduction	C-1
Description.	C-2
Adjustment for Data Rate	C-3
DPC Scaling Function	C-4

Network Migration

General	D-1
Firmware Upgrade.	D-3

Upgrade Overview	D-3
Required Support Utilities and Firmware	D-3
Basic Steps	D-3
Migration Procedure	D-4
Getting Information with VLOAD	D-4
Upgrade Router to v1.5.3	D-6
Save and Reboot to Latest	D-7
Get Information for Router v1.5.3	D-8
Upgrade Base Modem to v1.5.1	D-9
Upgrade Image 1 on Base Modem to v1.4.5	D-9
Upgrade Image 1 on Base Modem to v1.5.1	D-10
Download Base Modem v1.5.1 to Image 2 . D-11	D-11
Download Router v1.5.3 to Image 2.	D-12
Completing Migration	D-12
Picking Up Straggler/Offline Remotes.	D-12
Setting v1.5.2 Compatibility in Hub Modems D-13	D-13

Glossary

List of Figures

Chapter 2 Figures

Figure 2-1 Main Menu screen.	2-5
Figure 2-2 Administration screen	2-5
Figure 2-3 Feature Configuration screen	2-6
Figure 2-4 Feature and Unlock Code dialog.	2-6
Figure 2-5 Working Mode dialog	2-7
Figure 2-6 Configuring the Route Table screen	2-9
Figure 2-7 Tx Configuration screen	2-10
Figure 2-8 Vipersat Configuration screen (Hub).	2-11

Chapter 3 Figures

Figure 3-1 Main Menu screen.	3-3
Figure 3-2 Administration screen	3-4
Figure 3-3 Feature Configuration screen	3-4
Figure 3-4 Feature and unlock code dialog	3-5
Figure 3-5 Vipersat Configuration screen (Hub)	3-7
Figure 3-6 STDMA screen (Hub, Dynamic Cycle type).	3-8
Figure 3-7 STDMA screen (Remote)	3-8
Figure 3-8 Hub Type prompt	3-9
Figure 3-9 Group ID prompt	3-11
Figure 3-10 Burstmap Multicast IP prompt.	3-12
Figure 3-11 Outbound IP prompt	3-12
Figure 3-12 Cycles per Burst Map prompt	3-13
Figure 3-13 Slot Guardband prompt.	3-13
Figure 3-14 Slot Preamble Length prompt	3-13
Figure 3-15 Slot Data Length (Nominal).	3-14
Figure 3-16 STDMA Remotes Menu screen	3-15
Figure 3-17 Adding a Remote to the STDMA group	3-16
Figure 3-18 Modifying Remote Display Base	3-16
Figure 3-19 STDMA Remote Policies screen (GIR Hub).	3-17
Figure 3-20 GIR Remote Policies prompt.	3-17
Figure 3-21 Entry Channel Switch Rates screen	3-18
Figure 3-22 Remote SCPC Data Rate and Switch Type prompt.	3-18
Figure 3-23 Global SCPC Data Rate prompt	3-18
Figure 3-24 Global Switch Type prompt.	3-19
Figure 3-25 Delete Remote prompt	3-19

Figure 3-26 Enable/Disable Remote prompt	3-19
Figure 3-27 View Remote(s) screen	3-20
Figure 3-28 Remove Timeout prompt.	3-20
Figure 3-29 Remove Retry Timeout prompt	3-21
Figure 3-30 STDMA Statistics screen (Hub).	3-21
Figure 3-31 STDMA Statistics screen (Remote).	3-22
Figure 3-32 Hub Statistics screen.	3-22
Figure 3-33 STDMA/SCPC Auto Switching screen (Hub)	3-23
Figure 3-34 STDMA/SCPC Auto Switching screen (Remote)	3-24
Figure 3-35 QoS Configuration screen.	3-28
Figure 3-36 QoS Rules Configuration screen.	3-28
Figure 3-37 QoS Rules Based Switching screen	3-29
Figure 3-38 STDMA Slot Capacity prompt	3-30
Figure 3-39 STDMA Switch Delay prompt	3-31
Figure 3-40 Percent Allocation prompt.	3-31
Figure 3-41 ToS Switching Control screen	3-33
Figure 3-42 ToS Switching Entry dialog	3-33
Figure 3-43 ToS Delete prompt	3-34
Figure 3-44 ToS View screen	3-34
Figure 3-45 Unit Role prompt	3-35
Figure 3-46 Expansion Unit prompt	3-35
Figure 3-47 Network ID prompt	3-36
Figure 3-48 Unit Name prompt.	3-36
Figure 3-49 Receive Multicast IP Address prompt	3-37
Figure 3-50 Managing IP address menu	3-37
Figure 3-51 DPC Configuration screen (STDMA mode).	3-39
Figure 3-52 DPC Configuration screen (SCPC mode).	3-39
Figure 3-53 Maximum Power Level prompt (CDM-570L)	3-40
Figure 3-54 Minimum Power Level prompt (CDM-570L)	3-41
Figure 3-55 Maximum Step Down Power prompt.	3-41
Figure 3-56 Maximum Step Up Power prompt	3-41
Figure 3-57 Target EbNo prompt	3-42
Figure 3-58 Target Range prompt	3-42
Figure 3-59 Speed Up EbNo prompt	3-43
Figure 3-60 Target DPC Address prompt	3-43

Figure 3-61 Home State Configuration screen	3-44
Figure 3-62 Force Modem to Home State warning	3-45
Figure 3-63 Transmit Frequency prompt	3-45
Figure 3-64 Transmit Data Rate prompt	3-46
Figure 3-65 Transmit FEC Type prompt	3-46
Figure 3-66 Transmit Coding Rate prompt	3-46
Figure 3-67 Transmit Modulation Type prompt	3-47
Figure 3-68 Transmit Power Level prompt	3-47
Figure 3-69 Receive Frequency prompt	3-47
Figure 3-70 Receive Data Rate prompt	3-48
Figure 3-71 Receive FEC Type prompt	3-48
Figure 3-72 Receive Coding Rate prompt	3-49
Figure 3-73 Receive Modulation Type prompt	3-49
Figure 3-74 Vipersat Summary screen	3-50
Figure 3-75 Vipersat Migration prompt	3-51

Appendix A Figures

Figure A-1 The Seven OSI Protocol Layers	A-2
Figure A-2 Bits and Bytes	A-4
Figure A-3 Binary to Decimal Conversion	A-4
Figure A-4 IP Address Classes A, B, C	A-7
Figure A-5 NAT Router Example	A-8
Figure A-6 Default Subnet Masks for IP Classes	A-9
Figure A-7 ANDing an IP address and a subnet mask	A-10
Figure A-8 Network Segments	A-10
Figure A-9 Router as Default Gateway	A-11
Figure A-10 Network Node MAC Addresses	A-12

Appendix B Figures

Figure B-1 Hub autoswitching menu	B-5
Figure B-2 Autoswitching menu for a remote	B-7
Figure B-3 Load switching diagram	B-8

Figure B-4 Application switching diagram	B-11
Figure B-5 ECM switch recovery < 3 minutes	B-15
Figure B-6 ECM switch recovery > 3 minutes	B-16

Appendix C Figures

Figure C-1 DPC Scaling Function	C-4
---------------------------------	-----

Appendix D Figures

Figure D-1 Firmware Migration Stages	D-4
Figure D-2 Initial Vload screen	D-5
Figure D-3 Add All dialog	D-5
Figure D-4 Get Information for IP Address	D-6
Figure D-5 Put Application screen (Consecutive Load)	D-7
Figure D-6 Hard Reset screen	D-7
Figure D-7 Unit Information screen (Router)	D-8
Figure D-8 Select Configuration screen	D-8
Figure D-9 Configuration File Text	D-9
Figure D-10 Browse for Firmware File	D-9
Figure D-11 Download v1.4.5 and Hard Reset screen	D-10
Figure D-12 Unit Information screen (Base Modem Image 1)	D-10
Figure D-13 Download v1.5.1 and Hard Reset screen	D-11
Figure D-14 Unit Information screen (Base Modem Image 2)	D-11
Figure D-15 Unit Information screen (Base Modem v1.5.1)	D-12
Figure D-16 Unit Information screen (final status)	D-12
Figure D-17 Main Menu screen, CLI	D-13
Figure D-18 Vipersat Configuration screen	D-14
Figure D-19 Vipersat Migration prompt	D-14

GENERAL

How to Use This Manual

This manual documents the enhanced Vipersat features and functions of the CDM-570/570L Satellite Network Modem Router, and guides the user in how to configure this product for use in a Vipersat network. The material covered addresses only those areas specific to a CDM-570/570L running in Vipersat mode, and complements the universal features and functions described in the *CDM-570/570L Installation and Operation Manual*.

Earth station engineers, technicians, and operators responsible for the configuration and maintenance of the CDM-570/570L are the intended audience for this document.

Manual Organization

This User Guide is organized into the following sections:

Chapter 1 — General

Contains CDM-570/570L product description, customer support information, and manual conventions and references.

Chapter 2 — Quick Start Configuration

Covers the initial basic steps that are necessary for configuring the CDM-570/570L from a factory default state to a functional network element.

Chapter 3 — Using the Command Line Interface (CLI)

Describes the use of the CLI for configuring and monitoring the CDM-570/570L in a Vipersat network. Each CLI screen is presented along with a detailed description and related commands.

Appendix A — Network Addressing

Supplemental reference information on binary math and network addressing to assist with integrating the CDM-570/570L into a Vipersat network.

Appendix B — Automatic Switching

Supplemental reference information on the Vipersat feature that provides load switching (response to network traffic load), application switching (response to traffic type) functions, and Entry Channel Mode switching functions.

Appendix C — Dynamic Power Control

A description of Vipersat's DPC and its relationship to a CDM-570/570L configuration.

Appendix D — Network Migration

Procedural instructions on upgrading a network of CDM-570/CDD-564 series modems to firmware version 1.5.3.

Conventions and References

The following conventions are utilized in this manual to assist the reader:



Note: Provides important information relevant to the accompanying text.



Tip: Provides complementary information that facilitates the associated actions or instructions.



Caution: Explanatory text that notifies the reader of possible consequences of an action that they should be aware of.

The following documents are referenced in this manual, and provide supplementary information for the reader:

- *CDM-570/570L Modem Installation and Operation Manual* (Part Number MN/CDM570L.IOM)
- *Vipersat Management System User Guide* (Part Number 22156)

Product Description

Introduction

The Vipersat CDM-570 and CDM-570L (L-band) Satellite Network Modem Routers offer state of the art performance and reliability in a sophisticated and cost-effective 1RU package. The CDM-570/570L integrates router functionality into the modem, completely eliminating external serial port cabling, and allowing connection of a 10/100 Base-T LAN/WAN directly to the modem.

The CDM-570/570L integrated modem/router and communications controller operates as a Hub or Remote utilizing TDM/STDMA, SCPC, and IP circuit switched management, offering flexibility and control of private satellite networks. The CDM-570/570L is designed to connect low- to high-speed data link connections between Ethernet LAN to WAN networks, providing a variety of communications services to Operators, Service Providers, and Enterprise Users. The benefit of this architecture yields seamless bandwidth management-on-demand, while simplifying network capacity needs.

Modem Features

- 50–90 MHz or 100–180 MHz IF Range (CDM-570)
950–1950 MHz IF Range (CDM-570L)
- BPSK, QPSK, OQPSK, 8-PSK, 8-QAM, or 16-QAM Operation
- Data Rate Range from 2.4 kbps up to 9.98 Mbps, depending on modulation and FEC used (with FAST feature upgrade)
- Turbo Product Coding (TPC) FEC
- Fast Acquisition Demodulator
- Variable Bit Rate (to 1 bps)
- Programmable TDM/STDMA or dSCPC (dynamic SCPC) Access Control
- BUC 10 MHz Reference and FSK Communications, and optional BUC Power Supplies (CDM-570L)
- LNB Power Supply and 10 MHz Reference (CDM-570L)
- 1:1 Remote, and N:M Hub Modem Redundancy Schemes

Router Features

- Fully Integrated Network Management using Vipersat Management System (VMS)
- Single Hop On Demand (SHOD) Functions

- Multi-Transponder Mode (MTM) Functions
- Dynamic Power Control (DPC) for Environment or Mesh Links
- Upstream Bandwidth Management Switching for Application, Load, Scheduled, Manual, or VESP
- Dynamic SCPC (dSCPC) Bandwidth-On-Demand
- 10/100BaseT Ethernet LAN/WAN Interface
- Per Route IP Filtering
- Multi-Protocol Support
- Built-In Header and Payload Compression for Improved Satellite Bandwidth Efficiencies
- Built-In Quality of Service (QoS) Functions for Traffic Prioritization
- Software Version Management via FTP or VLoad
- 3xDES Decryption

Network and Bandwidth Management

The Vipersat network solution integrates this advanced modem/router with the powerful network management tool, the Vipersat Management System (VMS). The VMS provides for traditional monitor and control of the CDM-570/570L modem, but more than just an M&C package, the VMS allows these units to share bandwidth, and when needed, switch automatically to a dedicated SCPC channel.

Dynamic SCPC (dSCPC)

The VMS allows for dynamic point-to-point mesh connections to be established between remotes. Traffic inbounds from remotes can be switched: manually or automatically, application or load triggered, or scheduled, from shared STDMA (burst) mode, to a dedicated SCPC connection. Once the session is completed, the remote is automatically switched back to shared mode.

While in SCPC mode, the VMS provides for dynamic bandwidth allocation, automatically altering the bandwidth based on traffic conditions. This effectively enables the network to better handle connection oriented applications and reduce network congestion, jitter, and latency.

The result is an economical and flexible network with bandwidth shared and directed where it is needed for any mix of IP voice, video, and data traffic.

Turbo Product Coding

The Comtech Vipersat CDM-570/570L incorporates a Turbo Product Codec (TPC). TPC is a FEC technique that delivers significant performance improvement when compared to Viterbi with concatenated Reed-Solomon. TPC simultaneously offers increased coding gain, lower decoding delay, and significant bandwidth savings.

Header Compression

Configurable on a per route basis, Header Compression reduces the required Voice over Internet Protocol (VoIP) bandwidth by as much as 60%. Example: a G.729 voice codec operating at 8 kbps will occupy 32 kbps once encapsulated into IP framing on a LAN. Using IP/UDP/RTP Header Compression, the same traffic only needs 10.8 kbps total WAN satellite bandwidth to cross the link. Normal Web/HTTP traffic can be reduced by an additional 10% via IP/TCP Header Compression.

Payload Compression

Compressing Payload condenses the size of data frames and reduces the satellite bandwidth required to transmit across the link. Configurable on a per route basis, Payload Compression optimizes traffic and reduces bandwidth up to 40%.

Quality of Service

The CDM-570/570L supports multi-level QoS that minimizes jitter and latency for real time traffic, provides priority treatment to mission critical applications, and allows non-critical traffic to use the remaining bandwidth. Three modes are available: Max/Priority, Min/Max, and Diff Serv.

Data Encryption

The CDM-570/570L provides 3xDES data encryption to prevent unauthorized access to data over the satellite link. Encryption is configurable on a per route basis

New in this Release

The following firmware versions incorporate a number of additional features and enhancements.

1.5.3 Release

New Redundancy Features

Redundancy Heartbeat Message for Primary Hub Units

Provides the option for a periodic communications check message to be sent from the Hub modem to the VMS for backup recovery in N:M redundancy (protected) configurations. This feature allows the message interval to be specified by the administrator, and can be enabled through either the CLI or the VMS.

New QoS Features

Dynamic Buffering

Reduction of overall system latency is now optimized in the Vipersat network by dynamic buffering enhancements that provide a minimum buffer size of 2 MB, with a user-specified latency period (five second maximum).

QoS Rule Switching

With QoS Rule Switching, an STDMA to SCPC switch can be initiated based upon any type of IP traffic flow that matches a defined QoS queue.

Burst Fast Acquisition Timing (BFAT)

The BFAT feature provides dramatic reduction in data acquisition times for Vipersat modems operating in STDMA (burst) mode at low data rates (64 kbps to 256 kbps). Preamble size is automatically recalculated and adjusted by the modem for optimum performance. This feature can be enabled in modems operating at 3/4 QPSK.

STDMA Slot Quantization

Utilizing Turbo FEC Block mode, Vipersat STDMA Slot Quantization automatically sizes the data slot to hold an integral number of FEC blocks, based on the current data rate. This results in increased STDMA efficiency.

RTP Inactivity Timeout

The timeout period for Real-time Transfer Protocol (e.g., voice, video) data flows is now set for 10 seconds of inactivity to reduce the wait period until the next switch state occurs, thus increasing SCPC bandwidth utilization.

Parameter File Consolidation

Configuration parameters for the entire CDM-570/570L modem (base modem plus IP router module) are now stored in one common parameter file. All

modem parameters are now preserved across firmware upgrades and reboots, eliminating a potential cause of communications failure.

Vipersat File Streaming (VFS)

The Vipersat File Streaming feature option allows data files to be streamed over the Vipersat network at high transmission rates between PC hosts running the VFS application.

Automatic Home State Control (Remote Unit)

VMS communications management of Remote units is now improved with the Home State Revert feature. By configuring a time value (in minutes) in the VMS for each Remote in the network, resource recovery is performed on SCPC connections when a communications failure occurs between the VMS and a Remote, such as a rain fade condition, a Remote unit power down, or a hardware failure. Should communications be lost for more than the selected time period, the Remote will automatically revert to its Home State settings and the VMS will remove all allocated resources (bandwidth, demod(s)), freeing them for use by any other Remotes in the network.

ECM User Defined Switch Type

New SCPC switching flexibility is provided by the Entry Channel Mode (ECM) user-defined policy switch type feature. The STDMA Remote Policies can be set for the desired SCPC data rate (kbps) and the Switch Type (0=Load, 64-255 range is user-defined).

Customer Support

Contact Information

Contact Comtech Vipersat Networks Customer Support for information or assistance with product support, service, or training on any Vipersat product.

Mail: 3215 Skyway Court
Fremont, CA 94539
USA

Phone: 1+510-252-1462

Fax: 1+510-252-1695

Email: support@vipersat.com

Return Material Authorization

Any equipment returned to Vipersat must have a Return Material Authorization (RMA) issued prior to return. To return a Comtech Vipersat Networks product for repair or replacement:

- Obtain an RMA number from Vipersat Customer Support.
- Be prepared to supply the product model number and serial number of the unit.
- To ensure safe shipping of the product, pack the equipment in the original shipping carton.

Reader Comments / Corrections

If the reader would like to submit any comments or corrections regarding this manual and its contents, please forward them to a Vipersat Customer Support representative. All input is appreciated.

{ This Page is Intentionally Blank }

QUICK START CONFIGURATION

Introduction

This chapter describes the minimum configuration of a Vipersat CDM-570/570L Modem/Router that is necessary in order for the equipment to function in a Vipersat network.

The Vipersat CDM-570/570L stores its configuration in an ASCII file named the **PARAM** file. Equipment configuration is typically performed through the use of the Command Line Interface (CLI), particularly the initial configuration. Once the equipment is functioning in the network, additional configuration can be performed via the VMS.

Refer to Chapter 3, “Using the Command Line Interface,” for a detailed description on the usage of this feature.

This manual covers the configuration specifics of the CDM-570/570L when used in a Vipersat network. Refer to the *CDM-570/570L Installation and Operation Manual* (Part Number MN/CDM570L.IOM) for general instruction on setting up, installing and configuring this equipment.



Note: Before attempting to configure a CDM-570/570L to be used in a Vipersat network, make certain it has the Vipersat option installed and enabled.



Caution: Do not connect the TX cable until the modem is properly configured, and the Home State is verified and Saved.



Caution: Do not connect the TX and RX cables to test equipment without the use of a DC voltage block. If BUC or LNB power is disabled through the CLI, the setting must be Saved to prevent accidental re-enabling during modem reboot or power-cycle.

Initial Configuration



Note: Many of the settings required for equipment configuration are based on the LAN/WAN and Satellite network design, and should be obtained from the network administrator.

Terminal Connection

These procedures are performed using the CLI from a workstation connected to the modem/router either via a direct connection to the **Console** port (a console cable is shipped with each unit), or via a telnet connection to the **Traffic 100** port. Alternatively, HyperTerminal or any of the other connection methods described in the *CDM-570/570L Installation and Operation Manual* may be used.

Make a terminal connection to the target CDM-570/570L modem/router. If connecting via the Traffic 100 Ethernet port (do **not** use the M&C port), enter the IP address of the unit. The factory default IP address is **192.168.1.1**. Configure the terminal for VT-100 emulation mode. Once a terminal connection has been made, the CDM-570/570L will respond with a Login prompt. The factory defaults are:

Login: **comtech**

Password: **comtech**

Once the operator has logged in, the **Main Menu** shown in figure 2-1 is displayed.

Network Role

The first and most important step prior to configuring the CDM-570/570L is to define its network role.

The CDM-570/570L is a flexible network component able to perform different functions depending on how it is used in a network. The role that is defined for each CDM-570/570L will determine what functions are available for each unit to fill its role. Refer to the section “Unit Role” on page 3-35 for details on setting a CDM-570/570L’s network role. Table 2-1 lists the network roles and the corresponding network functions for which the CDM-570/570L can be configured.

Table 2-1 CDM-570/570L Network Roles and Functions

CDM-570/570L Network Role/Function	Hub	Remote	Expansion
Hub Burst Controller providing STDMA Timing Maps	X		
Hub Point-to-Point SCPC Modem	X		
Hub Switched Demodulator	X		X
Remote STDMA Modem		X	
Remote Point-to-Point SCPC Modem		X	
Remote Mesh Demodulator		X	X

Setting Vipersat CDM-570/570L Operating Parameters

The following is an example of using the CLI to bring a Vipersat CDM-570/570L with factory default settings to the configuration which allows the Vipersat functions to be accessible.

When the parameter file (**param image**) of the CDM-570/570L has either been reset to or still has the factory default configuration, all Vipersat feature and unlock codes in the CDM-570/570L are deleted and all configurations are reset, disabling the Vipersat feature set.

Set the Feature Configuration

The operating parameters that will be configured in the target CDM-570/570L are, in part, determined by the role the CDM-570/570L is to fill in the network, as shown in table 2-1 and table 2-2.

Use the following procedure to configure a CDM-570/570L to the network role it is to fill in a Vipersat network.

1. From the **Main Menu** shown in figure 2-1, select the **Administration** command by entering **A** at the command prompt.

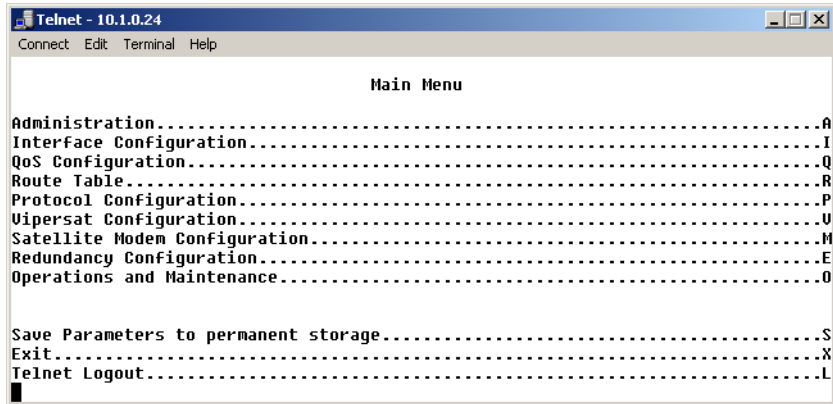

Figure 2-1 Main Menu screen

- From the **Administration** screen shown in figure 2-2, select the **Features Configuration** command by entering **F** at the command prompt.

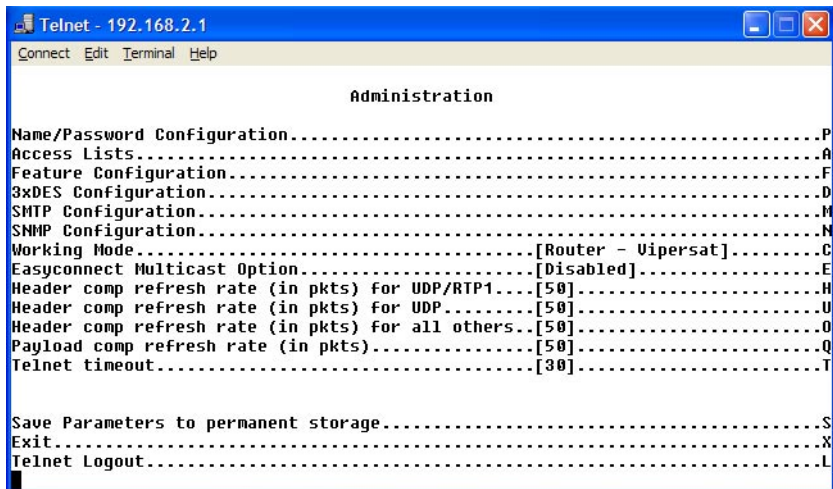

Figure 2-2 Administration screen

- From the **Feature Configuration** menu shown in figure 2-3, verify whether or not the Vipersat Feature Codes appear as shown in the figure. These codes are entered prior to shipment from the factory; however, if the unit has been reset, the codes will have to be re-entered. If the feature codes are not displayed in the menu, enter **F** at the command prompt, then enter the 3 digit **Feature Code** followed by the **Unlock Code**, as shown in figure 2-4.

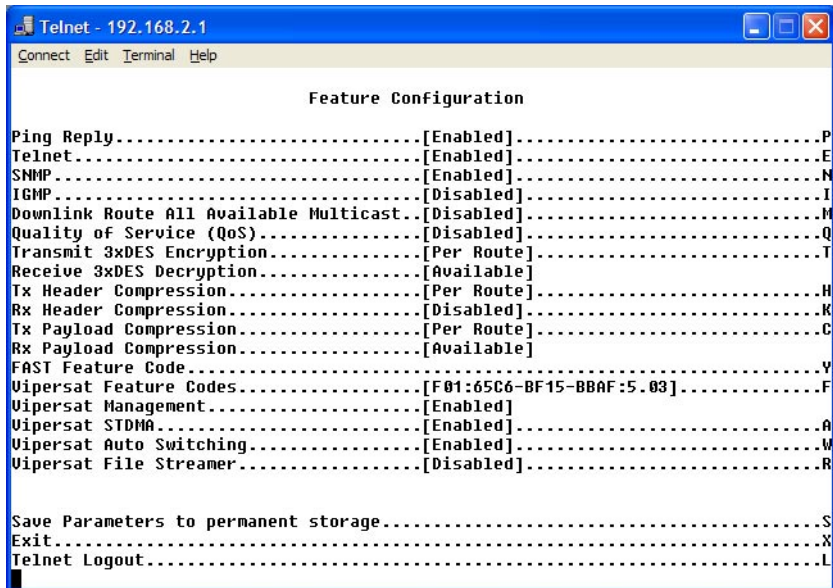

Figure 2-3 Feature Configuration screen

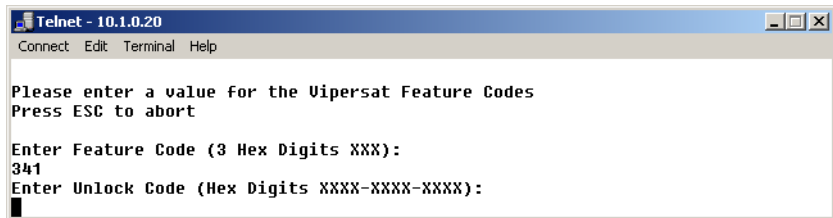

Figure 2-4 Feature and Unlock Code dialog



Tip: The network administrator will have the feature and unlock codes. These are stored by the MAC address for the target CDM-570/570L. The target unit's MAC address can be found by entering an **I** and then an **E** from the **Main Menu** shown in figure 2-1.

4. After entering the feature and unlock codes, return to the **Feature Configuration** menu, shown in figure 2-3, and enter **V** to toggle the Vipersat Management menu item to **Enabled**. The unit will automatically reboot in order to implement the change for this setting.
5. When the reboot is completed, return to the Feature Configuration menu and configure the settings for **Vipersat STDMA** and **Auto Switching** according to the table below.

Table 2-2 CDM-570/570L Network Roles and Features

Unit Role	Vipersat	STDMA	Auto Switching
Hub	Enabled	(optional) Enabled	(optional) Enabled
Hub Expansion	Enabled	Disabled	Disabled
Remote	Enabled	(optional) Enabled	(optional) Enabled
Remote Expansion	Enabled	Disabled	Disabled

- Save the settings to flash by entering **S** at the command prompt.
- Enter **X** at the command prompt to exit the **Feature Configuration** menu and return to the **Administration** screen.
- Ensure that the **Working Mode** is set to **Router-Vipersat**. If it is not, enter **C** and change the setting by selecting **4**, as shown in figure 2-5. The unit will automatically reboot in order to implement the change for this setting.

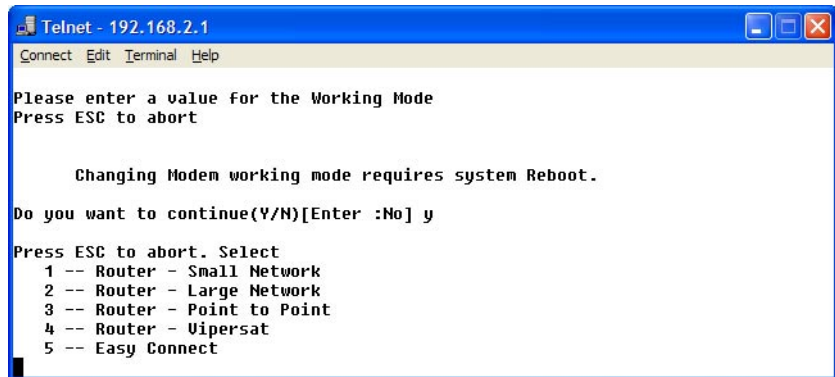
**Figure 2-5** Working Mode dialog

Set the IP Address

- From the Main Menu, enter **I** to access the **Interface Configuration** menu screen, then enter **E** to access the **Ethernet Interface** screen.
- Enter **I** at the command prompt, and enter the designated **IP address** for this unit.
- Save the settings to flash by entering **S** at the command prompt.

Configure the Route Table

Routing in a Vipersat Network

CDM-570/570L modem/routers operating in Vipersat mode do not use the small or large network described in the *CDM-570/570L Installation and Operation Manual*. There is no HDLC address in a Vipersat network; instead, the CDM-570/570L role designation — Hub or Remote, Expansion unit or not — determines routing rules that prevent multicast loops. This simplifies the configuration of a Vipersat network.

Because satellite networks are often used as extensions for access to services such as the Internet or the PSTN, they lend themselves quite readily to private addressing. For example, to provide Internet access to the satellite network, only the Hub requires a public IP address in order for the entire satellite network that is controlled by the Hub to have access to the Internet backbone. Utilizing Network Address Translation (NAT), the administrator can effectively address the network using a minimum number of static route statements.

Example:

The IP address 172.16.0.0 is the private address network number for class B networks. If there is a router at the Hub with a connection to the Internet, the operator can define the local network as a class B. If the operator splits the Class B in half and points the upper half toward the satellite there will be over 16000 usable addresses at the Hub as well as at the Remotes. For details on IP addressing, refer to Appendix A, "Network Addressing".

By putting the one route statement "Remotes 172.16.128.0/17 Wan to Sat" in the TDM Hub modem, and by using the route statement "GW 0.0.0.0/0 Wan to Sat" at each of the remote modems, the network will successfully route packets. The remotes can then be sub-netted as class C networks or below. Additional routers at the remotes can be added for unusually large sites, allowing an additional layer of NAT without requiring any more explicit routing within the Vipersat Modem/Routers.

Refer to the *CDM-570/570L Installation and Operation Manual* for additional information on entering routes.

Creating the Routes

The following procedure outlines the basic route structure that the target CDM-570/570L will require for its role in the network. One of the key routes

that must be created is a gateway address for routing the data traffic that is received by the unit.

1. From the **Main Menu** shown in figure 2-1, select **Route Table** by entering **R** at the command prompt.
2. From the **Configuring the Route Table** screen shown in figure 2-6, enter **1** at the command prompt to set the first route that will define the default gateway.

```

Telnet - 192.168.0.10
Connect Edit Terminal Help

              Configuring the Route Table
Route Name   Dest IP/SMet Bits  Next Hop      MultiCast State
Route001... [DFG           0.0.0.0/0      192.168.0.1   N/A          toEth]..1
Route002... [Remotes     192.168.1.0/24  WAN           N/A          toSat]..2
Route003... [UNKNOWN].....3
Route004... [UNKNOWN].....4
Route005... [UNKNOWN].....5
Route006... [UNKNOWN].....6
Route007... [UNKNOWN].....7
Route008... [UNKNOWN].....8
Base..... [1].....B
Delete.....D
Display.....P
PerRoute.....E
DL Mcast... [Disabled]
AddFilter.....A
DelFilter.....R

Save Parameters to permanent storage.....S
Exit.....X
Telnet Logout.....L

```

Figure 2-6 Configuring the Route Table screen

In a Hub configuration, the default route will typically point to a router on the same LAN as the CDM-570/570L Hub unit.

In a Remote configuration, the default route will typically point to the satellite modem used for communications back to the Hub.

3. When prompted, enter the **Route Name** (GW), the **IP Address**, the **Number of Bits** in the subnet mask, the **Route Interface** (Ethernet or Satellite), and the **Next Hop** address. The system administrator can supply this information, if necessary.

In a Hub role, for example, enter the name of the route (e.g., **DFG**), enter **0.0.0.0** for the destination IP address and **0** for the mask, enter **E** for Ethernet interface, then enter the **IP address** of the appropriate router or modem for the next hop.

If this Hub unit is providing the TDM outbound, a route statement or statements defining satellite communications with the Remote units must be entered as well. One recommended option is to enter a single super-route that will handle satellite communications with all of the remote subnets; an example of this is shown as Route002 in figure 2-6, above.

4. Enter **S** at the command prompt in figure 2-6 to save the settings to flash.

Set the Satellite Modem Configuration

1. Enter **M** from the **Main Menu**, then enter **C** from the **Satellite Modem** menu to access the **Configuration** screen.
2. Enter **T** to access the **Tx Configuration** screen shown in figure 2-7. Set the Tx parameters for **Frequency**, **Data Rate**, **FEC**, **Code Rate**, and **Modulation** as specified by the network administrator.

Note that only **Turbo** Product Coding is acceptable for FEC when the CDM-570/570L is running in Vipersat mode.

```

Telnet - 192.168.0.10
Connect Edit Terminal Help

                          Tx Configuration

Tx Frequency.....[1205.0000].....Q
Tx Data Rate.....[1024.000].....D
Tx Symbol Rate.....[0682.667]
Tx FEC.....[Turbo].....T
Tx Code Rate.....[3/4].....R
Tx Modulation.....[QPSK].....M
Tx Spectrum Inversion..[Normal].....U
Tx Data Inversion.....[Normal].....I
Tx Scrambling.....[On-Default].....B
Tx Power Level.....[18.0].....P
Tx Carrier.....[On].....C
Tx Clock Source.....[Internal]

Save Parameters to permanent storage.....S
Exit.....X
Telnet Logout.....L

```

Figure 2-7 Tx Configuration screen

3. Enter **R** to access the **Rx Configuration** screen, and set the Rx parameters as specified by the network administrator.
4. Save the settings to flash by entering **S** at the command prompt.

Set the Vipersat Configuration

1. Enter **V** at the **Main Menu** command prompt shown in figure 2-1 to select the **Vipersat Configuration** menu shown in figure 2-8.

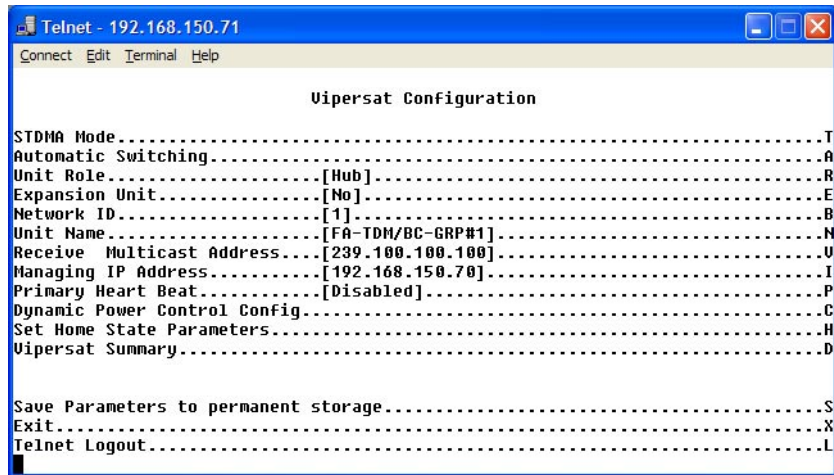

Figure 2-8 Vipersat Configuration screen (Hub)

2. Enter **R** at the command prompt to toggle the **Unit Role** to either **Hub** or **Remote**.
This parameter will determine the role the target CDM-570/570L will perform in the network and what type of commands and functions it will receive from the VMS.
3. Enter **E** to set the **Expansion Unit** value (**Yes** or **No**).
When configured as an expansion unit, either as a hub (switched) or as a remote (mesh), the CDM-570/570L is set up so that the demod is in SCPC mode and available as a resource for dedicated communications with the other end of the satellite link.
4. Enter **B** at the command prompt to set the **Network ID**.
The Network ID that is assigned to the unit defines to what network the target CDM-570/570L will belong. All units used in a network will have the same Network ID. This parameter is used by the VMS to identify units common to a network and allows the VMS to manage multiple networks, each with its own unique network ID number.
5. Enter **N** at the command prompt to set the **Unit Name**.

Initial Configuration

6. Enter **V** at the command prompt to set the **Receive Multicast Address**. The Receive Multicast Address is the multicast IP address assigned to the VMS and to all units in the network. The Hub modem transmits the multicast to this IP address, and the Remotes receive the multicast on this address.
7. Enter **I** at the command prompt to set the **Managing IP Address**. The Managing IP Address is the IP address of the VMS server.
8. Enter **H** to go to the **Home State Configuration** menu screen, then enter **W** to set the current configuration as the home state.
9. Save the settings to flash by entering **S** at the command prompt.

This completes the initial configuration of a CDM-570/570L from the factory default settings to a functioning, Vipersat-enabled unit. Additional configuration parameters must be set depending on the network requirements for a specific application.

Refer to Chapter 3, “*Using the Command Line Interface*,” for additional details on configuring the target Vipersat CDM-570/570L.

USING THE COMMAND LINE INTERFACE (CLI)

General

This chapter describes the use of the CLI for configuring and monitoring the CDM-570/570L Modem Router in a Vipersat network. Each CLI screen related to a CDM-570/570L operating in Vipersat mode is presented, along with a detailed description of the available commands. For descriptions of all other screens, refer to the *CDM-570/570L Installation and Operation Manual*.

Access to the CLI is provided through either the **Console** port (local, RS-232) or the 10/100BaseT Ethernet **Traffic** port (Telnet, IP). Access via Telnet requires login with password, Console access does not require login. The screens presented in this document are as they appear when the CDM-570/570L is accessed using Telnet.

Common Screen Commands

The following commands appear on each of the menu screens:

Save Parameters to Permanent Storage

To **Save** the current parameter settings to permanent storage, enter **S** at the command prompt. This command saves all data that has been entered from any of the CLI screens since the last save was executed. Exiting a screen without saving after parameters have been changed does not mean that the changes are

not applied. However, if these changes are not saved prior to a system reset or power cycle, they will be lost.

Exit

To **Exit** the current menu screen and return to the previous screen in the menu tree, enter **X** at the command prompt.

Telnet Logout

Enter **L** at the command prompt to **Logout** of the Telnet session. This command appears only when connected via Telnet.

Menu Descriptions

This section details the CLI command menus and briefly discusses the function of each of the commands available on each menu.

Main menu

The **Main Menu**, shown in figure 3-1, allows configuring both the modem and router functions of the target CDM-570/570L.



Note: The entry **Vipersat Configuration** shown in figure 3-1 will only be displayed if the target CDM-570/570L has had the Vipersat option enabled as described in the section “Setting Vipersat CDM-570/570L Operating Parameters” on page 2-4.

```

Telnet - 10.1.0.24
Connect Edit Terminal Help

Main Menu

Administration.....A
Interface Configuration.....I
QoS Configuration.....Q
Route Table.....R
Protocol Configuration.....P
Vipersat Configuration.....U
Satellite Modem Configuration.....M
Redundancy Configuration.....E
Operations and Maintenance.....O

Save Parameters to permanent storage.....S
Exit.....X
Telnet Logout.....L

```

Figure 3-1 Main Menu screen

A Vipersat CDM-570/570L is normally shipped with the Vipersat option enabled. You can verify the CDM-570/570L configuration by checking that the command line **Vipersat Configuration** is displayed on the menu as shown in Figure 3-1.

Administration

The **Administration Menu** also contains Vipersat CDM-570/570L commands. Entering an **A** at the prompt in the **Main Menu**, shown in figure 3-1 displays the **Administration** screen shown in figure 3-2.

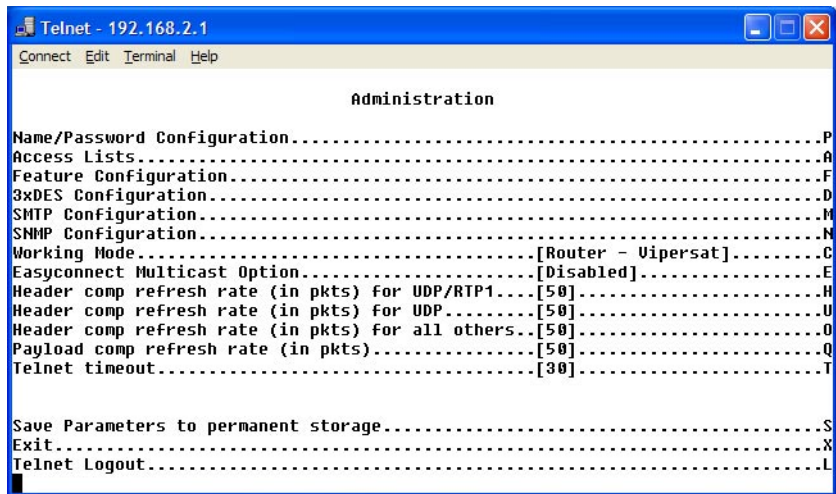

Figure 3-2 Administration screen

Enter an **F** at the prompt to display the **Feature Configuration** screen shown in figure 3-3.

Feature Configuration

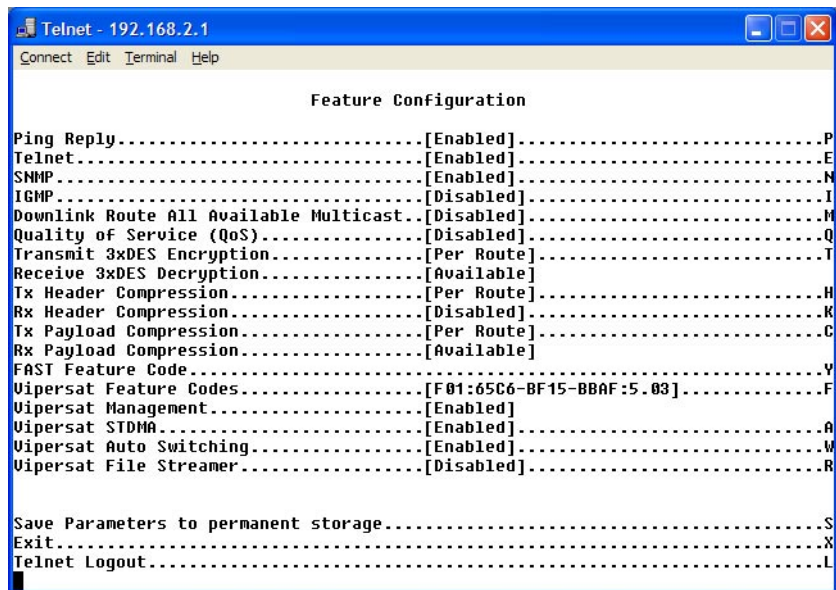

Figure 3-3 Feature Configuration screen

The **Feature Configuration** screen shown in figure 3-3 allows enabling and disabling CDM-570/570L features.

Use this menu to enable and disable Vipersat features such as:

- Vipersat STDMA
- Vipersat Auto Switching
- Vipersat File Streamer



Note: You must enable and disable these Vipersat features using this screen. They cannot be enabled or disabled from the Vipersat Configuration screen.

Vipersat Feature Codes menu

The Vipersat feature codes can be entered as three hexadecimal digits at the command prompt as shown figure 3-4 and determine which Vipersat features have been purchased for the target CDM-570/570L and are available for use.

```

Telnet - 10.1.0.20
Connect Edit Terminal Help

Please enter a value for the Vipersat Feature Codes
Press ESC to abort

Enter Feature Code (3 Hex Digits XXX):
341
Enter Unlock Code (Hex Digits XXXX-XXXX-XXXX):

```

Figure 3-4 Feature and unlock code dialog

Similarly, unlock codes determine which CDM-570/570L features have been purchased and are available for use on the target CDM-570/570L.



Tip: You may find it more convenient to use the Vipersat Vload utility to manage feature and unlock codes.

Vipersat Management

This item is an information only display and indicates whether Vipersat Management is enabled or disabled in the target Vipersat CDM-570/570L. Activation of the Vipersat Feature Code automatically enables the Vipersat Management feature.



Caution: This command must be enabled in order to use any of the Vipersat capabilities of the CDM-570/570L.

Vipersat STDMA

In order to utilize the Vipersat STDMA feature in the target Vipersat CDM-570/570L, this feature must be enabled. Enter **A** at the command prompt to toggle on or off.

Vipersat Auto Switching

In order to utilize the auto switching capabilities of the target Vipersat CDM-570/570L, toggle the auto switch command to enabled by entering **W** at the command prompt. Vipersat Auto Switching must be enabled for networks requiring Load or Application switching to SCPC connections.

Vipersat File Streamer

Vipersat File Streamer (VPS) is an optional feature that allows rapid file transfers over the satellite network between host PCs that are running the client VPS application. To activate the Vipersat File Streaming capabilities of the target Vipersat CDM-570/570L, toggle this command to enabled by entering **R** at the command prompt.

Once the parameters on the **Feature Configuration** screen have been set as desired, return to the **Main Menu** shown in figure 3-1 and enter the **V** command to display the **Vipersat Configuration** screen shown in figure 3-5.

Vipersat Configuration

Enter **V** at the command prompt from the CDM-570/570L **Main Menu** shown in figure 3-1 to display the **Vipersat Configuration** screen shown in figure 3-5.

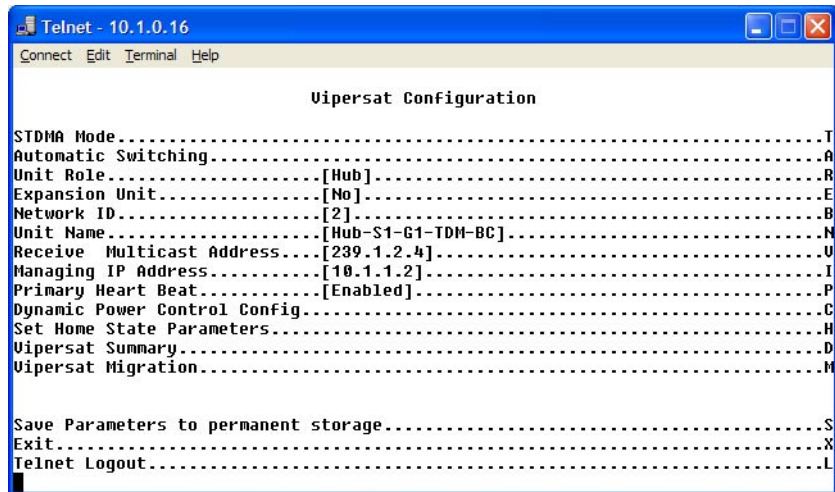

Figure 3-5 Vipersat Configuration screen (Hub)

This menu lists the available commands for configuring a Vipersat CDM-570/570L. Note that for the Hub modem only, the command **Primary Heart Beat** is displayed in the Vipersat Configuration screen. For the Remote modem only, the status of the **Home State Revert** setting is displayed.

Each of these commands is explained in the following sections.

STDMA Mode

The items in the **STDMA** menu will vary depending on the function the target CDM-570/570L performs in the network. The CDM-570/570L **STDMA** menu shown in figure 3-6 is from a CDM-570/570L serving as a Hub in the network.

For comparison, the STDMA Mode menu for a CDM-570/570L operating as a Remote unit is shown in figure 3-7. Note that some of the command items differ between these two screens, and most of the items on the Remote screen are information-only display.

```

Telnet - 192.168.150.71
Connect Edit Terminal Help

                                STDMA

STDMA.....[Enabled]
STDMA Tx Rate.....[512000 bps]
Hub Type.....[Dynamic Cycle].....T
Group ID.....[100].....I
Low Data Rate Fast Acquisition.....[Disabled].....A
Burstmap Multicast IP.....[239.10.10.10].....N
Outbound IP.....[192.168.150.71].....O
Slot Guardband.....[ 50 mSec ( 3200 bytes)].....G
Slot Preamble Length.....[ 55 mSec ( 3520 bytes)].....P
Maximum Data Length.....[ 200 mSec (12800 bytes)].....B
Minimum Data Length.....[ 50 mSec ( 3200 bytes)].....M
Slot Cycle Length.....[ 316 mSec (20224 bytes)]
Set Remotes.....R
STDMA Statistics.....U
Show Hub Statistics.....W

Save Parameters to permanent storage.....S
Exit.....X
Telnet Logout.....L

```

Figure 3-6 STDMA screen (Hub, Dynamic Cycle type)

```

Telnet - 192.168.2.1
Connect Edit Terminal Help

                                STDMA

STDMA.....[Enabled]
STDMA Tx Rate.....[512000 bps]
Group ID.....[100].....I
Low Data Rate Fast Acquisition.....[Disabled].....A
Burstmap Multicast IP.....[239.10.10.10].....N
Cycles Per Burst Map.....[1]
Slot Guardband.....[ 50 mSec ( 3200 bytes)]
Slot Preamble Length.....[ 55 mSec ( 3520 bytes)]
Nominal Data Length.....[ 53 mSec ( 3392 bytes)]
Slot Cycle Length.....[ 316 mSec (20224 bytes)]
Slot Start in Cycle.....[ 0 mSec ( 0 bytes)]
STDMA Statistics.....U

Save Parameters to permanent storage.....S
Exit.....X
Telnet Logout.....L

```

Figure 3-7 STDMA screen (Remote)

STDMA

This menu item is read-only and shows the current state of STDMA in the CDM-570/570L. In order to change the STDMA state in the CDM-570/570L, refer to the section “Feature Configuration” on page 3-4.

STDMA Tx Rate

This menu item shows the STDMA transmit rate in bps. This item is read-only and cannot be modified in this menu.

Hub Type

This menu item is only displayed if the CDM-570/570L is being used as a Hub in the network. Vipersat STDMA has five modes of operation:

- **Fixed** - All remotes get the same size slot, regardless of each remote's activity
- **Dynamic Slot** - Slot size is adjusted each cycle depending on activity during the previous cycle
- **Dynamic Cycle** - A dynamic cycle allows changing the cycle time, and corresponding latency, as loads change always providing minimum latency for the current traffic load.
- **GIR** - Guaranteed Information Rate allows assigning a guaranteed data rate to a channel.
- **Entry Channel** - Entry channel mode provides an on-demand channel for applications such as a mobile remote.

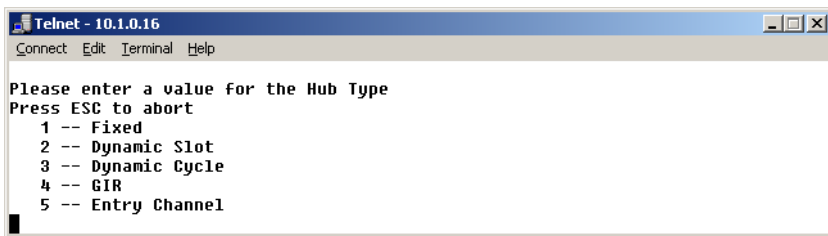

Figure 3-8 Hub Type prompt

Entering a number from **1** to **5** at the command prompt determines the bandwidth allocation mode for the Hub CDM-570/570L.



Note: If the selected Hub STDMA mode is **GIR** (Guaranteed Information Rate) or **Entry Channel**, normal load switching is automatically disabled. In GIR mode, the Remote is switched to SCPC as soon as the GIR threshold is reached, if there is a switch rate defined. In Entry Channel mode, the Remote is switched to SCPC as soon as the Hub receives the first transmission from the Remote.

Refer to Appendix B, "Automatic Switching" for details on how each of the bandwidth allocation modes functions and the parameters and processes used to calculate the commands for each mode.

1 -- Fixed

In the **Fixed** mode, all remotes have the same slot size regardless of type of traffic or load.

2 -- Dynamic Slot

In the **Dynamic Slot** mode, the slot size for each remote is computed based on the time (at the current data rate) needed to transmit all the Bytes in Queue. If the result is less than the minimum slot size or more than the maximum slot size, the slot is adjusted accordingly.

3 -- Dynamic Cycle

In the **Dynamic Cycle** bandwidth allocation method, available bandwidth is allocated to remotes proportionally based on their current bandwidth needs. The bandwidth requirements are determined by the number of bytes in queue for each remote divided by the total number of bytes in queue for all remotes to determine the percentage of bandwidth to allocate for each remote.

4 -- GIR

In the **GIR** mode, the initial computed slot size value is the same as the Dynamic Cycle mode except there is no maximum limit. After all remotes have been assigned slots, the burst map is checked to see if the total cycle length exceeds 1 second. If not, then all requirements are satisfied and the burst map is complete. However, if the cycle is greater than one second, then the slots are adjusted proportionally so that all remotes receive at least their guaranteed rate plus whatever excess is still available.

In this software version, when the 1 second restriction is exceeded, remotes without a specified GIR are reduced to the global minimum slot size and the remaining bandwidth is distributed to remotes that have been assigned a GIR rate. Remotes assigned a GIR are given available excess bandwidth when needed.



Note: GIR allocations are restricted so that assigned GIR totals cannot exceed the available bandwidth to insure proper bandwidth allocation when the network is overloaded.

5 -- Entry Channel

The Entry Channel mode is the same as Dynamic Cycle mode, except that as soon as the hub receives an STDMA ACK, it initiates a switch to SCPC mode based on the policy set for that remote.

This mode is designed to accommodate the needs of a remote which will not be continuously connected to the network, but which has the need to be able to make an on-demand connection when required, such as a mobile remote.

Note that the switch occurs as soon as the hub receives an STDMA ACK even though there may not be traffic at that time. The persistence of the link will be determined by the unit's flag settings.

Refer to Appendix B, "Automatic Switching" for details on this switching mode.

Group ID

The STDMA group ID number defines a group of equipment which will respond to the output of the burst controller. This group is addressable within a network which, in turn, is defined by the network ID number assigned to the CDM-570/570L.



Note: The STDMA group number and the network ID are independent. There can be multiple STDMA groups within a single network.

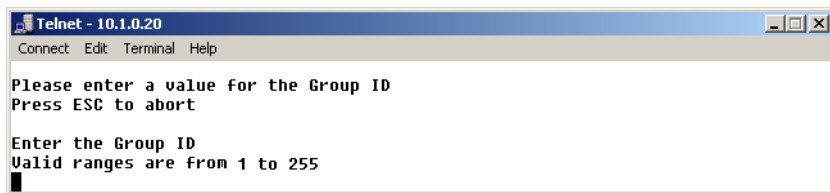

Figure 3-9 Group ID prompt

The target CDM-570/570L group ID can be modified by entering an I at the command prompt to display the dialog shown in figure 3-9.

Low Data Rate Fast Acquisition

This menu item is a toggle used to enable or disable the Vipersat **Burst Fast Acquisition Timing (BFAT)** feature that functions at low data rates (64 kbps to 256 kbps). Entering **A** at the command prompt will toggle this feature On or Off.

This feature requires Base Modem firmware version 1.5.2 or later, together with Router firmware version 1.5.3 or later.

Burstmap Multicast IP

This menu item is used to define the IP address for the Burstmap Multicast that is sent out by the STDMA burst controller at the Hub to all of the associated remotes in that group. This address must be the same for all members of the

group. The burstmap is a proprietary message sent from the Hub to all remotes, at regular intervals, specifying the relative start time and duration for each terminal to transmit.

To change the current address, enter **N** at the command prompt to display the dialog shown in figure 3-10.



Figure 3-10 Burstmap Multicast IP prompt

Outbound IP

This menu item, which appears for all Hub configurations, displays the current Outbound IP address. This specifies the Hub device that is supplying the TDM outbound to the satellite (typically a CDM-570/570L). Specifying this address is necessary when configuring a Hub that utilizes a burst controller that is a separate device from the TDM modem.

To change the target address of the TDM outbound for DPC messages for the STDMA controller, enter **O** at the command prompt to display the dialog shown in figure 3-11.

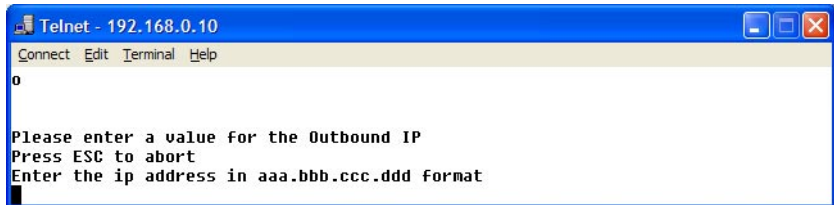

Figure 3-11 Outbound IP prompt

Cycles Per Burst Map

This menu item, which appears for all Hub types except Dynamic Cycle and GIR, displays the number of spin cycles that occur prior to each broadcast of the burstmap. This parameter can be modified from the Hub CDM-570/570L by entering a **C** at the command prompt as shown in figure 3-12. For Dynamic Cycle and GIR configurations, the number of cycles is automatically set to one in order to ensure optimum performance for these Hub types.

On Remote units, this menu item is an information-only display.

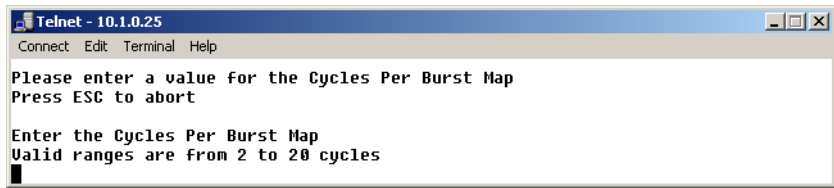

Figure 3-12 Cycles per Burst Map prompt

Slot Guardband

This menu item displays the current length of the slot guardband in milliseconds and the size of the guardband in bytes for the target CDM-570/570L.



Figure 3-13 Slot Guardband prompt

On a Hub unit, this value can be modified by entering **G** at the command prompt to display the dialog shown in figure 3-13 and entering a new value.

On Remote units, this menu item is an information-only display.



Note: Note that the value you enter at the command line in figure 3-13 is in milliseconds. The corresponding value expressed in bytes is calculated by the CDM-570/570L based on the STDMA transmit bit rate as shown in the menu in figure 3-6.

Slot Preamble Length

This menu item displays the current slot preamble size in milliseconds and bytes for the target CDM-570/570L.

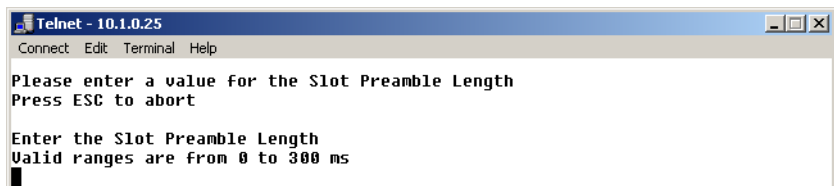

Figure 3-14 Slot Preamble Length prompt

On a Hub unit, entering **P** at the command prompt allows changing the preamble duration in milliseconds.

On Remote units, this menu item is an information-only display.



Note: Refer to the Viper Calculator for determining preamble length values to enter at the command prompt. If you not have a copy of the latest Viper Calculator, contact your Comtech Vipersat Networks representative to inquire about a copy.

Slot Data Length

This menu item displays the Slot Data Length in milli-seconds and bytes for the target CDM-570/570L, and represents the amount of data that can be transmitted or received in one spin of the STDMA cycle by each of the Remotes belonging to that group.

Depending on the Hub type that is defined for the modem, the appearance of this parameter will vary:

- *Fixed* – Slot Data Length
- *Dynamic Slot* – Nominal Data Length, Minimum Data Length
- *Dynamic Cycle* – Maximum Data Length, Minimum Data Length
- *ECM & GIR* – Minimum Data Length

On a Hub unit, entering **B** and **M** at the command prompt brings up the dialogs for specifying the data length in milli-seconds for the target CDM-570/570L, as shown in figure 3-15.

On Remote units, this menu item is an information-only display.

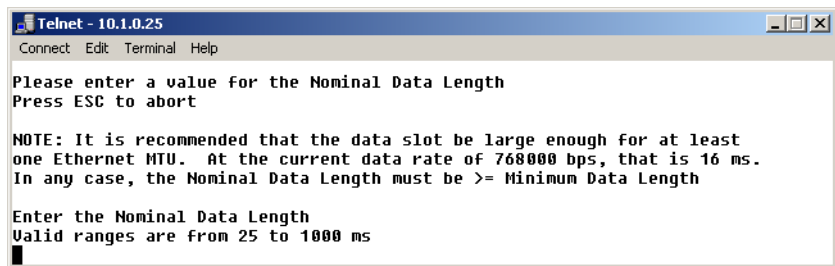

Figure 3-15 Slot Data Length (Nominal)

Slot Cycle Length

This menu item is for information only and displays the slot cycle length in milli-seconds and bytes for the target CDM-570/570L. This value represents the total amount of time (preamble, data length, and guardband) allocated to the remote modem during one spin cycle.

Slot Start in Cycle

This menu item is an information-only display for Remote modems, and indicates how much time passes from the start of the spin cycle until this Remote is provided a time slot. In the example shown in figure 3-7, the Remote is provided the first slot in the cycle (0 mSec).

Set Remotes

This menu item appears in the STDMA screen when the Unit Role is **Hub**.

From a Hub CDM-570/570L, entering **R** at the command prompt displays the **STDMA Remotes Menu**.

```

Telnet - 192.168.0.10
Connect Edit Terminal Help

                          STDMA Remotes Menu
Remote Name              Remote IP              Status
Remote01.....[Remote 1          192.168.1.1          0011 (U B )]..1
Remote02.....[Remote 2          192.168.1.65         0011 (U B )]..2
Remote03.....[Remote 3          192.168.1.129        0011 (U B )]..3
Remote04.....[UNKNOWN].....4
Remote05.....[UNKNOWN].....5
Remote06.....[UNKNOWN].....6
Remote07.....[UNKNOWN].....7
Remote08.....[UNKNOWN].....8
Remote09.....[UNKNOWN].....9
Base.....[1].....B
Remote Count.....[3]
Set Remote Policies.....P
Delete.....D
Enable/Disable.....E
View.....U
Remove Timeout.....[0].....R
Remove Retry Timeout..[0].....T

Save Parameters to permanent storage.....S
Exit.....X
Telnet Logout.....L

```

Figure 3-16 STDMA Remotes Menu screen

The menu shown in figure 3-16 is used to define and make modifications to the Remotes that belong to the STDMA group for the Hub modem, as well as to display each Remote's burstmap status information.

Adding a Remote to the STDMA Group

Entering the item number for the Remote modem/router brings up the dialog shown in figure 3-17. A prompt to enter the **Name** for the Remote unit appears, followed by a prompt to enter the **IP Address**.

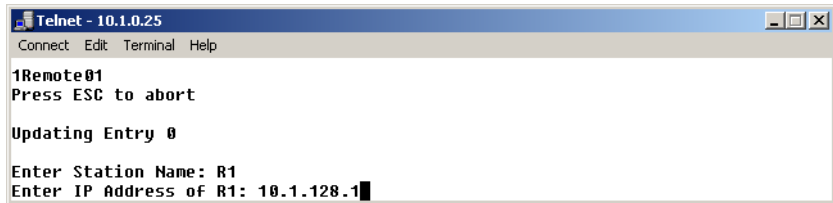

Figure 3-17 Adding a Remote to the STDMA group

Once a Remote has been added to the group, its Status in the group is displayed by the use of the following letters:

- **U = Used** – This Remote is being used in the burstmap
Once a remote has been added to the STDMA group, this status will always be displayed.
- **B = Burstmap** – This Remote is currently in the burstmap
This status will be displayed unless the remote has been removed (R), disabled (D), or switched (S) out of the STDMA burstmap.
- **R = Removed** – This Remote is currently removed from the burstmap.
When displayed, this status indicates that the Hub has removed this remote from the burstmap due to a communications fault.
- **D = Disabled** – This Remote is currently disabled and is not in the burstmap.
This status will be displayed when a remote is manually disabled by the operator or administrator.
- **S = Switched** – This Remote is currently switched into SCPC mode.
When displayed, this status indicates that the VMS has automatically switched the remote out of the burstmap and into SCPC operation.

Base

Entering a **B** at the command prompt in figure 3-16 allows entering the Remote number to start displaying remotes in this menu screen. Entering the number 1, as shown in figure 3-16, displays nine remotes, 1 through 9. If the number 4 had been entered, the display would show the nine remotes starting with remote 4 (i.e., remotes 4 through 12).



Figure 3-18 Modifying Remote Display Base

Remote Count

The **Remote Count** menu item in figure 3-16 is an information only display showing the total number of Remotes that currently belong to the STDMA group for this Hub modem.

Set Remote Policies

This menu item, which appears for *GIR and Entry Channel* Hub types, allows each Remote to be configured for specific data switching conditions. Entering **P** at the **STDMA Remotes Menu** command prompt displays the **Remote Policies** screens shown in either figure 3-19 (GIR Hub) or figure 3-21 (Entry Channel Hub).

```

Telnet - 192.168.0.10
Connect Edit Terminal Help

                          STDMA Remote Policies
Remote Name              GIR  Load Switch
Remote01.....[Remote 1      0    0].....1
Remote02.....[Remote 2      0    0].....2
Remote03.....[Remote 3      0    0].....3
Remote04.....[UNKNOWN].....4
Remote05.....[UNKNOWN].....5
Remote06.....[UNKNOWN].....6
Remote07.....[UNKNOWN].....7
Remote08.....[UNKNOWN].....8
Remote09.....[UNKNOWN].....9
Base.....[1].....B
Remote Count..[3]

Save Parameters to permanent storage.....S
Exit.....X
Telnet Logout.....L
  
```

Figure 3-19 STDMA Remote Policies screen (GIR Hub)

Entering the Remote number at the command prompt in figure 3-19 allows the **Guaranteed Information Rate** and the **Automatic Load Switch Rate** for that Remote to be set, as shown in figure 3-20. Note that the Available Bandwidth is displayed for reference in this screen to assist with entering the appropriate rates. The cycle length for GIR is limited to a maximum of one second.

```

Telnet - 192.168.0.10
Connect Edit Terminal Help

1Remote01
Press ESC to abort

Setting Policies for Remote 1 (1):
Available Bandwidth = 72 Kbps (567 ms)
Enter Guaranteed Information Rate (Kbps) for Remote 1 (0 = none): 56
Enter Automatic Switch Rate (Kbps) for Remote 1 (0 = none):
  
```

Figure 3-20 GIR Remote Policies prompt

The Remote Policies screen for an Entry Channel Hub type allows the SCPC data rates and switch types to be specified for when a Remote will switch and the desired starting point for communications.

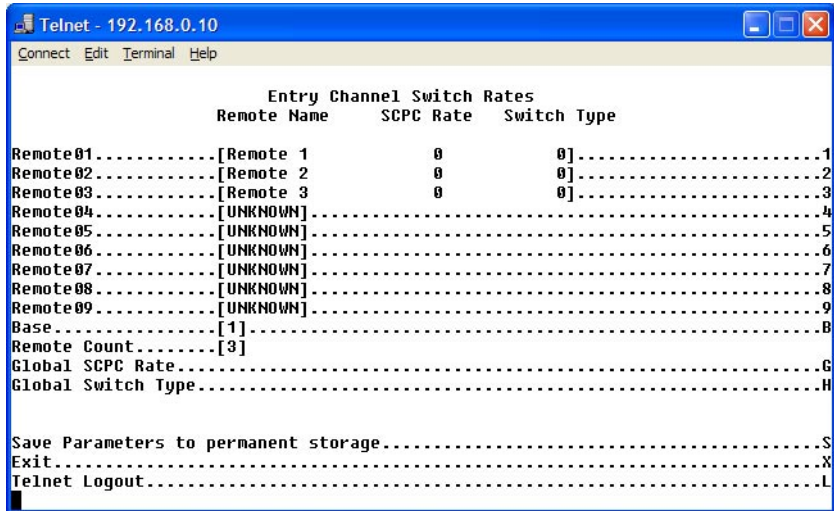

Figure 3-21 Entry Channel Switch Rates screen

Entering the Remote number at the command prompt in figure 3-21 allows the **SCPC Data Rate** and the **Switch Type** for that Remote to be set, as shown in figure 3-22. Switch type **0** corresponds to Load Switching; switch types **64** through **255** are user-defined, and must match VMS policies.

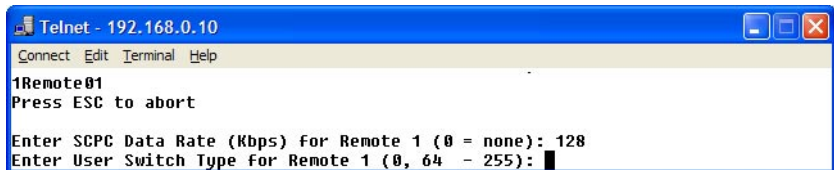

Figure 3-22 Remote SCPC Data Rate and Switch Type prompt

The Global SCPC Rate command can be used to set the data rate for all or a majority of the Remotes. This allows the rate to be entered just once instead of entering the rate for each remote individually. Enter **G** at the command prompt.

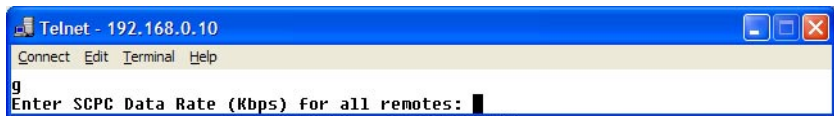

Figure 3-23 Global SCPC Data Rate prompt

Similarly, the Global Switch Type command can be used to set the switch type for all or a majority of the Remotes. Enter **H** at the command prompt.

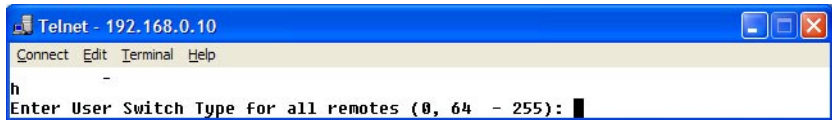

Figure 3-24 Global Switch Type prompt

Delete Remote

Entering **D** at the command prompt shown in figure 3-16 brings up the **Delete Remote** dialog shown in figure 3-25.

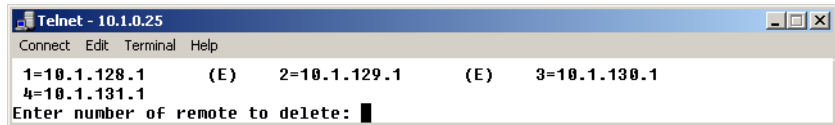

Figure 3-25 Delete Remote prompt

Enter the number of the Remote CDM-570/570L at the command prompt to delete it from the STDMA group for this Hub modem.

Enable/Disable Remote

Enter **E** at the command prompt in figure 3-16 to display the dialog shown in figure 3-26. The Remotes in the STDMA group are displayed, indicating whether each is currently Enabled (E) or Disabled.

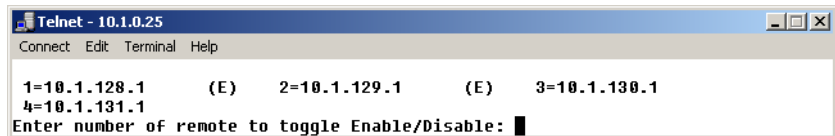

Figure 3-26 Enable/Disable Remote prompt

Enter the number of the Remote at the command prompt to toggle the Remote from its current Enable/Disable configuration.

View Remote(s)

Entering **V** at the command prompt shown in figure 3-16 will display the listing of Remote(s) that belong to the STDMA group for this Hub modem, as shown in figure 3-27.

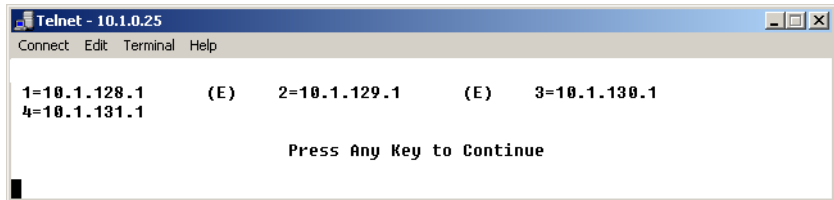

Figure 3-27 View Remote(s) screen

The display is for information only and pressing any key will return you to the menu shown in figure 3-16.

Remove Timeout

Entering **R** at the command prompt shown in figure 3-16 will display the **Remove Timeout** dialog shown in figure 3-28. Note that the menu item shown in figure 3-16 shows the current setting (in seconds) for this parameter.

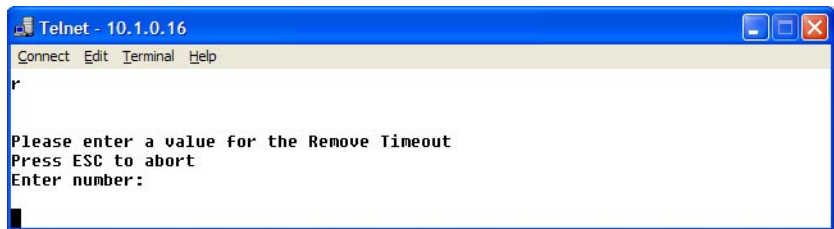

Figure 3-28 Remove Timeout prompt

The value entered at the command prompt in figure 3-28 defines the amount of time (in seconds) with no communication from a Remote to the Hub before that Remote is removed from the Burstmap. This feature is useful, for example, in an SNG application where a mobile remote has finished its assignment and has shut down.

If communications are lost for this period of time, the Remote is removed from the STDMA group, and the bandwidth resources it had been allocated are then made available for use by the other remotes remaining in the group.

Remove Retry Timeout

Entering **T** at the command prompt in figure 3-16 will display the **Remove Retry Timeout** dialog shown in figure 3-29.



Figure 3-29 Remove Retry Timeout prompt

When a Remote is removed from the STDMA group, as described in the section “Remove Timeout” above, entering a value in the Remove Retry Timeout dialog above defines the amount of time (in seconds) that is allowed to pass before a retry attempt is made to return the removed Remote to the group.

This allows, again using a mobile remote as an example, shutting down the remote at one location, moving it to a new location, and then automatically re-establishing a connection to the satellite network.

STDMA Statistics

Entering **V** at the command prompt on the **STDMA** screen displays the **STDMA Statistics** as shown in either figure 3-30 (Hub) or figure 3-31 (Remote). These screens provide information for the number of Bursts (Remote only), number of Burst Maps, and the current STDMA Cycle Length.

Because the Remote modem bursts back to the Hub once every cycle, the number of Bursts displayed should be a multiple of the number of Burst Maps displayed, with this multiple determined by the number of cycles per burst map (1, 2, or more) that has been defined at the Hub. For the example shown in figure 3-31 (Dynamic Cycle), the number of cycles per burst map is one, and therefore the number of Bursts equals the number of Burst Maps.

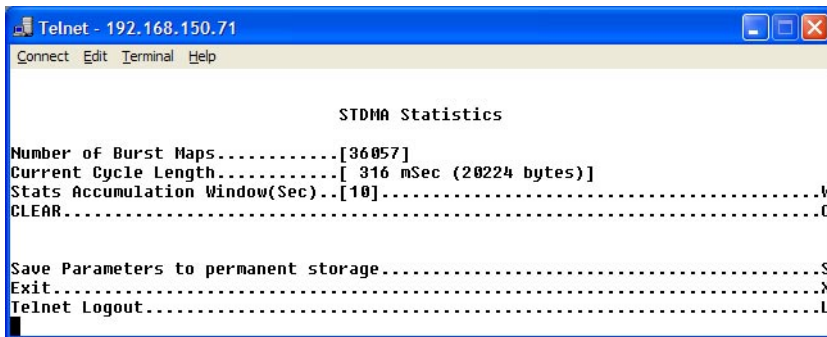

Figure 3-30 STDMA Statistics screen (Hub)

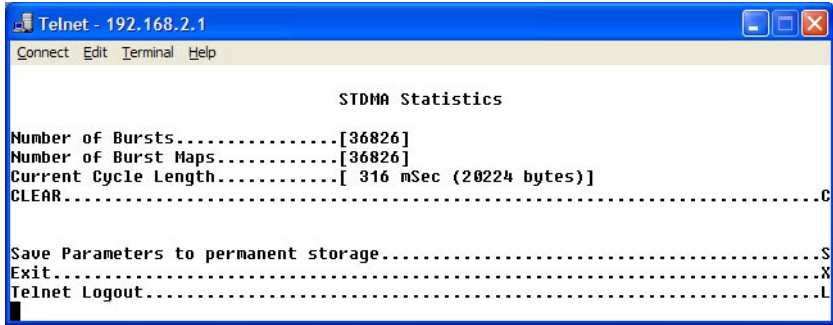

Figure 3-31 STDMA Statistics screen (Remote)

The window of time that is used to average the **accumulation of statistics** can be set by entering **W** at the command prompt in the Hub screen, then entering the number of seconds (from 1 to 20).

To **clear** (reset to 0) these statistics, enter **C** at the command prompt.

Show Hub Statistics

Entering a **W** at the command prompt in the **STDMA** screen (figure 3-6) displays the current statistics for the target CDM-570/570L Hub, as shown in figure 3-32.

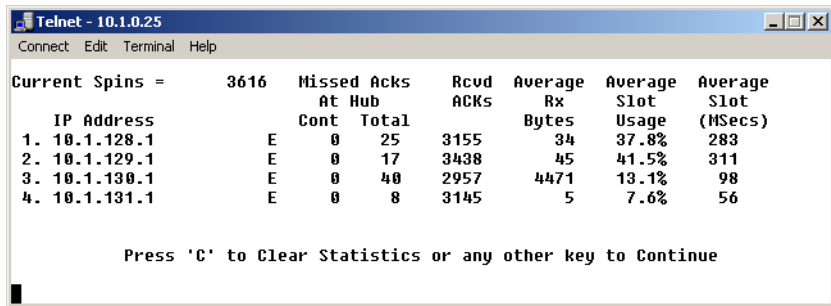

Figure 3-32 Hub Statistics screen

The Burst Controller monitors statistics in the received ACK from each Remote. The statistics report the fill status of the STDMA buffers. The Burst Controller builds a table of the group and calculates the relative buffer fill for each Remote. It then calculates the length of the Data Slot for each Remote based on the Minimum Slot Size plus a percentage of the Available Bandwidth. Idle remotes would receive a Data Slot equal to the Minimum Slot Size.

In the figure 3-32, Remote 1 with IP address 10.1.128.1 had activity during the averaging period. It captured 37.8% of the total slot time and had an average slot length of 283 ms. Remotes 2, 3, and 4 had 41.5%, 18.1%, and 7.6% respectively. The dynamic range of STDMA is a function of the difference between

the Nominal Data Slot Size and the Minimum Data Slot Size parameters. These parameters are operator selectable. The speed with which STDMA reacts to changes in dynamic load is a function of the Statistics Accumulation Window parameter and the Cycles per Burst Map parameter, both of which are also operator selectable.

STDMA/SCPC Automatic Switching

One of the most powerful features of the Vipersat CDM-570/570L is the capability to perform automatic switching between STDMA mode and SCPC mode based on bandwidth demand. The configuration options that are available to meet customer-specific requirements are extensive, and include switching based on Load, Application (Voice and Video RTP), ToS, and QoS.



Note: Care must be taken when configuring the Auto Switching features of the Vipersat system to ensure that there is no duplication or overlap of switching functions between Application, ToS, and QoS for a particular traffic flow. Only one of these switching methods should be utilized for any one flow requirement.

The functions available for configuring the switching operations depend on whether the target CDM-570/570L is a Hub unit or if it is a Remote unit.

In order for the target CDM-570/570L to be automatically switched between STDMA and SCPC modes, the **Auto Switching** feature must be enabled as described in the section “Feature Configuration” on page 3-4.

Selecting **Automatic Switching** from the **Vipersat Configuration** screen shown in figure 3-5 will display the **STDMA/SCPC Auto Switching** screen shown in either figure 3-33 (Hub modem) or figure 3-34 (Remote modem).

```

Telnet - 192.168.150.71
Connect Edit Terminal Help

                          STDMA/SCPC Auto Switching

Auto Switching.....[Enabled]
Current WAN Transmit Mode.....[Continuous]
Load Switching.....[Enabled].....B
STDMA Slot Capacity.....[95%].....U
STDMA Switch Delay.....[10 seconds].....W
Percent Allocation.....[10%].....E
Time for Carrier Inhibit (0 to disable)..[0].....C

Save Parameters to permanent storage.....S
Exit.....X
Telnet Logout.....L

```

Figure 3-33 STDMA/SCPC Auto Switching screen (Hub)

```

Telnet - 192.168.2.1
Connect Edit Terminal Help

                          STDMA/SCPC Auto Switching
Auto Switching.....[Enabled]
Current WAN Transmit Mode.....[STDMA(Burst)]
Voice Switch Detection.....[Enabled].....0
Video Switch Detection.....[Enabled].....I
TOS Switch Detection.....[Enabled].....T
QOS Switch Detection.....[Disabled].....Q
Load Switching.....[Disabled].....B
SCPC Step Up Threshold.....[75%].....U
SCPC Step Down Threshold.....[65%].....D
SCPC Step Delay.....[10 seconds].....W
SCPC Stepup Excess.....[10%].....E
Time for Carrier Inhibit (0 to disable).....[0].....C
TOS Switching Parameters.....P

Save Parameters to permanent storage.....S
Exit.....X
Telnet Logout.....L

```

Figure 3-34 STDMA/SCPC Auto Switching screen (Remote)

Auto Switching

The **Auto Switching** item is for information only and shows the current configuration of the target CDM-570/570L. This feature is Enabled and Disabled as described in section “Feature Configuration” on page 3-4. Auto Switching must be Enabled in order to utilize any of the related features/commands in this menu.

Current WAN Transmit Mode

The **Current WAN Transmit Mode** item is for information only and reflects the current status of the CDM-570/570L. If the CDM-570/570L is functioning as a Hub in the network, this item will always read **Continuous** as shown in figure 3-33. If the CDM-570/570L is functioning as a Remote in the network and STDMA is enabled on the target CDM-570/570L, this item will show **STDMA (Burst)** as shown in figure 3-34.



Tip: This menu item is useful for determining whether a Remote modem is currently operating in STDMA or SCPC mode.

Voice & Video Application Switching

One of the four automatic switching functions that the Vipersat CDM-570/570L is able to perform is **Application Switching**. The Vipersat CDM-570/570L provides application switching for non-encrypted SIP and/or H.323 traffic that is detected on the satellite network. When encryption prevents the detection of this type of traffic, an alternate means of SCPC switching can be configured using the ToS auto switching feature.

Detection of the voice and video traffic occurs in the Remote modem classifier, which looks at traffic that is passed in both directions (Hub-to-Remote and Remote-to-Hub). Once the Voice and Video Switch Detection features are enabled, the Remote modem will send an Automatic Switch Request (ASR) to the VMS when an SIP and/or H.323 call is detected. The ASR contains the destination IP address of the RTP packets. If available hardware and bandwidth exist, the VMS will establish the SCPC carrier automatically.



Note: Application switching (voice and video) must be enabled for each CDM-570/570L in a network that is going to perform application switching in order for the VMS to dynamically optimize network circuit parameters to accommodate these applications.

Load switching by the VMS is not affected by this setting.

Voice Switch Detection

This menu item appears for Remote modems only.

Voice Switch Detection is one of the Application switching commands that provides for a dedicated SCPC connection when an SIP and/or H.323 voice call is made over the satellite network.

Entering **O** at the command prompt toggles the **Voice Switch Detection** command for the CDM-570/570L between **Enabled** and **Disabled**. When enabled, a voice data-stream will be detected, causing the CDM-570/570L to send a switch request to the VMS to switch from STDMA to SCPC mode.

Video Switch Detection

This menu item appears for Remote modems only.

Video Switch Detection is one of the Application switching commands that provides for a dedicated SCPC connection when an H.323 video call is made over the satellite network.

Entering **I** at the command prompt toggles the **Video Switch Detection** command for the CDM-570/570L between **Enabled** and **Disabled**. When enabled, a video data-stream will be detected, causing the CDM-570/570L to send a switch request to the VMS to switch from STDMA to SCPC mode.

ToS Switch Detection

This menu item appears for Remote modems only.

One of the four automatic switching functions that the Vipersat CDM-570/570L is able to perform is **ToS (Type of Service) Switching**. ToS is defined by an eight bit field within an IP packet header that is used to set up per-hop-based QoS rules for prioritizing packets. Because the ToS field remains untouched by

most encryption methods, ToS switching provides an alternative means of SCPC switching when encryption prevents the detection of SIP and H.323 protocols.

ToS detection occurs in the Remote modem classifier which only looks at traffic that is passed in the LAN-to-SAT (Remote to Hub) direction. Once the ToS Switch Detection feature is enabled, the Remote modem will send an ASR to the VMS when a packet stamped with the ToS is detected. The ASR contains the destination IP address of the ToS stamped packet, the desired SCPC rate, and the VMS Switch Type (policy #). If available hardware and bandwidth exist, the VMS will establish the SCPC carrier automatically.

Entering **T** at the command prompt in figure 3-34 toggles the **TOS Switch Detection** command for the CDM-570/570L between **Enabled** and **Disabled**. When enabling ToS switching, the ToS switching control parameters must be defined as described in the section “ToS Switching Parameters” on page 3-32.

Applying a ToS value to an application (VoIP, IPVC, or priority data) through either preservation or classification packet stamping allows the Vipersat switching system to function in an encrypted network. Normally in a non-encrypted Vipersat network, packets are classified by the Remote CDM-570/570L using protocol classification detection and the results are forwarded to VMS via VESP (Vipersat External Switching Protocol) or, in legacy VMS systems, via an ASR (Automatic Switch Request) message. The VMS switch detector service then applies the required or requested bandwidth using policies which have been pre-configured in the VMS. Refer to the *VMS User's Guide* for details.

For example, if in a non-encrypted network a voice application service connection is started, the CDM-570/570L's classifier analyzes signaling and data protocols (H.323, SIP, & Data RTP) being routed through the CDM-570/570L. After connection detection, the process waits for data (RTP). Data is normally sent after the receiving party answers, which then triggers the system to process an ASR. Using the ToS classification, the detection function allows application-based switching in encrypted networks where the signaling protocols are encrypted or effectively hidden.



Note: Load switching by the VMS is not affected by enabling ToS detection.

QoS Switch Detection

This menu item appears for Remote modems only.

One of the four automatic switching functions that the Vipersat CDM-570/570L is able to perform is **QoS (Quality of Service) Switching**. With this feature, an STDMA to SCPC switch can be initiated based upon any type of IP traffic flow that matches a defined QoS queue. QoS detection occurs in the Remote modem

classifier, which looks at traffic that is passed in both directions (Hub-to-Remote and Remote-to-Hub). When an IP packet matches a defined QoS rule, the Remote modem sends an ASR to the VMS that contains the destination address of the detected packet, the defined bit rate, and the policy type. If available hardware and bandwidth exist, the VMS will establish the SCPC carrier automatically.

Enable Quality of Service (QoS) Feature

The Remote must have the QoS FAST feature code, and the QoS feature must be enabled in order for the QoS Switch Detection feature to function. The QoS feature is Enabled/Disabled from the **Feature Configuration** screen (see figure 2-3).

Configure QoS Rules

The Vipersat CDM-570/570L is capable of performing automatic switching based on the QoS rules for a Remote modem. QoS rules can be assigned to different flow types that are user-defined by any combination of traffic type protocol (FTP, UDP, RTP, etc.), source/destination IP (specific or range), and/or Layer 3 source/destination port.

The Vipersat QoS Switching feature is designed to manage single, specific sessions or flow types, such as a UDP video stream targeted to a specific port. When defining QoS rules for QoS based switching, it is best to make them as specific as possible so as to avoid unintended or multiple sessions/flows being generated with that rule. A QoS rule that creates multiple flows will result in poor switching performance. With voice traffic, for example, prioritize by using the VOICE protocol rather than prioritizing with RTP or UDP.

From the **Main Menu** for the Remote modem, enter **Q** to access the **QoS Configuration** screen, as shown in figure 3-35.

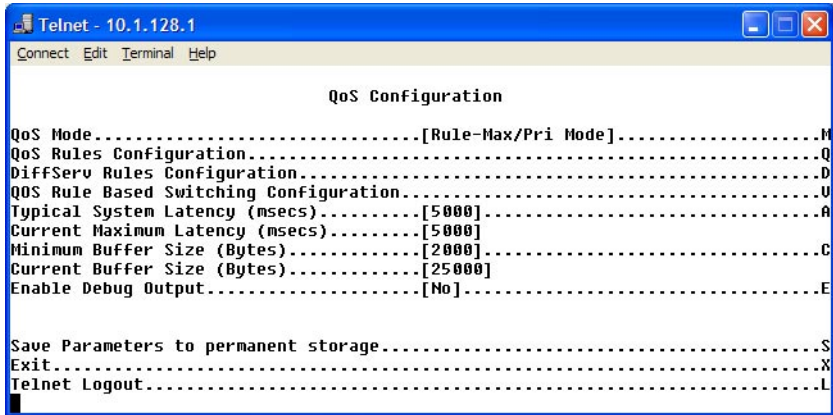

Figure 3-35 QoS Configuration screen

Enter **Q** at the command prompt in figure 3-35 to access the **QoS Rules Configuration** screen, as shown in figure 3-36.

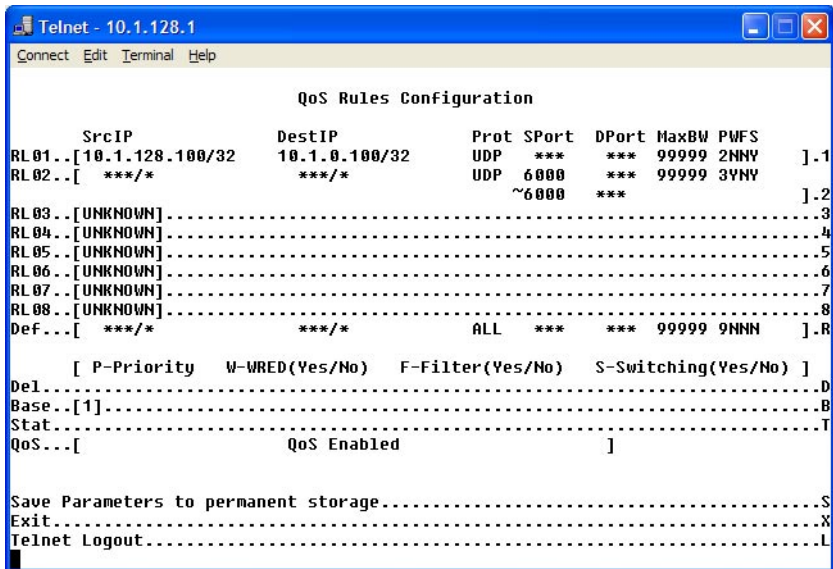

Figure 3-36 QoS Rules Configuration screen

Configure the desired number of rules that are necessary for the applications to be used for this network. Refer to the *CDM-570/570L Installation and Operation Manual* for details on configuring QoS Rules for the CDM-570/570L.

Configure QoS Rules Based Switching

Enter **V** at the command prompt in figure 3-35 to access the **QoS Rules Based Switching** screen for the Remote modem, as shown in figure 3-37

```

Telnet - 10.1.128.1
Connect Edit Terminal Help

                QoS Rules Based Switching

   PROT      DestIP      Dest  Dest  VMS  Switch  Timeout
   RL01..[ UDP      10.1.0.100  ****  ****  254  3000   5].....1
   RL02..[ UDP              ****  ****  67   128   5].....2
   RL03..[ UNKNOWN].....3
   RL04..[ UNKNOWN].....4
   RL05..[ UNKNOWN].....5
   RL06..[ UNKNOWN].....6
   RL07..[ UNKNOWN].....7
   RL08..[ UNKNOWN].....8
   Base..[1].....B

Save Parameters to permanent storage.....S
Exit.....X
Telnet Logout.....L

```

Figure 3-37 QoS Rules Based Switching screen

Determine which QoS rules will be used as a basis for performing SCPC switching, then configure the VMS policy type, the SCPC switch rate, and the timeout value to be associated with each rule. Assigning a **0** (zero) value means that no SCPC switch will occur for that rule.

Enable QoS Switch Detection Feature

Once QoS has been enabled and configured as described above, the last step in implementing QoS switching is to **Enable** the **QoS Switch Detection** feature. Entering **Q** at the command prompt in figure 3-34 toggles the QoS Switch Detection feature between Enabled and Disabled.

Load Switching

One of the four automatic switching functions that the Vipersat CDM-570/570L is able to perform is **Load Switching**. The system will detect variations in data rate and can be configured to switch from STDMA to SCPC based on bandwidth requirements.

The initial switch for a Remote CDM-570/570L from STDMA mode to SCPC mode is determined by the Hub Burst Controller. Once the Remote is switched into SCPC, any requests to meet additional switching requirements within SCPC (Step Up or Step Down) are made by the Remote modem.

The **Load Switching** command on the **Auto Switching** menu is a toggle that **Enables** and **Disables** Load Switching on the target CDM-570/570L. Entering **L** at the command prompt will toggle between these two states. Refer to *Appendix B, Automatic Switching*, in this document for additional information on Load Switching.



Note: Load Switching must be enabled for each CDM-570/570L in a network that is going to perform Load Switching in order for the VMS to dynamically optimize network performance as load conditions change on these circuits.

Application switching by the VMS, such as for Voice and/or Video, is not affected by this setting. However, using Load Switching for real-time applications is not recommended.

STDMA Slot Capacity

This menu item appears for Hub modems only.

The **STDMA Slot Capacity** command allows setting the threshold or level of slot capacity at which the Burst Controller sends a switch request to the VMS to switch the Remote from STDMA mode to SCPC mode.

Typically the default settings will be optimum, but there may be unique network configurations that require modifying the STDMA slot capacity value. To change this setting, enter **U** at the command prompt in figure 3-33 to display the screen shown in figure 3-38.

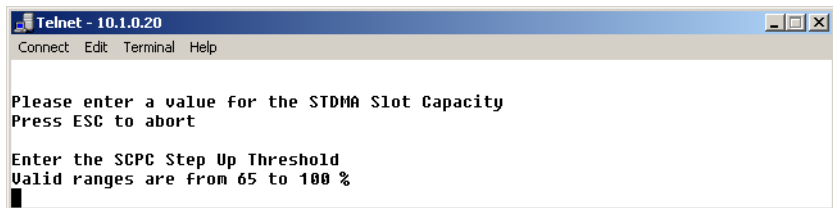

Figure 3-38 STDMA Slot Capacity prompt

STDMA Switch Delay

This menu item appears for Hub modems only.

In order to minimize unnecessary switching from STDMA to SCPC due to transient conditions, such as a temporary spike in network traffic for example, a switch delay parameter is provided.

Typically the default values will be optimum, but this value can be changed to accommodate a unique network configuration or application. To change this setting, enter **W** at the command prompt in figure 3-33 to display the screen shown in figure 3-39.

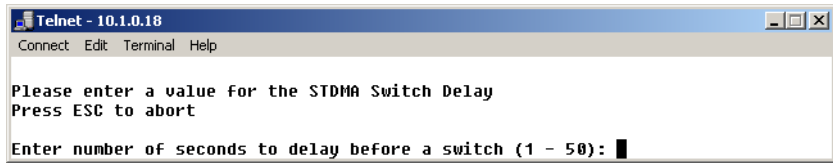

Figure 3-39 STDMA Switch Delay prompt

Percent Allocation

The **Percent Allocation** menu item allows adding a fixed percentage to the channel bandwidth request to accommodate additional bandwidth requirements which may occur after the switch is made from STDMA to SCPC mode.

Typically the default value will be optimum, but if there may be a larger bandwidth requirement after the switch, the percent allocation value can be increased. In choosing a value for this allocation, future bandwidth requirements for the channel must be balanced against efficient bandwidth utilization.

To change this setting, enter **E** at the command prompt in figure 3-33 to display the screen shown in figure 3-40.

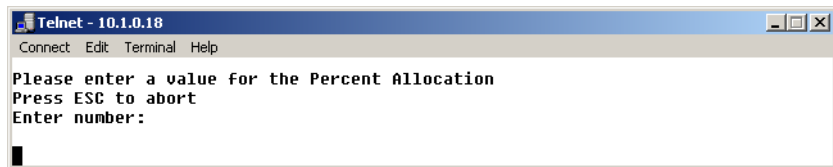

Figure 3-40 Percent Allocation prompt

SCPC Step Up Threshold

This menu item appears for the Remote modem only.

The **SCPC Step Up Threshold** establishes the percentage of bandwidth use that will trigger a switch up from the present SCPC rate to a higher rate to ensure that there is sufficient bandwidth available for current conditions.

Typically the default value will be optimum, but if a different threshold is desired, an alternate value can be specified by entering **U** at the command prompt in figure 3-34. Note that this value must be greater than the value specified for the SCPC Step Down Threshold.

SCPC Step Down Threshold

This menu item appears for the Remote modem only.

The **SCPC Step Down Threshold** establishes the percentage of bandwidth use that will trigger a switch down from the present SCPC rate to a lower rate to ensure efficient bandwidth usage.

Typically the default value will be optimum, but if a different threshold is desired, an alternate value can be specified by entering **D** at the command prompt in figure 3-34. Note that this value must be less than the value specified for the SCPC Step Up Threshold.

SCPC Step Delay

This menu item appears for the Remote modem only.

The **SCPC Step Delay** feature provides a switching delay period to ensure that a premature switch up or down in the SCPC rate does not occur due to a temporary rise or fall in traffic.

A default value (in seconds) is provided, but this parameter can be modified by entering **W** at the command prompt in figure 3-34.

SCPC Step Up Excess

This menu item appears for the Remote modem only.

During each SCPC Step Up switch, the excess capacity data rate value entered by this command is added to the new SCPC data rate. This excess is added each time an SCPC Step Up switch occurs. This setting makes additional bandwidth available for when the demand arises while minimizing step up switching events.

A default percentage value is provided, but this parameter can be modified by entering **E** at the command prompt in figure 3-34.

ToS Switching Parameters

This menu item appears for the Remote modem only.

When ToS switching is enabled on a CDM-570/570L, the parameters for ToS switching must be defined by entering **P** from the STDMA/SCPC Auto Switching screen (see figure 3-34). The **TOS Switching Control** menu shown in figure 3-41 is displayed, allowing parameter entry for the desired ToS service to be applied.

```

Telnet - 10.1.132.1
Connect Edit Terminal Help

          Service      TOS Switching Control
          Name         Value   Type     Switch   Timeout
TOS01.....[Voice 1      1      64      32      5].....1
TOS02.....[Video 1     5      65      450     7].....2
TOS03.....[UFS 1       10     70     1000    10].....3
TOS04.....[UNKNOWN].....4
TOS05.....[UNKNOWN].....5
TOS06.....[UNKNOWN].....6
TOS07.....[UNKNOWN].....7
TOS08.....[UNKNOWN].....8
TOS09.....[UNKNOWN].....9
Base.....[1].....B
TOS ID Count..[3]
Delete.....D
View.....U

Save Parameters to permanent storage.....S
Exit.....X
Telnet Logout.....L

```

Figure 3-41 ToS Switching Control screen

ToS Switching Entry

After determining what ToS value to use, either application or router classifier, select a ToS entry from the list for configuration or edit. The screen will prompt for inputs to the list of range-checked values, as shown in the sample dialog in figure 3-42 that displays the entries for TOS 03.

```

Telnet - 10.1.132.1
Connect Edit Terminal Help

3TOS03
Press ESC to abort
Creating new table entry:

Enter Name for TOS ID []: UFS 1
Enter the TOS ID; Valid range is from 1 to 63 [0]: 10
Enter the Switch Type; Valid range is from 64 to 254 [0]: 70
Enter the TOS SCPC Data Rate; Valid range is from 0 to 10000 Kbps [0]: 1000
Enter the TOS SCPC Timeout; Valid range is from 1 to 60 seconds [0]: 10

```

Figure 3-42 ToS Switching Entry dialog

- **Enter Name for TOS ID []** - At the prompt, enter a user-defined text label for circuit identification.
- **Enter the TOS ID** - Enter an integer value in the range of 1 to 63. Entering a value of **0** will result in no switch.
- **Enter the Switch Type** - Enter an integer value in the range of 64 to 254 at the prompt to inform the VMS what switching policy to use. Entering a value of **0** will result in no switch.

- **Enter the TOS SCPC Switch Data Rate** - Enter the desired data rate for this service type. Valid entries are from 0 to 10,000 Kbps. This setting will override the VMS set policy value.
- **Enter the TOS SCPC Timeout** - This timer monitors the defined packet flow. Once data stops for the duration of the timer setting, the link state will be restored to the home state condition. Valid entries are from 1 to 60 seconds.

After entering the timeout value, pressing the Enter key will update the **TOS Switching Control** menu with the changes.

Delete

Enter **D** at the command prompt in figure 3-41 to **Delete** a ToS entry, as shown in figure 3-43.

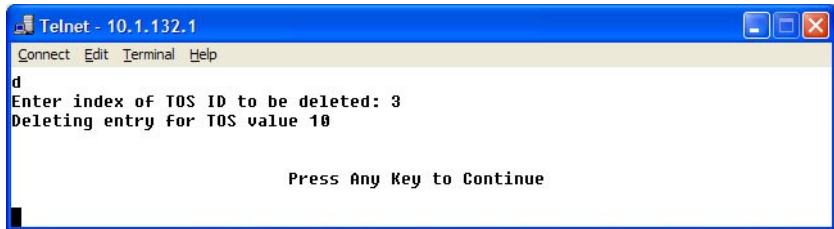

Figure 3-43 ToS Delete prompt



Note: The value shown in the **TOS Value** column is the **TOS ID** associated with the ToS entry to be deleted.

View

Entering a **V** at the command prompt will display the **Internal TOS Table** for active entries as shown in figure 3-44.

Note that, due to binary conversion, the **ID** value is a multiple of 4 and the **Timeout** value is a multiple of 2.

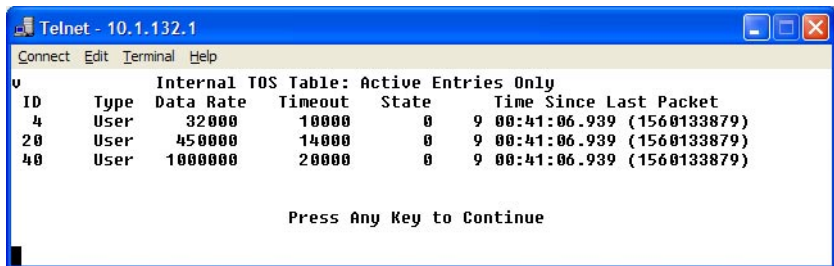

Figure 3-44 ToS View screen

Unit Role

The **Unit Role** configuration determines whether the target CDM-570/570L is to function as a **Remote** or as a **Hub** in the Vipersat satellite network. From the **Vipersat Configuration** screen (figure 3-5), enter **R** to display the dialog shown in figure 3-45.

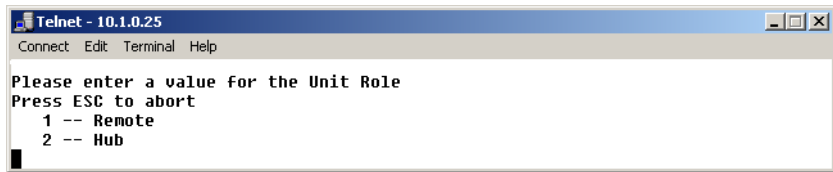

Figure 3-45 Unit Role prompt

The choice made in this command will determine the role the target CDM-570/570L will perform in the network and what type of commands and functions it will receive from the VMS.

Expansion Unit

The **Expansion Unit** menu item in the **Vipersat Configuration** screen (figure 3-5) defines whether the target CDM-570/570L is to function as an Expansion Unit (the demod configured to operate in SCPC mode) or not. Entering **E** at the command prompt will display the dialog shown in figure 3-46.

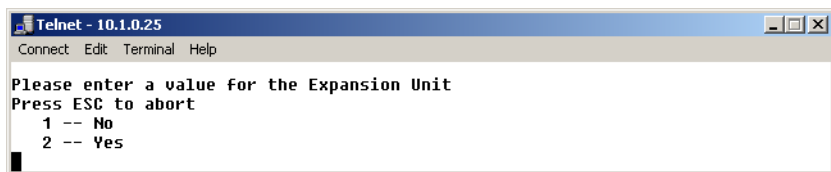

Figure 3-46 Expansion Unit prompt

The VMS uses this data when monitoring and controlling the network to determine the target CDM-570/570L's function. When configured as an expansion unit, either as a Hub (switched) or as a Remote (mesh), the CDM-570/570L is set up so that the demod is in SCPC mode and available as a resource for dedicated communications with the other end of the satellite link.

Network ID

The **Network ID** that is assigned to the unit defines to what network the target CDM-570/570L will belong. All units used in a network will have the same Network ID. Enter **B** at the command prompt in the **Vipersat Configuration** screen (figure 3-5) to display the dialog shown in figure 3-47.

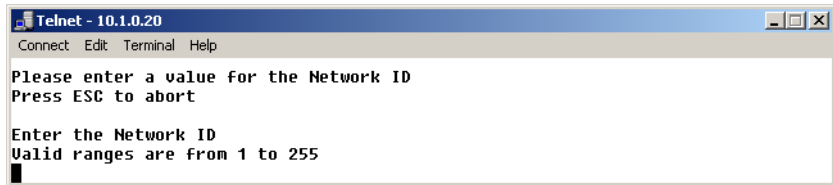

Figure 3-47 Network ID prompt

The Network ID is used by the VMS to identify units that are common to a network and allows the VMS to manage multiple networks, each with its own unique Network ID number.

Unit Name

The **Unit Name** command in the **Vipersat Configuration** screen (figure 3-5) is used to assign a name to the target CDM-570/570L. Enter **N** at the command prompt to display the dialog shown in figure 3-48. Any name, up to 16 characters, can be entered for the unit.

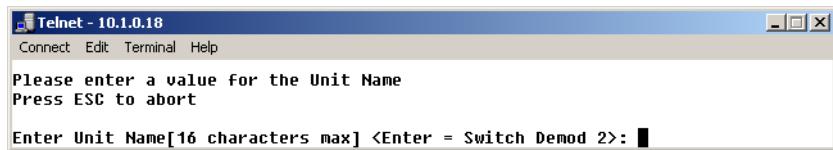

Figure 3-48 Unit Name prompt

This name is displayed by the VMS and identifies the unit in the graphical network display.

Receive Multicast Address

The **Receive Multicast Address** is the multicast IP address assigned to the VMS and all CDM-570/570L units in the network. When the CDM-570/570L receives a multicast from the VMS server, it receives the server's IP address and responds to the VMS server with a unicast containing its current

configuration data, including the CDM-570/570L's IP address. When the VMS receives the unicast response, it registers the CDM-570/570L on the network.

Enter **V** at the command prompt in the **Vipersat Configuration** screen (figure 3-5) to display the dialog shown in figure 3-49.

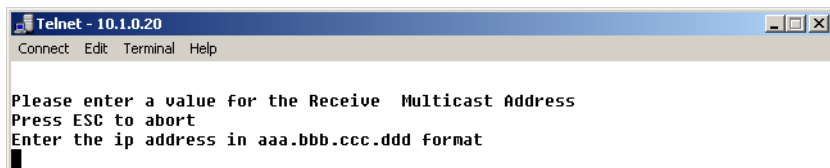

Figure 3-49 Receive Multicast IP Address prompt

Switch requests can be unicast to the VMS server and unicast switch commands received from the VMS by the CDM-570/570L. For more information on this process, refer to the *VMS User Guide*.

Managing IP Address

The **Managing IP Address** command in the **Vipersat Configuration** screen (figure 3-5) allows the IP address for the server running VMS to be entered. Enter **I** at the command prompt to display the dialog shown in figure 3-50.



Figure 3-50 Managing IP address menu

If available, this is the IP address to which the CDM-570/570L sends a unicast registration request every 60 seconds when requesting initial registration on the VMS network. Later the CDM-570/570L uses this address to send switch requests, network health messages, etc. to the managing VMS server.

Primary Heart Beat

This menu item appears for the Hub modem only.

The Primary Heart Beat feature is a redundancy heart beat message for primary Hub units that provides the option for a periodic communications check message to be sent from the Hub modem to the VMS for backup recovery in

N:M redundancy (protected) configurations. The message interval can be specified by the administrator through the VMS.

Enter **P** at the command prompt in the **Vipersat Configuration** screen (figure 3-5) to toggle this feature between **Enabled** and **Disabled**.

Home State Revert

This menu item appears for the Remote modem only.

The **Home State Revert** feature allows automatic resource recovery to be performed on SCPC connections when a communications failure occurs between the VMS and a Remote, such as a rain fade condition, a Remote unit power down, or a hardware failure. The period of time (in minutes) for a failure is configured in the VMS for each Remote in the network. Should communications be lost for more than the specified time period, the Remote will automatically revert to its Home State settings and the VMS will remove all allocated resources (bandwidth, demod(s)), freeing them for use by any other Remote in the network.

Because this feature is configured in the VMS, the status (Enabled or Disabled) appears as an information-only display in the **Vipersat Configuration** menu (figure 3-5).

Dynamic Power Control Configuration

Dynamic Power Control (DPC) is a Vipersat feature that acts to regulate the transmit power of the Vipersat satellite modem, such that the specified receive signal level (Eb/No) is met for the receiving Vipersat units in the group. DPC is driven by the receiver demod, which notifies the transmitting modem of the current Eb/No value.

Refer to *Appendix C, Dynamic Power Control*, in this document for additional information on the DPC feature.

The Dynamic Power Control Configuration screen (enter **C** in the **Vipersat Configuration** menu) allows for setting the parameters for the CDM-570/570L power levels. The information and commands in the menu will vary depending on the function that the target CDM-570/570L performs in the network. The screen shown in figure 3-51 is for a Hub or Remote operating in STDMA mode. For comparison, the DPC Config screen for a unit operating as a Hub or Remote with Expansion (SCPC mode) is shown in figure 3-52. Note that only the applicable settings appear in this screen.

```

Telnet - 192.168.150.71
Connect Edit Terminal Help

                Dynamic Power Control Configuration

DPC Enabled.....[Disabled].....E
Calibrated Data Rate..[3750.000]
Nominal Power Level..[35.0]
Max Power.....[-5.0].....A
Min Power.....[-20.0].....I
Max Step Down Power...[ 3.0].....D
Max Step Up Power....[ 3.0].....U
Target EbNo.....[10.0].....T
Target Range.....[ 0.2].....R
Speed Up EbNo.....[ 5.0].....Q
Target DPC Address...[NOT-DEFINED].....1

Save Parameters to permanent storage.....S
Exit.....X
Telnet Logout.....L

```

Figure 3-51 DPC Configuration screen (STDMA mode)

```

Telnet - 192.168.0.10
Connect Edit Terminal Help

                Dynamic Power Control Configuration

DPC Enabled.....[Enabled].....E
Speed Up EbNo.....[ 5.0].....Q
Target DPC Address...[NOT-DEFINED].....1

Save Parameters to permanent storage.....S
Exit.....X
Telnet Logout.....L

```

Figure 3-52 DPC Configuration screen (SCPC mode)



Note: The following descriptions will refer to the CDM-570/570L as either modulator or demodulator for simplicity and understanding.

Before enabling DPC, the operator should verify that a demodulator at another terminal is receiving from this modulator, and that there is a working communications channel from that receiving station back to the modulator terminal (inband communications). Additionally, since DPC controls potentially the full power range of the modulator's output power, it is recommended that the terminal be commissioned and calibrated before usage.

DPC Enabled

The **DPC Enabled** command (enter **E**) is a toggle that allows the DPC feature to be either Enabled or Disabled. The CDM-570/570L is shipped with the DPC Enabled menu item turned off (Disabled) to allow entrance link levels calibration during terminal setup.

Calibrated Data Rate

This menu item is for information only and displays the **Calibrated Data Rate** in Kbps for the target CDM-570/570L.

There is a proportional relationship between data rate and power level; as the data rate increases, there is a corresponding increase in transmit power level, and vice versa.

Nominal Power Level

This menu item is for information only and displays the **Nominal Power Level** in dB for the modulator. This power level will vary as the data rate varies.

Max Power

The commissioning of a satellite terminal must comply with the calculated link budget that is conducted before terminal installation. Using these calculations, the maximum transmit power level permitted for the modulator(s) based on link/satellite parameters can be configured. This is the value set by the **Max Power** command in the **DPC Configuration** menu. Enter **A** at the command prompt to display the Max Power dialog shown in figure 3-53.



Figure 3-53 Maximum Power Level prompt (CDM-570L)

If more than one modulator is used at this location, that must also be taken into consideration and applied to this value set point. The value entered sets the maximum power level allowed by all SCPC modulators.

Min Power

The **Minimum Power** level setting corresponds to the lowest transmit power level permitted based on link/satellite parameters. Min Power typically can be set to the lowest default value (-25.0 dBm for the CDM-570, -40.0 dBm for the CDM-570L). There is generally no problem in allowing the modulator(s) to reduce power levels when link conditions improve. Enter **I** at the command prompt to display the Min Power dialog shown in figure 3-54.



Figure 3-54 Minimum Power Level prompt (CDM-570L)

The value entered sets the minimum power level allowed by all SCPC modulators.

Max Step Down Power

The **Maximum Step Down Power** value sets the largest step reduction in transmit power permitted when the DPC is adjusting the power downward to achieve the target set point. The default value for this parameter is 3 dB.

Enter **D** at the command prompt to display the Max Step Down Power dialog shown in figure 3-55.



Figure 3-55 Maximum Step Down Power prompt

Max Step Up Power

The **Maximum Step Up Power** value sets the largest step increase in transmit power permitted when the DPC is adjusting the power upward to achieve the target set point. The default value for this parameter is 3 dB.

Enter **U** at the command prompt to display the Max Step Up Power dialog shown in figure 3-56.



Figure 3-56 Maximum Step Up Power prompt

Target EbNo

The **Target EbNo** is the desired operating receive level for closed loop servo control. This is the value used by the receiving CDM-570/570L for comparison with the actual received Eb/No. This information is sent back to the transmitting terminal for output power level adjustment as necessary.

Enter **T** at the command prompt in the **DPC Configuration** screen to display the Target EbNo dialog shown in figure 3-57. The default value for this parameter is 10 dB.

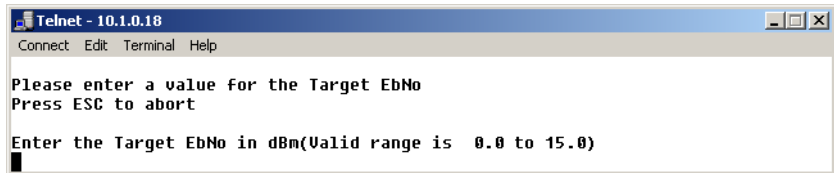

Figure 3-57 Target EbNo prompt

Target Range

The **Target Range** command sets the range on either side of the Target EbNo value, plus or minus, where the received level at the demodulator is acceptable and no adjustment to the output power of the transmitting terminal is necessary.

Enter **R** at the command prompt in the **DPC Configuration** screen to display the Target Range dialog shown in figure 3-58. The default value for this parameter is 0.2 dB.

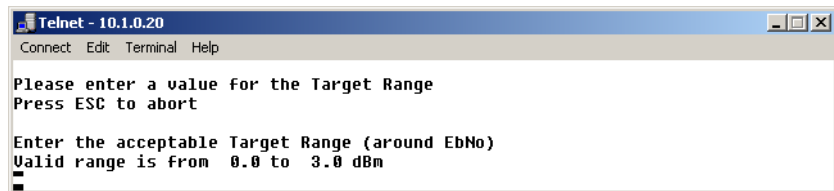

Figure 3-58 Target Range prompt

Speed Up EbNo

Normally, the PLDM (Path Loss Data Multicast) is sent every 60 seconds from each terminal in the network. If the received Eb/No level at the demodulator drops below the **Speed Up EbNo** set value, the corresponding terminal increases its PLDM send rate to every 15 seconds until the receive level is greater than the set value. This provides a loop speed up to rapidly regain link quality.

Enter **Q** at the command prompt in the **DPC Configuration** screen to display the Speed Up EbNo dialog shown in figure 3-59. The default value for this parameter is 5 dB.

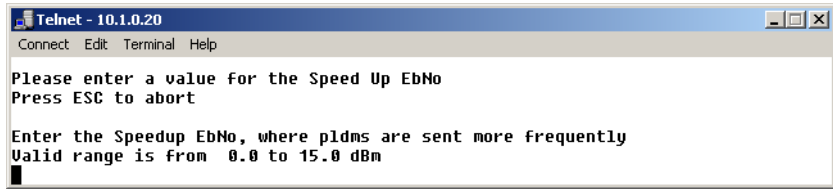

Figure 3-59 Speed Up EbNo prompt

Target DPC Address

The **Target DPC Address** identifies the modem that is transmitting to this CDM-570/570L, and will be receiving the PLDM messages that provide the current Eb/No value for this CDM-570/570L. Typically, all Remotes will specify the Hub modem that is supplying the TDM outbound. The Outbound IP address is sent out to all STDMA Remotes via the Burst Map, and the DPC Target for these Remotes is automatically mapped to that address. When operating in a dedicated SCPC mode, the Remote's Target DPC Address is configured manually with this command.

Enter **1** at the command prompt to display the Target DPC Address dialog shown in figure 3-60.

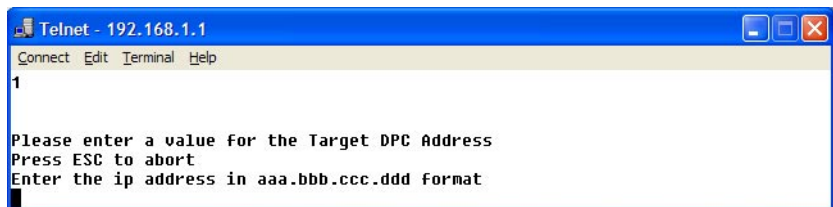

Figure 3-60 Target DPC Address prompt

The STDMA Burst Controller is not permitted to specify a DPC Target because the demodulator is receiving multiple bursts very rapidly from all Remotes in the group and is unable to utilize DPC to control the transmit power of the remote modems.

Set Home State Parameters

A CDM-570/570L's Home State are those parameters which the CDM-570/570L will return to when it is power cycled or reset. Enter **H** at the command

prompt in the **Vipersat Configuration** screen to display the **Home State Configuration** screen shown in figure 3-61.

The parameters entered using this menu define the settings the target CDM-570/570L will go to when it returns to its Home State, either as the result of a command by the VMS, or as it comes back on line from a reset or a power cycle. A CDM-570/570L's Home State settings are typically selected so that it goes to a configuration which is optimum for its function in the network.

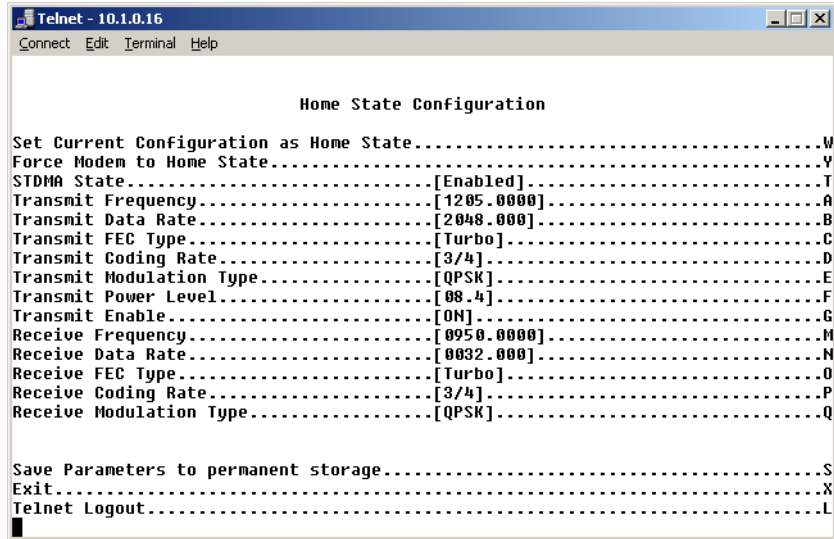

Figure 3-61 Home State Configuration screen

Note that each of these Transmit and Receive parameters are the same as found in the **Tx Configuration** and the **Rx Configuration** screens that are in the **Satellite Modem Configuration** menu.

Set Current Configuration as Home State

This command sets the CDM-570/570L's current configuration as its Home State settings. Assuming the modem has been properly configured using the **Satellite Modem Configuration** menu (Tx and Rx parameters) and the **Feature Configuration** menu (Vipersat STDMA setting), these parameter values will be copied into the Home State configuration. Rather than entering each of these values individually, this command can be used as a shortcut for establishing the Home State settings.

Enter **W** at the command prompt in the **Home State Configuration** screen to execute this command. Once saved, the modem will be configured with the Home State settings at boot time and when manually reset with the **Force Modem to Home State** command.



Tip: This command is useful when a CDM-570/570L's initial set up is completed and the unit is functioning as desired in a network.

Force Modem to Home State

If at any time it is desired to have a CDM-570/570L return to its Home State, this command (enter **Y**) can be executed. The Home State parameter values are “forced” into the Base Modem configuration so that they match. The Base Modem parameters will be updated to reflect any modifications that have been made from this menu.

A warning message is displayed as shown in figure 3-62, requiring the command to be confirmed before it is executed.



Figure 3-62 Force Modem to Home State warning

STDMA State

This command (enter **T**) toggles the setting of STDMA in the target CDM-570/570L's home state between **Enabled** and **Disabled**. This is the same feature that is set from the Feature Configuration menu screen shown in figure 3-3.

Transmit Frequency

Enter **A** at the command prompt to use the dialog shown in figure 3-63 to set the **Transmit Frequency** for the target CDM-570/570L's home state.

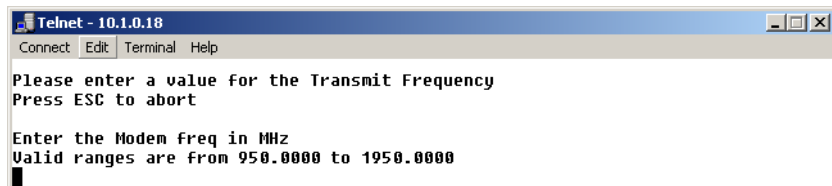

Figure 3-63 Transmit Frequency prompt

Note that this screen dialog example displays the frequency range for the CDM-570L L-Band modem. For the CDM-570, the range displayed will be either 50 to 90 MHz or 100 to 180 MHz.

Transmit Data Rate

Enter **B** at the command prompt to use the dialog shown in figure 3-64 to set the **Transmit Data Rate** for the target CDM-570/570L's home state.

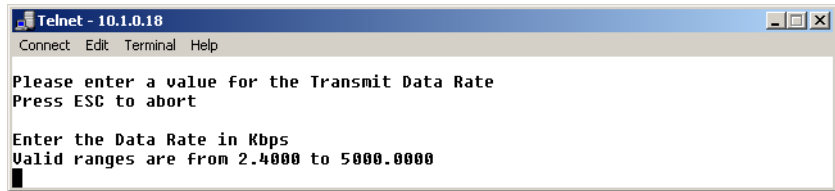

Figure 3-64 Transmit Data Rate prompt

Note that the valid range for this parameter will vary depending on the modulation type, coding rate, and FAST feature data rate.

Transmit FEC Type

Enter **C** at the command prompt to use the dialog shown in Figure 3-65 to enter the **FEC Coding Type** for the CDM-570/570L's home state. **Turbo** must be selected when operating in Vipersat mode.

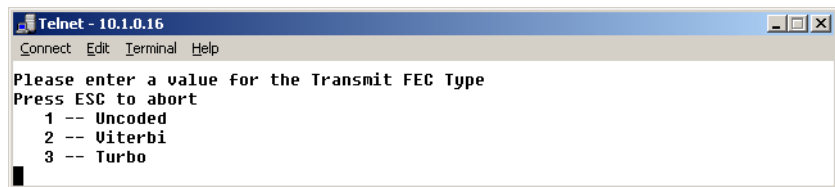

Figure 3-65 Transmit FEC Type prompt

Transmit Coding Rate

Enter **D** at the command prompt to use the dialog shown in figure 3-66 to set the **Transmit Coding Rate** for the target CDM-570/570L's home state.

Note that Coding Rates **3** (1/2), **4** (2/3), and **8** (1/1) are not valid selections when operating in Vipersat mode with Turbo Product Coding.

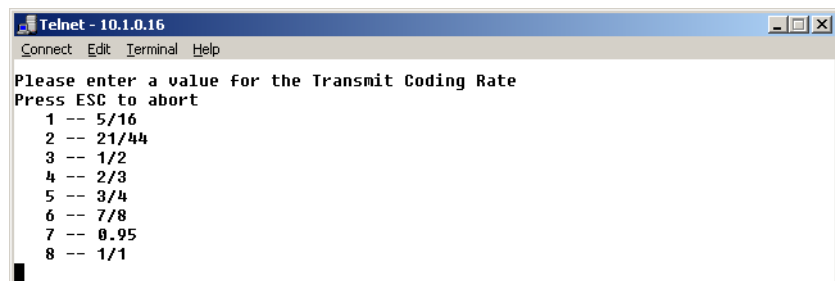

Figure 3-66 Transmit Coding Rate prompt

Transmit Modulation Type

Entering **E** at the command prompt to use the dialog shown in figure 3-67 to set the **Transmit Modulation Type** for the target CDM-570/570L's home state.

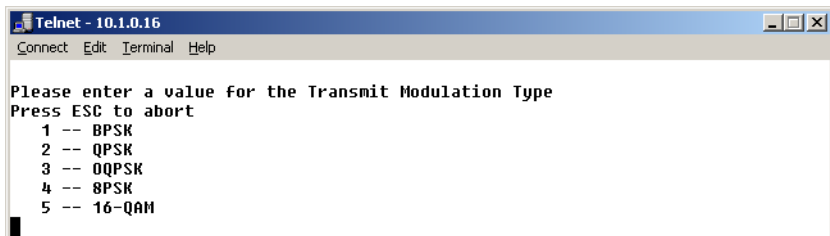

Figure 3-67 Transmit Modulation Type prompt

Transmit Power Level

Enter **F** at the command prompt to use the dialog shown in Figure 3-68 to set the **Transmit Power Level** for the target CDM-570/570L's home state.

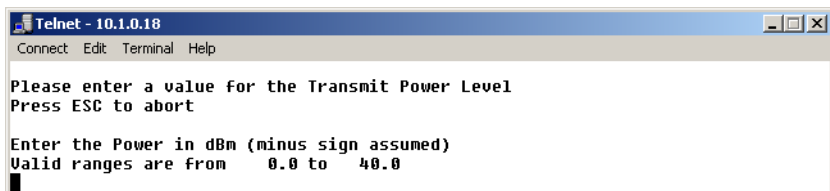

Figure 3-68 Transmit Power Level prompt

Transmit Enable

The modem transmitter can be Enabled or Disabled with this command. Enter **G** at the command prompt to toggle the **Transmit Enable** for the target CDM-570/570L's home state between On and Off.

Receive Frequency

Enter **M** at the command prompt to use the dialog shown in Figure 3-69 to set the **Receive Frequency** for the target CDM-570/570L's home state.

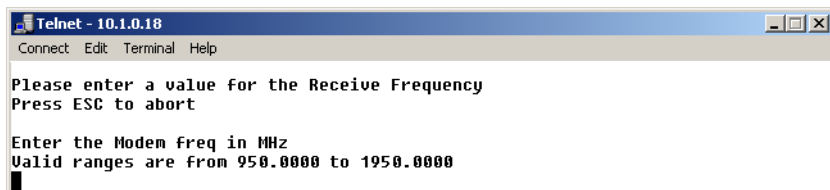

Figure 3-69 Receive Frequency prompt

Note that this screen dialog example displays the frequency range for the CDM-570L L-Band modem. For the CDM-570, the range displayed will be either 50 to 90 MHz or 100 to 180 MHz.

Receive Data Rate

Enter **N** at the command prompt to use the dialog shown in Figure 3-70 to set the **Receive Data Rate** for the target CDM-570/570L's home state.

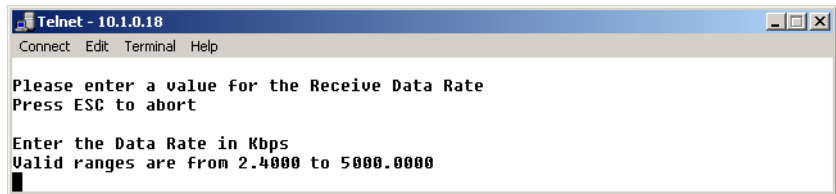

Figure 3-70 Receive Data Rate prompt

Note that the valid range for this parameter will vary depending on the modulation type, coding rate, and FAST feature data rate.

Receive FEC Type

Enter **O** at the command prompt to use the dialog shown in figure 3-71 to set the **Receive FEC Type** for the target CDM-570/570L's home state. **Turbo** must be selected when operating in Vipersat mode.

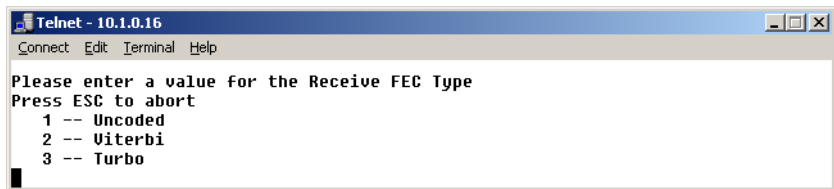

Figure 3-71 Receive FEC Type prompt

Receive Coding Rate

Enter **P** at the command prompt to use the dialog shown in Figure 3-72 to set the **Receive Coding Rate** for the target CDM-570/570L's home state.

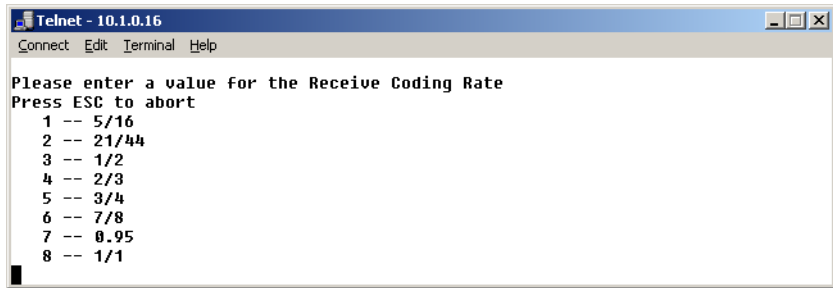

Figure 3-72 Receive Coding Rate prompt

Note that Coding Rates **3** ($1/2$), **4** ($2/3$), and **8** ($1/1$) are not valid selections when operating in Vipersat mode with Turbo Product Coding.

Receive Modulation Type

Enter **Q** at the command prompt to use the dialog shown in Figure 3-73 to set the **Receive Modulation Type** for the target CDM-570/570L's home state.

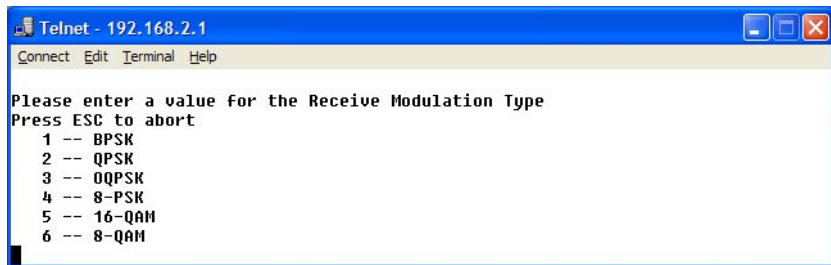
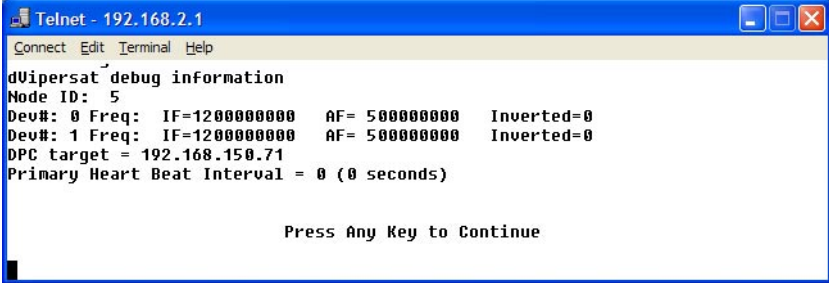

Figure 3-73 Receive Modulation Type prompt

Vipersat Summary

The **Vipersat Summary** screen can be viewed by entering **D** at the command prompt in the **Vipersat Configuration** screen (figure 3-5).



```
Telnet - 192.168.2.1
Connect Edit Terminal Help
dVipersat debug information
Node ID: 5
Dev#: 0 Freq: IF=1200000000 AF= 500000000 Inverted=0
Dev#: 1 Freq: IF=1200000000 AF= 500000000 Inverted=0
DPC target = 192.168.150.71
Primary Heart Beat Interval = 0 (0 seconds)

Press Any Key to Continue
```

Figure 3-74 Vipersat Summary screen

The **Node ID** number that appears in this screen verifies that the unit is registered with the VMS and is active in the network. This number is automatically assigned by the VMS.

The two frequency listings are for the modulator (**0**) and the demodulator (**1**) for the CDM-570/570L. The **IF** values represent the Intermediate Frequency (Hz) that this unit is currently using. The **AF** values represent Adjusted Frequency (Hz), a translation of the IF that is used by the VMS for internal tracking of switching commands.

The **DPC target** entry is the IP address of the modulator that is to receive the DPC messages from this unit.

The **Primary Heart Beat Interval** represents the time period between the communication check message that is sent from the primary Hub modem to the VMS in an N:M redundancy configuration. This interval is specified in the VMS.

Vipersat Migration

The **Vipersat Migration** command is used to set the compatibility mode for the Hub Burst Controller when conducting a firmware upgrade on the associated CDM-570/570L Remotes. Although this command appears in the menu for both the Hub modem and the Remote modem, it only applies to STDMA Controllers and TDM Outbound modems at the Hub.

Enter **M** at the command prompt in the **Vipersat Configuration** screen to display the Vipersat Migration dialog shown in figure 3-75.

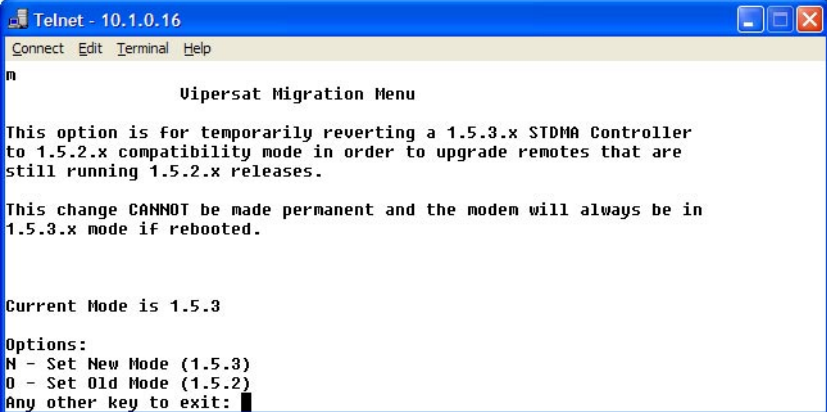
A screenshot of a Telnet terminal window titled "Telnet - 10.1.0.16". The window has a menu bar with "Connect", "Edit", "Terminal", and "Help". The main content area displays the "Vipersat Migration Menu" with the following text:

```
m
                                Vipersat Migration Menu

This option is for temporarily reverting a 1.5.3.x STDMA Controller
to 1.5.2.x compatibility mode in order to upgrade remotes that are
still running 1.5.2.x releases.

This change CANNOT be made permanent and the modem will always be in
1.5.3.x mode if rebooted.

Current Mode is 1.5.3

Options:
N - Set New Mode (1.5.3)
O - Set Old Mode (1.5.2)
Any other key to exit: █
```

Figure 3-75 Vipersat Migration prompt

Refer to *Appendix D, Firmware Installation*, in this document for additional information on the use of this command.

{ This Page is Intentionally Blank }



NETWORK ADDRESSING

This Appendix is an overview of network addressing and how it applies to configuring the CDM-570/570L for use in Vipersat Networks. The subjects covered are:

- OSI Model
- Binary Math
- IP Addressing
- Network Address Translation
- Subnets
- Network Segments
- Default Gateways
- MAC Addresses

The OSI Reference Model

OSI is an acronym for Open Systems Interconnection. This is a network model created by ISO (the International Standardization Organization.) The OSI model is the basic standard which forms the basis for all networking protocols.

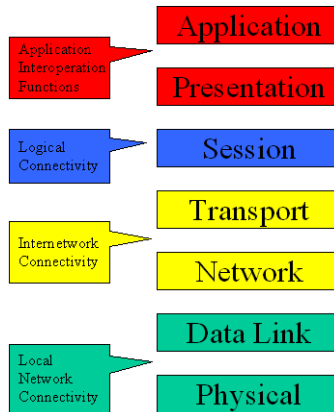

Figure A-1 The Seven OSI Protocol Layers

The OSI model defines the building blocks used to construct a working network protocol as shown in Figure A-1. The blocks on the right show the individual layers which make up the OSI model and the blocks on the left show the layer's functional grouping.

Each layer, as defined by the OSI model, is only aware of the layers directly above and below it.

Layers 1 – 3

Layer 1 / Physical – Layer 1 defines the physical means by which actual bits are sent and received. This layer, for example, is where connectors, cable lengths, and signaling specifications are defined.

Layer 2 / Data Link – Layer 2 consist of two sub-layers:

- Logical Link Control (LLC) – The LLC packages bytes received from the MAC into a format readable by the Network Layer above it.
- Media Access Control (MAC) – The MAC is concerned with obtaining access to the network at an appropriate time; i.e., when no other machines are communicating or when permission has been granted.

Together, these two sub-layer protocols are responsible for moving packets on and off the network.

Layer 3 / Network Layer – Layer 3 is responsible for routing packets through multiple networks. The Layer 3 protocol operates without regard to the underlying protocols in use. For example, routers operate at Layer 3.

Binary Math

Network devices communicate using BITS, where a bit is a single digit represented by a 1 or a 0, or by using BYTES, where a byte is made up of eight bits in any combination of 1's or 0's. A byte is also referred to as an octet.

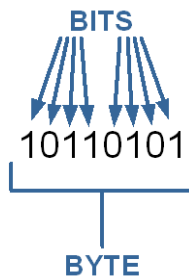

Figure A-2 Bits and Bytes

An octet can be converted to or from binary using the technique shown in the decimal conversion chart in Figure A-3. The conversion chart also shows the decimal equivalent of the binary number.

128	64	32	16	8	4	2	1	
1	0	1	0	0	1	0	1	= 165
1	1	0	0	0	0	1	0	= 194
1	1	1	1	1	1	1	1	= 255

128	
32	
4	
1	
165	

Figure A-3 Binary to Decimal Conversion

Bits containing a **1** in Figure A-3 determine which decimal values should be added. These decimal values, when added together, determine the decimal equivalent for the binary number.

This is an example of changing a number expressed in binary (base 2) to its decimal equivalent (base 10). The numeric value is the same, you have only changed the numbering base (radix.) All digital processes are done in binary.

The conversion to decimal is done whenever binary values need to be read or entered by humans as their decimal equivalents.

IP Addressing

An IP (Internet Protocol) address is a unique set of numbers assigned to a device on a network to uniquely identify that device (by its IP address).

An IP address is a unique number composed of four octets, with each octet separated by a dot. This notation style is called dotted decimal notation.

Each IP address can be broken down into two parts, as shown in the example below:

Example: **128.121.188.201**

The first two octets are the network ID: **128.121**

The second two octets are the host ID: **188.201**

- **Network ID** - In this example, the 128.121 portion of the IP address defines the network that a host belongs to, and is equivalent to a street name in a mailing address.
- **Host ID** - The 188.201 portion of the IP address specifies a unique number assigned to the host on the network, and is equivalent to a house number in a mailing address.

IP Address Classes

IP addresses are assigned to classes according the schedule shown in Figure A-4. IP address classes are assigned as follows:

Class A

- 1.x.x.x to 126.x.x.x (0 and 127 are reserved)
- 126 Class As exist
- Can have 16,777,214 hosts on each Class A
- 8-bit network number
- 24-bit node number

Class B

- 128.0.x.x to 191.254.x.x
- 16,384 Class Bs exist
- Can have 65,354 hosts on each Class B
- 16-bit network number

- 16-bit node number

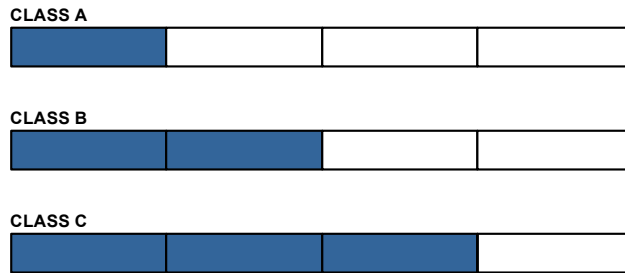

Address Class	High-Order-Bits	1 st Octet Decimal Range	Networks Available	Hosts Available
Class A	0	1-126.x.y.z	126	16,777,214
Class B	10	128-191.x.y.z	16,384	65,534
Class C	110	192-223.x.y.z	2,097,152	254

Figure A-4 IP Address Classes A, B, C

Class C

- 192.0.1.x to 223.255.254.x
- 2,097,152 Class Cs exist
- Can have 254 hosts on each Class C
- 24-bit network number
- 8-bit node number

Class D

- 224.0.0.0 to 239.255.255.255
- Reserved for Multicast (messages sent to many hosts).

Class E

- 240.0.0.0 to 255.255.255.255
- Reserved for experimental use and limited broadcast

Private Network IP Addresses

RFC 1918 defines blocks of addresses for use on private networks:

- 10.0.0.0 – 10.255.255.255
- 172.16.0.0 – 172.31.255.255
- 192.168.0.0 – 192.168.255.255

Network Address Translation (NAT)

Private networks can only connect to the public Internet by using a Network Address Translation (NAT) device (a router, for example) or a proxy server which has been assigned a public IP address. These network devices use a public IP address to request information from the Internet on behalf of the private IP addressed devices on the associated private network.

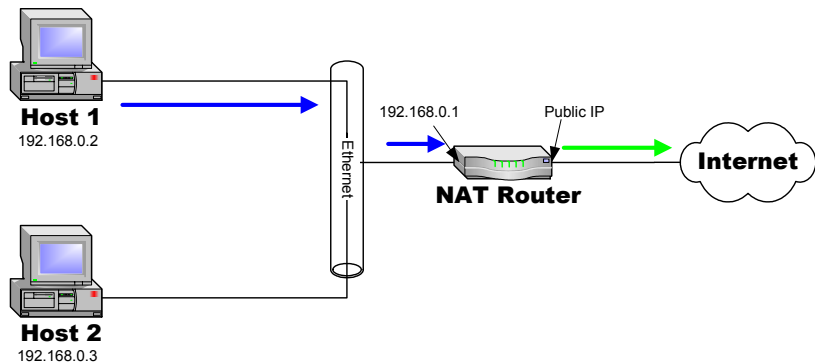

Figure A-5 NAT Router Example

This use of private addresses helps to conserve public IP addresses.

Subnets

Subnets can be defined as the further segmentation of the InterNIC assigned Network ID IP address. The amount and type of subnetting performed by the organization is determined by the network layout.

In the process of subnetting, bits are borrowed from the host ID portion of an IP address and are then given to the network ID. Then a “Subnet Mask” gets assigned to the host along with the IP address.

Subnetting is required if the network is segmented.

Subnet Mask

The Subnet Mask is used by the host to determine if a destination IP address is on the local or on a remote network segment. The table in Figure A-6 shows the default subnet mask used for each class of IP address.

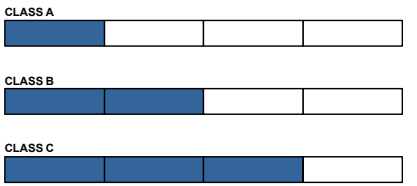

Address Class	Mask Decimal Value	Mask Binary Value
Class A	255.0.0.0	11111111.00000000.00000000.00000000
Class B	255.255.0.0	11111111.11111111.00000000.00000000
Class C	255.255.255.0	11111111.11111111.11111111.00000000

Figure A-6 Default Subnet Masks for IP Classes

The IP address and subnet mask work with each other to identify a network element or device. The subnet mask, like an IP address, contains 4 octets separated by a dot (.) and looks similar to an IP address.

The subnet mask determines what bits in the IP address are being used to determine the network ID by using the Boolean math operator **and** in a process called **anding**. **Anding** compares each bit value in the IP address with the bit value in the subnet mask. The result of the **anding** process determines which subnet the IP address is on. The Boolean **and** operator works as follows:

$$0 \text{ and } 0 = 0$$

$$1 \text{ and } 0 = 0$$

$$1 \text{ and } 1 = 1$$

The table shown in Figure A-7 shows the **anding** of two binary values and the corresponding decimal equivalents for each of the values.

	Dotted Decimal Address	Binary Values
IP Address	192.168.2.66	11000000.10101000.00000010.01000010
Subnet Mask	255.255.255.0	11111111.11111111.11111111.00000000
ANDing Result	192.168.2.0	11000000.10101000.00000010.00000000

Figure A-7 ANDing an IP address and a subnet mask

A calculator, available from SolarWinds, performs these IP and subnet mask calculations and can be found at:

<http://support.solarwinds.net/updates/SelectProgramFree.cfm>

Network Segments

A “Network Segment” is a portion of a network that is bordered by two router interfaces as shown in Figure A-8.

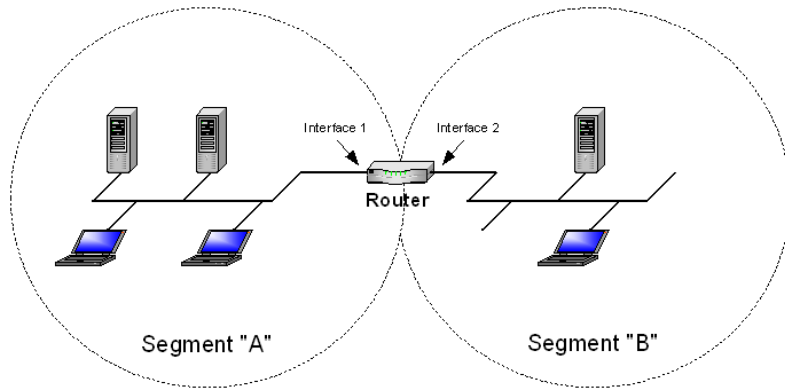

Figure A-8 Network Segments

Each network segment must either be on a different network or a different subnet. For example, if you have a single IP address available, you can change the default mask from 255.255.255.0 to 255.255.255.192. The resulting calculation yields four subnets:

- 192.168.100.0
- 192.168.100.64
- 192.168.100.128
- 192.168.100.192

Each of the four subnets can, in turn, support 64 members.

The example subnet used above yielded 4 subnets, but you can use a different mask to meet the specific requirements of your network.

Default Gateways

A default gateway is a network device, usually a router, that is responsible for routing data packets out of the local network segment.

The address of the gateway is entered into the devices on the local network, providing them with a location to send data that is destined for another segment.

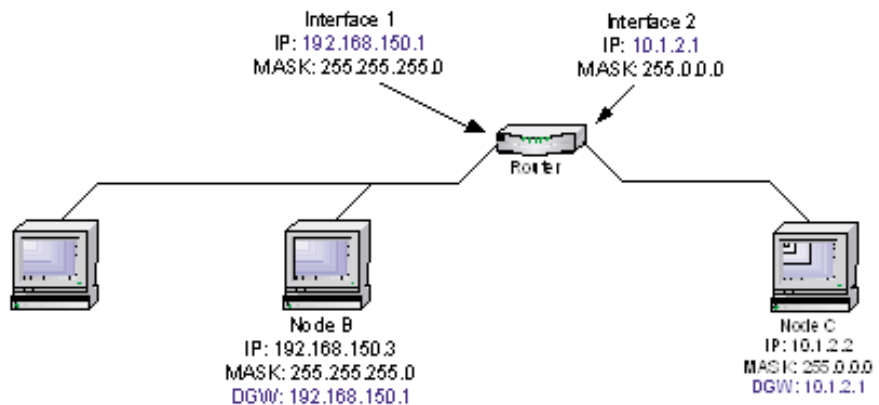

Figure A-9 Router as Default Gateway

MAC Addresses

A MAC address is a physical hardware address that gets assigned to the interface of a networking device. This address is typically created and burned into a device's ROM during the manufacturing process. MAC addresses are unique to the device and are not typically user-assignable.

The MAC address is used for Layer 2 (Data Link) communications between networking devices, and consists of 12 alpha-numeric characters as shown in the example below:

Example: **00-3f-bf-00-01-45**

IP Addressing

- The first six characters are issued to the organization.
- The second six characters are assigned to the hardware interface by manufacturing.

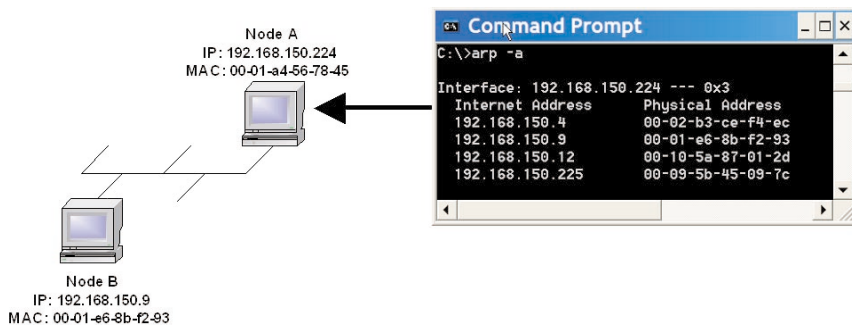

Figure A-10 Network Node MAC Addresses

B

AUTOMATIC SWITCHING

General

Automatic switching is a feature of VMS which allows dynamically changing network configuration in response to changes in either traffic type (application switching) or network traffic loads (load switching.)

The following discussions apply to the Vipersat CDM-570/570L, CDD-564L, and CDM-600. Throughout the following discussion, these units are referred to as modem/routers.

Bandwidth Allocation and Load Switching

Load Switching is the mechanism by which the Vipersat network switches a remote terminal from STDMA to SCPC mode based on traffic levels at the remote. There are two components of load switching in a Vipersat system: VMS (network management) and CDM (Comtech Data Modem). The VMS component receives switch requests from the CDM, and based on policy settings and available resources, either grants or denies the request. Within the CDM component, load switching is managed at either the Hub or the Remote, based on the current mode of operation. When a remote is in STDMA mode, load switching for that remote is managed by the Hub STDMA controller. After a Remote has been switched to SCPC mode it manages its own switching (or Step Up / Step Down) requests.

The basic concept for all load switching is that a running average of current utilization is maintained, and when that utilization exceeds a pre-set threshold, a switch is initiated. The data rate for the switch is computed by determining the current bandwidth requirement of the remote and adding some percentage of

Load Switching

excess margin. The main difference between switching from STDMA to SCPC and adjusting within SCPC is that in STDMA mode, the current available bandwidth is constantly changing while in SCPC mode it is constant between switches. Furthermore, switches from STDMA to SCPC mode are always caused by the traffic level exceeding the switch threshold. Within SCPC mode, switches can be caused by traffic exceeding an upper threshold or dropping below a lower threshold. However, in both cases the new data rate is based on the actual traffic requirements adjusted up by the margin percentage. Also, based on policies set in the VMS, if a remote requests less than some threshold amount of bandwidth, the remote is put back into STDMA mode.



Note: If the Hub STDMA mode is GIR (Guaranteed Information Rate) or Entry Channel, normal load switching is automatically disabled. In GIR mode, the remote is switched to SCPC as soon as the GIR threshold is reached, if there is a switch rate defined. In Entry Channel mode, the remote is switched to SCPC as soon as the hub receives the first transmission from the remote.

Load Switching

The next sections describe the principles behind Load Switching and Rate Adjustment (Step Up / Step Down).

Bandwidth Allocation and Load Switching by the STDMA Controller:

As part of normal STDMA processing, the hub monitors the traffic levels from each of the remotes for which it is allocating bandwidth. This is done using the STDMA ACK management message (Table 1) which is transmitted at the beginning of each burst from the remote. The STDMA ACK contains two metrics that are used by the hub:

1. The number of bytes received for transmission (Queued Bytes) since the last cycle.
2. The number of bytes currently waiting to be transmitted (Bytes In Queue).

These metrics are used by the hub for 3 purposes:

1. Determine the amount of STDMA bandwidth (slot size) to allocate in the next cycle.
2. Provide statistics of the amount of activity at each remote (Average Bytes Received).

3. Determine if a load switch is needed.

Table 2.1 STDMA ACK Message

Data Type	Size in Bytes	Description	Unit of Measure	Notes:
IP	4	IP address of Remote	N/A	Used by remote to identify itself
Unsigned	4	Queued Bytes	Bytes	Total number of bytes queued since last cycle (includes possible buffer overflow)
Unsigned	4	Bytes in Queue	Bytes	Number of bytes currently queued
Unsigned	1	Group Number	N/A	
Unsigned	1	Dropped Buffers	Packets	Number of packets dropped (due to limited bandwidth)

If there is adequate upstream bandwidth available, the values of these two metrics will be the same. However, if there is not enough bandwidth to satisfy the traffic requirements of the remote, or if the remote has exceeded the maximum allocation, some data will be held for the next cycle. In this case, the number of Bytes in Queue will start to grow and will exceed the Queued Bytes. (In other words, the Bytes in Queue is the sum of the data not yet transmitted plus the new data received.)

If the condition is due to a short burst of data, the backlogged data will eventually be transmitted and the system will return to a sustainable rate. However, if the overload condition is due to long term increased activity, then the backlog condition will continue to grow and eventually trigger an SCPC switch. If the overload condition lasts long enough, buffer capacity will eventually be exceeded and some data may have to be discarded.



Note: This is not necessarily bad, as it is often more effective to discard old data than transmit it after it has become 'stale'.

The "Bytes in Queue" metric is used to determine the STDMA bandwidth allocated (slot size) for the next cycle; the goal being to keep the data backlog to zero. The hub uses this metric to compute the slot size for each remote in the next cycle as follows:

- **Fixed Mode** - All remotes get the same slot regardless of need; i.e. the metric is not used.
- **Dynamic Cycle Mode** - Available bandwidth is allocated to remotes proportionally based on current need. (The Bytes in Queue for each

remote is divided by the total Bytes in Queue for all remotes to give the percentage allocation for each remote.)

- **Dynamic Slot Mode** - The slot size for each remote is computed based on the time (at the current data rate) needed to transmit all the Bytes in Queue. If the result is less than the minimum slot size or more than the maximum slot size, the slot is adjusted accordingly.
- **GIR (Guaranteed Information Rate) Mode** - Initially computed the same as Dynamic Cycle except there is no maximum limit. After all remotes have been assigned slots, the burst map is checked to see if the total cycle length exceeds 1 second. If not, then all requirements are satisfied and the burst map is complete. However, if the cycle is greater than one second, then the slots are adjusted proportionally so that all remotes receive at least their guaranteed rate plus whatever excess is still available. (In the current design, when the 1 second restriction is exceeded, remotes without a specified GIR are reduced to the global minimum slot size and the remaining bandwidth is distributed amongst remotes that have been assigned a GIR rate. This approach is based on the assumption that remotes that have been assigned a GIR are paying a premium and should benefit from available excess bandwidth when needed. Note that the GIR allocations are restricted so that the assigned GIR totals cannot exceed available bandwidth. If this restriction is somehow violated, then it will not be possible to properly allocate bandwidth when the network is overloaded.)
- **Entry Channel Mode** - This is the same as Dynamic Cycle, except that as soon as the Hub receives an STDMA ACK, it initiates a switch to SCPC mode based on the policy set for that remote.

The important thing to understand about “Bytes in Queue” is that any data that is not transmitted (i.e. does not fit) in the next slot will be reported again in the next STDMA ACK. Thus the “Bytes in Queue” is not necessarily an accurate measure of the actual traffic being passed through the remote.

The “Queued Bytes” on the other hand, reflects only the data that was received in the last cycle and thus is never duplicated (not including TCP retransmissions). This is the metric that is used for computing average load and initiating a load switch as needed.

Before discussing how load switching is determined, it is necessary to explain the user parameters that control the switch. The menu shown in figure B-1 shows the entries in the automatic switching menu at the hub that are used to control load switching.

TABLE B-1

```

Telnet - 10.1.0.23
Connect Edit Terminal Help

                          STDMA/SCPC Auto Switching

Auto Switching.....[Enabled]
Current WAN Transmit Mode.....[Continuous]
Load Switching.....[Enabled].....B
STDMA Slot Capacity.....[95%].....U
STDMA Switch Delay.....[10 seconds].....W
Percent Allocation.....[10%].....E
Time for Carrier Inhibit (0 to disable)..[0].....C

Demod Select.....[1].....Z
Save Parameters to permanent storage.....S
Exit.....X
Telnet Logout.....L

```

Figure B-1 Hub autoswitching menu

- **Auto Switching** - This is a Vipersat Feature which is enabled in the CDM Features Menu. If Auto Switching is not enabled, Load Switching will be ignored.
- **Load Switching** - This is a type of Automatic Switching that is based on the amount of traffic at a remote. If this mode is not set, then no remote will be switched based on load.
- **STDMA Slot Capacity** - This is a threshold value. When the amount of outbound traffic at a remote exceeds this percentage of the current STDMA slot capacity, a load switch is initiated. It is important to understand that in most STDMA modes, the amount of bandwidth allocated to a remote varies with need and thus from cycle to cycle. Thus the amount of traffic that constitutes X% will also vary from cycle to cycle. Furthermore, since the D2 allocation algorithm tends to provide no more bandwidth than is needed, remotes operating in this mode will normally appear to be near 100% capacity whenever they are passing real traffic. Thus, in this mode, if the threshold is set too low, switches will occur unnecessarily.
- **STDMA Switch Delay**- This is a built in latency that forces a remote to maintain an average load over some number of seconds after reaching a switch condition before the switch is actually initiated. This prevents switches due to momentary traffic-bursts.
- **Percent Allocation** - This is an excess amount of bandwidth that is allocated beyond the current traffic rate when the switch to SCPC is made. For example, if the current average traffic at the time of the switch is 60K, and the **Percent Allocation** is 10%, then the allocation will be for 60K + 6K = 66K. (Furthermore, the hub always allocates bandwidth in 16K blocks so 66K rounded up will actually be 80K.)

Load Switching Process

Each time the hub receives an STDMA ACK, it computes the average load for that remote. **(See Appendix A for a discussion of how the average is computed.)** This average is then compared to the bandwidth currently allocated to the remote.

For example, if a remote gets a 50 ms slot in an upstream that is running at 512000 bps then it can transmit $0.050 * 512000 = 25600$ bits = 3200 bytes. If the Queued Bytes was 3000, then for that cycle, the remote was at $3000/3200 = 93.75\%$ of capacity. (If the current cycle time is exactly 1 second, then the effective data rate of the remote is also 25600 bits per second.)

However, if the cycle time is only 500 milliseconds, then the effective data rate is actually $25600 / .5 = 51200$ bits per second. The effective data rate is important for calculating switch data rates. If the average bandwidth used exceeds the threshold percentage of available bandwidth, then a flag is set indicating a switch is pending. At this point, the statistics are reset and the traffic load is then computed for the time period specified by the switch delay. At the end of this delay, if the threshold is still exceeded, a switch is initiated. The data rate specified for the switch is determined by taking the current load, as indicated by the bytes queued during the delay period, multiplying it by the percent allocation and rounding up to the next 16Kbps.

A key point is that in most of the STDMA modes, the bandwidth allocated to each remote is constantly being adjusted to the needs of the network. As long as the network is running below capacity, most remotes will get the bandwidth they need and a switch will not be required.

Only when a remote requires more bandwidth than is available in STDMA will a switch occur.

Furthermore, in D2 mode, each remote will always appear to be running at near 100% capacity, even when there is actually excess bandwidth available. This is because in D2 mode, the remotes are almost never given more bandwidth than they need. As a result, the algorithm for D2 mode uses a maximum allowed slot size rather than the actual allocated slot size to calculate the effective data rate. This gives a more accurate estimate of the available STDMA bandwidth.

Load Switching by a Remote

Once a remote has been switched to STDMA mode, it checks its bandwidth requirements once per second to see if a change is needed. The menu for controlling the Step Up / Step Down switches are set in the menu shown in figure B-2.

```

Telnet - 10.1.128.1
Connect Edit Terminal Help

                          STDMA/SCPC Auto Switching

Auto Switching.....[Enabled]
Current WAN Transmit Mode..[STDMA(Burst)]
Voice Switch Detection....[Enabled].....0
Video Switch Detection....[Enabled].....I
TOS Switch Detection.....[Disabled].....T
Load Switching.....[Enabled].....B
SCPC Step Up Threshold....[95%].....U
SCPC Step Down Threshold...[65%].....D
SCPC Step Delay.....[10 seconds].....W
SCPC Stepup Excess.....[10%].....E
TOS Switching Parameters.....P

Save Parameters to permanent storage.....S
Exit.....X
Telnet Logout.....L

```

Figure B-2 Autoswitching menu for a remote

- **Auto Switching** - Same as Hub
- **Load Switching** - Same as Hub
- **SCPC Step Up Threshold** - Same as **STDMA Slot Capacity** at hub.
- **SCPC Step Down Threshold** - Similar to **STDMA Slot Capacity** at hub except **Step Down** is used to trigger a switch if the average load falls below this value
- **SCPC Step Delay** - Same as **STDMA Switch Delay** at hub
- **SCPC Stepup Excess** - Same as **Percent Allocation** at hub. Note that the value applies to both **Step Up** and **Step Down** switches and if computed against the average traffic load at the time the switch is initiated.

Determining Need-for-Change

The following process is used to determine if bandwidth utilization warrants a need-for-change.

The user defines both a Step Up and Step Down threshold in terms of percent utilization, a bandwidth margin value, and a latency or averaging period. Once per second, the CDM router software determines the current percent utilization by dividing the bits transmitted by the current transmit data rate.

If the percent utilization exceeds the step up threshold or is less than the step down threshold for the entire latency period, then an ASR (Automatic Switch Request) is sent to the VMS. The bandwidth requirement for the ASR is computed by taking the average percent utilization over the latency period and multiplying that by the current data rate to determine the actual data rate used over the measured interval. This number is multiplied by the margin value and rounded up to the nearest 8K to determine the requested bandwidth.

Load Switch Example

An automatic load switching example, illustrated in the schematic diagram in figure B-3, illustrates how a network can respond to changes in traffic volume or load conditions. The network's capability and method of response to load changes is determined by the setting and capability of each of the components in the system such as the transmitter power output, the antenna capabilities for each of the sites in the network, and the policies set in VMS.

The elements for determining policies and their interactions are discussed in this section.

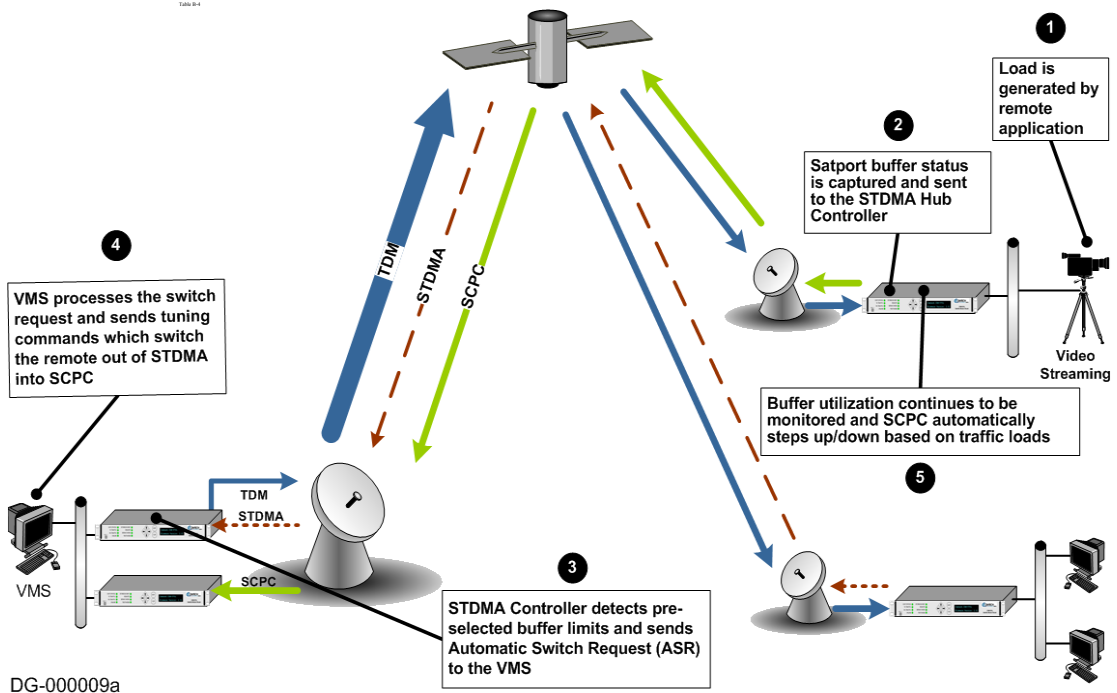

Figure B-3 Load switching diagram

A load switch is illustrated in figure B-3 using the following process.

1. A load is generated an application at a remote. In figure B-3, the application is a video stream.
2. The data is connected to the remote CDM-570/570L over an ethernet link for transmission to the satellite. While the data-stream transmission is in progress, the Satport buffer status is captured and the CDM-570/570L's buffer status is sent to the STDMA Hub Controller.

3. The STDMA Hub Controller compares the remote CDM-570/570L's pre-selected buffer limits with its buffer status and if the buffer status exceeds the preselected limits the STDMA Hub Controller increases the time-slot allocated to that channel. If this brings the buffer status within established limits no further changes are made.
4. If the buffer status continues to exceed the preselected limits, the STDMA Controller sends an Automatic Switch Request (ASR) to the VMS.
5. The VMS processes the switch request by checking for available resources by:
 - Determining if there is a free demodulator.
 - Determining the channel space (bandwidth) requirements to accommodate the data flow requested by the STDMA Hub Controller.
6. If the VMS finds available resources it processes the switch request and sends tuning commands which switches the remote CDM-570/570L out of STDMA into SCPC mode.

The ideal condition being looked for is that about 90% utilization of the channel be achieved striving to optimize the use of available bandwidth.

In the case where the remote CDM-570/570L continues to report buffer overflow, the STDMA Hub Controller will send a request to the VMS which in turn will attempt to double the carrier bandwidth for that channel.

The ability to actually accomplish this is limited by the currently available carrier bandwidth, and ultimately the power output and antenna size available at the transmitting remote site.

If the STDMA Hub Controller cannot make the increase in bandwidth, it will continue to receive buffer status reports from the remote CDM-570/570L indicating that buffer flow is continuing and the STDMA Hub Controller will, in turn, continue to request additional bandwidth from the VMS. If at any time another service drops making bandwidth available, the next time the STDMA Hub Controller requests additional bandwidth the VMS will grant the request.

If the video data stream is completed before the switch in bandwidth is done, the channel is closed, the bandwidth which had been used is made available again to the pool, and no further action is taken.

Reduced data flow in switched mode (SCPC)

In the event the data flow is reduced, for example a streaming file transfer terminates, the SCPC switched demodulator detects the reduced flow and notifies the VMS. Then, after a period of time determined by policies set for the network, the VMS will send a switch command to reduce the size of the carrier bandwidth.

This entire process is automatic following the policies established for the network. The network is dynamically modified changing configuration to automatically respond to changes to the network's load.

The home threshold is the bit rate set to trigger a return to the home threshold. This function is used when bandwidth has been allocated to meet load requirements, and the load has been either removed or partially removed. Since the new load does not require the bit rate established, the Home Threshold is used to determine when the bit rate falls below the preset threshold and switches the channel back to its home condition, STDMA for example.

Application switching

Application switching, diagramed in figure B-4, also is capable of changing bandwidth used, but the change is determined entirely by the type of application being requested ignoring load requirements.

Table B-1
Table B-1

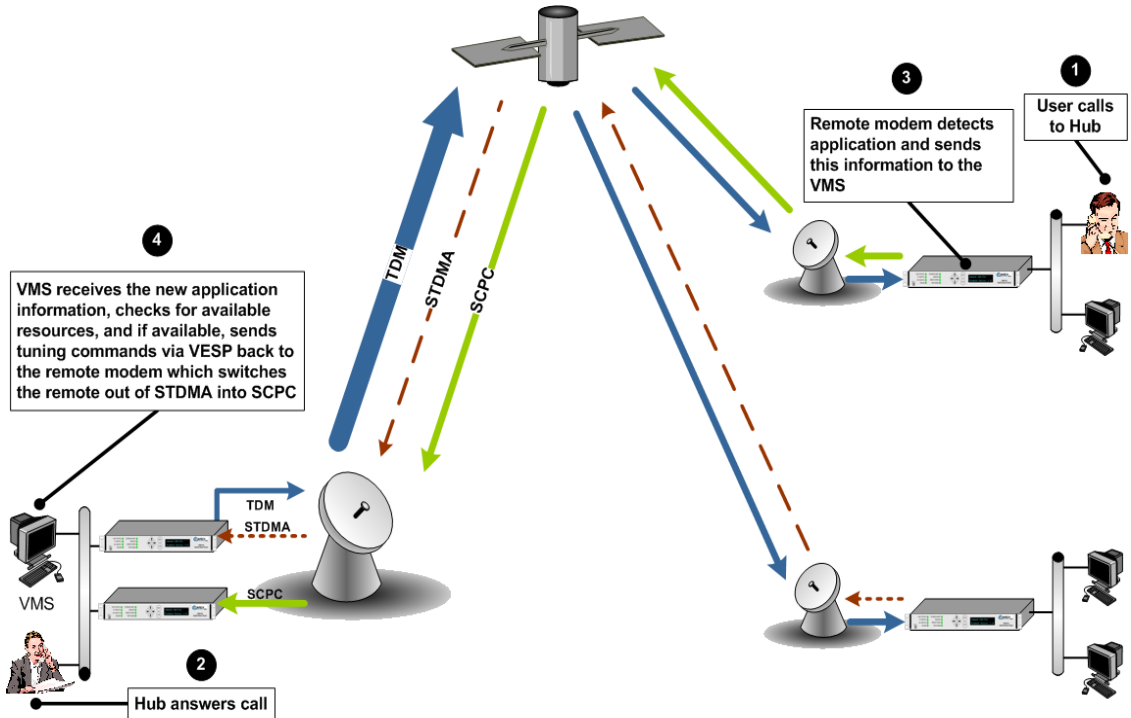

DG-000002a

Figure B-4 Application switching diagram

In a system configured for application switching, the remote site modem/router looks for a packet in the data stream coming from the LAN that is configured using the H.323 stack protocol and contains an H.225 signaling protocol. In the illustration shown in Figure B-4 the signal is a call initiated at the remote site.

The packet is then examined to determine the port number then, from the allocated port ranges, determines the type of application being sent.

The modem/router sends a switch request to the VMS requesting a carrier for the application type. Typical applications include:

- Video
- Voice over IP (VoIP)

Application switching

Each application type will have been assigned a bandwidth allocation when the policy for the remote site is established. The voice application, for example, might have had the bandwidth set in the policy to handle three simultaneous voice connections. When a VoIP protocol is detected in the H.225 signaling protocol, the modem/router requests the VMS to switch the bandwidth to accommodate three voice circuits.

The same process applies if the protocol detected is Video.

When *both* VoIP and Video are requested, the bandwidth required for the Video is used and the VoIP, which has priority, shares the SCPC with the Video.

Once VMS receives the request to switch, it determines if there is a free demodulator and if there is bandwidth space available to handle the requested application. If the resources are available, the VMS then performs the switch.

Applications are streaming data. The remote modem/router looks at the streaming data flow until it sees a break in the data exceeding 10 seconds. Once a break is detected the modem/router presumes that the application is terminated (or has malfunctioned), drops the carrier, and makes the bandwidth resources available for another service.

Type of Service (ToS) Switching

Type of Service (ToS) switching is used on circuits carrying encrypted traffic where the packets cannot be examined to determine the type of traffic being carried. Normally, in a non-encrypted Vipersat network, packets are classified by the remote CDM-570/570L using protocol classification detection and the results are forwarded to VMS via Automatic Switch Request (ASR) messages. The VMS switch detector service then applies the required or requested bandwidth using policies which have been pre-configured in the VMS.

For example, in a non-encrypted network if a voice application service connection is started, the CDM-570/570L's classifier analyzes signaling and data protocols (H.323, SIP, & Data RTP) being routed through the CDM-570/570L. After connection detection, the process waits for data (RTP). Data is normally sent after the receiving party answers, which then triggers the system to process an ASR.

Using the ToS classification, detection function allows application-based-switching in encrypted networks where the signaling protocols are encrypted or effectively hidden. ToS adds the type of service to the un-encrypted Quality of Service byte (QoS) in the header which then can be analyzed to determine the type of service being transmitted. Once the type of service is determined, VMS uses this information to perform switching following the policies established for the detected traffic type.

NOTE

Note: Load switching by VMS is not affected by enabling ToS detection.

Applying a ToS value to an application (VoIP, IPVC, or priority data) through either preservation or classification packet stamping allows the VMS to function in an encrypted network.

Entry Channel Mode (ECM) Switching

STDMA entry channel mode provides a method for remotes requiring SCPC access channels to enter/re-enter the network initially or after a power or other site outage. The switch time will be variable based on the burst rate (bps) of the STDMA group, the number of remotes with slots in the group, and where in the burst cycle the remote is when it acknowledges receipt of the burst map.

Initial SCPC rates are settable for each remote in the STDMA group(s). Upon detection of a burst map acknowledgement from a remote the STDMA burst controller will send a switch request to the VMS with the operator specified initial SCPC rate. Upon determining that there is an available demodulator and pool bandwidth the VMS will send a multi-command to remove the remote from the STDMA group, tune it and the switched demodulator to the specified initial bit rate and selected pool frequency. The remote will stay at this initial rate unless an application (such as VTC) or consistent load cause it to request additional bandwidth from the VMS.

Entry channel mode is not driven by the presence or absence of customer traffic. Once in ECM the switched initial data rate becomes the new temporary home state. Temporary home state sets the low limit data load threshold, where the remote will stop sending load switch request commands. Remotes no longer require burst maps to maintain SCPC transmission.

After all remotes are processed into ECM, the Burst Controller drops into sanity mode sending a keep alive map to service remotes which may have their SCPC carrier inhibit flag set. The keep alive message is sent once every two seconds until re-entry is invoked.

Applications Switching

Comtech Vipersat Networks describes the features of applications switching in the *VMS 3.x.x Users Guide*. As it relates to this application, it is useful to describe the fail-safe mechanism used for freeing pool bandwidth.

If the VMS loses communications with a switched remote for more than three minutes, it will attempt to return the remote to home state. If the revert-to-home state command succeeds (restoring communications) Entry Channel Mode will cause the remote to switch to its initial SCPC bit rate.

If the revert-to-home state command fails, the VMS will send a command to return the remote and the hub demodulator to the state where they were prior to losing communications, but leave the remote enabled in the STDMA burst controller. This provides the remote with 2 paths to rejoin the network:

1. If the outage was the result of power outage at the site, the remote CDM570(L) will reboot in its home state (STDMA), acknowledge the receipt of the first burst map causing it to rejoin the network through ECM. The VMS will park the demodulator previously in use and free the bandwidth slot.
2. If the outage was due to an extended rain fade or other communications blockage with no loss of power, the remote will rejoin the network via the previously assigned SCPC channel. When VMS receives a PLDM it will send a revert-to-home state command and free the bandwidth slot and burst demodulator. The remote will then rejoin the network through ECM.

Since it is not possible to know which of the above scenarios caused the communications outage the VMS will not free the bandwidth slot except through operator intervention.

Figure B-5 and figure B-5 diagram the time state differences and the process of recovery. Note that the times referenced in the diagrams are approximate.

Table B-7

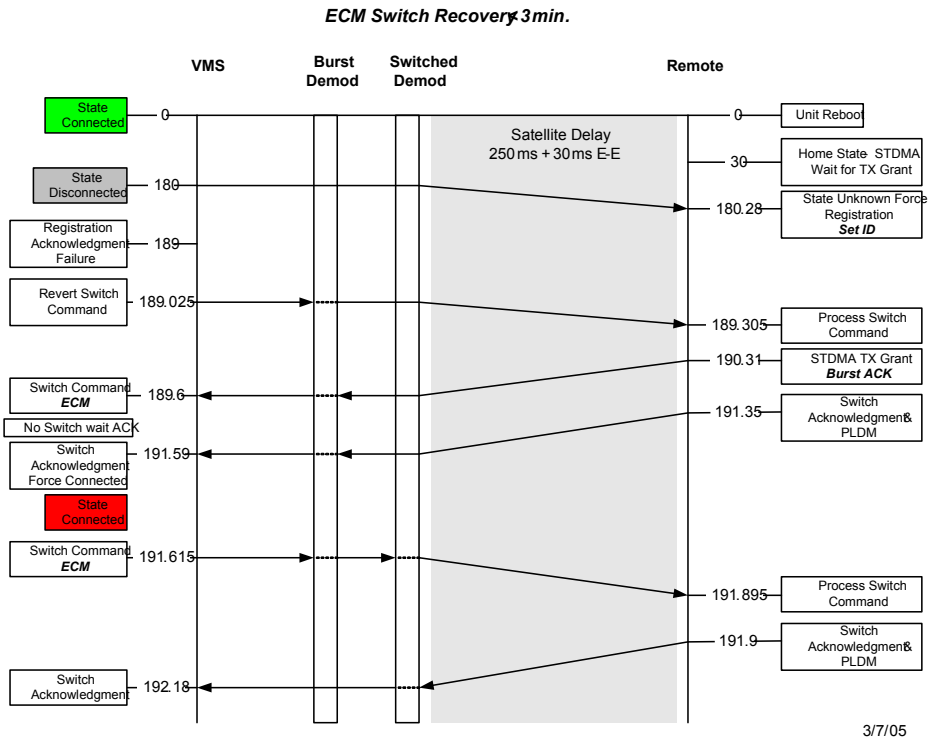
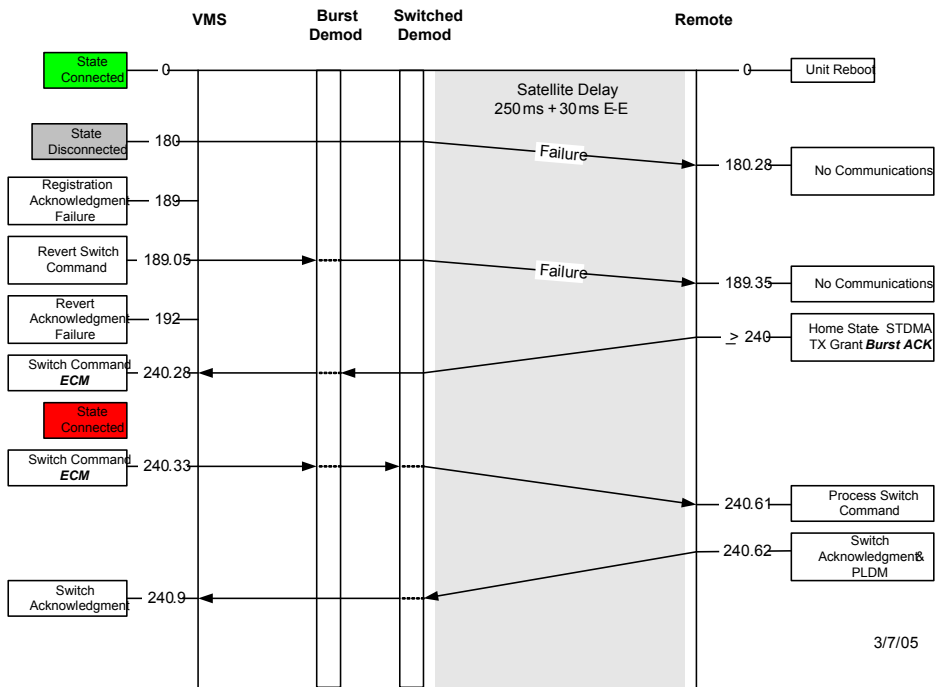

Figure B-5 ECM switch recovery < 3 minutes

Entry Channel Mode (ECM) Switching

Table B-4

ECM Switch Recovery 3min.



3/7/05

Figure B-6 ECM switch recovery > 3 minutes



DYNAMIC POWER CONTROL

Introduction

Dynamic Power Control (DPC) provides a mechanism whereby VIPERSAT satellite links have their transmit power levels adjusted in order to optimize the receive signal quality (as measured by the demodulator E_b/N_0). This optimization process acts to either increase or decrease transmitted signal levels in order to:

- Achieve a minimum level of received E_b/N_0 consistent with providing an error free link.
- Reduce transmit power where sufficient link margin exists in order to optimize station uplink and satellite transponder power usage.

DPC can be selectively enabled and disabled on a link-by-link basis and works on both point-to-point as well as point-to-multipoint links. DPC relies on the passing of an IP message called Path Loss Data Multicast (PLDM) between the receive site (where the receive quality is being measured) and the transmit site (where the power level is to be adjusted). PLDM's are IP unicast messages, and only the transmit site whose frequency and Network ID number matches that contained in the PLDM message will act on the message.

The Vipersat CDM (modulator) units have an algorithm that can, if activated by the VMS, automatically adjust the modulator transmit power to maintain a constant nominal receive signal quality (E_b/N_0) at the corresponding receive station(s). This provides a mechanism to compensate for varying signal levels caused, for example, by the use of different antenna sizes in a mesh network, or if Ku band is being used as a means to compensate for rain fade conditions. The power control algorithm is a closed loop servo-mechanism with the received

E_b/N_0 values as the input function and the modulator's transmit power as the output function. Only modulator transmit power is controlled by the algorithm since the receive chain has its own automatic gain control. DPC can be applied to any or all of the modems with the exception of the STDMA burst control demodulators. Since the STDMA burst demodulators are SCPC fast acquisitions receivers they cannot provide stable signal quality measurements (E_b/N_0). This value is critical in closing the power loop control mechanism.



Note: STDMA is not susceptible to bursts at different power levels since it is a standard SCPC demodulator — as long as the input C/N burst power ranges comply with the performance specifications of the modem. An example is an operation using meshed video carriers.

DPC is a modulator function that cannot be enabled in remotes operating in STDMA mode. DPC is automatically turned on when the remote switches to SCPC mode.

Description

Operation of the DPC algorithm is controlled by the parameters shown in table C-1, below.

Table C-1 Dynamic Power Control Parameters

Parameter	Default	Significance
Nominal Power Level	-25 to -5 dBm	Power used for scaling Maximum power after switching
Calibrated Data Rate	System Specific	Data Rate which is used for scaling Maximum power after switching
Maximum Power Level	System Specific	Maximum transmit power level permitted based on link/satellite parameters
Minimum Power Level	System Specific	Minimum transmit power level permitted based on link/satellite parameters
Max Step Down Power	3 dB	Largest step reduction in transmit power permitted
Max Step Up Power	3 dB	Largest step increase in transmit power permitted
Target E_b/N_0	10 dB	Target E_b/N_0 value for which DPC is aiming

Table C-1 Dynamic Power Control Parameters

Parameter	Default	Significance
Target Range	0.2 dB	Target range for no power adjustment; No adjustment occurs when power is within this range
Speed Up Eb/No	5 dB	DPC and PLDM process speeded up from default (1/min) if Eb/No is below this amount

The start point for all enabled modulators is the Nominal Power Level. This level is measured during initial system turn-up and is the power level at which all modems will initially transmit when a call is established. Once communication is established and data starts to flow, the modulator begins receiving DPC packets from the demodulator and adjusting its transmit power level accordingly.

The transmit power level is compared to the received Eb/No. Depending on whether the transmit power is high or low, the modulator transmit output level is adjusted in steps (step size set by parameters Max Step Up/Down Power) until the Eb/No is within the range set by the Target Range for no power adjustment.

If the received Eb/No should, for any reason, fall below a minimum value set by the Speed Up Eb/No parameter then the PLDM messages will be transmitted at a faster rate until the nominal level is restored.

Adjustment for Data Rate

The maximum output power level is scaled according to the data rate at which the modulator is transmitting. Consider, for example, a system that normally runs at a data rate of 512 kbps with a Nominal Power Level of -10 dBm and a Maximum Power Level of -5 dBm. If a voice switch occurs that sets the data rate to 32 kbps, the power requirements are much lower than the nominal -10 dBm level. With the above process, it is theoretically possible for the power to be raised all the way to -5 dBm, which is past the saturation point for such a small data rate. To prevent the use of excessive power that will drown out the signal and cause damage to the satellite, the modulator calculates a maximum power that is appropriate for its current data rate.

The net result of the DPC algorithm is that the transmit power of all video carriers is adjusted such that the receiving modems see a constant Eb/No value. This optimizes receive signal quality and use of system resources since it can lead to a reduction in power amplifier intermodulation and also a conserving of satellite transmit power.

DPC Scaling Function

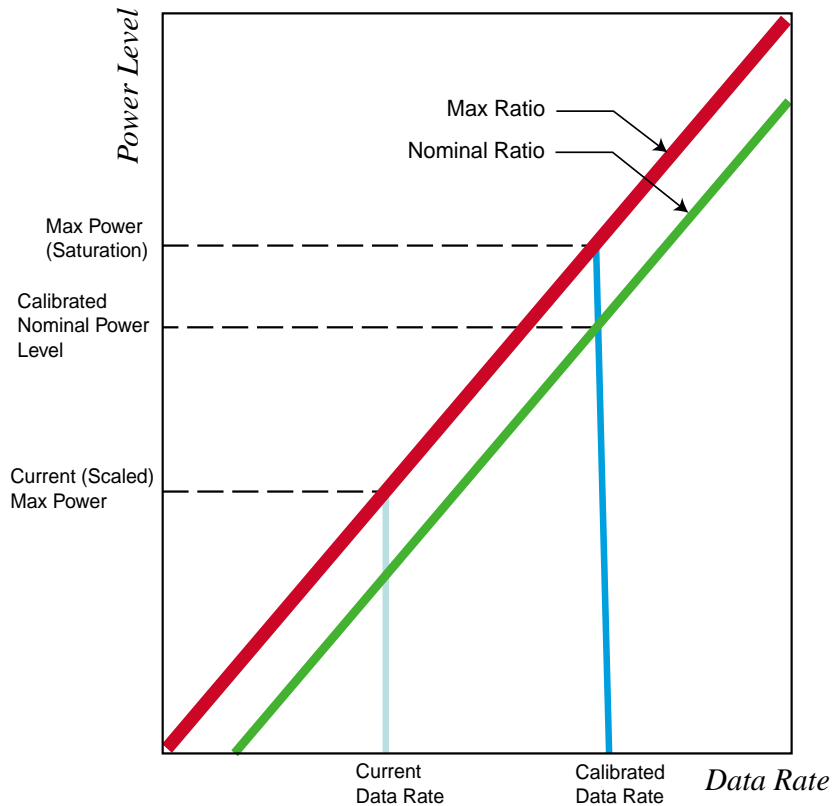

Figure C-1 DPC Scaling Function

Figure C-1 illustrates the scaling function, based on the ratio of power level to data rate, of the DPC system. Once this ratio is mapped out for the system, the DPC scaling function will automatically determine the appropriate power level for any given data rate. Three parameters are essential for this scaling function:

- Calibrated Data Rate
- Calibrated Nominal Power Level
- Maximum Power Level

As determined during initial system turn-up, the Calibrated Data Rate and the Calibrated Nominal Power Level values for the CDM are entered into the VMS *Home State* menu. The Maximum Power Level (the point at which the signal reaches saturation) for the Calibrated Data Rate is then determined, and entered into the VMS *DPC* menu (or the CLI *Dynamic Power Control Configuration* menu). If these home state parameters have not been entered, DPC will not be

able to function and will disable itself, resulting in an error message that is displayed in the CLI.

Under most circumstances, the system will be running at the Calibrated Data Rate, at the Calibrated Nominal Power level. When the VMS sends a switch command to the CDM, the modem will go to a different data rate, and will calculate a nominal power level for the transmitter. Communication is established, data starts to flow, and the modulator begins receiving DPC packets from the demodulator and adjusting its transmit power level accordingly. When changing its power, the CDM will calculate a scaled maximum power based on its current data rate and certain other values in the home state. This calculated maximum is what insures that the modulator is not transmitting with more power than is necessary, thus preventing problems.

{ This Page Intentionally Blank }

D

NETWORK MIGRATION

Upgrading CDM-570/CDD-564 Series Modems to Firmware Version 1.5.3

General

This document covers the migration of networks with CDM-570 and CDD-564 series modems to Firmware version 1.5.3 from any earlier versions of code. It addresses the issues customers will face when migrating their networks and provides a step-by-step plan to facilitate the process.

Comtech Vipersat Networks strives to make firmware migrations as painless as possible by maintaining backward compatibility with prior versions of code. Only under unavoidable circumstances where it is absolutely necessary will backward compatibility be broken. To provide a considerable increase in performance and reliability, the HDLC over-the-air frame was changed from 16 to 24 bit Cyclic Redundancy Check (CRC). By doing so, backward compatibility with all previous versions has been broken.

Customers with existing networks will need to carefully plan the migration to the new version of code. There is no particular problem presented for upgrading Hub units, Remote mesh units or spares inventories. However, as soon as the Hub units are rebooted to the new v1.5.3 code they will lose communications with Remote data units that are running v1.5.2.2 or earlier code. The Hub operator must take care to insure all Remote data units that are online have the new v1.5.3 code in the slot to which they will reboot.

Note that the main concern is for any Remotes that are offline during the migration phase, and then come back online sometime afterwards.

Since there is no way to guarantee all Remote sites will be online during the initial upgrade to v1.5.3, Vipersat is providing this migration procedure and utility to facilitate picking up new or offline units. This migration tool includes non-saved control parameters at Hub units only that allow the operator to select compatibility mode with v1.5.2 (or earlier) firmware. When the operator initiates this backwards compatibility migration control, communications with all Remote units at the newly upgraded version 1.5.3 will be lost during that time. However, when the migration parameter is set in the TDM outbound and the appropriate Burst Controller(s), communications with v1.5.2 (or earlier) straggler/offline Remotes will be restored. At this point they can be upgraded to v1.5.3, restoring total network wide communications.

This will represent a network outage to all Remotes connected to the TDM outbound. In networks with a DVB outbound, only those Remotes associated (grouped) with the Burst Controller set to v1.5.2 compatibility will lose communications.

Great care should be exercised in following these steps as outlined in this document. It is important to remember that network communications will not be effected until the units are rebooted to v1.5.3 router code. The last section of this document addresses recovering stragglers/offline remotes.

Firmware Upgrade

Upgrade Overview

This procedure describes the firmware upgrade process using both the Vipersat Vload Utility and a Telnet connection. For detailed information on using Vload, refer to the *Vload Utility User Guide*.



Caution: This firmware installation procedure requires the modem to be rebooted which, in turn, will cause a satellite circuit to drop momentarily. Firmware installation should be done when it will not cause disruption of a live circuit carrying customer traffic.

Required Support Utilities and Firmware

- PC Running Microsoft Windows (Latest OS)
- VLoad v3.1.6
- VLOAD Utility 3.1.x User's Guide
- Parameter (.DLL) v1.5.3.6
- Telnet (Windows Program)
- FW10805P.bin (Base Modem Firmware v1.4.5, If upgrading from v1.3.3)
- FW10805U.bin (Base Modem Firmware v1.5.1)
- FW10875J.bin (IP Option Firmware v1.5.3, CDM-570/570L)
- FW11669D.bin (Unit Firmware v1.5.3, CDD-564/564L)

Basic Steps

The Vipersat CDM-570/CDD-564 series of modems are comprised of two main parts, the Base Modem and the Router Card. These two parts function with different firmware code, each of which must be upgraded using the sequence of steps below.

- 1) "Get Information" from all units using VLOAD, this will retrieve currently loaded image versions.
- 2) Upgrade Bulk Image location #1 on the router to v1.5.3 Firmware.
- 3) Save Flash on all units and reset them to Latest/Oldest.
- 4) "Get Information" (VLOAD needs current information before performing each step).
- 5) Upgrade Bulk Image location #1 on the base modem to v1.4.5 and reset all boxes to "Latest" code. Note this is only necessary if unit is running < v1.4.4.

Firmware Upgrade

- 6) "Get Information" and load v1.5.1 base modem code to "Oldest" and reset all the modems to "Latest".
- 7) Load v1.5.1 modem code to "Oldest" (replacing the older image in the other location).
- 8) Load v1.5.3 router firmware to the "Oldest" Bulk Image.

CDM570 Router Card		CDM570 Base Modem		
Bulk #1	Bulk #2	Bulk#1	Bulk #2	
1.5.2.2	1.5.2.2	1.3.3	1.3.3	After 1
1.5.3	1.5.2.2	1.3.3	1.3.3	After 4
1.5.3	1.5.2.2	1.4.5*	1.3.3	After 5
1.5.3	1.5.2.2	1.4.5	1.5.1	After 6
1.5.3	1.5.2.2	1.5.1	1.5.1	After 7
1.5.3	1.5.3	1.5.1	1.5.1	After 8

- Note: 1.4.5 will originally load into the inactive slot, which could be either 1 or 2.

Figure D-1 Firmware Migration Stages

Migration Procedure

Getting Information with VLOAD

The first step in getting information is to discover the units in the network. Do this by performing an "Add All" as shown in the figures below.

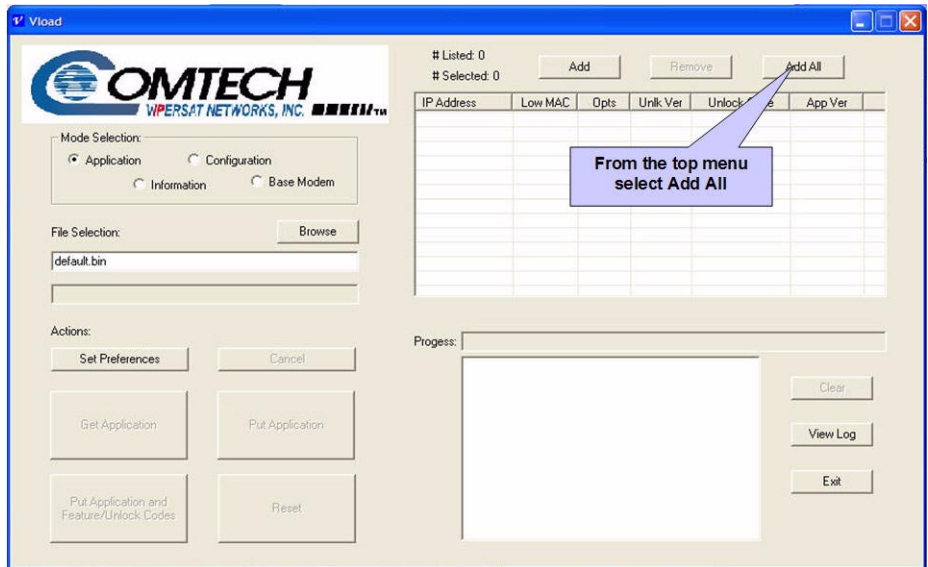

Figure D-2 Initial Vload screen

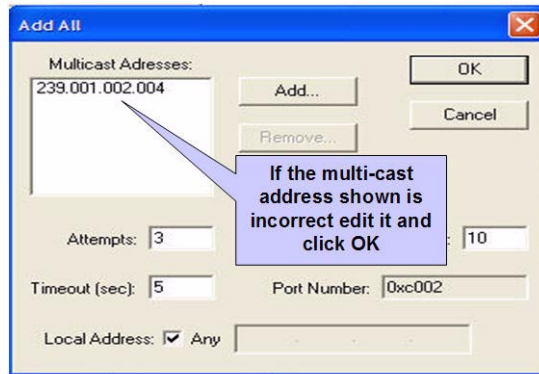

Figure D-3 Add All dialog

Note that the Receive Multicast Address is the same as the Transmit Multicast Address for the VMS. This IP address can be found under the VMS ViperView tree view “Vipersat Manager”.

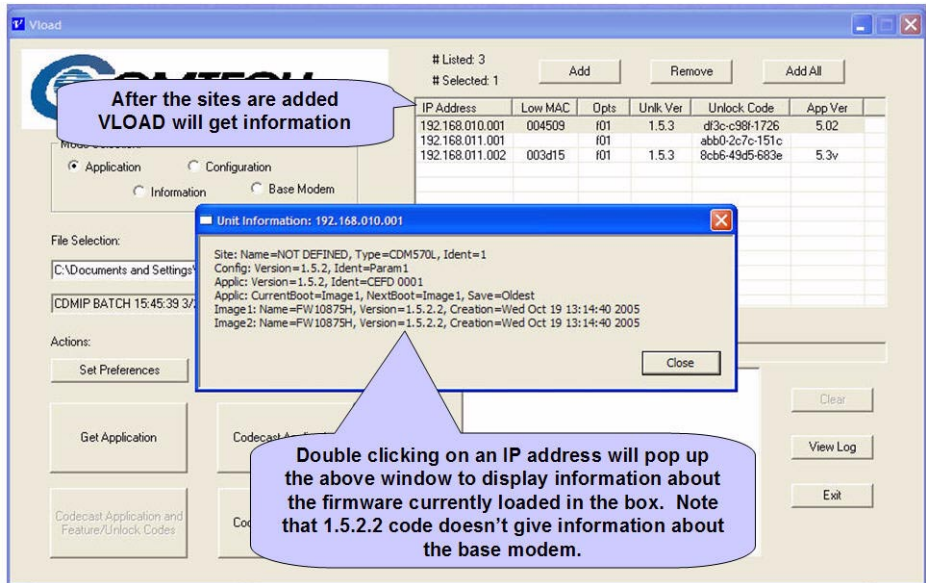

Figure D-4 Get Information for IP Address

It is very important to get information after each step. VLOAD needs to be aware of the current configuration of the modems when making decisions about "Oldest" and "Latest".

Upgrade Router to v1.5.3

This step will upgrade the Bulk Image location 1 of the Router Card to version 1.5.3 firmware. The Vload Utility provides 3 methods of loading code:

- 1) **Consecutive** - Vload will download each IP address consecutively. Useful if loading 1 or 2 units, but very slow for loading networks.
- 2) **Concurrent** - Vload will download all selected IP addresses simultaneously. Useful if loading multiple units over a Local Area Network or installed networks with large TDM or DVB Outbound Carriers. Take care not to over-run the outbound (TDM) transmission rate.
- 3) **CodeCast** - Vload will multicast to all selected IP addresses. The units must all have the same CodeCast address. CodeCast is useful for large networks that have limited bandwidth available on the TDM outbound.

Refer to the *Vload Utility User Guide* for a description of each type and to determine which suits your network best. Below is an example of the screen displayed for "Consecutive".

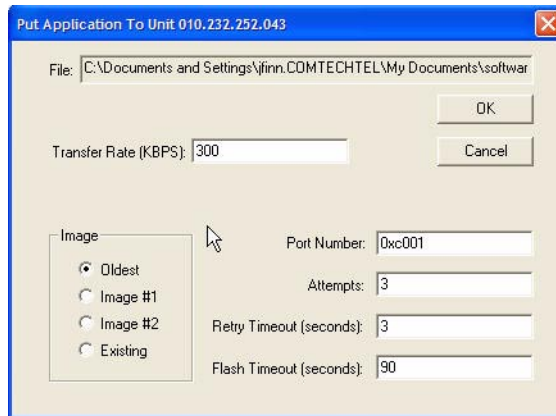

Figure D-5 Put Application screen (Consecutive Load)

Save and Reboot to Latest

Using either VMS or CLI, **Save** each unit to flash and reboot with **Hard Reset** to **Latest**.

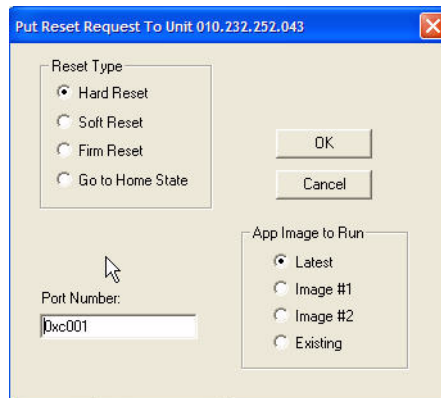

Figure D-6 Hard Reset screen

Note that all other parameters are set to defaults and do not require any changes.

Get Information for Router v1.5.3

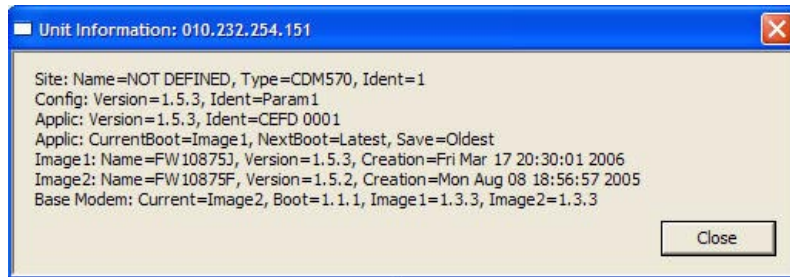

Figure D-7 Unit Information screen (Router)

The new unit information will show that Image 1 Version=1.5.3 and that the Application Version=1.5.3. The application CurrentBoot should = the image slot location of 1.5.3, and NextBoot=Latest and Save=Oldest.

The next part of this step is very important. Prior to version 1.5.3 code, the configuration files did not include all modem parameters or any Out Door Unit (ODU) parameters. These parameters are stored in 2 lines in the configuration file. If they are not saved, the modem will go to the default settings, causing the BUC and LNB to turn Off. As a result, the Remote will be lost when the modem firmware is updated.

Select "Configuration" in mode selection and "Get Configuration".

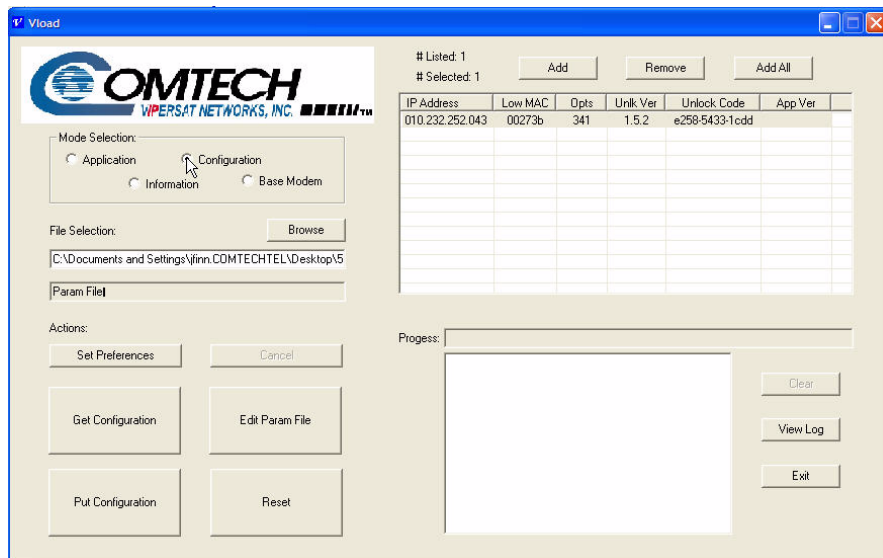

Figure D-8 Select Configuration screen

Save the configuration file. Open it using WordPad. Insure that the lines shown in figure D-9 are in the configuration near the bottom of the file.

```

MGC_SAVE#0      = 0001432.05656140128.0001223.02010009.960xxxxxxx0970.05456140128.00002003202
OGC_SAVE#0      = 010000xxxx1000200015450-xxxxxx0101060011300+xxxxxxx

```

Figure D-9 Configuration File Text

If this text is not displayed, **Save** to flash again, get the configuration and check for them in the configuration file once more. Note that the contents of the text lines will differ based on the actual configuration and modem type.

Upgrade Base Modem to v1.5.1

The Base Modem upgrades have to be done in 2 steps. This is necessary because the memory map changed with the v1.4.x firmware and v1.3.3 is not capable of writing directly to v1.5.x firmware.

Upgrade Image 1 on Base Modem to v1.4.5

Select **Base Modem** under Mode Selection, then click **Browse**. Two files named FW10805 will appear. Select the file name that ends with “P”; this is the v1.4.5 firmware file.

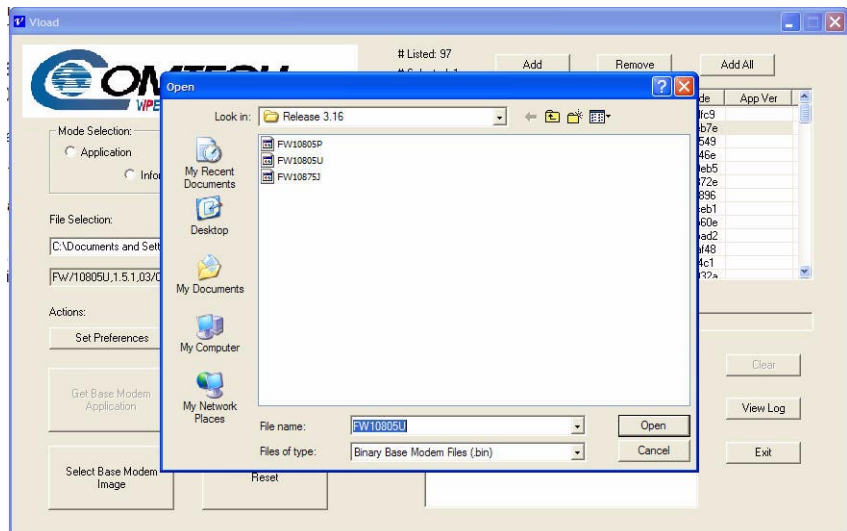

Figure D-10 Browse for Firmware File

Put the v1.4.5 modem firmware using the appropriate selected mode (Consecutive, Concurrent, or CodeCast).

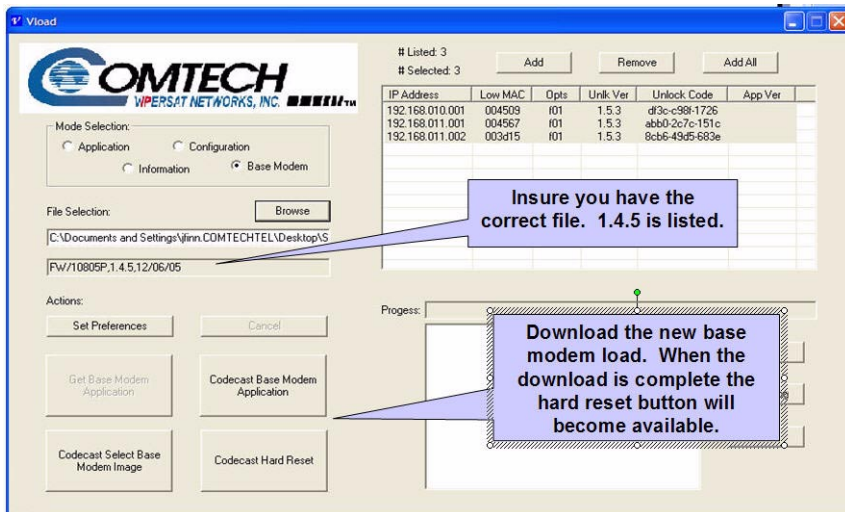

Figure D-11 Download v1.4.5 and Hard Reset screen

When the file transfer is completed, Hard Reset the Modem(s).

Upgrade Image 1 on Base Modem to v1.5.1

Get Unit Information to show that v1.4.5 modem code is loaded in Image 1 and that the Base Modem Current Image = Image 1. Which image this is will depend on which image was running in the modem; it will automatically select the offline image to upgrade.

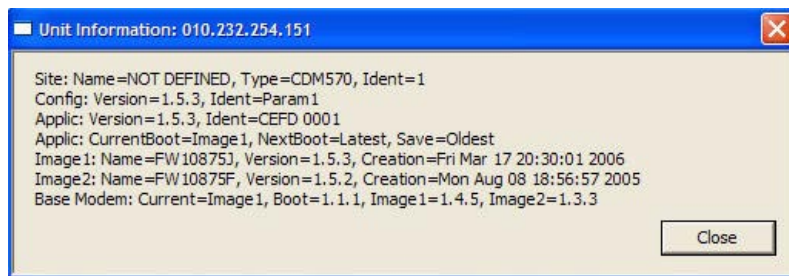

Figure D-12 Unit Information screen (Base Modem Image 1)

Browse for the v1.5.1 Base Modem firmware. The file name is **FW10805U**.

If the file can not be found, it can be downloaded from the *Comtech EF Data* web site:

<http://www.comtechefdata.com/>

The FW10805U.bin file can be found under Downloads, Flash Upgrades.

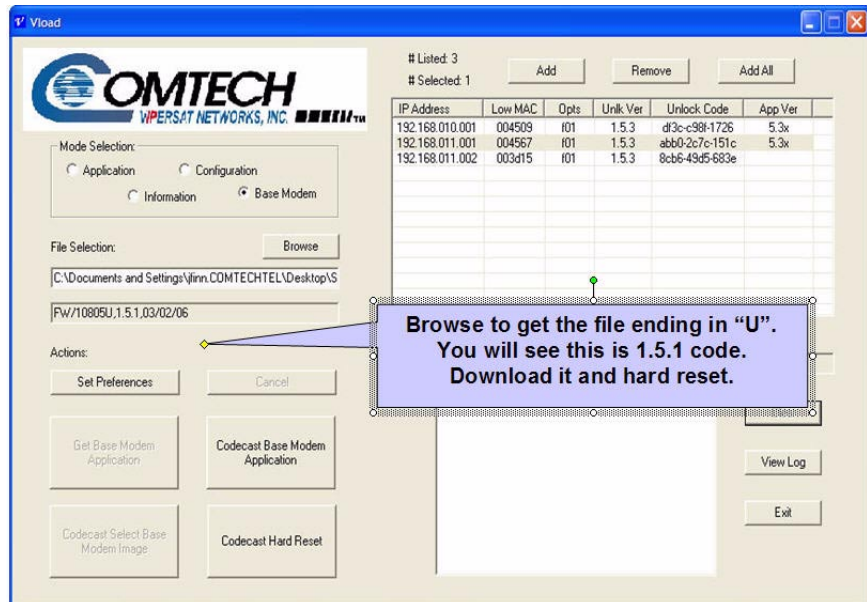

Figure D-13 Download v1.5.1 and Hard Reset screen

Download Base Modem v1.5.1 to Image 2

Get Unit Information to show that the current Base Modem image is Image 2, which is v1.5.1 firmware.

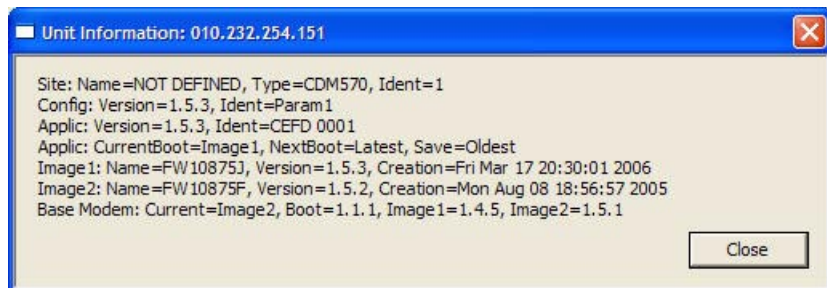

Figure D-14 Unit Information screen (Base Modem Image 2)

Repeat the Download procedure for the Base Modem v1.5.1 firmware file, but do not perform a Hard Reset; it is not necessary to reboot the modem again. This will insure that the v1.5.1 firmware is in both images in the Base Modem, as shown in figure D-15.

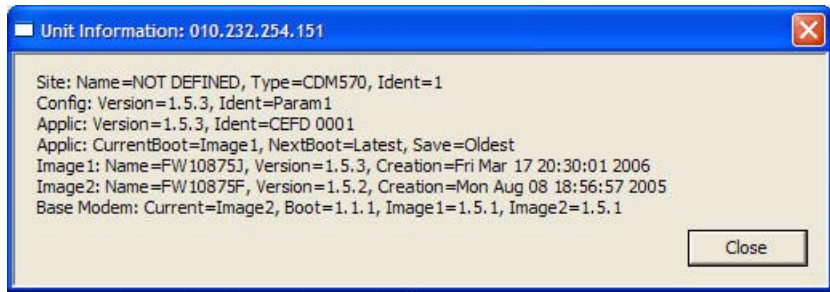

Figure D-15 Unit Information screen (Base Modem v1.5.1)

Download Router v1.5.3 to Image 2

Download the v1.5.3 firmware file to the Router Image 2. This insures that the latest firmware code is loaded in all images.

Get Unit Information one last time and **Save** the file when prompted. This file can be used to maintain a record of unlock codes and sent to Comtech Vipersat if additional features are required. The final "get Information" should look like the one displayed below.

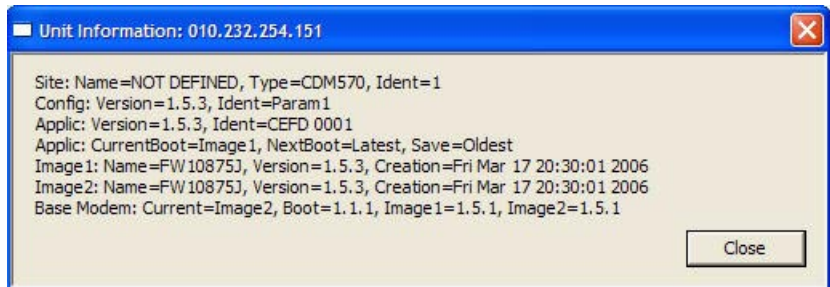

Figure D-16 Unit Information screen (final status)

Completing Migration

Picking Up Straggler/Offline Remotes

Ideally, all Remote units will be online during the migration phase. However, in a live network this cannot be guaranteed. Therefore, Vipersat provides a way to temporarily revert the TDM outbound and Burst Controller(s) to v1.5.2 HDLC WAN Framing compatibility mode. Remotes that had lost power or otherwise were offline during the upgrade can be recovered at this time. Remotes running

the v1.5.3 firmware will lose communications during this time, so a planned maintenance outage is necessary.

It is only necessary to download 1 image of the Router to v1.5.3 and reset the Remotes in order for them to rejoin the network, unless the associated Burst Controller is running BFAT. If that is the case, it is suggested that BFAT be disabled, and that the STDMA Preamble be increased. This will allow restoration of communications to all Remotes, with reduced performance. Once the straggler Remote(s) have v1.5.1 modem code loaded, BFAT can be re-enabled. The appropriate Preamble length will be reset automatically when BFAT is running.

Setting v1.5.2 Compatibility in Hub Modems

Telnet into the TDM Outbound and Burst Controller Hub units associated with the straggler Remote(s) and follow the steps below.

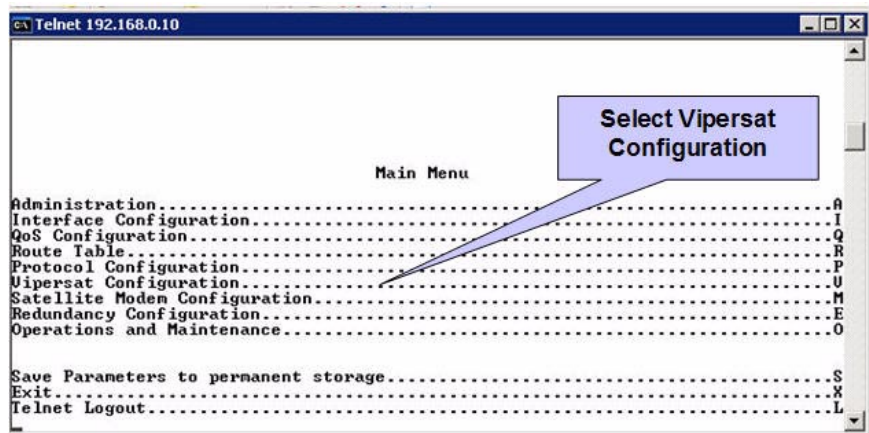

Figure D-17 Main Menu screen, CLI

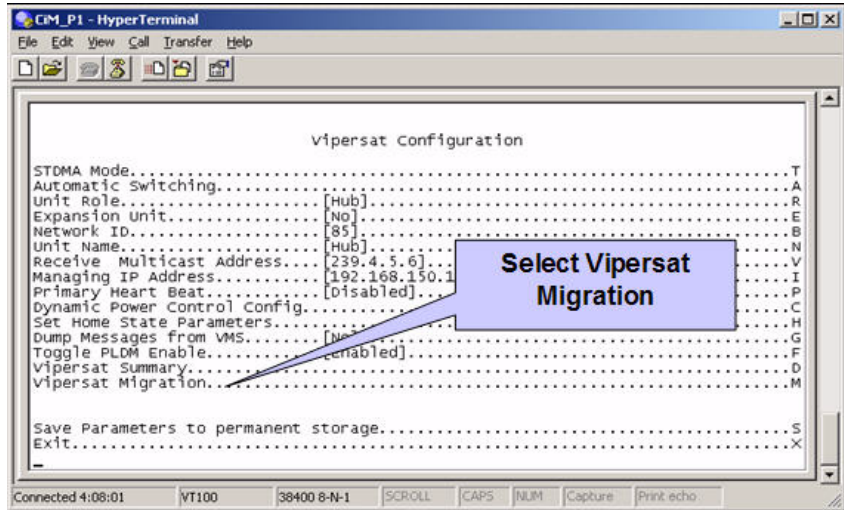

Figure D-18 Vipersat Configuration screen

The Vipersat Migration Parameter "M" is available only on Hub non-expansion units.

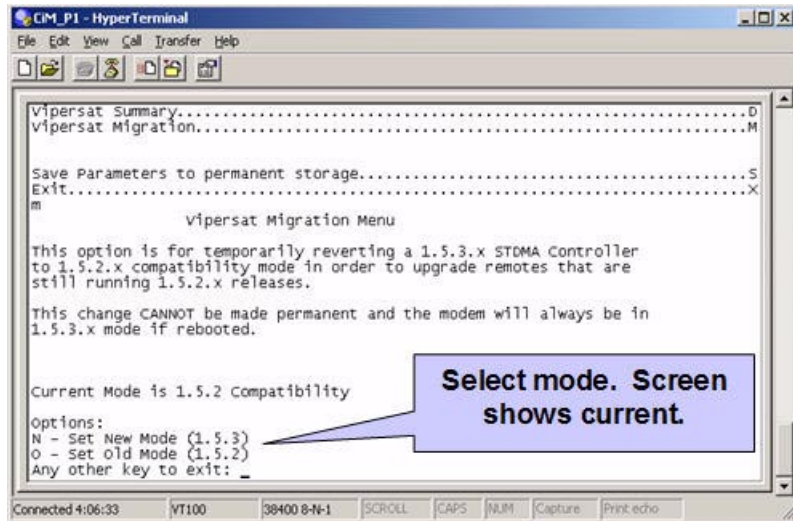

Figure D-19 Vipersat Migration prompt

Select **O** to set the old framing mode to v1.5.2 or earlier. This parameter must be set in both outbound and inbound units to properly transmit/receive to/from Remote units.

The straggler Remotes will now frame on the TDM outbound signal. The associated Burst Controller(s) will frame on the inbound signals from these Remotes ONLY.

Download the v1.5.3 Router firmware and Reset the straggler Remotes.

Return the network to N (1.5.3) compatibility.

{ This Page is Intentionally Blank }

E

GLOSSARY

A

- ALC** **A**utomatic **L**imit **C**ontrol is a closed loop mechanism controlling the gain stabilization of the HPA's RF output power.
- APL** **A**synchronous **P**arty **L**ine – A VIPERSAT term for RS-485 multi-drop bus used for control of indoor equipment. See also SPL.
- ARP** **A**ddress **R**esolution **P**rotocol – A protocol for a LAN device to determine the MAC address of a locally connected device given its IP address. See also MAC.
- ASR** **A**utomatic **S**witch **R**equest is a switch request message used in legacy VMS installations
- ATM** **A**synchronous Transfer Mode (ATM)

B

- BER** **B**it **E**rror **R**ate (sometimes **R**atio) – A measure of the number of data bits received incorrectly compared to the total number of bits transmitted.
- BUC** **B**lock **U**p **C**onverter
- Bps** **B**its **P**er **S**econd – A measure of transmission speed. See also kb/s & Mb/s

BPSK **B**inary **P**hase **S**hift **K**eying – A modulation technique in which the carrier is phase shifted +/- 180 degrees. See also QPSK

C

C-Band A frequency band commonly used for satellite communications (and sometimes terrestrial microwave). For terrestrial earth stations the receive frequency band is 3.7-4.2GHz and transmit 5.925-6.425GHz. See also Ku-band.

CRC **C**yclic **R**edundancy **C**heck – A method of applying a checksum to a block of data to determine if any errors occurred during transmission over communications links.

CXR **C**arrier – A radio frequency transmission bearer linking points and over which information may be carried.

D

DAMA **D**emand **A**ssigned **M**ultiple **A**ccess – A process whereby communications links are only activated when there is an actual demand.

dBm **D**ecibel referenced to 1 milliwatt.

DHCP The Dynamic Host Configuration Protocol (DHCP) is an Internet protocol for automating the configuration of computers that use TCP/IP.

DNA **D**ynamic **N**ode **A**nnouncement – In VIPERSAT satellite networks a process whereby remote sites periodically announce their presence to facilitate network setup and monitoring.

DOS **D**isk **O**perating **S**ystem – A computer operating system.

DPC **D**ynamic **P**ower **C**ontrol.

DRAM **D**ynamic **R**andom **A**ccess **M**emory

DSP **D**igital **S**ignal **P**rocessor – A microprocessor chip optimized for signal processing applications.

DVB **D**igital **V**ideo **B**roadcast

DVP **D**igital **V**oice **P**rocessor – The VIPERSAT voice card used in packet voice applications.

E

- Eb/No** **Eb/No Ratio** **Eb** = energy per bit **No** = noise power density per Hz. The bit error rate (BER) for digital data is a decreasing function of this ratio. **Eb** is the energy of an information bit. **Eb** is measured in Joules, or equivalently in Watts per Hertz.
- EEPROM** **Electrical Erasable Programmable Read Only Memory**. This equipment component is used to record and store data that needs to be retained when the equipment is powered down.
- E&M** **Ear & Mouth** (literally) – The signaling leads used to carry telephone circuit signaling or indicate circuit activity or status.

F

- FDMA** **Frequency Division Multiple Access** – A technique where multiple users can access a common resource (e.g. satellite) by each being allocated a distinct frequency for operation. See also TDMA.
- FEC** **Forward Error Correction** – A process whereby data being transmitted over a communications link can have error correction bits added which may be used at the receiving end to determine/correct any transmission errors which may occur.
- FIFO** **First In First Out** – A simple buffer or queue technique whereby data queued the longest is transmitted first.
- FTP** **File Transfer Protocol** – An application for transferring computer files over the Internet. See also TFTP.
- FXO** **Foreign eXchange Office** – a 2 wire telephone interface that looks like a line originating from a telephone exchange. See also FXS.
- FXS** **Foreign eXchange Subscriber** – a 2 wire telephone interface that looks like a line coming from a telephone instrument. See also FXO.

G

- G.729** ITU standard for **LD-CELP** (**L**ow **D**elay – **C**ode **E**xcited **L**inear **P**rediction) voice encoding at 8kb/s.

- Group ID** A number assigned to equipment which defines it as a member of a group when addressed by the burst controller.
- GUI** **Graphical User Interface** – A form of graphical shell or user interface to a computer operating system.

H

- HDLC** **High Level Data Link Control** – A standard defining how data may be transmitted down a synchronous serial link.
- HPA** **High Power Amplifier** – The amplifier used in satellite communications to raise the transmit signal to the correct power level prior to transmission to satellite. See also SSPA.
- HTTP** **Hyper Text Transfer Protocol** – The Internet standard for **World Wide Web (WWW)** operation.
- Hub** The central site of a network which links to a number of satellite earth sites.

I

- ICMP** **Internet Control Message Protocol**.
- Installation Wizard** A program which guides the user through the process of installing an application.
- IF** **Intermediate Frequency** – In satellite systems, IF frequencies are usually centered around 1200 MHz (L-band), or 70 MHz (video/TV).
- IP** **Internet Protocol** – A format for data packets used on networks accessing the Internet.
- ISP** **Internet Service Provider** – A company providing Internet access.
- ITU** **International Telecommunications Union**.

K

- Kb/s** **Kilo Bits per Second** - 1000 bits/second. A measure of transmission speed. See also bps & Mb/s.
- Ku-Band** A frequency band used for satellite communications. For terrestrial earth stations the receive frequency band is in the range 10.95 – 12.75GHz and transmit 14.0 – 14.5GHz. See also C-band.

L

- L-Band** A frequency band commonly used as an IF for satellite systems using block up/down conversion. Usually 950-1450MHz.
- LAN** **Local Area Network**.
- LLA** **Low Latency Application**
- LNA** **Low Noise Amplifier** - An amplifier with very low noise temperature used as the first amplifier in the receive chain of a satellite system.
- LNB** **Low Noise Block** - A downconverter so called because it converts a whole band or “block” of frequencies to a lower band. It is similar to LNA.
- LNC** **Low Noise Converter** - A combined low noise amplifier and block down converter, usually with an L-band (typically 950-1450MHz) IF.
- LO** **Local Oscillator**

M

- M&C** **Monitor & Control**.
- MAC** **Media Access Control** - A protocol controlling access to the physical layer of an Ethernet network.
- Mb/s** **Mega Bits per Second** - 1 Million bits/second. A measure of transmission speed. See also bps & kb/s.
- Modem** **MODulator and DEModulator** units combined.
- Multicast** Transmitting a single message simultaneously to all.

N

- NAT** **Network Address Translation** - An Internet standard that enables a local-area network (LAN) to use one set of IP addresses for internal (private) traffic and a second set of addresses for external (public) traffic.
- NOC** **Network Operation Center (NOC)** has access to any earth station installed using the VIPERSAT Network Control System (VNCS). An NOC can remotely interrogate, control, and log network activities.

O

- ODU** **Outdoor Unit** – In a VSAT system the RF components (transceiver) are usually installed outdoors on the antenna structure itself and are thus referred to as an ODU.
- OSPF** **Open Shortest Path First** - A common routing algorithm.

P

- PLDM** **Path Loss Data Multicast** message is sent every sixty seconds and contains information on messages received or lost.
- POP3** **Post Office Protocol 3** - A protocol for exchanging e-mail messages between host computers. See also SMTP.
- PMUX** **Port Multiplexing** - Each port of the SDMS is individually configured from the NMS port (hub) to port (remote) multiplexing.
- PSTN** **Public Switched Telephone Network** - Refers to the international telephone system based on copper wires carrying analog voice data.

Q

- QPSK** **Quaternary Phase Shift Keying** – A modulation technique in which the carrier is phase shifted +/- 90 or +/-180 degrees. See also BPSK

R

- RF** **Radio Frequency** – A generic term for signals at frequencies above those used for baseband or IF.
- RFC** **Request For Comment** – The de-facto Internet standards issued by the Internet Engineering Task Force (IETF).
- RIP** **Routing Information Protocol**
- RS-232** A common electrical/physical standard issued by the IEEE used for point to point serial communications up to approximately 115kb/s.
- RS-485** A common electrical/physical standard issued by the IEEE used for multi-drop serial communications.
- Rx** **Receive.**

S

- SCPC** **Single Carrier Per Channel** – A satellite communications technique where an individual carrier is transmitted to a single destination.
- SDMS** **Star Data Management System** – VIPERSAT equipment forming the heart of the **VIPERSAT** system.
- SMTP** **Simple Mail Transfer Protocol** - A protocol for exchanging e-mail messages between host computers. See also POP3.
- SNMP** **Simple Network Management Protocol** – A protocol defining how devices from different vendors may be managed using a common network management system.
- SPL** **Synchronous Party Line** – An electrically isolated interface between indoor and outdoor equipment used in VIPERSAT satellite systems. See also APL.
- SSPA** **Solid State Power Amplifier** – A high power amplifier used in satellite communications using semiconductor rather than vacuum tube devices. See also HPA.
- Star Topology** A network topology which, if drawn as a logical representation, resembles a star with a hub at the center.
- STDMA** An acronym for **Selective Time Division Multiple Access**

T

- TCP/IP** **T**ransmission **C**ontrol **P**rotocol / **I**nternet **P**rotocol – A standard for networking over unreliable transmission paths. See also UDP.
- TDMA** **T**ime **D**ivision **M**ultiple **A**ccess – A multiple access technique where users contend for access to a common channel on a time-shared basis. See also FDMA and STDMA.
- STDMA** This is an acronym for **S**elective **T**ime **D**ivision **M**ultiple **A**ccess - A multiple access technique where users time-shared access to a common channel with selective sized time slots allocated on usage.
- TFTP** **T**rivial **F**ile **T**ransfer **P**rotocol – A simple file transfer protocol used over reliable transmission paths. See also FTP.
- TPI** **T**rans**P**arent **I**nterface - As a message arrives at its destination, the SDMS-II decodes the token and forwards the data to a port known as TPI
- Tx** **T**ransmit.

U

- UDP** **U**ser **D**atagram **P**rotocol – A standard for networking over reliable transmission paths.
- UDP Multicast** A multicast transmission using the UDP protocol.

V

- VESP** **V**ipersat **E**xternal **S**witching **P**rotocol is a switch-request protocol which allows both Vipersat and other manufactures to participate in a VMS controlled network
- VMS** **VIPERSAT** Management System
- VoIP** **V**oice **o**ver **I**P
- VOS** **V**ipersat **O**bject **S**ervice

W

Wizard A specialized program which performs a specific function, such as installing an application (installation wizard).

{ This Page Intentionally Blank }

Free Manuals Download Website

<http://myh66.com>

<http://usermanuals.us>

<http://www.somanuals.com>

<http://www.4manuals.cc>

<http://www.manual-lib.com>

<http://www.404manual.com>

<http://www.luxmanual.com>

<http://aubethermostatmanual.com>

Golf course search by state

<http://golfingnear.com>

Email search by domain

<http://emailbydomain.com>

Auto manuals search

<http://auto.somanuals.com>

TV manuals search

<http://tv.somanuals.com>