

azur

551R

 **Cambridge Audio**

Your music + our passion

Make sure you register your purchase.

Visit: www.cambridge-audio.com/sts

By registering, you'll be the first to know about:

- Future product releases
- Software upgrades
- News, events and exclusive offers plus competitions!

-This guide is designed to make installing and using this product as easy as possible. Information in this document has been carefully checked for accuracy at the time of printing; however, Cambridge Audio's policy is one of continuous improvement, therefore design and specifications are subject to change without prior notice.

This document contains proprietary information protected by copyright. All rights are reserved. No part of this manual may be reproduced by any mechanical, electronic or other means, in any form, without prior written permission of the manufacturer. All trademarks and registered trademarks are the property of their respective owners.

Incognito and Incognito Ready are trademarks of Cambridge Audio Ltd. All rights reserved.

© Copyright Cambridge Audio Ltd 2011

Manufactured under license from Dolby Laboratories. "Dolby" and the double-D symbol are trademarks of Dolby Laboratories.

Manufactured under license under U.S. Patent #'s: 5,451,942; 5,956,674; 5,974,380; 5,978,762; 6,226,616; 6,487,535; 7,212,872; 7,333,929; 7,392,195; 7,272,567 & other U.S. and worldwide patents issued & pending. DTS is a registered trademark and the DTS logos, Symbol, DTS-HD and DTS-HD Master Audio are trademarks of DTS, Inc. © 1996-2011 DTS, Inc. All Rights Reserved.

"HDMI", "HDMI logo" and "High-Definition Multimedia Interface" are trademarks or registered trademarks of HDMI Licensing LLC.

Contents

Introduction	3
Important safety instructions	4
Limited warranty.....	5
Front panel controls	6
Rear panel connections.....	7
Apple device compatibility	8
Remote control.....	8
Loudspeaker connections	9
Front panel display.....	9
Digital audio connections.....	10
Analogue audio connections.....	10
HDMI input connections.....	11
Analogue video input connections	11
Video output connection (HDMI)	12
5.1/7.1 Direct in.....	12
7.1 Preamp out	13
Aerial connections	13
FM aerial.....	13
AM loop aerial	13
Front input connections	13
551R setup.....	14
1. Speaker configuration	14
2. Speaker setup	15
Speaker delay	15
Level calibration	16
Auto speaker setup for Distance/Level	16
3. Assigning Video inputs.....	17
Scaler Assign/Processing	18
4. Source setup	18
Audio connection type.....	18
Surround sound modes.....	19
Operating instructions	20
Selecting the source	20
Using the Tuner.....	24
Lip sync	24
Using ARC.....	25
Audio split mode.....	25
Advanced setup	26
Sub crossovers and bass management	26
Bi-amping.....	26
Tone/Sub/LFE configuration	26
OSD setup	27
Advanced Dolby/DTS adjustments.....	27
Dynamic range control	27
DTS-HD speaker re-map	28
Reset/Back-up memory	29
Troubleshooting.....	30
Technical specifications	31

Introduction

Thank you for purchasing this 551R AV Receiver. We are confident that you will enjoy many years of listening pleasure from it. Like all Cambridge Audio products the 551R adheres to our three core principles – stunning performance, ease of use and incredible value.

As such, the seven 60W audiophile grade fully discrete amplifiers are kept as separate as possible from the processing and input stages and feature a large power supply with a low flux toroidal transformer. This careful design of the amplifier stages ensure that the 551R can reproduce the dynamics and scale required for modern movie soundtracks whilst also being able to reproduce a genuinely musical performance with either stereo or multichannel music sources.

A full range of HDMI, digital and analogue inputs are fitted. These allow the connection of suitably equipped Blu-ray players, DVD players, satellite/set-top boxes and games consoles for decoding into stereo, stereo + sub or various digital surround formats.

The latest formats are supported including Dolby True HD, Dolby Digital Plus, DTS-HD Master Audio and DTS-HD High Resolution Audio in 5.1 or 7.1 variants. In particular support for the true lossless Dolby True HD and DTS-HD Master Audio formats provides unprecedented audio fidelity from Blu-ray discs.

Various HDMI 1.4 features are supported including 3D TV and deep-colour pass-through from suitable sources and Audio Return from TVs with this feature.

The 551R is also capable of decoding encoded analogue or digital stereo sources in Dolby Pro Logic® II or IIx and DTS Neo:6, for a convincing and effective surround experience from a matrix encoded stereo source. Sophisticated post-processing of 5.1 digital material is also possible with PLIIx or DTS Neo:6 to turn these formats into 7.1.

Conventional analogue stereo inputs allow the connection of audiophile CD players and the like, and an Analogue Stereo Direct mode with no processing ensures the very best possible stereo reproduction for these.

The 551R also carries a 5.1 / 7.1 channel analogue input. This feature allows for the connection of a DVD-Audio or SACD player equipped with a 5.1 output and is compatible with any future external 7.1 audio formats.

As well as the full complement of audio inputs, the 551R performs Composite, S-Video, Component Video and HDMI switching with transcoding and scaling (up-converting) of all analogue video to HDMI.

An RS232 port and IR Emitter In also make it easy to integrate the 551R into a Custom Install situation.

All this proprietary engineering is housed within our low resonance, acoustically damped chassis. An Azur Navigator remote control is also provided, giving full remote control of your AV receiver in an attractive and easy to use handset.

Remember your 551R can only be as good as the system it is connected to. Please do not compromise on your source equipment, speaker package or video and audio cabling. Naturally we particularly recommend our Blu-ray players, digital and analogue iPod docks, Network and CD players from the Cambridge Audio Azur range, which have been designed to the same exacting standards as our receivers. Your dealer can also supply excellent quality Cambridge Audio interconnects to ensure your system realises its full potential.

Thanks for taking the time to read this manual, we do recommend you keep it for future reference.



Matthew Bramble
Cambridge Audio Technical Director
and the 551R design team

Before connecting

The process of setting up the 551R is first to make all the connections to your speakers and source equipment and then set the unit up via its On-Screen Display (OSD) as there are various settings and adjustments that need to be made before the 551R can be used.

However before you actually decide which connections to make or perform any adjustments it is strongly advised that you read through the '551R setup' section of this manual first, starting on page 14.

A lot of explanation is included that will help you to choose the right connection types for both your sources and TV.

Important safety instructions

For your own safety please read the following important safety instructions carefully before attempting to connect this unit to the mains power supply. They will also enable you to get the best performance from and prolong the life of the unit:

1. Read these instructions.
2. Keep these instructions.
3. Heed all warnings.
4. Follow all instructions.
5. Do not use this apparatus near water.
6. Clean only with a dry cloth.
7. Do not block any ventilation openings. Install in accordance with the manufacturer's instructions.
8. Do not install near any heat sources such as radiators, heat registers, stoves, or other apparatus (including amplifiers) that produce heat.
9. Do not defeat the safety purpose of the polarized or grounding-type plug. A polarized plug has two blades with one wider than the other. A grounding-type plug has two blades and a third grounding prong. The wide blade or the third prong are provided for your safety. If the provided plug does not fit into your outlet, consult an electrician for replacement of the obsolete outlet.
10. Protect the power cord from being walked on or pinched, particularly at plugs, convenience receptacles and the point where they exit from the apparatus.
11. Only use attachments/accessories specified by the manufacturer.
12. Use with only the cart, stand, tripod, bracket, or table specified by the manufacturer, or sold with the apparatus. When a cart is used, use caution when moving the cart/apparatus combination to avoid injury from tip-over. 
13. Unplug this apparatus during lightning storms or when unused for long periods of time.
14. Refer all servicing to qualified service personnel. Servicing is required when the apparatus has been damaged in any way, such as the power-supply cord or plug having been damaged, liquid has been spilled or objects have fallen into the apparatus, the apparatus has been exposed to rain or moisture, does not operate normally, or has been dropped.

WARNING

- To reduce the risk of fire or electric shock, do not expose this unit to rain or moisture.
- Batteries (battery pack or batteries installed) shall not be exposed to excessive heat such as sunshine, fire or the like.

The unit must be installed in a manner that makes disconnection of the mains plug from the mains socket outlet (or appliance connector from the rear of the unit) possible. Where the mains plug is used as the disconnect device, the disconnect device shall remain readily operable. Only use the mains cord supplied with this unit.

Please ensure there is ample ventilation (at least 10cm clearance all round). Do not put any objects on top of this unit. Do not situate it on a rug or other soft surface and do not obstruct any air inlets or outlet grilles. Do not cover the ventilation grilles with items such as newspapers, tablecloths, curtains, etc.

This unit must not be used near water or exposed to dripping or splashing water or other liquids. No objects filled with liquid, such as vases, shall be placed on the unit.



The lightning flash with the arrowhead symbol within an equilateral triangle is intended to alert the user to the presence of un-insulated 'dangerous voltage' within the product's enclosure that may be of sufficient magnitude to constitute a risk of electric shock to persons.

The exclamation point within an equilateral triangle is intended to alert the user to the presence of important operating and maintenance instructions in the service literature relevant to this appliance.



The symbol on this product indicates that it is of CLASS II (double insulated) construction.



WEEE symbol

The crossed-out wheeled bin is the European Union symbol for indicating separate collection for electrical and electronic equipment. This product contains electrical and electronic equipment which should be reused, recycled or recovered and should not be disposed of with unsorted regular waste. Please return the unit or contact the authorised dealer from whom you purchased this product for more information.



CE mark

This product complies with European Low Voltage (2006/95/EC), Electromagnetic Compatibility (2004/108/EC) and Environmentally-friendly design of Energy-related Products (2009/125/EC) Directives when used and installed according to this instruction manual. For continued compliance only Cambridge Audio accessories should be used with this product and servicing must be referred to qualified service personnel.



C-Tick mark

This product meets the Australian Communications Authority's Radio communications and EMC requirements.



Gost-R Mark

This product meets Russian electronic safety approvals.

FCC regulations

NOTE: THE MANUFACTURER IS NOT RESPONSIBLE FOR ANY RADIO OR TV INTERFERENCE CAUSED BY UNAUTHORIZED MODIFICATIONS TO THIS EQUIPMENT. SUCH MODIFICATIONS COULD VOID THE USER AUTHORITY TO OPERATE THE EQUIPMENT.



This equipment has been tested and found to comply with the limits for a Class B digital device, pursuant to Part 15 of the FCC Rules. These limits are designed to provide reasonable protection against harmful interference in a residential installation. This equipment generates, uses and can radiate radio frequency energy and, if not installed and used in accordance with the instructions, may cause harmful interference to radio communications. However, there is no guarantee that interference will not occur in a particular installation.

If this equipment does cause harmful interference to radio or television reception, which can be determined by turning the equipment off and on, the user is encouraged to try to correct the interference by one or more of the following measures:

- Re-orient or relocate the receiving antenna.
- Increase the separation between the equipment and receiver.
- Connect the equipment into an outlet on a circuit different from that to which the receiver is connected.
- Consult the dealer or an experienced radio/TV technician for help.

Ventilation

IMPORTANT – The unit will become hot when in use. Do not stack multiple units on top of each other. Do not place in an enclosed area such as a bookcase or in a cabinet without sufficient ventilation.

Ensure that small objects do not fall through any ventilation grille. If this happens, switch off immediately, disconnect from the mains supply and contact your dealer for advice.

Positioning

Choose the installation location carefully. Avoid placing it in direct sunlight or close to a source of heat. No naked flame sources, such as lighted candles, should be placed on the unit. Also avoid locations subject to vibration and excessive dust, cold or moisture. The unit can be used in a moderate climate.

This unit must be installed on a sturdy, level surface. Do not place in a sealed area such as a bookcase or in a cabinet. Any space open at the back (such as a dedicated equipment rack) is fine, however. Do not place the unit on an unstable surface or shelf. The unit may fall, causing serious injury to a child or adult as well as serious damage to the product. Do not place other equipment on top of the unit.

Due to stray magnetic fields, turntables or CRT TVs should not be located nearby due to possible interference.

Electronic audio components have a running in period of around a week (if used several hours per day). This will allow the new components to settle down and the sonic properties will improve over this time.

Power sources

The unit should be operated only from the type of power source indicated on the marking label. If you are not sure of the type of power-supply to your home, consult your product dealer or local power company.

This unit has been designed to be left in Standby mode when not in use as this will increase the life of the unit (this is true with all electronic equipment). To turn the unit off, switch off at the rear panel. If you do not intend to use this unit for a long period of time, unplug it from the mains socket.

Overloading

Do not overload wall outlets or extension cords as this can result in a risk of fire or electric shock. Overloaded AC outlets, extension cords, frayed power cords, damaged or cracked wire insulation and broken plugs are dangerous. They may result in a shock or fire hazard.

Be sure to insert each power cord securely. To prevent hum and noise, do not bundle the interconnect leads with the power cord or speaker leads.

Cleaning

To clean the unit, wipe its case with a dry, lint-free cloth. Do not use any cleaning fluids containing alcohol, ammonia or abrasives. Do not spray an aerosol at or near the unit.

Battery disposal

Batteries may contain substances harmful to the environment. Please dispose of any discharged batteries with due consideration and in accordance with local environmental/electronic recycling guidelines.

Loudspeakers

Before making any connections to loudspeakers, make sure all power is turned off and only use suitable interconnects.

Servicing

These units are not user serviceable. Never attempt to repair, disassemble or reconstruct the unit if there seems to be a problem. A serious electric shock could result if this precautionary measure is ignored. In the event of a problem or failure, please contact your dealer.

IMPORTANT

If the unit is run at a very high level, a sensor will detect a temperature rise and show "PROTECTION OVERLOAD" on the display. The unit will then go into Standby mode. It cannot be switched on again until the temperature has fallen to a more normal level.

Limited warranty

Cambridge Audio warrants this product to be free from defects in materials and workmanship (subject to the terms set forth below). Cambridge Audio will repair or replace (at Cambridge Audio's option) this product or any defective parts in this product. Warranty periods may vary from country to country. If in doubt consult your dealer and ensure that you retain proof of purchase.

To obtain warranty service, please contact the Cambridge Audio authorised dealer from which you purchased this product. If your dealer is not equipped to perform the repair of your Cambridge Audio product, it can be returned by your dealer to Cambridge Audio or an authorised Cambridge Audio service agent. You will need to ship this product in either its original packaging or packaging affording an equal degree of protection.

Proof of purchase in the form of a bill of sale or receipted invoice, which is evidence that this product is within the warranty period, must be presented to obtain warranty service.

This Warranty is invalid if (a) the factory-applied serial number has been altered or removed from this product or (b) this product was not purchased from a Cambridge Audio authorised dealer. You may call Cambridge Audio or your local country Cambridge Audio distributor to confirm that you have an unaltered serial number and/or you purchased from a Cambridge Audio authorised dealer.

This Warranty does not cover cosmetic damage or damage due to acts of God, accident, misuse, abuse, negligence, commercial use, or modification of, or to any part of, the product. This Warranty does not cover damage due to improper operation, maintenance or installation, or attempted repair by anyone other than Cambridge Audio or a Cambridge Audio dealer, or authorised service agent which is authorised to do Cambridge Audio warranty work. Any unauthorised repairs will void this Warranty. This Warranty does not cover products sold AS IS or WITH ALL FAULTS.

REPAIRS OR REPLACEMENTS AS PROVIDED UNDER THIS WARRANTY ARE THE EXCLUSIVE REMEDY OF THE CONSUMER. CAMBRIDGE AUDIO SHALL NOT BE LIABLE FOR ANY INCIDENTAL OR CONSEQUENTIAL DAMAGES FOR BREACH OF ANY EXPRESS OR IMPLIED WARRANTY IN THIS PRODUCT. EXCEPT TO THE EXTENT PROHIBITED BY LAW, THIS WARRANTY IS EXCLUSIVE AND IN LIEU OF ALL OTHER EXPRESS AND IMPLIED WARRANTIES WHATSOEVER INCLUDING, BUT NOT LIMITED TO, THE WARRANTY OF MERCHANTABILITY AND FITNESS FOR A PRACTICAL PURPOSE.

Some countries and US states do not allow the exclusion or limitation of incidental or consequential damages or implied warranties so the above exclusions may not apply to you. This Warranty gives you specific legal rights, and you may have other statutory rights, which vary from state to state or country to country.

For any service, in or out of warranty, please contact your dealer.

Plug Fitting Instructions (UK Only)

The cord supplied with this appliance is factory fitted with a UK mains plug fitted with a 5 amp fuse inside. If it is necessary to change the fuse, it is important that a 5 amp one is used. If the plug needs to be changed because it is not suitable for your socket, or becomes damaged, it should be cut off and an appropriate plug fitted following the wiring instructions below. The plug must then be disposed of safely, as insertion into a mains socket is likely to cause an electrical hazard. Should it be necessary to fit a 3-pin BS mains plug to the power cord the wires should be fitted as shown in this diagram. The colours of the wires in the mains lead of this appliance may not correspond with the coloured markings identifying the terminals in your plug. Connect them as follows:

The wire which is coloured BLUE must be connected to the terminal which is marked with the letter 'N' or coloured BLACK.

The wire which is coloured BROWN must be connected to the terminal which is marked with the letter 'L' or coloured RED.

The wire which is coloured GREEN/YELLOW must be connected to the terminal which is marked with the letter 'E' or coloured GREEN.

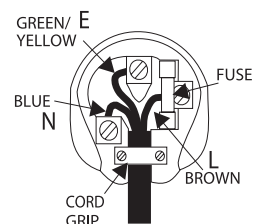

If your model does not have an earth wire, then disregard this instruction.

If a standard 13 amp (BS 1363) plug is used, a 5 amp fuse must be fitted, or if any other type of plug is used a 5 amp fuse must be fitted, either in the plug or adaptor, or on the distribution board.

Front panel controls

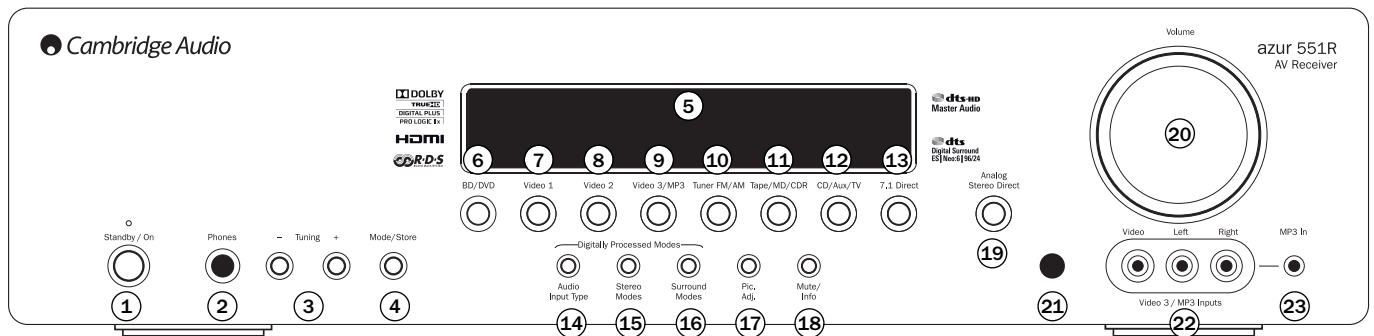

① Standby/On

Switches the unit between Standby mode (indicated by a dim power LED) and On (indicated by a bright power LED). Standby is an eco-friendly <1W low power mode. The unit may be left in Standby mode when not in use.

② Phones

Allows for the connection of stereo headphones with a 6.35mm/¼" Jack plug. Headphones with an impedance of between 32 and 600 ohms are recommended.

Note: Plugging in headphones will automatically mute the main and pre-amp outputs and select a 2-channel stereo down-mix to be created for headphone use.

③ Tuning +/-

Used to tune FM/AM frequencies and skip presets for the built-in Tuner.

④ Mode/Store

Press to cycle between Tuner modes. Press and hold for storing presets (refer to the 'Operating Instructions' of this manual for more information).

⑤ Display

Displays the status of the unit.

⑥ BD/DVD

Press to select the source equipment connected to the BD/DVD input.

⑦ Video 1

Press to select the source equipment connected to the Video 1 input.

⑧ Video 2

Press to select the source equipment connected to the Video 2 input.

⑨ Video 3/MP3

Press to select the source equipment connected to the Video 3 or MP3 input (if a device is plugged into its 3.5mm mini-jack input).

Note: The L audio input is also used for the supplied auto setup microphone. Refer to the 'Auto setup' section of this manual for more information.

⑩ Tuner FM/AM

Press to select the tuner. Once in Tuner mode press to switch between FM and AM modes.

⑪ Tape/MD/CDR

Press to select the source equipment connected to the Tape/MD/CDR input.

⑫ CD/Aux/TV

Press to select the source equipment connected to the CD/Aux input.

With ARC enabled (see later section), press again to select Audio Return Channel from a suitable TV.

⑬ 7.1 Direct

Press to select a 7.1 or 5.1 source (DVD-A or SACD player etc) connected to the 7.1 Direct In sockets.

Note: The 551R remembers the audio and video input type and processing mode for each individual source input. These are recalled each time a source is selected.

⑭ Audio input type

Press this button to select between analogue, digital (optical/coaxial) or HDMI input types as the source of the audio for the currently selected source input.

The choices available depend on the inputs that have been assigned to that source, see later section.

⑮ Stereo modes

Press to listen to a source in either digitally processed stereo or stereo and sub modes.

⑯ Surround modes

Press to select Dolby Digital or DTS surround modes (with suitably encoded digital source material), or various Pro Logic II/IIx, DTS Neo:6 modes for matrix encoded analogue or digital material.

⑰ Picture Adjustment

Press to select various picture adjustments for sources that have the Scaler set to **Process only** (see 'Source setup' section in the manual). An adjustment bar will appear on the TV for the current item (Brightness, Contrast etc.) Press the Pic. Adj. button again to move to the next item.

This button is also used to change the scaler output resolution. Press and hold the button for 10 seconds and the current output resolution will appear on the 551R's front panel display. Keep holding the button down and the 551R will change to the next available resolution and show it on the front panel display. See later section.

⑱ Mute/Info

Press to mute the sound from the main and pre-amp outputs of the 551R. Press again to cancel mute.

Note: Selecting a new source always cancels mute.

Press and hold to re-display the current decoding mode.

⑲ Analogue Stereo Direct

Press to listen directly to the analogue inputs for the current source directly with no analogue to digital conversion or DSP processing for highest possible stereo sound quality.

⑳ Volume

Use to increase/decrease the level of the sound from the outputs of the 551R.

㉑ Infrared sensor

Receives IR commands from the supplied remote control. A clear, unobstructed line of sight between the remote control and the sensor is required.

㉒ Video 3 Input

For occasional use with camcorders or games consoles etc.

㉓ MP3 Input

This input can be used with the line or headphone outputs of portable music players.

Rear panel connections

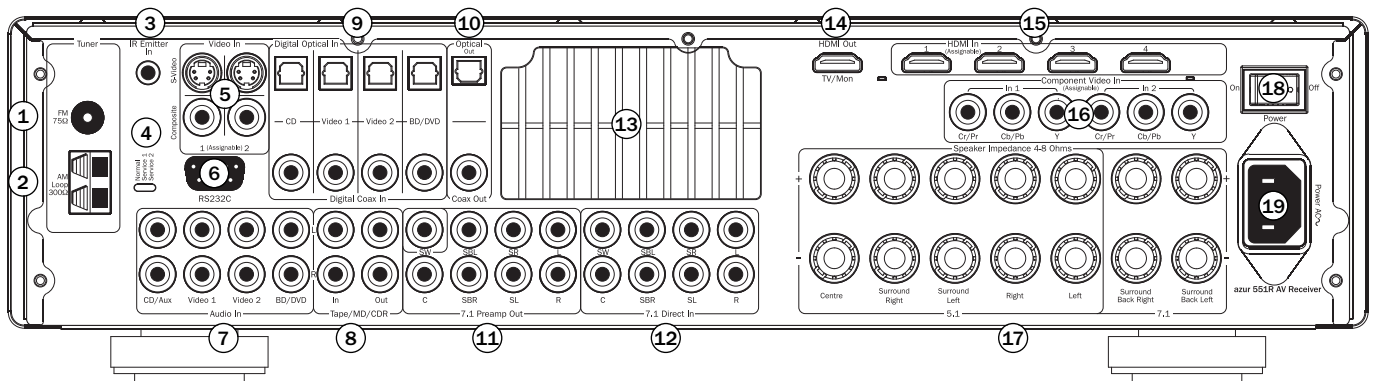

① & ② FM/AM antennas

All tuner antenna connections are made here. Refer to the 'Antenna Connections' section of this manual for more information.

③ Emitter In

Allows modulated IR commands from multi-room systems or IR repeater systems to be received by the 551R.

④ Service/Normal

For dealer use only - Switches the 551R between normal (default) mode and two Service modes. **Do not change the mode to service or make RS232C connections to it in service mode as damage may result!**

⑤ Composite and S-Video inputs

These may be freely assigned to any source, see later section.

⑥ RS232C

Used for control of the 551R in Custom Install situations. A full protocol is available for the 551R on our website.

⑦ Analogue Audio inputs

For use with the line level outputs of CD players, BD/DVD players etc.

⑧ Tape/MD/CDR In / Out

For use with suitable recording devices. The output allows recording of the currently selected analogue source.

⑨ Digital Inputs

S/P DIF or Toslink digital inputs for each source.

You can choose to use a different type for each source but do not connect both at the same time for the same source.

⑩ Digital Outputs

S/P DIF and Toslink digital outputs for recording. The outputs allow recording of the currently selected digital source.

These are concurrent and both can be connected at the same time.

⑪ 7.1 Preamp Out

Connect to the 5.1/7.1 channel input terminals of another amplifier system, separate power amps, subwoofer or active loudspeakers.

⑫ 7.1 Direct In

Connect to the output terminals of a DVD-A, SACD player or other 5.1/7.1 analogue source.

⑬ Heat tunnel vent grille

Allows cooling of internal circuitry via the 551R's proprietary X-TRACT heat tunnel. **DO NOT OBSTRUCT!**

⑭ & ⑮ HDMI

Inputs and output to a suitable TV/Monitor. The HDMI inputs can be assigned in the OSD. By Default the HDMI inputs are assigned to BD/DVD, Video 1 and Video 2, with the 4th input unassigned.

These inputs can be freely assigned, see later section on assigning video inputs.

All video inputs whether analogue or HDMI are transcoded and output via the HDMI output.

⑯ Component Video inputs

By default the component inputs are unassigned, these inputs can be freely assigned, see later section on assigning video inputs.

Note: The preferred connection method for video inputs is always Composite Video, then S-Video, then Component Video, then HDMI in ascending order of quality (HDMI being the highest quality). HDMI and Component Video sources often also support Progressive Scan which gives better picture quality if supported by both your BD/DVD player and TV.

⑰ Speaker terminals

Connect to loudspeakers with an impedance of between 4-8 ohms. 7.1, 5.1 or less connections can be made.

⑱ Power On/Off

Switches the unit on and off.

⑲ Mains power lead

Once you have completed all connections, plug the AC power lead into an appropriate mains socket. The AV receiver is now ready for use.

Remote control

The 551R is supplied with an Azur Navigator remote control. Insert the supplied AAA batteries to use. For full details of the various adjustment functions available from the remote, refer to the later sections of this manual.

Standby/On

Switches the unit between Standby mode and On.

Analogue Direct

Directly selects a stereo analogue input for the current source with no A/D conversion or DSP processing.

Stereo Modes

Selects Stereo or Stereo + Sub modes for Analogue or Digital sources (digitally processed).

Surround Modes

Selects digital surround processing modes and various matrix encoded surround processing modes for analogue or digital sources (digitally processed).

Info

Press to view the current source material and decoding mode. Press again whilst the current decoding mode is scrolling (as long as mute is not on) to display the incoming sample rate. When listening to FM with RDS, press to cycle round various RDS information modes.

Stereo Mono

When listening to FM, press to alternate between stereo and mono modes.

Store

Press to store the current frequency when in Tuner mode.

Mode

Press to select Auto/Manual or Preset tuning when in Tuner mode.

Mute

Mutes the audio on the AV Receiver. Press again to cancel mute.

Volume

Increase or decrease the volume of the AV receiver output. Also used as up/down in the OSD setup menus.

Tune / Left & Right

Press the right arrow to increase tuner frequency/change preset. Press the left arrow to decrease tuner frequency/change preset. Also used to scroll left/right in the OSD setup menus.

Enter

Used in the OSD setup menus.

On-Screen Display (OSD)

Press to turn on and off the on-screen setup menus for display on your monitor/screen.

Bass/Treble

Press for bass/treble adjustment, using the Volume up/down buttons. **Note:** Bass/Treble is bypassed in analogue stereo direct and 7.1 direct modes.

Audio In Type

Switches the audio between the types available for the current source. Depending on the source selected and whether you have assigned an HDMI input to it, Analogue, Digital and HDMI can be available.

7.1 Direct

Selects the 5.1/7.1 direct input.

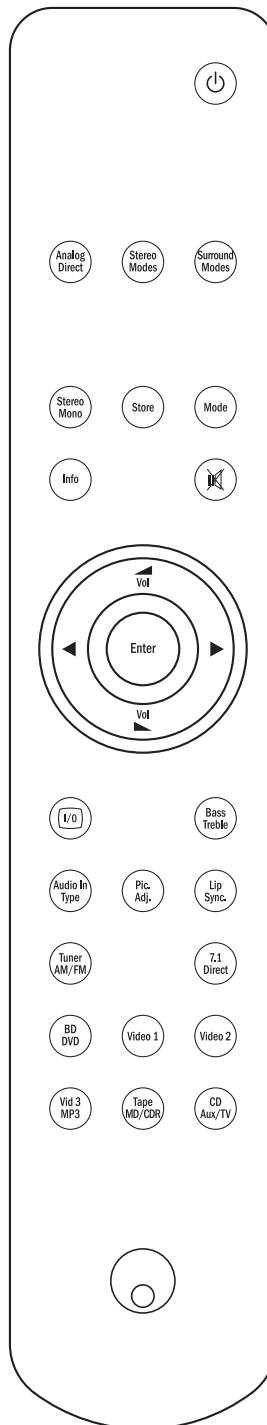

Picture Adjustment

Press to select various picture adjustments for sources that have the Scaler set to Process only.

An adjustment bar will appear on the TV for the current item (Brightness, Contracts etc.) Press the Pic. Adj. button again to move to the next item.

Lip sync

Press to activate and adjust the lip sync delay function if the audio and video appear out of sync. While the Lip sync delay status is shown on the units display, use the Vol \blacktriangleleft and Vol \blacktriangleright buttons to adjust the delay time. Adjusting the value to zero causes lip sync delay to be turned off. See later section in this manual.

Tuner AM/FM, BD/DVD, Video 1, Video 2, Vid 3/MP3, Tape/MD/CDR, CD/Aux/TV

Press the corresponding button to change the input source. Pressing the Tuner AM/FM button a second time toggles between AM and FM modes.

Pressing the CD/Aux/TV button a second time if ARC is enable (see later section) selects TV-ARC (Audio Return Channel).

The above button descriptions are naturally brief. Please refer to the 'Operating Instructions' section of this manual for more information on the relevant functions implemented.

Apple device compatibility

The Azur 551R Navigator remote control can control the basic functions of Apple devices such as Apple TV and Apple's iPod/iPhone/iPad range when docked in a Cambridge Audio or Apple dock.

Press and hold the source button that corresponds to the input that the Apple product is connected to whilst also pressing one of the buttons below.

The functions are slightly different depending on the Apple product.

 Enter

 Menu

 Play/Pause

 Used to control volume and/or navigate menus.

 Used to navigate menus or Skip/Scan depending on Apple product used.

In addition, the Azur remote can be paired with up to six specific Apple devices using any of the six source buttons. This can be useful if you have more than one Apple product.

For more information on pairing refer to your Apple device's instruction manual.

Pairing – To pair with an Apple device, press and hold the required source button along with the \blacktriangleright button for six seconds. Some devices like Apple TV have visual indication once pairing is achieved.

Un-pairing – To un-pair an Apple device, press and hold any of the source buttons along with the \blacktriangleleft button for six seconds.

Front panel display

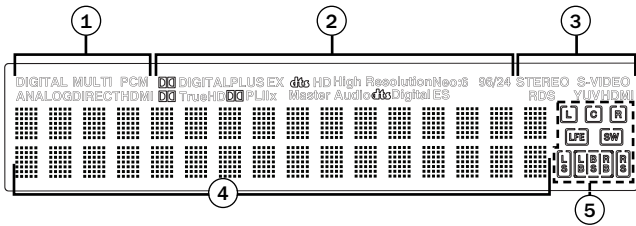

1 Mode icons

Direct indicator

Lights when the 551R is in a Direct mode - Analogue Stereo Direct or 7.1 Direct.

HDMI

Indicates the current source audio input type is HDMI.

Multi

Indicates the 551R is receiving multi-channel PCM over HDMI.

Digital/Analogue indicators

Indicates whether the current source audio input type is Digital (S/P DIF/Toslink) or Analogue.

2 Decoding mode indicators (PCM, Dolby Digital, DTS etc)

Shows the current decoding mode, Dolby Digital, DTS etc. In conjunction with the Output Channel indicators these give full details of the current processing mode.

3 Video input icons

Indicates the current video input type as Video (composite), S-Video, YUV (Component) or HDMI.

4 Main information display

Shows the current source selected, also the surround mode and station name/frequency when in tuner mode etc.

5 Output channel indicators

Shows the currently active channels depending on decoding mode and source material. Icons lit indicate active channels in the source material. Icons with a box around them indicate actual channels being output by the 551R.

Display examples



Indicates a 5.1 Dolby Digital source being played back as 5.0 (Sub off). The lit LFE indicates a low frequency effects channel is present in the source material. When this icon isn't boxed it indicates the LFE channel is not being sent to a subwoofer but will be mixed into the front left and right instead.

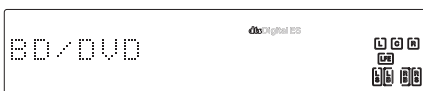

Indicates a 7.1 playback of DTS ES material.



Indicates a 2.1 output created in the digital domain from analogue input material.

Loudspeaker connections

To avoid damaging the speakers with a sudden high-level signal, be sure to switch the power off before connecting the speakers. Check the impedance of your speakers. Speakers with an impedance of between 4 and 8 ohms (each) are recommended.

The coloured speaker terminals are positive (+) and the black speaker terminals are negative (-). Make sure correct polarity is maintained at each speaker connector or the sound can become weak and "phasy" with little bass.

Prepare the speaker cords for connection by stripping off approximately 10mm (3/8") or less (no more than 10mm, as this could cause a short-circuit) of the outer insulation. Twist the wire tightly together so there are no loose ends. Unscrew the speaker terminal knob, insert the speaker cable, tighten the knob and secure the cable.

Note: All connections are made via loudspeaker cable, except if using an active subwoofer which would be connected via a standard RCA phono cable.



Banana Plugs (4mm standard) connected to the speaker cable are recommended for direct insertion into the speaker terminals.

Please refer to the 'Speaker Configuration' section of this manual for more information on 5.1 and 7.1 speaker setups.

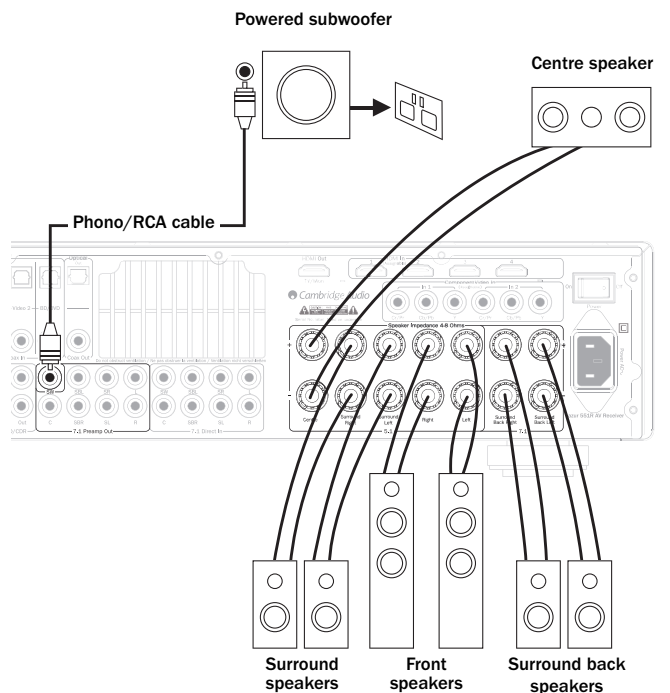

Analogue audio connections

Note: Do not plug in the mains power lead or turn the unit on until all connections have been made.

Connect to source equipment using stereo phono cables (stereo 2RCA-2RCA). Tape/MD/CD-R recorder/players require two sets of stereo phono/RCA cables, one for recording, one for listening.

Examples

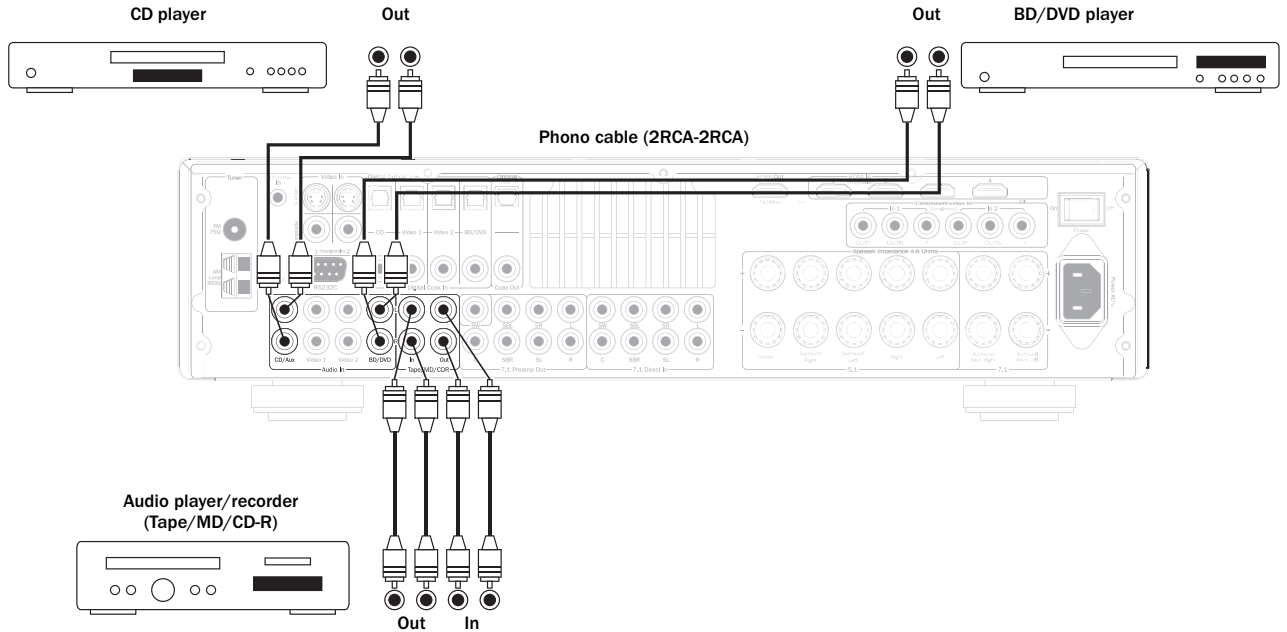

Digital audio connections

Two types of digital audio connections can be made to the 551R:

1. Optical (Toslink)
2. Coaxial (S/P DIF)

Either type can be used for a source as the 551R automatically uses the active one.

Note: Only one connection type should be used per source.

Examples

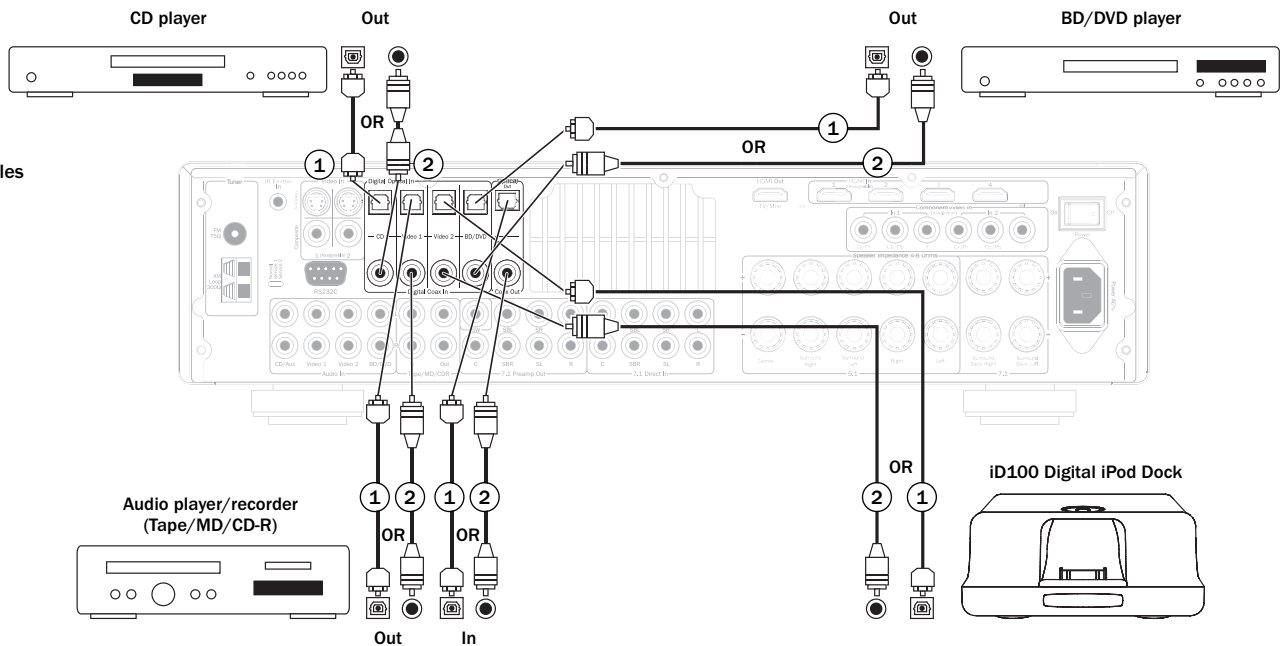

A recording device such as MD or CD-R can be connected to the digital outputs as shown.

HDMI input connections

HDMI (High-Definition Multi-Media Interface) is an all digital connection that can carry both audio and video in one cable. Direct digital transfer of audio and video and support for various types of High Definition video content and high resolution audio make this the best connection type to use. The 4 HDMI inputs can be assigned to the BD/DVD, Video 1, Video 2, CD/Aux/TV, Tape/MD/CD/R or 7.1 Direct sources (see the "Assigning HDMI sources" section for more information).

DVI switching can be supported by using DVI to HDMI adaptors as these two connection types are compatible. When using DVI only video will be passed to the TV/Monitor and a Co-axial (S/P DIF) or Optical (Toslink) digital audio connection must be made from each source to the 551R for it to be able to receive audio and decode surround sound etc.

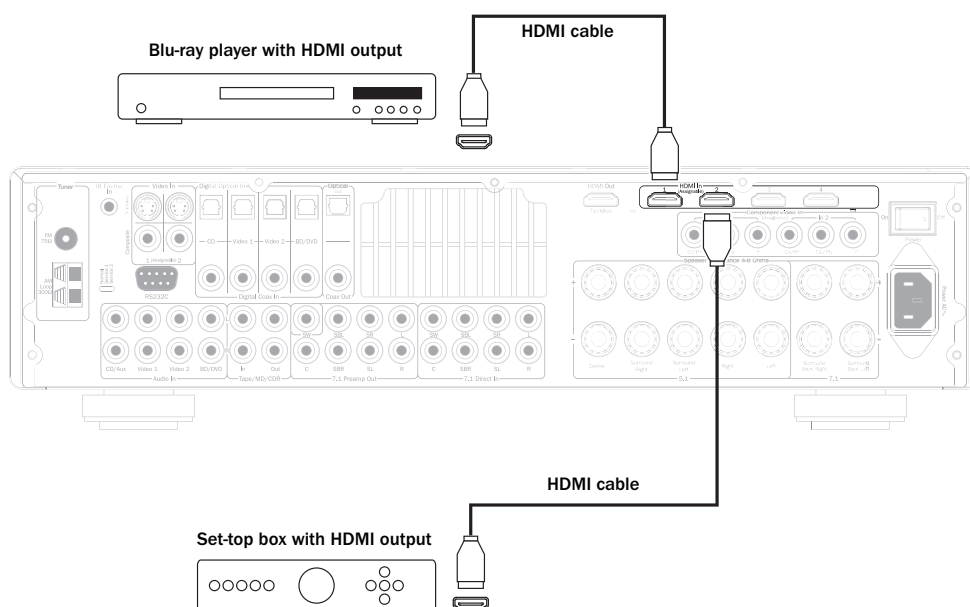

Examples

Analogue video input connections

Three types of analogue video connections can be made to the 551R:

1. Composite - connect with single 75 ohm video phono cable (RCA-RCA).
2. S-Video - connect with S-Video cable.
3. Component - connect with 75 ohm Component video cables (3RCA-3RCA)

For sources that support HDMI this is always the best choice.

For sources that only support analogue video for best picture quality we recommend making Component video connections, then in declining order of quality, S-Video connections and then Composite video connections.

The 551R is able to transcode i.e. upconvert analogue video to HDMI for the main monitor/TV output.

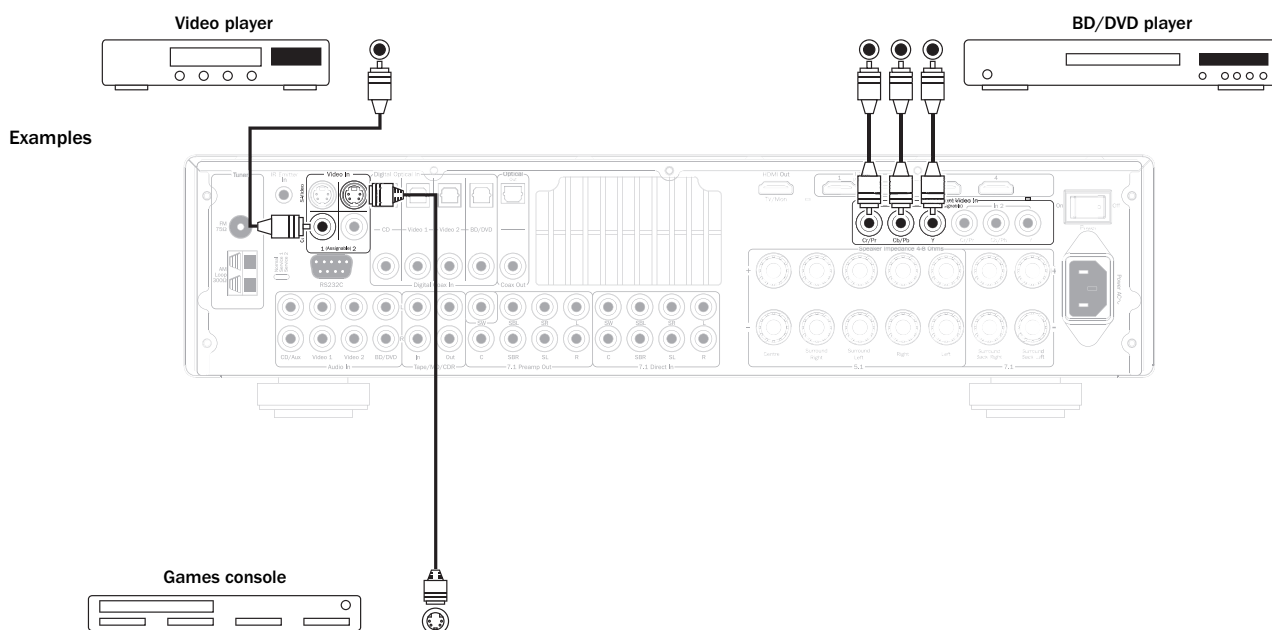

Examples

Video output connection (HDMI)

Connection to the TV is by HDMI. The 551R converts incoming analogue video to HDMI and scales it for best picture quality. See later section.

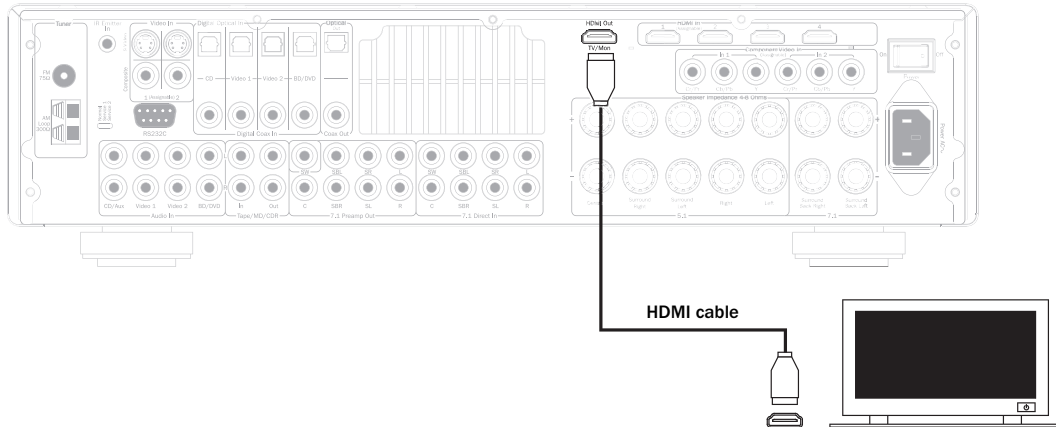

5.1/7.1 Direct in

DVD-A or SACD players can be connected to the 551R via its 5.1/7.1 Direct inputs allowing multi-channel music playback from these sources.

DVD-A and SACD both support 5.1 output. The 551R's direct inputs also allow optional connection of Surround Back or Surround Left and Surround Right signals for compatibility with future 7.1 sources or external decoders.

To select the Direct Input press the *7.1 Direct* button on the front panel or remote.

It can be desirable to connect DVD-A/SACD players to the 551R by two methods at the same time.

A Digital or HDMI input can be made to the 551R for surround sound decoding and an analogue 5.1 connection to 7.1 Direct for DVD-A/SACD playback.

If the player is selected via the BD/DVD button you can then view its content and decode any relevant surround sound soundtracks.

If 7.1 Direct is then pressed, the audio is now switched to come from the players analogue outputs.

These connections are pure analogue for best sound quality and no DSP processing or Bass and Treble adjustment by the 551R is possible.

DVD-A player or SACD multi-channel player 5.1 connections

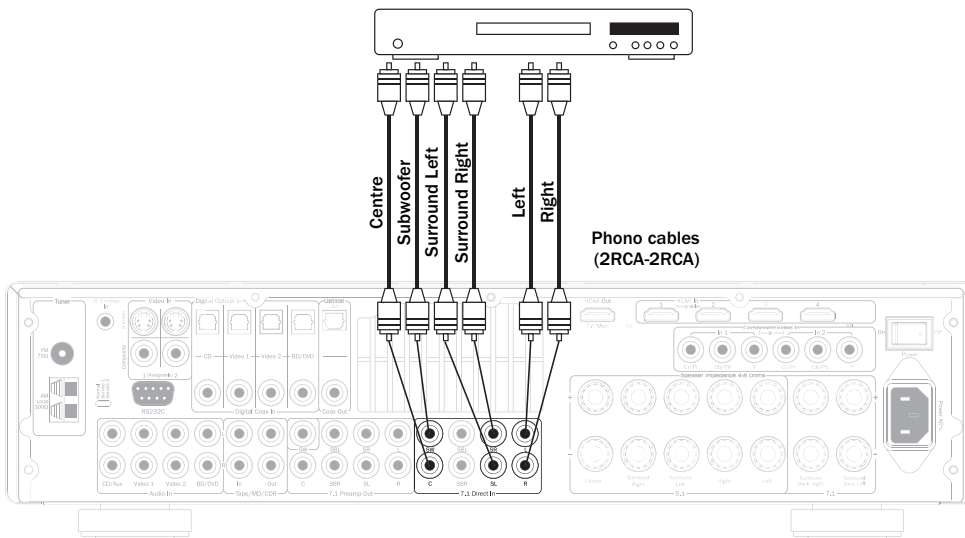

7.1 Preamp out

If it is desired to connect external power amplifiers, use Phono/RCA leads connected to the 7.1 Preamp Outputs on the rear panel.

For 5.1/7.1 use set the 'Preamp Out' setting in the 'Output Setup' OSD menu to 'Pre Out' rather than 'Normal'. This mutes all the internal power amplifiers as they are not being used.

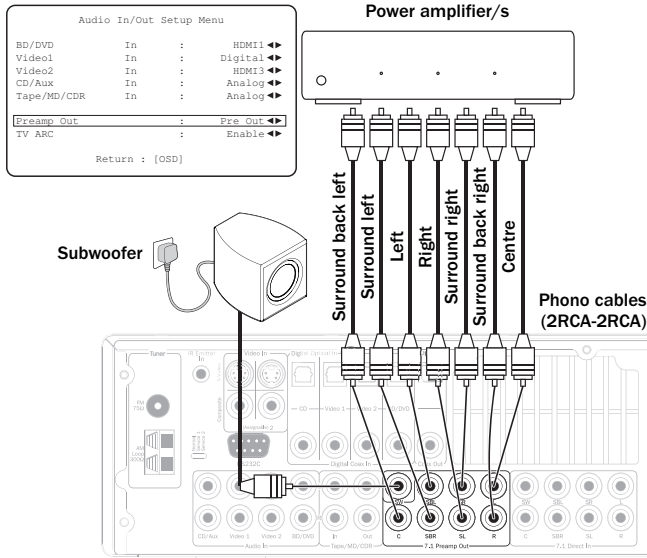

Alternatively the 551R features an External 2-Channel mode. This allows the 551R to reproduce all the surround channels of suitable source material (Centre, Surrounds and Sub) whilst the Left and Right Front speakers are driven by an external power amplifier or other amplifier capable of supporting fixed level inputs (e.g. Cambridge Audio's own 7/8 series amplifiers).

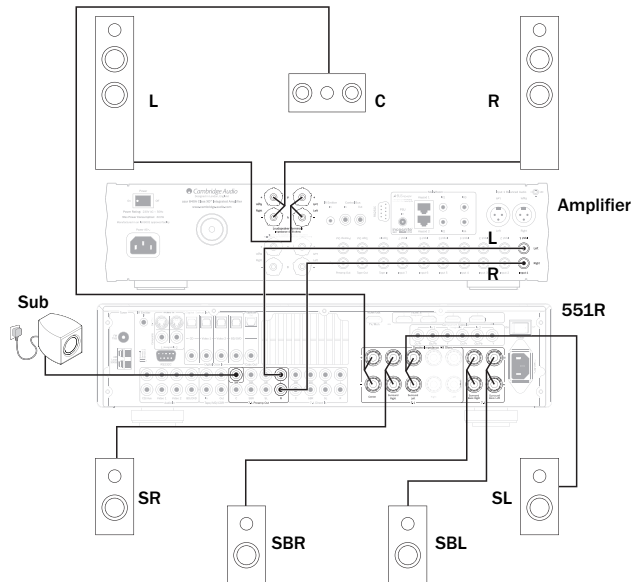

Set the 'Preamp Out' to 'Ext 2 Ch' in the OSD to mute the 551R's own front left and right amplifier outputs only:

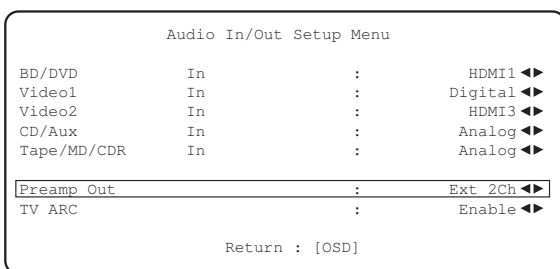

Front input connections

The front panel Video 3/MP3 input is for temporary connections to video games consoles etc. Remove the cap to access the Video 3 inputs and connect to a video game console or video camera's outputs using stereo phono cables (RCA-RCA) and a Composite video cable. Alternatively, use the 3.5mm mini-jack MP3 socket for the headphone/line outputs of portable MP3 players.

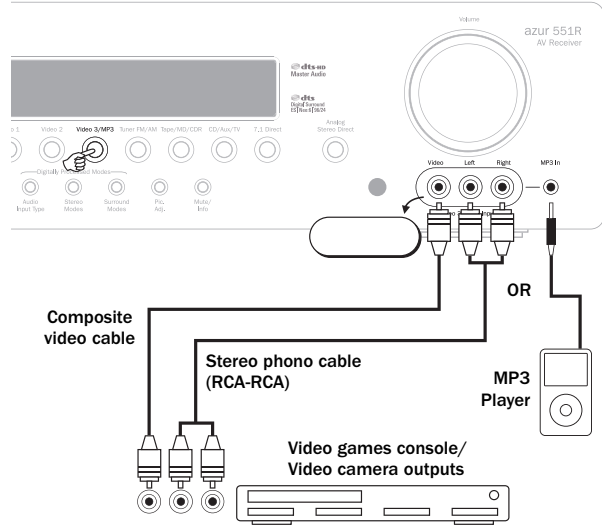

When pressing Video 3/MP3, the 551R automatically selects the MP3 socket if there is a device plugged into it.

Note: The Left front input is also used for the supplied auto setup microphone. Refer to the 'Auto setup' section of this manual for more information.

Aerial connections

FM aerial

Connect an aerial to the FM 75 ohm socket (a simple wire aerial is supplied only for temporary use). Extend the lead and move the aerial around until you get the best reception. For continued use, we strongly recommended using a 75ohm outdoor FM aerial.

AM loop aerial

Connect each end of the single length antenna to the antenna terminals. Place the antenna as far from the main system as possible to prevent unwanted noise and to obtain optimum reception. If the AM loop aerial provided does not receive sufficient reception, it may be necessary to use an outdoor AM aerial.

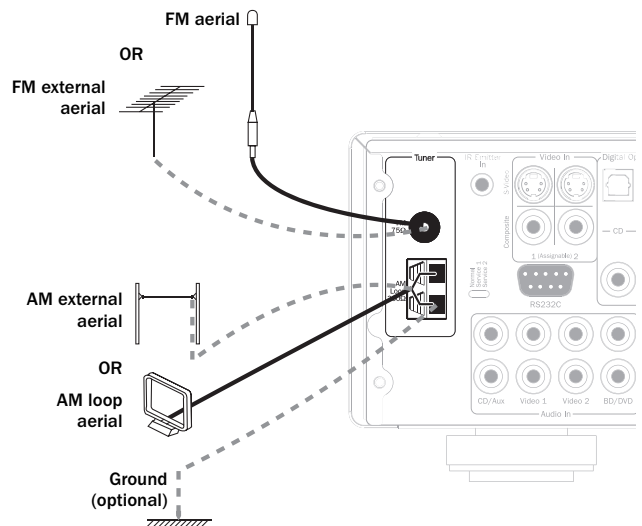

551R setup

The setup of the 551R is a reasonably simple 4 stage process. The speaker setup process (stage 2.) can either be performed manually or via the CAMCAS (Cambridge Audio Microphone Controlled Auto Setup) procedure.

The procedure is as follows:

1. Speaker configuration.
2. Speaker setup (Speaker delay and Level calibration)
3. Assigning HDMI and Analogue video inputs
4. Source setup

1. Speaker configuration

First tell the unit what kind of speaker package you have. The options are 5.1 or 7.1 as shown below. The 551R can support up to a 7.1 speaker setup which means 7 speakers (Front Left, Front Right, Centre, Surround Left, Surround Right, Surround Back Left, Back Right) plus a mains powered Subwoofer (the .1).

Refer to the diagrams below for typical examples of 5.1 and 7.1 loudspeaker setups. Always adjust the speaker and listening positions until you are happy with the sound. Please refer to your loudspeaker and subwoofer manuals for more detailed positioning information.

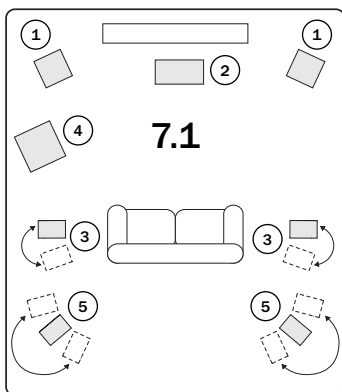
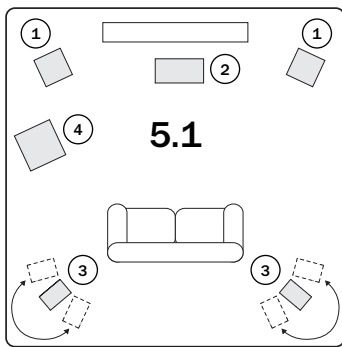

① Front Left and Right speakers

For stereo and multi-channel sound.

② Centre speaker

For dialogue and centre sounds. Ideally position at a similar height to the front left and right speakers (above or below the TV/monitor). Using a centre speaker from the same manufacturer/range as used for the front left and right speakers is advisable. This “timbre matching” allows surround effects to flow more naturally from left to right without obvious transitions between the speakers.

③ Surround Left and Right speakers

For ambient and multi-channel sound. Floorstanding speakers should be angled towards the listening position. Bookshelf/standmount speakers should be wall mounted or used with dedicated speaker stands, positioned at or above ear height.

④ Subwoofer

For improving the bass in your system, as well as reproducing dedicated LFE (Low Frequency Effects) cinema effects when playing Dolby Digital or DTS encoded discs. Your subwoofer can often be placed almost anywhere in the room as bass is less directional, but experimentation with positioning is recommended.

⑤ Surround Back Left and Right speakers

Individual back speakers in place of a single surround back. Used with the 7.1 processing types. Remember to experiment with the positions until you are happy with the sound.

In each case the 5.1/7.1 in fact relates to the maximum number of speakers that can be used, as the Centre, Sub and Surround speakers can all be deleted if required (although of course performance is reduced). For example, if you choose not to use a Centre Channel speaker you can set this to 'None' in the settings as shown later and the 551R will automatically redirect the centre channel audio information into the Left and Right Front channels, creating what is known as a 'Phantom Centre'.

Similarly, you might decide not to use a subwoofer if your main Left and Right speakers are capable of reproducing enough bass for a satisfying music/movie experience. The 551R will then automatically re-direct the bass from the Subwoofer/Low Frequency Effect channel to the Left and Right Front Speakers.

Note: This setup is very important as the 551R will also automatically use this information to select appropriate Dolby and DTS decoding modes dependant not only on the source material but also the speaker package it knows you have.

To tell the unit the type of package you have, turn on the On-Screen Display via the remote button as shown. Highlight the 'Speaker Configuration' menu by using volume up and down on the remote then go to it by pressing *Enter*:

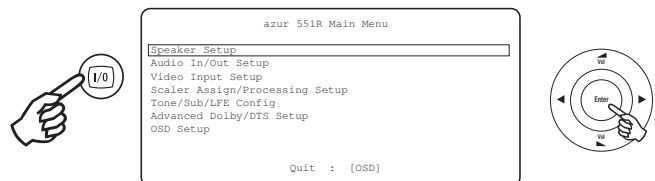

Set the Decode mode as 5.1 or 7.1 by highlighting the Decode Mode item and using the *Left* and *Right* arrows to scroll through the options:

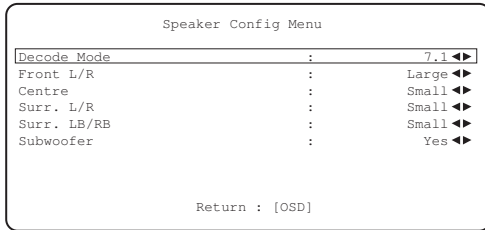

Now move down and by highlighting each speaker in turn and using the *Left* and *Right* arrows select from 'Large', 'Small' or 'None' for each speaker. 'Large' or 'Small' are used to describe each speaker in terms of bass response, they do not necessarily reflect the actual physical size of the speaker.

Large = Speakers with an extended low frequency response of approximately 20-40Hz to 16-20kHz (floorstanders or high quality larger stand-mounted speakers).

Small = Speakers with a less extended low frequency response of approximately 80-100Hz to 16-20kHz (small stand-mounted, bookshelf or satellite speakers).

Setting each speaker allows the 551R to perform what is called Bass Management and to direct low frequency bass from music and the Low Frequency Effects channel of surround sound material to those speakers best able to reproduce it. If you do not wish to use any of the speakers set its setting to 'None'.

The Subwoofer output can also be set to Yes or No. If no sub is being used make sure this setting is set to No to allow the 551R to re-direct the bass information in this channel to other speakers.

Note: The 551R will force some speakers to certain settings in the following circumstances!

The Front Left and Right speakers may be 'Large' or 'Small' but never 'None' as they are always required for any type of music/movie reproduction.

Bass must always be reproduced by either the Front Left and Right or Subwoofer channel (or both). Setting the Front Left and Right to 'Small' will result in the Subwoofer automatically being set to 'Yes'. Setting the Subwoofer to 'No' will automatically result in the Front Left and Right being set to 'Large'.

If the Front Left and Right cannot reproduce low frequency bass a Subwoofer must be used. I.e. if the Front Left and Right are set as 'Small' the Sub must be Set to 'Yes'.

Also, setting the Front Left and Right as 'Small' will always set the other speakers as 'Small' (and the Sub to 'Yes'). This is because LFE/ bass information should not be redirected to the surround channels.

To store the setting simply come back out of the OSD (pressing the OSD button always moves back one menu item, and then exits and stores from the main menu screen).

2. Speaker setup

The following two sections can be performed by Cambridge Audio CAMCAS procedure so you can if you wish jump straight to that section. However, it is recommended that you do read these sections to understand the reasons for these settings and their implications.

Speaker delay

Because the speakers in a surround sound system are usually different distances from the listener the 551R incorporates the ability to apply a variable digital delay to each of the channels so that the sound from each arrives at the same time at the listening position for best surround-sound effect.

To set the delay times automatically, refer to the Auto setup section of this manual.

To set the delay times manually, simply measure the distances from the listening position to each speaker as shown in the following diagram:

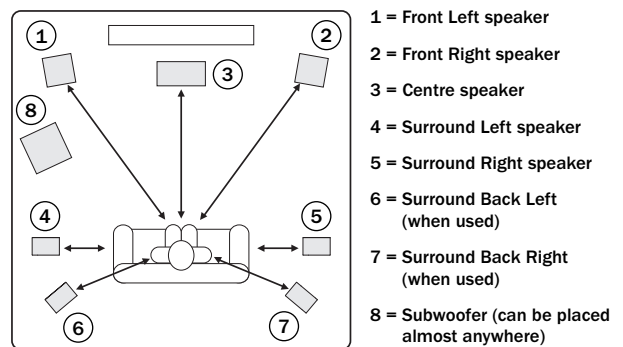

Note: No delay setting for the subwoofer is necessary.

Set the distances in the OSD Speaker Distance menu to the nearest value in metres (1 foot = 0.3 metres). The speed of sound is approx 340 metres per second, the 551R thus introduces approx 3ms of delay per metre of distance set.

Go to the 'Speaker Distance' and highlight each speaker in turn. Set the distance to the nearest value to that which you measured by using the *Left* and *Right* arrows (the values do not need to be exact):

Press the OSD button to exit the menu.

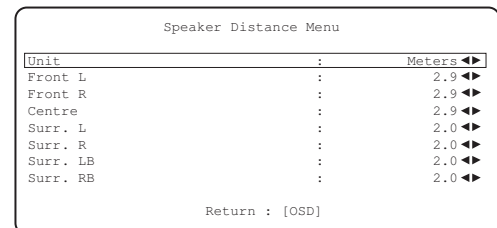

Note: In addition to the delays as set above Dolby Pro Logic II playback also requires an extra 15 milliseconds delay to the surround channels only. This extra delay is part of the Dolby ProLogic II specification and ensures that sound from the surrounds arrives just after sound from the front reducing the audibility of sound leakage from the front to the surround speakers. Because the relationship between the Dolby Digital and Dolby ProLogic II two delays is fixed (15mS extra to the surround channels), it is only necessary to set the delay by measuring the distances as we have described. The 551R will automatically provide the appropriate extra delay whenever you switch to a Pro Logic Mode.

Level calibration

The 551R allows level calibration to match the acoustic level between different types/sizes or even manufacturers of speaker that may be being used for each channel. This is achieved by adjusting the relative level of each speaker. This can be done manually through the 'Level Calibration' menu in the OSD or automatically, see the following Auto setup section of this manual.

The basic process for manual adjustment is to listen to or measure with a Sound Pressure Level (SPL) meter (more accurate and recommended but not essential) the level of sound produced by each speaker and set relative levels for each speaker so that they all sound the same loudness at the normal listening position. The 551R incorporates a Test Signal Generator (broad-band white noise) to facilitate this.

Press the OSD button on the remote control then select the 'Level Calibration' menu. Now turn on the test signal by highlighting this item and pressing the *Left* or *Right* arrows:

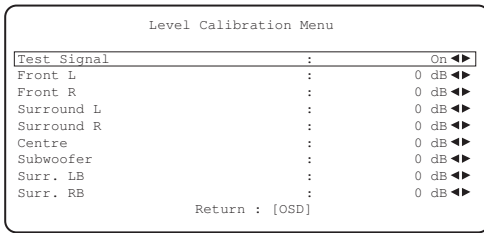

You can now move up and down the channels using *Volume Up/Down* on the remote. Each time a new channel is selected the test signal will be heard to move to that channel. Compare the loudness of all channels as heard at the listening position.

A "rushing" or "hissy" sound should be heard.

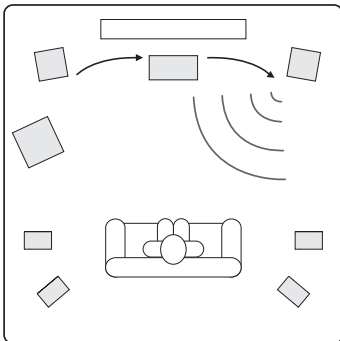

Now adjust the channels so they all sound the same (in terms of loudness only, channels of different frequency responses can sound different in terms of the "tone" of the sound i.e. more or less hissy).

Pick the channel that sounds most different and select it to listen to the test signal. Now adjust the relative level in dB (using Arrow left/right on the remote) and continue comparing it to other channels until it is of equal loudness. The level can be adjusted up to + or - 10dB in 1dB steps. Repeat the process with the next most different channel. Once all channels sound the same in terms of loudness, press the OSD button again to save the settings and exit the menu.

Auto speaker setup for Distance/Level

The 551R includes our simple automatic speaker setup system called 'CAMCAS' (Cambridge Audio Mic Controlled Auto Setup). The system performs two sets of tests firstly checking which speakers are connected and whether they are wired correctly and in phase then second automatically measuring and adjusting the speaker delay timings (i.e. distance setting) and levels.

Before activating this feature the 'Decode Mode' (i.e. type of speaker package e.g. 5.1, 7.1) of the 551R and Large/Small/None status of each speaker must be set correctly as per section 1. This is important as the unit will only look for and check the speakers you have told it you have.

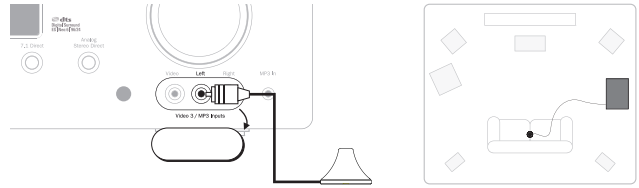

To perform Auto Distance/Level setup first connect the supplied microphone to the front Left front panel audio input on the front panel and place it at your normal listening position in the room.

Press the OSD button on the remote control to access the OSD and then select the Speaker Setup Menu. Now select the option 'Auto Setup'. This will access the 'Auto Setup Menu' as below.

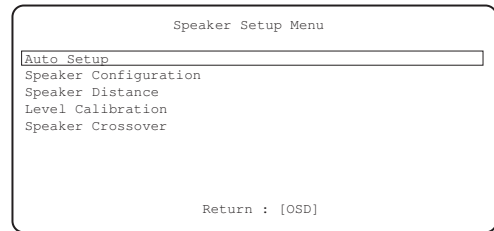

Follow the on-screen instructions and press 'Enter' on the remote control when ready to start the Auto Setup function.

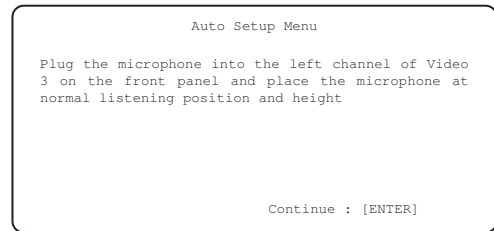

Once activated the OSD will display the message below and the word 'AUTOSUP' will also be displayed on the front panel of the 551R to confirm.

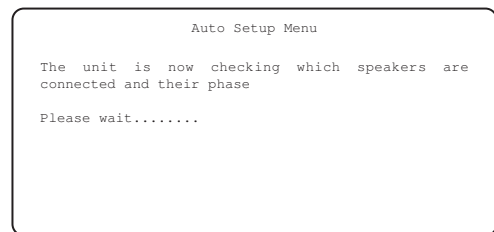

A series of test signals will now be output from all of the connected speaker terminals of the 551R (including the Subwoofer output).

Once finished the unit will display a screen similar to the one below reporting which speakers were found and any that appear out of phase.

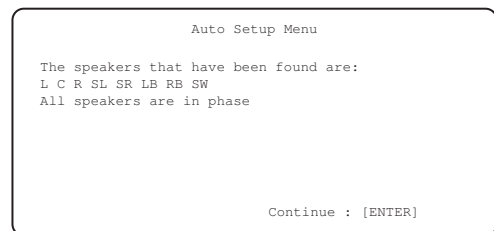

If any speakers appear unconnected or out of phase carefully check the connections on the speaker and the back of the unit. Also check any bi-wiring links that might be present on the speaker. For any out of phase speakers check that the relevant + terminal of the 551R goes to the + terminal of that speaker and similarly the - terminal of the 551R goes to the - terminal of the speaker for that channel.

If necessary press the OSD button to perform a retest or press Enter to start the second part of the autsetup procedure as below.

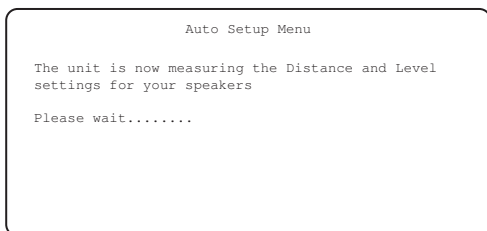

Again a series of test signals will now be output from all of the connected speaker terminals and Subwoofer. The 551R uses these to measure the levels and distances (and hence introduce the correct delays) appropriate to your speakers and room characteristics.

When the auto setup of the 551R is completed successfully, the 551R will return to the Speaker Setup Menu.

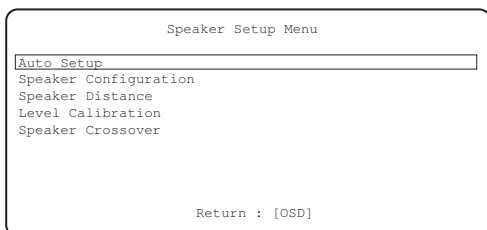

The Speaker Distance and Level Calibration settings for each speaker will have been updated.

It is of course now possible to go into the Speaker Delay and Level Calibration menus if you want to manually check/adjust the settings made by the CAMCAS system, and it is always advisable to check them as no system can be totally foolproof.

To exit the auto setup menu of the 551R continue to press the OSD button on the remote control to exit all menus or until 'OSD' is no longer displayed on the front panel. You can now unplug the microphone and put it away for future use.

Note: If the auto setup of the 551R is unsuccessful for some reason a 'Fail' message will appear on the OSD. Included in this message will be details of the speaker channel or channels which have not been successfully adjusted. If this is the case, please again check that the speaker or speakers detailed in the OSD as 'failed' are connected correctly & have not been wired out of phase. Also check the microphone connection and any other external issues that could have affected the tests such as noise in the room etc.

Note: Like all such systems CAMCAS has some limitations. Speakers that exhibit very strong phase angles or deliberately wire some drive units out of phase can of course appear to the system as an out of phase speaker when correctly connected. If a speaker is reported as out of phase but is correctly wired please consult the speakers manufacturer in case this is the case.

Similarly bi-polar speakers which radiate in more than one direction can make it difficult to measure the distance and sometimes level accurately as you might expect.

In all cases it is always advisable to manually check the settings CAMCAS has made for a 'reality check' to ensure there are no obvious errors.

3. Assigning Video inputs

The 551R has 4 HDMI (High Definition Multi-Media Interface) inputs and one HDMI output. HDMI is a fully digital audio/video system for picture and audio in digital format for best possible picture quality. DVI (Digital Video Interface) is a subset of HDMI that uses different connectors and only supports digital video (no audio). The 551R is compatible with DVI in that simple passive DVI-HDMI adaptors are available which allow the conversion of the DVI connector to an HDMI format connector (and back again if required) for routing via the 551R.

HDMI outputs on Blu-ray, DVD players and Set-top boxes also often support higher resolution formats including progressive scan types. Consult both your HDMI source and TV manuals for details, it is often possible to select from various options, you will want to select the highest quality output that both your source and TV are compatible with.

From Blu-ray players, HDMI can also carry the latest Dolby Digital Plus and True-HD formats as well as DTS-HD High Resolution and Master Audio.

Ensure that the HDMI output of your player has been set to 'Bitstream' or 'Raw' to pass the formats to the 551R for decoding.

Also some Blu-ray players feature settings to allow down conversion of Dolby Digital Plus etc. to backwards compatible Dolby Digital 5.1 for older AV receivers which do not support these formats.

Ensure any such settings are disabled to allow our 551R access to all the latest formats.

For all the above reasons HDMI is the preferred connection method for both Audio and Video.

The 551R can however also accept Composite, S-Video and Component video for sources without HDMI outputs and automatically transcode and scale this video to the HDMI output.

Select the Video Input Assignment Menu.

For each source the currently selected video input type will be shown.

It is possible to assign any of the video input sockets to each Source in turn.

The Options are Composite 1 and 2, S-Video 1 and 2, Component 1 and 2, HDMI1 - 4.

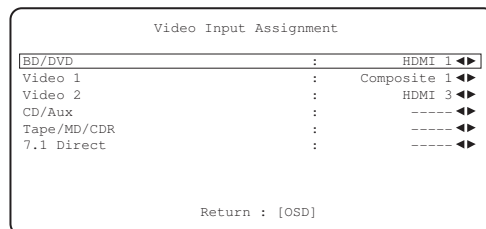

Note: Assigning a HDMI input to a source automatically also selects Scaler Bypassing for that source.

You can process these sources if you wish simply by setting the Scaler to Process in the Scaler Assign Processing menu afterwards.

4. Source setup

The next step is to select each source input in turn on the 551R and tell the unit:

- The type of audio connection you want to use for that source (Analogue, Digital or HDMI).
- The processing mode for that source.

The 551R remembers these settings individually for every source input and automatically recalls them as and when you change source input.

Audio connection type

Select the 'Audio In/Out Setup' menu. Highlight each source in turn and select either analogue, digital or HDMI input types (use the *Left* and *Right* arrows):

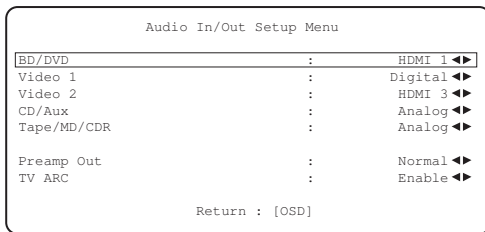

The options shown will be Analogue, Digital and HDMI if that source has been assigned an HDMI input for video as above.

Analogue inputs will require a stereo phono/RCA to phono/RCA cable connection to the 551R. Digital inputs will require either a 75ohm digital type phono/RCA to phono/RCA co-axial cable (S/P DIF) or an optical fibre cable (TOSLINK). The 551R will automatically use whichever is connected. Do not make connections to both the Optical and Co-axial inputs for a source.

Note: The Preamp output item at the bottom of this menu selects between Normal mode (the default), Pre Out Mode (when external power amps are used) and Ext 2 Ch Mode (where external power amps for front left and right only are used). These options are covered later. Make sure this setting shows Normal. TV-ARC is also covered in a later section.

Once you have set the audio types exit the OSD to save.

This setting can also be changed at any time without using the OSD by pressing the *Audio Input Type* button on the front panel or remote, this will then cycle between analogue, digital or HDMI input types where available for the currently selected source, as usual they will then be remembered the next time you return to that source.

Scaler Assign/Processing

The 551R features a Faroudja digital video processor/ scaler.

This can if desired process any of the video sources and scale them up (or down) to various resolutions.

This feature is most useful with analogue video sources where the processor can clean up the picture and scale it to 720p, 1080i or 1080p before outputting them over HDMI to a suitable TV.

On entering this menu you will see that the sources that you assigned an analogue video input are automatically set to Process.

Sources that you assigned an HDMI input for video are automatically set to Bypass (i.e. no processing).

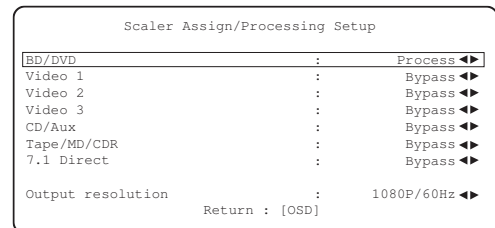

This is because many HDMI sources will be natively 1080p or may have high quality processing built in where it is best to send this video directly to the TV without any further processing in the 551R.

For analogue video sources it is almost always desirable to process these for best picture quality before passing them to the TV.

To change the Process/Bypass status of any source (including HDMI) simple select it in the menu and use the left and right buttons on the remote.

You can also set the desired output resolution for any Processed video (Bypassed video is unaffected).

The options are 480p 60Hz, 576p 50Hz, 720p 50Hz, 720p 60Hz, 1080i 50Hz, 1080i 60Hz, 1080p 50Hz and 1080p 60Hz.

Note: 3D TV content, 24fps content or other video standards that the 551R cannot process or recognise are always Bypassed to the output whatever the setting in this OSD.

Surround sound modes

The 551R supports several music and home-cinema listening modes. The output the 551R can provide, depends both on the source signal present, the speaker setup selected and the decode mode selected. Before we describe how to operate the 551R, below is a brief guide to the Surround Sound formats that the 551R is compatible with for reference:



Dolby's lossless audio technology developed primarily for high capacity Blu-ray discs/players. Dolby True HD delivers theoretically bit-for-bit sound identical to the studio master by the use of 100% lossless encoding. Previous formats such as Dolby Digital 5.1 or EX have used lossy encoding where some data (that is theoretically less audible) is always lost in the encoding process to reduce the storage capacity needed on the disc. This is a new format that supports up to eight (usually used as 7.1) full-range channels of 24-bit/96 kHz audio or two channels of 24/192 kHz via Blu-ray discs and is not backwards compatible with earlier schemes. The format can either be transmitted as a 'bitstream' to the 551R for internal decoding (recommended) or can be decoded by some Blu-ray players internally and sent to the 551R as multi-channel PCM. In both cases an HDMI connection is required to the 551R and a suitable Blu-ray player as Dolby True HD is only ever transmitted over HDMI.



An encoding scheme based on the original Dolby Digital CODEC, but with enhancements to improve coding efficiency and improved audio quality. Dolby Digital Plus supports 7.1 fully discrete channels compared to Dolby Digitals 5.1 (or 6.1 in its EX variant where the 6th channel is matrix encoded). These Dolby Digital Plus bitstreams are not backward compatible with legacy Dolby Digital decoders but require an AV Receiver developed to decode them (such as the 551R) and an HDMI connection as Dolby Digital Plus is currently only transmitted over HDMI. It is however a requirement that any Dolby Digital Plus enabled Blu-ray player must also be able to transform the Dolby Digital Plus into a backwards compatible Dolby Digital 5.1 output for playback on legacy Dolby Digital systems. The 551R is however fully compatible with Dolby Digital Plus.



A new lossless audio CODEC from DTS, rather than being incompatible with earlier versions, DTS-HD Master Audio is transmitted as an extension to a normal DTS bitstream. A second embedded stream is sent which contains the "difference" between the original studio master and the lossy compressed DTS, plus the two extra channels. DTS-HD Master Audio enabled devices (such as the 551R) are able to use this difference information to recreate a bit for bit lossless version of the original 7.1 data. Devices which do not support the Master Audio extension simply decode the original 5.1 DTS stream and ignore the Master Audio extension providing backwards compatibility.



Known also as DTS-HR an extension to the original DTS audio format. DTS-HD High Resolution Audio supports 7.1 fully discrete channels compared to DTS's 5.1 (or 6.1 in its DTS ES Matrix or DTS ES Discrete variants). As with DTS-HD Master Audio a second embedded stream is sent which contains the "difference" between the original studio master and the lossy compressed DTS, plus the two extra channels, however in this case the extra stream is also formed by lossy compression. Effectively this is a 7.1 version of DTS which can be decoded by devices (such as the 551R) which are able to decode DTS-HD High Resolution Audio. Devices which do not support the High Resolution extension simply decode the original 5.1 DTS stream and ignore the High Resolution extension providing backwards compatibility



Known also as DD (3/2) or DD 5.1, provides (up to) 5.1 output from suitable encoded Dolby Digital material, with 5 main channels (Front Left, Front Right, Centre, Surround Left, Surround Right) and a Low Frequency Effects Channel for the subwoofer, all discretely encoded. Decoding Dolby Digital requires a Dolby Digital encoded DVD disc and a digital connection from the source equipment (Such as a DVD player) to the 551R.

Note: Dolby Digital and DTS formats can sometimes carry less channels than their maximum such as Dolby Digital (2/0) which means a Dolby Digital encoded signal which is actually only carrying a two channel stereo signal (other channels inactive).



Known also as DTS (3/2) or DTS 5.1, DTS provides (up to) 5.1 output from suitable encoded DTS material, with 5 main channels (Front Left, Front Right, Centre, Surround Left, Surround Right) and a Low Frequency Effects Channel for the subwoofer, all discretely encoded. Decoding DTS requires a suitably encoded DTS disc and a digital connection from the source equipment to the 551R.



Known also as DD (3/3) or DD 6.1, an enhanced form of Dolby Digital. On top of the discretely encoded 5.1 channels DD EX provides an extra 6th channel (Surround Back, giving 6.1) matrix encoded into the rear surrounds for greater image depth and more solid sound localisation behind the listener. DD EX requires a DD EX encoded disc. DD EX is backwards compatible with DD 5.1 decoding. If DD EX is decoded as normal DD the Surround Back signal will be present in both Left and Right Rear Surrounds (forming a phantom rear centre). It can also be decoded as 7.1 by sending the Surround Back decode to both the Surround Back Left and Right speakers (forming two mono Back Surrounds).



Known also as DTS (3/3) Matrix, an enhanced form of DTS. On top of the discretely encoded 5.1 channels DTS ES also provides an extra 6th channel (Surround Back giving 6.1), matrix encoded into the rear surrounds for greater image depth and more solid sound localisation behind the listener. DTS ES requires a DTS ES encoded disc. DTS ES material is backwards compatible with DTS 5.1 decoding. If DTS ES is decoded as normal DTS the Surround Back signal will be present in both Left and Right Rear Surrounds (forming a phantom rear centre). It can also be decoded as 7.1 by sending the Surround Back decode to both the Surround Back Left and Right speakers (forming two mono Back Surrounds).



Another enhanced form of DTS, also known as DTS (3/3) Discrete or DTS ES Discrete 6.1. DTS ES Discrete also provides an extra channel (Surround Back) for greater image depth and more solid sound localisation behind the listener, however in this case extra data is included in the bitstream so that all channels are discretely encoded. The Surround Back has greater separation from the other channels than is possible with matrix encoded technologies. DTS-ES Discrete requires a DTS-ES Discrete encoded disc.

DTS ES Discrete is backwards compatible with both DTS 5.1 and DTS ES Matrix 6.1 decoding. If DTS ES Discrete is decoded as normal DTS the Surround Back signal will be present in both Left and Right Rear Surrounds (forming a phantom rear centre). If DTS ES Discrete is decoded with DTS ES Matrix the Surround Back signal will be decoded separately (i.e. as 6.1) but by a matrix process, which will give the same channel separation as if the source disc were actually DTS ES Matrix (but not as good as DTS EX Discrete).

It can also be decoded as 7.1 by sending the Surround Back decode to both the Surround Back Left and Right speakers (forming two mono Back Surrounds).



The replacement for the original ProLogic, Pro Logic II is a technology where 5 channels (Front Left, Front Right, Centre, Surround Left, Surround Right) are encoded into a Stereo mix by an analogue matrix process. Dolby Pro Logic II material can be played back by normal Stereo equipment (as Stereo) or decoded into 5 channel surround-sound.

Dolby Pro Logic II is compatible with the earlier 4 channel (Left, Centre, Right and mono Surround) Dolby Pro Logic system (which was the decoding counterpart to Dolby Surround encoding) as used widely on Video tapes, TV broadcasts and earlier films.

Note: Pro Logic does not include a Low Frequency Effects channel for the Subwoofer, but the 551R can create a Subwoofer output (for 5.1) via Bass management. Refer to the 'Tone/Sub/LFE configuration' section in the 'Operating instructions' part of this manual.



A newer version of Dolby Pro Logic II which is able to recreate 7 discrete surround sound channels from suitable encoded stereo source material. Pro Logic IIx also has modes for post processing either Stereo material or 5.1 material into 7 channels whether or not it has been Pro Logic IIx encoded. When 5.1 decoding is required, Dolby Prologic II decoding will always be used by the 551R in place of Pro Logic IIx as IIx only works for 7 channel output.

Note: Pro Logic IIx does not include a Low Frequency Effects channel for the Subwoofer, but the 551R can create a Subwoofer output (for 7.1) via Bass management. Refer to the 'Tone/Sub/LFE configuration' section in the 'Operating instructions' part of this manual.

Surround sound modes cont.



A DTS technology which is able to recreate 6 channel (Left Front, Right Front, Centre, Left Surround, Right Surround, Surround Back) surround sound from suitable analogue matrix encoded stereo source material. DTS Neo:6 material can be played back by normal Stereo equipment (as Stereo) or decoded into 7.1 by sending the Surround Back decode to the both the Surround Back Left and Right speakers (forming two mono Back Surrounds).

Note: Neo:6 does not include a Low Frequency Effects channel for the Subwoofer, but the 551R can create a Subwoofer output via Bass management. Refer to the 'Tone/Sub/LFE configuration' section in the 'Operating instructions' part of this manual.



A DTS technology that provides 5.1 channels of 96kHz / 24bit audio (along with video if required) on DVD-Video and DVD-Audio (video zone) discs (when suitably encoded in DTS 96/24). DVD players which allow 'DTS digital out' pass the DTS 96/24 bitstream over S/P DIF or HDMI for decoding in the 551R.

DSP modes

These modes allow a surround-sound experience from source material that has no encoding at all. The surround sound effect is achieved by Digital Signal Processing of the Analogue or Digital stereo source used. Five modes are possible: Movie, Music, Room, Theatre and Hall.

Stereo/Stereo + Sub

Only the Front Left and Front Right speakers (and subwoofer if selected) have output in this mode. If an analogue source is selected it will be converted to digital via 24 bit A/D converters to allow digital domain sub creation and bass/treble controls.

If a digital source is selected the 551R will be processing either LPCM stereo (from the digital outputs of a CD player for instance) or a Stereo downmix of DD or DTS material (from the digital output of a DVD player for instance).

Other modes

Analogue Stereo Direct

Selects the analogue inputs for the current source directly with no A/D conversion, DSP processing, Bass/Treble or subwoofer channel active. Provides the very best fidelity for analogue Hi-Fi source equipment. In this mode the 551R is acting just like a normal Hi-Fi integrated amplifier.

Multi Channel PCM

Some playback devices (in particular Blu-ray players) are able to decode some of the above formats themselves internally and then output the decoded audio as Multi Channel PCM to the 551R. In addition Blu-ray disks can support native unencoded Multi Channel PCM soundtracks (of up to 8 channels) on the disc itself. In either case if your player can output these over HDMI the 551R is able to receive them in Multi-Channel PCM mode.

Operating instructions

To activate the 551R, switch the Power button on the rear panel to *On* then press the *Standby/On* button on the front panel.

Selecting the source

1. Select the desired source by pushing the corresponding source button on the front panel or remote control.

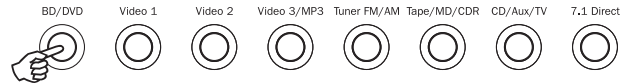

2. If necessary, press the *Audio Input Type* button to select the input mode of the source equipment, either analogue, digital or HDMI (depending on the connection made on the rear panel). You may have already assigned this in the 'Audio In/Out Setup Menu' in the OSD.

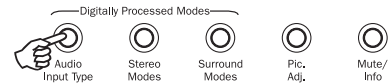

The digital, analogue or HDMI icons on the display show which is the currently selected input type.

Note: The 551R stores the input type for each source so that it is automatically recalled when that source is selected again.

Selecting the desired listening mode

Select an appropriate mode for the source material/type you are listening to by pressing the Stereo or Surround Modes button and cycling through sub-modes where available.

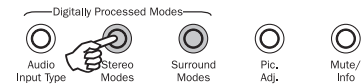

In all cases the first time a mode button is pressed the 551R will report the current decoding mode on the front panel display. Pressing the button again will then cycle to the next available mode (if there is one). If no button is pressed for 4 or 5 seconds the 551R returns to normal operation without changing mode.

Stereo Modes - Selects 2 channel Stereo operation for stereo material, pressing again selects Stereo + Sub mode.

This is a digitally processed mode that allows bass and treble controls, and sub generation if required. The input can be either analogue (in which case it will be turned into digital by 24 bit A/D conversion) or natively digital.

Surround Modes - Selects a range of digital surround modes for the appropriately digitally encoded material

Note: Some Surround Sound types (such as the Dolby and DTS HD) are available only from Blu-ray disc over HDMI.

Pressing the Surround Modes button will cause the 551R to lock onto the incoming bitstream and select the first available mode for the current bitstream type.

In some circumstances (see tables) pressing the button again will switch to an alternative decoding option.

ProLogic and Neo:6 are both available in various guises to decode appropriately encoded soundtracks. Additionally DSP modes are available to process sources with no encoding at all. Due to the matrix encoding process none of these modes incorporate flags that tell the 551R the type of encoding used in the source material. Thus you must manually select these modes.

Pressing the Surround Modes button when the 551R has locked to a DD/DTS bitstream will present more options where possible including Post-Processed modes.

These are modes that allow extra processing to be applied after the main surround-sound decoding. For instance Dolby Digital (2/0) + PLII Music. Which adds a 5.1 ProLogic decode to a Stereo Dolby Digital decode to turn 2 channel stereo into 5.1.

For 7.1 Speaker setups, the number of decoding possibilities increases as shown in the following 'Decode modes' tables. Several extra Post Processing modes are available using either Prologic Iix or Neo:6.

Incoming Dolby Digital/DTS streams are always shown on the front panel display as Dolby Digital (x/x).x or DTS (x/x).x, where the bracketed numbers indicate the active channels in the source material. Active output channels are shown by the icons on the right hand side of the front panel display. Possible incoming DD/DTS types are:

- (1/0) - Mono, Centre channel only
- (2/0) - Left/Right stereo
- (2/0).1 - Left/Right stereo and LFE (Sub)
- (2/2) - Left/Right stereo and Left/Right surround
- (3/0) - Left, Centre, Right
- (3/0).1 - Left, Centre, Right and LFE (Sub)
- (3/2).1 - 5.1: Left, Right, Centre, Left Surround, Right Surround and LFE (Sub)
- (3/4).1 - 7.1: Left, Right, Centre, Left Surround, Right Surround, Surround Back Left, Surround Back Right and LFE (Sub)

Operating instructions continued

Decode modes - 5.1 speaker setup



Surround Modes

Incoming audio format	Native channel resolution	Modes available	Output channels
PCM	2	PCM PCM + PLII Movie PCM + PLII Music PCM + PLII Game PCM + Neo:6 Cinema PCM + Neo:6 Music Movie Music Room Theatre Hall	2 ◆ >5.1 >5.1 >5.1 >5.1 >5.1 >5.1 >5.1 ■ >5.1 ■ >5.1 ■ >5.1 ■ >5.1 ■
Dolby Digital (2/0)	2	Dolby Digital (2/0) Dolby Digital (2/0) + PLII Movie Dolby Digital (2/0) + PLII Music Dolby Digital (2/0) + PLII Game	2 ◆ >5.1 >5.1 >5.1
Dolby Digital	5.1	Dolby Digital (3/2).1	5.1
Dolby Digital EX	6.1	Dolby Digital EX (3/3).1	5.1<
DTS (2/0)	2	DTS (2/0)	2 ◆
DTS	5.1	DTS (3/2).1	5.1
DTS ES Matrix	6.1	DTS ES Matrix (3/3).1	5.1<
DTS ES Discrete	6.1	DTS ES Discrete (3/3).1	5.1<
DTS 96/24	5.1	DTS 96/24	5.1
Multi Channel PCM	5.1 ★	Multi PCM (3/2).1	5.1
Multi Channel PCM	7.1 ★	Multi PCM (3/4).1	5.1<
Dolby Digital Plus	5.1 ★	Dolby Digital Plus (3/2).1	5.1
Dolby Digital Plus	7.1 ★	Dolby Digital Plus (3/4).1	5.1<
Dolby True HD	5.1 ★	Dolby True HD (3/2).1	5.1 ▼
Dolby True HD	7.1 ★	Dolby True HD (3/4).1	5.1< ▼
DTS HD High Resolution	5.1 ★	DTS-HD HR (3/2).1	5.1
DTS HD High Resolution	7.1 ★	DTS-HD HR (3/4).1	5.1<
DTS Master Audio	5.1 ★	DTS-HD MA (3/2).1	5.1 ▼
DTS Master Audio	7.1 ★	DTS-HD MA (3/4).1	5.1< ▼

Key (all tables)

5.1< Indicates a 5.1 decode of 6.1 or 7.1 material (phantom back centre).

>5.1 Indicates a 5.1 output created by a 2.0 decode post processed to 5.1.

>7.1 Indicates 7.1 output created by a 2.0 or 5.1 decode, post-processed to 7.1.

● 7.1 Upmix of 5.1 material, Left and Right Surrounds mixed to both Left and Right Surrounds and Left and Right Rear Surrounds.

▲ 7.1 'upmix' of 6.1 material. Center back surround channel played back via two mono rear surrounds. Acoustically this is actually a native format presentation.

◆ Stereo or Stereo + Sub, Press Stereo Modes Button to change.

■ Digital Signal Processing created modes for signals with no encoding.

★ Available via HDMI inputs only.

▼ Lossless encoded format.

Note: Bold entries are being output in their native resolution/format.

In all cases, pressing the Stereo Modes button always cycles round:	
Stereo Modes	Output channels
Stereo	2
Stereo + Sub	2.1
Either native Stereo or downmix of DD/DTS 5.1/6.1/7.1 etc.	

Pressing a mode button will first cause the 551R to scroll the current decode mode across the front panel display. Pressing the mode button again whilst text is scrolling on the display or within 4 seconds of it finishing will select and display the next available mode.

Decode modes - 7.1 speaker setup



Surround Modes

Incoming audio format	Native channel resolution	Modes available	Output channels
PCM	2 When the source has been appropriately encoded PLII gives 5 channel Neo:6 6 channel and PLIIx 7 channel matrix encoding	PCM PCM + PLIIx Movie PCM + PLIIx Music PCM + PLIIx Game PCM + Neo:6 Cinema PCM + Neo:6 Music Movie Music Room Theatre Hall	2 ◆ >7.1 >7.1 >7.1 >7.1 >7.1 >7.1 >7.1 ■ >7.1 ■ >7.1 ■ >7.1 ■ >7.1 ■ >7.1 ■
Dolby Digital (2/0)	2	Dolby Digital (2/0) Dolby Digital (2/0) + PLIIx Movie Dolby Digital (2/0) + PLIIx Music Dolby Digital (2/0) + PLIIx Game	2 ◆ >7.1 >7.1 >7.1
Dolby Digital	5.1	Dolby Digital (3/2).1 + EX Dolby Digital (3/2).1 Dolby Digital (3/2).1 + PLIIx Movie Dolby Digital (3/2).1 + PLIIx Music	>7.1 >7.1 >7.1 5.1
Dolby Digital EX	6.1	Dolby Digital EX (3/3).1 Upmix Dolby Digital (3/3).1 + PLIIx Movie Dolby Digital (3/3).1 + PLIIx Music	7.1 ▲ >7.1 >7.1
DTS (2/0)	2	DTS (2/0) DTS (2/0) + PLIIx Movie DTS (2/0) + PLIIx Music DTS (2/0) + Neo:6 Cinema DTS (2/0) + Neo:6 Music	2 ◆ >7.1 >7.1 >7.1 ▲ >7.1 ▲
DTS	5.1	DTS (3/2).1 Upmix DTS (3/2).1 DTS (3/2).1 + PLIIx Movie DTS (3/2).1 + PLIIx Music DTS (3/2).1 + Neo:6 Cinema DTS (3/2).1 + Neo:6 Music	>7.1 ● >7.1 >7.1 >7.1 ▲ >7.1 ▲ 5.1
DTS ES Matrix	6.1	DTS ES Matrix (3/3).1 Upmix DTS ES Matrix (3/3).1 + PLIIx Movie DTS ES Matrix (3/3).1 + PLIIx Music DTS ES Matrix (3/3).1 + Neo:6 Cinema DTS ES Matrix (3/3).1 + Neo:6 Music	7.1 ▲ >7.1 >7.1 >7.1 ▲ >7.1 ▲
DTS ES Discrete	6.1	DTS ES Discrete (3/3).1 Upmix DTS ES Discrete (3/3) + PLIIx Movie DTS ES Discrete (3/3) + PLIIx Music DTS ES Discrete (3/3) + Neo:6 Cinema DTS ES Discrete (3/3) + Neo:6 Music	7.1 ▲ >7.1 >7.1 >7.1 ▲ >7.1 ▲
DTS 96/24	5.1	DTS 96/24 Upmix DTS 96/24 DTS 96/24 (3/2).1 + PLIIx Movie DTS 96/24 (3/2).1 + PLIIx Music DTS 96/24 (3/2).1 + Neo:6 Cinema DTS 96/24 (3/2).1 + Neo:6 Music	>7.1 >7.1 >7.1 >7.1 >7.1 5.1
Multi Channel PCM	5.1 ★	Multi PCM 3/2.1 Multi PCM (3/2).1 + PLIIx Movie Multi PCM (3/2).1 + PLIIx Music	5.1 >7.1 >7.1
Multi Channel PCM	7.1 ★	Multi PCM 3/4.1	7.1
Dolby Digital Plus	5.1 ★	Dolby Digital Plus (3/2).1 Upmix Dolby Digital Plus (3/2).1 Dolby Digital Plus (3/2).1 + PLIIx Movie Dolby Digital Plus (3/2).1 + PLIIx Music	>7.1 ● >7.1 >7.1 5.1
Dolby Digital Plus	7.1 ★	Dolby Digital Plus (3/4).1	7.1

Operating instructions continued

Decode modes - 7.1 speaker setup



Surround Modes

Incoming audio format	Native channel resolution	Modes available	Output channels
Dolby True HD	5.1 ★	Dolby True HD (3/2).1 Upmix Dolby True HD (3/2).1 Dolby True HD (3/2).1* + PLIIx Movie Dolby True HD (3/2).1* + PLIIx Music	>7.1 ▼ ● >7.1 >7.1 5.1 ▼
Dolby True HD	7.1 ★	Dolby True HD (3/4).1	7.1 ▼
DTS HD High Resolution	5.1 ★	DTS-HD HR (3/2).1 Upmix DTS-HD HR (3/2).1	>7.1 ● 5.1
DTS HD High Resolution	7.1 ★	DTS-HD HR (3/4).1	7.1
DTS HD Master Audio	5.1 ★	DTS-HD MA (3/2).1 Upmix DTS-HD MA (3/2).1	>7.1 ▼ ● 5.1 ▼
DTS HD Master Audio	7.1 ★	DTS-HD MA (3/4).1	7.1 ▼

* <=96kHz

Using the Tuner

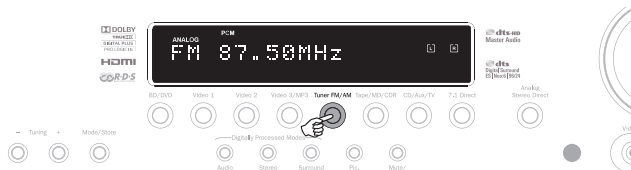

1. Press the *Tuner FM/AM* button on the front panel or remote control to select Tuner mode.
2. Press the *Tuner FM/AM* button again to select FM or AM if desired.
3. Press the *Mode/Store* button on the front panel (or *Mode* button on the remote control) to select automatic tuning, manual tuning or preset mode.
4. Press the *Tuning +* and *Tuning -* buttons (or the left and right arrow buttons on the remote) to select the station you want to listen to.

In automatic tuning mode the unit scans to the next strong station. In manual tuning mode the user can step manually through the frequencies. In preset mode the unit cycles through the presets only.

Two FM modes are available, stereo and mono - Press the *Stereo Mono* button on the remote to alternate between Stereo mode and Mono mode. If the *Display* button is pressed, the RDS station names of FM stations will be displayed if available.

Storing stations

1. Tune in a station you wish to store as explained previously.
2. Press and hold the *Mode/Store* button (or use the *Store* button on the remote) for 5 seconds.
3. Use the *Tuning+/-* buttons to select a preset station number (1-15). The station number will be displayed on the screen.
4. Press the *Mode/Store* button (or use the *Store* button on the remote) to memorise the frequency.

Radio Data Systems (RDS)

RDS is a method for the transmission of additional information from local radio stations. It is only available in FM mode. RDS will only work if the local broadcasting stations have RDS transmission and the signal is strong enough.

Press the *Info* button on the remote and go through the displayed functions. There are functions for PS, PTY, CT and RT:

PS (Station Name) - current station name will be shown

PTY (Program Type) - current name type of the program will be shown

CT (Clock/Time) - current time from Radio Station will be displayed.

Note: Clock/Time will be only transmitted from local radio station once a minute. If the Clock - Time is not available the message "NO CT" will appear briefly on the display.

RT (Radiotext) - some Text messages will be shown.

Lip sync

The 551R can if required apply a small delay to the audio playback to resynchronise it to any video playback which appears to be behind the audio in time.

This can sometimes happen if the video is slightly delayed by a player or TV performing a lot of video processing.



Pressing the Lip Sync button on the remote will bring up the current Lip Sync value on the 551R's main display and allow adjustments in 10mS (10 thousandths of a second) increments.

Setting the Lip sync value to 0 causes Lip Sync delay to be turned off.



Note: The Lip sync value is stored and recalled separately for each source.

Audio Return Channel

The 551R supports an Audio Return Channel (ARC) function from TVs that also support this function (which must feature an HDMI1.4 input and have actually implemented the ARC feature, see your TV's manual).

ARC allows a TV to send audio back down its incoming HDMI lead to the 551R's HDMI output socket.

This function allows the 551R to play back the audio from a TV's built-in terrestrial cable or satellite tuner whilst you watch its picture.

To enable the use of ARC navigate to the select TV- ARC and use the up/down buttons to select the Enabled setting.

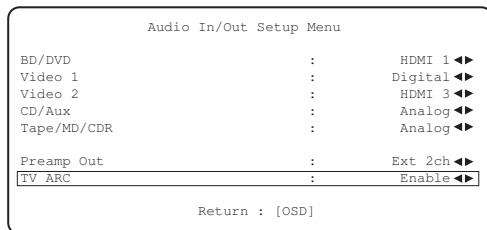

Using ARC

ARC can be started in one of two ways. If your TV supports it there may be a menu item to start ARC on your TV.

Your TV then sends commands to the 551R which cause it to start an ARC session and 'TV-ARC' will appear on the front panel display automatically.

Some TVs may also start an ARC session whenever you select the in-built tuner and stop when you select another source.

Alternatively you can start ARC by pressing the CD/Aux/TV button twice on the 551R (as long as TV-ARC has been enabled in the 551R's OSD as above).

The first press selects CD/Aux, the second selects ARC and 'TV-ARC' appears on the front panel display. The 551R will then send commands to the TV over HDMI to try to start an ARC session.

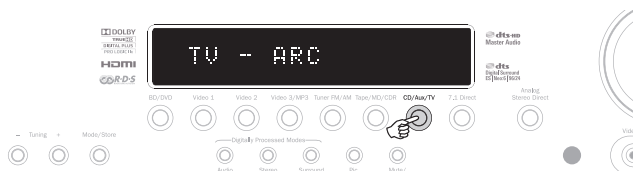

To finish ARC simply disengage it on your TV or press a different source button on the 551R.

Picture Adjustment

For sources that have had the Scaler set to Process the 551R can provide some picture adjustments.

These adjustments are remembered source by source.

Pressing a source for which the scaler is in Bypass will do nothing.

Pressing a source for which the scaler is set to Process will bring up the first adjustment item, shown at the top of the screen as below:

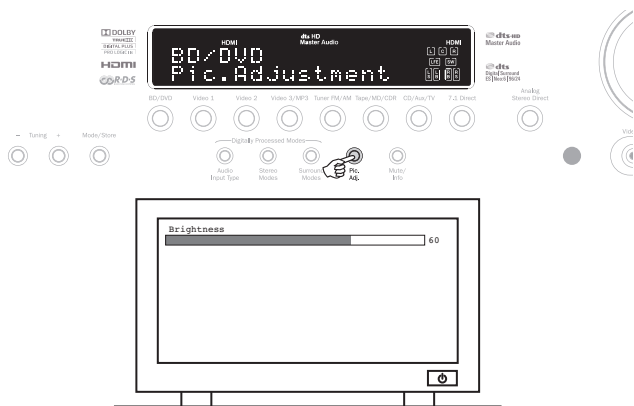

You can use the up/down buttons to make changes to the picture or press Pic.Adj. again to move to the next item.

Adjustments are available for Brightness, Contrast, Hue, Saturation and 4:3/16:9 Zoom.

A second feature of the Picture Adjustment button is setting the output resolution for the scaler (this can also be done in the OSD see earlier section).

If the button is pressed and held for 10 seconds approx the 551R will show the current scaler output resolution on the 551R's front panel display.

Holding for a further 10S will change the output resolution to the next available one (and allow time for the TV to re-sync).

Holding further will continue the process and the video output will gradually move through all possible resolutions 480i 50Hz, 576i 60Hz, 720p 50Hz, 720p 60Hz, 1080i 50Hz, 1080i 60Hz, 1080p 50Hz and 1080p 60Hz (and back round).

This feature can be useful if the scaler output is accidentally set to a resolution your TV does not support and picture is lost.

By pressing and holding Pic.Adj. you can cause the 551R to scroll through all resolutions automatically. Simply let go of the button when a visible video image at a suitable resolution appears.

Audio split mode

In some circumstances the 551R is able to allow the user to view one source whilst listening to another. For instance you could watch the video of a sports channel whilst getting an audio commentary from another such as the Tuner.

To perform Audio Split:

1. Select the source you wish to watch in the normal way.
2. Press and hold the button for the source you wish to listen to. After 4 seconds approx "Audio Split" will scroll across the display and you will now be listening to that source instead. Video will not have changed.



The 551R allows splitting from any source whatever its video input type (Composite, S-Video, Component or HDMI) but only to sources where analogue or digital audio is the current audio input type, not HDMI.

If the combination is not allowed "Mode Unavailable" will instead scroll across the display and no change will be made.

To cancel audio split mode simply select a new source and normal operation will be resumed.

Advanced setup

For most users the basic four stage setup process (Page 14 onwards) should be sufficient for normal use.

However the 551R also features many more advanced settings for users who wish to further customise the settings and operation to personal preference.

Sub crossovers and bass management

As covered in the '551R Setup' section the 551R performs bass management for any speaker that is set to 'Small' in the OSD. This means that bass for speakers that are unable to reproduce bass effectively is instead routed to the subwoofer.

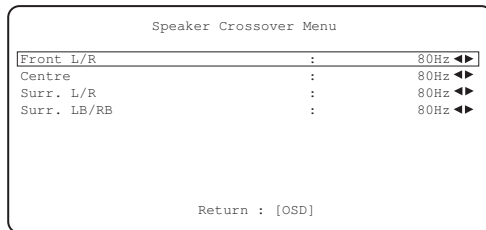

The crossover adjustments in the Speaker crossover menu are used to determine the point at which this transition is made. In other words they set the frequency below which bass is routed away from any 'Small' speakers and into the Subwoofer channel. It should be understood that bass sent to the subwoofer by bass management is different to bass encoded into the surround-sound material as a dedicated Low Frequency Effects channel.

If the source material contains a separate LFE channel (ie DD or DTS material) this is always routed to the subwoofer (if it is On) and is not affected by the crossover setting. Some encoding types (Such as Dolby PLII/Ix and Neo:6) do not actually have a LFE channel.

The default setting for all bass management crossovers is 80Hz and is a good global starting point. If you do not wish to make any adjustments simply leave all crossovers at this default setting.

Note: These settings are actually only used for speakers that have been set to Small in the Speaker Configuration Menu.

For advanced users it is however possible to adjust the speaker crossovers used for any speakers set as 'Small' independently to allow for the fact that you may wish to direct bass away from front floorstanding speakers (and to the Subwoofer) at perhaps 50Hz but away from Surround Left and Rights at perhaps 100Hz. If you wish to make these adjustments it is best to consult your loudspeaker manufacturers documentation or contact your dealer to determine the frequency response of your system and where each speaker types bass response starts to tail off (often called the 3dB or 6dB roll off/cutoff point). This would be approximately the point the corresponding crossover should be set to.

Bi-amping

If you are running a 5.1 (or less) speaker setup only the 551R allows for bi-amping of the front left and right channels. It will be seen in the Speaker Configuration menu that with the Decode mode set as 5.1 a Bi-amp On/Off item appears.

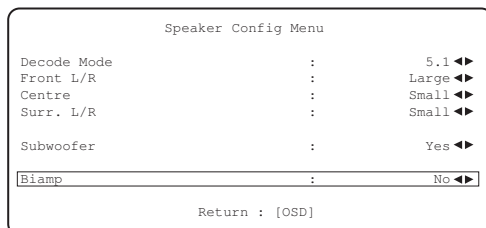

When selected, the 551R sends the front left and right signals to the SBL and SBR outputs as well.

In conjunction with bi-wireable/bi-ampable speakers this allows you to use two runs of speaker cable to each speaker with a dedicated amplifier channel for the bass and treble drivers of each speaker which can slightly increase the sound quality.

See diagram below of a bi-amped system (only front left and right speakers shown).

Note: Bi-wire links must be removed on the speaker's terminals.

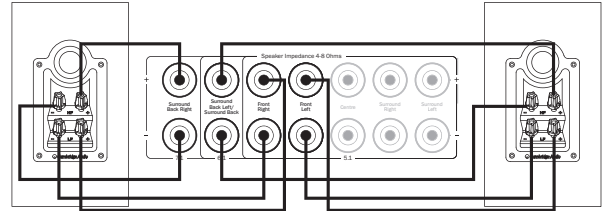

Tone/Sub/LFE configuration

Select the 'Tone/Sub/LFE' menu:

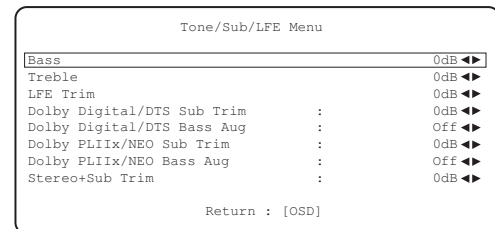

The Bass response can be adjusted +/- 10dB @ 100Hz (shelving). The Treble response can be adjusted +/-10dB @ 10kHz (shelving). The "Tone" icon will light up on the display if these controls are adjusted away from 0dB (flat). The Subwoofer crossover point can also be adjusted from 40 to 150Hz in 10Hz steps and also to 200Hz.

The 551R incorporates a couple of advanced Bass Management features. The overall Sub Level for DD/DTS modes, PLII/x/Neo:6 modes and Stereo + Sub mode can be set to different levels. This can be useful if you prefer to have a high level of Sub operation whilst watching movies but a lower level for music playback. The three levels are simply adjusted by up to +/-10dB in the OSD. The second feature is that the way Bass Management is applied can be changed.

In normal operation (Bass Augment Off) if the Front speakers are set to 'Small' (in the 'Speaker Config' menu) their bass is re-directed by high-pass filtering the Fronts and sending that bass to the Sub channel (i.e. bass is removed from the Fronts and sent to the Sub). If they are set to 'Large' no filtering takes place and no bass is sent from them to the Sub channel.

However with the Bass Augment function On and the Front speakers set to 'Large', bass from the Front Left and Right is now sent to the Sub channel without any filtering of the Front Left and Right taking place (i.e. these channels remain full range). In other words, the bass in the Sub channel is augmented by extra bass from the Front Left and Right channels. If the Front Left and Right are set 'Small', Bass Augment has no effect and operation is the same as for Bass Augment Off.

Bass Augment can be On or Off separately for DD/DTS or PLII/Ix/Neo:6 operation.

There is no Bass Augment function for Stereo + Sub mode because in this mode if the Front speakers are set to 'Large' they will actually always be unfiltered.

Bass Augment can be a useful function with PLII/Ix and Neo:6 material because these encoding types do not include an LFE Channel. This would normally mean that if all the speakers in your setup were set to 'Large', the subwoofer would in fact be inactive (as no bass has been re-directed plus there is no LFE channel). If it is desired to have the subwoofer running with all Large Speakers and these encoding types, enable Bass Augment for PLII/Neo6 and then set the Crossover points and levels by ear. A Sub channel will now be created from the Front Left and Right channels without filtering them. As with all adjustments it is a good idea to experiment to determine what works best with your particular setup.

Note: These adjustments work in all digitally processed Stereo or Surround modes but not in Analogue Stereo Direct or 7.1 Direct modes.

The LFE channel (for DD / DTS material) can also be trimmed by up to 10dB in 1dB steps useful for late night listening or other situations where it might be desired to reduce the low frequency effect level perhaps temporarily.

Remember the LFE is the Low Frequency Effects channel encoded into the disc and is different to the over all sub level which can include bass management from the other speakers.

Bass/Treble adjustments can also be made from the remote without entering the OSD by pressing the Bass/Treble button and then using the Vol Up/Down buttons.

Sub trim adjustments can also be made from the remote without the OSD by holding down the Sub On/Off button and using the Vol Up/Down buttons whilst it is kept down.

OSD setup

On-Screen Display is available on all video outputs.

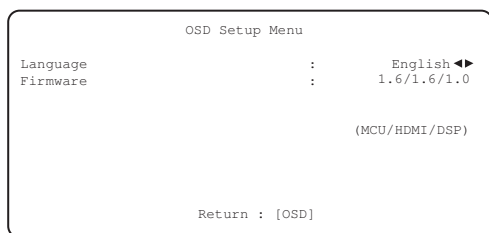

The OSD can be shown in several different languages. To change the OSD language highlight the 'Language' menu and use the *Left* and *Right* arrows to select between English, Dutch, French, German, Spanish, Italian, Norwegian, Swedish and Danish. Press the OSD button again to exit and save the options.

Advanced Dolby/DTS adjustments

The first three adjustments affect Dolby Prologic II or IIx processing (or post-processing) in Music mode only. Movie and Game modes where available are preset as part of their specification to match the encoding or provide a specific effect. These adjustments have no affect in these modes.

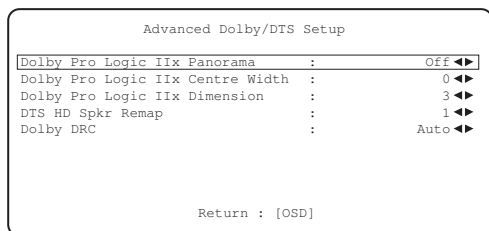

Panorama mode - A Prologic II/IIx mode that extends the front Stereo image to the surround sound speakers for a more enveloping experience. This mode can be either On or Off.

Centre Width - Allows gradual adjustment of the centre image from being produced only by the Centre speaker (Setting 0) through levels of being spread between the centre channel and Left and Right speakers to finally being produced by the Front Left and Right speakers only (Phantom Centre, Setting 7). Useful in optimising the Front/Centre/Right soundfield for best integration of the 3 speakers. Best tuned by ear.

Dimension - Adjusts the soundfield to be gradually shifted from the front of the room to the back to suit taste, speaker positioning and size of room. Setting 0 has the image furthest forward, 6 furthest back.

All three adjustments are a matter of personal preference, experiment for the settings that you prefer when you are using PLII or PLIIx decoding.

Dynamic range control

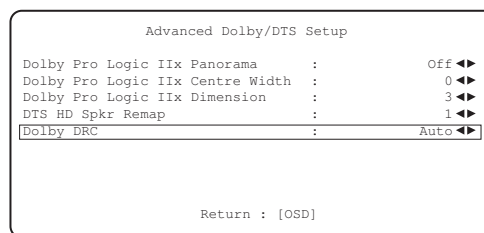

This setting controls the dynamic range of Dolby Digital movie soundtracks by compressing the audio to limit the difference in level between loud and quiet passages in the movie.

This can be a useful feature when watching movies late at night for instance. Three settings are possible:

Auto - Compression is always applied for Dolby Digital and Dolby Digital Plus soundtracks. The application and amount of compression to Dolby True HD soundtracks is dictated by the soundtrack itself.

Off - No Compression (normal full dynamic range playback)

On - Compression is always applied for all Dolby soundtracks (reduced dynamic range playback)

Advanced setup continued

DTS-HD speaker re-map

As there is no "official" speaker layout for discrete 7.1 channel audio it could be possible that the original master track of a 7.1 soundtrack was mastered with a different speaker layout than the one being used in your home. DTS have addressed this issue for DTS-HD Master Audio and High Resolution Audio by including in the bitstream flags to tell the receiving AV Receiver which of a 7 nominal 7.1 speaker layouts was actually used. By using special DTS Speaker Remap algorithms the 551R is able to electronically "reposition" the speakers (i.e. direct the audio propagation), so that the playback matches the original encoded layout for the best possible sound quality.

A second aim of this technology is that by re-purposing some of the 7.1 available channels it is possible to use some of them to do new things such as adding a height element to the sound field.

The following diagrams show the 7 possible encoding schemes for reference.

The angles quoted refer to the angle from a nominal 0 degrees line through the centre channel to each speaker either side right or left of that line.

Configurations 1 and 5 are variants of normal 7.1 setups whilst Configuration 6 can increase the available panning of the front channels.

Configurations 2,3,4 and 7 are less conventional and re-purpose some of the available 7.1 channels to provide an extra height dimension to the sound field in different ways. Please refer to the DTS website for more details on this new technology.

Configuration 1 - 7.1 channel: L, C, R, LFE, Lss, Rss, Lsr, Rsr

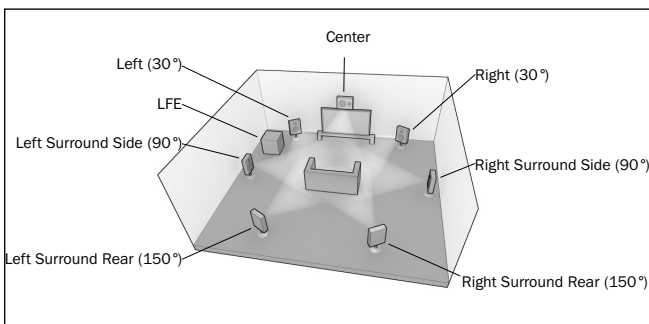

Configuration 2 - 7.1 channel: L, C, R, LFE, Ls, Rs, Lhs, Rhs

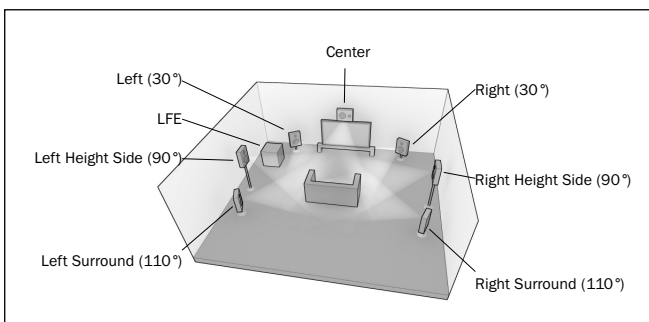

Configuration 3 - 7.1 channel: L, C, R, LFE, Ls, Rs, Cs, Oh

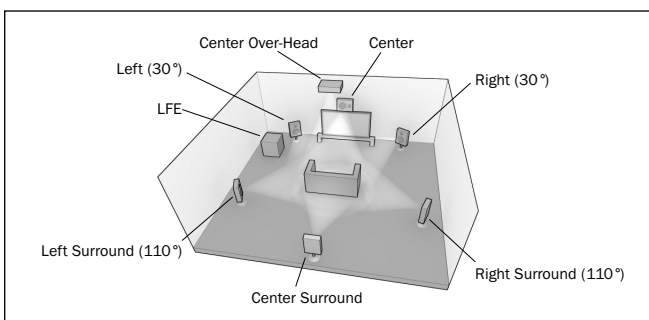

Configuration 4 - 7.1 channel: L, C, R, LFE, Ls, Rs, Lh, Rh

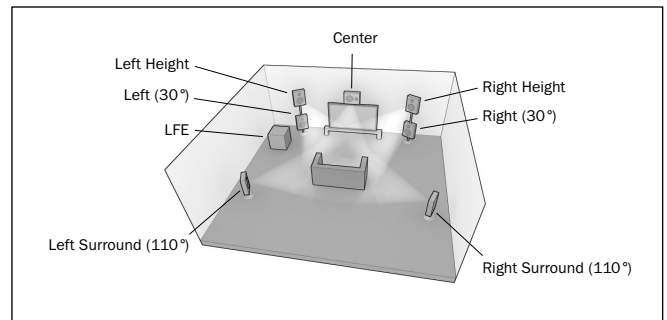

Configuration 5 - 7.1 channel: L, C, R, LFE, Ls, Rs, Lsr, Rsr

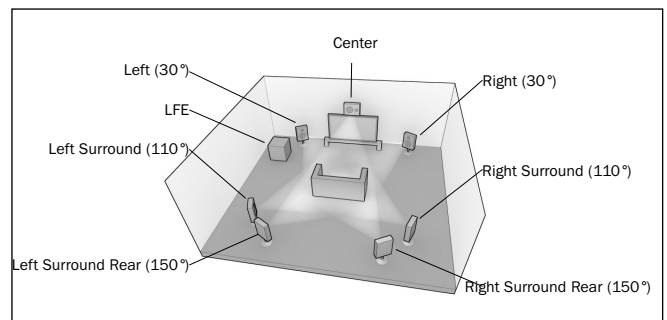

Configuration 6 - 7.1 channel: L, C, R, LFE, Ls, Rs, Lw, Rw

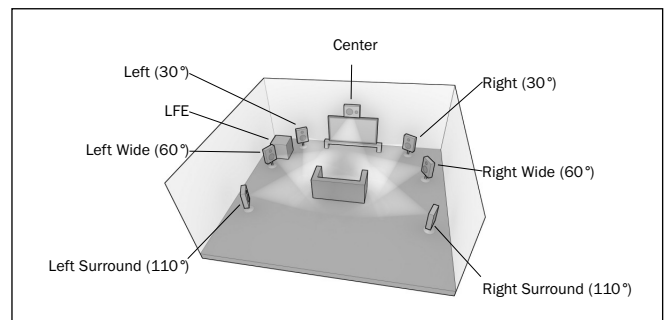

Configuration 7 - 7.1 channel: L, C, R, LFE, Ls, Rs, Ch, Cs

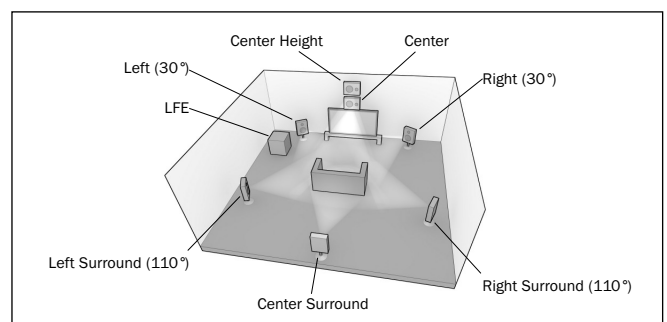

For **playback** the 551R expects you to have an actual physical speaker setup approximately conforming to one of the layouts as shown below.

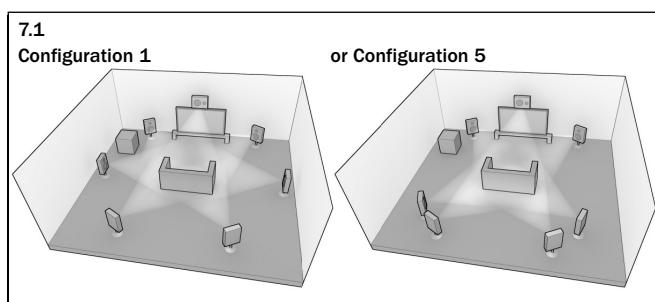
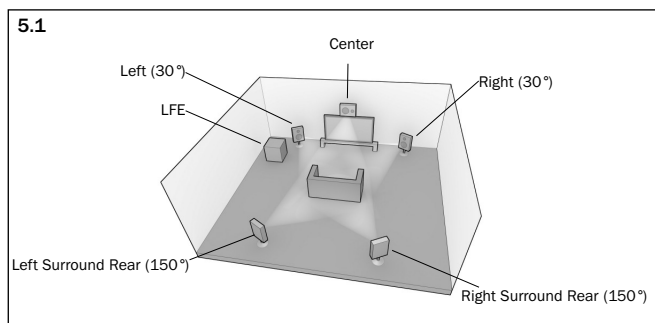

For 5.1 setups the situation is simple, the 551R automatically performs any DTS Speaker Remapping required, mapping any of the 7 incoming possibilities to this configuration.

For 7.1 there are two alternative speaker setup you might have. These corresponds to configuration 1 and configuration 5 as above.

Here you need to tell the 551R which configuration best matches your speaker setup by selecting the DTS-HD speaker menu and selecting the 1 or 5 option.

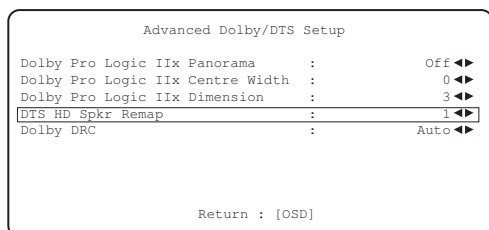

The 551R can then perform any speaker re-mapping required automatically, and maps any of the incoming 7 possibilities to whichever one of the two 7.1 possibilities you have.

Note: This feature by its nature only works for 7.1 DTS HD Master Audio or DTS HD High Resolution Audio bitstreams.

Also note that where the incoming speaker configuration and your physical speaker configuration actually match the 551R performs no mapping as you'd expect.

Custom installation (C.I.) use



An IR Emitter Input is provided that allows modulated IR remote control commands to be received electrically by the unit. An RS232 port is also featured which allows the 551R to be controlled by C.I. systems.



In addition the unit features 'direct' IR/Control codes as well as toggle codes for some of their features to simplify programming custom installation systems. Special direct On/Off and Mute commands can be accessed on the supplied remote control for teaching into C.I. systems as follows:

1. Press and hold the *Standby/On* button on the remote control. The remote first generates it's standby (toggle) command. Keep the button held down, after 12 seconds an AV receiver "On" command will be generated. If the button is kept held down for a further 12 seconds, an AV receiver "Off" command is generated.

Repeat this procedure with the Mute, Sub On/Off, Stereo Mono and Tuner AM/FM buttons to send On/Off commands. The Tuner AM/FM button also provides unique FM and AM commands to allow switching to a specific band.

A full code table and RS232 protocol for this product is available on the Cambridge Audio website at www.cambridge-audio.com.

Reset/Back-up memory

The 551R has a function that preserves the preset memory and other settings. In the event of a power failure, or if the power cord of the unit is disconnected from the mains outlet, the back-up memory will preserve the preset memory for approximately one week. If the power supply is interrupted for 7 days or longer, the memory settings will be erased.

If it is desired to reset all settings to their factory defaults (or in the unlikely event that the unit locks up due to an electrical discharge etc), with the unit on and out of Standby mode press and hold the DVD and Analogue Stereo Direct buttons on the front panel for three seconds.

"RESET" will appear briefly on the front panel display before returning to Standby mode.

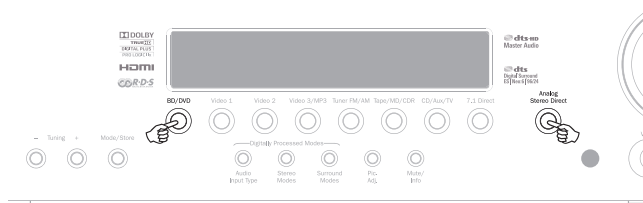

Troubleshooting

A low hum or buzz sound can be heard

Power cords or lighting placed near this product.

Analogue inputs not connected securely.

Sound is not audible from one channel

Speaker connections disconnected.

Speaker set to "None" in OSD setup menu.

Sound cuts off when listening to music or there is no sound even though power is ON

Speaker impedance is less than prescribed for the 551R.

The unit is not adequately ventilated and may be overheating.

Low bass or "phases" response

Speaker polarity (+/-) of one or more speakers is reversed.

An unusual hissing noise is heard when listening to a radio broadcast in stereo, but not heard when listening in mono

A slight noise may be heard because the method used for modulation of FM stereo broadcasts is different than that used for mono broadcasts.

Aerial quality also effects the level of hiss heard.

Noise is excessive in both stereo and monaural radio broadcasts

Poor location and/or direction of the antenna.

Transmitting station is too far away.

No sound from the rear speakers

Source being played is not recorded in surround sound.

Speaker/s set to "None" in OSD setup menu.

A stereo mode has been selected.

No sound from the centre speaker

Centre speaker has been set to "None" in OSD setup menu.

A stereo mode has been selected.

No sound from the subwoofer

Sub has been set to 'Off' in the OSD setup menu or via the remote.

DTS Neo:6, DD PLII/IIx modes (which have no LFE channel) have been selected with all speakers set to "Large".

Remote control is not working

The batteries are flat.

The remote is too far from the receiver or out of the effective range.

No sound from speakers when connected to a digital input

Audio input type is set to analogue (check display). Press the *Audio Input Type* button to switch to digital.

No sound from speakers when connected to an analogue input

Audio input type is set to digital. Press the *Audio Input Type* button to switch to analogue (check display).

Audio input type can also be set in the Input/Output Setup menu of the OSD.

No Sound from any speakers

Receiver is set for 'Pre-out' operation.

By entering the OSD menu, selecting the input/output setup menu, the Preamp out setting can be changed from 'Normal' to 'Pre-out'. This disables the internal amplifiers when an external decoder amplifier is being used. Reset this to 'Normal' to restore sound.

No Sound from front speakers, but rear speakers work

Receiver is set for 'Ext 2Ch' operation.

By entering the OSD menu, selecting the input/output setup menu, the Preamp out setting can be changed from 'normal' to 'Ext. 2 Ch'. This disables the internal amplifiers for the front channels when an external amplifier is being used to drive those channels. Reset this to 'Normal' to restore sound.

Technical specifications

Audio

Power Output	All Channels : 110 watts rms per channel, 6 ohms (two channels driven)
	All Channels : 90 watts rms per channel, 8 ohms (two channels driven)
	All Channels : 60 watts rms per channel, 8 ohms (all 7 channels driven)
THD	<0.006% @1kHz
Crosstalk	<-60dB @ 1kHz
Frequency response	10Hz - 20kHz -1dB
S/N Ratio	>90dB 'A' weighted
Audio Input Impedance / Sensitivity	47kOhms / 175mV or greater
Digital Input Impedance	75 ohms (Coaxial/S/P DIF)
Tone Control	
- Bass	+/-10dB @ 100Hz
- Treble	+/-10dB @ 10kHz
Tuner	
- FM mode	87.5-108MHz, 75 ohm coaxial aerial
- AM mode	522-1629kHz, 300 ohm loop aerial

Video

Video Levels /Impedance	
- Composite (CVBS)	1Vp-p / 75 ohm
- S-Video (S-VHS)	Y 1Vp-p / 75 ohm C 0.286 Vp-p / 75 ohm
- Component	Y 1Vp-p / 75 ohm Cb/Cr 0.75Vp-p / 75 ohm Pb/Pr 0.75Vp-p / 75 ohm

HDMI

HDMI 1.4
EIA/CEA - 861D
HDCP 1.1

All audio modes supported except reception of native Direct Stream Digital (DSD).

ARC and 3D-TV/deep colour pass through supported.

CEC and HEC not supported.

General

Architecture	Cirrus Logic CS43122 24 Bit 192kHz capable DAC for Front Left & Right
	Cirrus Logic CS52526 24 Bit 192kHz capable CODEC for surround channels + 24 Bit 2 channel A/D conversion
	Cirrus Logic CS497004 dual 32 bit DSP
	Faroudja FLI2310 scaler
Audio Inputs	6 Line Level Analogue Tuner (FM/AM) 7.1 Analogue Input 4 Digital Co-axial, 4 Digital Optical
Video Inputs	2 Composite, 2 S-Video, 2 Component Video, 4 HDMI
Main Audio Outputs	7 Amplified Speaker Outputs 7.1 Preamp outputs
Main Video Output	1 HDMI
Recording Audio Outputs	1 Line Level Analogue 1 Digital Co-Axial, 1 Digital Optical
Other connections	1 1/4" / 6.35mm Headphone Output (32 To 600 ohms recommended) 1 IR Emitter In 1 RS232C 1 IEC type mains inlet
Standby power consumption	<1w
Quiescent power consumption	<70w
Max power consumption	700w
Dimensions - H x W x D	110 x 430 x 340mm
Weight	10kg (22lbs)

Cambridge Audio is a brand of Audio Partnership Plc
Registered Office: Gallery Court, Hankey Place
London SE1 4BB, United Kingdom
Registered in England No. 2953313

www.cambridge-audio.com

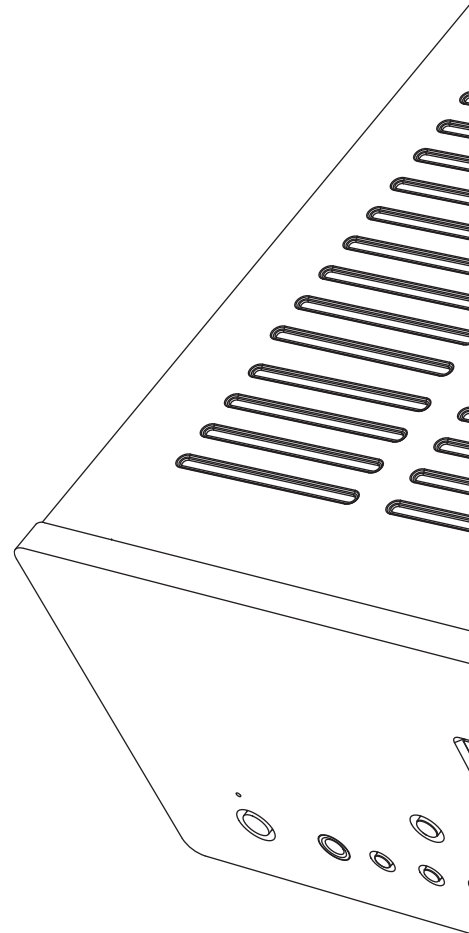

© 2011 Cambridge Audio Ltd

AP30836/1-A

Free Manuals Download Website

<http://myh66.com>

<http://usermanuals.us>

<http://www.somanuals.com>

<http://www.4manuals.cc>

<http://www.manual-lib.com>

<http://www.404manual.com>

<http://www.luxmanual.com>

<http://aubethermostatmanual.com>

Golf course search by state

<http://golfingnear.com>

Email search by domain

<http://emailbydomain.com>

Auto manuals search

<http://auto.somanuals.com>

TV manuals search

<http://tv.somanuals.com>