

CASIO®

Digital Camera

EX-FH20

User's Guide

E

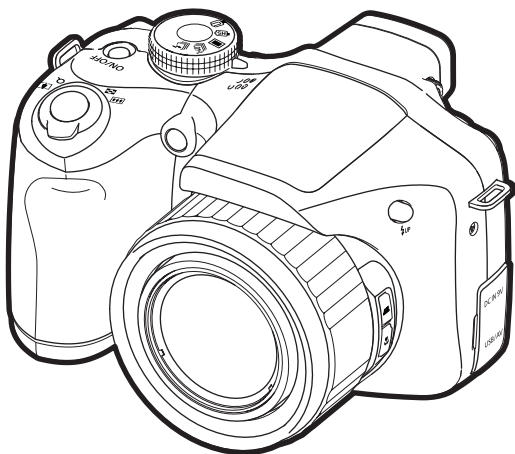

K1160PCM2DMX

Thank you for purchasing this CASIO product.

- Before using it, be sure to read the precautions contained in this User's Guide.
- Keep the User's Guide in a safe place for future reference.
- For the most up-to-date information about this product, visit the official EXILIM Website at <http://www.exilim.com/>

EXILIM

Download from www.Somanuals.com. All Manuals Search And Download.

Unpacking

As you unpack your camera, check to make sure that all items shown below are included. If anything is missing, contact your original retailer.

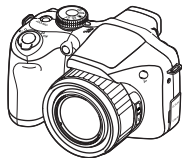

Digital camera



Alkaline batteries
(4 AA-size batteries)

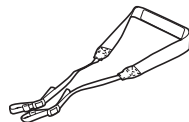

Strap



Lens cap/cap holder



USB cable

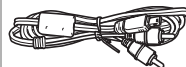

AV cable



CD-ROM



Basic Reference

Read this first!

- The contents of this manual are subject to change without notice.
- The contents of this manual have been checked at each step of the production process. Feel free to contact us if you notice anything that is questionable, erroneous, etc.
- Any copying of the contents of this User's Guide, either in part or its entirety, is forbidden. Except for your own personal use, any other use of the contents of this manual without the permission of CASIO COMPUTER CO., LTD. is forbidden under copyright laws.
- CASIO COMPUTER CO., LTD. shall not be held liable for any damages or lost profits suffered by you or any third party due to the use or malfunction of this product.
- CASIO COMPUTER CO., LTD. shall not be held liable for any damages, lost profits, or claims by third parties arising out of the use of YouTube Uploader for CASIO.
- CASIO COMPUTER CO., LTD. shall not be held liable for any damages or lost profits caused by loss of memory contents due to malfunction, repair, or any other reason.
- Note that the example screens and product illustrations shown in this User's Guide may differ somewhat from the screens and configuration of the actual camera.

LCD Panel

The liquid crystal panel used for the monitor screen and viewfinder employs high-precision technology that provides a pixel yield of 99.99%. This means that some very small number of pixels may not light or may remain lit at all times. This is due to the characteristics of the liquid crystal panel, and does not indicate malfunction.

Take test shots

Before shooting your final image, shoot a test shot to ensure that the camera is recording correctly.

Contents

Unpacking	2
Read this first!	3

■ Quick Start Basics 9

What is a digital camera?	9
What you can do with your CASIO camera	10
Attaching the Lens Cap and Strap	11
To load the batteries	12
■ Specifying the Battery Type	15
Configuring the Display Language the First Time You Turn On the Camera ..	15
Preparing a Memory Card	17
■ Supported Memory Cards	17
■ To load a memory card	17
■ To format (initialize) a new memory card	18
Turning the Camera On and Off	19
■ To turn power on	19
■ To turn off the camera	19
To shoot a snapshot	20
Holding the Camera Correctly	23
Viewing Snapshots	24
Deleting Images	25
■ To delete a single file	25
■ To delete all files	25
Snapshot Shooting Precautions	26
■ Auto Focus Restrictions	26

■ Snapshot Tutorial 27

Selecting a Recording Mode	27
Using the Control Panel	28
Selecting the Exposure Mode	29
Changing the Image Size	(Size) 31
Using Flash	(Flash) 35
Specifying ISO Sensitivity	(ISO) 38
Adjusting White Balance	(White Balance) 38
Correcting Image Brightness	(EV Shift) 40
Specifying the Metering Mode	(Metering) 41
Specifying the Auto Focus Area	(AF Area) 41
Changing the Control Panel Date/Time Style	43
Shooting with Zoom	43
■ Optical Zoom/Digital Zoom Switch Point	44
Selecting a Focus Mode	(Focus) 46
Locking the Auto Exposure and Auto Focus Setting	49
■ Specifying the [AEL] button Operation	49
Using Continuous Shutter	50

■ Using Flash Continuous Shutter	50
■ Using High-speed CS and Prerecord CS	51
■ Specifying the Method for Saving Continuous Shutter Images	53
■ Continuous Shutter Precautions	55

■ Recording Movies 56

To record a movie	56
■ Audio	57
Recording a High-definition Movie	59
Recording a High-speed Movie	59
Using Prerecord Movie (Prerecord (Movie))	61
Recording a Movie for YouTube (YouTube)	62
Turning Optical Zoom On or Off (Optical Zoom)	63

■ Using BEST SHOT 64

What is BEST SHOT?	64
■ Some Sample Scenes	64
To shoot with BEST SHOT	64
■ Creating Your Own BEST SHOT Setups	66
Shooting with High Speed Night Scene (High Speed Night Scene)	67
Shooting with High Speed Anti Shake (High Speed Anti Shake)	68
Shooting with Digital Panning (Digital Panning)	69
Isolating Moving Subjects (Multi-motion image)	69
■ Basic Multi-motion image Procedure	69
Shooting an Image in Accordance with Subject Movement (Move Out CS/Move In CS)	71

■ Advanced Settings 76

Using On-screen Menus	76
REC Mode Settings (REC)	78
■ Using the Self-timer (Self-timer)	78
■ Using the Auto Focus Assist Light (AF Assist Light)	79
■ Reducing the Effects of Camera and Subject Movement (Anti Shake)	79
■ Shooting with Face Detection (Face Detection)	80
■ Shooting with Continuous Auto Focus (Continuous AF)	81
■ Specifying the [AEL] button Operation (AE/AF Lock)	82
■ Configuring the Continuous Shutter Image Save Method (Save CS Images)	82
■ Turning Digital Zoom On or Off (Digital Zoom)	82
■ Shooting with Quick Shutter (Quick Shutter)	83
■ Turning on Image Review (Review)	83
■ Displaying the On-screen Grid (Grid)	83
■ Using Icon Help (Icon Help)	84
■ Configuring Power On Default Settings (Memory)	84
Image Quality Settings (Quality)	85
■ Specifying Snapshot Image Quality (☐ Quality (Snapshot))	85

■ Reducing Underexposure and Overexposure (Dynamic Range)	85
■ Specifying Flash Intensity (Flash Intensity)	86
■ Turning On Flash Assist (Flash Assist)	86
■ Using Built-in Color Filters (Color Filter)	86
■ Controlling Image Sharpness (Sharpness)	87
■ Controlling Color Saturation (Saturation)	87
■ Adjusting Image Contrast (Contrast)	87

■ Viewing Snapshots and Movies 88

Viewing Snapshots	88
Viewing a Movie	88
Viewing Continuous Shutter Images	89
■ Deleting Continuous Shutter Images	90
■ Dividing Up a CS Group	90
■ Copying a CS Group Image	91
Zooming an On-screen Image	92
Displaying the Image Menu	92
Viewing Snapshots and Movies on a TV Screen	93

■ Other Playback Functions (PLAY) 95

Playing a Slideshow on the Camera (Slideshow)	95
Creating a Snapshot of Movie Frames (MOTION PRINT)	96
Editing a Movie on the Camera (Movie Editing)	97
Adjusting White Balance (White Balance)	99
Adjusting the Brightness of an Existing Snapshot (Brightness)	100
Selecting Images for Printing (DPOF Printing)	100
Protecting a File Against Deletion (Protect)	101
Rotating an Image (Rotation)	102
Resizing a Snapshot (Resize)	102
Cropping a Snapshot (Trimming)	103
Copying Files (Copy)	103
Dividing Up a Continuous Shutter Group (Divide Group)	104
Copying a Continuous Shutter Group (Select Frame)	104

■ Printing 105

Printing Snapshots	105
Connecting Directly to a PictBridge Compatible Printer	106
Using DPOF to Specify Images to be Printed and the Number of Copies	108

■ Using the Camera with a Computer 111

Things you can do using a computer	111
Using the Camera with a Windows Computer	112
■ Viewing and Storing Images on a Computer	113
■ Playing Movies	116

■ Uploading Movie Files to YouTube	116
■ Viewing User Documentation (PDF Files)	118
■ User Registration	118
Using the Camera with a Macintosh	119
■ Connecting the Camera to Your Computer and Saving Files	119
■ Transferring Images Automatically and Managing Them on Your Macintosh	121
■ Playing a Movie	121
■ Viewing User Documentation (PDF Files)	122
■ User Registration	122
Files and Folders	123
Memory Card Data	124

■ Other Settings (Set Up) 126

Adjusting Monitor Screen Brightness (Screen)	126
Adjusting Viewfinder Brightness (EVF Brightness)	126
Configuring Camera Sound Settings (Sounds)	127
Specifying the File Name Serial Number Generation Rule (File No.)	127
Configuring World Time Settings (World Time)	128
Time Stamping Snapshots (Timestamp)	129
Setting the Camera's Clock (Adjust)	129
Specifying the Date Style (Date Style)	130
Specifying the Display Language (Language)	130
Configuring Sleep State Settings (Sleep)	131
Configuring Auto Power Settings (Auto Power Off)	131
Configuring [📷] and [▶] Settings (REC/PLAY)	132
Controlling Monitor Screen Priority (LCD Priority)	132
Configuring USB Protocol Settings (USB)	133
Selecting the Screen Aspect Ratio and Video Output System (Video Out)	133
Specifying the Battery Type (Battery Type)	134
Configuring a Startup Image (Startup)	134
Formatting Built-in Memory or a Memory Card (Format)	135
Resetting the Camera to Factory Defaults (Reset)	135

■ Configuring Monitor Screen Settings 136

Turning Display Information On and Off (Info)	136
Selecting Monitor Screen and Viewfinder Settings	136
Using the On-screen Histogram to Check Exposure (+Histogram)	137
■ How to Use the Histogram	138

■ Appendix 139

Precautions during Use	139
Power Supply	146
■ To replace the batteries	146
■ Battery Precautions	146

■ Using Household Power	150
Using a Memory Card	151
■ To replace the memory card	151
Computer System Requirements for Bundled Software	153
General Guide	154
Monitor Screen Contents	156
Reset Initial Default Settings	159
When things don't go right...	161
■ Troubleshooting	161
■ Display Messages	165
Number of Snapshots and Movie Recording Time	168
Specifications	171

Quick Start Basics

What is a digital camera?

A digital camera stores images on a memory card, so you can record and delete images a countless number of times.

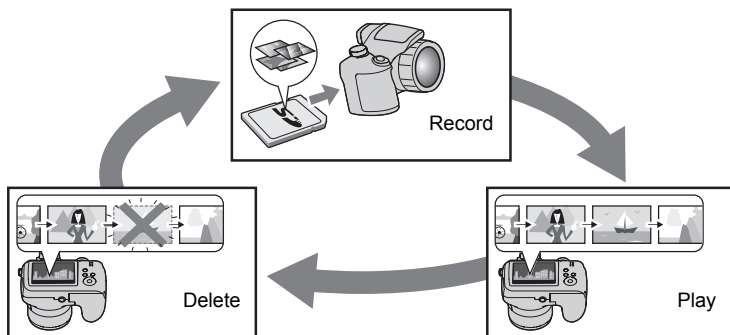

You can use the images you record in a variety of different ways.

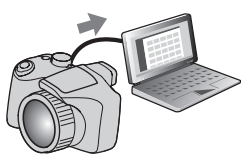

Store images on your computer.

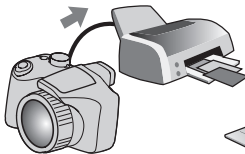

Print images.



Attach images to e-mail.

What you can do with your CASIO camera

Your CASIO camera is packed with a powerful selection of features and functions to make recording of digital images easier, including the following three main functions.



High-speed Continuous Shutter Prerecord (Still image)

Now you can shoot continuous high-resolution images at the amazing speed of 40 images per second. Prerecord (Still image) pre-records images to ensure you are almost never too late with the shutter button.

See page **50** for more information.



High-speed Movies

Movies can be recorded at up to 1000 frames per second. This makes it possible to clearly view phenomena that are invisible to the human eye, in slow motion.

See page **59** for more information.

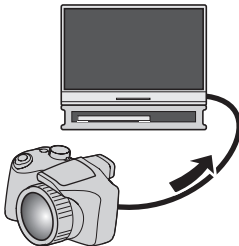

HD Movie Recording

You can record movies in high-quality HD. (1280×720 pixels 30 fps)

See page **59** for more information.

Attaching the Lens Cap and Strap

Be sure to attach the lens cap and strap to the camera before using it.

■ Attaching the Lens Cap

Always keep the lens cap on the lens whenever you are not using the camera. Always leave the lens cap on the lens when the camera is turned off and the lens is retracted.

- Attach the lens cap holder to the strap or the strap ring. This protects against accidental loss of the lens cap.
- Never turn on camera power with the lens cap affixed to the lens.

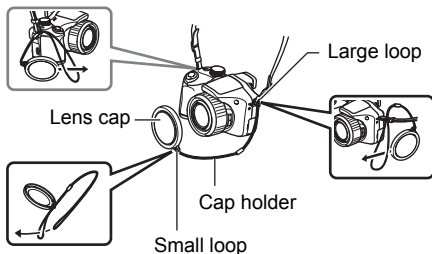

■ Attaching the strap

- Attach either end of the strap to the two strap rings on the sides of the camera as shown in the illustration.
- After you are finished pull on the strap to test it and to make sure it does not come loose.

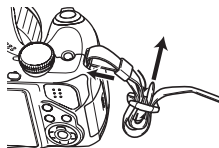

To load the batteries

Use one of the following battery types.

- Four AA-size alkaline batteries: LR6
Recommended
 - Panasonic LR6 (Panasonic Corporation)
 - DURACELL ULTRA (MX1500) (DURACELL, div of P&G Inc.)
- Four AA-size rechargeable Ni-MH (nickel-metal hydride) batteries: HR6
Recommended
 - SANYO eneloop (SANYO Electric Co., Ltd.)
 - DURACELL RECHARGEABLE (DURACELL, div of P&G Inc.)
 - ENERGIZER RECHARGEABLE (Energizer Holdings, Inc.)

* Proper operation cannot be guaranteed if you use any other type of battery other than that noted above.

IMPORTANT!

- When being powered by AA-size alkaline batteries (LR6), the camera may not operate at all at temperatures of 5°C (41°F) or lower.
- When charging rechargeable batteries, use only the charger specified for each battery type.
- Do not use manganese batteries to power this camera. Use only the specified types of AA-size batteries.

1. Open the battery cover.

Slide the lock in the direction indicated by the arrow and the battery cover will open.

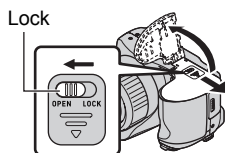

2. Load the batteries.

Be sure to keep all four batteries together as a set at all times, for both charging and powering the camera. Mixing batteries from different sets can shorten overall battery life and cause malfunction of the camera.

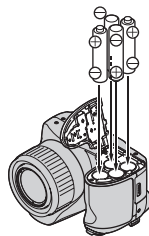

3. Close the battery cover.

- For information about how to replace the batteries, see page 146.

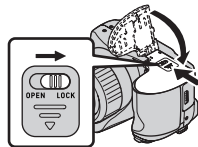

IMPORTANT!

- Before using the camera, you must specify the type of battery type (alkaline, Ni-MH) you are using. Specifying the wrong battery type setting will shorten the life of the batteries you are using. Make sure you specify the battery type setting correctly (page 15) whenever you change from one battery type to another.

About rechargeable batteries





Use only the rechargeable Ni-MH batteries that are specifically recommended for this camera. Proper camera operation is not guaranteed when other rechargeable batteries are used.



IMPORTANT!

- Batteries cannot be charged while they are loaded in the camera.

Checking Remaining Battery Power

As battery power is consumed, a battery indicator on the monitor screen indicates remaining power as shown below.

Remaining Power	High ←————→ Low
Battery Indicator	 →  →  → 
Indicator Color	Cyan → Amber → Red → Red

The flash will take longer than normal to charge if it is being used when the battery level indicator is showing  or  while "Alkaline" is selected for the "Battery Type" setting (page 15).

 indicates that the flash is disabled. Replace batteries as soon as possible.

- The level shown by the battery indicator may change when you switch between the REC mode and PLAY mode.
- Leaving the camera for about one day with no power supplied while the batteries are dead will cause its date and time settings to be cleared. You will have to re-configure the settings after power is restored.
- See page 174 for information about battery life and memory capacity.
- Certain camera operating conditions and battery can cause the battery level indicator to indicate the battery level incorrectly. In this case, the camera may suddenly shut down without retracting the lens. If this happens, replace or charge the batteries and configure the correct "Battery Type" setting.

Battery Power Conservation Tips

- When you do not need to use the flash, select  (flash off) for the flash setting (page 35).
- Enable the Auto Power Off and the Sleep features to protect against wasting battery power when you forget to turn off the camera (pages 131, 131).
- Select "Off" for "Continuous AF" (page 81).
- Turn off the LCD monitor screen and use the viewfinder (page 136).
- Avoid unnecessary optical zoom operations.

Specifying the Battery Type

Your camera is designed to optimize its operation in accordance with the type of batteries you are using to power it. Specifying the wrong battery type, can cause power to turn off without retracting the lens and incorrect indication of remaining battery power. Proper operation of the camera is not guaranteed when the wrong battery type is specified.

1. Press [ON/OFF] to turn on the camera.
2. Press [MENU].
3. Use [◀] and [▶] to select the “Set Up” tab.
4. Use [▲] and [▼] to select “Battery Type” and then press [▶].
5. Use [▲] and [▼] to select the type of battery you are using, and then press [SET].

Alkaline	AA-size alkaline (LR6)
Ni-MH	AA-size rechargeable Ni-MH (nickel metal hydride) (HR6)

Configuring the Display Language the First Time You Turn On the Camera

The first time you load batteries into the camera, a screen appears for configuring the display language, date, and time settings. Failure to set the date and time correctly will cause the wrong date and time data to be recorded with images.

1. Press [ON/OFF] to turn on the camera.

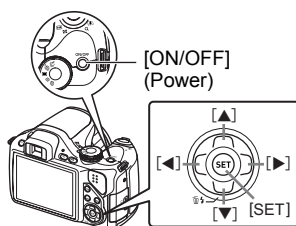

2. Use [▲], [▼], [◀], and [▶] to select the language you want and then press [SET].

3. Use [▲], [▼], [◀], and [▶] to select the area where you will be using the camera and then press [SET].

The selected area is highlighted in red.

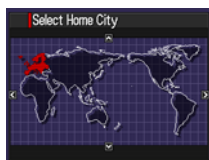

4. Use [▲] and [▼] to select the city where you will be using the camera and then press [SET].

5. Use [▲] and [▼] to select the summer time (DST) setting you want and then press [SET].

6. Use [▲] and [▼] to select a date style and then press [SET].

Example: 19. 12. 09

YY/MM/DD → 09/12/19

DD/MM/YY → 19/12/09

MM/DD/YY → 12/19/09

7. Set the date and the time.

Use [◀] and [▶] to select the setting you want to change and then use [▲] and [▼] to change it.

To switch between 12-hour and 24-hour format, press [BS].

8. Press [SET].

- If you make a mistake, you can change the settings later (pages 129, 130).

NOTE

- Each country controls its local time offset and the use of summer time, and so they are subject to change.

Preparing a Memory Card

Though the camera has built-in memory that can be used to store images and movies, you probably will want to purchase a commercially available memory card for greater capacity. The camera does not come with a memory card. Images recorded while a memory card is loaded are saved to the memory card. When no memory card is loaded, images are saved to built-in memory.

- For information about memory card capacities, see page 168.

Supported Memory Cards

- SD Memory Card
- SDHC Memory Card
- MMC (MultiMediaCard)
- MMC*plus* (MultiMediaCard*plus*)



Use one of the above types of memory card.

- Use only SD cards that are compliant with the SD Card Association specification.

Memory Card Handling Precautions

Certain types of cards can slow down processing speeds, and even can make it impossible to store High Quality movies correctly. Also, use of certain types of memory cards slows down data transfer and increases the time it takes to record movie data, which can result in movie frames being dropped. The “● REC” indicator on the monitor screen turns yellow to indicate that frames are being dropped. In order to avoid problems such as these, use of an Ultra High-Speed Type SD memory card is recommended. Note, however that CASIO makes no guarantees about the operation of any Ultra High-Speed Type SD memory card used with this camera.

To load a memory card

1. Press [ON/OFF] to turn off the camera and then open the memory card slot cover.

Pressing the memory card slot cover, slide it in the direction indicated by the arrow.

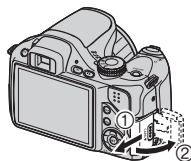

2. Load a memory card.

Positioning the memory card so its back is facing in the same direction as the monitor screen side of the camera, slide it into the card slot as far as it will go, until you hear it click securely into place.

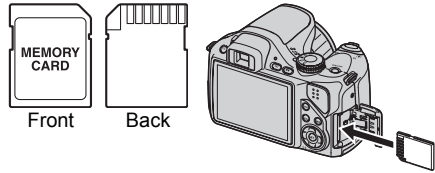

3. Close the memory card slot cover.

Pressing the memory card slot cover against the camera, slide it closed.

- For information about how to replace the memory card, see page 151.

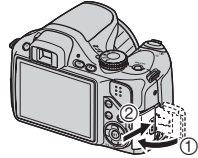

IMPORTANT!

- Never insert anything besides a supported memory card (page 17) into the memory card slot.
- Should water or any foreign object ever get into the card slot, immediately turn off the camera, remove the batteries, and contact your retailer or nearest CASIO authorized service center.

To format (initialize) a new memory card

You need to format a new memory card before using it for the first time.

1. Turn on the camera and press [MENU].

2. On the “Set Up” tab, select “Format” and then press [▶].

3. Use [▲] and [▼] to select “Format” and then press [SET].

IMPORTANT!

- Formatting a memory card that already has snapshots or other files on it, will delete its contents. Normally you do not need to format a memory card again. However, if storing to a card has slowed down or if you notice any other abnormality, re-format the card.
- Be sure to use the camera to format a memory card. Formatting a memory card on a computer and then using it in the camera can slow down data processing by the camera. In the case of an SD or SDHC memory card, formatting on a computer can result in non-conformity with the SD format, causing problems with compatibility, operation, etc.

Turning the Camera On and Off

To turn power on

To enter the REC mode, press [ON/OFF] (Power) or [RECORD] (REC). To enter the PLAY mode, press [PLAY] (PLAY).

The back lamp will light (green) momentarily and the camera will turn on. If you are entering the REC mode, the lens will extend from the camera at this time.

- Pressing [PLAY] (PLAY) while in the REC mode switches to the PLAY mode.
- The Sleep function or Auto Power Off (pages 131, 131) will turn off power automatically if you do not perform any operation for a preset amount of time.

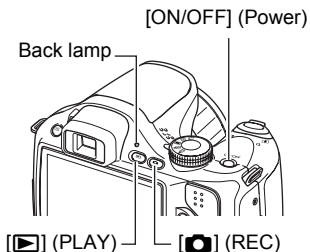

To turn off the camera

Press [ON/OFF] (Power).

- You can configure the camera so power does not turn on when you press [RECORD] (REC) or [PLAY] (PLAY). You also can configure the camera to turn off when you press [RECORD] (REC) or [PLAY] (PLAY) (page 132).

To shoot a snapshot

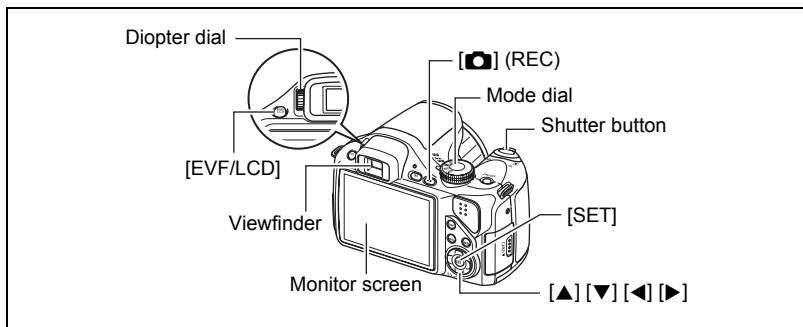

1. Remove the lens cap and then press [📷] (REC) to turn on the camera.
2. Set the mode dial to [📷] (Single Shot).
3. Press [▲] .
4. Use [▲] and [▼] to select the top option in the control panel (Exposure mode).



5. Use [◀] and [▶] to select [📷] (Auto) and then press [SET].
 - You can use either monitor screen or viewfinder to compose the image. Each press of the [EVF/LCD] button cycles through the available monitor screen and viewfinder on/off settings (page 136). If the image in the viewfinder appears blurry, use the diopter dial to adjust it.

Snapshot mode icon

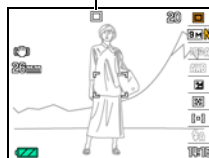

6. Point the camera at the subject.

You can zoom the image, if you want.

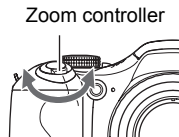

☒ Telephoto



☒ Wide Angle

7. Half-press the shutter button to focus the image.

When focus is complete, the camera will beep, the back lamp will light green, and the focus frame will turn green.

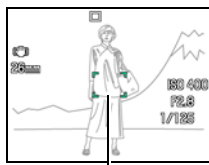
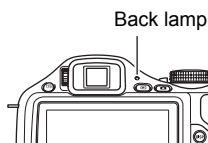

Focus frame

Half-press

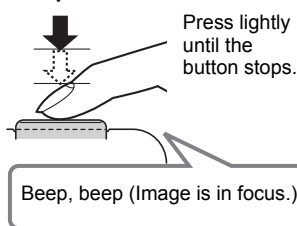

Press lightly until the button stops.

Beep, beep (Image is in focus.)

When you half-press the shutter button, the camera automatically adjusts exposure and focuses on the subject it is currently pointed at. Mastering how much pressure is required for a half-press and a full-press of the shutter button is an important technique for good-looking images.

8. Continuing to keep the camera still, press the shutter button the rest of the way down.

This records the snapshot.

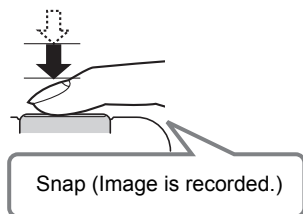

Full-press



Snap (Image is recorded.)



IMPORTANT!

- While the “Anti Shake” setting is “ Auto” or “ Camera AS”, half pressing the shutter will cause the camera to vibrate and emit an operation sound. This is normal and does not indicate malfunction (page 79).

■ Using Quick Shutter

Fully pressing the shutter button without waiting for Auto Focus to operate will record using Quick Shutter (page 83).

- With Quick Shutter, the camera focuses faster than normal Auto Focus, which means you can capture quick moving action more easily. Note, however, that some images may be out of focus when Quick Shutter is used.
- Whenever possible, take a little extra time to half-press the shutter button in order to ensure proper focus.

■ If the image does not focus...

If the focus frame stays red and the back lamp is flashing green, it means that the image is not in focus (because the subject is too close, etc.) Point the camera at the subject and try to focus again.

■ If the subject is not in the center of the frame...

“Focus lock” (page 48) is the name of a technique you can use when you want to shoot an image in which the subject to be focused on is not within the focus frame in the center of the screen.

Holding the Camera Correctly

Your images will not come out clearly if you move the camera when you press the shutter button. When pressing the shutter button, be sure to hold the camera as shown in the illustration near by, and keep it still by pressing your arms firmly against your sides as you shoot.

Holding the camera still, carefully press the shutter button and take care to avoid all movement as the shutter releases and for a few moments after it releases. This is especially important when available lighting is low, which slows down the shutter speed.

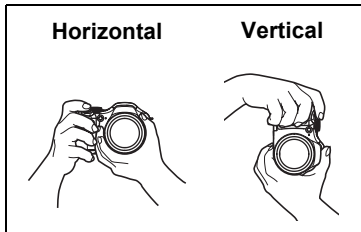

IMPORTANT!

- Never touch the lens-barrel unit, except for cleaning. Never hold the camera by the lens when aiming it or transporting it.

NOTE

- Take care that your fingers and the strap do not cover any of the areas indicated in the illustration.
- To protect against accidentally dropping the camera, attach the strap and make sure it is around your neck while you are operating the camera.
- Never swing the camera around by its strap.
- The supplied strap is intended for use with this camera only. Never use it for any other purpose.

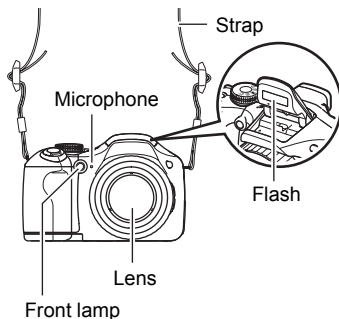

Viewing Snapshots

Use the following procedure to view snapshots on the camera's monitor screen.

- For information about how to play back movies, see page 88.
- For information about images recorded using continuous shutter (CS), see page 89.
- For information about high-speed movies, see page 59.

1. Press **[▶]** (PLAY) to enter the **PLAY** mode.

- This will display one of the snapshots currently stored in memory.
- Information about the displayed snapshot also is included (page 157).
- You also can clear the information to view only the snapshot.
- You can zoom in on the image by sliding the zoom controller towards **[4]** (page 92). If you are recording a snapshot that is very important to you, it is recommended that you zoom the image and check its details after recording it.



2. Use **[◀]** and **[▶]** to scroll between images.

- Holding down either button scrolls at high speed.



Deleting Images

If memory becomes full, you can delete images you no longer need in order to free up storage and record more images.

- Remember that a file (image) delete operation cannot be undone.
- For information about images recorded using continuous shutter (CS), see page 90.

To delete a single file

1. Press [▶] (PLAY) to enter the PLAY mode and then press [▼] (🗑️).

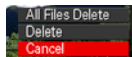

2. Use [◀] and [▶] to scroll through the files until the one you want to delete is displayed.

3. Use [▲] and [▼] to select "Delete" and then press [SET].

- To delete other files, repeat steps 2 and 3.
- To exit the delete operation, press [MENU].
- If a CS group (page 89) is displayed when you perform the above procedure, all of the images in the currently display CS group will be deleted.

To delete all files

1. Press [▶] (PLAY) to enter the PLAY mode and then press [▼] (🗑️).

2. Use [▲] and [▼] to select "All Files Delete" and then press [SET].

3. Use [▲] and [▼] to select "Yes" and then press [SET] to delete all files. This will cause the message "There are no files" to appear.

Snapshot Shooting Precautions

Operation

- Never open the battery cover while the back lamp is flashing green. Doing so can result in the image you just shot being saved incorrectly, damage to other images stored in memory, malfunction of the camera, etc.
- If unwanted light is shining directly onto the lens, shade the lens with your hand.

Monitor Screen when Shooting Snapshots

- The image that appears on the monitor screen is for image composition. The actual image will be recorded at the quality set for the image quality setting (page 85).

Shooting Indoors under Fluorescent Lighting

- Minute flickering of fluorescent lighting can affect the brightness or color of an image.





Auto Focus Restrictions

- Any of the following can make proper focus impossible.
 - Solid color wall or other very low contrast subject
 - Strongly back lit subject
 - Very shiny subject
 - Blinds or other subject with a repeating horizontal pattern
 - Multiple subjects at varying distances from the camera
 - Subject in a dark location
 - Subject that is too far away for light from the AF assist lamp to reach
 - Camera movement while shooting
 - Fast-moving subject
 - Subjects outside the focus range of the camera
- If you cannot focus properly, try using focus lock (page 48) or Manual Focus (page 46).

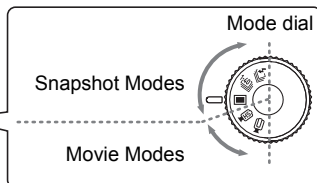
Selecting a Recording Mode

Your camera has a variety of different recording modes. Before shooting, use the mode dial to select the recording mode that suits the type of subject you are trying to record.



 Flash CS	This mode will record consecutive images while firing the flash. See page 50 for details.
 High-speed CS	This mode continues to shoot images as long as you keep the shutter button depressed, and you can change the shooting speed while recording is in progress. You can record up to 40 images. In this mode, half-pressing the shutter button starts continual pre-recording of images to a temporary buffer. Then when you press the shutter button the rest of the way down, the camera saves the buffer contents and perform real-time continuous shutter recording of new images until you release the shutter button. See page 51 for details.
 Single Shot	Continuous shutter recording is disabled when this mode is selected. Each press of the shutter button records a single image. See page 20 for details.
 HS	This mode records high-speed movies. See page 59 for details.
 HD/STD	This more records HD or standard movies. See page 59 for details.

Using the Control Panel

The control panel can be used to configure camera settings.

1. In the REC mode, press [▲].

2. Use [▲] and [▼] to select the setting you want to change.

This will select one of the control panel icons and display its settings.

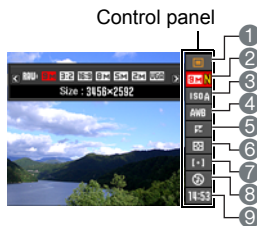
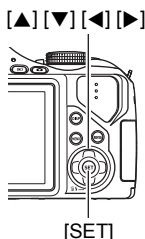

- ① Exposure mode (page 29)
- ② Image size/Quality* (pages 31, 85)
- ③ ISO sensitivity (page 38)
- ④ White balance (page 38)
- ⑤ EV shift (page 40)
- ⑥ Metering mode (page 41)
- ⑦ AF area (page 41)
- ⑧ Flash (page 35)
 - Continuous shutter (CS) speed (High-speed CS, Flash CS modes) (pages 50, 51)
- ⑨ Date/Time (page 43)
 - Prerecord (Still image) Time (High-speed CS mode) (page 51)
 - Flash continuous shutter (CS) images (Flash CS mode) (page 50)

* Image quality cannot be changed using the control panel.

- The content of the control panel is different when shooting a movie and when using some BEST SHOT scenes (Move Out CS, Move In CS, Multi-motion Image).

3. Use [◀] and [▶] to change the setting.

4. If you want to configure another setting, repeat steps 2 and 3.

5. After all of the settings are the way you want, press [SET].

This will apply the settings and return to the REC mode.

NOTE

- You also can configure settings other than those listed above (page 76).

Selecting the Exposure Mode

Your camera has a variety of different exposure modes. Before shooting an image, select the exposure mode that suits the type of subject you are shooting.

1. In the REC mode, press [▲] .
2. Use [▲] and [▼] to select the top option in the control panel (Exposure mode).
3. Use [◀] and [▶] to select the setting you want and then press [SET].

Auto

Use this setting for easy image recording. This is the mode you normally should use (page 20).

BS BEST SHOT

Simply select one of a collection of built-in sample scenes and the camera sets up automatically for beautiful images every time (page 64).

A (Aperture Priority) mode

In this mode, you select the aperture and other settings are adjusted accordingly.

Use [◀] and [▶] to select the desired aperture value.

- The ISO sensitivity, shutter speed and aperture value on the monitor screen will turn orange when you half-press the shutter button if the image is over-exposed or under-exposed.
- If you are using manual focus (page 46), you also can press [SET], select "Focus", and then use [◀] and [▶] to focus manually.



Aperture value

S S (Shutter Speed Priority) mode

In this mode, you select the shutter speed and other settings are adjusted accordingly.

Use [◀] and [▶] to select the desired shutter speed.

- The ISO sensitivity, shutter speed and aperture value on the monitor screen will turn orange when you half-press the shutter button if the image is over-exposed or under-exposed.
- If you are using manual focus (page 46), you also can press [SET], select "Focus", and then use [◀] and [▶] to focus manually.



Shutter speed

M M (Manual Exposure) mode

This mode gives you total control over aperture and shutter speed settings.

- ① Press [SET], select the aperture setting, and then use [◀] and [▶] to change it.
 - ② Press [SET], select the shutter speed setting, and then use [◀] and [▶] to change it.
- If you are using manual focus (page 46), you also can press [SET], select "Focus", and then use [◀] and [▶] to focus manually.



Aperture value

Shutter speed



IMPORTANT!

- You may not be able to achieve the brightness you want when shooting an image that is very dark or very bright. If this happens, use the M mode to adjust the aperture or shutter speed manually.
- Due to the characteristics of the camera's semiconductor, slow shutter speeds can cause digital noise in images. The camera performs an automatic noise reduction process whenever the shutter speed is 1 second or slower. Storage of images shot at slower shutter speeds takes longer because of the time required for noise reduction. Do not perform any key operation while the image storage operation is in progress.
- Due to the characteristics of the imaging element used by the camera, very fast moving objects in an image may appear distorted.
- Depending on the shutter speed setting and the recording mode you used, the brightness of what appears on the monitor screen when you record the image may be different from the brightness of the recorded image.
- Image AS (page 79) does not work in the S mode and M mode. You can, however, turn on Camera AS, if you like.
- When recording with some modes, light source flicker can cause horizontal bands to appear in the image.

Changing the Image Size (Size)

■ Pixels

A digital camera image is a collection of small dots called "pixels". The more pixels there are in an image, the more detail there will be. However, you generally can do with fewer pixels when printing an image (L size) through a print service, attaching an image to e-mail, when viewing the image on a computer, etc.

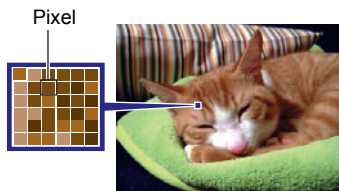

■ About image sizes

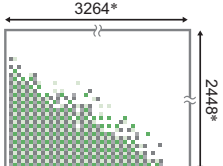
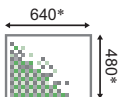

The size of an image indicates how many pixels it contains, and is expressed as horizontal pixels×vertical pixels.

8M (3264×2448) size image = Approximately 8 million pixels	 A diagram of a large image with a green and white pixelated pattern. The width is labeled as 3264* and the height as 2448*.
VGA (640×480) size image = Approximately 300,000 pixels	 A diagram of a smaller image with a green and white pixelated pattern. The width is labeled as 640* and the height as 480*.

* Unit: pixels

Image Size Selection Tips

Note that larger images have more pixels, so they take up more memory space.

Large Number of Pixels	More detail, but takes up more memory. Best when you plan to print large-size prints (such as A3 size).	 A high-resolution image showing two small, fluffy puppies, one white and one brown, sitting together.
Small Number of Pixels	Less detail, but takes up less memory. Best when you want to send images by e-mail, etc.	 A low-resolution image of the same two puppies, appearing more pixelated and less detailed.

- For information about image size, image quality, and number of images that can be stored, see page 168.
- For information about movie image size, see page 56.
- For information about resizing existing snapshots, see page 102.

■ To select the image size

1. In the REC mode, press [▲] .

2. Use [▲] and [▼] to select the second control panel option from the top (Image Size).

3. Use [◀] and [▶] to select an image size and then press [SET].

Image Size (Pixels)	Suggested Print Size and Application	Description
RAW+	RAW+JPEG (Select when you want to process image data yourself.)	Saves the image as both normal JPEG data and RAW image data. A 9M size image (3456×2592 pixels) is stored for the JPEG data. RAW image data is unprocessed data output by the image sensor and is saved in DNG (digital negative) format. Though the image of such data is virtually undeteriorated, it cannot be viewed on the camera's monitor screen or printed. After transferring RAW image data to your computer, you can use software that supports the general-purpose DNG format to process the image and convert it to image data that suits your particular needs. Since both RAW image data and JPEG data are saved by the camera, you can view the JPEG version on the camera's monitor screen.
9M (3456×2592)	A3 Print	Good detail for better clarity even for images cropped (page 103) from the original
3:2 (3456×2304)	A3 Print	
16:9 (3456×1944)	HDTV	
8M (3264×2448)	A3 Print	Good detail
7M (3072×2304)	A3 Print	
5M (2560×1920)	A3 Print	

Image Size (Pixels)	Suggested Print Size and Application	Description
2M (1600×1200)	3.5"×5" Print	Best when preserving memory capacity is relatively more important than image quality.
VGA (640×480)	E Mail	Image files are smaller, which is better when attaching images to e-mail. However, images are relatively coarser.

- The initial factory default image size setting is 9M (9 million pixels).
- Selecting 3:2 (3456×2304 pixels) records images with an aspect ratio of 3:2, which matches the standard aspect ratio of print paper.
- The letters "HDTV" stand for "High Definition Television". An HDTV screen has an aspect ratio of 16:9, which makes them wider than the usual 4:3 aspect ratio of television screens of the past. Your camera can record images that are compatible with the aspect ratio an HDTV screen.
- You should regard the print paper sizes suggested here as guidelines only (200 dpi print resolution).
- You can shoot directly to RAW image data only while the  (Single Shot) is selected with the Mode dial and "RAW+" is selected as the image size.
- Available image sizes are limited for some functions as noted below.

RAW+, 9M, 3:2, 16:9	These options cannot be selected when using High-speed CS, Flash CS, and some* BEST SHOT scenes.
8M	This option cannot be selected when using some* BEST SHOT scenes, and High-speed CS while the High-speed CS fps setting is 40 fps.
7M	This option cannot be selected when using Single Shot or Flash CS, and High-speed CS while the High-speed CS fps setting is 30 fps or less.

* Applicable BEST SHOT scenes: "Move In CS", "Move Out CS", "Digital Panning", "High Speed Anti Shake", "High Speed Night Scene", "Multi-motion Image"

Using Flash (Flash)

1. Press \uparrow (Flash up) to open the flash unit.

- The flash will not fire if the flash unit is not open.

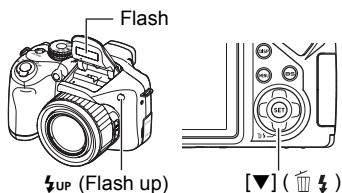

2. In the REC mode, press [\downarrow] (Flash down) once.

3. Use [\leftarrow] and [\rightarrow] to select the flash setting you want and then press [SET].

\uparrowA Auto Flash	Flash fires automatically in accordance with exposure (amount of light and brightness) conditions.
OFF Flash Off	Flash does not fire.
ON Flash On	Flash always fires. This setting can be used to brighten a subject that normally comes out dark due to daylight or backlight (daylight synchro flash).
RE Red Eye Reduction	Flash fires automatically. This type of flash can be used to reduce the chance of redness in the subject's eyes.

4. Press the shutter button to shoot.

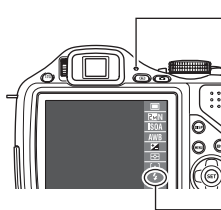

Back lamp

Flashes red while the flash is charging to indicate that image recording is disabled.

ON indicates the flash will fire.

- Note that the flash unit does not close automatically. After you are finished using it, you need to close it by hand.

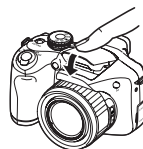





IMPORTANT!

- The camera will not release the shutter unless the flash unit is raised when any one of the following conditions exists. Be sure to raise the flash unit whenever shooting with flash is required.
 - When shooting with Flash CS, which requires the flash to fire
 - When “Flash On” is selected for the flash mode
 - When “Auto Flash” or “Red-Eye Reduction” is selected for the flash mode and the camera judges that flash is required

NOTE

- Take care to ensure nothing is close to or in contact with the flash unit when it fires. Also make sure that the flash unit and the area around it is not dirty. Objects, dust, or dirt near the flash unit can be burned when the flash fires.
- Take care so your fingers and the strap do not block the flash.
- The desired effect may not be obtained when the subject is too far away or too close.
- Flash charging time depends on operating conditions (battery condition, ambient temperature, etc.) With new batteries it takes about 5 seconds.
- Flash charging time and operation are affected by the remaining battery capacity. The flash will take longer than normal to charge if it is being used when the battery level indicator is showing  or  while “Alkaline” is selected for the “Battery Type” setting (page 15).
-  indicates that the flash is disabled. Replace batteries as soon as possible.
- Shooting with flash turned off when lighting is dim results in a slow shutter speed, which can cause image blur due to camera movement. Under such conditions, secure the camera with a tripod, etc.
- With red eye reduction, the flash is fired automatically in accordance with exposure. It does not fire in areas where lighting is bright.
- The presence of outdoor sunlight, fluorescent lighting, or some other light source can cause abnormal image colors.
- Select “Flash Off” for the flash setting when shooting in areas where flash photography is prohibited.
- Approximate Flash Range (ISO Sensitivity: AUTO / Recording mode: Single Shot)
Wide Angle: 0.4 m to 7.0 m (1.3' to 23.0')
Telephoto: 1.3 m to 4.4 m (4.3' to 14.4')
- * The above values depend on the optical zoom setting.

Red-eye Reduction

Using the flash to shoot at night or in a dimly lit room can cause red spots inside the eyes of people who are in the image. This is caused when the light from the flash reflects off of the retina of the eye. When red-eye reduction is selected as the flash mode, the camera fires a pre-flash to cause the irises in the eyes of any people in the image to close, which reduces the chance of red eye.

Note the following important points when using red-eye reduction.

- Red-eye reduction does not work unless the people in the image are looking directly at the camera (flash).
- Red-eye reduction may not work very well if the subjects are located far away from the camera.

Other Useful Flash Features

- Changing the flash intensity (page 86)
- Compensating for insufficient flash intensity (page 86)

Specifying ISO Sensitivity (ISO)

ISO sensitivity is a measure of sensitivity to light.

1. In the REC mode, press [▲] .
2. Use [▲] and [▼] to select the third control panel option from the top (ISO Sensitivity).
3. Use [◀] and [▶] to select the setting you want and then press [SET].

AUTO	Adjusts sensitivity automatically according to conditions		
ISO 100	Lower sensitivity	Slow shutter speed	Less noise
ISO 200	↑ ↓	↑ ↓	↑ ↓
ISO 400			
ISO 800	Higher sensitivity	Fast shutter speed (Set for shooting in dimly lit areas.)	Some coarseness (increased digital noise)
ISO 1600			

- The current ISO sensitivity setting is used when shooting a High-speed Movie in the M (manual exposure) mode. For all other types of movies, "AUTO" is used as the ISO sensitivity setting.
- "Image AS" (page 79) can be used only when the ISO sensitivity setting is "AUTO".
- An ISO setting of ISO 400 or greater is not supported when the "Image Size" setting is "RAW+". If the ISO setting is "ISO 400" or greater when you change the "Image Size" setting to "RAW+", an ISO setting of ISO 200 will be used for recording.

Adjusting White Balance (White Balance)

You can adjust white balance to match the source of light available where you are shooting and avoid the blue cast that results when shooting outdoors when it is cloudy, and the green cast that results when shooting under fluorescent lighting.

1. In the REC mode, press [▲] .
2. Use [▲] and [▼] to select the fourth control panel option from the top (White Balance).

3. Use [◀] and [▶] to select the shooting condition you want and then press [SET].

AWB Auto WB	Configures the camera to adjust white balance automatically
☀ Daylight	For shooting outdoors on a clear day
☁ Overcast	For shooting outdoors on an overcast rainy day, in the shade, etc.
🌳 Shade	For shooting on a clear day in the shade of trees or buildings
☀N Day White Fluorescent	For shooting under white or day white fluorescent lighting
☀D Daylight Fluorescent	For shooting under daylight fluorescent lighting
💡 Tungsten	For shooting under light bulb lighting
MWB Manual WB	<p>For configuring the camera manually to suit a particular light source.</p> <p>① Select “MWB Manual WB”.</p> <p>② Under the lighting conditions you plan to use when shooting, point the camera at a blank white piece of paper so it fills the entire monitor screen and then press the shutter button.</p> <p>③ Press [SET].</p> <p>The white balance setting is retained even if you turn off the camera.</p>

Blank white paper

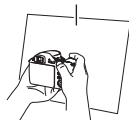

- When “**AWB** Auto WB” is selected for the white balance setting, the camera automatically determines the white point of the subject. Certain subject colors and light source conditions can cause problems when the camera tries to determine the white point, which makes proper white balance adjustment impossible. If this happens, select the white balance setting that matches your shooting conditions (Daylight, Overcast, etc.)

Correcting Image Brightness (EV Shift)

You can manually adjust an image's exposure value (EV value) before shooting it.

- Exposure Compensation Range: -2.0EV to $+2.0\text{EV}$
- Unit: $1/3\text{EV}$

1. In the REC mode, press [▲].

2. Use [▲] and [▼] to select the fifth control panel option from the top (EV Shift).

3. Use [◀] and [▶] to adjust the exposure compensation value.

[▶]: Increases the EV value. A higher EV value is best for light-colored subjects and backlit subjects.

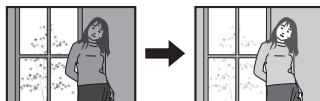

[◀]: Decreases the EV value. A lower EV value is best for dark-color subjects and for shooting outdoors on a clear day.



To cancel exposure compensation, change the EV value to 0.0.



Exposure compensation value

4. Press [SET].

This applies the exposure compensation value. The exposure compensation value you set remains in effect until you change it.

NOTE

- When shooting under very dark or very bright conditions, you may not be able to obtain satisfactory results even after performing exposure compensation.



Specifying the Metering Mode (Metering)

The metering mode determines what part of the subject is metered for exposure.

1. In the REC mode, press [▲] .

2. Use [▲] and [▼] to select the sixth control panel option from the top (Metering).

3. Use [◀] and [▶] to select the setting you want and then press [SET].

 Multi	Multi-pattern metering divides the image into sections and measures the light in each section for a balanced exposure reading. This type of metering provides error-free exposure settings for a wide range of shooting conditions.
 Center Weighted	Center weighted metering concentrates on the center of the focus area to measure light. This type of metering is best when you want some level of control over contrast.
 Spot	Spot metering takes readings at a very small area. Use this metering method when you want exposure to be set according to the brightness of a particular subject, without being affected by surrounding conditions.

Specifying the Auto Focus Area (AF Area)





You can use the following procedure to change the Auto Focus metering area for shooting snapshots.

- When recording movies, the AF metering area is always “ Spot”.



1. In the REC mode, press [▲] .

2. Use [▲] and [▼] to select the third control panel option from the bottom (AF Area).

3. Use [◀] and [▶] to select the setting you want and then press [SET].

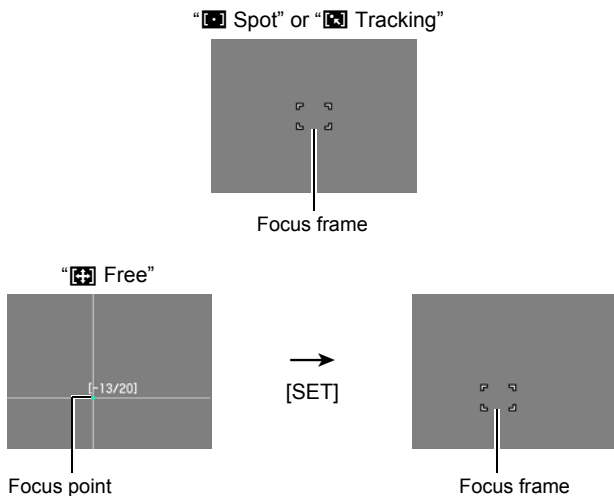
 Spot	This mode takes readings of a small area in the center of the image. This setting works well with focus lock (page 48).
 Free	You can move the focus frame by using [▲], [▼], [◀], and [▶] to move the focus point and then pressing [SET]. To change the focus point position, select “  Free” again and then use [▲], [▼], [◀] and [▶] to select the position you want.
 Tracking	When you half-press the shutter button while this setting is selected, the focus frame will follow the movement of the subject.



- “ Tracking” cannot be used in combination with the following features. Prerecord (Still image), YouTube, Prerecord (Movie), some BEST SHOT scenes (Move Out CS, Move In CS, Multi-motion Image)
- “ Free” cannot be selected for the AF area while Face Detection is enabled.

Changing the Control Panel Date/Time Style

1. In the REC mode, press [▲] .
2. Use [▲] and [▼] to select the bottom control panel option (Date/Time).
You can use [◀] and [▶] to select date or time display.

NOTE

- You can select either of two display styles (page 130) for the date: Month/Day or Day/Month.
- The time is displayed using 24-hour format.

Shooting with Zoom

Your camera provides you with 20X optical zoom (that changes the lens focal distance), which can be used in combination with digital zoom (that digitally processes the center portion of the image to enlarge it) for total zoom capabilities of 20X to 318.8X. The image deterioration point depends on the image size (page 44).

1. In the REC mode, slide the zoom controller to zoom.



[▲] Telephoto

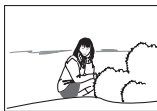

[▼] Wide Angle

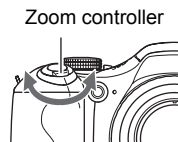

[▲] (Telephoto) : Enlarges the subject and narrows the range

[▼] (Wide Angle): Reduces the size of the subject and broadens the range

- Sliding the zoom controller as far as it will go in either direction will zoom at high speed.

2. Press the shutter button to shoot the image.

NOTE

- The higher the digital zoom factor, the coarser the recorded image. Note that the camera also has a function that lets you record using digital zoom without image deterioration (page 44).
- Use of a tripod is recommended to protect against image blur due to camera movement when shooting with telephoto.
- Performing a zoom operation changes the lens aperture.
- Digital zoom is disabled while "RAW+" is selected for the "Image Size" setting (page 33).
- Both optical zoom and digital zoom are disabled during High-speed Movie recording.
- Both optical zoom and digital zoom are disabled when "Super Macro" is selected as the focus mode.

Optical Zoom/Digital Zoom Switch Point

If you hold the zoom controller towards **[T]** (Telephoto), the zoom operation will stop when the optical zoom factor reaches its maximum. Momentarily releasing the zoom controller and then holding it again towards **[T]** (Telephoto) will switch to digital zoom, which you can use to set an even higher zoom factor.

- If you do want to use digital zoom, change the "Digital Zoom" setting to "On" (page 82).
- During zoom, a zoom bar on the monitor screen shows the current zoom setting.

Focal distance

(Converted to 35mm film format.)

- * The displayed focal distance (angle of view) and the actual angle of view may be different when using continuous shutter (except in the Single Shot Mode), when shooting a movie, and when using some BEST SHOT scenes.

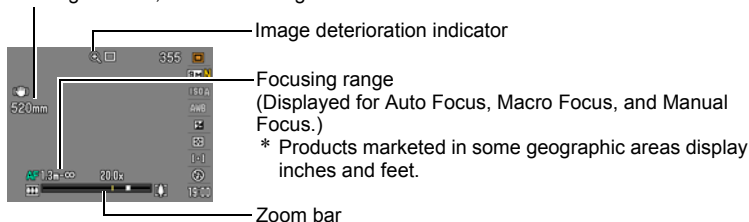

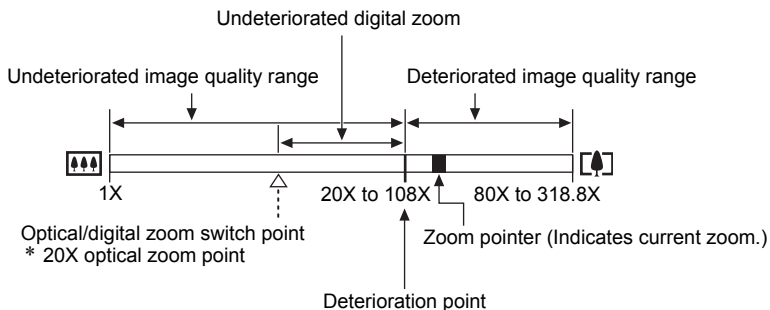

- The deterioration point depends on the current image size setting (page 31). The smaller the image size setting, the higher the zoom factor you can use before reaching the image deterioration point.
- Though digital zoom generally causes a deterioration of image quality, some digital zoom without image deterioration is possible with image sizes of "8M" and smaller. The range in which you can use digital zoom without image deterioration is indicated on the display. The deterioration point depends on the image size.
- The maximum zoom factor using optical zoom (page 63) and digital in combination when "HD/STD" is selected as the movie mode is 318.8X.
- When "HD/STD" is selected as the movie mode, minimal deterioration up to a zoom factor of 108X is possible only for STD shooting.

Image Size	Maximum Zoom Factor	Deterioration Point
9M	80X	20X
3:2	80X	20X
16:9	80X	20X
8M	84.6X	21.2X
7M	90X	22.4X
5M	108X	27X
2M	172.4X	43.2X
VGA	318.8X	108X

Selecting a Focus Mode (Focus)

Each press of  (Focus) will cycle through the available focus mode settings.

- Whenever you change to another focus mode, the previous focus point is saved, so you can use Auto Focus for initial focus, and then switch to Manual Focus to make fine adjustments.

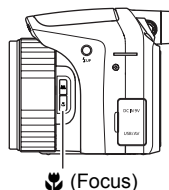

Settings	Type of Shot	Focus Mode		Approximate Focus Range*	
		Snapshot	Movies	Snapshot	Movies
AF Auto Focus	General recording	Automatic		40 cm to ∞ (infinity) (1.3' to ∞)	
M Macro Focus	Close ups	Automatic		12 cm to 50 cm (4.7" to 19.7")	
MS Super Macro	Extreme close ups	Automatic		1 cm to 12 cm (0.4" to 4.7")	
MF Manual Focus	When you want to focus manually	Manual		12 cm to ∞ (infinity) (4.7" to ∞) 1 cm to ∞ (infinity) (0.4" to ∞) (when the zoom focal distance is equivalent to 57 mm in 35 mm film format)	

- Range is affected by optical zoom.

* The focus range is the distance from the lens surface.

To focus with manual focus

1. On the monitor screen, compose the image so the subject you want to focus on is within the yellow boundary.

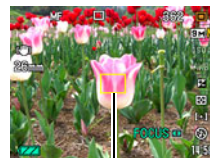

Yellow boundary

2. Watching the image on the monitor screen use  and  to adjust focus.

- At this time the image that is within the boundary will enlarge and fill the monitor screen, which aids in focusing. If you do not perform any operation for two seconds while the enlarged image is displayed, the screen in step 1 will re-appear.
- When the exposure mode setting is **A**, **S**, or **M**, or when "30-210 fps" is selected for High-speed Movie recording, you need to press [SET] and then selected "FOCUS" before performing step 2 of the above procedure.

NOTE

- When proper focusing is not possible because the subject is closer than the Auto Focus range, the camera will switch to the Macro Focus range (which does not include the Super Macro range) automatically (Auto Macro).
- When proper focusing is not possible because the subject is further than the macro range (which does not include the Super Macro range), the camera will switch to the Auto Focus range automatically (Auto Macro).
- Auto Macro can be used when recording snapshots only.
- Use of the flash together with Macro Focus can cause the light of the flash to become blocked, which may result in unwanted lens shadows in your image.
- Whenever you perform an optical zoom operation while shooting with Auto Focus, Macro Focus, or Manual Focus, a value will appear on the monitor screen to tell you the focus range, as shown below.

Example: ○○ cm to ∞



* ○○ is the actual focusing range value.

* Products marketed in some geographic areas display inches and feet.

- Always be sure to select Auto Focus (AF) as the focus mode whenever using face detection (page 80).
- The following functions are disabled when shooting with Super Macro.
 - Zoom (both optical and digital)
 - Auto Macro
 - Flash
 - Flash CS
- The large zoom factor capabilities of this camera can result in images being out of focus if the camera is moved while shooting with fixed focus. Whenever possible, mount the camera on a tripod or secure it using some other means before focusing. If the image is out of focus, either refocus or change to manual focus (MF) to adjust focus as required.

Using Focus Lock

“Focus lock” is a technique you can use when you want to compose an image in which the subject you want to focus on is not within the focus frame in the center of the screen.

- To use focus lock, select “ Spot” or “ Tracking” for the Auto Focus area (page 41).

1. Align the monitor screen’s focus frame with the subject you want to focus on and then half-press the shutter button.

2. Keeping the shutter button half-pressed (which maintains the focus setting), move the camera to compose the image.

- When “ Tracking” is selected as the Auto Focus area, the focus frame will move automatically and follow the subject.

3. When you are ready to shoot the image, press the shutter button the rest of the way down.

Subject to be focused on

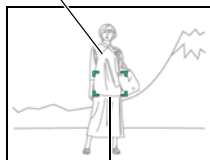

Focus frame



NOTE

- Focus lock also locks exposure (AE).

Locking the Auto Exposure and Auto Focus Setting

Pressing [AEL] temporarily locks the current exposure and/or focus settings. Press [AEL] again to unlock the settings.

- Pressing [AEL] while the shutter button is half-pressed will lock the current exposure or focus setting.

[AEL]

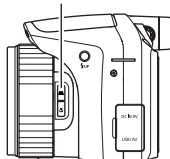

Specifying the [AEL] button Operation

Use the following procedure to specify the operation that the [AEL] button performs.

1. In the REC mode, press [MENU].
2. Use [◀] and [▶] to select "REC".
3. Use [▲] and [▼] to select "AE/AF Lock" and then press [▶].
4. Use [▲] and [▼] to change the setting, and then press [SET] to apply it.

AE Lock	Exposure lock
AF Lock	Focus lock
AE/AF Lock	Exposure and focus lock

NOTE

- AE Lock and AF Lock are not supported while "[Tracking]" is selected for the "AF Area" setting.
- Performing an EV shift operation while AE Lock is in effect will cause Auto Exposure to be unlocked.
- Performing a zoom operation while AF Lock and AE Lock are in effect will cause both of them to become unlocked.
- AE Lock and AF Lock are not supported during movie recording.

Using Continuous Shutter

Using Flash Continuous Shutter

This mode will record consecutive images while firing the flash.

- You can select a CS speed of 1 image, 3 images, or 5 images per second.
- In this mode, you can specify consecutive recording of three to 10 images. Recording will stop if you release the shutter button.

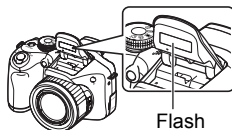

1. Set the mode dial to  (Flash CS).

2. Press  (Flash up) to open the flash unit.

3. Use [▲] and [▼] to select the second control panel option from the bottom (Flash CS fps).

4. Use [◀] and [▶] to select the continuous shutter (CS) speed you want and then press [SET].

Flash Unit CS Speeds



5. Use [▲] and [▼] to select the bottom item (Flash CS Images).

6. Use [◀] and [▶] to select the number of flash continuous shutter (CS) images you want to shoot and then press [SET].



You can select any one of the following values: 3, 5, 7, or 10.

7. Press the shutter button to shoot.

8. If you keep the shutter button depressed, the camera will shoot the number of images you specified. Recording will stop if you release the shutter button before the specified number of images is reached.

9. Save the CS images (page 53).

NOTE

- The back lamp flashes red while the flash is charging. You will not be able to perform further Flash CS shooting until charging is complete, which is indicated when the back lamp stops flashing and goes out.
- When shooting with Flash CS, there may be times when a message appears telling you to wait, because you have reached the limit of the flash. This is to protect the flash from damage. You will be able to resume using flash after the message disappears.

Using High-speed CS and Prerecord CS

In this mode, half-pressing the shutter button starts continual pre-recording of images to a temporary buffer. Then when you press the shutter button the rest of the way down, the camera stores what is currently in the buffer and starts continuous shutter recording of new images. Recording continues until you release the shutter button or until a total of up to 40 images (buffer images plus new images) are recorded (Prerecord (Still image)). You can configure this mode to specify how many of the 40 images are recorded in the buffer and how many are recorded after you fully press the shutter button. You can use this mode when you want to make sure you do not miss fast-moving action.

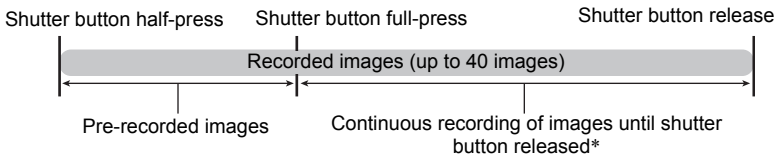

* You can record up to 40 images (pre-recorded buffer images plus real-time images) for each Prerecord (Still Image) operation.

- You can specify anywhere from one second up to 40 seconds as the continuous shutter shooting time, which is the amount of time of the pre-record buffer plus the amount of time that continuous shutter recording is performed after the shutter button is pressed all the way. The maximum shooting time depends on the selected CS speed. You can select a CS speed in the range of 1 to 40 fps.
40 images per second (40 fps) : You can shoot up to 40 images in one second.
1 image per second (1 fps) : You can shoot up to 40 images over 40 seconds.
- You can configure the mode so up to 39 images are pre-recorded to the buffer until you fully press the shutter button.
- The minimum interval for images pre-recorded in the buffer is 0.5 seconds and the minimum number of pre-recorded images is one.

1. Set the mode dial to  (High-speed CS).

2. Use [▲] and [▼] to select the second control panel option from the bottom (High-speed CS fps).

3. Use [◀] and [▶] to select the continuous shutter (CS) speed you want and then press [SET].

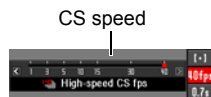

4. Use [▲] and [▼] to select the bottom control panel option (Prerecord (Still image) Time).

5. Use [◀] and [▶] to specify how many of the 40 images and for how long images should be pre-recorded in the buffer.

- Prerecord (Still image) shooting is not performed when the number of buffer images and the recording time are both zero.

Number of pre-record images and pre-record time

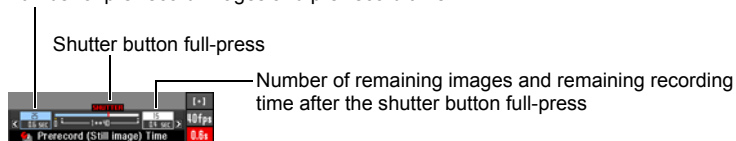

6. Press [SET].

- The approximate number of recordable CS images will appear on the monitor screen.

Number of recordable CS images (If you are not performing Prerecord CS, the allowable continuous shutter time also is displayed.)



Remaining snapshot memory capacity

7. Half-press the shutter button.

This will cause the camera to start pre-recording images.

- The camera will not emit a shutter sound when you half-press the shutter button while Prerecord (Still image) is selected.

8. Press the shutter button the rest of the way down.

This will record the images in the pre-record buffer and start recording new images in real-time. Images continue to be shot as long as you keep the shutter button depressed.

9. Image recording will stop when you release the shutter button or after a total of 40 images are recorded.

10. Save the CS images (page 53).

Specifying the Method for Saving Continuous Shutter Images

You can specify the method to use for saving images recorded with the following continuous shutter (CS) modes.

Flash CS, High-speed CS

1. In the REC mode, press [MENU].

2. Use [◀] and [▶] to select "REC".

3. Use [▲] and [▼] to select "Save CS Images", and then press [▶].

4. Use [▲] and [▼] to change the setting.

Normal (Batch)

All images that were shot are saved after the continuous shutter operation is finished.

Select & Save

After continuous shutter shooting is finished, the shot images are played back at slow speed so you can select the images you want to save.

- When shooting with Prerecord (Still Image), the first image saved when you press the shutter all the way is indicated by an “S” mark so you can tell where the continuous shutter operation started.
- ① While the shot images are playing back and an image appears that you want to save, press the shutter button. Each image that you select by pressing the shutter button will have a mark appended to it.
 - ② After selecting all of the images you want to save, press [▲].

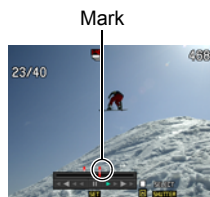

Buttons Used for Image Selection

[◀] [▶]	During playback, changes the playback direction and playback speed. While playback is paused, scrolls forward or back.
[SET]	Toggles between pause and play.
Shutter button	Press all the way down to select an image for saving.
[▲]	Saves the selected images and exits the image select operation.

- ③ Use [▲] and [▼] to select the save method you want and then press [SET].
Save Selected: Saves selected images.
Save All : Saves all the images.
Cancel Save : Does not save any of the images.

Always Ask

After continuous shutter shooting is finished, a prompt appears allowing you to select Normal (Batch) or Select & Save.

Select the save method you want to use and then press [SET].

Save Selected: Saves selected images.

Save All : Saves all the images.

Cancel Save : Does not save any of the images.



5. Press [SET] to apply the setting.

Continuous Shutter Precautions

- If there is not enough available capacity on the memory card, you may not be able to record the number of CS images indicated on the monitor screen. Make sure your memory card has sufficient remaining capacity before shooting with using continuous shutter.
- With continuous shutter, exposure and focus for the first image are applied for successive images as well.
- When using a continuous shutter mode, keep the camera still until shooting is finished.
- In the High-speed CS mode, the flash setting automatically becomes  (flash off).
- Zoom is disabled during continuous shutter operations.
- RAW+, 9M, 3:2, or 16:9 cannot be selected as the image size while High-speed CS or Flash CS is being used. If you enter the High-speed CS or Flash CS mode while one of these image sizes is selected, the camera will record 8M size images.
- If 8M is selected as the image size in the High-speed CS mode, selecting a CS speed of 40 fps will cause 7M (3072×2304) size images to be recorded.
- The maximum number of images that can be recorded during each High-speed CS or Flash CS session is limited, regardless of how much memory card storage capacity is available.

High-speed CS	Up to 40 images
Flash CS with flash	Up to 3 to 10 images

The number of images will be restricted even further or shooting may be impossible when remaining memory card capacity is less than the allowable number of images for a particular CS mode.

- The Triple Self-time cannot be used in the High-speed CS and Flash CS.
- The Self-timer cannot be used in the Prerecord (Still image) mode.
- When the flash is fired for Flash CS, the greater the number of images setting, the smaller the flash range (shooting range).
- With some BEST SHOT scenes, the current mode dial setting () (High-speed CS), ) (Flash CS) is ignored.

Recording Movies

To record a movie

The following procedure explains how to record a standard (STD) movie.

1. Set the mode dial to  (HD/STD).

2. Press [▲].

3. Use [▲] and [▼] to select the second control panel option from the top (HD/STD switching).

4. Use [◀] and [▶] to select “STD” (Standard), and then press [SET].

- Recording is performed with an aspect ratio of 4:3, an image size of 640×480 pixels, and a frame rate of 30 frames per second (STD Movie). Image size setting cannot be changed.

5. Press the shutter button.

This will start recording and display  on the monitor screen.

Movie recording includes monaural audio.

6. Press the shutter button again to stop recording.

- Each movie can be up to 10 minutes long. Movie recording stops automatically after 10 minutes of recording. Movie recording also will stop automatically if memory becomes full before you stop movie recording by pressing the shutter button.

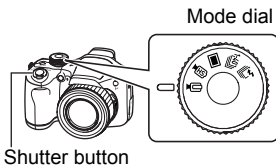

Remaining recording time

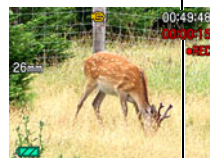

Recording time

Minimizing the Effects of Camera Movement during Movie Recording

You can configure the camera to minimize the effects of camera movement during movie recording (page 79). Note, however, that this does not prevent image blur due to subject movement.

Audio

Your camera has a built-in microphone that can be used to record audio (monaural) during movie recording.

■ Recording Precautions

The camera also records audio. Note the following points when shooting a movie.

- Take care that the microphone is not blocked by your fingers, etc.
- Good recording results are not possible when the camera is too far away from what you are trying to record.
- Operating camera buttons while shooting can cause button noise to be picked up in the audio.
- When **"HD/STD"** is selected as the movie mode, turning optical zoom on or off also turns audio recording on or off. Audio recording is turned off while optical zoom is turned on, and turned on while optical zoom is turned off. The optical zoom on/off operation is performed using the control panel. Note that lens operation noise may be picked up in audio recordings.
- Audio recording cannot be performed while **"HS"** is selected as the movie mode.

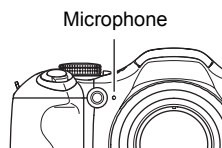



NOTE



- Continuous Auto Focus is performed during movie recording when optical zoom is turned on while **"HD/STD"** is selected as the movie mode, regardless of the current Continuous AF setting. If optical zoom is turned off, continuous Auto Focus is not performed during movie recording, regardless of the current Continuous AF setting.
- When **"HD/STD"** is selected as the movie mode and optical zoom is turned off, you can readjust focus while movie recording is in progress by half pressing the shutter button. Note, however, that noise produced by the lens operation will be picked up in the audio recording.
- Focus is fixed during movie recording when **"HS"** is selected as the movie mode.
- The YouTube mode is disabled automatically during HD movie recording when **"HD/STD"** is selected as the movie mode.
- The [BS] button and BEST SHOT feature are disabled during movie recording.
- Spending a long time using movie recording will cause the camera to become slightly warm to the touch. This is normal and does not indicate malfunction.
- Use of certain types of memory cards slows down data transfer and increases the time it takes to record movie data, which can result in movie frames being dropped. The **"● REC"** indicator on the monitor screen turns yellow to indicate that frames are being dropped. In order to avoid problems such as these, use of an Ultra High-Speed Type SD memory card is recommended. Note, however that CASIO makes no guarantees about the operation of any Ultra High-Speed Type SD memory card used with this camera.
- The effects of camera movement in an image become more pronounced when you shoot close up or with a large zoom factor. Because of this, use of a tripod is recommended under these conditions.
- Face Detection is disabled during movie recording.
- The exposure mode changes to  (Auto) automatically whenever you shoot a movie with the **"STD"** or **"HD"** movie mode (pages 56, 59).
- The aperture, shutter speed, and ISO sensitivity settings (M Mode only) configured with the snapshot A Mode, S Mode, or M Mode are used when shooting a movie with the **"HS"** movie mode (page 59). Note, however, that the shutter speed range is limited in accordance with the frame rate specified for the high-speed movie.
- The [AEL] button is disabled (AE lock and AF lock do not function) while **"HS"** or **"HD/STD"** is selected as the movie mode.



Recording a High-definition Movie

This camera supports recording of high-definition (HD) movies. The aspect ratio of an HD movie is 16:9, the image size is 1280×720 pixels, and the frame rate is 30 fps. Image quality and image size settings cannot be changed.

1. Set the mode dial to  (HD/STD).

2. Press [].

3. Use [] and [] to select the second control panel option from the top (HD/STD switching).

4. Use [] and [] to select “HD”, and then press [SET].

5. Record the movie the same way as you would a normal movie (page 56).
Press the shutter button to start and stop recording.

NOTE

- When recording certain types of movies, the image that appears on the monitor screen may be smaller than normal. When recording an HD movie, there are black bands along the top and bottom of the screen.



Recording a High-speed Movie

This camera supports recording of high speed movies at a maximum speed of 1000 fps. The aspect ratio of movies recorded with this mode depends on the frame rate (recording speed).

- Audio is not recorded in this mode.

1. Set the mode dial to  (HS).

2. Press [].

3. Use [] and [] to select the second control panel option from the top (HS Speed).

4. Use [◀] and [▶] to select the frame rate (recording speed) of the movie you want and then press [SET].

A fast frame rate (such as 1000 fps) will result in a smaller image size.

5. Record the movie the same way as you would a normal movie (page 56).

Press the shutter button to start and stop recording.

- With the “30-210 fps” high-speed movie, the frame rate is always fixed at 30 fps when you first begin recording. You can switch between 30 fps and 210 fps only while recording is in progress. Use [◀] and [▶] or press [SET] to switch speeds.

Frame Rate	Image Size (Pixels)
210 fps	480×360
420 fps	224×168
1000 fps	224×56*
30-210 fps	480×360

* 224×80 in the YouTube mode.

NOTE



- When recording certain types of movies, the image that appears on the monitor screen may be smaller than normal. When recording a high-speed movie, there are black bands along the top, bottom, left, and right of the screen.
- When recording a high-speed movie, light source flicker can cause horizontal bands to appear in the image. This does not indicate malfunction of the camera.
- During High-speed Movie recording, Auto Focus and exposure remain fixed at the levels they were when you initially started recording. Zoom and monitor screen content switching are all disabled.
- To focus the image, half-press the shutter button for Auto Focus or focus manually before starting the High-speed Movie recording operation.
- When recording a high-speed movie, you can record movies with the **A** (Aperture Priority) mode, **S** (Shutter Speed Priority) mode, or **M** (Manual Exposure) mode (page 29). Note, however, that you cannot set a shutter speed that is slower than the High-speed Movie frame rate. The A, S, and M mode settings are not supported when recording with “Prerecord (Movie)”.

Using Prerecord Movie (Prerecord (Movie))

With this feature, the camera pre-records up to five seconds of whatever is happening in front of the lens in a buffer that is continually updated. Pressing [●] saves the prerecorded action (buffer contents) followed by real-time recording. Real-time recording continues until you stop it.

- When using Prerecord Movie in combination with High-speed Movie, the buffer will store two seconds of pre-recording instead of the usual five.

■ To set up the camera to shoot with Prerecord Movie

1. In the REC mode, set the mode dial to  (HD/STD) or  (HS).

2. Press [▲].

3. Use [▲] and [▼] to select the third control panel option from the bottom (Prerecord (Movie)).

4. Use [◀] and [▶] to select “Prerecord (Movie): On” and then press [SET].

To turn off Prerecord (Movie), select “Prerecord (Movie): Off”.

■ To shoot a Prerecord Movie

1. With the camera pointed at the subject, half-press and hold the shutter button.

Movie images will be pre-recorded to the five-second buffer only while the shutter button is maintained in the half-press position.

- When using Prerecord Movie in combination with High-speed Movie, the buffer will store two seconds of pre-recording instead of the usual five.

2. When you are ready to start real-time recording, press the shutter button the rest of the way down.

3. Press the shutter button again to stop recording.



- When shooting with the High-speed Movie “30-210 fps” setting, you cannot change the speed (fps) setting when recording while the shutter button is half-pressed (while recording to the buffer). You can change the speed (fps) setting after you press the shutter button all the way down to start real-time recording.

NOTE

- Focus is locked while the shutter button is half-pressed when Prerecord (Movie) is turned on and optical zoom is turned off, or when Prerecord (Movie) is turned off.

Recording a Movie for YouTube (YouTube)

The YouTube mode records movies in a format that is optimal for uploading to the YouTube movie site, which is operated by YouTube, LLC.

1. Set the mode dial to  (HD/STD) or  (HS).

2. Press [**▲**].

3. Use [**▲**] and [**▼**] to select the second control panel option from the bottom (YouTube).

4. Use [**◀**] and [**▶**] to select “YouTube: On” and then press [**SET**].

5. Record the movie.

The movie file will be stored in a camera folder named “100YOUTB”.

- Installing YouTube Uploader for CASIO from the CD-ROM that comes with your camera simplifies uploading of movie files you recorded with the YouTube Mode to YouTube (page 124).

NOTE

- Movies recorded with the YouTube mode are stored in a special folder to make them easy to locate for uploading (page 116). When the Movie Mode setting (page 56) is “HS” (High-speed Movie) or “STD”, the YouTube mode movie is recorded with the current movie size, recording speed and quality settings.
- To focus before starting to record a movie with the “YouTube” mode, use manual focus. After focusing, start recording.
- The YouTube mode is always turned off (which means you cannot shoot a YouTube optimized movie) during HD movie recording while “HD/STD” is selected as the movie mode.
- When “HS” is selected as the movie mode and “1000 fps” is selected as the recording speed, black bands will be added along to the top and bottom of recorded images to adjust them to the ideal size for YouTube, which is 224×80 pixels.

Turning Optical Zoom On or Off (Optical Zoom)

You can use the following procedure to turn optical zoom (page 44) on or off while “HD/STD” is selected as the movie mode.

1. Set the mode dial to  (HD/STD).
2. Press [**▲**].
3. Use [**▲**] and [**▼**] to select the fourth control panel option from the bottom (Optical Zoom).
4. Use [**◀**] and [**▶**] to select the setting you want and then press [**SET**].

Optical Zoom: On/Record: Off	Enables optical zoom and disables audio recording. Continuous AF is always performed during recording.
Optical Zoom: Off/Record: On	Disables optical zoom and enables audio recording. Continuous AF is never performed during recording. You can readjust focus while recording is in progress by half pressing the shutter button, but doing so will cause noise produced by the lens operation to be picked up in the audio.

NOTE





- Optical zoom operation while recording is disabled when “HS” is selected as the movie mode.
- Regardless of the above setting, optical zoom operation prior to recording is supported when either “HS” or “HD/STD” is selected as the movie mode.
- Optical zoom is disabled when “ Super Macro” is selected as the focus mode.

Using BEST SHOT



What is BEST SHOT?

BEST SHOT provides you with a collection of sample “scenes” that show a variety of different types of shooting conditions. When you need to change the setup of the camera, simply find the scene that matches what you are trying to achieve, and the camera sets up for it automatically. This helps to minimize the chance of ruined images due to poor exposure and shutter speed settings.

Some Sample Scenes

			
Portrait	Scenery	High Speed Night Scene	Night Scene Portrait

To shoot with BEST SHOT

- 1. Set the mode dial to  (Single Shot),  (High-speed CS), or  (Flash CS).**
- 2. Press [BS].**
This will display a menu of BEST SHOT scenes.
- 3. Use [▲], [▼], [◀], and [▶] to move the boundary to the scene you want to select.**
 - The scene menu has multiple pages. Use [▲] and [▼] to scroll between menu pages.
 - You can access information about the currently selected scene. See page 65 for details.
- 4. Press [SET] to configure the camera with the settings for the currently selected scene.**
This returns to the REC mode.
 - The settings of the scene you selected remain in effect until you select a different scene.
 - To select a different BEST SHOT scene, repeat the above procedure from step 1.
- 5. Press the shutter button to start shooting.**

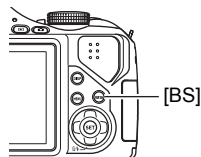

Currently selected scene (with boundary)

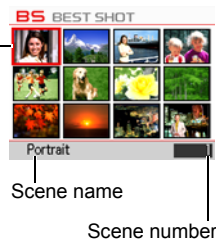

■ Using the Scene Information Screen

To find out more about a scene, select it with the boundary on the scene menu and then slide the zoom controller in either direction.

- To return to the scene menu, slide the zoom controller again.
- To scroll between scenes, use [◀] and [▶].
- To configure the camera with the settings for the currently selected scene, press [SET]. To return to the scene information screen for the currently selected BEST SHOT scene, press [BS].

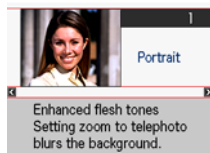

■ BEST SHOT Precautions

- BEST SHOT scene images were not shot using this camera.
- Images shot using a BEST SHOT scene may not produce the results you expected due to shooting conditions and other factors.
- You can modify the camera settings that are configured after you select a BEST SHOT scene. Note, however, that the BEST SHOT settings revert to their defaults when you select another BEST SHOT scene or turn off the camera.
- The mode dial's (Single Shot), (High-speed CS), and (Flash CS) settings are ignored when some BEST SHOT scenes are selected.
- The [BS] button is ignored while the mode dial setting is (HS) or (HD/STD).
- RAW+, 9M, 3:2, 16:9, and 8M cannot be selected for the image size while "High Speed Anti Shake", "Digital Panning", "High Speed Night Scene", "Move Out CS", "Move In CS", or "Multi-motion Image" BEST SHOT scene is selected. An image size setting of 7M is used if any one of the above image sizes is already selected before selecting one of the above BEST SHOT scenes.

Creating Your Own BEST SHOT Setup

You can save up to 999 camera setups as user BEST SHOT scenes for instant recall whenever you need them.

- 1. On the BEST SHOT scene menu, select the scene named BEST SHOT (Register User Scene).**
- 2. Use [◀] and [▶] to select the snapshot whose setup you want to save.**
- 3. Use [▲] and [▼] to select “Save”, and then press [SET].**

Your BEST SHOT scene will be assigned the name “Recall User Scene”, along with a scene number.

NOTE

- You can create BEST SHOT setup for snapshots only. You cannot create a movie BEST SHOT setup.
- You can check the settings of the currently selected BEST SHOT scene by displaying the camera's setting menus and looking at its settings.
- User snapshot scenes are assigned numbers in the sequence: U1, U2, and so on.
- The following are the settings that are saved for each user snapshot BEST SHOT scene.
Face Detection, Focus, EV Shift, White Balance, Flash, ISO, Metering, Dynamic Range, Flash Intensity, Flash Assist, Color Filter, Sharpness, Saturation, Contrast
- User BEST SHOT scenes are stored in built-in memory (page 124) in the SCENE folder (snapshots).
- Formatting the camera's built-in memory (page 135) deletes all user BEST SHOT scenes.
- Use the following procedure when you want to delete a user BEST SHOT scene.
 - ① Display the information screen (page 65) of the user BEST SHOT scene you want to delete.
 - ② Press [▼] (), select “Delete”, and then press [SET].

Shooting with High Speed Night Scene (High Speed Night Scene)

With High Speed Night Scene, the camera detects automatically whether it is being hand-held or on a tripod. When you press the shutter button, the camera will record a series of image and combine them in a way that minimizes image blur due to low light conditions. If the camera detects it is on a tripod, it will shoot a single image using a longer exposure time (instead of shooting and combining multiple images), which results in an even clearer image.

1. Set the mode dial to  (Single Shot),  (High-speed CS), or  (Flash CS).

2. Press [BS].



3. Select “High Speed Night Scene”.

- The camera automatically decides whether it is handheld or mounted on tripod at the moment you select the “High Speed Night Scene” BEST SHOT scene. It does not update its decision any time after that, until you select “High Speed Night Scene” again.
-

4. When you are ready to shoot, press the shutter button.



- After you press the shutter button, the message “Busy... Please wait...” will appear on the monitor screen to indicate that recording is in progress. Keep the camera still while this message is displayed. The recording process takes some time to complete after the message appears.

NOTE

- The following mode dial settings are ignored when shooting with this BEST SHOT scene:  (Single Shot),  (High-speed CS),  (Flash CS).
- Shooting with this BEST SHOT scene makes the shooting range narrower than normal.
- Movement while the camera is mounted on a tripod may cause the camera to erroneously judge it is being hand held.
- The flash is always turned off and the flash setting cannot be changed while High Speed Night Scene is enabled.
- For handheld shooting under very dark conditions, this BEST SHOT scene may not be able to produce the exposure level required for a clear image. Use of a tripod under very dark conditions is recommended.

Shooting with High Speed Anti Shake (High Speed Anti Shake)

When you press the shutter button while High Speed Anti Shake is enabled, the camera records multiple images and automatically combines them in a way that produces a final image with minimal blur. You can shoot with this feature to minimize the effects of camera movement when shooting with optical anti shake does not produce the desired results.



- 1. Set the mode dial to  (Single Shot), , or  (Flash CS).**

- 2. Press [BS].**

- 3. Select “High Speed Anti Shake”.**



- 4. When you are ready to shoot, press the shutter button.**
 - After you press the shutter button, the message “Busy... Please wait...” will appear on the monitor screen to indicate that recording is in progress. Keep the camera still while this message is displayed. The recording process takes some time to complete after the message appears.

NOTE



- The following mode dial settings are ignored when shooting with this BEST SHOT scene: , , .
- Shooting with this BEST SHOT scene makes the shooting range narrower than normal.
- High Speed Anti Shake will not operate correctly while the camera is mounted on a tripod.
- High Speed Anti Shake may not operate properly resulting in blurred images if the camera is moved more than the allowable range or if the subject moves during shooting.

Shooting with Digital Panning (Digital Panning)

When you point the camera at a moving object and pan as you press the shutter button, the camera will perform a continuous shutter operation, recording multiple images. Then it will automatically correct for blurring of the subject only in the recorded images and combine them into a single image that shows a clear subject on a blurred background. This feature lets you shoot powerful panning images simply by following the subject.

1. Set the mode dial to  (Single Shot),  (High-speed CS), or  (Flash CS).
2. Press [BS].
3. Select "Digital Panning".
4. When you are ready to shoot, press the shutter button.
 - Lines will appear on the monitor screen, dividing it into nine areas. As you shoot, move the camera to keep the subject within the middle area as much as possible.

NOTE



- The following mode dial settings are ignored when shooting with this BEST SHOT scene:  (Single Shot),  (High-speed CS),  (Flash CS).
- Shooting with this BEST SHOT scene makes the shooting range narrower than normal.
- Under certain lighting conditions, shooting with Digital Panning can result in overexposure.

Isolating Moving Subjects (Multi-motion image)

Multi-motion image can be used to isolate a moving subject within a series of multiple images and place them against a stationary background. Use a tripod or some other means to make sure that the camera is not moving or shaking when shooting with Multi-motion image.



Basic Multi-motion image Procedure



1. Set the mode dial to  (Single Shot),  (High-speed CS), or  (Flash CS).
2. Press [BS].
3. Select "Multi-motion Image".
4. Hold down the shutter button to record.

5. Release the shutter button.

Continuous Shutter shooting will stop and the resulting composite image will appear on the monitor screen.

- The above procedure shoots multiple images and combines them automatically into a final image. Do not move the camera until shooting is complete.
- You can configure the CS fps and Prerecord CS time settings the same way as you configure the High-speed CS setting. Note, however, unlike High-speed CS, the maximum CS fps setting is 30.
- When recording, keep the shutter button depressed long enough to record at least six consecutive shutter images.

NOTE



- The following mode dial settings are ignored when shooting with this BEST SHOT scene:  (Single Shot),  (High-speed CS),  (Flash CS).
- Shooting with this BEST SHOT scene makes the shooting range narrower than normal.
- Shooting with "Multi-motion Image" assumes that the subject is moving and changing positions. Trying to use it to shoot a subject that is moving while maintaining the same location (such as a golf swing, a baseball swing, etc.) will cause an error message to appear on the monitor screen and failure of image recording, or will produce an image in which the shots of the subject are arranged incorrectly.
- Multi-motion will not operate correctly if you shake or move the camera along with the movement of the subject.
- If an error message appears on the monitor screen, either secure the camera so it does not move or shoot against a different type of background.
- Choose a shooting angle so the colors, shapes, and patterns of the moving subject and the background are as different as possible.
- Avoid a shooting angle where the background is monotone or mono-pattern (such as a clear blue sky).
- The camera may not be able to compose the final image if the intervals between movements are so narrow the subject shots overlap. If this happens, increase the interval by using the control panel to select a slower "High-speed CS fps" setting (page 51).





Shooting an Image in Accordance with Subject Movement (Move Out CS/Move In CS)

You can use these features to shoot an image automatically whenever the subject moves into or moves out of a frame on the monitor screen. You also can configure the camera to record images of what happened immediately before and after the subject moves.

Move Out CS	Automatically records what happened immediately before and after the subject moves outside of a boundary on the monitor screen.
Move In CS	Automatically records what happened immediately before and after the subject moves into a boundary on the monitor screen.

■ To setup the camera

1. Set the mode dial to  (Single Shot),  (High-speed CS), or  (Flash CS).
2. Press [BS].
3. Select “Move Out CS” or “Move In CS”.
4. Press [SET].
5. Configure the boundary location and size settings.

   	Moves the boundary.
Zoom controller	Resizes the boundary.

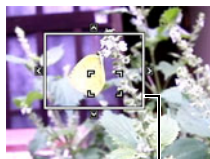

Boundary

6. Press [SET].
 - If you want to reconfigure the settings, start again from step 4.
7. Use [▲] and [▼] to select the third control panel option from the bottom (Trigger Sense).

8. Use [◀] and [▶] to select the subject movement sensitivity, and then press [SET].

- You can select any one of three sensitivity levels: “High”, “Normal”, or “Low”.
- Move Out CS Setting Guide
High: For a subject that moves out of the boundary quickly
Low : For a subject that moves out of the boundary slowly
- Move In CS Setting Guide
High: For a subject that moves into the boundary quickly or for a small subject (relative to the boundary)
Low : For a subject that moves into the boundary slowly or for a large subject (relative to the boundary)

9. Use [▲] and [▼] to select the second control panel option from the bottom (High-speed CS fps).

10. Use [◀] and [▶] to select the CS speed setting you want, and then press [SET].

- You select a value in the range of 1 frame per second to 40 frames per second for the CS speed.

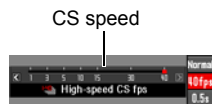

11. Use [▲] and [▼] to select the bottom control panel option (Prerecord (Still image) Time).

12. Use [◀] and [▶] to specify the pre-record time, which is the amount of time before and after subject movement for which you want to record images, and then press [SET].

Number of pre-recorded images and recording time

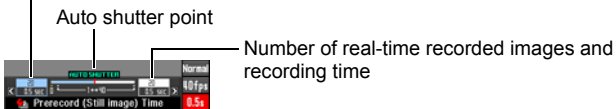

- The approximate number of recordable CS images will appear on the monitor screen.
- The “Number of pre-recorded images and recording time” cannot be set to zero.

Number of recordable CS images 40
470
Remaining snapshot memory capacity

■ To shoot using Move Out CS

1. Compose the image so the subject is within the boundary on the monitor screen.

2. Half-press the shutter button.

- The camera will adjust exposure and focus automatically.
-

3. When the boundary on the monitor screen turns green, press the shutter button the rest of the way down.

At this time the camera will go into recording standby and start pre-recording images and storing them in a buffer, in accordance with the Prerecord Time setting you configured in step 10 under “To setup the camera” on page 71. After the buffer becomes full, new images keep being added while older images are continually being deleted.

The camera will start saving images automatically the moment it detects that the subject has moved out of the boundary.

- “● AUTO” flashes on the monitor screen during recording standby and auto recording.
-

4. Image recording will continue until the end of the Prerecord Time is reached.

- While the camera is in Move Out CS recording standby, you can cancel standby by pressing the shutter button all the way down. You then will be able to shoot images normally.
 - To stop an ongoing image recording operation, press [SET].
-

5. Save the CS images (page 53).

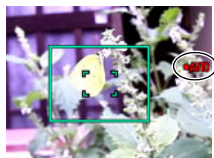

■ To shoot using Move In CS

1. Compose the image at a location where you expect the subject to enter the boundary on the monitor screen.

2. Half-press the shutter button.

- The camera will adjust exposure and focus automatically.
 - In this case, use of manual focus (page 46) to preset a fixed focus is recommended.
-

3. When the boundary on the monitor screen turns green, press the shutter button the rest of the way down.

At this time the camera will go into recording standby and start pre-recording images and storing them in a buffer, in accordance with the Prerecord Time setting you configured in step 10 under "To setup the camera" on page 71. After the buffer becomes full, new images keep being added while older images are continually being deleted.

The camera will start saving images to memory automatically the moment it detects the subject has moved into the area within the boundary.

- "● AUTO" flashes on the monitor screen during recording standby and auto recording.
-

4. Image recording will continue until the end of the Prerecord Time is reached.

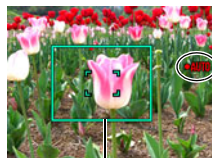

- While the camera is in Move In CS recording standby, you can cancel standby by pressing the shutter button all the way down. You then will be able to shoot images normally.
 - To stop an ongoing image recording operation, press [SET].
-

5. Save the CS images (page 53).



Boundary

NOTE

- Compose the image so the entire subject and its background are within the boundary. Recording may not be performed correctly if there is little difference between the subject and the part of the background enclosed by the boundary. Also, Move Out CS may not record correctly if the subject is not in the center of the boundary.
- Move In CS and Move Out CS do not operate correctly if you press the shutter button all the way down. Be sure to half-press the shutter button. After images are pre-recorded, press the shutter button the rest of the way down.
- After pressing the shutter button all the way to put the camera into record standby, keep the camera still. Recording may not be performed correctly if you move the camera during record standby.
- The following mode dial settings are ignored when shooting with this BEST SHOT scene:  (Single Shot),  (High-speed CS),  (Flash CS).
- The sleep mode and Auto Power Off are disabled while the camera is in record standby.
- The camera may not start recording automatically or camera power may turn off when battery power is low. Always make sure that the battery is sufficiently charged or use the optional AC adaptor before using these features.
- To save all of the continuous shutter images, select "Save All" (page 53) as the continuous shutter image save method. If you do, make sure that the memory card loaded in the camera has enough free space to store them.
- Zoom is disabled, and focus and exposure are fixed while the camera is in recording standby.

Advanced Settings

The following are menu operations you can use to configure various camera settings.

Using On-screen Menus

■ Example Menu Screen Operation

Press [MENU] to display the menu screen.

- Menu contents are different in the REC mode and PLAY mode.

Example: REC mode menu

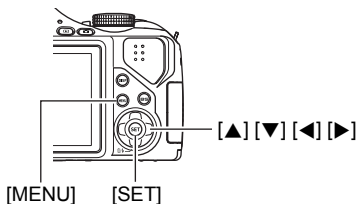
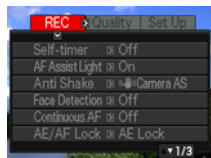

Menu Screen Operation Buttons

[◀] [▶]	Selects tabs. [▶] is also used to display the options available for a setting.
[▲] [▼]	Selects a setting option.
[SET]	Registers the selected setting.
[MENU]	Exits the menu screen.

1. In the REC mode, press [MENU].

This will display the menu screen.

2. Use [◀] and [▶] to select the tab where the item you want to configure is located.

3. Use [▲] and [▼] to select the menu item you want, and then press [▶].

4. Use [▲] and [▼] to change the setting.

5. After the setting is the way you want, press [SET].

- Pressing [◀] registers the selected setting and returns to the menu.
- To configure settings on another tab after pressing [◀] to return to the menu, use [▲] to move the highlighting up to the tabs, and then use [◀] and [▶] to select the tab you want.

Example:
When "Self-timer" is selected on the "REC" tab

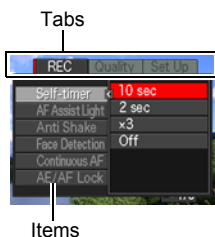

■ Menu Operations in This Manual

Menu operations are represented in this manual as shown below. The following operation is the same one described under "Example Menu Screen Operation" on page 76.

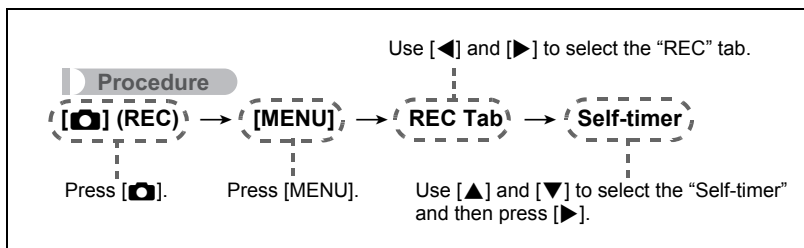



REC Mode Settings (REC)

Using the Self-timer (Self-timer)

Procedure

[] (REC) → [MENU] → REC Tab → Self-timer

With the Self-timer, pressing the shutter button starts a timer. The shutter is released and the image is shot after a fixed amount of time.

 10 sec	10-second Self-timer
 2 sec	2-second Self-timer • When shooting under conditions that slow down the shutter speed, you can use this setting to prevent image blur due to camera movement.
 X3 (Triple Self-timer)	Shoots three images: one image 10 seconds after the shutter button is pressed, and the next two images as soon as the camera is ready after shooting the previous image. How long it takes for the camera to get ready to shoot depends on the image size and quality settings, whether or not a memory card is loaded in the camera, and the flash charge condition.
Off	Self-timer is disabled.

- The front lamp flashes while the Self-timer countdown is in progress.
- You can interrupt an ongoing Self-timer countdown by pressing [SET].

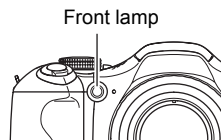

NOTE

- The Self-timer cannot be used together with the following features.
High-speed CS with Prerecord (Still image), movie recording with Prerecord (Movie), Move Out CS, Move In CS, Multi-motion Image
- The Triple Self-timer cannot be used together with the following features.
High-speed CS, Flash CS, Movie

Using the Auto Focus Assist Light (AF Assist Light)

Procedure

[] (REC) → [MENU] → REC Tab → AF Assist Light

Half-pressing the shutter button while this setting is selected causes the front lamp to light, which provides illumination for focusing in areas where lighting is dim. Leaving this function turned off is recommended when shoot portraits from short distances, etc.

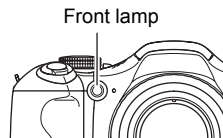

IMPORTANT!





- Never look directly into the front lamp while it is lit.
- Make sure your finger is not covering the front lamp.

Reducing the Effects of Camera and Subject Movement (Anti Shake)







Procedure

[] (REC) → [MENU] → REC Tab → Anti Shake

You can turn on the camera's Anti Shake feature to reduce image blur due to subject movement or camera movement when shooting a moving subject using telephoto, when shooting a fast-moving subject, or when shooting under dim lighting conditions.

 Auto	Minimizes the effects of camera and subject movement
 Camera AS	Minimizes the effects of camera movement only
 Image AS	Minimizes the effects of subject movement only
 DEMO	Half-pressing the shutter button demonstrates the effect of "  Camera AS". However, the image is not recorded.
Off	Turns off all Anti Shake settings

NOTE

- Only “ Camera AS” can be used during movie recording.
- The ISO sensitivity setting (page 38) must be “AUTO” for “ Image AS” to work.
- If the flash fires, the Anti Shake icon will remain on the display, even though Anti Shake does not function during flash photography.
- Shooting with Anti Shake can cause an image to appear somewhat coarser than normal and can cause slight deterioration of image resolution.
- Anti Shake may not be able to eliminate the effects of camera or subject movement when movement is severe.
- “ Camera AS” may not work properly when the camera is mounted on a tripod. Either turn off Anti Shake or select “ Image AS”.
- When the image size setting is “RAW+” (page 33), this setting becomes “ Camera AS” when the Anti Shake setting is “ Auto”, and “Off” when the Anti Shake setting is “ Image AS”.

Shooting with Face Detection (Face Detection)

Procedure

 (REC) → [MENU] → REC Tab → Face Detection

The face detection feature adjusts focus and brightness to the faces in the image.

1. Use [◀] and [▶] to select “On” and then press [SET].

2. Point the camera at the subject (s).

The camera will detect human faces and display a frame around each one.



3. Half-press the shutter button.

The camera will focus and the frames around the faces it focuses on will turn green.

4. Press the shutter button the rest of the way down.

Tips for Best Face Detection Results

- The camera performs center focus if it cannot detect a face.
- Always make sure that Auto Focus (AF) is selected as the focus mode when shooting with face detection.
- Detection of the following types of faces is not supported.
 - A face that is obstructed by hair, sunglasses, a hat, etc., or a face in dark shade
 - A profile or a face that is at an angle
 - A face that is very far away and small, or very close and large
 - A face in an area that is very dark
 - A face of a pet or some other non-human subject



IMPORTANT!

- Face detection cannot be used in combination with any of the following features.
 - Some BEST SHOT scenes (Digital Panning, Move Out CS, Move In CS, Multi-motion Image)
 - YouTube
 - Prerecord (Movie)
 - Movie Mode
 - High-speed CS with Prerecord (Still image)
- (Focus) is disabled while face detection is turned on.

Shooting with Continuous Auto Focus (Continuous AF)

Procedure

[CAMERA] (REC) → [MENU] → REC Tab → Continuous AF

When shooting a snapshot while “On” is selected for Continuous AF, Auto Focus is performed and focusing is continually updated until you half-press the shutter button.

- Continuous Auto Focus is performed during movie recording when optical zoom is turned on while “HD/STD” is selected as the movie mode, regardless of the current Continuous AF setting. If optical zoom is turned off, continuous Auto Focus is not performed during movie recording, regardless of the current Continuous AF setting.
- Before you half-press the shutter button, the camera focuses at the center of the screen. If “ Free” is selected for the “AF Area” setting (page 41) when you half-press the shutter button, focusing is performed for the area specified by “ Free”. If “Face Detection” is turned on, focusing is performed in the area where a face is detected.

Specifying the [AEL] button Operation (AE/AF Lock)

Procedure

[] (REC) → [MENU] → REC Tab → AE/AF Lock

See page 49 for details.

Configuring the Continuous Shutter Image Save Method (Save CS Images)

Procedure

[] (REC) → [MENU] → REC Tab → Save CS Images

See page 53 for details.

Turning Digital Zoom On or Off (Digital Zoom)

Procedure

[] (REC) → [MENU] → REC Tab → Digital Zoom

Select “On” when you want to use digital zoom (page 44).

- Digital zoom is disabled while shooting with the following features.
 - Some BEST SHOT scenes (High Speed Anti Shake, Digital Panning)
 - High-speed movie recording
 - “ Super Macro” selected for the focus mode
 - “RAW+” image size

Shooting with Quick Shutter (Quick Shutter)

Procedure

[CAMERA] (REC) → [MENU] → REC Tab → Quick Shutter

When Quick Shutter is turned on, you can press the shutter button all the way without waiting for Auto Focus. This will record the image using a high-speed focus operation that is much faster than Auto Focus.

On	Turns on Quick Shutter <ul style="list-style-type: none">Some images may be out of focus when Quick Shutter is used.
Off	Turns off Quick Shutter so focus is performed using normal Auto Focus before the image is recorded. <ul style="list-style-type: none">If you fully press the shutter button while Quick Shutter is turned off, images will continue to be shot without focusing.Whenever possible, take a little extra time to half-press the shutter button in order to ensure proper focus.

NOTE

- Quick Shutter is disabled when the zoom factor is greater. Recording is performed using Auto Focus at this time.

Turning on Image Review (Review)

Procedure

[CAMERA] (REC) → [MENU] → REC Tab → Review

While Review is turned on, the camera will display a image for about one second immediately after you press the shutter button to record it.

- Image review is available only when shooting single images. It does not work with continuous shutter.

Displaying the On-screen Grid (Grid)

Procedure

[CAMERA] (REC) → [MENU] → REC Tab → Grid

The on-screen grid can be displayed on the REC mode monitor screen for easy vertical and horizontal alignment when composing images.



Using Icon Help (Icon Help)

Procedure

[] (REC) → [MENU] → REC Tab → Icon Help

While Icon Help is turned on, a textual description will appear on the display for certain icons when you switch between REC functions.

Function Supported by Icon Help

- REC Mode

Configuring Power On Default Settings (Memory)

Procedure

[] (REC) → [MENU] → REC Tab → Memory

When you turn off the camera, it remembers the current settings of all enabled memory items and restores them when you turn it back on. Any memory item that is disabled will be returned to its initial default setting whenever you turn off the camera.

Setting	Disabled (Initial Default Setting)	Enabled
Flash	Auto	Setting at power off
Self-timer	Off	
Flash Intensity	0	
Digital Zoom	Off	
MF Position	Position before manual focus was selected.	
Zoom Position*	Full wide	

* Optical zoom setting only.

Image Quality Settings (Quality)

Specifying Snapshot Image Quality (Quality (Snapshot))

Procedure

[CAMERA] (REC) → [MENU] → Quality Tab → Quality (Snapshot)

Fine	Gives image quality priority
Normal	Normal
Economy	Gives the number of images priority

- The "Fine" setting helps to bring out details when shooting a finely detailed image that includes dense tree branches or leaves, or an image of a complex pattern.
- Memory capacity (the number of images you can record) will be affected by the quality settings you configure (page 168).

Reducing Underexposure and Overexposure (Dynamic Range)

Procedure

[CAMERA] (REC) → [MENU] → Quality Tab → Dynamic Range

You can adjust the Dynamic Range setting in order to capture the bright areas of an image while reducing the chance of overexposure and underexposure.

Expand +2	Suppresses overexposure and underexposure more than "Expand +1"
Expand +1	Suppresses overexposure and underexposure
Off	No suppression of overexposure and underexposure

- The dynamic range setting is ignored during high-speed movie recording.

Specifying Flash Intensity (Flash Intensity)

Procedure

[] (REC) → [MENU] → Quality Tab → Flash Intensity

You can specify flash intensity to one of 13 levels from +2 (brightest flash) to -2 (least bright flash).

- Flash intensity may not change when the subject is too far away or too close.

Turning On Flash Assist (Flash Assist)

Procedure

[] (REC) → [MENU] → Quality Tab → Flash Assist

The subject in an image will look too dark if flash intensity is not enough to reach a subject that is too far away. When this happens, you can use flash assist to supplement the brightness of the subject so it appears as if flash illumination was sufficient. Select “Auto” to turn on Flash Assist.

Flash Assist may not produce the desired result if you use it after changing the initial default settings of any of the following.

Flash Intensity, EV Shift, ISO, Contrast



Flash assist turned off



Flash assist turned on

Using Built-in Color Filters (Color Filter)

Procedure

[] (REC) → [MENU] → Quality Tab → Color Filter

Settings: Off, B/W, Sepia, Red, Green, Blue, Yellow, Pink, and Purple

Controlling Image Sharpness (Sharpness)

Procedure

[CAMERA] (REC) → [MENU] → Quality Tab → Sharpness

You can specify one of five sharpness settings from +2 (sharpest) to -2 (least sharp).

Controlling Color Saturation (Saturation)

Procedure

[CAMERA] (REC) → [MENU] → Quality Tab → Saturation

You can specify one of five saturation settings from +2 (most saturated) to -2 (least saturated).

Adjusting Image Contrast (Contrast)

Procedure

[CAMERA] (REC) → [MENU] → Quality Tab → Contrast

You can specify one of five contrast settings from +2 (most contrast between light and dark) to -2 (least contrast between light and dark).

Viewing Snapshots and Movies

Viewing Snapshots

See page 24 for the procedure for viewing snapshots.

Viewing a Movie

1. Press [▶] (PLAY) and then use [◀] and [▶] to display the movie you want to view.
2. Press [SET] to start playback.



Movie Playback Controls

[◀] [▶]	During playback, changes the playback direction and playback speed. While playback is paused, scrolls forward or back. <ul style="list-style-type: none">• Playback speed cannot be adjusted while the displayed image is zoomed.
[SET]	Toggles between pause and play.
[DISP]	Cycles through information display formats.
Zoom controller	Zooms the image. <ul style="list-style-type: none">• You can use [▲], [▼], [◀], and [▶] to scroll the zoomed image on the monitor screen.
[▲] [▼]	Adjusts audio volume during playback. Pressing [▼] while playback is paused starts movie editing (page 97). <ul style="list-style-type: none">• Audio adjustment is not possible for a movie that does not include audio.
[MENU]	Ends movie playback.

- Playback may not be possible for movies not recorded with this camera.

Viewing Continuous Shutter Images

Each time you perform a continuous shutter (CS) operation, the camera creates a CS group that includes all of the images for that particular CS session. You can use the following procedure to play back the images in a particular CS group.

1. Press **[▶]** (PLAY) and then use **[◀]** and **[▶]** to display the CS group whose images you want to view.
2. Press **[SET]** to start playback the images in the CS group.

This will play back the images in the CS group you selected.

Current image number/number of images in the group

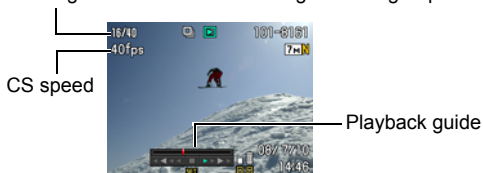

Number of image files in the CS group

CS group icon



Playback Controls

[◀] [▶]	During playback, changes the playback direction and playback speed. While playback is paused, scrolls forward or back. <ul style="list-style-type: none"> • Playback speed cannot be adjusted while the displayed image is zoomed.
[SET]	Toggles between pause and play.
[DISP]	Cycles through information display formats.
Zoom controller	Zooms the image. <ul style="list-style-type: none"> • You can use [▲], [▼], [◀], and [▶] to scroll the zoomed image on the monitor screen.
[▲]	Exits CS group playback.
[▼]	Displays the delete menu.

Deleting Continuous Shutter Images

You can use the following procedures to delete images while playback is in progress or paused.

■ Deleting a Specific CS Group File

1. While CS image playback is in progress or paused, press [▼].
2. Use [◀] and [▶] to display the image you want to delete.
3. Use [▲] and [▼] to select “Delete” and then press [SET].
 - To delete other files, repeat steps 2 and 3.
 - To exit the delete operation, press [MENU].

■ Deleting All Files in a CS Group

1. While CS image playback is in progress or paused, press [▼].
2. Use [▲] and [▼] to select “Del Group Images” and then press [SET].
3. Use [▲] and [▼] to select “Yes”, and then press [SET].

Dividing Up a CS Group

Use the following to divide up a CS Group into individual images.

■ Dividing Up a Specific CS Group

1. While a CS group folder is displayed, press [MENU].
2. Use [◀] and [▶] to select “PLAY”.
3. Use [▲] and [▼] to select “Divide Group” and then press [▶].
4. Use [◀] and [▶] to display the CS group folder whose CS group you want to divide up.
5. Use [▲] and [▼] to select “Divide” and then press [SET].
 - To divide up other CS group files, repeat steps 4 and 5.

■ Dividing Up All CS Groups

1. While a CS group folder is displayed, press [MENU].

2. Use [◀] and [▶] to select “PLAY”.

3. Use [▲] and [▼] to select “Divide Group” and then press [▶].

4. Use [▲] and [▼] to select “Divide All Groups” and then press [SET].

5. Use [▲] and [▼] to select “Yes”, and then press [SET].
 - Once a CS group is divided, it cannot be regrouped.

■ Copying a CS Group Image

Use the following procedure to copy an image in a CS group to a location outside of the group.

1. While a CS group folder is displayed, press [SET].

2. While an image inside the CS group is displayed, press [MENU].

3. Use [◀] and [▶] to select “PLAY”.

4. Use [▲] and [▼] to select “Select Frame”, and then press [▶].

5. Use [◀] and [▶] to display the image you want to copy.

6. Use [▲] and [▼] to select “Copy”, and then press [SET].

NOTE

- The functions below cannot be performed on snapshots inside a CS group folder. Before using either of these functions, perform the above procedure (Select Frame) to copy the image first.
Cropping, Rotation, Resize

Zooming an On-screen Image

1. In the PLAY mode, use [◀] and [▶] to scroll through the images until the one you want is displayed.

2. Slide the zoom controller towards [📏] (🔍) to zoom.

You can use [▲], [▼], [◀], and [▶] to scroll the zoomed image on the monitor screen. Slide the zoom controller towards [📏] to unzoom the image.

- When monitor screen contents are turned on, a graphic in the lower right corner of the screen shows what part of the zoomed image is currently displayed.
- To exit the zoom screen, press [MENU].
- Though the maximum image zoom factor is 8X, certain image sizes may not allow zooming up to the full 8X.

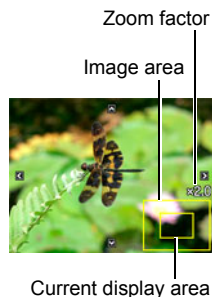

Displaying the Image Menu

1. In the PLAY Mode, slide the zoom controller towards [📏] (🗨️).

Use [▲], [▼], [◀] and [▶] to move the selection boundary around the image menu.

To view a particular image, use [▲], [▼], [◀], or [▶] to move the selection boundary to the image you want and then press [SET].

- In the case of a movie or a continuous shutter (CS) file, the first frame of the file will be displayed.



Viewing Snapshots and Movies on a TV Screen

1. Use the AV cable that comes with the camera to connect it to the TV.

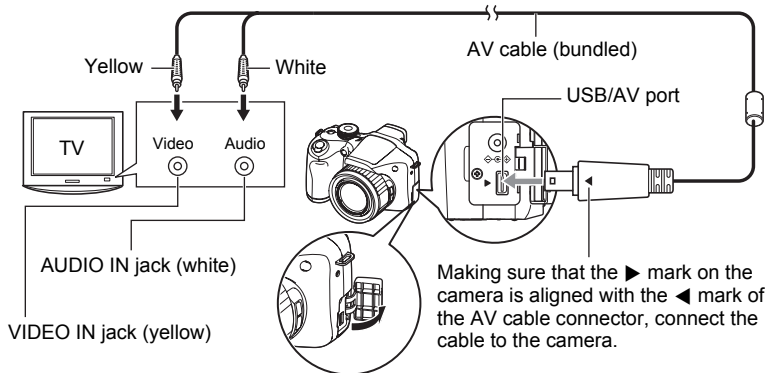

- Make sure that you insert the cable connector into the USB/AV port until you feel it click securely into place. Failure to insert the connector fully can result in poor communication or malfunction.
- Note that even while the connector is fully inserted, you still will be able to see the metal part of the connector as shown in the illustration.
- Before connecting to a TV to display images, be sure to configure the camera's [RECORD] (REC) and [PLAY] (PLAY) buttons for "Power On" or "Power On/Off" (page 132).
- Make sure that the camera is turned off before plugging in or unplugging the cable. Check the user documentation that comes with the TV for information about requirements before plugging into or unplugging from the TV.

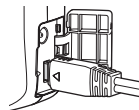

2. Turn on the TV and select its video input mode.

If the TV has more than one video input, select the one where the camera is connected.

3. Press [▶] (PLAY) to turn on the camera.

This will cause an image to appear on the TV screen, without anything appearing on the camera's monitor screen.

- Pressing [ON/OFF] or [📷] (REC) will not turn on the camera while the AV cable is connected.
- You also can change the aspect ratio of the screen and the video output system (page 133).

4. Now you can display images and play back movies as you normally do.

Recording Camera Images to a DVD Recorder or Video Deck

Use one of the following methods to connect the camera to the recording device using the camera's bundled AV cable.

- DVD recorder or video deck: Connect to the VIDEO IN and AUDIO IN terminals.
- Camera: USB/AV port

You can play a slideshow of snapshots and movies on the camera and record it on a DVD or video tape. You can record movies by selecting "📷 Only" for the slideshow "Images" setting (page 95). When recording images to an external device, use [DISP] to clear all indicators from the monitor screen (page 136).

For information about connecting a monitor to the recording device and about how to record, see the user documentation that comes with the recording device you are using.

NOTE

- Audio is monaural.
- Some TVs may not be able to output images and/or audio correctly.
- Audio is initially output by the camera at maximum volume. When you first start displaying images, set the TV volume control at a relatively low level and then adjust it as required.
- All icons and indicators that appear on the monitor screen also appear on the TV screen. You can use [DISP] to change the display contents.

Other Playback Functions (PLAY)





This section explains menu items that you can use to configure settings and perform other playback operations.

For information about menu operations, see page 76.

Playing a Slideshow on the Camera (Slideshow)

Procedure

[▶] (PLAY) → [MENU] → PLAY Tab → Slideshow

Start	Starts the slideshow
Images	Specifies the type of images to be included in the slideshow All images: Snapshots, movies, continuous shutter images All images except  : All non-continuous shutter (CS) images  Only: Snapshots only  Only: Movies only One Image: One single selected image (selected using [◀] and [▶])
Time	Time from the start to the end of the slideshow 1 to 5 minutes, 10 minutes, 15 minutes, 30 minutes, 60 minutes
Interval	Amount of time each image remains displayed Use [◀] and [▶] to select a value from 1 to 30 seconds, or "MAX". If you specify a value from 1 to 30 seconds, movies play from beginning to end. When the slideshow reaches a movie file while "MAX" is selected, only the first frame of the movie will be displayed.
Effect	Select the effect you want. Pattern 1 to 5: Plays background music and applies an image change effect. <ul style="list-style-type: none">• Patterns 1 through 4 have different background music, but they all use the same image change effect.• Pattern 5 can be used for playback of snapshots only (except for those that are part of a CS group), and the "Interval" setting is ignored.• Movies that include audio are played back without BGM. Movies that do not include audio are played back with BGM.• The currently selected image change effect setting is disabled automatically in following cases.<ul style="list-style-type: none">– When playing a slideshow for which " Only" or "One Image" is selected for the "Images" setting– When the interval setting is 1 second or 2 seconds.– Before and after playback of a movie– During CS group playback Off: No image change effect or background music

- To stop the slideshow, press [SET] or [MENU]. Pressing [MENU] stops the slideshow and returns to the menu screen.
- Adjust audio volume by pressing [▲] or [▼] during playback.
- All button operations are disabled while the slideshow is transitioning from one image to another.
- The time required for transition from one image to another may be longer in the case of an image that was not recorded with this camera.

Creating a Snapshot of Movie Frames (MOTION PRINT)

Procedure

[▶] (PLAY) → Movie Screen → [MENU] → PLAY Tab → MOTION PRINT

1. Use [◀] and [▶] to scroll through the movie frames and display the one you want to use as the image of the MOTION PRINT image.

Holding down [◀] or [▶] scrolls at high speed.

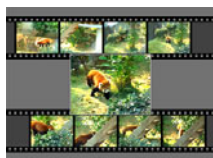

9 frames



1 frame

2. Use [▲] and [▼] to select either “9 frames” or “1 frame” and then press [SET].



- When “9 frames” is selected, the frame you select in step 1 will be in the center of the MOTION PRINT image.
- Only the frames of movies recorded on this camera can be used in a MOTION PRINT image.
- Motion print cannot be used to capture frames from a 1000 fps high-speed movie recorded in the YouTube mode.

Editing a Movie on the Camera (Movie Editing)

Procedure

[**▶**] (PLAY) → **Movie Screen of Movie to be Edited** → [**MENU**] → **PLAY Tab** → **Movie Editing**

The Movie Editing feature lets you use one of the following procedures to edit out a specific part of a movie.

 Cut (To-Point Cut)	Cuts everything from the beginning of the movie up to the current location.
 Cut (Point-To-Point Cut)	Cuts everything between two points.
 Cut (From-Point Cut)	Cuts everything from the current location to the end of the movie.

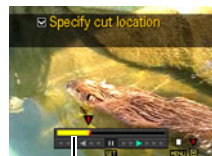

1. Use [**▲**] and [**▼**] to select the editing method you want to use and then press [**SET**].
2. Use the following operations to select the frame (point) from which or to which you want to cut the movie (the cut point).

[◀] [▶]	During playback, changes the playback direction and playback speed. While playback is paused, scrolls forward or back.
[SET]	Toggles between pause and play.



Cut range (yellow)

3. When the frame where you want the cut point to be is displayed, press [▼].

 Cut (To-Point Cut)	While the frame you want the cut to be up to is displayed, press [▼].
 Cut (Point-To-Point Cut)	① While the frame you want the first (From) cut to be is displayed, press [▼]. ② Select another frame. ③ While the frame you want the second (To) cut to be is displayed, press [▼].
 Cut (From-Point Cut)	While the frame you want the cut to be from is displayed, press [▼].

4. Use [▲] and [▼] to select “Yes” and then press [SET].

The selected cut operation will take considerable time to complete. Don't try to perform any camera operation until the “Busy... Please wait...” message disappears from the monitor screen. Note that a cut operation can take a long time if the movie being edited is long.

 **IMPORTANT!**

- When you edit a movie, only the result is saved. The original movie is not retained. An editing operation cannot be undone.

NOTE







- A movie that is shorter than five seconds cannot be edited.
- Editing of movies recorded with a different type of camera is not supported.
- You will not be able to edit a movie if the amount of remaining memory capacity is less than the size of the movie file you want to edit. If there is not enough memory available, delete files you no longer need to free up more.
- Splitting of a movie into two movies and splicing of two different movies into a single movie are not supported.
- You also can start a movie editing operation while the movie you want to edit is playing back. Press [SET] to pause playback, and then press [▼] to display the menu of editing options. Perform editing using the same procedures as described above.

Adjusting White Balance (White Balance)

Procedure

[] (PLAY) → Snapshot Screen → [MENU] → PLAY Tab → White Balance

You can use the white balance setting to select a light source type for a recorded image, which will affect the colors of the image.

 Daylight	Outdoors, fair weather
 Overcast	Outdoors, cloudy to rain, in tree shade, etc.
 Shade	Very high temperature light, such as building shade, etc.
 Day White Fluorescent	White or day white fluorescent lighting, without suppressing color cast
 Daylight Fluorescent	Daylight fluorescent lighting, while suppressing color cast
 Tungsten	Suppressing of the appearance of light bulb lighting
Cancel	No white balance adjustment

NOTE

- You also can adjust the white balance when recording images (page 38).
- The original snapshot is retained in memory and not deleted.
- When you display an altered image on the camera's monitor screen, the date and time indicates when the image was originally recorded, not when the image was altered.
- The corrected version of an image cannot be output to a TV (page 93).

Adjusting the Brightness of an Existing Snapshot (Brightness)

Procedure

[] (PLAY) → Snapshot Screen → [MENU] → PLAY Tab → Brightness

You can select one of five brightness levels, from +2 (brightest) to -2 (least bright).

NOTE

- The original snapshot is retained in memory and not deleted.
- When you display an altered image on the camera's monitor screen, the date and time indicates when the image was originally recorded, not when the image was altered.
- The corrected version of an image cannot be output to a TV (page 93).

Selecting Images for Printing (DPOF Printing)

Procedure

[] (PLAY) → Snapshot Screen → [MENU] → PLAY Tab → DPOF Printing

See page 108 for details.

Protecting a File Against Deletion (Protect)

Procedure

[▶] (PLAY) → [MENU] → PLAY Tab → Protect

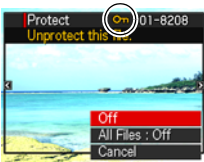
On	<p>Protects specific files.</p> <ol style="list-style-type: none">① Use [◀] and [▶] to scroll through the files until the one you want to protect is displayed.② Use [▲] and [▼] to select "On" and then press [SET]. An image that is protected is indicated by the  icon.③ To protect other files, repeat steps 1 and 2. To exit the protect operation, press [MENU]. To unprotect a file, select "Off" instead of "On" in step 2 above.	
All Files: On	<p>Protects all files.</p> <ol style="list-style-type: none">① Use [▲] and [▼] to select "All Files: On" and then press [SET].② Press [MENU]. To unprotect all files, select "All Files: Off" instead of "All Files: On" in step 1 above.	



IMPORTANT!

- Note that even if a file is protected, it will be deleted if you perform the format operation (page 135).

NOTE

- Performing the above procedure while a CS group folder is displayed will protect all the images in the CS group folder. You can protect individual images in a CS group by performing the above procedure while the image is displayed.

Rotating an Image (Rotation)

Procedure

[] (PLAY) → Snapshot Screen → [MENU] → PLAY Tab → Rotation

1. Use [] and [] to select “Rotation” and then press [SET].

Each press of [SET] will rotate the displayed image 90 degrees left.

2. When the displayed image is at the orientation you want, press [MENU].

NOTE

- Rotation of movie images is not supported.
- Note that this procedure does not actually change the image data. It simply alters how the image is displayed on the camera's monitor screen.
- An image that has been protected or zoomed cannot be rotated.
- The original (unrotated) version of the image will be displayed on the image menu screen.

Resizing a Snapshot (Resize)

Procedure

[] (PLAY) → Snapshot Screen → [MENU] → PLAY Tab → Resize

You can reduce the size of a snapshot and save the result as a separate snapshot. The original snapshot is also retained. You can resize an image to one of three image sizes: 5M, 2M, VGA.





- Resizing a 16:9 or 3:2 size snapshot will create an image with an aspect ratio of 4:3, with both sides cut off.
- The recording date of the resized version of the snapshot will be the same as the recording date of the original snapshot.

Cropping a Snapshot (Trimming)

Procedure

[] (PLAY) → Snapshot Screen → [MENU] → PLAY Tab → Trimming

You can crop a snapshot to trim parts you do not need, and save the result in a separate file. The original snapshot is also retained.

Use the zoom controller to zoom the image to the size you want, use [, [, [, and [] to display the portion of the image you want to cut out, and then press [SET].

- The image produced by cropping a 3:2 or 16:9 image will have an aspect ratio of 4:3.
- The recording date of the cropped image will be the same as the recording date of the original snapshot.

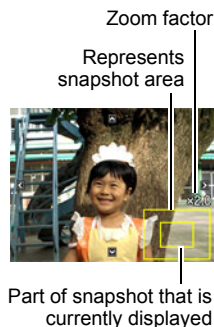





Copying Files (Copy)

Procedure

[] (PLAY) → Snapshot Screen → [MENU] → PLAY Tab → Copy

Files can be copied from the camera's built-in memory to a memory card or from a memory card to built-in memory.

Built-in → Card	Copies all files from built-in camera memory to a memory card. This option copies all the files in built-in camera memory. It cannot be used to copy a single file.
Card → Built-in	Copies a single file on the memory card to camera built-in camera memory. Files are copied to the folder in built-in memory whose name has the largest serial number. <ul style="list-style-type: none">• You cannot copy a continuous shutter (CS) group image (page 91). <ol style="list-style-type: none">① Use [] and [] to select the file you want to copy.② Use [] and [] to select "Copy" and then press [SET].

NOTE

- You can copy snapshots or movies you recorded with this camera.

Dividing Up a Continuous Shutter Group (Divide Group)

Procedure

[▶] (PLAY) → [MENU] → PLAY Tab → Divide Group

See page 90 for details.

Copying a Continuous Shutter Group (Select Frame)

Procedure

[▶] (PLAY) → [MENU] → PLAY Tab → Select Frame

See page 91 for details.

Printing Snapshots

Professional Print Service

You can take a memory card that contains the images you want to print to a professional print service and have them printed.



Printing on a Home Printer

Printing Images on a Printer with Memory Card Slot

You can use a printer equipped with a memory card slot to print images directly from a memory card. For details, see the user documentation that comes with your printer.



Connecting Directly to a PictBridge Compatible Printer

You can print on a printer that supports PictBridge (page 106).

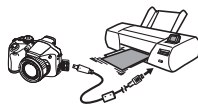

Printing with a Computer

After transferring the images to your computer, use commercially available software to print.

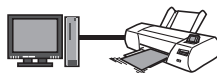

- You can specify which images you want to print, the number of copies, and date stamp settings before printing (page 108).

Connecting Directly to a PictBridge Compatible Printer

You can connect the camera directly to a printer that supports PictBridge and print images without going through a computer.

■ To set up the camera before connecting to a printer

1. Turn on the camera and press [MENU].
2. On the “Set Up” tab, select “USB” and then press [▶].
3. Use [▲] and [▼] to select “PTP (PictBridge)”, and then press [SET].

■ Connecting the Camera to a Printer

Use the USB cable that comes bundled with the camera to connect the camera to your printer's USB port.

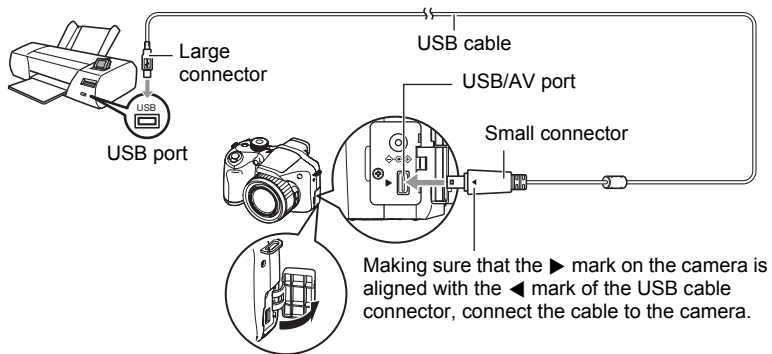

- The camera does not draw power over the USB cable. Check the battery level before connecting and make sure it is not too low.
- Make sure that you insert the cable connector into the USB/AV port until you feel it click securely into place. Failure to insert the connector fully can result in poor communication or malfunction.
- Note that even while the connector is fully inserted, you still will be able to see the metal part of the connector as shown in the illustration.
- When connecting the USB cable to a USB port, make sure you align the connector correctly with the port.
- Make sure that the camera is turned off before plugging in or unplugging the cable. Check the user documentation that comes with the printer for information about requirements before plugging into or unplugging from the printer.

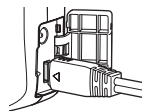

■ To print

1. Turn on the printer and load paper.

2. Turn on the camera.

This will display the print menu screen.

3. Use [▲] and [▼] to select “Paper Size”, and then press [▶].

4. Use [▲] and [▼] to select a paper size and then press [SET].

- The following are the available paper sizes.
3.5"×5", 5"×7", 4"×6", A4, 8.5"×11", By Printer
 - Selecting “By Printer” prints using a paper size selected on the printer.
 - See the documentation that comes with your printer for information about paper settings.
-

5. Use [▲] and [▼] to specify the print option you want.

1 Image : Prints one image. Select and then press [SET]. Next, use [◀] and [▶] to select the image you want to print.

DPOF Printing: Prints multiple images. Select and then press [SET]. With this option, images will be printed in accordance with DPOF settings (page 108).

- To toggle date stamping on and off, press [BS]. The date stamp will be printed when “On” is indicated on the monitor screen.
-

6. Use [▲] and [▼] to select “Print” and then press [SET].

Printing will start and the message “Busy... Please wait...” will appear on the monitor screen. The message will disappear after a short while, even though printing is still being performed. Pressing any camera button will cause the printing status to re-appear. The print menu screen will re-appear when printing is complete.

- If you selected “1 Image”, you can repeat the procedure from step 5, if you want.
-

7. After printing is complete, turn off the camera and disconnect the USB cable from the printer and camera.

Using DPOF to Specify Images to be Printed and the Number of Copies

■ Digital Print Order Format (DPOF)

DPOF is a standard that allows you to include image type, number of copy, and time stamp on/off information on the memory card with the images. After configuring settings, you can use the memory card to print on a home printer that supports DPOF or take the memory card to a professional print service.



- Whether or not you will be able to use DPOF settings for printing depends on the printer you are using.
- Some professional print services may not support DPOF.

■ Configuring DPOF Settings Individually for Each Image

Procedure

[] (PLAY) → Snapshot Screen → [MENU] → PLAY Tab → DPOF Printing → Select images

1. Use [] and [] to scroll through the files until the image you want to print is displayed.

2. Use [] and [] to specify the number of copies.
You can specify a value up to 99. Specify 00 if you do not want to print the image.
 - If you want to include the date in the images, press [BS] so “On” is shown for date stamping.
 - Repeat steps 1 and 2 to configure settings for other images, if you want.

3. Press [SET].

■ Configuring the Same DPOF Settings for All the Images

▶ Procedure

[▶] (PLAY) → Snapshot Screen → [MENU] → PLAY Tab → DPOF Printing → All images

1. Use [▲] and [▼] to specify the number of copies.

You can specify a value up to 99. Specify 00 if you do not want to print the image.

- If you want to include the date in the images, press [BS] so "On" is shown for date stamping.

2. Press [SET].

DPOF settings are not cleared automatically after printing is complete.

The next DPOF print operation you execute will be performed using the last DPOF settings you configured for the images. To clear DPOF settings, specify "00" for the number of copies of all images.

Tell your print service about your DPOF settings!

If you take a memory card to a professional print service, be sure to tell them that it includes DPOF settings for the images to be printed and the number of copies. If you don't, the print service may print all the images without regard to your DPOF settings, or they may ignore your date stamp setting.

■ Date Stamping

You can use one of the following three methods to include the recording date in the printout of an image.

Configuring camera settings	Configure DPOF settings (page 108). You can turn date stamping on and off each time you print. You can configure settings so some images include the date stamp and some don't.
	Configure the Camera's Timestamp setting (page 129). <ul style="list-style-type: none">• The camera's Timestamp setting imprints the date into a snapshot when you shoot it, so the date is always included when you print. It cannot be deleted.• Do not turn on DPOF date stamping for an image that includes a date stamped with the camera's Timestamp function. Doing so can cause the two stamps to be overprinted.
Configuring computer settings	You can use commercially available image management software to date stamp images.
Professional print service	Request date stamping when ordering prints from a professional print service.

■ Standards Supported by the Camera

- PictBridge

This is a standard of the Camera and Imaging Products Association (CIPA).



- PRINT Image Matching III

Using image editing software and printing on a printer that supports PRINT Image Matching III makes it possible to use information about shooting conditions that is recorded with the image, and produce exactly the type of image you want. PRINT Image Matching and PRINT Image Matching III are trademarks of Seiko Epson Corporation.



- Exif Print



Printing on a printer that supports Exif Print (Exif 2.2) uses information about shooting conditions recorded with the image to enhance printed image quality. Contact your printer manufacturer for information about models that support Exif Print, printer upgrades, etc.



Using the Camera with a Computer

Things you can do using a computer...

You can perform the operations described below while the camera is connected to a computer.

Save images to a computer and view them there 	<ul style="list-style-type: none">• Save images and view them manually (USB connection) (pages 113, 119).
Playback and edit movies 	<ul style="list-style-type: none">• You can play back movies (pages 116, 121).• To edit movies, use commercially available software as required.

The procedures you need to perform when using the camera with your computer and when using the bundled software are different for Windows and the Macintosh.

- Windows users should refer to “Using the Camera with a Windows Computer” on page 112.
- Macintosh users should refer to “Using the Camera with a Macintosh” on page 119.

Using the Camera with a Windows Computer

Install the required software in accordance with the version of Windows you are running and what you want to do.

When you want to do this:	Operating System Version	Install this software:	See page:
Save images to a computer and view them there manually	Vista / XP / 2000	Installation not required.	113
Play movies	Vista / XP / 2000	<p>DirectX 9.0c Windows 2000 Users of the above operating systems also need to install DirectX 9.0c if DirectX 9.0 or greater is not already installed on your system.</p> <ul style="list-style-type: none"> Windows Media Player is not included on the CD-ROM that comes bundled with the camera, but it is included with Windows. Use the Windows Media Player application that is installed with Windows for playback. 	116
Edit movies	Vista / XP / 2000	<p>–</p> <ul style="list-style-type: none"> Use commercial software as required. 	–
Upload movie files to YouTube	Vista / XP (SP2) / 2000 (SP4)	YouTube Uploader for CASIO	116
View the User's Guide	Vista / XP (SP2) / 2000 (SP4)	Adobe Reader 8 (Not required if already installed.)	118

■ Computer System Requirements for Bundled Software

Computer system requirements are different for each of the applications. See the “Read me” file that comes with each application for details. Information about computer system requirements also can be found under “Computer System Requirements for Bundled Software” on page 153 of this manual.

■ Precautions for Windows Users

- The bundled software will not run under 64-bit versions of Windows Vista.
- Except for DirectX and Adobe Reader, the bundled software requires Administrator privileges to run.
- Operation on under a dual-processor environment is not supported.
- Operation may not be possible under certain computer environments.

Viewing and Storing Images on a Computer

You can connect the camera to your computer in order to view and store images (snapshot and movie files).

■ To connect the camera to your computer and save files

1. Turn on the camera and press [MENU].
2. On the “Set Up” tab, select “USB” and then press [▶].
3. Use [▲] and [▼] to select “Mass Storage”, and then press [SET].

4. Turn off the camera and then use the USB cable that comes with the camera to connect it to your computer.

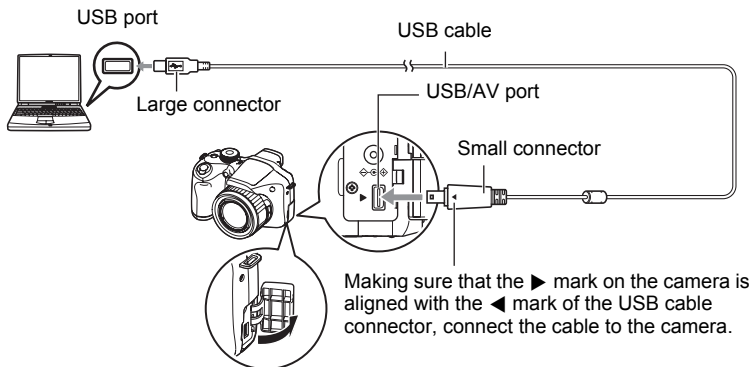

- The camera does not draw power over the USB cable. Check the battery level before connecting and make sure it is not too low.
- Make sure that you insert the cable connector into the USB/AV port until you feel it click securely into place. Failure to insert the connector fully can result in poor communication or malfunction.
- Note that even while the connector is fully inserted, you still will be able to see the metal part of the connector as shown in the illustration.
- When connecting the USB cable to a USB port, make sure you align the connector correctly with the port.
- Your computer may not be able to recognize the camera if you connect via a USB hub. Always connect directly to the computer's USB port.

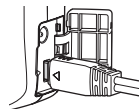

5. Turn on the camera.

6. Copy images to your computer.

Windows XP

- ① Select "Open folder to view files" and then click "OK".
- ② Drag the "DCIM" folder to your Windows desktop to copy it.

Windows Vista

- ① Select "Open folder to view files".
- ② Drag the "DCIM" folder to your Windows desktop to copy it.

Windows 2000

- ① Double-click "My Computer".
- ② Double-click "Removable Disk".
- ③ Drag the "DCIM" folder to your Windows desktop to copy it.

7. After you finish copying images, disconnect the camera from the computer.

Windows Vista, Windows XP

On the camera, press [ON/OFF] to turn off the camera. After making sure that the back lamp is unlit, disconnect the camera from the computer.

Windows 2000

Click card services in the task tray on your computer screen, and disable the drive number assigned to the camera. Next, after making sure that the back lamp is unlit, press the camera's [ON/OFF] button to turn off the camera and disconnect the camera from your computer.

■ To view images you copied to your computer

1. Double-click the copied "DCIM" folder to open it.

2. Double-click the folder that contains the images you want to view.

3. Double-click the image file you want to view.

- For information about file names, see "Memory Folder Structure" on page 124.
- An image that was rotated on the camera will be displayed on your computer screen in its original (unrotated) orientation.



IMPORTANT!

- Never use your computer to modify, delete, move, or rename any image files that are in the camera's built-in memory or on its memory card. Doing so can cause problems with the camera's image management data, which will make it impossible to play back images on the camera and can drastically alter remaining memory capacity. Whenever you want to modify, delete, move, or rename an image, do so only on images that are stored on your computer.
- Never unplug the USB cable, or operate the camera while viewing or storing images. Doing so can cause data to become corrupted.

Playing Movies

Windows Media Player, which is already installed on most computers, can be used for movie playback. To play back a movie, first copy the movie to your computer and then double-click the movie file.

■ Minimum Computer System Requirements for HD Movie Playback

The minimum system requirements described below are necessary to play back HD movies recorded with this camera on a computer.

Operating System : Vista / XP / 2000

CPU : Pentium 4, 3.2 GHz or higher

Required Software: Windows Media Player, DirectX 9.0c or higher

- The above are recommended system environments. Configuring one of these environments does not guarantee proper operation.
- Certain settings and other installed software may interfere with proper playback of movies.

■ Movie Playback Precautions

- Be sure to move the movie data to the hard disk of your computer before trying to play it. Proper movie playback may not be possible for data accessed over a network, from a memory card, etc.
- Proper movie playback may not be possible on some computers. If you experience problems, try the following.
 - Try recording movies with a quality setting of "STD".
 - Try upgrading Windows Media Player to the latest version.
 - Quit any other applications you have running, and stop resident applications.

Even if proper playback is not possible on the computer, you can use the AV cable that comes bundled with the camera to connect to the video input terminal a TV or computer and play back movies that way.

Uploading Movie Files to YouTube

Installing YouTube Uploader for CASIO from the CD-ROM that comes with your camera simplifies uploading of movie files you recorded with the YouTube mode to YouTube.

■ What is YouTube?

YouTube is a movie sharing site managed by YouTube, LLC where you can upload movies and view movies uploaded by others.

■ To install YouTube Uploader for CASIO

1. On the CD-ROM menu screen, select “YouTube Uploader for CASIO”.

2. After reading the information about installation conditions and system requirements for installation in the “Read me” file, install YouTube Uploader for CASIO.

■ To upload a movie file to YouTube

- Before you can use YouTube Uploader for CASIO, you need to go to the YouTube website (<http://www.youtube.com/>) and register as a user there.
- Do not upload any video that is copyrighted (including neighboring copyrights) unless you yourself own the copyright or you have obtained the permission of the applicable copyright holder(s).
- The maximum file size for each upload is 100 MB or 10 minutes of playing time.

1. Record the movie you want to upload using the YouTube mode (page 62).

2. If it isn't already, connect your computer to the Internet.

3. Connect the camera to your computer (page 113).

4. Turn on the camera.

YouTube Uploader for CASIO will start up automatically.

 - If this is the first time you are using the application, configure the YouTube user ID and network environment settings, and then click the [OK] button.

5. The left side of the display will have an area for inputting a title, category, and other information required for uploading to YouTube. Enter the required information.

6. The right side of the display shows a list of movie files in camera memory. Select the check box next to the movie file you want to upload.

7. When everything is ready, click the [Upload] button.

This will upload the movie file(s) to YouTube.

 - After uploading is complete, click the [Exit] button to exit the application.

Viewing User Documentation (PDF Files)

1. Start up your computer, and place the bundled CD-ROM into its CD-ROM drive.

Normally, this should cause the menu screen to appear automatically. If your computer does not display the menu screen automatically, navigate to the CD-ROM on your computer and then double-click the "AutoMenu.exe" file.

2. On the menu screen, click the "Language" down arrow button and then select the language you want.

3. Click "Manual" to select it and then click "Digital Camera".



IMPORTANT!

- You must have Adobe Reader or Adobe Acrobat Reader installed on your computer in order to view the contents of a PDF file. If you do not already have Adobe Reader or Adobe Acrobat Reader installed, install Adobe Reader from the bundled CD-ROM.

User Registration

You can perform user registration over the Internet. To do so, of course, you need to be able to connect to the Internet with your computer.

1. On the CD-ROM menu screen, click the "Register" button.

- This starts up your Web browser and accesses the user registration website. Follow the instructions that appear on your computer screen to register.

Using the Camera with a Macintosh

Install the required software in accordance with what version of the Macintosh OS you are running and what you want to do.

When you want to do this:	Operating System Version	Install this software:	See page:
Save images to your Macintosh and view them there manually	Mac OS 9	Installation not required.	119
	Mac OS X		
Save images to your Macintosh automatically/Manage images	Mac OS 9	Use commercially available software.	121
	Mac OS X	Use iPhoto, which comes bundled with your operating system.	
Play movies	Mac OS 9 / OS X	You can playback with QuickTime, which comes bundled with your operating system.	121

Connecting the Camera to Your Computer and Saving Files



IMPORTANT!

- The camera does not support operation with Mac OS 8.6 or earlier, or Mac OS X 10.0. Operation is supported with Mac OS 9, X (10.1, 10.2, 10.3, 10.4, 10.5) only. Use the standard USB driver that comes with your supported operating system.

■ To connect the camera to your computer and save files

1. Turn on the camera and press [MENU].
2. On the “Set Up” tab, select “USB” and then press [▶].
3. Use [▲] and [▼] to select “Mass Storage”, and then press [SET].

4. Turn off the camera and then use the USB cable that comes with the camera to connect it to your Macintosh.

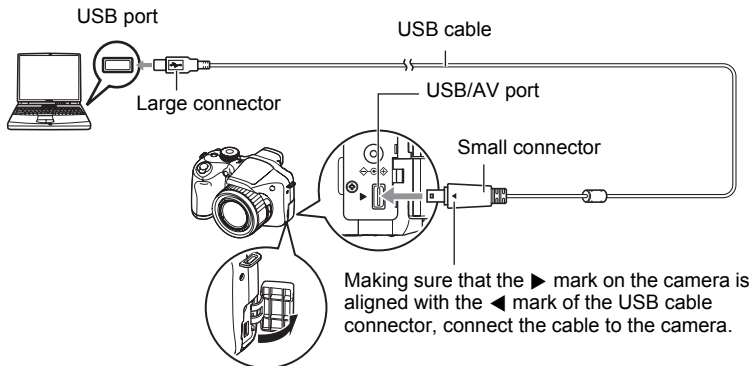

- The camera does not draw power over the USB cable. Check the battery level before connecting and make sure it is not too low.
- Make sure that you insert the cable connector into the USB/AV port until you feel it click securely into place. Failure to insert the connector fully can result in poor communication or malfunction.
- Note that even while the connector is fully inserted, you still will be able to see the metal part of the connector as shown in the illustration.
- When connecting the USB cable to a USB port, make sure you align the connector correctly with the port.
- Your computer may not be able to recognize the camera if you connect via a USB hub. Always connect directly to the computer's USB port.

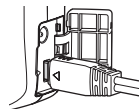

5. Turn on the camera.

The camera's back lamp will light green at this time. In this mode, your Macintosh recognizes the memory card loaded in the camera (or the camera's built-in memory if it does not have a memory card loaded) as a drive. The appearance of the drive icon depends on the Mac OS version you are using.

6. Double-click the camera's drive icon.

7. Drag the "DCIM" folder to the folder to which you want to copy it.

-
8. After the copy operation is complete, drag the drive icon to Trash.
 9. On the camera, press [ON/OFF] to turn off the camera. After making sure that the green back lamp is unlit, disconnect the camera from the computer.

■ To view copied images

1. Double-click the camera's drive icon.
2. Double-click the "DCIM" folder to open it.
3. Double-click the folder that contains the images you want to view.
4. Double-click the image file you want to view.
 - For information about file names, see "Memory Folder Structure" on page 124.
 - An image that was rotated on the camera will be displayed on your Macintosh screen in its original (unrotated) orientation.



IMPORTANT!

- Never use your computer to modify, delete, move, or rename any image files that are in the camera's built-in memory or on its memory card. Doing so can cause problems with the camera's image management data, which will make it impossible to play back images on the camera and can drastically alter remaining memory capacity. Whenever you want to modify, delete, move, or rename an image, do so only on images that are stored on your computer.
- Never unplug the USB cable, or operate the camera while viewing or storing images. Doing so can cause data to become corrupted.

Transferring Images Automatically and Managing Them on Your Macintosh

If you are running Mac OS X, you can use the iPhoto application that comes bundled with the operating system to manage your images. If you are running Mac OS 9, you will need to use commercially available software.

Playing a Movie

You can use QuickTime, which comes bundled with your operating system, to play back movies on a Macintosh. To play back a movie, first copy it to your Macintosh and then double-click the movie file.

■ Minimum Computer System Requirements for HD Movie Playback

The minimum system requirements described below are necessary to play back HD movies recorded with this camera on a computer.

Operating System : Mac OS X 10.3.9 or higher

Required Software : QuickTime 7 or higher

- The above are recommended system environments. Configuring one of these environments does not guarantee proper operation.
- Certain settings and other installed software may interfere with proper playback of movies.

■ Movie Playback Precautions

Proper movie playback may not be possible on some Macintosh models. If you experience problems, try the following.

- Change the movie image quality setting to “STD”.
- Upgrade to the latest version of QuickTime.
- Shut down other applications that are running.

Even if proper playback is not possible on your Macintosh, you can use the AV cable that comes bundled with the camera to connect to the video input terminal a TV or Macintosh and play back movies that way.

IMPORTANT!

- Be sure to move the movie data to the hard disk of your Macintosh before trying to play it. Proper movie playback may not be possible for data accessed over a network, from a memory card, etc.

Viewing User Documentation (PDF Files)

You must have Adobe Reader or Adobe Acrobat Reader installed on your computer in order to view the contents of a PDF file. If you don't, go to the Adobe Systems Incorporated website and install Acrobat Reader.

1. On the CD-ROM, open the “Manual” folder.
2. Open the “Digital Camera” folder and then open the folder for the language whose user's guide you want to view.
3. Open the file named “camera_xx.pdf”.
 - “xx” is the language code (Example: camera_e.pdf is for English.)

User Registration

Internet registration only is supported. Visit the following CASIO website to register:
<http://world.casio.com/qv/register/>

Files and Folders

The camera creates a file and saves it each time you shoot a snapshot, record a movie, or perform any other operation that stores data. Files are grouped by storing them in folders. Each file and folder has its own unique name.

- For details about how folders are organized in memory, see “Memory Folder Structure” (page 124).

Name and Maximum Number Allowed	Example
File	
Each folder can contain up to 9999 files named CIMG0001 through CIMG9999. The extension on the file name depends on the file type.	26th file name: CIMG0026.JPG Serial number Extension (4 digits)
Folders	
Folders are named from 100CASIO to 999CASIO There can be up to 900 folders in memory. <ul style="list-style-type: none">• Images recorded with the YouTube mode are stored in a folder named “100YOUTB”.	100th folder name: 100CASIO Serial number (3 digits)

- You can view folder and file names on your computer. For details about how file names are displayed on the camera’s monitor screen, see page 157.
- The total number of folders and files allowed depends on the image size and quality, and capacity of the memory card being used for storage.

Memory Card Data

The camera stores images you shoot in accordance with the Design Rule for Camera File System (DCF).

■ About DCF

DCF is a standard that makes it possible to view and print images recorded on one manufacturer's camera on DCF-compliant devices produced by other manufacturers. You can transfer DCF-compliant images recorded with another camera to this camera and view them on this camera's monitor screen.

■ Memory Folder Structure

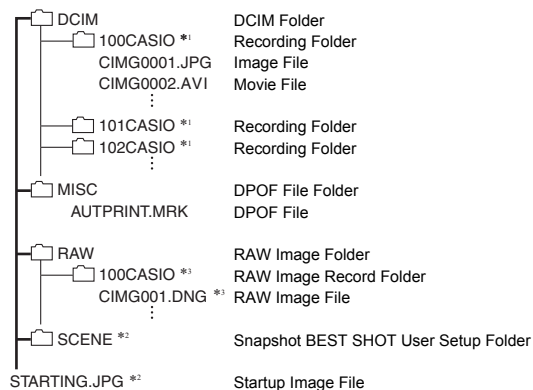

*1 The YouTube mode can be used to record movies are optimized for uploading to YouTube. Images recorded with the YouTube mode are stored in a folder named "100YOUTB".

*2 This folder or file can be created in built-in memory only.

*3 RAW image data is stored with the same file name in a folder with the same folder name as the corresponding JPEG memory that is recorded at the same time.

■ Supported Image Files

- Image files shot with this camera
- DCF-compliant image files

This camera may not be able to display an image, even if it is DCF-compliant. When displaying an image recorded on another camera, it may take a long time for the image to appear on this camera's monitor screen.

■ Built-in Memory and Memory Card Data Handling Precautions

- Whenever copying memory contents to your computer, you should copy the DCIM folder and all of its contents. A good way to keep track of multiple DCIM folders is to change their names to dates or something similar after you copy them to your computer. If you later decided to return a DCIM folder to the camera, however, be sure to change its name back to DCIM. The camera is designed to recognize only a root file with the name DCIM. Note the camera also will not be able to recognize the folders inside the DCIM folder unless they have the names they originally had when you copied them from the camera to your computer.
- Folders and files must be stored in accordance with the "Memory Folder Structure" shown on page 124 in order for the camera to be able to recognize them correctly.
- You also can use a PC card adapter or a memory card reader/writer to access camera files directly from the camera's memory card.

Other Settings (Set Up)

This section explains menu items that you can use to configure settings and perform other operations in both the REC mode and PLAY mode.

For information about menu operations, see page 76.

Adjusting Monitor Screen Brightness (Screen)

Procedure

[MENU] → Set Up Tab → Screen

Auto 2/ Auto 1	With this setting, the camera detects available light levels and automatically adjusts the brightness of the monitor screen accordingly. "Auto 2" changes monitor screen brightness relatively more quickly than "Auto 1" when surrounding light is bright.
+2	Brightness that is greater than +1, which makes the screen easier to view. This setting consumes more power.
+1	Bright setting for outdoor use, etc. Brightness that is greater than 0.
0	Normal monitor screen brightness for indoor use, etc.

Adjusting Viewfinder Brightness (EVF Brightness)

Procedure



[MENU] → Set Up Tab → EVF Brightness

You can use the above procedure to change the brightness of the viewfinder. You can select one of three levels from +2 (brightest) to 0 (normal).

Configuring Camera Sound Settings (Sounds)

Procedure

[MENU] → Set Up Tab → Sounds

Startup	
Half Shutter	Specifies the startup sound
Shutter	Sound 1 - 5: Built-in sounds (1 through 5) Off: Sound off
Operation	
 Operation	Specifies the sound volume. This setting is also used as the audio level during video output (page 133).
 Play	Specifies the volume of movie audio output. This volume setting is not used during video output (from the USB/AV port) (page 133).

- Setting a volume level of 0 mutes output.

Specifying the File Name Serial Number Generation Rule (File No.)

Procedure

[MENU] → Set Up Tab → File No.

Use the following procedure to specify the rule that governs generation of the serial number used in file names (page 123).

Continue	Tells the camera to remember the last used file number. A new file will be named using the next sequential number, even if files are deleted or if a blank memory card is loaded. If a memory card is loaded and that card already has files stored on it and the largest sequential number in the existing file names is greater than the largest sequential number remembered by the camera, numbering of new files will start from the largest sequential number in the existing file names plus 1.
Reset	Restarts the serial number from 0001 whenever all files are deleted or when the memory card is replaced with a blank one. If a memory card is loaded and that card already has files stored on it, numbering of new files will start from the largest sequential number in the existing file names number plus 1.

Configuring World Time Settings (World Time)

Procedure

[MENU] → Set Up Tab → World Time

You can use the World Time screen to view the current time in a zone that is different from your Home City when you go on a trip, etc. World Time displays the current time in 162 cities in 32 time zones around the globe.

1. Use [▲] and [▼] to select “World” and then press [▶].

- To change the geographic area and city for the time where you normally use the camera, select “Home”.

2. Use [▲] and [▼] to select “City” and then press [▶].

- To change the “World” setting to summer time, use [▲] and [▼] to select “DST” and then select “On”. Summer time is used in some geographical areas to advance the current time setting by one hour during the summer months.

3. Use [▲], [▼], [◀], and [▶] to select the geographic area you want and then press [SET].

4. Use [▲] and [▼] to select the city you want and then press [SET].

5. Press [SET].

Time Stamping Snapshots (Timestamp)

Procedure

[MENU] → Set Up Tab → Timestamp

You can configure the camera to stamp the recording date only, or date and time in the lower right corner of each snapshot.

- Once date and time information is stamped into a snapshot, it cannot be edited or deleted.

Example: December 19, 2009, 1:25 p.m.

Date	2009/12/19
Date&Time	2009/12/19 1:25pm
Off	No stamping of date and/or time

- Even if you do not stamp the date and/or time with Timestamp, you can do so later using the DPOF function or some printing application (page 110).
- Stamping is performed in accordance with the date and time settings (page 129) and the display style settings (page 130).

Setting the Camera's Clock (Adjust)

Procedure

[MENU] → Set Up Tab → Adjust

[▲] [▼]	Change the setting at the cursor location
[◀] [▶]	Move the cursor between settings
[BS]	Toggles between 12-hour and 24-hour format

When the date and time settings are what you want, press [SET] to apply them.

- You can specify a date from 2001 to 2049.
- Be sure to select your Home City (page 128) before setting the time and date. If you set the time and date while the wrong city is selected for your Home City, the times and dates of all of the World Time cities (page 128) will be wrong.

Specifying the Date Style (Date Style)

Procedure

[MENU] → Set Up Tab → Date Style

You can select from among three different styles for the date.

Example: December 19, 2009

YY/MM/DD	09/12/19
DD/MM/YY	19/12/09
MM/DD/YY	12/19/09

- This setting also affects the control panel date format as shown below (page 28).
YY/MM/DD or MM/DD/YY: MM/DD
DD/MM/YY: DD/MM

Specifying the Display Language (Language)

Procedure

[MENU] → Set Up Tab → Language

■ Specify the display language you want.

- ① Select the tab on the right.
- ② Select "Language".
- ③ Select the language you want.



Configuring Sleep State Settings (Sleep)

Procedure

[MENU] → Set Up Tab → Sleep

This feature turns off the monitor screen whenever no camera operation is performed for a preset amount of time. Press any button to turn the monitor screen back on.

Trigger Time Settings: 30 sec, 1 min, 2 min, Off (Sleep is disabled while "Off" is selected.)

- Sleep is disabled under any of the following conditions.
 - In the PLAY Mode
 - While the camera is connected to a computer or other device
 - During a slideshow
 - During movie recording and playback
 - During Move Out CS or Move In CS auto record standby
 - When both sleep and Auto Power Off are turned on, Auto Power Off takes priority.

Configuring Auto Power Settings (Auto Power Off)

Procedure

[MENU] → Set Up Tab → Auto Power Off

Auto Power Off turns off the camera whenever no camera operation is performed for a preset amount of time.

Trigger Time Settings: 2 min, 5 min, 10 min (The trigger time is always 5 minutes in the PLAY mode.)

- Auto Power Off is disabled under any of the following conditions.
 - While the camera is connected to a computer or other device
 - During a slideshow
 - During CS group playback
 - During movie recording and playback
 - During Move Out CS or Move In CS auto record standby
 - While the AC adaptor is being used for power

Configuring [📷] and [▶] Settings (REC/PLAY)

Procedure

[MENU] → Set Up Tab → REC/PLAY

Power On	Camera turns on whenever [📷] (REC) or [▶] (PLAY) is pressed.
Power On/Off	Camera turns on or off whenever [📷] (REC) or [▶] (PLAY) is pressed.
Disable	Camera does not turn on or off whenever [📷] (REC) or [▶] (PLAY) is pressed.

- With “Power On/Off”, the camera turns off when you press [📷] (REC) in the REC mode or [▶] (PLAY) in the PLAY mode.
- Change this setting to anything besides “Disable” before connecting to a TV for image viewing.

Controlling Monitor Screen Priority (LCD Priority)

Procedure

[MENU] → Set Up Tab → LCD Priority

You can use this setting to control when the monitor screen turns on.

On	With this setting, the viewfinder display turns off and the monitor screen turns on, regardless of the monitor screen/viewfinder setting selected using the [EVF/LCD] button (page 136), during playback, menu display, and BEST SHOT scene selection.
Off	With this setting, the monitor screen/viewfinder operation (page 136) is always in accordance with the setting selection with the [EVF/LCD] button.

Configuring USB Protocol Settings (USB)

Procedure

[MENU] → Set Up Tab → USB

You can use the procedure below to select the USB communication protocol, which is used when exchanging data with a computer, printer, or other external device.

Mass Storage	Select this setting when connecting to a computer (pages 113, 119). With this setting, the computer sees the camera as an external storage device. Use this setting for normal transfer of images from the camera to a computer.
PTP (PictBridge)	Select this setting when connecting to a printer that supports PictBridge (page 106). This setting simplifies the transfer of image data to the connected device.

Selecting the Screen Aspect Ratio and Video Output System (Video Out)

Procedure

[MENU] → Set Up Tab → Video Out

You can use the procedure in this section to select either NTSC or PAL as the video output system. You can also specify an aspect ratio of 4:3 or 16:9.

NTSC	Video system used in Japan, the U.S., and other countries
PAL	Video system used in Europe and other areas
4:3	Normal TV screen aspect ratio
16:9	Wide screen aspect ratio

- Select the aspect ratio (4:3 or 16:9) that matches the type of TV you plan to use. Images will not display correctly if you select the wrong aspect ratio.
- Images will not display correctly unless the camera's video signal output setting matches the video signal system of the TV or other video equipment.
- Images cannot be displayed correctly on a TV or video equipment that is not NTSC or PAL.
- REC mode video output is supported only when the aspect ratio setting is 16:9.

Specifying the Battery Type (Battery Type)

Procedure

[MENU] → Set Up Tab → Battery Type

See page 15 for details.

Configuring a Startup Image (Startup)

Procedure

[MENU] → Set Up Tab → Startup

Display the image you want to use as your startup image and then select “On”.

- The startup image does not appear when you turn on the camera by pressing [▶] (PLAY).
- You can specify a snapshot you recorded as the startup image, or you can use the special startup image provided in the camera’s built-in memory.
- Formatting built-in memory (page 135) will delete the current startup image setting.
- You can select the first snapshot of a CS group as the startup image. If you want to select another image within a CS group, you need to first divide up the CS group or use the frame select feature to make a copy of the image outside of the CS group.

Formatting Built-in Memory or a Memory Card (Format)

Procedure

[MENU] → Set Up Tab → Format

If a memory card is loaded in the camera, this operation will format the memory card. It will format built-in memory if no memory card is loaded.

- The format operation will delete all contents on the memory card or in built-in memory. It cannot be undone. Make sure you do not need any data currently on the card or in built-in memory before you format it.
- Formatting built-in memory will delete the following data.
 - Protected images
 - BEST SHOT user setups
 - Startup screen
- Formatting a memory card will delete the following data.
 - Protected images
- Check the battery level before starting a format operation and make sure it is not too low. Formatting may not be performed correctly and the camera may stop operating normally if the camera powers down while formatting is in progress.
- Never open the battery cover while formatting is in progress. Doing so can cause the camera to stop operating normally.

Resetting the Camera to Factory Defaults (Reset)

Procedure

[MENU] → Set Up Tab → Reset

See page 159 for details about the camera's factory default settings.

Configuring Monitor Screen Settings

Turning Display Information On and Off (Info)

Each press of [DISP] will cycle through display settings that display or hide on-screen information and the control panel. You can configure separate settings for the REC mode and PLAY mode.

Information on, control panel on	Displays setting information and the control panel.
Information on, control panel on, histogram on	Displays setting information and the control panel, and a histogram (page 137) on the left side of the display.  Histogram
Information off, control panel off	Hides setting information and the control panel.

- The control panel is not displayed and display information settings cannot be changed during movie recording.

Selecting Monitor Screen and Viewfinder Settings

Each press of the [EVF/LCD] button cycles through the available monitor screen and viewfinder on/off settings.

- Both the monitor screen and viewfinder cannot be turned on at the same time.

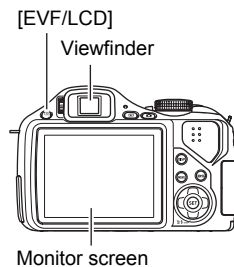

Using the On-screen Histogram to Check Exposure (+Histogram)

Displays a histogram on the monitor screen which you can use to check the exposure of an image before you shoot it. You also can display the histogram in the PLAY mode for information about the exposure levels of images.



Histogram

NOTE

- A centered histogram does not necessarily guarantee optimum exposure. The recorded image may be over-exposed or under-exposed, even though its histogram is centered.
- Due to the limitations of exposure compensation, you may not be able to achieve an optimum histogram configuration.
- Use of the flash and certain shooting conditions can cause the histogram to indicate exposure that is different from the actual exposure of the image when it is shot.
- The histogram cannot be displayed during High-speed Movie recording.

How to Use the Histogram

A histogram is a graph that represents the lightness of an image in terms of the number of pixels. The vertical axis indicates the number of pixels, while the horizontal axis indicates lightness. If the histogram appears too lopsided for some reason, you can use EV shift to move it left or right in order to achieve better balance. Optimum exposure can be achieved by EV shifting so the graph is as close to the center as possible. For snapshots, you can even display individual histograms for R (red), G (green), and B (blue).

Example Histograms

A histogram towards the left side results when the overall image is dark. A histogram that is too far to the left may result in “black out” of the dark areas of an image.

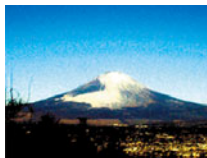

A histogram towards the right side results when the overall image is light. A histogram that is too far to the right may result in “white out” of the light areas of an image.



An overall well-balanced histogram results when the overall image is at optimal lightness.



Precautions during Use

■ Avoid Use While In Motion

- Never use the camera to record or play back images while operating an automobile or other vehicle, or while walking. Looking at the monitor while in motion creates the risk of serious accident.

■ Directly Viewing the Sun or Bright Light

- Never look at the sun or any other bright light through the camera's viewfinder. Doing so can damage your eyesight.

■ Flash

- Never use the flash unit in areas where flammable or explosive gas may be present. Such conditions create the risk of fire and explosion.
- Never fire the flash in the direction of a person operating a motor vehicle. Doing so can interfere with the driver's vision and creates the risk of accident.
- Never fire the flash too close to the eyes of the subject. Doing so creates the risk of loss of eyesight.

■ Display Panel

- Do not apply strong pressure to the LCD panel surface or subject it to strong impact. Doing so can cause the display panel glass to crack.
- Should the display panel ever become cracked, never touch any of the liquid inside the panel. Doing so creates the risk of skin inflammation.
- Should display panel liquid ever get into your mouth, immediately rinse your mouth out and contact your physician.
- Should display panel liquid ever get into your eyes or onto your skin, immediately rinse with clean water for at least 15 minutes and contact your physician.

■ Connections

- Never plug any devices that are not specified for use with this camera into connectors. Connecting a non-specified device creates the risk of fire and electric shock.

■ Transport

- Never operate the camera inside of an aircraft or anywhere else where operation of such devices is restricted. Improper use creates the risk of serious accident.

■ **Smoke, abnormal odor, overheating, and other abnormalities**

- Continued use of the camera while it is emitting smoke or strange odor, or while it is overheating creates the risk of fire and electric shock. Immediately perform the following steps whenever any of the above symptoms are present.
 1. Turn off the camera.
 2. Remove the batteries from the camera, taking care to protect yourself against burn injury.
 3. Contact your dealer or nearest CASIO authorized service center.

■ **Water and Foreign Matter**

- Water, other liquids, or foreign matter (especially metal) getting inside the camera creates the risk of fire and electric shock. Immediately perform the following steps whenever any of the above symptoms are present. Particular care is required when using the camera where it is raining or snowing, near the ocean or other body of water, or in a bathroom.
 1. Turn off the camera.
 2. Remove the batteries from the camera.
 3. Contact your dealer or nearest CASIO authorized service center.

■ **Dropping and Rough Treatment**

- Continued use of the camera after it is damaged by dropping or other rough treatment creates the risk of fire and electric shock. Immediately perform the following steps whenever any of the above symptoms are present.
 1. Turn off the camera.
 2. Remove the batteries from the camera.
 3. Contact your dealer or nearest CASIO authorized service center.

■ **Keep Away From Fire**

- Never expose the camera to fire, which can cause it to explode and creates the risk of fire and electric shock.

■ **Disassembly and Modification**

- Never try to take the camera apart or modify it in any way. Doing so creates the risk of electric shock, burn injury, and other personal injury. Be sure to leave all internal inspection, maintenance, and repair up to your dealer or nearest CASIO authorized service center.

■ Locations To Be Avoided

- Never leave the camera in any of the following types of locations. Doing so creates the risk of fire and electric shock.
 - Areas subject to large amounts of humidity or dust
 - Food preparation areas or other locations where oil smoke is present
 - Near heaters, on a heated carpet, in areas exposed to direct sunlight, in a closed vehicle parked in the sun, or other areas subject to very high temperatures
- Never place the camera on an unstable surface, on a high shelf, etc. Doing so can cause the camera to fall, creating the risk of personal injury.

■ Backing Up Important Data

- Always keep backup copies of important data in camera memory by transferring it to a computer or other storage device. Note that data can be deleted in the case of camera malfunction, repair, etc.

■ Memory Protection

- Whenever replacing the batteries, be sure to follow the correct procedure as described in the documentation that comes with the camera. Incorrectly replacing the batteries can result in corruption or loss of data in camera memory.

■ Batteries

- Misuse of batteries can cause them to leak, which damages and corrodes the area around the batteries and creates the risk of fire and personal injury. Make sure you observe the following precautions when using batteries.
 - Never try to take batteries apart and never allow them to become shorted.
 - Do not expose batteries to heat or fire.
 - Never mix new batteries with old ones.
 - Never mix batteries of different types.
 - Do not charge non-rechargeable batteries.
 - When loading batteries, make sure their positive (+) and negative (–) ends are facing correctly.
 - When using rechargeable batteries, be sure to read the Safety Precautions section of the user documentation that comes with them.
 - Use only the batteries that are specified for this camera.
 - If you do not plan to use the camera for a long time, remove its batteries.

■ Alkaline Batteries

- Should liquid from an alkaline battery ever get into your eyes, take the following steps.
 1. Immediately rinse your eyes with clean water. Do not rub!
 2. See a physician as soon as possible.Failure to clean alkaline battery fluid from the eyes creates the risk of loss of sight.

■ Rechargeable Batteries

- Should you ever notice any of the following conditions while using, charging, or storing batteries, immediately remove them from the camera, and keep them away from open flame:
 - Fluid leaking
 - Emission of a strange odor
 - Heat emission
 - Battery discoloration
 - Battery deformation
 - Any other battery abnormality
- Failure to observe any of the following precautions while using batteries creates the risk of overheating, fire, and explosion.
 - Never use or leave batteries near open flame.
 - Never place batteries in a microwave oven, throw them into fire, or otherwise expose them to intense heat.
 - Make sure batteries are oriented correctly when you load them into the camera.
 - Never carry or store batteries together with items that can conduct electricity (necklaces, pencil lead, etc.).
 - Never try to take batteries apart, modify them in any way, or expose them to strong impact.
 - Do not immerse batteries in fresh water or salt water.
 - Do not use or leave batteries under direct sunlight, in an automobile parked in the sun, or in any other area subject to high temperatures.
- Battery fluid can damage your eyes. Should battery fluid get into your eyes accidentally, immediately rinse them with clean tap water and then consult a physician.
- If batteries are to be used by young children, make sure that a responsible adult makes them aware of the precautions and proper handling instructions, and make sure that they handle batteries correctly.
- Should fluid from batteries accidentally get onto clothing or your skin, immediately rinse it off with clean tap water. Prolonged contact with battery fluid can cause skin irritation.

■ Battery Life

- The battery lives noted in the User's Guide are approximate values until power fails, based on use of batteries of recommended brands at temperature 23°C (73°F), and do not guarantee you will be able to achieve operation for the life noted. Actual battery life is greatly affected by the battery brand, battery production date, and ambient temperature.
- Leaving the camera on can run down batteries and cause the low battery warning to appear. Turn off the camera whenever you are not using it.
- Sometimes, the camera may shutdown after the low battery warning appears. If this happens, immediately replace both of the batteries. Leaving low or dead batteries in the camera can lead to battery leakage and data corruption.
- Though you could use alkaline batteries when there are no other types of batteries available, note that the life of alkaline batteries will be very short. Use of rechargeable Ni-MH batteries is recommended.

■ Data Error Precautions

Your digital camera is manufactured using precision digital components. Any of the following creates the risk of corruption of data in camera memory and camera malfunction.

- Removing the batteries or memory card while the camera is performing some operation
- Removing the batteries or memory card while the back lamp is flashing green after turning off the camera
- Disconnecting the USB cable while communication is in progress
- Low battery power
 - * Note that continued use of weak batteries can lead to malfunction of the camera. Replace the batteries with new ones as soon as possible after signs of low power appear
- Other abnormal operations

Any of the above conditions can cause an error message to appear on the monitor screen (page 165). Perform the action indicated by the message that appears.

■ Operating Environment

- Operating Temperature: 0 to 40°C (32 to 104°F)
- Operating Humidity: 10 to 85% (non condensation)
- Do not place the camera in any of the following locations.
 - In an area exposed to direct sunlight, or large amounts of moisture or dust
 - Near an air conditioner or in other areas subjected to extreme temperature or humidity
 - Inside of a motor vehicle on a hot day, or in an area subjected to strong vibration

■ Condensation

Sudden and extreme temperature changes, such as when the camera is moved from the outdoors on a cold winter day into a warm room, can cause water droplets called “condensation” to form on the interior and the exterior of the camera, which creates the risk of malfunction. To prevent condensation from forming seal the camera in a plastic bag before changing locations. Then leave the bag sealed to allow the air inside to naturally change to the same temperature as the air in the new location. After that, remove the camera from the bag and open the battery cover for a few hours.

■ Lens

- Never apply too much force when cleaning the surface of the lens. Doing so can scratch the lens surface and cause malfunction.
- You may sometimes notice some distortion in certain types of images, such as a slight bend in lines that should be straight. This is due to the characteristics of lenses, and does not indicate malfunction of the camera.

■ Caring for your camera

- Never touch the lens or flash window with your fingers. Finger smudges, dirt, and other foreign matter on the lens or flash window can interfere with proper operation of the camera. Use a blower or other means to keep the lens and flash window free of dirt and dust, and wipe gently with a soft, dry cloth.
- To clean the camera, wipe it with a soft, dry cloth.

■ Old Battery Handling Precautions

- Insulate the positive and negative terminals with tape, etc.
- Do not peel the covering off of the battery.
- Do not try to take the battery apart.

■ Other Precautions

The camera becomes slightly warm during use. This is normal and does not indicate malfunction.

■ Copyrights

Except for your own personal enjoyment, unauthorized use of use of snapshots or movies of images whose rights belong to others, without the permission of the right holder, is forbidden by copyright laws. In some cases, shooting of public performances, shows, exhibitions, etc. may be restricted entirely, even if it is for your own personal enjoyment. Regardless of whether such files are purchased by you or obtained for free, posting them on a website, a file sharing site, or any other Internet site, or otherwise distributing them to third parties without the permission of the copyright holder is strictly prohibited by copyright laws and international treaties. For example, uploading or distributing on the Internet images of TV programs, live concerts, music videos, etc. that were photographed or recorded by you may infringe upon the rights of others. Note that CASIO COMPUTER CO., LTD. shall not be held liable for use of this product in any way that infringes on the copyrights of others or that violates copyright laws.

The following terms, which are used in this manual, are registered trademarks or trademarks of their respective owners.

Note that trademark [™] and registered trademark [®] are not use within the text of this manual.

- The SDHC logo is a trademark.
- Microsoft, Windows, Internet Explorer, and Windows Vista are registered trademarks or trademarks of Microsoft Corporation in the United States and other countries.
- Macintosh, Mac OS, QuickTime, and iPhoto are trademarks of Apple Inc.
- MultiMediaCard is a trademark of Infineon Technologies AG of Germany, and licensed to the MultiMediaCard Association (MMCA).
- MMC*plus* is a trademark of the MultiMediaCard Association.
- Adobe and Reader are trademarks or registered trademarks of Adobe Systems Incorporated in the United States and other countries.
- YouTube, the YouTube logo, and "Broadcast Yourself" are trademarks or registered trademarks of YouTube, LLC.
- EXILIM, and YouTube Uploader for CASIO are registered trademarks or trademarks of CASIO COMPUTER CO., LTD.
- All other company or product names mentioned herein are registered trademarks or trademarks of their respective companies.

Any and all unauthorized commercial copying, distribution, and copying of the bundled software over a network are prohibited.

This product contains PrKERNELv4 Real-time OS of eSOL Co., Ltd. Copyright© 2007 eSOL Co., Ltd.



PrKERNELv4 is a registered trademark of eSOL Co., Ltd. in Japan.

This product's YouTube upload functionality is included under license from YouTube, LLC. The presence of YouTube upload functionality in this product is not an endorsement or recommendation of the product by YouTube, LLC.

Power Supply

To replace the batteries

1. Open the battery cover and remove the current batteries.

2. Load a full set of new batteries.

- If the new batteries are a different type from the ones you removed, use "Battery Type" (page 15) to specify the type of the news batteries you are loading.

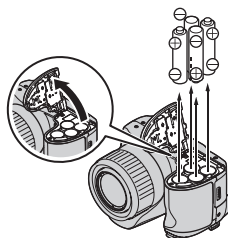

Battery Precautions

■ Precautions during Use

- Operation provided by a battery under cold conditions is always less than operation under normal temperatures. This is due to the characteristics of the battery, not the camera.
- Batteries may become warm to the touch when power is low. This is normal and does not indicate malfunction.

■ Storage Precautions

- Always remove the batteries from the camera when you are not using it. Leaving batteries in the camera can cause it to discharge and go dead, which will lead to malfunction of the camera.
- Remove batteries from the camera if you do not plan to use it for about two weeks or more.
- Store batteries in a cool, dry place (20°C (68°F) or lower).

■ Battery Handling Precautions

Misuse of batteries can cause them to leak or explode, which damages and corrodes the area around the batteries and creates the risk of fire and personal injury. Make sure you observe the following precautions when using batteries.

- When loading batteries, make sure their positive ⊕ and negative ⊖ ends are facing correctly.
- Never mix new batteries with old ones.
- Never mix batteries of different brands.
- Use only the batteries that are specified for this camera.
- Never try to take batteries apart and always take care to avoid conditions where their two ends can become connected to each other (shorting). Never expose batteries to heat or throw them into fire.
- Dead batteries are susceptible to leakage, which can cause serious damage to your camera. Remove batteries from the camera as soon as you notice they are dead.
- Remove batteries from the camera if you do not plan to use it for more than two weeks.
- The batteries that power the camera normally become warm as you use them.
- Use of these battery types is not supported.

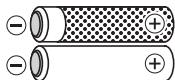

⇒ A bare battery whose label (insulation) is partially or wholly peeled off.



⇒ A battery whose negative ⊖ pole has a raised area or a battery whose negative pole is not covered by a label (insulation).



⇒ A battery whose positive ⊕ pole is flat.

■ Alkaline Battery Life

The actual life of alkaline batteries is affected by a variety of factors, including the battery manufacturer, the amount of time the batteries spend in storage before you use them, temperature while you are recording, and photographic conditions. As a rule, we recommend the use of rechargeable Ni-MH batteries, which have longer lives than alkaline batteries.

- When using alkaline batteries, use of the camera in cold temperatures can shorten the life of the batteries.
- The PLAY mode requires less power than the REC mode. If you experience a problem turning on the camera in a REC mode, try switching to the PLAY mode.

■ Using Rechargeable Batteries

In the case of rechargeable batteries, use of one of the rechargeable Ni-MH (nickel metal hydride) batteries (HR6) listed below is recommended.

- SANYO eneloop (SANYO Electric Co., Ltd.)
- DURACELL RECHARGEABLE (DURACELL, div of P&G Inc.)
- ENERGIZER RECHARGEABLE (Energizer Holdings, Inc.)

IMPORTANT!

- Never mix four batteries of different brands, ages, or charge levels. Doing so creates the risk of shortened battery life and can even damage the camera.
- Batteries cannot be recharged while they are loaded in the camera.

■ Refreshing Rechargeable Batteries

Batteries can start to lose their ability to retain a charge if you do not use them for a long time or when you charge them repeatedly without allowing their current charge to be used up completely. If this happens, you may be able to restore battery capacity by performing the following "battery refresh" operation to fully discharge the batteries.

1. Load the chargeable batteries into the camera.
2. While holding down [MENU], press the power button. This should cause the firmware version screen to flash on the monitor screen.
3. Leave the camera on until the batteries run out of power and the camera turns off.
 - The battery refresh operation can take as long as 10 hours. The actual amount of time required depends on battery conditions.
4. After the camera turns off, remove the batteries and charge them.

IMPORTANT!

- Performing the battery refresh operation reduces the battery charge level to almost zero. Never load refreshed batteries into the camera without charging them first. Though you may be able to momentarily turn on the camera while refreshed uncharged batteries are loaded, power may suddenly fail, leaving the lens extended, or some other misoperation may occur.
- You do not need to perform the above operation each time you charge the batteries. Only use it if you notice that you are getting less operation between charges. Note that you may eventually reach the point when even the above operation will not refresh batteries. If this happens, it means that the rechargeable batteries have reached the end of their service life and that you will need to purchase new rechargeable batteries.
- The above notes are all based on use of a recommended type of rechargeable Ni-MH battery.

Using Household Power

You need to purchase the optionally available AC adaptor (AD-C100) in order to be able to power the camera using a household power supply.

1. Connect the power cord to the AC adaptor.
2. Open the camera's terminal cover and connect the AC adaptor to the terminal marked [].
3. Plug the power cord into a power outlet.

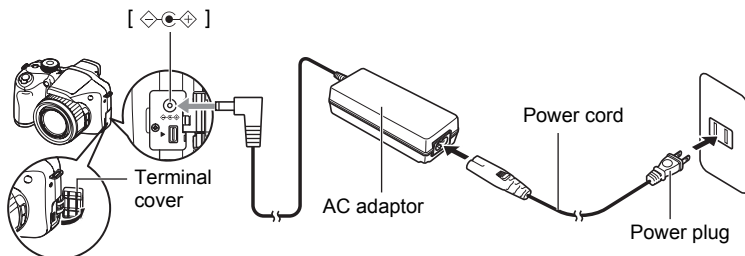

■ Using Power in Other Countries

- The AC adaptor is designed for operation with any power supply in the range of 100 V to 240 V AC, 50/60 Hz. Note, however, that the shape of the power cord plug depends on each country or geographic area. Before taking the camera and AC adaptor along on a trip, check with travel agent about the power supply requirements in your destination(s).
- Do not connect the AC adaptor to a power supply through a voltage converter or similar device. Doing so can lead to malfunction.

■ Precautions when Using the AC Adaptor

- Connecting the AC adaptor to the camera does not charge the batteries.
- Make sure that the camera is turned off before connecting or disconnecting the AC adaptor.
- If you are connecting the AC adaptor to the camera while it has batteries loaded, never connect or disconnect the AC adaptor while the camera is turned on.
- The AC adaptor will become warm after long use. This is normal and does not indicate malfunction.
- Unplug the AC adaptor from the power outlet whenever you are not using it.
- When the AC adaptor is connected to the camera while the batteries are loaded, the AC adaptor power is given priority.
- Use of the AC adaptor to power the camera is recommended when connected to a computer.
- Never cover the AC adaptor with a blanket, etc. Doing so creates the risk of fire.

Using a Memory Card

See page 17 for information about supported memory cards and how to load a memory card.

To replace the memory card

Press the memory card and then release it. This will cause it to pop out of the memory card slot slightly. Pull the card out the rest of the way and then insert another one.

- Never remove a card from the camera while the back lamp is flashing green. Doing so can cause the image save operation to fail and even damage the memory card.

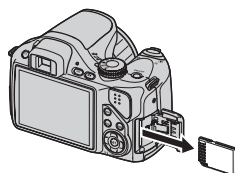

■ Using a Memory Card

- SD memory cards and SDHC memory cards have a write protect switch. Use the switch when you need to guard against accidentally deleting data. Note, however, if you write protect an SD memory card you must then turn write protection off whenever you want to record to it, format it, or delete any of its images.
- If a memory card starts to behave abnormally during image playback, you can restore normal operation by reformatting it (page 135). However, it is recommended that you always take along multiple memory cards whenever using the camera far away from the home or office.
- As you record data to and delete data from a memory card a number of times, it loses its ability to retain data. Because of this, periodic re-formatting of a memory card is recommended.
- Electrostatic charge, electrical noise, and other phenomena can cause data to become corrupted or even lost. Make sure that you always back up important data on other media (CD-R, CD-RW, hard disk, etc.)

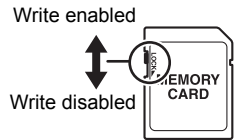

■ Discarding or Transferring Ownership of a Memory Card or the Camera

The format and delete functions of the camera do not actually delete files from the memory card. The original data remains on the card. Note that responsibility for the data on a memory card lies with you. The following procedures are recommended whenever you discard a memory card or the camera, or if you transfer ownership to another party.

- When discarding a memory card, either physically destroy the memory card or use commercially available data delete software to completely delete the data on the memory card.
- When transferring ownership of a memory card to another party, use commercially available data deletion software to completely delete the data on it.
- Use the format function (page 135) to completely delete the data in built-in memory before discarding or transferring ownership of the camera.

Computer System Requirements for Bundled Software

Computer system requirements are different for each of the applications. Be sure to check the requirements for the particular application you are trying to use. Note that the values provided here are minimum requirements for running each application. Actual requirements are greater, depending on the number of images and the sizes of the images being handled.

● Windows

DirectX 9.0c

Hard Disk Drive Space : 65MB for installation (18MB on hard disk)

YouTube Uploader for CASIO

- Sufficient memory to run the operating system
- Computer configuration that enables playback of movies on the YouTube site
- Computer configuration that enables upload of movies to the YouTube site

Adobe Reader 8

CPU : Pentium III Class

Memory : At least 128MB

Hard Disk Drive Space : At least 180MB

Other : Internet Explorer 6.0 or higher installed

For details about the minimum system requirements for each software application, see the "Read me" files on the CASIO Digital Camera Software CD-ROM that comes bundled with the camera.

General Guide

The numbers in parentheses indicate the pages where each item is explained.



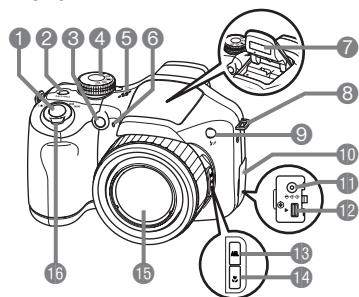

■ Camera

Front

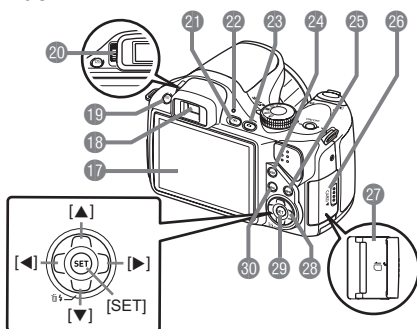

Back



- | | | |
|--|--|---|
| 1 Shutter button (page 20) | 14  (Focus) button (page 46) | 26 Memory card slot cover (page 17) |
| 2 [ON/OFF] (Power) (page 19) | 15 Lens | 27 Memory card slot (pages 17, 151) |
| 3 Front lamp (pages 78, 79) | 16 Zoom controller (pages 20, 43, 92) | 28 Control button ([▲] [▼] [◀] [▶]) (page 28) |
| 4 Mode dial (pages 20, 27) | 17 Monitor screen (pages 136, 156) | 29 [SET] button (page 28) |
| 5 Speaker | 18 Viewfinder (pages 20, 126) | 30 [MENU] button (page 76) |
| 6 Microphone (page 57) | 19 [EVF/LCD] button (page 136) | |
| 7 Flash (page 35) | 20 Diopter dial (page 20) | |
| 8 Strap ring (page 11) | 21  (PLAY) button (pages 19, 24) | |
| 9  (Flash up) button (page 35) | 22 Back lamp (pages 19, 21, 35) | |
| 10 Terminal cover (page 150) | 23  (REC) button (pages 19, 20) | |
| 11 [DC IN 9V] AC adaptor connector (page 150) | 24 [DISP] button (page 136) | |
| 12 [USB/AV] port (pages 93, 106, 113, 119) | 25 [BS] button (page 64) | |
| 13 [AEL] button (page 49) | | |

Bottom

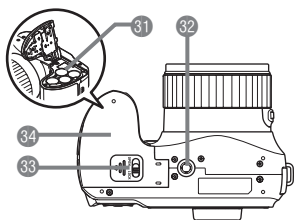

- 31 Battery compartment (pages 12, 146)
- 32 Tripod hole
Use this hole when attaching to a tripod.
- 33 Lock (page 12)
- 34 Battery cover (pages 12, 146)

Monitor Screen Contents

The monitor screen uses various indicators, icons, and values to keep you informed of the camera's status.

- The sample screens in this section are intended to show you the locations of all the indicators and figures that can appear on the monitor screen in various modes. They do not represent screens that actually appear on the camera.

■ Snapshot Recording

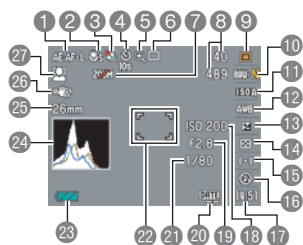

- 1 AE/AF Lock (page 49)
- 2 Focus mode (page 46)
- 3 Move Out CS/Move In CS (page 71)
- 4 Self-timer mode (page 78)
- 5 Image deterioration indicator (page 44)
- 6 Recording mode (page 27)
- 7 Zoom disabled (page 46)
- 8 Number of recordable CS images (pages 51, 71)
Remaining snapshot memory capacity (pages 51, 71)
- 9 Exposure mode (page 29)
- 10 Snapshot image size/Quality (pages 31, 85)
- 11 ISO sensitivity (page 38)
- 12 White balance setting (page 38)
- 13 Exposure compensation (page 40)
- 14 Metering mode (page 41)
- 15 AF area (page 41)/Subject movement sensitivity (Move Out CS, Move In CS) (page 71)
- 16 Flash (page 35)/Continuous shutter (CS) speed (High-speed CS, Flash CS mode) (pages 50, 51)
- 17 Date/Time (page 43)
Prerecord (Still image) Time (High-speed CS mode) (page 51)
Flash continuous shutter (CS) images (Flash CS mode) (page 50)
- 18 ISO sensitivity (page 38)
- 19 Aperture value (page 29)
- 20 Timestamp indicator (page 129)
- 21 Shutter speed (page 30)
- 22 Focus frame (pages 20, 41)
- 23 Battery level indicator (page 14)
- 24 Histogram (page 137)
- 25 Focal distance (Converted to 35 mm film format.) (page 44)
- 26 Anti Shake (page 79)
- 27 Face Detection (page 80)

NOTE

- If the current aperture, shutter speed, ISO sensitivity, or Auto Exposure is not correct, the setting will turn orange when you half-press the shutter button.

■ Movie Recording

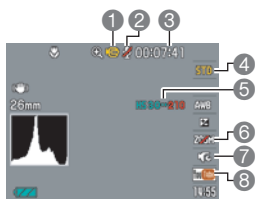

- 1 Recording mode (page 56)
- 2 Record: Off (page 63)
- 3 Remaining movie memory capacity (page 169)
- 4 Movie quality (HD/STD movie) (pages 56, 59)/
Recording speed (high speed movie) (page 59)
- 5 Current movie fps indicator
- 6 Optical zoom (page 63)
- 7 Prerecord Movie (page 61)
- 8 YouTube (page 62)

■ Snapshot Viewing

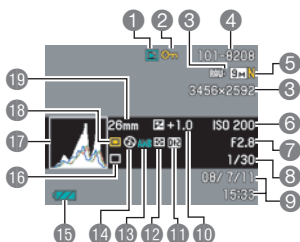

- 1 File type
- 2 Protect indicator (page 101)
- 3 Snapshot image size (page 31)
- 4 Folder name/file name (page 123)
- 5 Snapshot image quality (page 85)
- 6 ISO sensitivity (page 38)
- 7 Aperture value (page 29)
- 8 Shutter speed (page 30)
- 9 Date/time (page 130)
- 10 Exposure compensation (page 40)
- 11 Dynamic range correction (page 85)
- 12 Metering mode (page 41)
- 13 White balance setting (page 99)
- 14 Flash (page 35)
- 15 Battery level indicator (page 14)
- 16 Recording mode
- 17 Histogram (page 137)
- 18 Exposure mode (page 29)
- 19 Focal distance (Converted to 35mm film
format.) (page 44)

■ Movie Playback



- 1 File type
- 2 Protect indicator (page 101)
- 3 Folder name/file name (page 123)
- 4 Movie recording time (page 88)
- 5 Movie Quality/Speed (pages 56, 59)
- 6 Prerecord (Movie) (page 61)
- 7 YouTube (page 62)
- 8 Date/time (page 130)
- 9 Battery level indicator (page 14)

■ CS Image Viewing

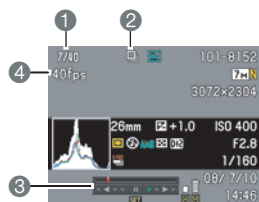

- 1 Current image number/number of images in the group (page 89)
- 2 CS group icon (page 89)
- 3 Playback guide (page 89)
- 4 CS speed (page 89)

Reset Initial Default Settings

The tables in this section show the initial default settings that are configured for menu items (displayed when you press [MENU]) after you reset the camera (page 135).

Menu items depend on whether the camera is in the REC mode or PLAY mode.

- A dash (–) indicates an item whose setting is not reset or an item for which there is no reset setting.

■ REC Mode

“REC” Tab

Self-timer	Off
AF Assist Light	On
Anti Shake	 Camera As
Face Detection	Off
Continuous AF	Off
AE/AF Lock	AE Lock
Save CS Images	Always Ask
Digital Zoom	On
Quick Shutter	Off

Review	On
Grid	Off
Icon Help	On
Memory	Flash: On Self-timer: Off Flash Intensity: Off Digital Zoom: On MF Position: Off Zoom Position: Off

“Quality” Tab

 Quality (Snapshots)	Normal
Dynamic Range	Off
Flash Intensity	0
Flash Assist	Auto

Color Filter	Off
Sharpness	0
Saturation	0
Contrast	0

“Set Up” Tab

Screen	Auto 2
EVF Brightness	0
Sounds	Startup: Sound 1 / Half Shutter: Sound 1 / Shutter: Sound 1 / Operation: Sound 1 / 🔊 Operation: ■■■□□□□ / 🔊 Play: ■■■□□□□
File No.	Continue
World Time	Home
Timestamp	Off
Adjust	–

Date Style	–
Language	–
Sleep	1 min
Auto Power Off	5 min
REC/PLAY	Power On
LCD Priority	Off
USB	Mass Storage
Video Out	–
Battery Type	–
Startup	Off
Format	–
Reset	–

■ PLAY Mode

“PLAY” Tab

Slideshow	Images: All images / Time: 30 min / Interval: 3 sec / Effect: Pattern 1
MOTION PRINT	9 frames
Movie Editing	–
White Balance	–
Brightness	–
DPOF Printing	–

Protect	–
Rotation	–
Resize	–
Trimming	–
Copy	–
Divide Group	–
Select Frame	–









“Set Up” Tab

- The contents of the “Set Up” tab are the same in the REC mode and PLAY mode.

When things don't go right...

Troubleshooting



Problem	Possible Cause and Recommended Action
Power Supply	
Power does not turn on.	1)The batteries may not be loaded correctly (page 12). 2)The batteries may be dead.
The camera suddenly powers down.	1)Auto Power Off may have activated (page 131). Turn power back on. 2)The batteries may be dead. 3)The camera's protection function may have activated because camera temperature is too high. Turn off the camera and wait until it cools down before trying to use it again.
Power will not turn off. Nothing happens when a button is pressed.	Remove the batteries from the camera and then reload them.
Image Recording	
Image is not recorded when the shutter button is pressed.	1)If the camera is in the PLAY mode, press [RECORD] (REC) to enter the REC Mode. 2)If the flash is charging, wait until the charge operation finishes. 3)If the message "Memory Full" appears, transfer images to your computer, delete images you no longer need, or use a different memory card. 4)Flash is required but the flash unit is closed. Press the [FLASH UP] (Flash up) to open the flash unit.
Auto Focus does not focus properly	1)If the lens is dirty, clean it off. 2)The subject may not be in the center of the focus frame when you compose the image. 3)The subject you are shooting may not be a type that is compatible with Auto Focus (page 26). Use manual focus (page 46). 4)You may be moving the camera when shooting. Try shooting with Anti Shake or use a tripod. 5)You may be pressing the shutter button all the way without waiting for Auto Focus. Half-press the shutter button and allow enough time for Auto Focus to focus.
The subject is out of focus in the recorded image.	The image may not be focused properly. When composing the image, make sure the subject is located inside the focus frame.

Problem	Possible Cause and Recommended Action
The flash does not fire.	1) If  (Flash Off) is selected as the flash mode, change to another mode (page 35). 2) If battery power is low, replace them with a full set of new ones. 3) If a BEST SHOT scene that uses  (Flash Off) is selected, change to a different flash mode (page 35) or select a different BEST SHOT scene (page 64).
Camera powers down during Self-timer countdown.	The batteries may be dead.
The monitor screen image is out of focus.	1) You may be using Manual Focus and have not focused the image. Focus the image (page 46). 2) You may be using  (Macro) or  (Super Macro) for scenery or portraits. Use Auto Focus for scenery and portrait shots (page 46). 3) You may be trying to use Auto Focus when shooting a close-up shot. Use the  (Macro) or  (Super Macro) for close ups (page 46).
There is digital noise in images.	1) Sensitivity may have been increased automatically for a dark subject, which increases the chance of digital noise. Use a light or some other means to illuminate the subject. 2) You may be attempting to shoot in a dark location with  (Flash Off) selected, which can increase digital noise and make images appear coarse. In this case, turn on flash (page 35) or use lights for illumination. 3) Flash assist or dynamic range may be enabled for snapshots, which can cause an increase in digital noise. Use a light or some other means to illuminate the subject.
A recorded image was not saved.	1) Camera power may have been turned off before the save operation was complete, which will result in the image not being saved. If the battery indicator shows  , replace batteries (alkaline) or charge batteries (Ni-MH) as soon as possible. 2) You may have removed the memory card from the camera before the save operation was complete, which will result in the image not being saved. Do not remove the memory card before the save operation is complete.
Though available lighting is bright, the faces of people in the image are dark.	Not enough light is reaching the subjects. Change the flash mode setting to  (Flash On) for daylight synchro flash (page 35), or adjust EV shift to the + side (page 40).

Problem	Possible Cause and Recommended Action
Subjects are too dark when shooting images in a seashore or ski area.	Sunlight reflected by water, sand, or snow, can cause underexposure of images. Change the flash mode setting to L (Flash On) for daylight synchro flash (page 35), or adjust EV shift to the + side (page 40).
Digital zoom (including HD zoom) does not work. The zoom bar indicates zoom only up to a zoom factor of 20.	The digital zoom setting may be turned off. Turn on digital zoom (page 82).
The image is out of focus during movie recording.	<ol style="list-style-type: none"> 1) Focusing may not be possible because the subject is outside the focus range. Shoot within the allowable range. 2) The lens may be dirty. Clean the lens (page 144). 3) Continuous Auto Focus is not performed during movie recording when optical zoom is turned on while "HD/STD" is selected as the movie mode, regardless of the current Continuous AF setting. You can readjust focus while movie recording is in progress by half pressing the shutter button, but doing so will cause noise produced by the lens operation to be picked up in the audio recording. 4) Focus is fixed during movie recording when "HS" is selected as the movie mode.
Playback	
The color of the playback image is different from what appears on the monitor screen when shooting.	Sunlight or light from another source may be shining directly into the lens when you are shooting. Position the camera so sunlight does not shine directly into the lens.
Images are not displayed.	This camera cannot display non-DCF images recorded onto a memory card using another digital camera.
Images cannot be edited (with resizing, trimming, rotation).	<p>Note that you cannot edit the following types of snapshots.</p> <ul style="list-style-type: none"> • Snapshots created using MOTION PRINT • CS group snapshots • Movies • Snapshots recorded with another camera

Problem	Possible Cause and Recommended Action
Other	
The wrong date and time are displayed.	The date and time setting is off. Set the correct date and time (page 129).
The messages on the display are in the wrong language.	The wrong display language is selected. Change the display language setting (page 130).
Images cannot be transferred over a USB connection.	<ol style="list-style-type: none"> 1)The USB cable may not be connected securely. Check all connections. 2)The wrong USB communication protocol is selected. Select the correct USB communication protocol in accordance with the type of device you are connecting (pages 113, 119). 3)If the camera is not turned on, turn it on. 4)Your computer may not be able to recognize the camera if you connect via a USB hub. Always connect directly to the computer's USB port.
Language selection screen appears when the camera is turned on.	<ol style="list-style-type: none"> 1)You did not configure initial settings after purchasing the camera or the battery may have been left with dead batteries. Configure the correct settings (pages 15, 130). 2)There may be a problem with the camera's memory data. If this is the case, perform the reset operation to initialize the camera's setup (page 135). After that, configure each setting. If the language selection screen does not re-appear when you turn the camera on, it means that the camera's memory management data has been restored. If the same message appears after you turn power back on, contact your retailer or a CASIO authorized service center.
The lens-barrel unit is dirty or looks scratched.	A lubricating agent is used to ensure that the lens operates smoothly. When the lens is extended, the lubricating agent can make it appear as if the lens-barrel unit is scratched. You can use a soft, dry cloth to wipe the lubricating agent off, if you want. When wiping off the lens-barrel unit, wipe gently taking care you do not twist the unit, or push it in, or pull it out. Note that the lubricating agent is not harmful to humans.

Display Messages

ALERT	The camera's protection function may have activated because camera temperature is too high. Turn off the camera and wait until it cools down before trying to use it again.
Battery is low.	Battery power is low.
Camera not in standby. Re-frame the image.	Move Out CS or Move In CS framing could not be performed for some reason, and so the camera cannot go into auto record standby. Perform the framing operation again (page 71).
Cannot find the file.	The image you specified with the slideshow "Images" setting cannot be found. Change the "Images" setting (page 95) and try again.
Cannot register any more files.	You are attempting to save a user BEST SHOT scene in the "SCENE" folder when the folder already contains 999 user scenes.
Card ERROR	<p>There is something wrong with the memory card. Turn off the camera, remove the memory card and then reload it into the camera. If this message re-appears when you turn the camera back on, format the memory card (page 135).</p> <p> IMPORTANT!</p> <ul style="list-style-type: none"> • Formatting a memory card deletes all its files. Before formatting, try transferring recoverable files to a computer or some other storage device.
Check connections!	You are attempting to connect the camera to a printer while the camera's USB settings are not compatible with the USB system of the printer (page 106).
Files could not be saved because battery is low.	Battery power is low, so an image file could not be saved.
Flash cool down...	The flash is disabled for a short while to protect the flash unit after consecutive operations during Flash CS. You will be able to resume using the flash after this message disappears.
Open the flash unit.	The flash needs to be fired by the flash unit is not open. Press  (Flash up) to open the flash unit.
Flash not possible.	Battery power is too low to fire the flash. Replace or charge the batteries as soon as possible.

Folder cannot be created.	You are trying to record a file while there are already 9999 files stored in the 999th folder. If you want to record more, delete files you no longer need (page 25).
LENS ERROR	This message appears and the camera turns off whenever lens performs some unexpected operation. If the same message appears after you turn power back on, contact a CASIO authorized service center or your original retailer.
LENS ERROR 2	The Anti Shake unit of the camera may be malfunctioning. If the same message appears after you turn power back on, contact your retailer or a CASIO service center.
Load paper!	The printer ran out of paper while printing.
Memory Full	Memory is full with images you recorded and/or files saved by editing operations. When shooting with Prerecord (Still image), this message indicates that there is not enough memory capacity to record all of the pre-recorded images. Delete files you no longer need (page 25).
Printing Error	An error occurred while printing. <ul style="list-style-type: none"> • The printer is turned off. • The printer generated an error, etc.
Record Error	Image compression could not be performed for some reason during image data storage. Shoot the image again.
SYSTEM ERROR	Your camera system is corrupted. Contact your retailer or an authorized CASIO authorized service center.
The card is locked.	The LOCK switch of the SD or SDHC memory card loaded in the camera is in the locked position. You cannot store images to or delete images from a memory card that is locked. <div style="float: right; text-align: center;"> <p>LOCK</p>  </div>
There are no files.	There are no files in built-in memory or on the memory card.
There are no printing images. Set up DPOF.	There are currently no files specified for printing. Configure the required DPOF settings (page 108).
There is no image to register.	The setup you are trying to save is for an image that cannot be saved as a user BEST SHOT scene.
This card is not formatted.	The memory card loaded in the camera is not formatted. Format the memory card (page 135).

This file cannot be played.	The file you are trying to access is corrupted or is a type that cannot be displayed by this camera.
This function cannot be used.	<ul style="list-style-type: none">• You attempted to copy images from built-in memory to a memory card while there is no memory card loaded in the camera (page 103).• You attempted to divide up a CS group while a file that is not a CS group is displayed (page 90).

Number of Snapshots and Movie Recording Time

Snapshot

Image Size (Pixels)	Image Quality	Approximate Image File Size	Built-in Memory Snapshot Recording Capacity	SD Memory Card (1GB) Snapshot Recording Capacity
RAW+ (9M: 3456×2592)* ¹	Fine	19.4 MB	1	49
	Normal	16.8 MB	1	57
	Economy	15.8 MB	2	61
9M (3456×2592)	Fine	5.66 MB	5	170
	Normal	3.0 MB	10	322
	Economy	2.02 MB	16	478
3:2 (3456×2304)	Fine	4.94 MB	6	195
	Normal	2.64 MB	12	366
	Economy	1.78 MB	18	543
16:9 (3456×1944)	Fine	4.04 MB	8	239
	Normal	2.18 MB	14	443
	Economy	1.48 MB	21	653
8M (3264×2448)	Fine	4.59 MB	7	210
	Normal	2.46 MB	13	393
	Economy	1.67 MB	19	579
7M (3072×2304)	Fine	4.3 MB	7	224
	Normal	2.31 MB	14	418
	Economy	1.57 MB	20	616
5M (2560×1920)	Fine	2.99 MB	10	323
	Normal	1.62 MB	20	597
	Economy	1.12 MB	29	863
2M (1600×1200)	Fine	1.26 MB	25	767
	Normal	790 KB	41	1224
	Economy	470 KB	69	2057
VGA (640×480)	Fine	330 KB	98	2930
	Normal	190 KB	171	5090
	Economy	140 KB	232	6908

Movies

Movie Mode	Image Quality (Pixels) / (Audio)	Approximate Data Rate (Frame Rate)	Built-in Memory Movie Recording Capacity	SD Memory Card (1GB) Movie Recording Capacity	File Size of 1-minute Movie
HD/STD	HD 1280×720 (Monaural)	30 Megabits/second (30 frames/second)	8 seconds	4 minutes 22 seconds	225 MB
	HD 1280×720 (No audio)				
	STD 640×480 (Monaural)	10 Megabits/second (30 frames/second)	26 seconds	12 minutes 57 seconds	75 MB
	STD 640×480 (No audio)				
HS	210 fps 480×360 (No audio)	50 Megabits/second (210 frames/second)	5 seconds	2 minutes 38 seconds	375 MB
	420 fps 224×168 (No audio)	50 Megabits/second (420 frames/second)	5 seconds	2 minutes 38 seconds	375 MB
	1000 fps 224×56 (No audio)	25 Megabits/second (1000 frames/second)	10 seconds	5 minutes 14 seconds	187.5 MB
	30-210 fps 480×360 (No audio)	7.1 Megabits/second (30 frames/second) 50 Megabits/second (210 frames/second)	37 seconds* ²	18 minutes 28 seconds* ²	53 MB* ²

Movie Mode	Image Quality (Pixels) / (Audio)	Maximum File Size	Approximate Data Rate (Frame Rate)	Built-in Memory Movie Recording Capacity	SD Memory Card (Maximum recording time per recording)
YouTube Capture Mode*3	YouTube (HS210 fps) 480×360 (No audio)	Maximum Movie Size: 100MB (or 10 minutes)	50 Megabits/second (210 frames/second)	5 seconds	15 seconds
	YouTube (HS420 fps) 224×168 (No audio)		50 Megabits/second (420 frames/second)	5 seconds	15 seconds
	YouTube (HS1000 fps) 224×80 (No audio)		25 Megabits/second (1000 frames/second)	10 seconds	18 seconds
	YouTube (HS30-210 fps) 480×360 (No audio)		7.1 Megabits/second (30 frames/second) 50 Megabits/second (210 frames/second)	37 seconds*2	1 minute 54 seconds*2
	YouTube (STD) 640×480 (Monaural)		10 Megabits/second (30 frames/second)	26 seconds	1 minute 20 seconds
	YouTube (STD) 640×480 (No audio)				

- Snapshot and movie recording capacity values are approximate and intended for reference only. Actual capacity depends on image contents.
- File size and data rate values are approximate and intended for reference only. Actual values depend on the type of image being shot.
- The above values are based on use of a PRO HIGH SPEED SD memory card (Panasonic Corporation). The number of images you can save depends on the type of memory card you are using.
- When using a memory card with a different capacity, calculate the number of images as a percentage of 1GB.
- The time it takes to play back a high-speed movie will be different from the time it takes to record it. If you record a 210 fps high-speed movie for 10 seconds, for example, it will take 70 seconds to play it back.
- Each movie can be up to 10 minutes long. Movie recording stops automatically after 10 minutes of recording.

*1 RAW+ is the total file size of the RAW file and 9M (3456×2592) JPEG file. The image quality setting applies to the JPEG file only.

*2 Recordable time when the entire movie is recorded at 30 fps. Recording time is shorter if the 30 fps frame rate is switched to 210 fps during recording.

*3 Shooting with "YouTube" is not possible while "HD" is selected as the movie mode.

Specifications

File Format	Snapshots: RAW (DNG), JPEG (Exif Version 2.2); DCF 1.0 standard; DPOF compliant * DNG file format is one type of RAW image file, and it is recommended by Adobe Systems for use as a standard image file format. Movies: Motion JPEG AVI, IMA-ADPCM audio (monaural)
Recording Media	Built-in Memory (Image Storage Area: 31.9MB) SD/SDHC/MMC/MMC <i>plus</i>
Recorded Image Sizes	Snapshots: RAW, 9M (3456×2592), 3:2 (3456×2304), 16:9 (3456×1944), 8M (3264×2448), 7M (3072×2304), 5M (2560×1920), 2M (1600×1200), VGA (640×480) Movies: HD (1280×720 30 fps), HS210 (480×360 210 fps), HS420 (224×168 420 fps), HS1000 (224×56 1000 fps), HS30-210 (480×360 30-210 fps switchable), STD (640×480 30 fps)
Delete	1 file; all files CS group, Individual images within a CS group (with memory protection feature)
Effective Pixels	9.10 Megapixels
Imaging Element	Size: 1/2.3-inch square pixel high-speed CMOS Total Pixels: 10.29 Megapixels
Lens/Focal Distance (Snapshot)	F2.8 (W) to 4.5 (T) f= 4.6 to 92.0 mm (equivalent to 26 to 520 mm in 35 mm format) 14 lenses in 11 groups, including aspherical lens.
Zoom	20X optical zoom, 4X digital zoom (80X in combination with optical zoom) 108X maximum HD Zoom (in combination with optical zoom, VGA size)
Focusing	Contrast Detection Auto Focus • Focus Modes: Auto Focus, Macro Focus, Super Macro Focus, Manual Focus • AF Area: Spot, Free, Tracking; with AF assist lamp
Approximate Focus Range (Snapshot) (From Lens Surface)	Auto Focus: 40 cm to ∞ (1.3' to ∞) (Wide Angle) Macro Focus: 12 cm to 50 cm (4.7" to 19.7") (Wide Angle) Super Macro Focus: 1 cm to 12 cm (0.4" to 4.7") Manual Focus: 12 cm to ∞ (4.7" to ∞) (Wide Angle), 1 cm to ∞ (0.4" to ∞) (when the zoom focal distance is equivalent to 57 mm in 35 mm film format) * Range is affected by optical zoom.
Metering	Multi-pattern, center weighted, and spot by imaging element
Exposure Control	Program AE, Aperture Priority AE, Shutter Speed Priority AE, Manual Exposure

Exposure Compensation	-2.0 EV to +2.0 EV (in 1/3EV steps)
Shutter	CMOS electronic shutter, mechanical shutter
Shutter Speed	Snapshot (Auto): 1 to 1/2000 second Snapshot (Aperture Priority AE): 1 to 1/2000 second Snapshot (Shutter Speed Priority AE): 30 to 1/2000 second Snapshot (Manual Exposure): 30 to 1/2000 second * May differ due to the camera setup. * 1/40000-second shutter speed is possible only with High-speed Continuous Shutter, shutter speed priority AE or manual exposure.
Aperture Value	F2.8 (W) to F7.9 (W); aperture changed by optical zoom or recording mode
White Balance	Auto, Daylight, Overcast, Shade, Day White Fluorescent, Daylight Fluorescent, Tungsten, Manual WB
Sensitivity (Standard Output Sensitivity)	Snapshots: Auto, ISO 100, ISO 200, ISO 400, ISO 800, ISO 1600 equivalent Movies: Auto (Hi-Speed Movie when Manual Exposure mode: ISO 100, ISO 200, ISO 400, ISO 800, ISO 1600)
Self-timer	Approximate Trigger Times: 10 seconds, 2 seconds, Triple Self-timer (Trigger time setting depends on CS mode being used.)
Flash Modes	Auto, Off, On, Red-eye reduction
Flash Range (ISO Sensitivity: Auto)	Normal: 0.4 m to 7.0 m (1.3' to 23.0') (Wide Angle) 1.3 m to 4.4 m (4.3' to 14.4') (Telephoto) Flash Continuous Shutter (5 flash CS images): 0.6 m to 2.3 m (2.0' to 7.5') (Wide Angle) 1.3 m to 1.4 m (4.3' to 4.6') (Telephoto) * Range is affected by optical zoom.
Flash Intensity Adjustment	-2.0 EV to +2.0 EV (in 1/3EV steps)
Flash Charging Time	Approximately 5 seconds maximum
Movie Recording Minimum Illumination	18 lx (HD/STD movie)
Recording	Snapshot, High Speed Continuous shutter, Prerecord (still image), Flash Continuous shutter, BEST SHOT, Face detection, High Speed Movie (no audio), HD Movie, STD Movie, Prerecord (Movie), YouTube Capture Mode, CMOS shift image stabilization
Monitor Screen	3.0-inch TFT color LCD (Super Clear LCD) 230,400 (960×240) dots
Viewfinder	LCD monitor/Electronic View Finder (0.2-inch, Equal to 201,600 dots)
Timekeeping Functions	Built-in quartz digital clock Date and Time: Recorded with image data Auto Calendar: To 2049

World Time	162 cities in 32 time zones City name, date, time, summer time
Input/Output Terminals	USB/AV port, Hi-Speed USB compatible AC adaptor connector (DC-IN)
Microphone	Monaural
Speaker	Monaural
Power Requirements	AA-size alkaline battery ×4 AA-size rechargeable Ni-MH battery ×4 AC adaptor (AD-C100) (optional accessory)

Approximate Battery Life

All of the values provided below represent the approximate amount of time under normal temperature (23°C (73°F)) before the camera turns off. These values are not guaranteed. Low temperatures shorten battery life.

Operation	Number of Shots (CIPA) (Operating Time)*1	Continuous Playback (Snapshots)*2	Approximate continuous movie recording time
ALKALINE BATTERY LR6			
Panasonic	230 shots	5 hours 20 minutes	2 hours 10 minutes
DURACELL ULTRA	210 shots	5 hours 20 minutes	2 hours
RECHARGEABLE Ni-MH BATTERY			
eneloop	400 shots	6 hours 20 minutes	3 hours 50 minutes
ENERGIZER	430 shots	8 hours 20 minutes	4 hours 50 minutes
DURACELL RECHARGEABLE	440 shots	5 hours 40 minutes	4 hours 20 minutes

- The above guidelines are based on the following battery types:

ALKALINE BATTERY LR6	
Panasonic LR6 (XW) (Panasonic Corporation)	
DURACELL ULTRA (MX1500) (DURACELL, div of P&G Inc.)	
RECHARGEABLE Ni-MH BATTERY	
SANYO eneloop (HR-3UTG) (SANYO Electric Co.,Ltd.) Capacity: Min.1900 mAh	
ENERGIZER RECHARGEABLE (NH15-2500) (Energizer Holdings, Inc.) Capacity: 2500 mAh	
DURACELL RECHARGEABLE (DC1500) (DURACELL, div of P&G Inc.) Capacity: 2650 mAh	

* Battery life varies with brand.

- Recording Medium: 1GB SD memory card (PRO HIGH SPEED (Panasonic Corporation))
- Measurement Conditions

- *1 Approximate number of shots (CIPA) (Operating Time)
In accordance with CIPA standards
Normal temperature (23°C (73°F)), monitor on, zoom operation between full wide and full telephoto every 30 seconds, during which two images are shot with flash; power turned off and back on every time 10 images are shot.
- *2 Approximate playback time
Standard temperature (23°C (73°F)), one-image scroll approximately every 10 seconds
- The above values are based on a set of new batteries.
- Frequency of flash, zoom, High-speed Continuous Shutter, and Auto Focus usage, and the time the camera is on greatly affects recording time and number of shots values.

Power Consumption	6.0 V DC, Approximately 9.0 W
Dimensions	122.6 (W) × 81.4 (H) × 84.5 (D) mm (4.8" (W) × 3.2" (H) × 3.3" (D))
Weight	Approximately 483 g (17.0 oz) (excluding battery and bundled accessories)

CASIO®

CASIO COMPUTER CO.,LTD.
6-2, Hon-machi 1-chome
Shibuya-ku, Tokyo 151-8543, Japan

Free Manuals Download Website

<http://myh66.com>

<http://usermanuals.us>

<http://www.somanuals.com>

<http://www.4manuals.cc>

<http://www.manual-lib.com>

<http://www.404manual.com>

<http://www.luxmanual.com>

<http://aubethermostatmanual.com>

Golf course search by state

<http://golfingnear.com>

Email search by domain

<http://emailbydomain.com>

Auto manuals search

<http://auto.somanuals.com>

TV manuals search

<http://tv.somanuals.com>