

COSMOSYNTHESIZER

CZ-3000



OPERATION MANUAL 1
MANUAL DE OPERACION 37

Thank you for purchasing the Casio CZ-3000. The CZ-3000 is a totally digital synthesizer under LSI (large scale integrated circuit) control, and is designed using the same principles that apply to analog synthesizers, thus eliminating the frequently heard complaint about digital synthesizers that they are too complex. This makes the unit actually a hybrid that combines the operational ease of an analog synthesizer with the tonal quality of a digital model.

3 Modes of the CZ-3000

1 NORMAL MODE

- Play of preset timbres.
 - Modification of timbre data recalled from memory.
 - Creation of new sounds.
 - Application of various effects to timbres.
 - Saving of timbres created to built-in memory or optional RAM cartridge RA-3.
-

2 TONE MIX MODE

- Mixing of any two timbres.
 - Independent setting of each timbre level.
-

3 KEY SPLIT MODE

- Splitting of the keyboard into UPPER and LOWER portions for independent play of two timbres.
 - Independent setting of each timbre level and effect.
-

CONTENTS

GENERAL GUIDE	3
PERIPHERALS	8
PART 1 NORMAL MODE	
PRESET VOICES	10
MEMORY VOICES	10
EFFECT/OVERALL CONTROL	11
PD (PHASE DISTORTION) SOUND SOURCE	13
8-STEP EMVELOPES.....	14
BLOCK CONFIGURATION.....	15
TIMBRE DATA WRITE/SAVE/LOAD	25
PART 2 TONE MIX MODE	
TONE MIX SETTING	28
EFFECT/OVERALL CONTROL.....	28
PART 3 KEY SPLIT MODE	
KEY SPLIT SETTING.....	29
EFFECT/OVERALL CONTROL.....	30
PART 4 MIDI	
SEND/RECEIVE DATA	31
MIDI IN EACH MODE.....	32
CARE OF YOUR UNIT	35
SPECIFICATIONS	36

GENERAL GUIDE

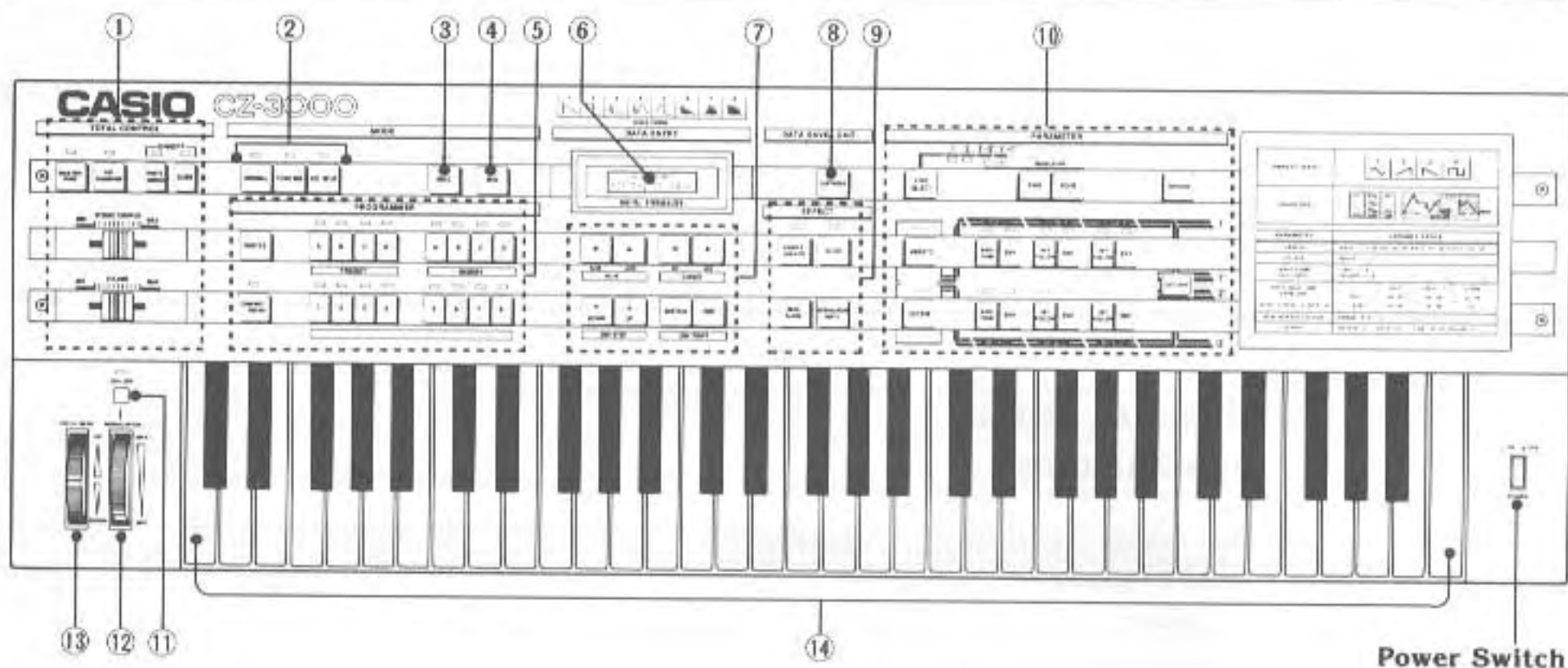

① OVERALL CONTROL SECTION [TOTAL CONTROL]

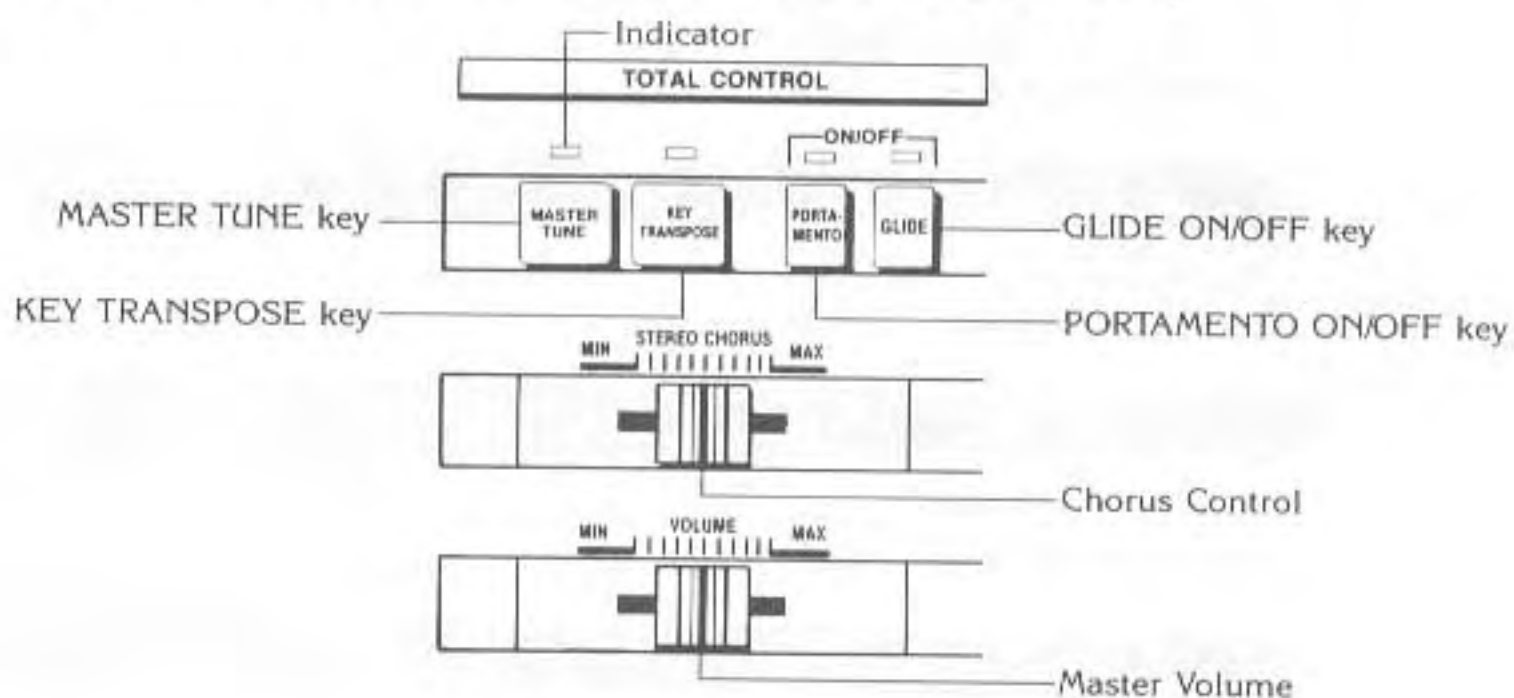

- **MASTER TUNE key**

Used to adjust the pitch of the entire keyboard within the range of ± 100 cent (half tone).

- **KEY TRANSPOSE key**

Transposes selections in half tone increments within the range of G through F#.

- **PORTAMENTO ON/OFF key**

Switches portamento ON and OFF. The indicator above the key lights when ON, and portamento is applied according to the portamento time set using the PORTAMENTO key in the Effect Section ⑨.

- **GLIDE ON/OFF key**

Switches glide ON and OFF. The indicator above the key lights when ON, and glide is applied according to the NOTE and TIME values set using the GLIDE key in the Effect Section ⑨.

- **Master Volume**

Adjusts the volume levels for the headphone and LINE OUT output.

- **Chorus Control**

Adjusts the chorus effect.

② MODE SELECT SECTION

The keys in this section are used to select one of the three modes.

③ SOLO KEY

Switches between monophonic (ON) and polyphonic (OFF) play. An indicator will light above the key when ON.

④ MIDI KEY

Set to the ON position to specify the send/receive status when a MIDI instrument or personal computer is connected to the MIDI terminal on the back panel of the keyboard.

⑤ PROGRAMMER SECTION

A total of 64 timbres are contained in memory (32 PRESET and 32 MEMORY). The keys in this section are used to select one of these timbres and to write timbres to memory.

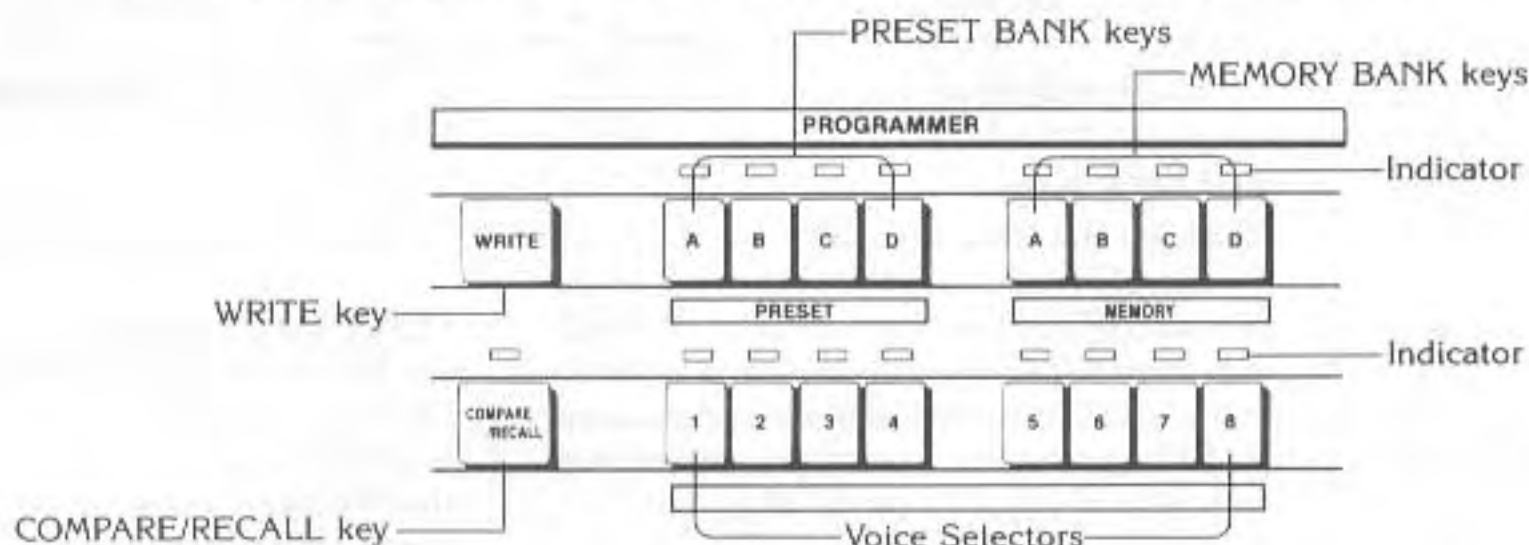

• PRESET BANK keys

Used to select one of the four preset banks. An indicator will light above the key pressed.

• MEMORY BANK keys

Used to select one of the four memory banks. An indicator will light above the key pressed.

• Voice Selectors

Used to select one of the eight timbre memories in the selected bank. An indicator will light above the key pressed, and a message will appear on the LCD as shown in the following illustration.

```
*PRESET*  C-2  
SYNTH. STRINGS
```

PRESET BANK C, tone number 2

```
*MEMORY*  
A-4
```

MEMORY BANK A, tone number 4

• WRITE key

Records timbres created using the Parameter Section ⑩ in the MEMORY BANK.

• COMPARE/RECALL key

Compares a timbre created by modifying a voice recalled from memory with the original (unmodified) voice. The modified timbre is temporarily stored in the COMPARE/RECALL area of memory and the COMPARE/RECALL function is automatically turned ON (indicator lights above key). The original voice is recalled when OFF and the modified timbre is recalled when ON.

⑥ LIQUID CRYSTAL DISPLAY (LCD)

Such information as voice numbers, voice names, parameters and data appears on the LCD as the keyboard is being used.

⑦ DATA ENTRY SECTION

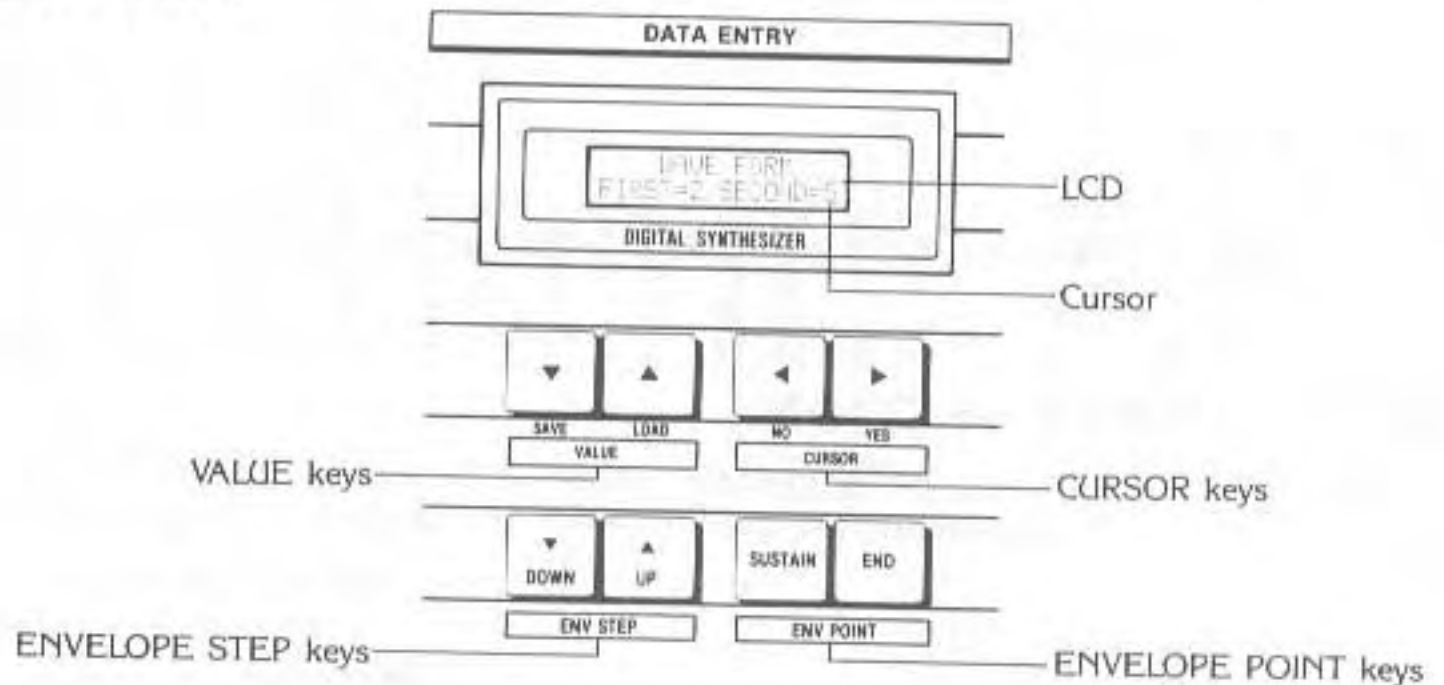

•VALUE keys

Changes the data displayed on the LCD. Pressing decreases the value by 1, while pressing increase the value by 1. Holding down either key will cause the value to continuously increase/decrease. Also used for SAVE and LOAD operations with a RAM cartridge RA-3. (See page 26.)

•CURSOR key

Moves the cursor (blinking mark below the data) on the LCD. Basically, each press of the key moves the cursor one position to the left, while each press of the key moves the cursor one position to the right when multiple data are being displayed.

*The (YES) and (NO) cursor keys are also used for SAVE and LOAD operations using a RAM cartridge RA-3 (page 26),

INITIALIZE of the timbre data (page 23).

•ENV STEP keys

Used to adjust the envelope steps of each DCO, DCW and DCA envelopes provided in the Parameter Section ⑩. Each press of the lowers the step while each press of the raises the step.

•ENV POINY keys

Used to specify the SUSTAIN POINT and END POINT of each DCO, DCW and DCA envelope provided in the Parameter Section ⑩.

⑧ Cartridge key

The cartridge key is used in connection with an optional RAM cartridge RA-3 for saving or loading timbre data of MEMORY BANK. Press as the initial step for performing SAVE and LOAD operation between the keyboard and an optional RAM cartridge. (See page 26.)

⑨ EFFECT SECTION

The keys in this section are used to set data for applying four types of effects to all timbres using the ON/OFF keys and PITCH BEND/MODULATION wheels. Any data modification is performed using the Data Entry Section ⑦.

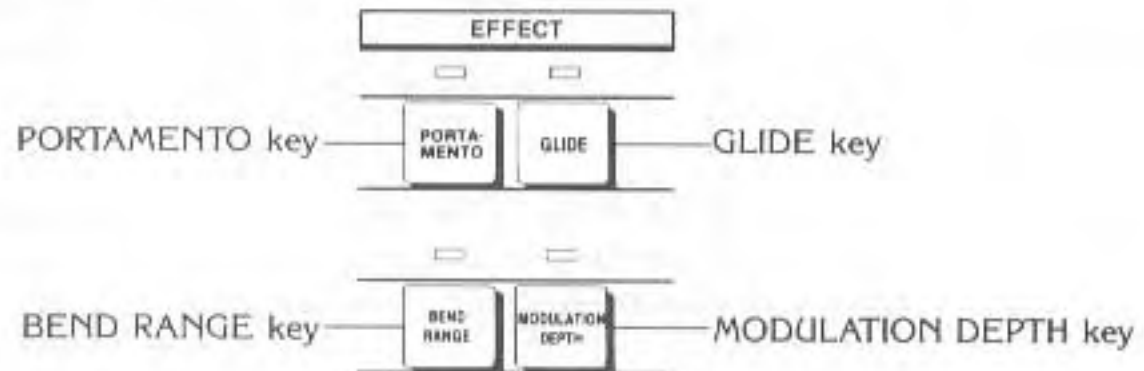

•PORTAMENTO key

Used to set the portamento time. Portamento is applied according to the set value when the PORTAMENTO ON/OFF key of the Overall Control Section ① is ON.

•GLIDE key

Used to set the glide time. Glide is applied according to the set value when the GLIDE ON/OFF key of the Overall Control Section ① is ON.

•BEND RANGE key

Used to set the PITCH BEND ⑬ variation range.

•MOD DEPTH key

Used to set the MODULATION variation range. The MODULATION WHEEL ⑫ operates in the range of the set value when the MODULATION ON/OFF key ⑪ is ON.

⑩ PARAMETER SECTION

All parameters of timbre data are set using the keys in this section. All data modifications (except for line select parameters) are performed using the Data Entry section ⑦.

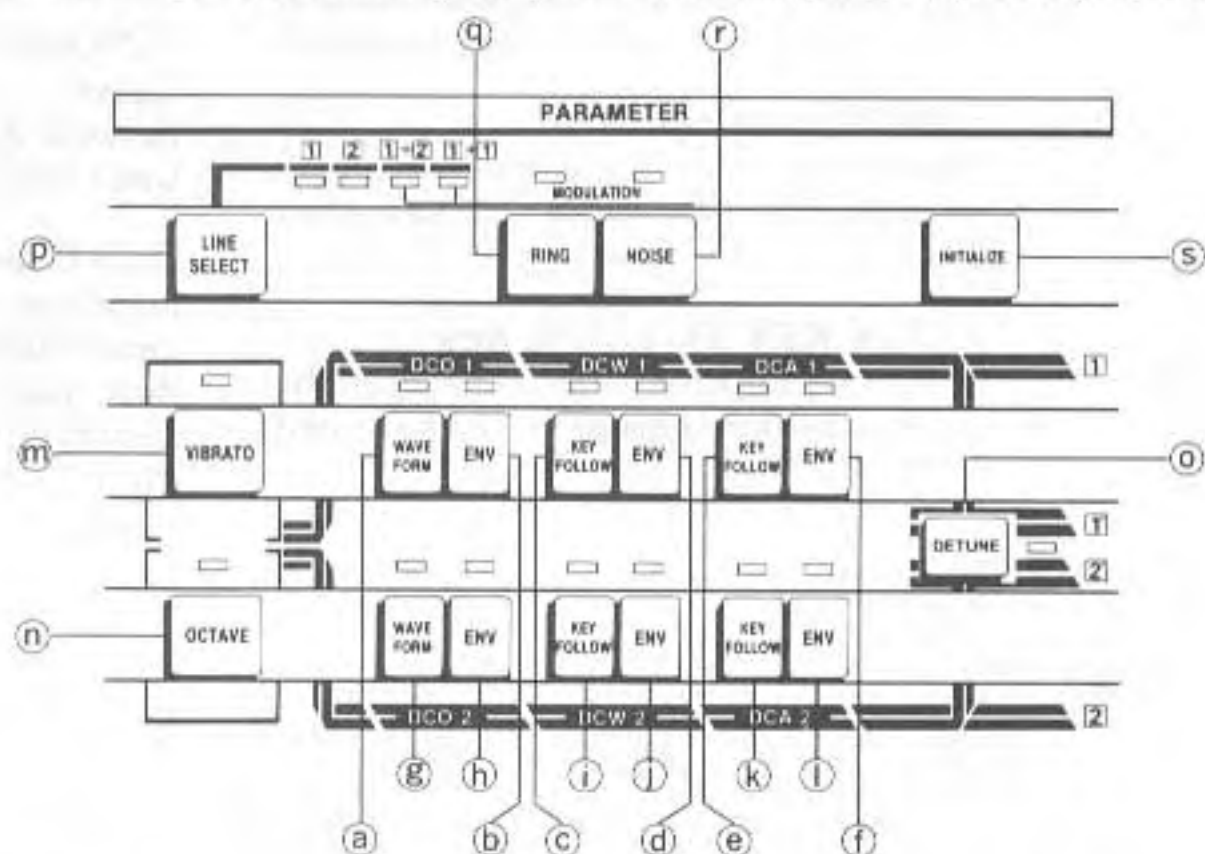

① WAVE FORM key

Press this key when you want to select the basic wave form for Line 1. An indicator lights above this key when ON.

② DCO envelope key

This key lets you set the pitch envelope for Line 1. An indicator lights above this key when ON.

Ⓒ DCW KEY FOLLOW key

Press to make the wave form of the Line 1 DCW approach a pure sine wave according to the pitch of the keys being played.

Ⓓ DCW envelope key

Press to set the wave envelope for Line 1. An indicator lights above this key when ON.

Ⓔ DCA KEY FOLLOW key

Used to set the time variance between the upper and lower registers of the keyboard for DCA 1.

Ⓕ DCA envelope key

Press to set the parameters of the Line 1 amplifier envelope. An indicator lights above this key when ON.

Ⓖ WAVE FORM key

Press to select the basic wave form for Line 2. An indicator lights above this key when ON.

Ⓗ DCO envelope key

Sets the pitch envelope for Line 2. An indicator lights above this key when ON.

Ⓙ DCW KEY FOLLOW key

Press to make the wave form of the Line 2 DCW approach a pure sine wave according to the pitch of the keys being played.

Ⓚ DCW envelope key

Press to set the wave envelope for Line 2. An indicator lights above this key when ON.

Ⓛ DCA KEY FOLLOW key

Used to set the time variance between the upper and lower registers of the keyboard for DCA 2.

Ⓜ DCA envelope key

Press to set the parameters of the Line 2 amplifier envelope. An indicator lights above this key when ON.

Ⓝ VIBRATO key

Press to set the vibrato effect independently for each tone. Data setting itself is performed in the Data Entry section.

Ⓞ OCTAVE keys

Press to shift the pitch range of each tone up or down in one octave steps. Data setting itself is performed in the Data Entry section.

Ⓟ DETUNE key

Press to detune the pitch of Line 1 or Line 2 without changing the tone, for Line 1' or Line 2'.

Ⓠ LINE SELECT key

Changes line select in the order 1 → 2 → 1 + 1 → 1 + 2. The indicator above the selected line combination lights up.

Ⓡ RING key

Causes Line 1' or Line 2' to be ring modulated by Line 1. An indicator lights above this key when ON.

Ⓢ NOISE key

Causes Line 1' or Line 2' to be modulated by noise. An indicator lights above this key when ON.

Ⓣ INITIALIZE key

Initializes the settings of the various parameters (sets the respective data to 0), thus making it easier to start creating sounds right from the beginning. Press the INITIALIZE key and simultaneously press the key of the parameter to be initialized.

⑪ MODULATION ON/OFF KEY

⑫ MODULATION WHEEL

Turned to adjust the vibrato depth according to the variation range set using the MOD DEPTH key in the Effect Section ⑨.

⑬ PITCH BEND WHEEL

Turned to control the pitch according to the variation set using the BEND RANGE key in the Effect Section ⑨.

⑭ KEYBOARD

PERIPHERALS

The CZ-3000 is not equipped with built-in speakers. A keyboard amp is required except when using headphones.

• Connection Diagram

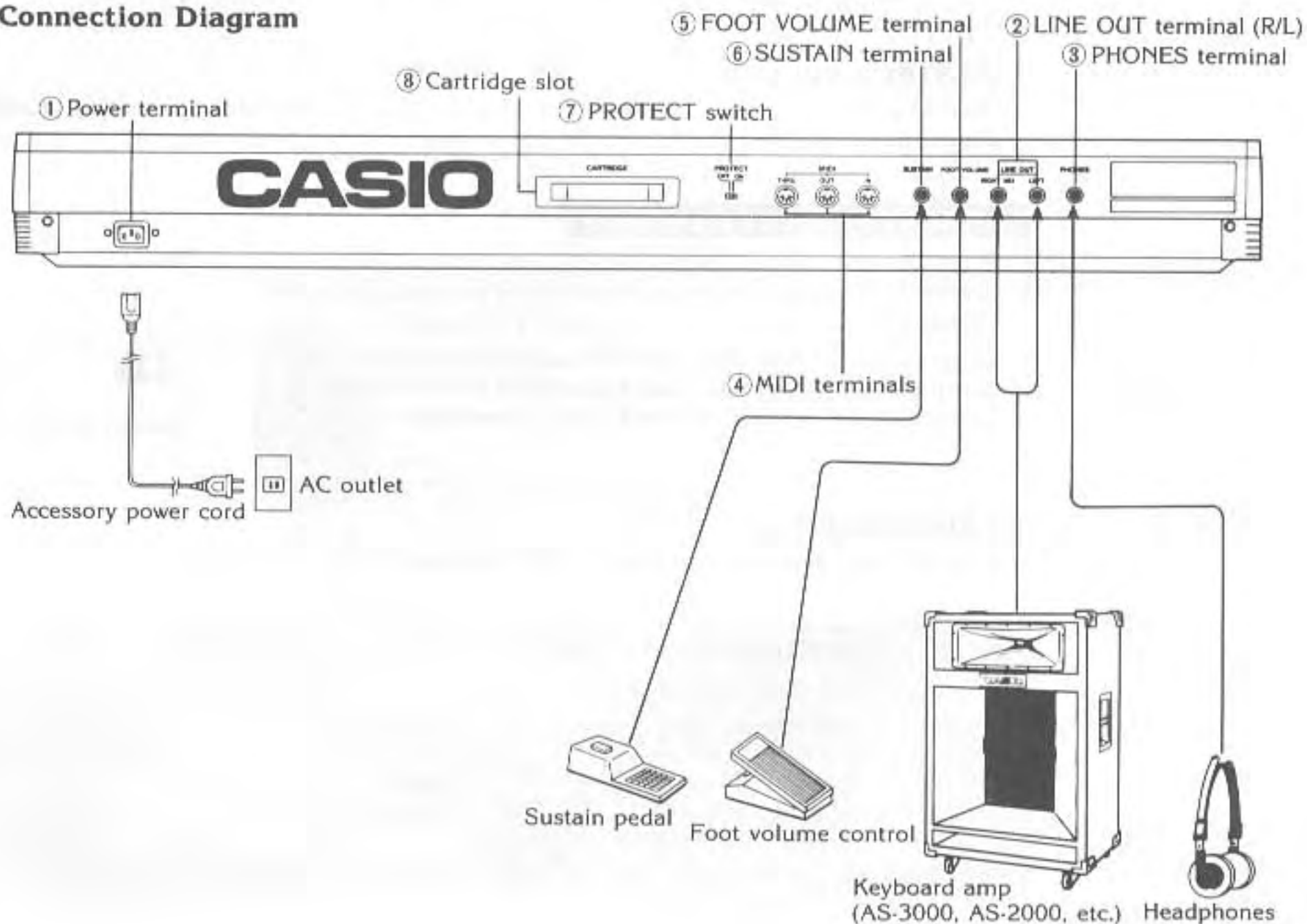

① **POWER TERMINAL**

For connection of accessory power cord.

② **LINE OUT TERMINAL (RIGHT/LEFT)**

For connection of a speaker with a built-in keyboard amp (such as the optional AS-3000).

*Stereo output is only possible when both the RIGHT and LEFT terminals are connected to speakers.

Connecting only one of the two terminals will result in monaural output.

③ **PHONES TERMINAL**

For connection of headphones.

④ **MIDI TERMINALS**

For connection of another keyboard or a computer equipped with MIDI terminals.

⑤ **FOOT VOLUME TERMINAL**

For connection of a foot volume pedal (optional VP-2) which allows fine adjustments of volume during keyboard play.

*No sound is heard when the foot volume pedal is not pressed or when the main volume of the keyboard is set to MIN.

⑥ **SUSTAIN TERMINAL**

For connection of a sustain pedal (optional SP-1). Sustain effect applied when pedal is pressed.

⑦ **PROTECT SWITCH**

Used to protect against erasure of timbre data from the Programmer section or data played using the Sequencer Section.

MEMORY PROTECT FUNCTION

WRITE is impossible and data LOAD from an optional RAM cartridge is impossible when the PROTECT switch is in the ON position. This protects against inadvertently erasing data (see page 25). The switch should usually be kept ON and only be set to OFF for WRITE and LOAD operations.

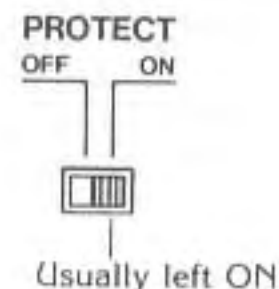

⑧ **CARTRIDGE SLOT**

For loading a separately available RAM cartridge (RA-3). (See page 26.)

OPTIONS (SEPARATELY AVAILABLE)

- Keyboard amp (AS-3000)
- Keyboard amp (AS-2000)
- Keyboard amp (AS-20)
- Volume foot control (VP-2)
- Sustain pedal (SP-1)
- Headphones (CP-2)
- RAM cartridge (RA-3)
- Stand (CS-2)
- Stand (CS-5)
- Protective case (HC-16)
- Flight case (HC-100)

*All options should be available from dealers that handle the CZ series.

★ PART 1 ★ NORMAL MODE

PRESET VOICES

•First, turn power ON by pressing the power switch located to the right of the keyboard. The display will appear as shown here when power is switched ON.



PRESET A-1
BRASS ENS.1

Display when power is switched ON.

At this time the keyboard is set to the NORMAL mode and the Programmer Section automatically recalls PRESET A-1, BRASS ENSEMBLE.

32 preset voices selected using the PRESET BANK keys and VOICE selectors can be used for keyboard play.

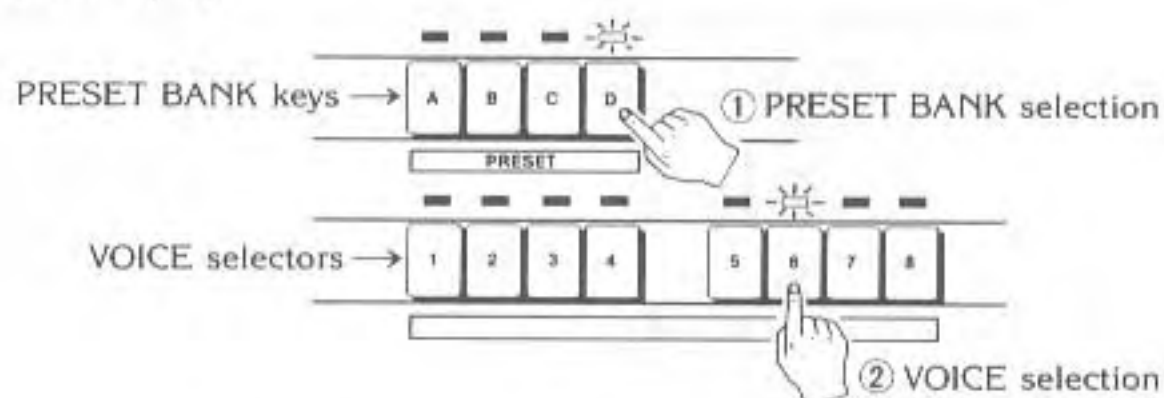

*The name of the preset voice selected will be shown on the LCD.

PRESET VOICE TABLE

No.	BANK	A	B	C	D
1		BRASS ENSEMBLE 1	SYNTH. BRASS	BRASS ENSEMBLE 2	TRUMPET
2		STRING ENSEMBLE 1	STRING ENSEMBLE 2	SYNTH. STRINGS	VIOLIN*
3		JAZZ ORGAN	ELEC. PIANO	ACCORDION	FANTASTIC ORGAN
4		WHISTLE*	FLUTE*	BLUES HARMONICA	DOUBLE REED
5		FAT BASS	SYNTH. BASS	ELEC. GUITAR	METALLIC SOUND
6		VIBRAPHONE	CRISPY XYLOPHONE	SYNTH. GLOCKENSPIEL	CARIMBA
7		SYNTH. DRUMS	STEEL DRUM	SYNTH. PERCUSSION	CONGA
8		HUMAN VOICE	FAIRY TALE	CARILLON	TYPHOON SOUND

*16-tone polyphonic (1 DCO). Unmarked are 8-tone polyphonic (2 DCO).

MEMORY VOICES

The memory bank is composed of 32 memory areas to which original timbre data created using the Parameter Section can be written. MEMORY BANK keys A through D and VOICE selectors 1 through 8 of the Programmer Section are used to select a memory voice for recall.

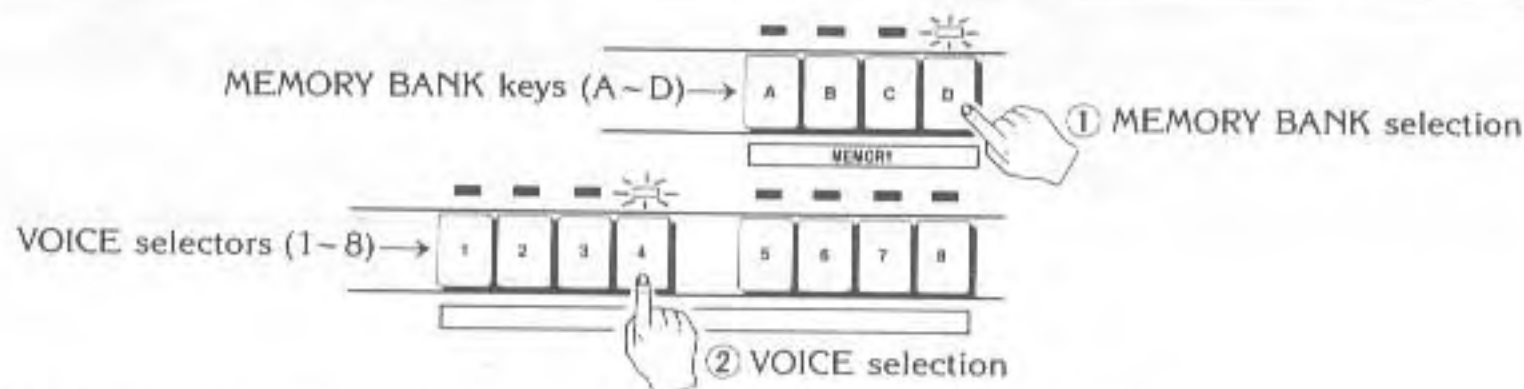

- *The memory bank and voice number are displayed on the LCD.
- *The 32 memories of the MEMORY BANK are set at the factory with sample tones included in the separate "DATA BOOK".

EFFECT/OVERALL CONTROL

• Portamento time

The following appears on the LCD when the PORTAMENTO key in the Effect Section is ON:

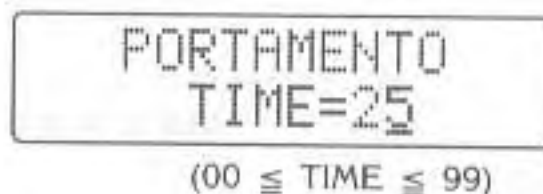
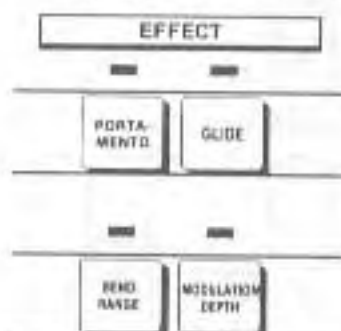

The VALUE ∇ and \blacktriangle keys in the Data Entry Section are used to set the portamento time within a range of 00 through 99. The portamento time increases (portamento becomes slower) as the numeric value increases.

• PORTAMENTO ON/OFF

Portamento is switched ON and OFF using the PORTAMENTO ON/OFF key in the Overall Control Section.

- *Portamento is only applied for legato (subsequent keys are pressed while previously pressed keys are held down) when portamento is switched ON while the SOLO key is ON.
- *Portamento and glide mutually cancel each other.

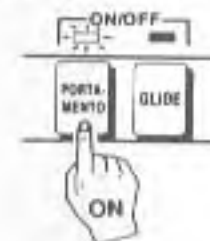

• GLIDE NOTE/TIME

The following appears on the LCD when the GLIDE key in the Effect Section is ON:

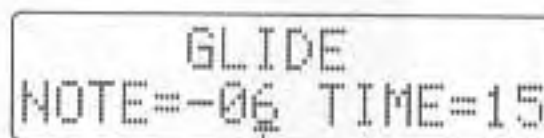

Cursor $(-24 \leq \text{NOTE} \leq +24)$
 $(00 \leq \text{TIME} \leq 99)$

NOTE indicates the pitch divergence from standard of the key pressed. Settings are made in half-tone units in the range of 2 octaves up and down (± 24 half tones). When the keyboard is pressed, the pitch successively changes from the set pitch to standard, thus producing a glide effect. The difference in pitch becomes greater as the numeric value increases.

TIME indicates the glide time and is set within the range of 00 through 99. Glide time becomes longer (glide becomes slower) as the numeric value increases.

The cursor is moved to TIME using the cursor keys in the Entry Section and the numeric value is set using the VALUE keys.

•GLIDE ON/OFF

Glide is switched ON and OFF using the GLIDE ON/OFF key in the Overall Control Section.
*Portamento and glide mutually cancel each other.

•PITCH BEND

Pitch is controlled by turning the PITCH BEND WHEEL located to the left of the keyboard.

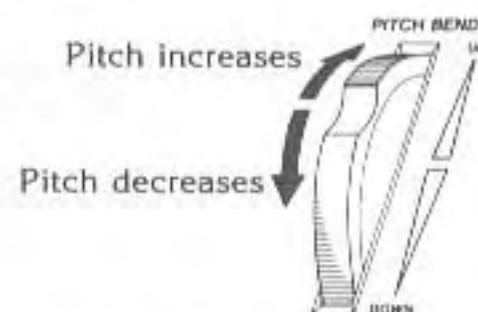

•BEND RANGE

The following appears on the LCD when the BEND RANGE key in the Effect Section is ON:



The VALUE keys in the Data Entry Section are used to set the pitch bend width at half-tone intervals within the range of 00 through 12 (± 1 octave). Each increment of the numeric value increases the bend width by ± 100 cent (\pm half tone).

•MODULATION DEPTH

The following appears on the LCD when the MODULATION DEPTH key in the Effect Section is ON:



The VALUE keys in the Data Entry Section are used to set the MODULATION WHEEL depth within a range of 00 through 99.

•MODULATION WHEEL

When the ON/OFF key above the MODULATION WHEEL is ON, rotating the wheel away from the front of the unit (see illustration) will gradually increase the depth of vibrato. The MODULATION DEPTH set in the Effect Section will be applied with the wheel is rotated to its full (MAX) extent.

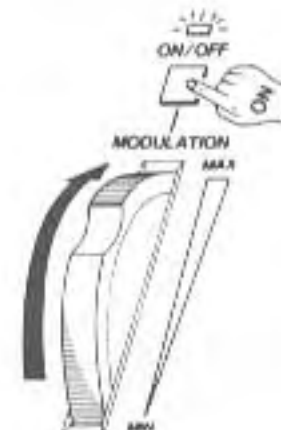

•MASTER TUNE

The following appears on the LCD when the MASTER TUNE key is ON:

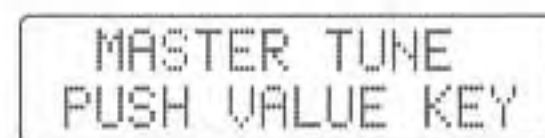

Each press of the \blacktriangledown or \blacktriangle VALUE key will respectively lower or raise pitch by 1.7 cent.
*Simultaneously pressing the \blacktriangledown and \blacktriangle keys will return pitch to the standard value (A4 = 442Hz).

*The pitch value can be successively changed at high speed by holding down either VALUE key.

•KEY TRANSPOSE

The following appears on the LCD when the KEY TRANSPOSE key is ON:

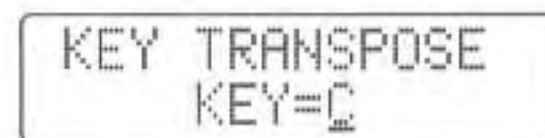

Each press of the ∇ or \blacktriangle VALUE key will respectively lower or raise the key by half tone steps. The key is displayed at the cursor position.

Initial value.
 $G \leftarrow A^b \leftarrow A \leftarrow B^b \leftarrow B \leftarrow C \rightarrow C^{\sharp} \rightarrow D \rightarrow E^b \rightarrow E \rightarrow F \rightarrow F^{\sharp}$

SOLO

SOLO key ON

Volume ↑

KEY ON ① KEY ON ②

KEY ON ② simultaneously deletes note ①.

SOLO key OFF

Volume ↑

KEY ON ① KEY ON ②

Note ① remains even at KEY ON ②.
(Illustration shows a non-sustained tone.)

PD (PHASE DISTORTION) SOUND SOURCE

The CZ-3000 employs a unique, CASIO developed PD (Phase Distortion) sound source system. This system is capable of producing a variety of wave forms by distorting the read phase angles of sine and cosine waves that are written in ROM. The pattern of the read phase angle distortion is determined by the specification of the DCO (VCO of analog synthesizer) WAVE FORM. The magnitude (modulation depth) of the read angle distortion corresponds to the momentary value of the DCW (VCF of analog synthesizer) envelope.

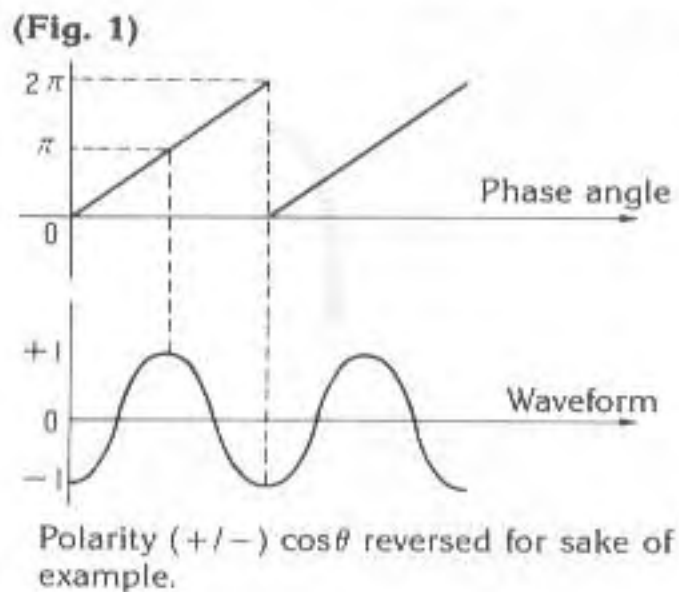
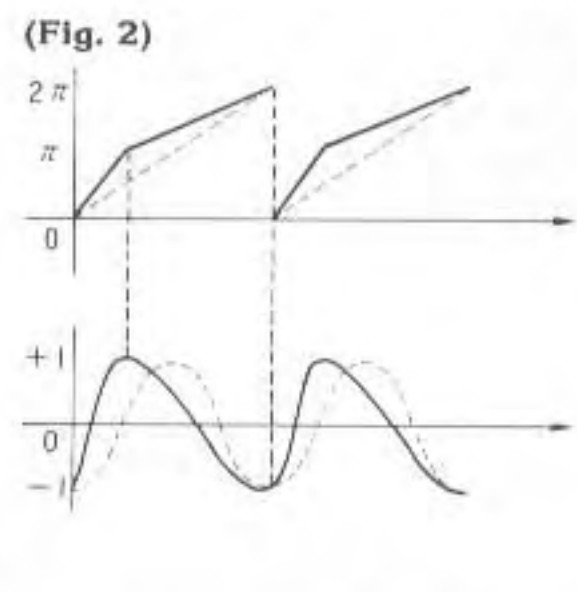

Fig. 1 illustrates output of a non-distorted cosine wave when a cosine wave in ROM is read with a linear phase angle. The phase angle is read at a constant speed from 0 through 2π . What would happen if we increase the phase angle read speed from 0 through π and decrease it from π through 2π ?



As shown in Fig. 2, the phase angle read is distorted rather than linear, and the output cosine wave takes on what is close to a saw-tooth pattern. What would happen now if we further increase the phase angle read speed from 0 through π and decrease it from π through 2π ?

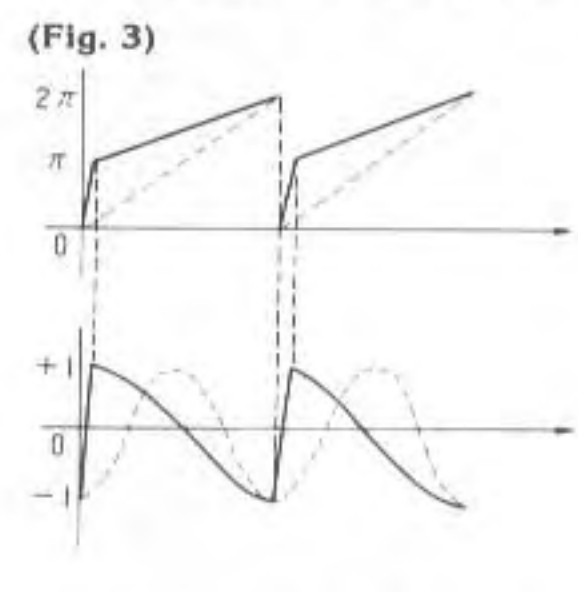
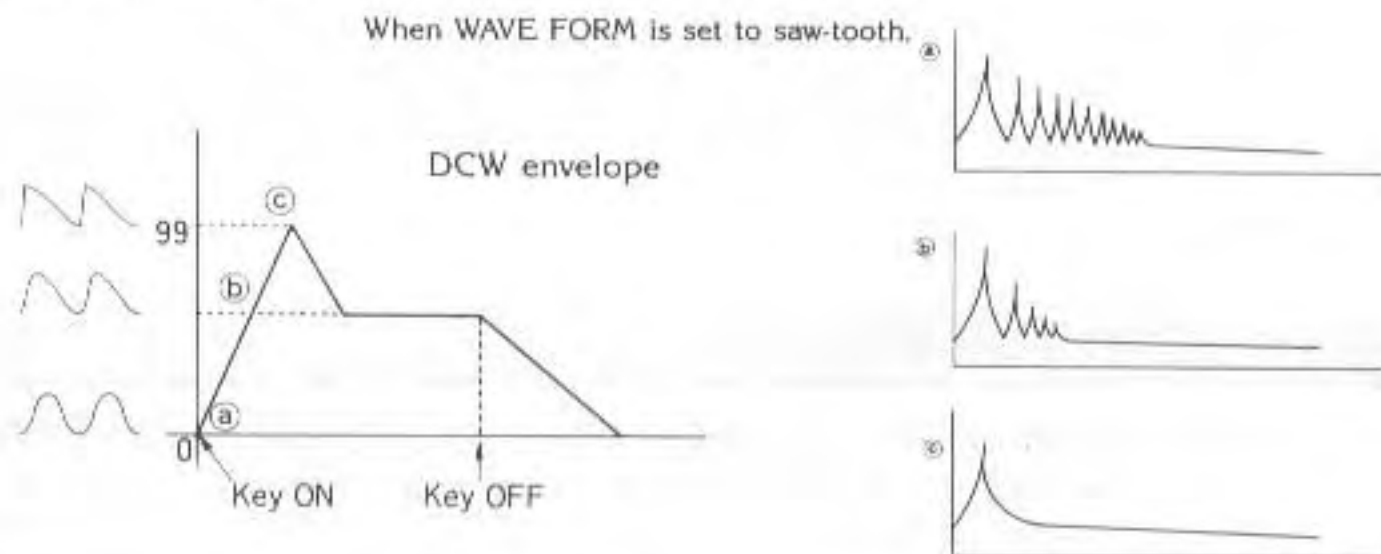

Fig. 3 shows that the output cosine wave is almost a perfect saw-tooth pattern.

The revolutionary PD sound source system thus makes it possible to output waveforms that differ from cosine waves by simply distorting the cosine (or sine) wave read from ROM. Figs. 1 through 3 illustrate the patterns produced by increasing the phase angle read speed from 0 through π while decreasing the speed from π through 2π . This is the pattern effected when the SAW-TOOTH waveform is selected in the DCO parameter.

Read phase angles are also distorted in accordance with the selection of the other DCO parameter WAVE FORMs, thus making a variety of waveform outputs possible.

The magnitude of the read phase angle distortion corresponds to the momentary value (change over time) of the DCW envelope. When the DCW envelope is set as shown in Fig. 4, an undistorted cosine wave is output at point (a), distortion reaches its peak at point (c), and a saw-tooth pattern as shown in Fig. 3 is output. Distortion is reduced (modulation become shallower) at point (b), and a pattern that is somewhere between a cosine wave and a saw-tooth wave as illustrated in Fig. 2 is output.



POINTS TO REMEMBER

- 1) The pattern of the read phase angle distortion corresponds to the WAVE FORM setting of the DCO parameter.
- 2) The magnitude of the read output phase angle distortion (modulation depth) corresponds to the momentary value of the DCW envelope.

8-STEP ENVELOPES

The CZ-3000 features a dual system DCO/DCW/DCA, and each system has its own independent envelope generator for control of changes in notes, timbres and volume over time. The envelope generators can set up to eight steps including setting of the sustain point (the level at which a note is sustained while a key is depressed). This provides greater versatility than the conventional ADSR generator and makes sound creation possibilities virtually unlimited.

(Fig. 1)

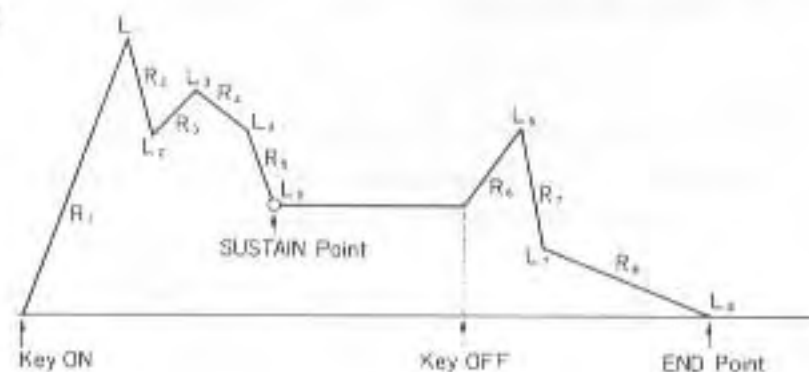

* R_1 through R_8 indicate the RATE (slope) of each various steps, while L_1 through L_8 indicate the LEVEL (destination level). L_1 is reached at a slope of R_1 in STEP 1, L_2 is reached at a slope of R_2 in STEP 2, etc.

Fig. 1 shows an example of an envelope employing 8 steps. There are two attacks before the sustain point, as well as a third attack after the key is released, resulting in an "after-envelope".

(Fig. 2)

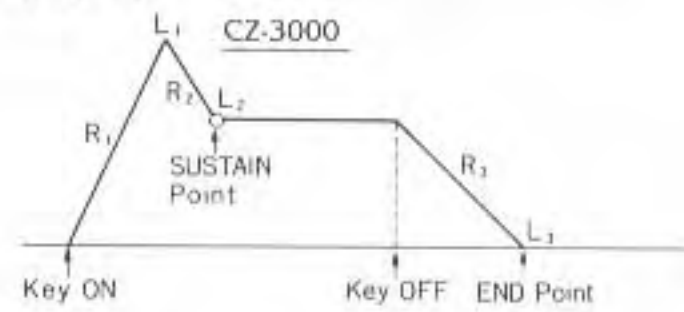

(Fig. 3)

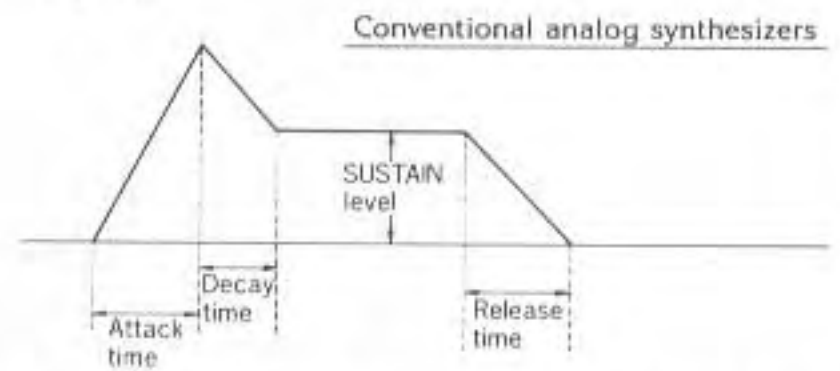

Analog synthesizers usually require the setting of envelopes according to 4 parameters: Attack time, Decay time, Sustain level and Release time (hence, the name ADSR system). With the envelope generator of the CZ-3000, only 3 step settings are required to attain the same effect.

BLOCK CONFIGURATION

The PD sound source of the CZ-3000 makes it a fully digital synthesizer. Actually, however, the DCO (pitch and basic waveform setting), DCW (timbre control), and DCA (volume control) digital circuits of the Parameter Section result in a block configuration that closely resembles an analog synthesizer. The block configuration of the CZ-3000 consists of LINE 1 and LINE 2 which make up a dual system. DETUNE allows you to create differences between the sounds generated by LINE 1 and 2 to produce subtle nuances. With LINE SELECT, a single line can be output or combined with the detuned line for a total of 4 line output settings.

CZ-3000 block configuration

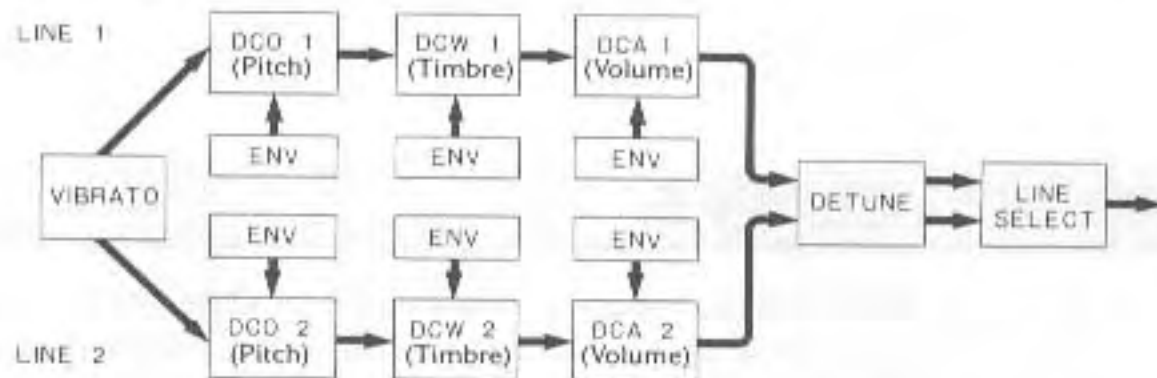

*VIBRATO is the parameter that oscillates the low frequencies of the DCO and applies a vibrato effect. Another parameter applied to DCO is OCTAVE.

■ DCO (DIGITAL CONTROLLED OSCILLATOR)

DCO corresponds to the VCO of an analog synthesizer, and is comprised of WAVE FORM for selection of the basic waveform and ENV (pitch envelope) for control of the pitch over time for a pressed key. The dual system line provides an independent DCO 1 and DCO 2 which can be used as desired.

• WAVE FORM

Determines the basic waveform of a timbre. Independent settings can be made using the DCO 1 and DCO 2 keys.

As can be seen in fig. a, there are eight types of basic waveforms: from SAW-TOOTH to RESONANCE III. Any one of these eight waveforms can be combined as shown in fig. b to produce a total of 33 waveforms suitable for virtually any application.

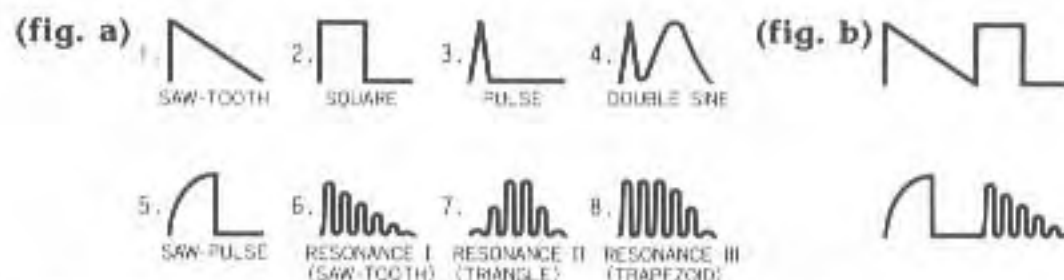

*The three RESONANCE waveforms cannot be used in combination with each other.

When the WAVEFORM key is ON, the LCD appears as shown in Fig. 1.

(Fig. 1) Indicator lights.



Fig. 1 indicates that only the saw-tooth pattern is selected. (Only the FIRST waveform is applied when SECOND = 0 is displayed.) At this time, the VALUE keys can be used to set FIRST (the current position of the cursor) to a value from 1 through 8 to select the required waveform. Then the CURSOR keys can be used to move the cursor under the value of SECOND and the another waveform can be set using the VALUE keys (see Fig. 2). This procedure is used to select one of the 33 combinations of basic waveforms.

(Fig. 2)

① Either of the CURSOR keys is used to move the cursor.



② The VALUE keys are used to change the numeric value.

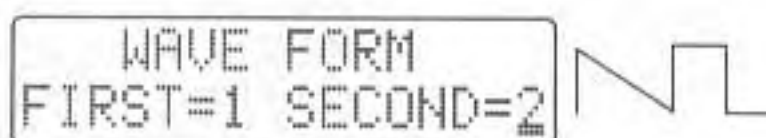

*Giving the same value to FIRST and SECOND is the same as when SECOND = 0.

*FIRST = 1, SECOND = 2 produces the same effect as FIRST = 2, SECOND = 1.

• DCO ENVELOPE (PITCH ENVELOPE)

DCO controls changes in pitch over time. Independent envelopes can be set using the DCO 1 and DCO 2 ENV keys.

The PITCH envelope sets the change in pitch over time up to 8 levels for pressed keys in accordance with the RATE and LEVEL.

Now let's set up an actual 4-step envelope as shown in Fig. 3.

(Fig. 3)

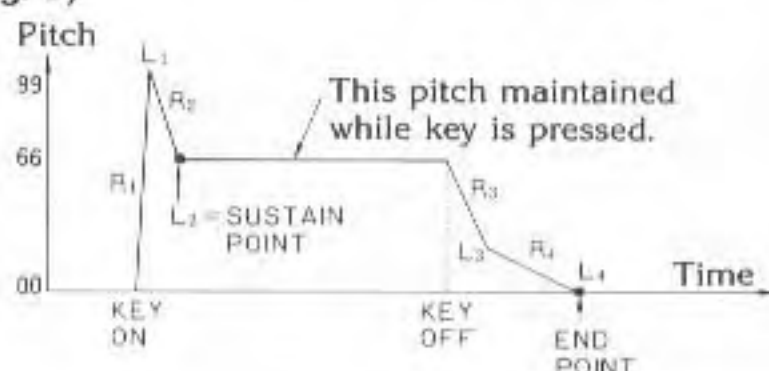

	STEP 1	STEP 2	STEP 3	STEP 4
RATE	99	72	60	20
LEVEL	99	66	24	00
SUS. END	***	SUS	***	END

- ① When the ENV key of the DCO 1 or DCO 2 is pressed, the following appears on the LCD.

SUS will be displayed if the displayed STEP is a sustain point.
END will be displayed if it is an end point.

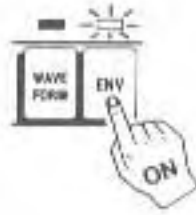

Pitch envelope STEP 1 selected.

```
PITCH STEP1 ***
RATE=m1m2 LEVEL=n1n2 (00 ≤ m1m2 ≤ 99)
                          (00 ≤ n1n2 ≤ 99)
```

Rate of step 1. Destination level of step 1.

- ② Use the VALUE key to raise the RATE value to 99.

```
PITCH STEP1 ***
RATE=99 LEVEL=n1n2
```

- ③ Use either one of the CURSOR keys to move the cursor under the LEVEL value. Use the VALUE key to raise the LEVEL value to 99. This completes the setting of STEP 1.

```
PITCH STEP1 ***
RATE=99 LEVEL=99
```

- ④ Use the ENV STEP key to advance to STEP 2. After ensuring the STEP 2 is displayed, follow the same procedures outlined for STEP 1 to set the RATE to 72 and the LEVEL to 66.

```
PITCH STEP2 ***
RATE=72 LEVEL=66
```

- ⑤ Press the ENV POINT SUSTAIN key to designate STEP 2 as a SUSTAIN POINT.

SUSTAIN POINT

```
PITCH STEP2 SUS
RATE=72 LEVEL=66
```

- ⑥ Use the ENV STEP key to advance to STEP 3 and set the RATE to 60 and the LEVEL to 24.

```
PITCH STEP3 ***
RATE=60 LEVEL=24
```

- ⑦ Use the ENV STEP key to advance to STEP 4 and set the RATE to 20. Then press the ENV POINT END key to set the END POINT, and the LEVEL will automatically be set to 00.

END POINT

```
PITCH STEP4 END
RATE=20 LEVEL=00
```

LEVEL of the last step is 00.

*It is not necessary to press the END key if the END POINT is already set.

RATE/LEVEL NUMERIC VALUES

RATE



The RATE indicates the slope (interior angle in relation to horizontal) of each step in the envelope. R = 99 indicates nearly 90° while R = 0 indicates nearly 0°. Since the value used is an absolute value, the slope increases and decreases in direct proportion with the value of R, regardless of whether the pattern shows a rise or fall. This means that a steep incline results in a quick level change while a gentle incline results in a slow level change.

LEVEL

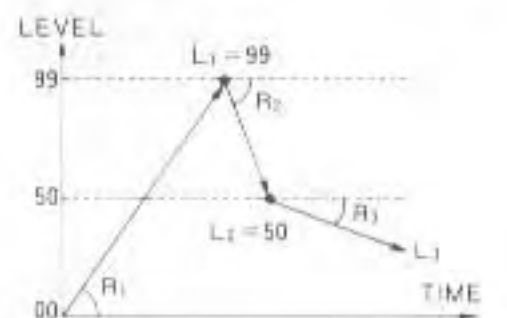
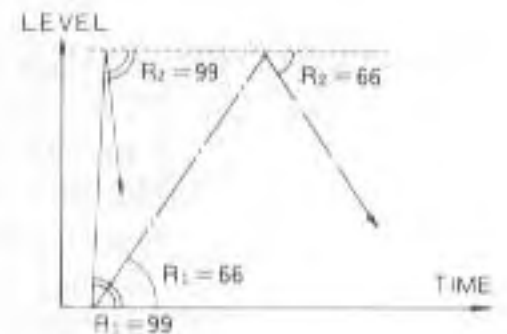
The LEVEL indicates up to what point each step rises or falls (destination level), and the range is from 00 through 99. For the DCO envelope, LEVEL means the pitch height, and a value of 00 is the pitch of a pressed key. For the DCW envelope, L = 99 results in a basic waveform (see page 20 for details). For the DCA envelope, LEVEL means the volume.



NOTES

- Even if the ENV STEP  key is pressed, it will be impossible to advance from the present step if END POINT is specified. In this case, press the ENV POINT END key again to cancel the END point and then press the ENV STEP  key. If an END point is cancelled within STEP 1 through 7, an END POINT is automatically designated in STEP 8 and previously set data is automatically restored.
- The LEVEL for a STEP that includes an END POINT is fixed as 00 and cannot be changed.
- When a SUSTAIN POINT is designated in a STEP, SUSTAIN POINTs set in other STEPs are cancelled.

■ DCW (DIGITAL CONTROLLED WAVE)

DCW corresponds to the VCF of an analog synthesizer, and is comprised of KEY FOLLOW for control of the waveform corresponding to the keyboard range, and ENV (wave envelope). The dual system line provides an independent DCO 1 and DCO 2 which can be used as desired.

• KEY FOLLOW/DCW

This parameter applies a difference change in the DCW envelope level in accordance with the pitch of the key played. The DCW 1 and DCW 2 KEY FOLLOW keys are used to independently set each key follow.

Key follow can be set to levels ranging from 0 through 9. The higher the note played, the closer, the waveform comes to being a sine (cosine) wave. (See Fig. 4.)

(Fig. 4)

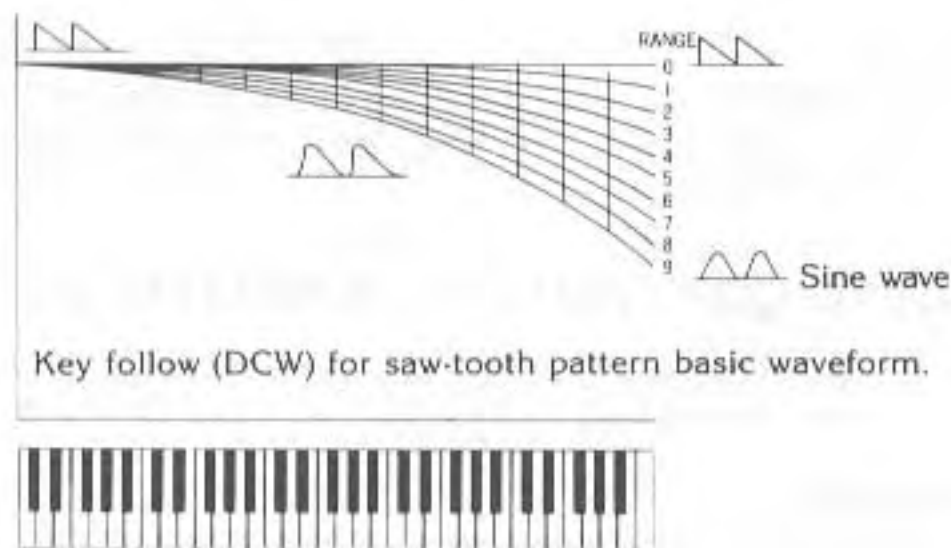

The LCD appears as in Fig. 5 when the DCW KEY FOLLOW key is pressed.

(Fig. 5)

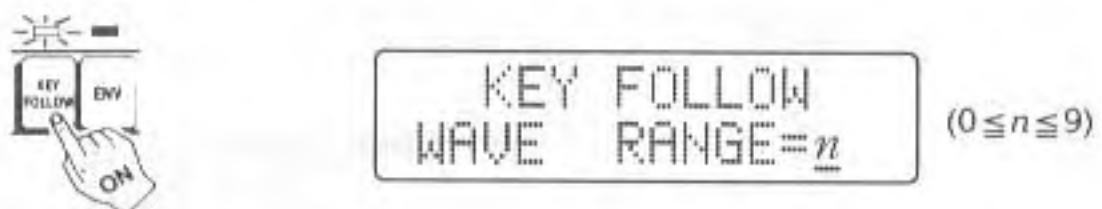

The VALUE keys in the Data Entry Section are used to set the RANGE value within a range of 0 through 9. The greater the RANGE value the greater the waveform level variance (timbre change rate) in the upper registers. A setting of 9 represents the maximum variance.

• DCW (WAVE) ENVELOPE

This parameter controls the timbre (waveform) change over time, and the DCW 1 and DCW 2 ENV keys are used to independently set the timbre envelopes. The timbre envelope is used to set the timbre (waveform) change over time for a pressed key in accordance with the RATE (slope) and LEVEL (destination level). Settings can be made to a maximum of 8 steps.

(Fig. 6) WAVE FORM 1 (Saw-tooth)

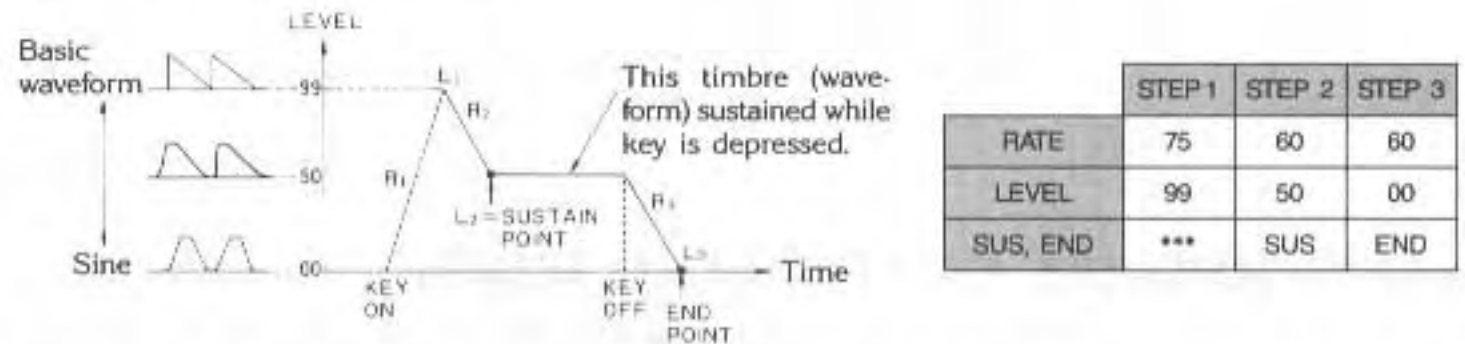

The change of timbre over time is in accordance with the DCW envelope LEVEL. A sine wave is attained when $L = 00$ and the basic waveform is attained when $L = 99$.

The LCD appears as in Fig. 7 when the DCW 1 or DCW 2 ENV key is ON.

(Fig. 7)

Wave envelope STEP 1 is selected.

SUS will be displayed here if the displayed STEP is a sustain point. END will be displayed if it is an end point.

```

WAVE STEP1 ***
RATE=m1m2 LEVEL=n1n2
    
```

Rate of STEP 1.

Destination level of STEP 1.

*Operational procedures are identical to those previously explained for the DCO envelope (page 17). Data is set using the VALUE, CURSOR, ENV STEP and ENV POINT SUS-TAIN/END keys.

■ DCA (DIGITAL CONTROLLED AMPLIFIER)

DCA corresponds to the VCA of an analog synthesizer and independent volume envelopes can be set using the DCA 1 and DCA 2 ENV keys.

• KEY FOLLOW/DCA

This is the parameter that applies a variance to the DCA envelope in accordance with the pitch of the key played. The DCW 1 and DCW 2 KEY FOLLOW keys are used to independently set each key follow.

The higher the note played, the shorter the time of the volume envelope.

(Fig. 8)

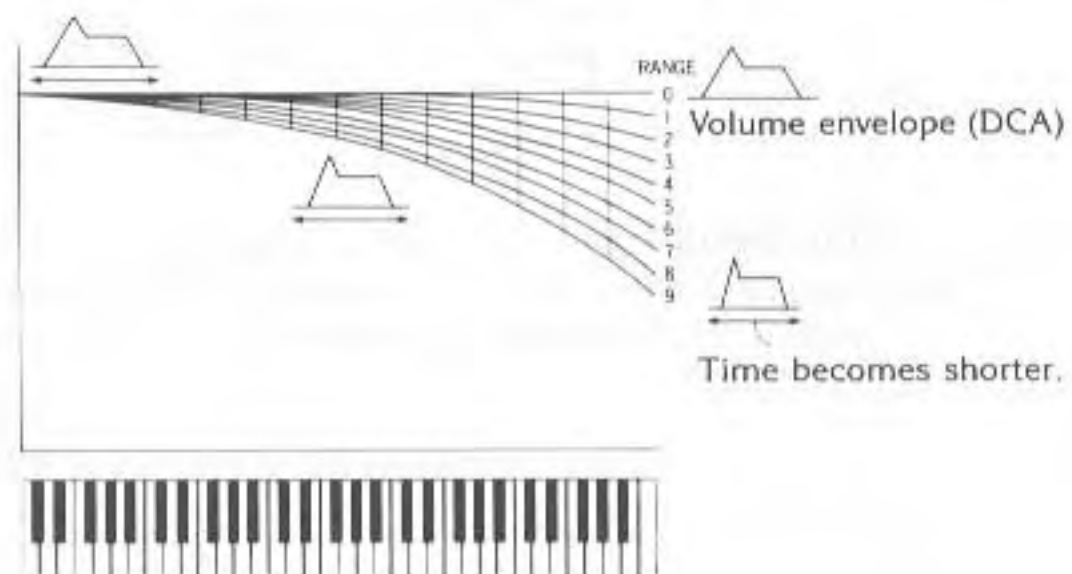

The LCD appears as in Fig. 9 when the DCA KEY FOLLOW key is pressed.

(Fig. 9)

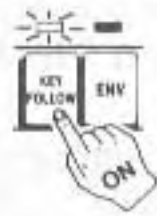

KEY FOLLOW
AMP RANGE = n $(0 \leq n \leq 9)$

The VALUE keys are used to set the RANGE value within a range of 0 through 9. The greater the RANGE value the greater the time variance in the upper registers. A setting of 9 represents the largest variance.

• DCA (AMP) ENVELOPE

This is the parameter that controls volume change over time, and the DCW 1 and DCW 2 ENV keys are used to independently set the volume of the envelopes. The volume change over time of a pressed key is set in accordance with the RATE (slope) and LEVEL (destination level). Settings can be made to a maximum of 8 steps.

(Fig. 10) Piano amp envelope

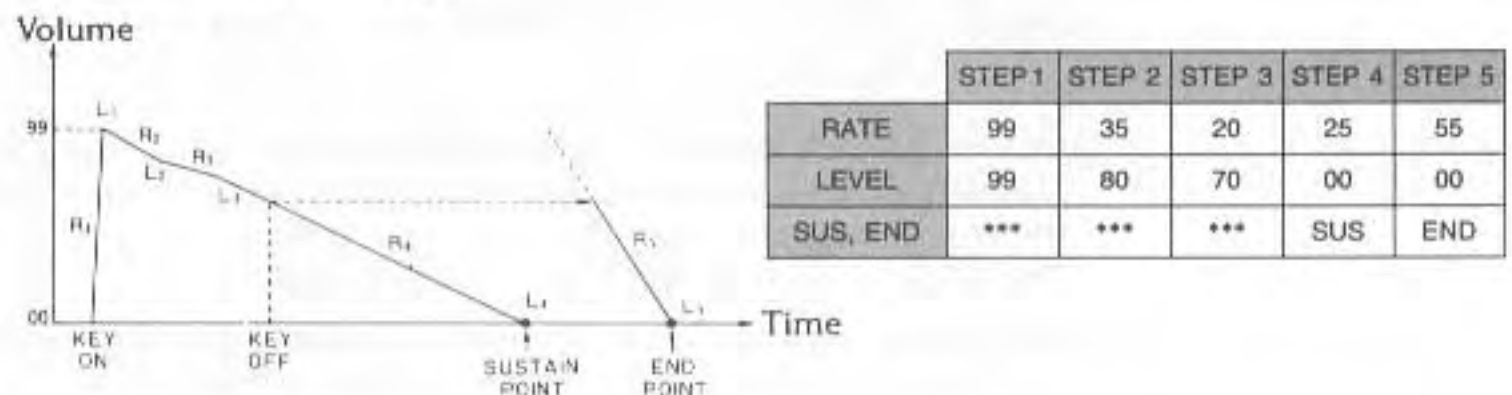

This is an example of a piano envelope where the sound produced by a pressed key gradually decreases. If the key is released before the sound is completely attenuated, the sound quickly decreases. If the key is released before the SUSTAIN POINT is reached, the envelope jumps to the last step in which the END POINT is specified.

The LCD appears as in Fig. 11 when the DCA 1 or DCA 2 ENV key is ON.

(Fig. 11)



Amp envelope STEP 1 is selected.

SUS will be displayed here if the displayed STEP is a sustain point. END will be displayed if it is an end point.

AMP STEP1 ***
RATE = $m_1 m_2$ LEVEL = $n_1 n_2$ $(00 \leq m_1 m_2 \leq 99)$
 $(00 \leq n_1 n_2 \leq 99)$
Rate of STEP 1. Destination level of STEP 1.

Operational procedures are identical to those previously explained for the DCO envelope (page 17). Data is set using the VALUE, CURSOR, ENV STEP and ENV POINT SUSTAIN/END keys.

* * * * *

This completes the explanation of the DCO, DCW and DCA blocks. The most important point to remember is that these three blocks interact with each other to form a single timbre. Actual tone creation examples are given in the SOUND DATA BOOK.

■ VIBRATO

VIBRATO corresponds to the LFO of an analog synthesizer, and it oscillates the low frequencies of the DCO to apply a vibrato effect. This key is used to set 4 parameters: WAVE, DELAY, RATE and DEPTH.

The LCD appears as in Fig. 12 when the VIBRATO key is pressed.

(Fig. 12)

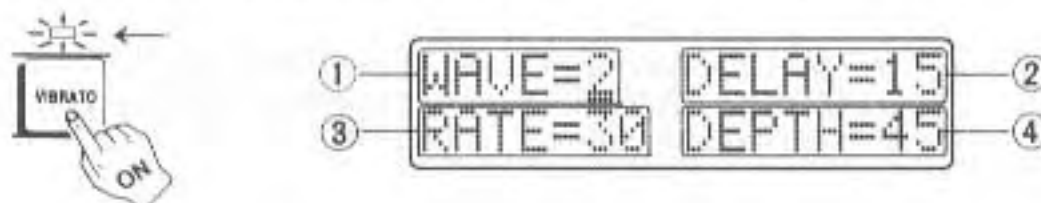

- ① WAVE is the parameter that selects the vibrato waveform, and is set to a value in the range of 1 through 4 using the VALUE keys. The 4 waveforms are as follows:

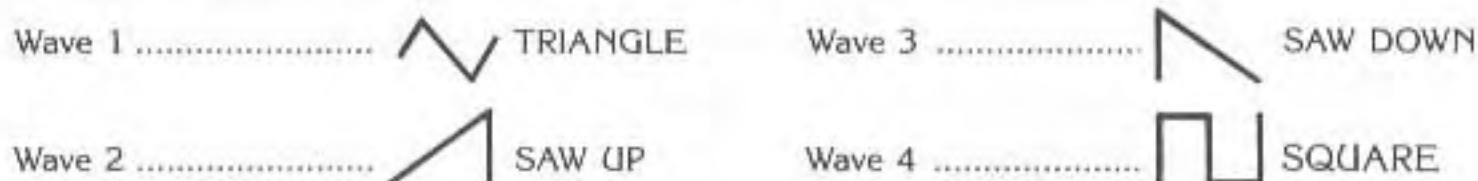

- ② DELAY is the parameter that sets the time from when a key is pressed until the point at which vibrato is applied. DELAY is set to a value in the range of 0 through 99 using the VALUE keys after the cursor is moved to the proper position with the CURSOR keys. The larger the value, the later vibrato is applied.
- ③ RATE is the parameter that sets the period (speed) of the vibrato. RATE is set to a value in the range of 0 through 99 using the VALUE keys after the cursor is moved to the proper position with the CURSOR keys. The larger the value, the faster the vibrato.
- ④ DEPTH is the parameter that sets the depth of the vibrato. DEPTH is set to a value in the range of 0 through 99 using the VALUE keys after the cursor is moved to the proper position with the CURSOR keys. The larger the value, the deeper the vibrato.

■ OCTAVE

This parameter is used to raise and lower pitch by one octave, and each timbre can be set to a suitable pitch.

The LCD appears as in Fig. 13 when the OCTAVE key is ON.

(Fig. 13)

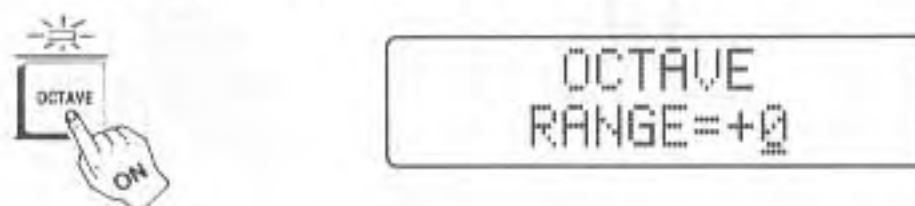

The VALUE keys in the Data Entry Section are used to set the OCTAVE RANGE to a value of +1 (one octave up), 0 or -1 (one octave down).

*The initial data settings for each preset and internal memory timbre also include an OCTAVE RANGE setting.

■ DETUNE

The pitch between different tones in DCO 1 and DCO 2 can be detuned, the DCO 2 timbre pitch only can be detuned, or a DCO 1 with detuned pitch can be used in combination with a pitch that has not been detuned for the creation of a chorus effect. The result of a detuned Line 1 DCO is referred to as 1, while that of a detuned Line 2 DCO is 2.

The LCD appears as in Fig. 14 when the DETUNE key is ON. (The cursor is located below the OCT value.)

(Fig. 14)

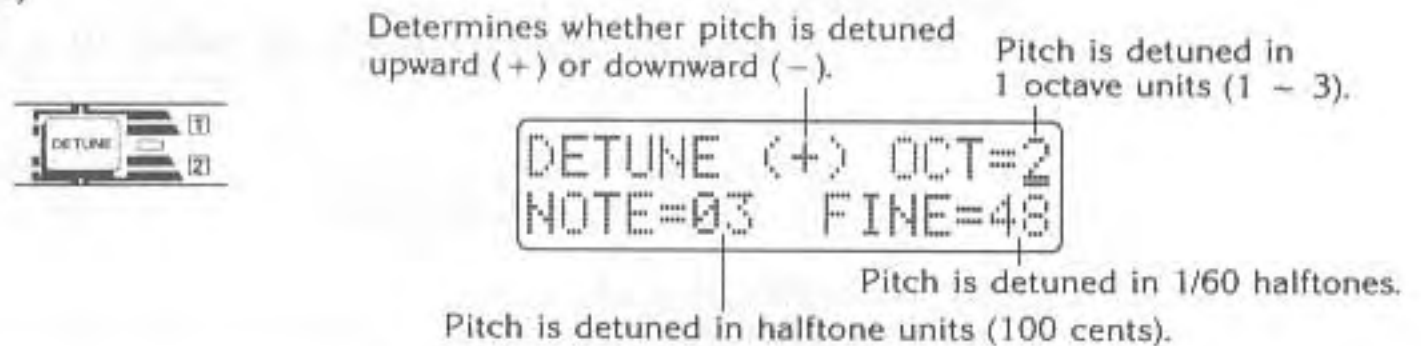

The following operations can be performed to allow monitoring of the degree of detuning.

•Line 1 detune (Use the LINE SELECT key to select 1 + 1. (Lights indicate the current selector setting.)

•Line 2 detune (Use the LINE SELECT key to select 1 + 2.)

*Individual monitoring of line 1 or 2 is impossible.

1) Determining the detune direction (up/down)

Use the CURSOR keys to move the cursor under the (+/-) indicator and the VALUE keys to change between plus and minus. Set to + to raise pitch and to - to lower pitch.

2) Detuning in 1 octave units

Move the cursor under the OCT value and use the VALUE keys to change the value within a range of 0 through 3. The pitch can be raised or lowered up to 3 octaves in one octave units.

3) Detuning in half tone (100 cents) units

Move the cursor under the NOTE value and use the VALUE keys to change the value within a range of 0 through 11. The pitch can be raised or lowered up to 11 (100 cents).

4) Fine detune

Move the cursor under the FINE value and use the VALUE keys to change the value within a range of 0 through 60. The pitch can be raised or lowered up to 1/60 half tones (approximately 1.7 cents).

*Using data 1 through 4 in combination makes it possible to detune within a range of ± 4 octaves. If OCT, NOTE and FINE are all set to 0, LINE 1 = LINE 1 and LINE 2 = LINE 2.

■ LINE SELECT

This function makes it possible to select the best line combination for the type of sound being produced. The data settings for each preset and internal memory timbre also include LINE settings.

The line setting changes in the following order each time the LINE SELECT key is pressed:

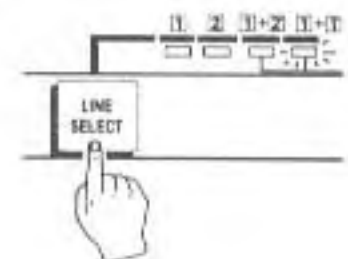

• **Line select** [1]

16-note polyphonic for creation of simple sounds.

• **Line select** [2]

16-note polyphonic for monitoring LINE [2] during [1] + [2] tone creation.

• **Line select** [1] + [2]

8-note polyphonic for creating sounds with complex harmonics structures. Same as [1] + [2] when all detune values (OCT, NOTE, FINE) are set to 0.

• **Line select** [1] + [1]

8-note polyphonic for ensemble and chorus effects. Same as [1] + [1] when all detune values (OCT, NOTE, FINE) are set to 0.

*When more than 8 keys are pressed in 8-note polyphonic, the most recently pressed keys are usually given priority.

■ RING MODULATION

Pressing the RING key causes an indicator to light above the key and LINE [1] and LINE [2] output is ring modulated by LINE [1]. Pressing the RING key again will turn the function OFF. Ring modulation is only possible when LINE SELECT is set to [1] + [2] or [1] + [1].

Ring modulation is used when creating bell-type sounds.

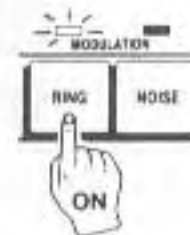

■ NOISE MODULATION

Pressing the NOISE key causes an indicator to light above the key and LINE [1] or LINE [2] output is modulated by noise. Pressing the NOISE key again will turn the function OFF. Noise modulation is only possible when LINE SELECT is set to [1] + [2] or [1] + [1]. Noise modulation is used when creating wind or percussion sounds.

*The RING and NOISE keys mutually cancel each other.

Extreme settings in the Parameter Section can result in no sound production at all when the range of possible sounds is exceeded.

■ INITIALIZE

This function returns parameters to their initial settings. Press the key that corresponds to the parameter to be initialized while holding the INITIALIZE key down. The LCD will then show the initialized status of the parameter.

(Example 1) Initializing the VIBRATO values.

① Press and hold down the INITIALIZE key.

② Simultaneously press the VIBRATO key.



<LCD>

```
WAVE=1  DELAY=00  
RATE=00  DEPTH=00
```

(Example 2) Initializing the values of the DCA 1.

- ① Press and hold down the INITIALIZE key. ② Simultaneously press the DCA 1 ENV key.

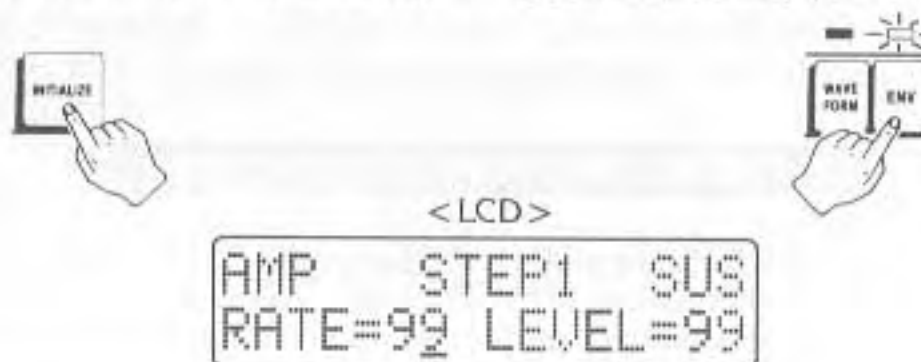

Original sounds can be created following one of two methods:

- 1) Selecting one of the 64 timbres in the Programmer Section that is close to the desired sound and modifying it as required.
- 2) Initializing all parameters and starting from scratch.

The following table shows each parameter's initialized values:

Parameter	Initialized values																
VIBRATO	WAVE = 1, DELAY = 00, RATE = 00, DEPTH = 00																
OCTAVE	RANGE = 0																
WAVE FORM (DCO 1, DCO 2)	FIRST = 1 SECOND = 0																
PITCH ENVELOPE (DCO 1, DCO 2)	<table border="1"> <thead> <tr> <th></th> <th>STEP 1</th> <th>STEP 2-7</th> <th>STEP 8</th> </tr> </thead> <tbody> <tr> <td>RATE</td> <td>50</td> <td>50</td> <td>50</td> </tr> <tr> <td>LEVEL</td> <td>00</td> <td>00</td> <td>00</td> </tr> <tr> <td>ENV POINT</td> <td>SUS</td> <td>***</td> <td>END</td> </tr> </tbody> </table>		STEP 1	STEP 2-7	STEP 8	RATE	50	50	50	LEVEL	00	00	00	ENV POINT	SUS	***	END
	STEP 1	STEP 2-7	STEP 8														
RATE	50	50	50														
LEVEL	00	00	00														
ENV POINT	SUS	***	END														
DCW KEY FOLLOW	RANGE = 0																
WAVE ENVELOPE (DCW 1, DCW 2)	<table border="1"> <thead> <tr> <th></th> <th>STEP 1</th> <th>STEP 2-7</th> <th>STEP 8</th> </tr> </thead> <tbody> <tr> <td>RATE</td> <td>99</td> <td>50</td> <td>50</td> </tr> <tr> <td>LEVEL</td> <td>99</td> <td>00</td> <td>00</td> </tr> <tr> <td>ENV POINT</td> <td>SUS</td> <td>***</td> <td>END</td> </tr> </tbody> </table>		STEP 1	STEP 2-7	STEP 8	RATE	99	50	50	LEVEL	99	00	00	ENV POINT	SUS	***	END
	STEP 1	STEP 2-7	STEP 8														
RATE	99	50	50														
LEVEL	99	00	00														
ENV POINT	SUS	***	END														
DCA KEY FOLLOW	RANGE = 0																
AMP ENVELOPE (DCA 1, DCA 2)	<table border="1"> <thead> <tr> <th></th> <th>STEP 1</th> <th>STEP 2-7</th> <th>STEP 8</th> </tr> </thead> <tbody> <tr> <td>RATE</td> <td>99</td> <td>50</td> <td>50</td> </tr> <tr> <td>LEVEL</td> <td>99</td> <td>00</td> <td>00</td> </tr> <tr> <td>ENV POINT</td> <td>SUS</td> <td>***</td> <td>END</td> </tr> </tbody> </table>		STEP 1	STEP 2-7	STEP 8	RATE	99	50	50	LEVEL	99	00	00	ENV POINT	SUS	***	END
	STEP 1	STEP 2-7	STEP 8														
RATE	99	50	50														
LEVEL	99	00	00														
ENV POINT	SUS	***	END														
DETUNE	OCTAVE = 0, NOTE = 00, FINE = 00																

*Data is initialized to values that are the most convenient for the creation of new tones (00, 99 or middle).

TIMBRE DATA WRITE/SAVE/LOAD

WRITE is used to store newly created timbre data in the memory bank, SAVE is used to collectively store all timbre data to a RAM cartridge and LOAD is used to reload data to the memory bank from cartridge.

MEMORY PROTECT FUNCTION

The function protects against inadvertently erasing valuable timbre data from memory. LOAD from external memory sources and WRITE operations cannot be performed when the PROTECT switch on the back panel of the CZ-3000 is ON.

*The PROTECT switch should only be set to the OFF position during WRITE and LOAD operations. Keep the switch in the ON position for normal use and SAVE operations.



■WRITE

It is said we WRITE altered or newly created timbres when we store them to memory. Data altered in the Parameter Section are temporarily stored after alteration in the COMPARE/RECALL area. Notice this is temporary. Data stored in the COMPARE/RECALL area will be erased the instant other data are altered.

Therefore, it is necessary to WRITE important timbre data from the COMPARE/RECALL area to one of the 32 memory areas of the memory bank.

Before beginning WRITE operations, confirm that the COMPARE/RECALL key is ON.



① Set the PROTECT switch on the back panel of the unit to the OFF position.

*The following will appear on the LCD when the WRITE key is pressed while the PROTECT switch is left ON.

PROTECT SWITCH
* ON *

② While holding down the WRITE key, press, in order, the MEMORY BANK key (A ~ D) and then the Voice Selector (1 ~ 8) that corresponds to the area to which the data is to be written.

(Example) WRITE to memory bank D-5

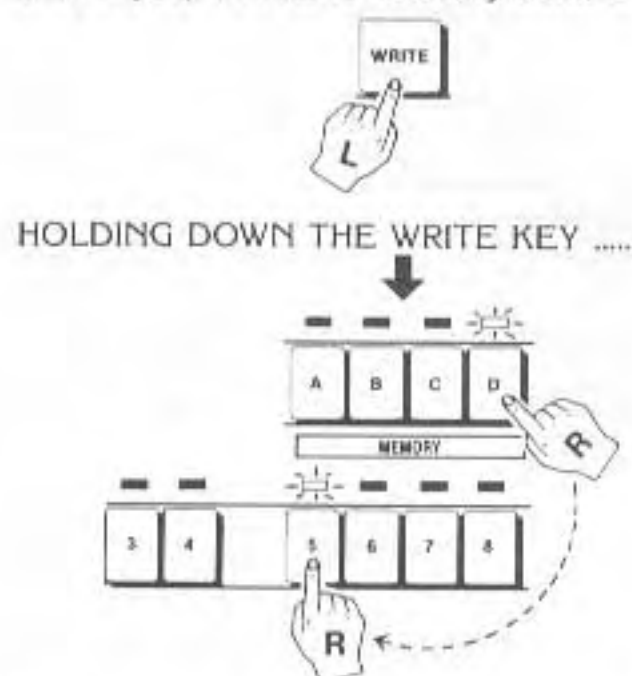

*When the WRITE key is pressed, all indicators in the Programmer Section go out and the following is displayed in the LCD:

WRITE
SELECT MEMORY!

*Press first MEMORY bank key D and then Voice Selector key 5. Indicators will light above the respective keys and the following will appear on the LCD:

WRITE
OK!

*This display indicates that WRITE operations are complete, so the WRITE key can be released. MEMORY D-5 will appear on the LCD.

③ Return the PROTECT switch to the ON position.

- When a timbre is unaltered after calling it in the Programmer Section, or if WRITE is performed with the COMPARE/RECALL key OFF, the data for the timbre is written as it is to the specified memory area. This makes it possible to copy timbres from one memory number to another.
- Always confirm proper WRITE operations by pressing a few keyboard keys in the memory area to which data has been written.

■ SAVE/LOAD

Securely insert a RAM cartridge (RA-3, optional) into the cartridge slot located on the back panel.

(Fig. 1)

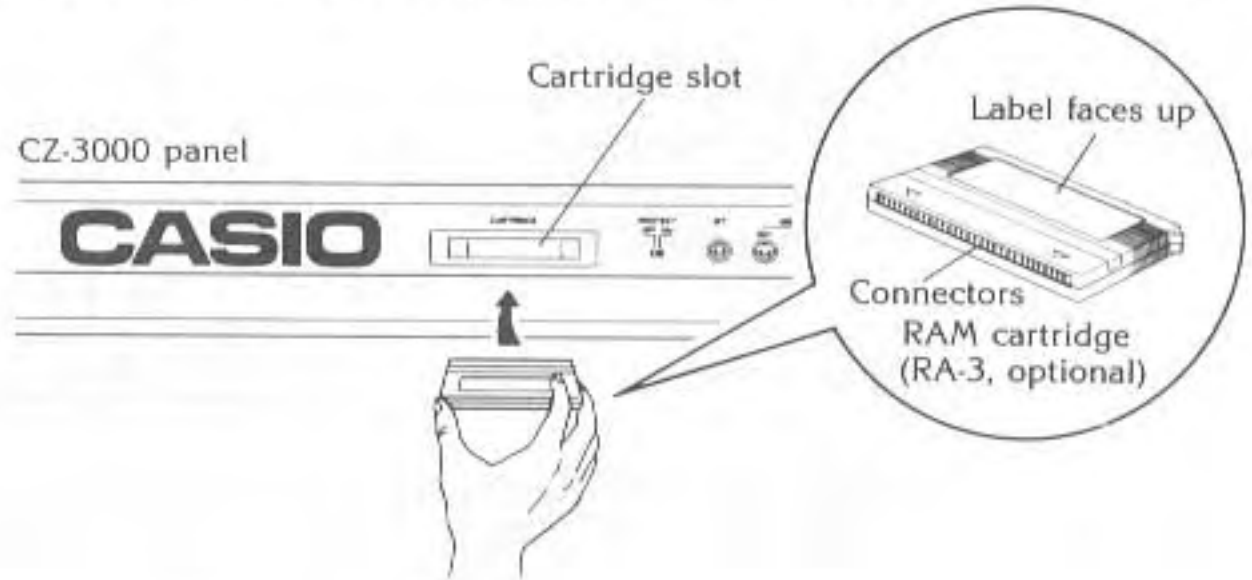

SAVE

- ① Correctly load a cartridge (see Fig. 1).
- ② Press the CARTRIDGE key.



- ③ Press the SAVE (▼) key in the Data Entry Section.



*Separate SAVE/LOAD operations are performed for A/B (16 timbres) and C/D (16 timbres). Here, the display shows that A/B are ready for SAVE. To save C/D, first press the NO (◀) key.

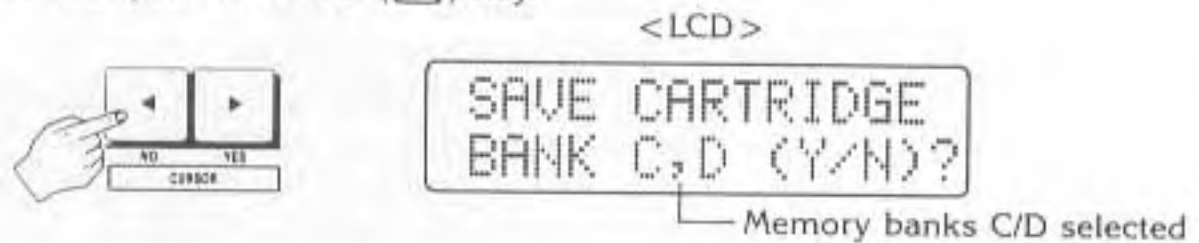

- ④ Actual SAVE operations will begin when the YES (▶) key in the Data Entry Section is pressed.



After banks A/B are saved <LCD>

SAVE CARTRIDGE
BANK A,B OK!

After banks C/D are saved

SAVE CARTRIDGE
BANK C,D OK!

- * SAVE operations are complete when "OK" is displayed.

LOAD

- ① Correctly load a cartridge (see Fig. 1).
 - ② Set the PROTECT switch located on the rear panel of the unit to the OFF position.
- *LOAD cannot be performed and the following will appear on the LCD if the PROTECT switch is left ON.

PROTECT SWITCH
* ON *

- ③ Press the CARTRIDGE key.
- ④ Press the LOAD (▲) key in the Data Entry Section.



- *To load C/D, first press the NO (◀) key.

- ⑤ Actual LOAD operations will begin when the YES (▶) key in the Data Entry Section is pressed.

Banks A/B LOAD

LOAD CARTRIDGE
BANK A,B OK!

Banks C/D LOAD

LOAD CARTRIDGE
BANK C,D OK!

- *LOAD operations are complete when "OK" is displayed.
- *Data passed between the keyboard and RAM cartridge is handled in sets of A/B and C/D. A/B data saved on a cartridge can only be loaded back into memory as A/B.

NOTE

- The following error messages will appear on the LCD if SAVE/LOAD operations are attempted when a RAM cartridge is not loaded or if it is improperly loaded.

SAVE CARTRIDGE
* ERROR *

LOAD CARTRIDGE
* ERROR *

If such messages should appear, reinsert the cartridge as far as it will go and reattempt SAVE/LOAD procedures.

- The optional RA-3 RAM cartridges are equipped with a built-in battery (BR-2016) that will preserve contents for approximately 1 year (longer if the RAM cartridge is inserted in the CZ-3000). If the cartridge is stored outside of the keyboard unit for extended periods, the battery should be periodically replaced to avoid alteration or erasure of data. (See RA-3 OPERATION MANUAL.)
- *RAM contents are erased when the battery is replaced. Load the data from the cartridge to the keyboard before changing the battery.

★ PART 2 ★ TONE MIX MODE

TONE MIX SETTING

With the CZ-3000, two different timbres can be mixed for output. The volumes of the individual timbres that make up a tone mix can be independently controlled. At this time, the keyboard becomes 4-note polyphonic.

- ① Press the TONE MIX key.



- ② Tones can be selected and the volume can be set for the position (LEV 1/LEV 2) at which the cursor is located. In the situation shown above, the cursor is below the level for TONE 1, and so the timbre and volume level can be changed.

- Select 1 timbre using the PRESET and MEMORY BANK keys in the Programmer Section.
- Use the VALUE keys to set the volume level within a range of 1 through 15. A setting of 15 represents maximum volume.

- ③ Use the  CURSOR key in the Data Entry Section to move the cursor under the LEV 2 value. Set the timbre and volume level in the same manner as that outlined for LEV 1.

EFFECT/OVERALL CONTROL

The Effect and Overall Control Sections operate just as in the NORMAL MODE for tone mixed timbres. Setting procedures are identical, and each function is commonly applied to both of the mixed timbres.

- PORTAMENTO TIME and ON/OFF
- GLIDE/NOTE and ON/OFF
- PITCH BEND and MODULATION DEPTH
- MASTER TUNE and KEY TRANSPOSE

*With the exception of MODULATION, effect ON/OFF can be independently set in 3 modes: NORMAL, TONE MIX and KEY SPLIT. Each effect data (numeric) and modulation ON/OFF are common for 3 modes.

*Monophonic play of the tone mixed data is possible when the SOLO key is ON.

Tone mix settings are stored in memory, so they are not cancelled by changing to another mode and then back to the TONE MIX mode.

*However, though TONE 1 and TONE 2 and the volume level are retained, all effects are turned OFF when the power of the unit is switched OFF.

★ PART 3 ★ KEY SPLIT MODE

With the CZ-3000, two timbres can be assigned to the upper and lower ranges of the keyboard. The split point of the keyboard and the individual volumes of the two timbres can be freely set, and effects can be set to ON and OFF.

KEY SPLIT SETTING

- ① Press the KEY SPLIT key in the Mode Select Section.

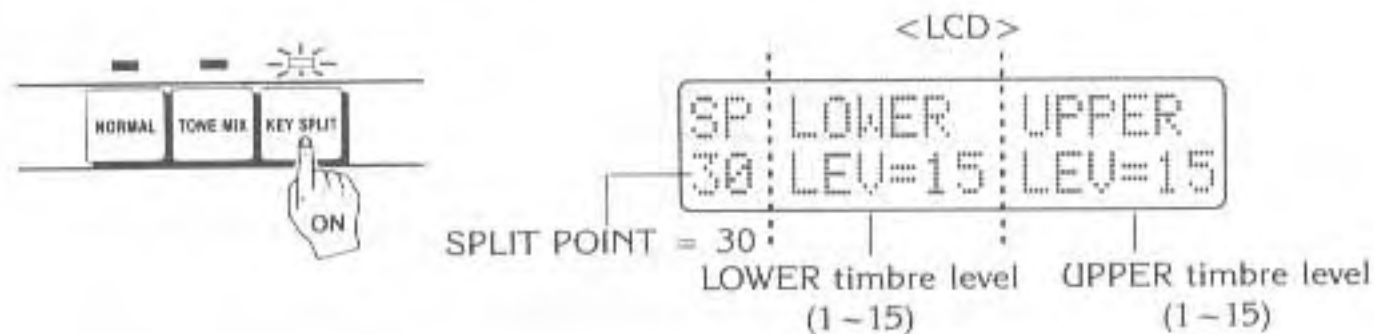

- ② Use the CURSOR keys to move the cursor to the SPLIT POINT value. Use the VALUE keys to set the value within a range of 1 through 60. This determines the split point.

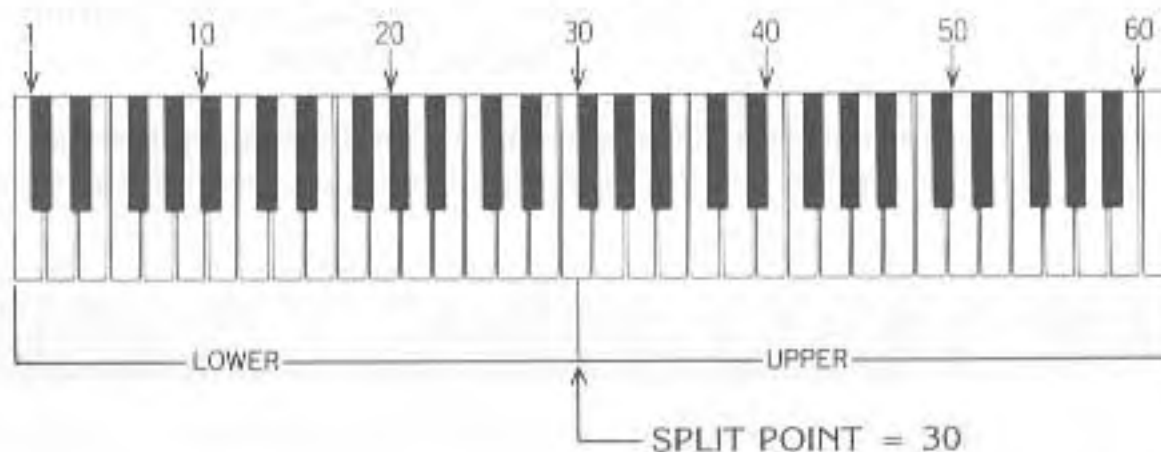

- ③ Use the CURSOR key to move the cursor to the LOWER LEVEL value. Here, the LOWER timbre and volume level are set.
- Select one of the timbres from the PRESET or MEMORY banks in the Programmer Section. The timbre selected will be playable to the left of the split point.
 - The VALUE keys in the Data Entry Section are used to set the volume level within a range of 1 through 15. A setting of 15 represents maximum volume.
- ④ Use the CURSOR key to move the cursor to the UPPER LEVEL value. Select the timbre and set the volume in the same way as for the LOWER LEVEL.

Now the keyboard is split for simultaneous, separate play of two timbres.

EFFECT/OVERALL CONTROL

The Effect and Overall Control Sections operated just as in the NORMAL MODE for key split timbres. Setting procedures are identical, but each function is independently set for the UPPER and LOWER timbres.

- PORTAMENTO TIME and ON/OFF
 - GLIDE/NOTE and ON/OFF
 - PITCH BEND and MODULATION DEPTH
 - MASTER TUNE and KEY TRANSPOSE
- *PORTAMENTO and GLIDE effects are applied to the timbre at which the cursor is located when the respective control key is pressed.
- *SOLO key ON/OFF setting can also be applied independently to the timbres the same as for PORTAMENTO and GLIDE.

Key split settings are stored in memory so they are not cancelled by changing to another mode and then back to the KEY SPLIT mode.

*Though UPPER and LOWER and the volume level are retained, all effects are turned OFF when the power of the unit is switched OFF.

★ PART 4 ★ MIDI

MIDI (MUSICAL INSTRUMENT DIGITAL INTERFACE) is a standard interface that allows the connection of two electronic musical instruments. The CZ-3000 is capable of transmitting the following data:

SEND/RECEIVE DATA

Message	NORMAL		TONE MIX		KEY SPLIT		SEQUENCER	
	Send	Receive	Send	Receive	Send	Receive	Send	Receive
Key pitch, ON/OFF data	<input type="radio"/>	<input type="radio"/>	<input type="radio"/>	<input type="radio"/>	<input type="radio"/>	<input type="radio"/>	<input type="radio"/>	
MODULATION WHEEL data	<input type="radio"/>	<input type="radio"/>	<input type="radio"/>	<input type="radio"/>	<input type="radio"/>	<input type="radio"/>	<input type="radio"/>	
PORTAMENTO TIME		<input type="radio"/>		<input type="radio"/>		<input type="radio"/>		<input type="radio"/>
MASTER TUNE		<input type="radio"/>		<input type="radio"/>		<input type="radio"/>		<input type="radio"/>
PORTAMENTO ON/OFF	<input type="radio"/>	<input type="radio"/>	<input type="radio"/>	<input type="radio"/>	<input type="radio"/>	<input type="radio"/>	<input type="radio"/>	
SUSTAIN PEDAL ON/OFF	<input type="radio"/>	<input type="radio"/>	<input type="radio"/>	<input type="radio"/>	<input type="radio"/>	<input type="radio"/>	<input type="radio"/>	
Timbre number data	<input type="radio"/>	<input type="radio"/>	<input type="radio"/>	<input type="radio"/>	<input type="radio"/>	<input type="radio"/>	<input type="radio"/>	
PITCH BEND data	<input type="radio"/>	<input type="radio"/>	<input type="radio"/>	<input type="radio"/>	<input type="radio"/>	<input type="radio"/>	<input type="radio"/>	
LOCAL CONTROL OFF	<input type="radio"/>	<input type="radio"/>		<input type="radio"/>		<input type="radio"/>		
END OF SYSTEM EXCLUSIVE		<input type="radio"/>	<input type="radio"/>	<input type="radio"/>	<input type="radio"/>	<input type="radio"/>	<input type="radio"/>	<input type="radio"/>

SYSTEM EXCLUSIVE MESSAGE TABLE

Message	NORMAL		TONE MIX		KEY SPLIT		SEQUENCER	
	Send	Receive	Send	Receive	Send	Receive	Send	Receive
(1) SEND REQUEST 1		<input type="radio"/>						
(2) RECEIVE REQUEST 1		<input type="radio"/>						
(3) BEND RANGE		<input type="radio"/>	<input type="radio"/>	<input type="radio"/>	<input type="radio"/>			
(4) KEY TRANSPOSE		<input type="radio"/>	<input type="radio"/>	<input type="radio"/>	<input type="radio"/>			
(5) GLIDE NOTE		<input type="radio"/>	<input type="radio"/>	<input type="radio"/>	<input type="radio"/>			
(6) GLIDE TIME		<input type="radio"/>	<input type="radio"/>	<input type="radio"/>	<input type="radio"/>			
(7) MODULATION DEPTH		<input type="radio"/>	<input type="radio"/>	<input type="radio"/>	<input type="radio"/>			
(8) LEVEL		<input type="radio"/>	<input type="radio"/>	<input type="radio"/>	<input type="radio"/>			
(9) GLIDE ON/OFF	<input type="radio"/>	<input type="radio"/>	<input type="radio"/>	<input type="radio"/>	<input type="radio"/>	<input type="radio"/>	<input type="radio"/>	

MIDI IN EACH MODE

•NORMAL MODE

The following appears on the LCD when the MIDI key is pressed in the NORMAL MODE:

①	P.MODE	KBCH=01	②
③	CH=01	PRG=ENA	④

① P.MODE

Polyphonic mode, indicates polyphonic data interchange capabilities.

② KBCH = 01 (Send channel)

Indicates that Channel 1 is the send channel. The CURSOR keys are used to move the cursor to KBCH and the channel is set within a range of 01 through 16 using the VALUE keys in the Data Entry Section.

③ CH = 01 (Receive channel)

Indicates that Channel 1 is the receive channel. The Cursor keys are used to move the cursor to CH and the channel is set within a range of 01 through 16 using the VALUE keys in the Data Entry Section.

④ PRG = ENA (Timbre data interchange enable)

Indicates that it is possible to exchange timbre data.

SEND CHANNEL AND RECEIVE CHANNEL

When the keyboard is connected to another MIDI keyboard or a rhythm box, one end becomes signal send and the other signal receive. Correct interchange of data is impossible unless the two channels match. This is similar to having to tune in a radio or television to match the transmission frequency from the broadcasting station. Generally, if the send channel is 1, the receive channel must also be 1.

⑤	M.MODE	KBCH=01	
⑥	CH=01(1)	PRG=DIS	⑦

⑤ M.MODE

Pressing one of the VALUE keys in the Data Entry Section when the cursor is under the mode causes the LCD to change as shown here. This display indicates the monophonic mode which means that monophonic data interchange is possible.

⑥ CH = 01 (1) (Basic channel and voice channel setting)

Indicates the receive channel in the mono mode setting. The first value shows the basic channel while the value in parentheses indicates the number of voice channels.

⑦ PRG = DIS (Timbre data interchange disable)

Indicates that it is impossible to exchange timbre data. This setting changes from DIS to ENA and back again with each press of a VALUE key when the cursor is in this position.

POLY MODE AND MONO MODE

In the poly mode, the CZ-3000 is capable of exchanging polyphonic data. As previously mentioned, the send and receive channels must match at this time.

In the mono mode, the CZ-3000 can act as a monophonic synthesizer, able to receive and play independent timbres in each channel.

Using the CURSOR and VALUE keys to change the settings in Fig. 6 to CH = 01 (8) results in 8 voice channels starting with basic channel 1.

Similarly, in the case of CH = 03 (3), channels 3, 4 and 5 are each equivalent to monophonic synthesizers. At this time, the remaining sound sources ($8 - 3 = 5$) can be used for keyboard play.

The timbre from 2 DCO (selecting 1 + 2' or 1 + 1' with the LINE SELECT key) results in 5-note polyphonic, while 1 DCO (selecting 1 or 2) results in 10-note polyphonic. Since all sound sources are used as MIDI channels when the voice channel setting is 8, the keyboard becomes inoperable.

The lamps that are lit on the console of the CZ-3000 do not indicate data received through the MIDI. They show the status of CZ-3000 timbres and effects.

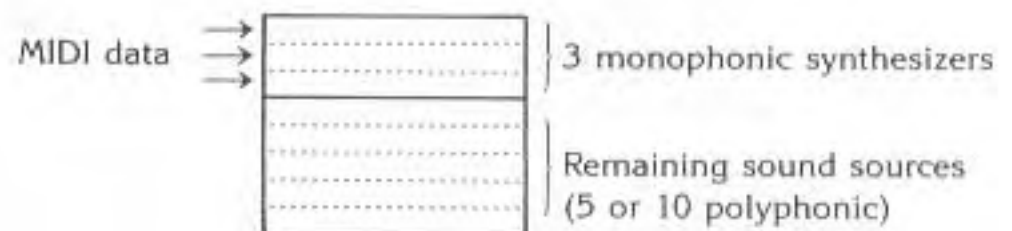

USE AS A MULTI-TIMBRAL EXPANDER

When using the CZ-3000 as a multi-timbral expander, it is possible to choose the preset/memory voice for each MIDI channel. To get into the multi-timbral mode, press the MIDI button and change the mode from "P" to "M" with the value key. Then, move the cursor to the "CH = 01" indicator and choose the bottom number of consecutive channels you want to receive on. Move the cursor underneath the "(1)" to set the desired number of channels. As an example, if the "CH =" is set to "CH = 04", and the other setting is "(6)", the machine will respond to incoming data on channels 4, 5, 6, 7, 8 and 9, and there will still 2 voices left over ($6 + 2 = 8$ total).

Now set voices for each MIDI channel by the following method: connect a MIDI cable from the "MIDI OUT" directly into the "MIDI IN". Set the "KBCH =" to channel 4 and choose a preset/memory number. Switch to "KBCH = 5" and choose a voice, and just keep switching the "KBCH" number until a voice is selected for each channel desired.

```
M. MODE   KBCH=01
CH=04(6)  PRG=ENA
```

PRG = ENA AND PRG = DIS

It is sometimes desirable to keep the timbre of one of the two connected musical instruments fixed. The example here will use two CZ-3000s.



In this example, the timbres of unit Ⓑ are fixed and are unaffected when timbres in unit Ⓐ are changed. If unit Ⓑ were set to PRG = ENA, changes of unit Ⓐ timbres would result in corresponding changes in unit Ⓑ.

•TONE MIX AND KEY SPLIT MODE

The following appears on the LCD when the MIDI key is pressed in the TONE MIX or KEY SPLIT mode:

```
P.MODE  KBCH=01  
CH=01   PRG=ENA
```

In this case, data exchange is only possible in the poly mode, and the mono mode cannot be specified. (The cursor will not move to the P.MODE position.)

Settings for the send channel (KBCH), receive channel (CH) and timbre exchange able/disable (PRG = ENA/DIS) mode are made in the same manner as those for the NORMAL mode (see page 32).

*When timbre change data or volume level change data is received from an external source in the TONE MIX or KEY SPLIT mode, the indicators on the CZ-3000 change for the settings corresponding to the position of the cursor.

CARE OF YOUR UNIT

1. Please be careful of extreme temperatures, moisture and direct sunlight.

Please avoid using or storing your CZ-3000 in places subject to direct sunlight, excessively moist places or near air conditioning and heating appliances where temperatures and moisture tend to be extreme.

2. Please do not drop this instrument or subject it to strong shocks.

Subjecting this precision instrument to strong shocks may cause malfunctioning, so please be very careful. When carrying the CZ-3000 with you or transporting it, please protect it properly with shock-absorbant packaging, in particular the keyboard and switches.

3. Make sure no foreign matter gets into the inside of this instrument.

Please take care that no foreign objects, especially metal objects such as hair pins, sewing needles or coins gets into the instrument e.g. through the gaps between the keys. Also make sure no water or other fluids get in. Any metal objects or water entering the instrument can cause malfunctioning as well as an electric shock hazard.

4. Customizing may cause malfunction and accidents.

The CZ-3000 uses many high-precision electronic components. Converting it in any manner or carelessly touching the internal parts may cause malfunction and accidents and should therefore be avoided under all circumstances.

5. Please do not use thinner and similar chemicals when cleaning this instrument.

When cleaning your CZ-3000, use a soft cloth dampened with a neutral detergent solution which has been wrung out completely to wipe the keyboard etc. Use of thinner, alcohol, benzene and similar chemicals should be avoided under all circumstances.

6. Insert and remove cartridges only after power has been turned off.

Be sure to turn off power when inserting or removing cartridges to protect the RAM.

SPECIFICATIONS

Model	CZ-3000
Keyboard	61 keys/5 octaves
Sound source	PD (phase distortion) system
Voices	16 (1 DCO) or 8 (2 DCOs)
Modes	NORMAL/TONE MIX/KEY SPLIT
Programmer	32 preset voices (fixed) 32 memory voices (exchangeable) WRITE, COMPARE/RECALL
Parameters	DCO 1/DCO 2 Waveform (33 types) Pitch envelope (STEP = 1 ~ 8/RATE = 00 ~ 99/LEVEL = 00 ~ 99/ SUSTAIN/END) DCW 1/DCW 2 Key follow (RANGE = 0 ~ 9) Wave envelope (STEP = 1 ~ 8/RATE = 00 ~ 99/LEVEL = 00 ~ 99/ SUSTAIN/END) DCA 1/DCA 2 Key follow (RANGE = 0 ~ 9) Amp envelope (STEP 1 ~ 8/RATE = 00 ~ 99/LEVEL = 00 ~ 99/ SUSTAIN/END) Vibrato (WAVE = 1 ~ 4/DELAY = 00 ~ 99/RATE = 00 ~ 99/ DEPTH = 00 ~ 99) Octave (RANGE = -1/0/+1) Detune (OCT = 0 ~ 3/NOTE = 00 ~ 11/FINE = 00 ~ 60) Line select (1/2/1 + 2/1 + 1) Ring modulation/Noise modulation Initialize
Tone mix	Tone 1 (LEVEL = 00 ~ 15)/Tone 2 (LEVEL = 00 ~ 15)
Key split	Split point (01 ~ 60) LOWER (LEVEL = 00 ~ 15)/UPPER (LEVEL = 00 ~ 15)
Effect/Overall control	Portamento time (00 ~ 99)/Portamento ON/OFF Glide note (-24 ~ +24)/Glide time (00 ~ 99)/Glide ON/OFF Pitch bend/Bend range (00 ~ 12) Modulation depth (00 ~ 99)/Modulation ON/OFF Master tune (± 100 cents) Key transpose (G ~ F #) Master volume Chorus control
Data entry	Value <input type="checkbox"/> (SAVE)/ <input type="checkbox"/> (LOAD), Cursor <input type="checkbox"/> (NO)/ <input type="checkbox"/> (YES), Envelope step <input type="checkbox"/> / <input type="checkbox"/> , Envelope point (SUSTAIN, END)
LCD	Dot matrix (32-character)
Data SAVE/LOAD	Cartridge RA-3, option (Timbre data SAVE/LOAD: 32 timbres)
Other	Solo

Rear panel	LINE OUT jacks (R/L), Headphone jack (stereo), Sustain jack, Foot volume control jack, MIDI jacks (IN/OUT/THROUGH), Protect switch (ON/OFF), Cartridge slot, Power jack
Power supply	AC 100V, 120V, 220V, 240V
Memory back up	3 size AA dry cells (Battery life: Approximately 1 year)
Power consumption	26W
Dimensions	1025 (W) × 341 (D) × 125 (H) mm (40 ³ / ₈ " (W) × 13 ⁷ / ₁₆ " (D) × 4 ¹⁵ / ₁₆ " (H))
Weight	11.7 kg (25.8 lb) including batteries
Accessories	AC power cord, Plug & cord set, Dust cover, 3 size AA dry cells

**Design and specifications are subject to change without notice.*

WARNING:

CHANGING THE VOLTAGE SELECTOR MAY REQUIRE THE USE OF A DIFFERENT LINE CORD OR ATTACHMENT PLUG, OR BOTH. TO REDUCE THE RISK OF FIRE OR ELECTRIC SHOCK, REFER SERVICING TO QUALIFIED SERVICE PERSONNEL.

GUIDELINES LAID DOWN BY FCC RULES FOR USE OF THE UNIT IN THE U.S.A. (not applicable to other areas).

This equipment generates and uses radio frequency energy and if not installed and used properly, that is, in strict accordance with the manufacturer's instructions, may cause interference to radio and television reception. It has been type tested and found to comply with the limits for a Class B computing device in accordance with the specifications in Subpart J of Part 15 of FCC Rules, which are designed to provide reasonable protection against such interference in a residential installation. However, there is no guarantee that interference will not occur in a particular installation. If this equipment does cause interference to radio or television reception, which can be determined by turning the equipment off and on, the user is encouraged to try to correct the interference by one or more of the following measures:

- reorient the receiving antenna
- relocate the equipment with respect to the receiver
- move the equipment away from the receiver
- plug the equipment into a different outlet so that equipment and receiver are on different branch circuits.

If necessary, the user should consult the dealer or an experienced radio/television technician for additional suggestions. The user may find the following booklet prepared by the Federal Communications Commission helpful: "How to Identify and Resolve Radio-TV Interference Problems". This booklet is available from the US Government Printing Office, Washington, D.C., 20402, Stock No. 004-000-00345-4.

CASIO

CASIO DIGITAL SYNTHESIZER

Model CZ-3000

MIDI Implementation Chart

Function ...		Transmitted	Recognized	Remarks
Basic Channel	Default Changed	1 1-16	1 1-16	
Mode	Default Messages Altered	Mode 3 × *****	Mode 3 ×	Mode setting on panel (Mode 3, Mode 4) possible.
Note Number:	True voice	36-96 *****	0-127 36-96	0-11, 12-23, 24-35 = 36-47, 97-108, 109-120, 121-127 = 85-96
Velocity	Note ON Note OFF	× 9n v = 64 × 9n v = 0	× 9n v = 1-127 → 64 × 9n v = 0, 8n v = × ×	× × = ignored
After Touch	Key's Ch's	× ×	× ×	
Pitch Bender		○	○	8 bits effective, 0-12 half tones
Control Change	1	○	○	MODULATION WHEEL PORTAMENTO TIME MASTER TUNE SUSTAIN PEDAL PORTAMENTO ON/OFF
	5	×	○	
	6	×	○	
	64	○	○	
	65	○	○	
Prog Change:	True #	○ 0-63 *****	○ 0-63 0-31, 32-63	0-31 preset 32-63 memory
System Exclusive		○	○	Timbre data, and others
System Common	: Song Pos : Song Sel : Tune	× × ×	× × ×	
System Real Time	: Clock : Commands	× ×	× (MIDI mode) ×	
Aux Messages	: Local ON/OFF : All Notes OFF : Active Sense : Reset	× × × ×	○ × × ×	
Notes				

Mode 1 : OMNI ON, POLY
Mode 3 : OMNI OFF, POLY

Mode 2 : OMNI ON, MONO
Mode 4 : OMNI OFF, MONO

○ : Yes
× : No

Free Manuals Download Website

<http://myh66.com>

<http://usermanuals.us>

<http://www.somanuals.com>

<http://www.4manuals.cc>

<http://www.manual-lib.com>

<http://www.404manual.com>

<http://www.luxmanual.com>

<http://aubethermostatmanual.com>

Golf course search by state

<http://golfingnear.com>

Email search by domain

<http://emailbydomain.com>

Auto manuals search

<http://auto.somanuals.com>

TV manuals search

<http://tv.somanuals.com>