

LK-300TV

USER'S GUIDE GUÍA DEL USUARIO



GUIDELINES LAID DOWN BY FCC RULES FOR USE OF THE UNIT IN THE U.S.A. (not applicable to other areas).

NOTICE

This equipment has been tested and found to comply with the limits for a Class B digital device, pursuant to Part 15 of the FCC Rules. These limits are designed to provide reasonable protection against harmful interference in a residential installation. This equipment generates, uses and can radiate radio frequency energy and, if not installed and used in accordance with the instructions, may cause harmful interference to radio communications. However, there is no guarantee that interference will not occur in a particular installation. If this equipment does cause harmful interference to radio or television reception, which can be determined by turning the equipment off and on, the user is encouraged to try to correct the interference by one or more of the following measures:

- Reorient or relocate the receiving antenna.
- Increase the separation between the equipment and receiver.
- Connect the equipment into an outlet on a circuit different from that to which the receiver is connected.
- Consult the dealer or an experienced radio/TV technician for help.

FCC WARNING

Changes or modifications not expressly approved by the party responsible for compliance could void the user's authority to operate the equipment.

Declaration of Conformity

Model Number: LK-300TV

Trade Name: CASIO COMPUTER CO., LTD.

Responsible party: CASIO, INC.

Address: 570 MT. PLEASANT AVENUE, DOVER, NEW JERSEY 07801

Telephone number: 973-361-5400

This device complies with Part 15 of the FCC Rules, Operation is subject to the following two conditions:

(1) This device may not cause harmful interference, and (2) this device must accept any interference received, including interference that may cause undesired operation.

Important!

Please note the following important information before using this product.

- Before using the optional AD-5 Adaptor to power the unit, be sure to check the AC Adaptor for any damage first. Carefully check the power cord for breakage, cuts, exposed wire and other serious damage. Never let children use an AC adaptor that is seriously damaged.
- Never attempt to recharge batteries.
- Do not use rechargeable batteries.
- Never mix old batteries with new ones.
- Use recommended batteries or equivalent types.
- Always make sure that positive (+) and negative (-) poles are facing correctly as indicated near the battery compartment.
- Replace batteries as soon as possible after any sign they are getting weak.
- Do not short-circuit the battery terminals.
- The product is not intended for children under 3 years.
- Use only CASIO AD-5 adaptor.
- The AC adaptor is not a toy.
- Be sure to disconnect the AC adaptor before cleaning the product.



This mark applies in EU countries only.



CASIO Europe GmbH
Bornbarch 10, 22848 Norderstedt, Germany

Safety Precautions

Congratulations on your selection of the CASIO electronic musical instrument.

- Before using the instrument, be sure to carefully read through the instructions contained in this manual.
- Be sure to keep all user documentation handy for future reference.

Symbols

Various symbols are used in this user's guide and on the product itself to ensure that the product is used safely and correctly, and to prevent injury to the user and other persons as well as damage to property. Those symbols along with their meanings are shown below.

DANGER

This symbol indicates information that, if ignored or applied incorrectly, creates the danger of death or serious personal injury.

WARNING

This indication stipulates matters that have the risk of causing death or serious injury if the product is operated incorrectly while ignoring this indication.

CAUTION

This indication stipulates matters that have the risk of causing injury as well as matters for which there is the likelihood of occurrence of physical damage only if the product is operated incorrectly while ignoring this indication.

Symbol Examples



This triangle symbol (\triangle) means that the user should be careful. (The example at left indicates electrical shock caution.)



This circle with a line through it (\odot) means that the indicated action must not be performed. Indications within or nearby this symbol are specifically prohibited. (The example at left indicates that disassembly is prohibited.)



The black dot (\bullet) means that the indicated action must be performed. Indications within this symbol are actions that are specifically instructed to be performed. (The example at left indicates that the power plug must be unplugged from the electrical socket.)

DANGER

Alkaline Batteries

Perform the following steps immediately if fluid leaking from alkaline batteries ever gets into your eyes. 

1. Do not rub your eyes! Rinse them with water.
 2. Contact your physician immediately.
- Leaving alkaline battery fluid in your eyes can lead to loss of sight.

WARNING



Smoke, Strange Odor, Overheating

Continued use of the product while it is emitting smoke, a strange odor, or heat creates the risk of fire and electric shock. Take the following steps immediately.



1. Turn off power.
2. If you are using the AC adaptor for power, unplug it from the wall outlet.
3. Contact your original retailer or an authorized CASIO Service Provider.



AC Adaptor

● Misuse of the AC adaptor creates the risk of fire and electric shock. Always make sure you observe the following precautions.

- Be sure to use only the AC adaptor that is specified for this product.
- Use only a power source whose voltage is within the rating marked on the AC adaptor. 
- Do not overload electrical outlets and extension cords. 

● Misuse of the AC adaptor's electric cord can damage or break it, creating the risk of fire and electric shock. Always make sure you observe the following precautions.

- Never place heavy objects on the cord or subject it to heat. 
- Never try to modify the cord or subject it to excessive bending.
- Never twist or stretch the cord.
- Should the electric cord or plug become damaged, contact your original retailer or authorized CASIO Service Provider. 

- Never touch the AC adaptor while your hands are wet. Doing so creates the risk of electric shock. 
- Use the AC adaptor where it will not be splashed with water. Water creates the risk of fire and electric shock. 
- Do not place a vase or any other container filled with liquid on top of the AC adaptor. Water creates the risk of fire and electric shock. 

Batteries

Misuse of batteries can cause them to leak, resulting in damage to nearby objects, or to explode, creating the risk of fire and personal injury. Always make sure you observe the following precautions.

- Never try to take batteries apart or allow them to become shorted. 
- Never expose batteries to heat or dispose of them by incineration.
- Never mix old batteries with new ones.
- Never mix batteries of different types.
- Do not charge the batteries.
- Make sure the positive (+) and negative (-) ends of the batteries are facing correctly.

Do not incinerate the product.

Never throw the product into fire. Doing so can cause it to explode, creating the risk of fire and personal injury. 

Water and Foreign Matter

Water, other liquids, and foreign matter (such as pieces of metal) getting into the product create the risk of fire and electric shock. Take the following steps immediately. 

1. Turn off power.
2. If you are using the AC adaptor for power, unplug it from the wall outlet.
3. Contact your original retailer or an authorized CASIO Service Provider.

Disassembly and Modification

Never try to take this product apart or modify it in any way. Doing so creates the risk of electric shock, burn injury, or other personal injury. Leave all internal inspection, adjustment, and maintenance up to your original retailer or authorized CASIO Service Provider. 

Dropping and Impact

Continued use of this product after it has been damaged by dropping or subjecting it to strong impact creates the risk of fire and electric shock. Take the following steps immediately.



1. Turn off power.
2. If you are using the AC adaptor for power, unplug it from the wall outlet.
3. Contact your original retailer or an authorized CASIO Service Provider.

Plastic Bags

Never place the plastic bag the product comes in over your head or in your mouth. Doing so creates the risk of suffocation. Particular care concerning this precaution is required where small children are present.



Keep off of the product and stand.*

Climbing onto the product or stand can cause it to tip over or become damaged. Particular care concerning this precaution is required where small children are present.



Location

Avoid locating the product on an unstable stand, on an uneven surface, or any other unstable location. An unstable location can cause the product to fall over, creating the risk of personal injury.



CAUTION

AC Adaptor

- Misuse of the AC adaptor creates the risk of fire and electric shock. Always make sure you observe the following precautions.
 - Do not locate the electric cord near a stove or other sources of heat.
 - Never pull on the cord when unplugging from the electrical outlet. Always grasp the AC adaptor when unplugging.
- Misuse of the AC adaptor creates the risk of fire and electric shock. Always make sure you observe the following precautions.
 - Insert the AC adaptor into the wall outlet as far as it will go.
 - Unplug the AC adaptor from the wall outlet during lightening storms or before leaving on a trip or other long-term absence.
 - At least once a year, unplug the AC adaptor from the wall outlet and wipe away any dust that is built up in the area around the prongs of the plug.



Relocating the Product

Before relocating the product, always unplug the AC adaptor from the wall outlet and disconnect all other cables and connecting cords. Leaving cords connected creates the risk of damage to the cords, fire, and electric shock.



Cleaning

Before cleaning the product, always unplug the AC adaptor from the wall outlet first. Leaving the AC adaptor plugged in creates the risk of damage to the AC adaptor, fire, and electric shock.



Batteries

Misuse of batteries can cause them to leak resulting in damage to nearby objects, or to explode, creating the risk of fire and personal injury. Always make sure you observe the following precautions.

- Use only batteries that are specified for use with this product.
- Remove batteries from the product if you do not plan to use it for a long time.

Connectors

Connect only the specified devices and equipment to the product's connectors. Connection of a non-specified device or equipment creates the risk of fire and electric shock.



Location

Avoid the following locations for this product. Such locations create the risk of fire and electric shock.



- Areas subject to high humidity or large amounts of dust.
- In food preparation areas or other areas subject to oil smoke.
- Near air conditioning equipment, on a heated carpet, in areas exposed to direct sunlight, inside of a vehicle parked in the sun, or any other area that subjects the product to high temperatures.

Display Screen

- Never push on the display screen's LCD panel or subject it to strong impact. Doing so can cause the LCD panel's glass to crack, creating the risk of personal injury.
- Should the LCD panel ever crack or break, never touch the liquid inside of the panel. LCD panel liquid can cause skin irritation.
- Should LCD panel liquid ever get inside your mouth, immediately wash out your mouth with water and contact your physician.
- Should LCD panel liquid ever get into your eyes or onto your skin, rinse with clear water for at least 15 minutes, and then contact a physician.



Sound Volume

Do not listen to music at very loud volumes for long periods. Particular care concerning this precaution is required when using headphones. High volume settings can damage your hearing.



Health Precaution

In extremely rare cases, exposure to strong sudden light or flashing light can cause momentary muscle spasms, loss of consciousness, or other physical problems with some individuals.

- If you suspect that you might be susceptible to any condition such as this, be sure to consult with your physician before using this product.
- Use this product in an area that is well illuminated.



- Should you ever feel any symptoms similar to those described above when using this product, stop using it immediately and contact your physician.



Heavy Objects

Never place heavy object on top of the product.

Doing so can make the product top heavy, causing the product to tip over or the object to fall from it, creating the risk of personal injury.



Correct Stand* Assembly

An incorrectly assembled stand can tip over, causing the product to fall and creating the risk of personal injury.

Make sure you assemble the stand correctly, following the assembly instructions that come with it. Make sure you mount the product on the stand correctly.



* Stand is available as an option.

IMPORTANT!

When using batteries, be sure to replace them or shift to one of the alternate power sources whenever you notice any of the following symptoms.

- Dim power supply indicator
- Instrument does not turn on
- Dim, difficult to read display
- Abnormally low speaker/headphone volume
- Distortion of sound output
- Occasional interruption of sound when playing at high volumes
- Sudden power failure when playing at high volumes
- Dimming of the display when playing at high volume
- Continued sound output even after you release a key
- A totally different tone may sound
- Abnormal rhythm pattern and demo tune play
- Abnormally low microphone volume
- Distortion of microphone input
- Dim power supply indicator when a microphone is used
- Sudden power failure when using the microphone
- Dimming of keyboard lights when notes sound
- Loss of power, sound distortion, or low volume when playing from a connected computer



Main Features

□ 514 tones

A wide selection of tones includes stereo piano and synthesized sounds, drum sets, and much more. Other features include digital effects that control the acoustical characteristic of tones.

□ PIANO BANK button

The touch of a button takes you directly to piano tones and piano lessons.

□ Advanced 3-Step Lesson System

The 3-Step Lesson System lets you practice at your own pace. The keyboard automatically grades your performances, so you can trace your progress as you improve.

- 3-Step Lesson System: Use any of the keyboard's built-in tunes and SMF data from a memory card to learn to play as the keyboard keys light to teach you the correct notes. First practice the timing of the notes. Next, play along at your own pace. Soon you will be ready for step three, where you play along at normal speed.
 - * Note that key lights may be difficult to see under direct sunlight or under other very bright lighting.
- Evaluation System: The keyboard can be configured to rate your performances during Step 1, Step 2, and Step 3 lessons by assigning points. You can even have the keyboard report your points vocally, both part way through and at the end of a lesson.

□ Karaoke

Simply connect a commercially available microphone to the microphone jack and you can sing along with the keyboard's built-in tunes and SMF data from a memory card.

□ 100 built-in tunes, including piano pieces

Built-in tunes are divided into two groups: a Song Bank of 50 tunes with Auto Accompaniment, and a Piano Bank of 50 piano tunes. You can simply enjoy listening to the built-in tunes, or eliminate either hand part of a tune, and then play along on the keyboard.

□ 120 rhythms

A selection of rhythms cover rock, pops, jazz and just about any other musical style imaginable.

□ Auto Accompaniment

Simply play a chord and the corresponding rhythm, bass, and chord parts play along automatically.

□ Musical Information System

A big LCD screen graphically shows you fingerings and notes, making keyboard play more informative and enjoyable than ever before.

□ Song Memory function

With lesson recording you can record as you play along with built-in tunes for later playback. Performance recording lets you record your performances, including Auto Accompaniment, in real time. When playing back recorded data, keyboard keys light in time with the melody.

□ Storing and Playing Back Tune Data You Transferred from Your Computer

You can connect your keyboard to a computer, use special CASIO conversion software to convert SMF data you purchase or create to CASIO format, and then transfer it to the keyboard.

□ Memory Card Slot

You can load a card with a standard MIDI file (SMF) and play it back on the keyboard.

□ VIDEO OUT Jack

Connect the keyboard to a TV equipped with a video input jack and you can view lesson information on your TV screen. You can also view lyric data for easy reading during karaoke.

You can also specify the type of alphabet that should be used for TV screen display (Russian Cyrillic or Latin).



Contents

Safety Precautions E-1

Main Features E-5

General Guide E-8

Attaching the Score Stand E-10

Quick Reference E-11

To play the keyboard E-11

Power Supply E-13

Using batteries E-13

Using the AC Adaptor E-13

Auto Power Off E-14

Power On Alert E-14

Memory Contents E-14

Connections E-15

Phones/Output Jack E-15

USB port E-15

Sustain/Assignable Jack E-15

Microphone Jack E-16

VIDEO OUT Jack E-16

Accessories and Options E-16

Basic Operations E-17

To play the keyboard E-17

Selecting a Tone E-17

Using Tone Effects E-18

Turning the Key Light System
On and Off E-18

Playing a Built-in Tune E-19

To play back a Song Bank tune E-19

To play back a Piano Bank tune E-20

Musical Information System E-20

Adjusting the Tempo E-20

To pause playback E-21

To fast reverse E-21

To fast forward E-21

Looping a Musical Phrase E-21

To change the melody tone E-22

To play all tunes in succession E-22

Using the PIANO BANK Button E-22

Using the SMF Data on the Bundled
CD-ROM E-22

Advanced 3-Step Lesson E-23

Evaluation Mode E-24

Using the Lesson Functions and
Evaluation Mode E-25

Step 1 – Master the timing. E-25

Step 2 – Master the notes. E-26

Step 3 – Play at normal speed. E-27

Using the Phrase Practice Mode E-27

Voice Fingering Guide E-28

Using the Metronome E-28

Using a Microphone for Karaoke E-29

Auto Accompaniment E-31

Selecting a Rhythm E-31

Playing a Rhythm E-32



Using Auto Accompaniment E-32

Using an Intro Pattern E-35

Using a Fill-in Pattern E-35

Using a Rhythm Variation E-35

Using a Fill-in Pattern with a Variation
Rhythm E-36

Synchro Starting Accompaniment with
Rhythm Play E-36

Finishing with an Ending Pattern E-36

Song Memory Function E-37

Parts and Tracks E-37

Recording Play Along with
a Built-in Tune E-38

Playing Back a Lesson Recording E-39

Recording a Performance E-39

Playing Back a Performance
Recording E-41

Overdubbing a Performance
Recording E-42

Deleting a Specific Part/Track E-42

Keyboard Settings E-43

Using Layer E-43

Using Split E-44

Using Layer and Split Together E-44

Transposing the Keyboard E-45

Using Touch Response E-46

Adjusting Accompaniment and
Song Bank Volume E-46

Tuning the Keyboard E-47

Selecting the Alphabet Type for
TV Screen Display E-47

Connection to a Computer E-48

Connecting to a Computer E-48

Expanding the Selections in the
Song Bank Tunes E-49

General MIDI Tone E-50

Changing the Settings E-50

Using a Memory Card E-52

Getting Ready E-53

Reading a Memory Card E-54

Memory Card Error Messages E-55

Troubleshooting E-57

Specifications E-59

Care of your keyboard E-60

Appendix A-1

Tone List/Note Table A-1

Drum Assignment List A-5

FINGERED Chord Chart A-7

Rhythm List A-8

Song List A-9

***MIDI messages that can be sent
and received using the USB port***

Company and product names used in this manual may be registered trademarks of others.

General Guide

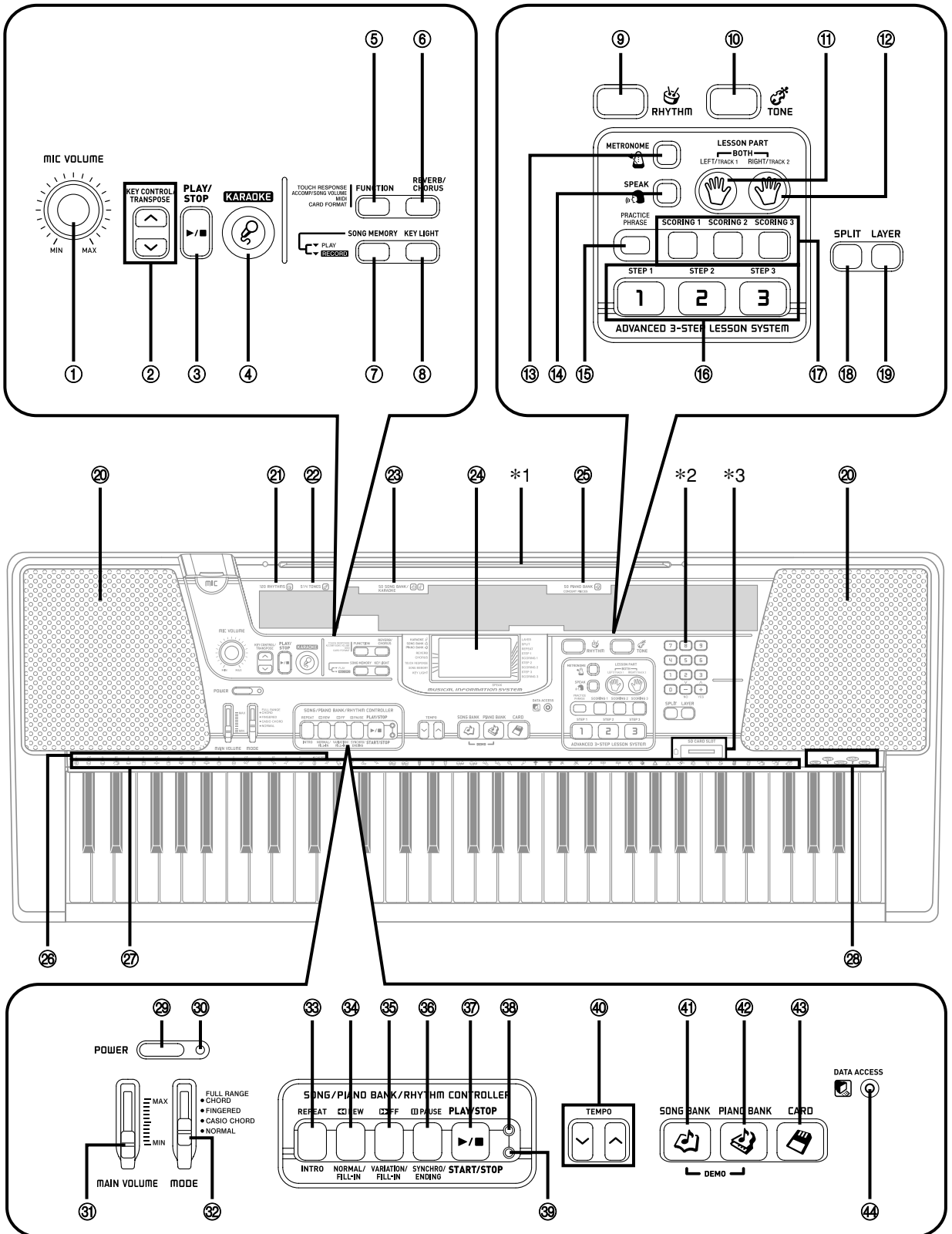

**NOTE**

- This keyboard has two PLAY/STOP buttons. In this manual, the PLAY/STOP button that is located near the KARAOKE button is indicated as <PLAY/STOP>.

- | | |
|--|--|
| ① MIC VOLUME knob | ②③ SONG BANK/KARAOKE list |
| ② KEY CONTROL/TRANPOSE buttons | ②④ Display |
| ③ <PLAY/STOP> button | ②⑤ PIANO BANK list |
| ④ KARAOKE button | ②⑥ CHORD root names |
| ⑤ FUNCTION button | ②⑦ Percussion instrument list |
| ⑥ REVERB/CHORUS button | ②⑧ Voice 1 to 5 list |
| ⑦ SONG MEMORY button | ②⑨ POWER button |
| ⑧ KEY LIGHT button | ③⑩ Power indicator |
| ⑨ RHYTHM button | ③① MAIN VOLUME slider |
| ⑩ TONE button | ③② MODE switch |
| ● ADVANCED 3-STEP LESSON SYSTEM | ● SONG/PIANO BANK/RHYTHM CONTROLLER |
| ①① LEFT/TRACK 1 button | ③③ REPEAT button, INTRO button |
| ①② RIGHT/TRACK 2 button | ③④ REW button, NORMAL/FILL-IN button |
| ①③ METRONOME button | ③⑤ FF button, VARIATION/FILL-IN button |
| ①④ SPEAK button | ③⑥ PAUSE button, SYNCHRO/ENDING button |
| ①⑤ PRACTICE PHRASE button | ③⑦ PLAY/STOP button, START/STOP button |
| ①⑥ STEP 1 to 3 button | ③⑧ Song/Piano Bank controller indicator |
| ①⑦ SCORING 1 to 3 button | ③⑨ Rhythm controller indicator |
| ①⑧ SPLIT button | ④⑩ TEMPO buttons |
| ①⑨ LAYER button | ④① SONG BANK button |
| ②⑩ Speaker | ④② PIANO BANK button |
| ②① RHYTHM list | ④③ CARD button |
| ②② TONE list | ④④ DATA ACCESS lamp |

Controller Indicators

Song/Piano Bank controller indicator

Pressing the SONG BANK, PIANO BANK, or KARAOKE button causes the Song/Piano Bank controller indicator to light. This indicates that buttons ③③ through ③⑦ are currently functioning as playback control buttons.

Rhythm controller indicator

Pressing the RHYTHM button to enter the Rhythm Mode, or pressing the RHYTHM button and then the SONG MEMORY button to enter the Song Memory mode causes the Rhythm controller indicator to light. This indicates that buttons ③③ through ③⑦ are currently functioning as rhythm control buttons.

NOTE

- Display examples shown in this User's Guide are intended for illustrative purposes only. The actual text and values that appear on the display may differ from the examples shown in this User's Guide.
- Viewing a liquid crystal display screen from an angle can change the appearance of display contrast. The display contrast of this keyboard is set to allow easy viewing for a person seated on a chair in front of the keyboard. Note that display contrast is fixed, and cannot be adjusted.

***1 Attaching the Score Stand**

Insert both ends of the music stand provided with the keyboard into the two holes on the top surface.

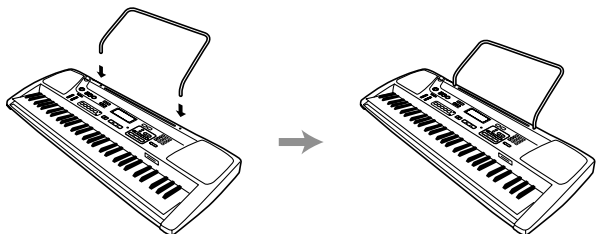

***3**

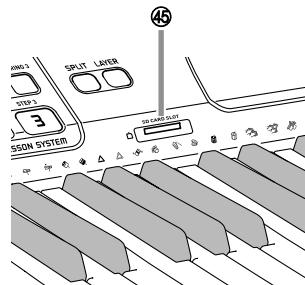

45 SD CARD SLOT

***2**

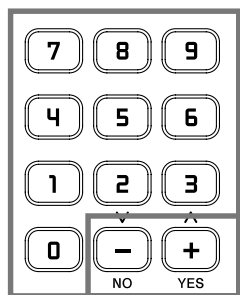

46 Number buttons

47 [+]/[-] buttons

- For input of numbers to change a displayed number or setting.
- Negative values cannot be input using the number buttons. Use [+] (increase) and [-] (decrease) instead.

Rear Panel

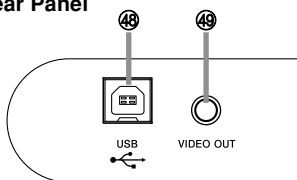

- 48 USB port
- 49 VIDEO OUT jack

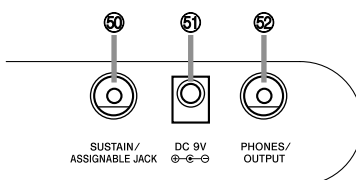

- 50 SUSTAIN/ASSIGNABLE JACK
- 51 DC 9V jack
- 52 PHONES/OUTPUT jack

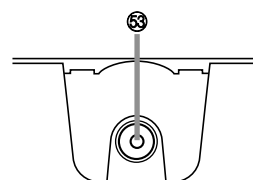

53 MIC jack

Using the Keyboard Position Stickers

Affix the keyboard position stickers that come with the keyboard as shown in the illustration below. The locations of the ▼ and ● marks will correspond to the marks shown in the TV image when you practice while viewing a TV screen. This will make it easier for you to see the relationship between the TV image and the keyboard.

Affix the keyboard position stickers here.

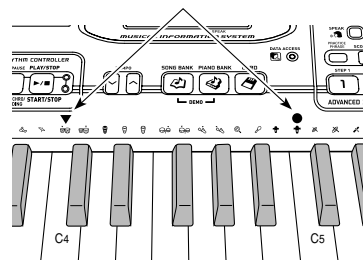

Quick Reference

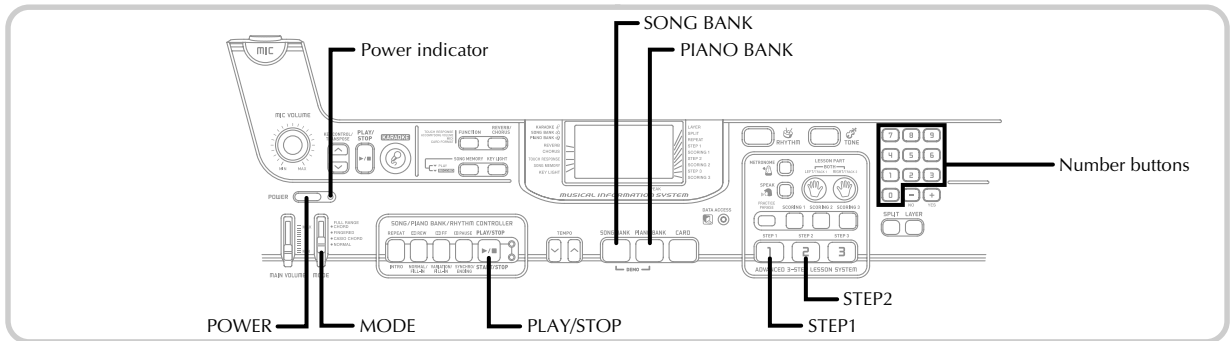

This section provides a quick overview of keyboard operation using steps one and two of the 3-step lesson feature.

To play the keyboard

- 1 Press the POWER button to turn on power.
 - This causes the power indicator to light.

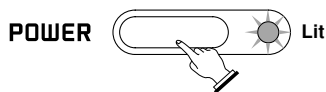

- 2 Set the MODE switch to NORMAL.

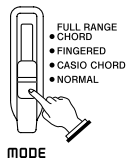

- 3 Press the SONG BANK button.

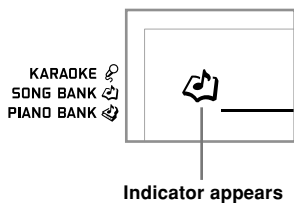

- 4 Find the tune you want to play in the SONG BANK/KARAOKE List, and then use the number buttons to input its two-digit number.
 - See page A-9 for the SONG BANK/KARAOKE List.
 - Example: To select "46 ALOHA OE", input 4 and then 6.



- 5 Press the STEP 1 button or STEP 2 button.
 - The keyboard sounds a count beat and waits for you to play something on the keyboard. The keys that you need to press first flash.

- 6 Play the melody along with the selected tune's accompaniment.
 - Play in accordance with the fingerings, notes, and dynamic marks that appear on the display.

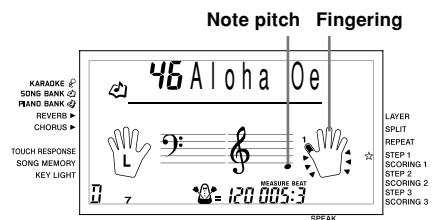

If you selected lesson Step 1

- Play the notes on the keyboard.
- Accompaniment (left-hand part) plays in time with the notes.
- With Step 1, the correct melody note is played no matter which keyboard key you press.

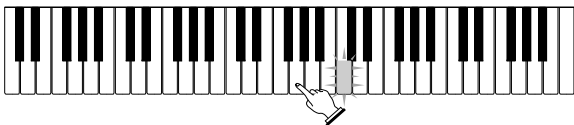

If you selected lesson Step 2

- Play the correct notes on the keyboard.



- Press the keyboard key that lights. Note that with a Piano Bank tune, the keyboard key light turns off as soon as you press the key.
- The keyboard key for the next note you will need to play flashes.
- Accompaniment (left-hand part) plays in time with the notes, as long as you press the correct keyboard keys.

- 7 To stop play at any time, press the PLAY/STOP button.

To play an Etude or Concert Piece tune

- 1 When you get to step 3 of the above procedure, press the PIANO BANK button in place of the SONG BANK button.

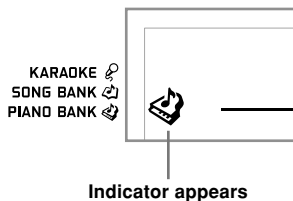

- 2 Find the tune you want to play in the PIANO BANK List, and then use the number buttons to input its two-digit number.
 - See page A-9 for the PIANO BANK List.
- 3 Next, continue from step 5 of the above procedure.

Power Supply

This keyboard can be powered by current from a standard household wall outlet (using the specified AC adaptor) or by batteries. Always make sure you turn the keyboard off whenever you are not using it.

Using batteries

Always make sure you turn off the keyboard before loading or replacing batteries.

To load batteries

- 1 Remove the battery compartment cover.

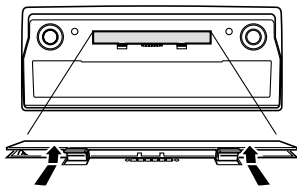

- 2 Load 6 D-size batteries into the battery compartment.

- Make sure that the positive (+) and negative (-) ends are facing correctly.

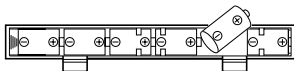

- 3 Insert the tabs on the battery compartment cover into the holes provided and close the cover.

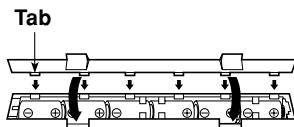

NOTE

- The keyboard may not function correctly if you load or replace batteries with power turned on. If this happens, turning the keyboard off and then back on again should return functions back to normal.

Important Battery Information

- The following shows the approximate battery life.
Manganese batteries 2.5 hours
The above value is standard battery life at normal temperature, with the keyboard volume at medium setting. Temperature extremes or playing at very loud volume settings can shorten battery life.

⚠ WARNING

Misuse of batteries can cause them to leak, resulting in damage to nearby objects, or to explode, creating the risk of fire and personal injury. Always make sure you observe the following precautions.

- Never try to take batteries apart or allow them to become shorted. ⓧ
- Never expose batteries to heat or dispose of them by incineration.
- Never mix old batteries with new ones.
- Never mix batteries of different types.
- Do not charge the batteries.
- Make sure the positive (+) and negative (-) ends of the batteries are facing correctly.

⚠ CAUTION

Misuse of batteries can cause them to leak resulting in damage to nearby objects, or to explode, creating the risk of fire and personal injury. Always make sure you observe the following precautions.

- Use only batteries that are specified for use with this product. ⓧ
- Remove batteries from the product if you do not plan to use it for a long time.

Using the AC Adaptor

Make sure that you use only the AC adaptor specified for this keyboard.

Specified AC Adaptor: AD-5

[Rear Panel]

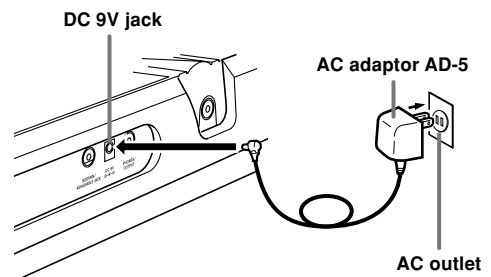

Note the following important precautions to avoid damage to the power cord.

● During Use

- Never pull on the cord with excessive force.
- Never repeatedly pull on the cord.
- Never twist the cord at the base of the plug or connector.
- The power cord should not be stretched tight while it is in use.

● During Movement

- Before moving the keyboard, be sure to unplug the AC adaptor from the power outlet.

● During Storage

- Loop and bundle the power cord, but never wind it around the AC adaptor.

IMPORTANT!

- Make sure that the keyboard is turned off before connecting or disconnecting the AC adaptor.
- Using the AC adaptor for a long time can cause it to become warm to the touch. This is normal and does not indicate malfunction.

Auto Power Off

When you are using battery power, keyboard power turns off automatically whenever you leave it on without performing any operation for about 6 minutes. When this happens, press the POWER button to turn power back on.

NOTE

- Auto Power Off is disabled (it does not function) when you are using the AC adaptor to power the keyboard.

To disable Auto Power Off

Hold down the TONE button while turning on the keyboard to disable Auto Power Off.

NOTE

- When this function is turned off, the keyboard does not turn off automatically no matter how long it is left with no operation being performed.
- Auto Power Off is enabled again when you manually turn off power and then turn it back on again.

Power On Alert

Keyboard keys light to alert you if you leave power on and do not perform any operation for about 6 minutes. Note that keys light only, and no sound is produced. When this happens, press any button or keyboard key to clear the power on alert.

NOTE

- Power on alert operates only when you are powering the keyboard using the AC adaptor. It does not operate when you are using batteries.

To turn off power on alert

- 1 Press the FUNCTION button a number of times until "DEMO 2" appears on the display.
- 2 Use the [+] and [-] buttons to change the setting to "oFF".
- 3 Press the FUNCTION button to clear the setting screen from the display.

Memory Contents

Even when the keyboard is turned off, song memory contents and user song data saved as Song Bank tunes are retained as long as power is being supplied to the keyboard.

Unplugging the AC adaptor when batteries are not loaded or when batteries are dead cuts off the power supply. This causes all keyboard settings to be initialized to the initial factory defaults, and clears all data stored in memory.

Power Requirements

Note the following precautions whenever you want to ensure that current keyboard settings and memory contents are not lost.

- Make sure the keyboard is being supplied power through the AC adaptor before replacing its batteries.
- Before unplugging the AC adaptor, make sure that fresh batteries are loaded in the keyboard.

Make sure that keyboard power is turned off before replacing batteries or unplugging the AC adaptor.

Connections

Phones/Output Jack

PREPARATION

- Before connecting headphones or other external equipment, be sure to first turn down the volume settings of the keyboard and the connected equipment. You can then adjust volume to the desired level after connections are complete.

[Rear Panel]

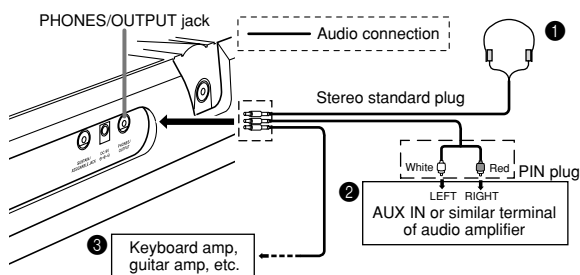

Connecting Headphones (Figure ①)

Connecting headphones cuts off output from the keyboard's built-in speakers, so you can play even late at night without disturbing anyone.

Audio Equipment (Figure ②)

Connect the keyboard to an audio equipment using a commercially available connecting cord with a standard plug on one end and two PIN plugs on the other end. Note that the standard plug you connect to the keyboard must be a stereo plug, otherwise you will be able to output only one of stereo channels. In this configuration, you normally set the input selector of the audio equipment to the terminal (usually marked AUX IN or something similar) where the cord from the keyboard is connected. See the user documentation that comes with your audio equipment for full details.

Musical Instrument Amplifier (Figure ③)

Use a commercially available connecting cord to connect the keyboard to a musical instrument amplifier.

NOTE

- Be sure to use a connecting cord that has a stereo standard plug on the end you connect to the keyboard, and a connector that provides dual channel (left and right) input to the amplifier to which you are connecting. The wrong type of connector at either end can cause one of the stereo channels to be lost.

When connected to a musical instrument amplifier, set the volume of the keyboard to a relatively low level and make output volume adjustments using the amplifier's controls.

Connection Example

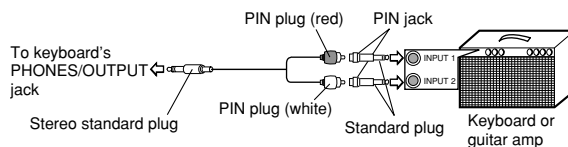

USB port

You can also connect the keyboard to a computer. See "Connecting to a Computer" on page E-48 for details.

Sustain/Assignable Jack

You can connect an optional sustain pedal (SP-3 or SP-20) to the SUSTAIN / ASSIGNABLE JACK to enable the capabilities described below.

For details on how to select the pedal function you want, see "SUSTAIN / ASSIGNABLE JACK (Default: SUS)" on page E-51.

SUSTAIN/ASSIGNABLE JACK

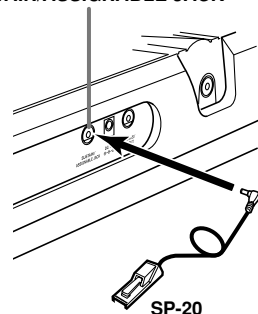

Sustain Pedal

- With piano tones, depressing the pedal causes notes to linger, much like a piano's damper pedal.
- With organ tones, depressing the pedal causes notes to continue to sound until the pedal is released.

Sostenuto Pedal

- As with the sustain pedal function described above, depressing the sostenuto pedal causes notes to be sustained.
- This difference between a sostenuto pedal and sustain pedal is the timing. With a sostenuto pedal, you press the keys and then depress the pedal before you release the keys.
- Only the notes that are sounding when the pedal is depressed are sustained.

Soft Pedal

Depressing the pedal softens the sound of the notes being played.

Rhythm Start/Stop Pedal

In this case, the pedal performs the same functions as the START/STOP button.

Microphone Jack

You can connect a commercially available microphone to the microphone jack and sing along with notes played on the keyboard. For details, see "Using a Microphone for Karaoke" on page E-29.

VIDEO OUT Jack

You can connect the keyboard to a TV equipped with a video input jack, and view lessons*1 and song lyrics*2 on the TV screen.

*1: Lessons using built-in tunes or SMF data

*2: Built-in tunes with lyric data or commercially available SMF data with lyric data

Connecting to a TV

IMPORTANT!

- Make sure that both the keyboard and the TV are turned off before connecting them.
- Placing the keyboard on top of or too close to the TV can cause problems with the colors that appear on the TV screen. Keep the keyboard away from the TV.

Use the bundled video cable to connect the keyboard to a TV as shown below.

- Turn on the TV and perform the required operation to select its video input terminal.
- Turn on the keyboard.

[Rear Panel]

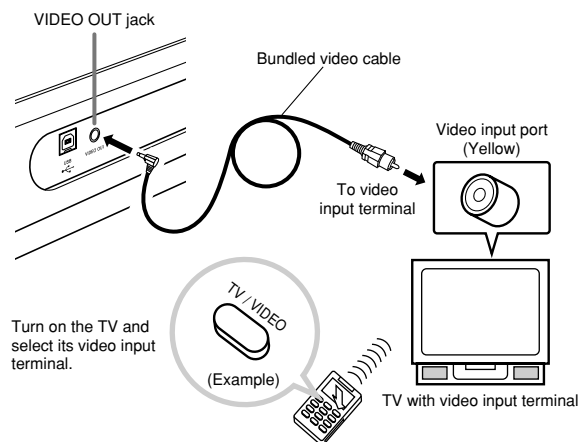

IMPORTANT!

- See the user documentation that comes with your TV for information about how to configure the required settings.
- A TV normally supports either NTSC or PAL as its color system. The system supported by your keyboard matches the system used in the geographic area where you purchased it. The color system is also indicated on the rating plate on the bottom of the keyboard.

Keyboard Model	Supported Color System
LK-300TV-N	NTSC
LK-300TV-P	PAL

Images will not appear correctly on the TV screen if its color system does not match the color system of the keyboard. Make sure you check with your retailer before purchasing the keyboard outside of the area where you will normally use it.

Accessories and Options

Use only the accessories and options specified for this keyboard. Use of non-authorized items creates the danger of fire, electrical shock, and personal injury.

Basic Operations

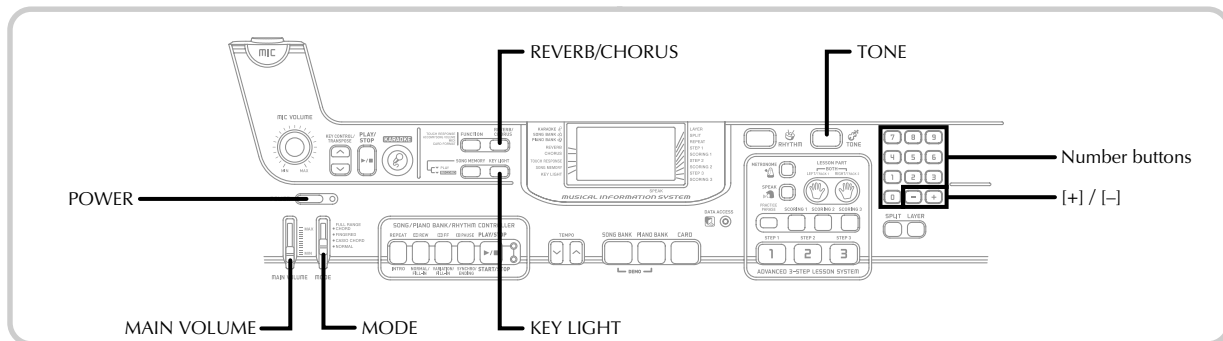

This section provides information on performing basic keyboard operations.

To play the keyboard

- 1 Press the POWER button to turn the keyboard on.
- 2 Set the MODE switch to NORMAL.
- 3 Use the MAIN VOLUME slider to set the volume to a relatively low level.
- 4 Play something on the keyboard.

Selecting a Tone

This keyboard comes with 514 built-in tones. Use the following procedure to select the tone you want.

To select a tone

- 1 Find the tone you want to use in the TONE List and note its tone number.
 - Not all of the available tones are shown on the tone list printed on the keyboard console. For a complete list, see the "Tone List" on page A-1.
 - If the keyboard is connected to a TV, the tone list appears on the TV screen. For information about connecting to a TV, see "VIDEO OUT Jack" on page E-16.

- 2 Press the TONE button.

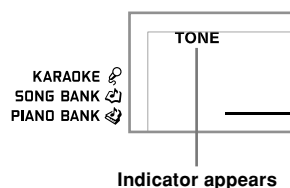

Indicator appears

- 3 Use the number buttons to input the three-digit tone number of the tone you want to select.
Example: To select "049 BRIGHT CELESTA", input 0, 4 and then 9.



NOTE

- Always input all three digits for the tone number, including leading zeros (if any). If you input one or two digits and stop, the display will automatically clear your input after a few seconds.
- You can also increment the displayed tone number by pressing [+] and decrement it by pressing [-].
- When one of the drum sets is selected (tone numbers 500 through 513), each keyboard key is assigned a different percussion sound. See page A-5 for details.

Polyphony

The term polyphony refers to the maximum number of notes you can play at the same time. The keyboard has 32-note polyphony, which includes the notes you play as well as the rhythms and auto-accompaniment patterns that are played by the keyboard. This means that when a rhythm or auto-accompaniment pattern is being played by the keyboard, the number of notes (polyphony) available for keyboard play is reduced. Also note that some of the tones offer only 16-note polyphony.

- When rhythm or auto accompaniment is playing, the number of sounds simultaneously played is reduced.

Using Tone Effects

Reverb: Makes your notes resonate

Chorus: Adds more breadth to your notes

- 1 Press the REVERB/CHORUS button to cycle through the effect settings as shown below.
 - You can find out the current effect setting by looking at the REVERB and CHORUS indicators.

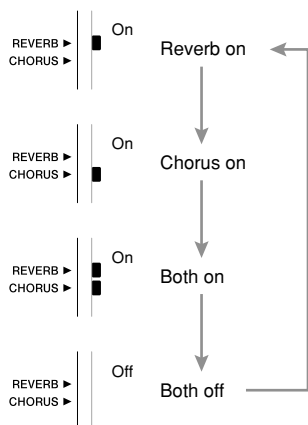

- 2 After turning on the effect you want, use the number buttons or the [+]/[-] buttons to select the effect type you want.

- Note that you need to select an effect type with the number buttons or the [+]/[-] buttons within a few seconds after turning on an effect. If you don't, the display will exit the setting screen.

Effect List

Reverb	0: Room 1
	1: Room 2
	2: Hall 1
	3: Hall 2
Chorus	0: Chorus 1
	1: Chorus 2
	2: Chorus 3
	3: Chorus 4

Turning the Key Light System On and Off

Use the following procedure when you want to turn the key light system on or off.

To turn the key light system on and off

- 1 Press the KEY LIGHT button to toggle the key light system on and off.
 - The KEY LIGHT indicator disappears when the key light system is turned off.

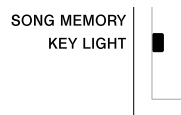

NOTE

- The key light system is turned on automatically whenever you turn on keyboard power.

Playing a Built-in Tune

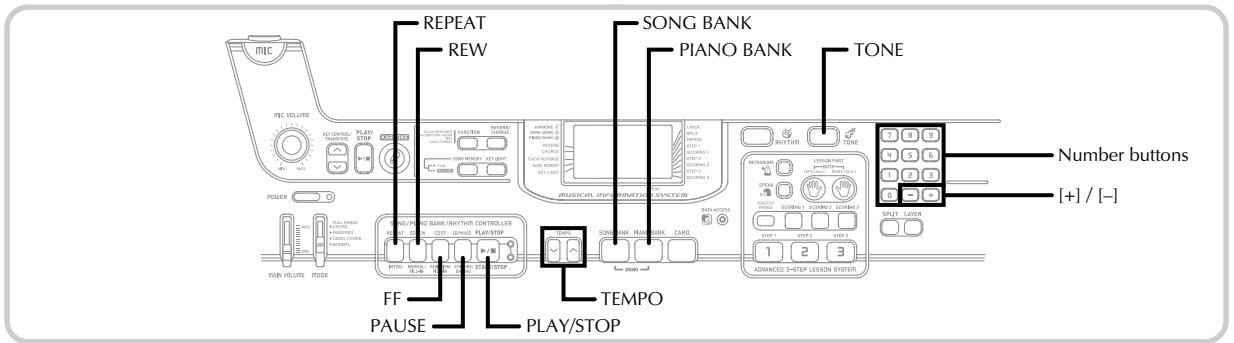

Your keyboard comes with a total of built-in 100 tunes. You can play back built-in tunes for your own listening pleasure, or you can use them for practice and even karaoke. Built-in tunes are divided between the two groups described below.

- **Song Bank/Karaoke Group:** 50 tunes

The tunes in this group are Auto Accompaniment tunes. If you connect a microphone to the keyboard and enter the Karaoke Mode*, you can sing along with the built-in tune.

* The Karaoke Mode reduces the volume of the melody part of the built-in tunes and changes the tone selection to one that makes it easier for a vocalist to follow.

- **Piano Bank Group:** 50 tunes

The piano tunes in this group are subdivided between 20 etudes and 30 concert pieces.

In addition to the built-in tunes, you can also play back the tunes you download over the Internet (page E-49).

To play back a Song Bank tune

PREPARATION

- Adjust the main volume (page E-17).

- 1 Find the tune you want to play in the SONG BANK/KARAOKE List, and note its number.
 - See page A-9 for the SONG BANK/KARAOKE List.
- 2 Press the SONG BANK button to enter the Song Bank Mode.

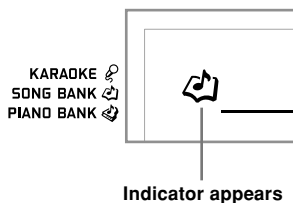

- 3 Use the number buttons to input the tune's two-digit number.

Example: To select "46 ALOHA OE", input 4 and then 6.

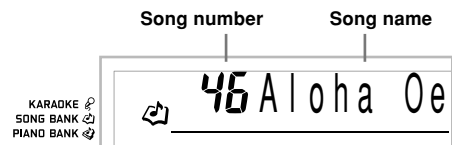

NOTE

- Tune Number 00 is the initial default Song Bank tune setting whenever you turn on keyboard power.
- You can also increment the displayed tune number by pressing [+], and decrement is by pressing [-].

- 4 Press the PLAY/STOP button to start play of the tune.

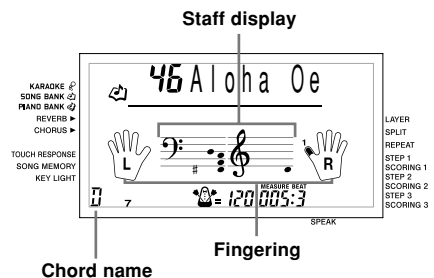

- 5 Press the PLAY/STOP button to stop playback of the Song Bank tune.
 - The tune you select continues to play until you stop it.

To play back a Piano Bank tune

- Find the tune you want to play in the PIANO BANK List, and note its number.
 - See page A-9 for the PIANO BANK List.
- Press the PIANO BANK button to specify the Piano Bank group.

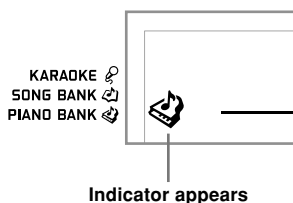

NOTE

- Pressing the PIANO BANK button changes the tone to STEREO GRAND PIANO (Tone Number 000).

- Use the number buttons to input the two-digit tune number you looked up in step 1.

Example: To select tune number 44 (ODE TO JOY), input 4 and then 4.

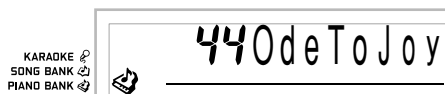

NOTE

- Tune Number 00 is the initial default Piano Bank tune setting whenever you turn on keyboard power.
- You can also change the displayed tune number using the [+] and [-] buttons.

- Press the PLAY/STOP button to start playback.
- To stop playback, press the PLAY/STOP button.
 - The tune you select continues to play until you stop it.

Musical Information System

When the keyboard is playing one of its built-in tunes, the display shows a variety of information about the tune.

Example: Display during Song Bank play

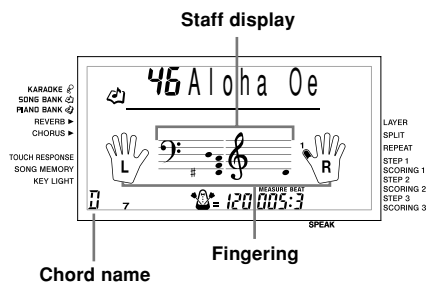

NOTE

- Chord names are not displayed for Piano Bank tunes.

Adjusting the Tempo

The tempo (beats per minute) can be set to a value in the range of 30 to 255. The tempo value you set is used for Song Bank, Piano Bank, karaoke, 3-step lesson, and Auto Accompaniment chord play, as well as playback from Song Memory, memory card, and metronome operation.

To set the tempo

- Use the TEMPO buttons to set the tempo.
 - ∧ : Increases the tempo value.
 - ∨ : Decreases the tempo value.

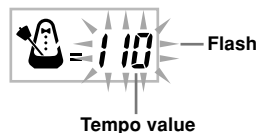

NOTE

- While the tempo value is flashing, you can also use the number buttons or [+] and [-] to input a three-digit value. Note that you must input leading zeros, so 90 is input as 090.
- Pressing both the ∧ and ∨ TEMPO buttons at the same time automatically returns the currently selected rhythm to its default tempo.
- Piano Bank tunes have tempo changes part way through in order to produce specific musical effects.

To pause playback

- 1 Press the PAUSE button while a tune is playing to pause it.
- 2 Pressing the PAUSE button again resumes play from the point where it was paused.

To fast reverse

- 1 While a tune is playing or paused, hold down the REW button to skip in a reverse direction at high speed.
 - The fast reverse operation skips back one measure at a time.
 - The measure and beat numbers on the display change while the fast reverse operation is being performed.



- 2 Releasing the REW button starts song playback from the measure whose number is shown on the display.

NOTE

- Fast reverse does not work while tune play is stopped.
- Certain playback conditions can cause it to take some time before fast reverse starts after you press the REW button.

To fast forward

- 1 While a tune is playing or paused, hold down the FF button to skip forward at high speed.
 - The fast forward operation skips forward one measure at a time.
 - The measure and beat numbers on the display change while the fast forward operation is being performed.



- 2 Releasing the FF button starts song playback from the measure whose number is shown on the display.

NOTE

- Fast forward does not work while tune play is stopped.

Looping a Musical Phrase

You can select one or more measures and “loop” them, which means that they play again and again until you stop playback.

- 1 While the tune is playing, press the REPEAT button while the measure you want to start from is playing.
 - This causes the repeat indicator to flash on the display, and displays the measure number of the start measure.
- 2 When playback is within the measure you want to specify as the end of the loop, press the REPEAT button again.
 - This displays the measure number of the end measure, and starts repeat play of the loop.
 - To cancel repeat play of a loop, press the REPEAT button again so the repeat indicator is not displayed.

To change the melody tone

- 1 Press the TONE button.

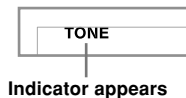

- 2 Find the tone you want in the TONE List, and then use the number buttons to input its three-digit number.

Example: To select “130 VIOLIN”, input 1, then 3, then 0.

- You can select any one of the keyboard’s built-in tones.

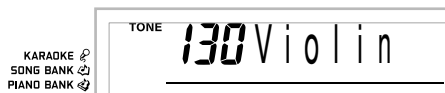

NOTE

- You can also use the [+] and [-] buttons to change the melody tones.
- For two-hand tunes (Piano Bank tunes), the same tone is applied for both the left and right hand parts.
- Specifying the tune number for the same tune that is currently selected returns the melody tone to the default setting for that tune.

To play all tunes in succession

- 1 Press the SONG BANK button and PIANO BANK button at the same time.
 - Playback starts from Song Bank tune number 00, followed in sequence by Piano Bank tunes.
- 2 To stop tune play, press the PLAY/STOP button.

NOTE

- While a tune is playing, you can use the number buttons or [+] and [-] to change to another tune.
- You can play along with the tunes on the keyboard.

Using the PIANO BANK Button

Pressing the PIANO BANK button provides instant access to piano tones and piano tune selection.

Initial Piano Bank Setting

Tone: 000 STEREO GRAND PIANO

To use the piano bank

- 1 Press the PIANO BANK button.

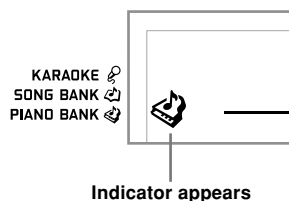

- 2 Now try playing something on the keyboard.
 - The notes you play sound with a piano tone.
- 3 If you want to playback the built-in tune, press the PLAY/STOP button.
 - This causes the currently selected tune to play in an endless loop.
 - To stop playback, press the PLAY/STOP button again.

Using the SMF Data on the Bundled CD-ROM

The CD-ROM that comes bundled with the keyboard contains demos as well as 25 tunes (SMF data) that you can use for step lessons. It also contains PDF format files that contain the sheet music of the included tunes.

For a full list of the tunes that are included, open the “List.txt” file located inside the “MusicDataFolder” on the CD-ROM. For each tune, “List.txt” shows the tune name, SMF file name, PDF file name of the music score, and the type of lesson* for which the tune can be used.

* A tune marked with an asterisk (*) can be used for a both-hand lesson. A tune that is not marked with an asterisk can be used for a right-hand lesson.

NOTE

- You can load SMF data from the CD-ROM to the keyboard using an SD memory card (page E-54) or using the SMF converter tool (page E-49).
- You will need to have Adobe Reader or Acrobat Reader installed on your computer in order to view the contents of a music score PDF file. If neither of these applications is installed on your computer, see “Installing Adobe Reader (Acrobat Reader**)” on page E-48.

Advanced 3-Step Lesson

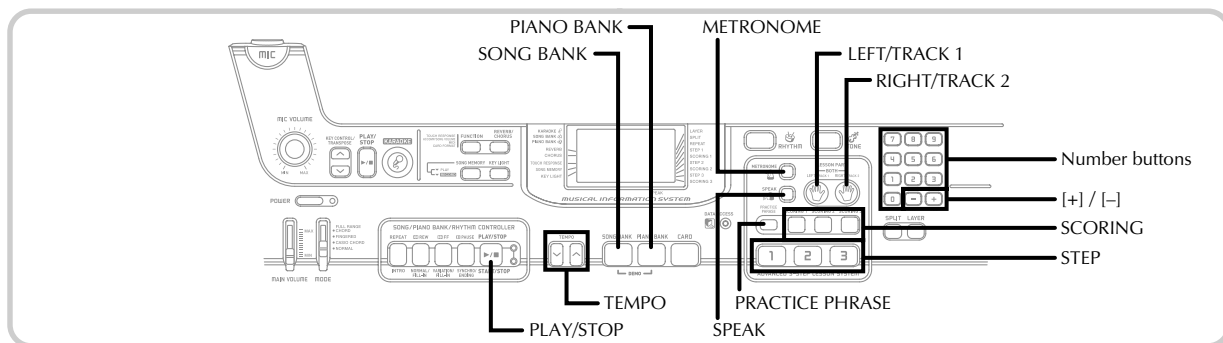

With the 3-Step Lesson System, you can practice built-in tunes and SMF data from a memory card, and even plot your progress according to the evaluation points the keyboard awards you.

* See "Using a Memory Card" on page E-52 for information about using the SMF data from a memory card for playback.

Lesson Progress



3-Step Lesson

The 3-step lesson feature takes you through the three distinct steps described below to help you learn to play tunes on the keyboard.

Step 1 – Master the timing.

In this step, pressing any key on the keyboard plays the correct note, so you can concentrate on getting the timing right without worrying about playing the right note. Accompaniment (left-hand part) waits until you press a key before proceeding to the next phrase.

Step 2 – Master the notes.

In this step, you use the display to learn which fingers you should use and how loud or soft to play, and the key light system to learn which keyboard keys to press. Accompaniment (left-hand part) waits until you play the correct note, so you can learn at your own pace.

Step 3 – Play at normal speed.

This is where you enjoy actually playing the tunes you learn using Step 1 and Step 2. The key light system still shows you which keyboard keys to press, but accompaniment proceeds at normal speed regardless of whether or not you play the correct notes.

Lesson Parts

3-Step Lesson lets you practice the right-hand part, left-hand part, or the parts for both hands.

VIDEO OUT Jack

Connect the keyboard to a TV equipped with a video input jack and you can view lesson information on your TV screen.

- See "VIDEO OUT Jack" on page E-16 for information.

Key Lighting System Operation and Display Contents During 3-step Lesson Play

Whenever you select an Auto Accompaniment tune for 3-step lesson play, the key lighting system shows you which keys to press, while the display shows you the notes and their fingerings.

Note Pitch

The keyboard key that should be pressed lights, while the actual pitch of the note appears in the display's staff notation area. The fingers you should use to play the notes are also shown on the display.

Note Length

Keyboard keys stay lit for as long as the note should be played. The staff notation and fingerings also remain on the display for the length of the note.

Next Note

The keyboard key for the next note to be played flashes, while a number appears on the display near the finger you should use to play the next note.

Series of Same Pitch Notes

The keyboard key light turns off momentarily between the notes and lights again for each successive note. The staff notation and fingerings also turn off and back on again.

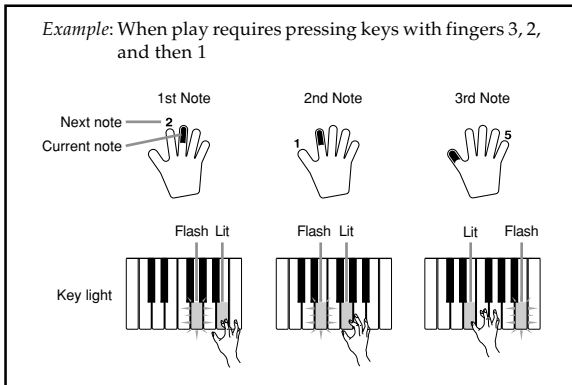

NOTE

- Note length is not indicated when you are using two-hand tunes with 3-step lesson Steps 1 and 2. As soon as you press a lit key, it goes out and the next key to be played starts to flash.
- Note length is indicated by the key light system when you use a two-hand tune with Step 3. In this case, the next key to be pressed does not flash when you press a lit key and the next finger number does not appear on the display. Only the current finger number is shown.

3-step Lesson Tempo Setting

Use the procedure under "Adjusting the Tempo" on page E-20 to adjust the tempo for 3-step lesson play.

Dynamic Marks

The dynamic marks listed below appear on the display while tunes are playing. Adjust the pressure you apply to the keyboard in accordance with the mark that is on the display.

- pp*** pianissimo: Very soft
p piano: Soft
mp mezzo piano: Moderately soft
mf mezzo forte: Moderately loud
f forte: Loud
ff fortissimo: Very loud
cresc. (<) crescendo: Gradually louder
decresc. (>) decrescendo: Gradually softer

Evaluation Mode

The keyboard's Evaluation Mode awards points to your performances during Step 1 and Step 2 of the 3-Step Lesson. A perfect score is 100. Also, the Evaluation Mode provides comments about your play, both on the monitor screen and by means of a simulated human voice.

Evaluation Mode Display

Level Indicator (9 Levels): This indicator shows the evaluation of your current performance at a glance. The more segments that appear, the higher your points.

Example: 50 points



Timing Indicator: In the Evaluation Mode, the configuration of the star changes with each note to let you know how your timing is. The more stars, the better your timing.



Using Tone and Voice Guide

When the keyboard senses that your timing is off, it will let you know by changing the notes you play to a tone that is different from the one you currently have selected. In the Evaluation Mode, a simulated human voice will also tell you your evaluation level. The sound effect keeps you informed of when your evaluation level is about to change.

Expressions

- "Good!"
 "That's close!"
 "Nice try!"
 "Keep trying!"
 "Take your time" : This expression is used if you do not play the correct note for a long time.
- <High>
 ↑ Evaluation Ranges
 ↓ <Low>

Evaluation Results

After you finish playing, the keyboard calculates an evaluation of your total performance, from beginning to end, and displays your total score on the monitor screen. The greater the score, the higher your evaluation is.

Evaluation Rank Display Messages and Sound Effects

Display Message	Sound Effect
"Bravo!"	Applause and cheering
"Great!"	Applause only
"Not bad!"	None
"Again!"	None

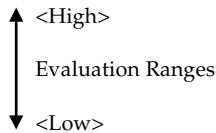

"*****" : indicates that the Evaluation Mode was exited before an evaluation result could be obtained.

NOTE

- If your play is flawless, the message "Perfect!" appears before the evaluation result.
- If you press the PLAY/STOP button and interrupt the Evaluation Mode part way through, the monitor screen shows the evaluation points you have accumulated up to that point. In this case, the keyboard does not display a message and play a sound effect.

Using the Lesson Functions and Evaluation Mode

Perform the following steps to master your favorite tunes.

Step 1 – Master the timing.

- 1 Select the tune you want to use.
- 2 Press the RIGHT/TRACK 2 button or the LEFT/TRACK 1 button to specify the part you want to practice.
 - If you want to practice both hands, press both buttons at the same time.
 - Indicators appear around the hand on the display whose part is selected for practice.

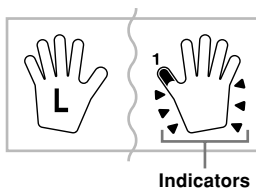

- 3 Press the STEP 1 button to start Step 1 play.
 - After a count sounds, the keyboard stands by and waits for you to play the first note of the tune.
 - Voice fingering guide will use a simulated human voice to call out fingering numbers during one-hand part practice. See "Voice Fingering Guide" on page E-28 for details.

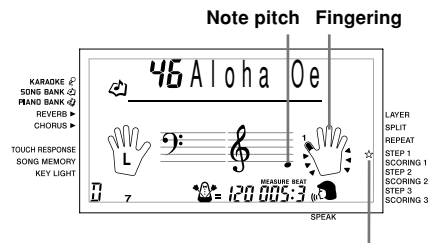

Indicator appears

- 4 Press any keyboard keys to play the notes.

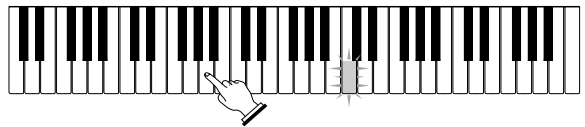

- The key for the next note to be played flashes while the keyboard waits for you to play it. When you press any key to play the note, the key remains lit as the note plays.
- Accompaniment (left-hand part) waits until you press any key to play a note.
- If you accidentally press more than one key in succession, accompaniment is played for the corresponding number of notes.
- Pressing more than one key at the same time counts as a single note. Pressing a key while another key is held down is counted as two notes.

- 5 To stop play at any time, press the PLAY/STOP button.

Evaluation 1: Find out how the keyboard evaluates your Step 1 play.

Use the SCORING 1 button to check the evaluation of your play in Step 1.

- 1 Press the SCORING 1 button.
 - This causes the SCORING 1 indicator to appear on the display.
 - A count beat sounds and then evaluation mode starts.

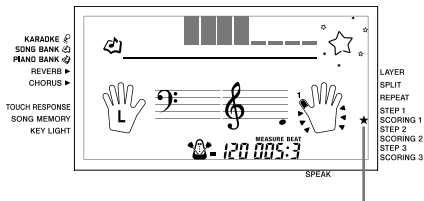

Indicator appears

- 2 Play in accordance with the guidance on the monitor screen and as told by the voice.
 - To stop evaluation, press the PLAY/STOP button. This displays only the points accumulated up to that point.
- 3 After you finished playing, your evaluation result appears on the display.
 - For information about evaluation ranks and sound effects, see "Evaluation Results" on page E-25.
 - The keyboard will tell you where you scored the lowest during your performance, so you can find out where you need the most work. See "Using the Phrase Practice Mode" on page E-27 for more information.
 - Pressing the SONG BANK button or PIANO BANK button returns to the tune selection screen.

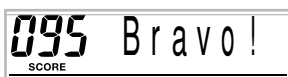

Step 2 – Master the notes.

- 1 Select the tune you want to use.
- 2 Press the RIGHT/TRACK 2 button or the LEFT/TRACK 1 button to specify the part you want to practice.
 - If you want to practice both hands, press both buttons at the same time.

- 3 Press the STEP 2 button to start Step 2 play.
 - After a count sounds, the keyboard stands by and waits for you to play the first note of the tune.
 - Voice fingering guide will use a simulated human voice to call out fingering numbers during one-hand part practice. See "Voice Fingering Guide" on page E-28 for details.

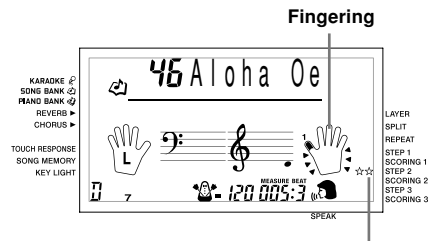

Indicator appears

- 4 Follow the key light system to press the correct keyboard keys and play the notes.

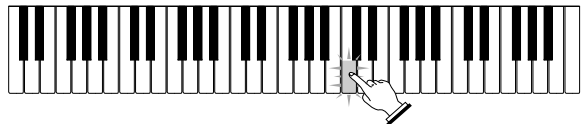

- The key for the next note to be played flashes while the keyboard waits for you to play it. When you press any key to play the note, the key remains lit as the note plays.
- If multiple keys light on the on-screen keyboard guide when you are using a two-hand tune, it means that you must press all of the keys that are lit.

- 5 To stop play at any time, press the PLAY/STOP button.

Evaluation 2: Find out how the keyboard evaluates your Step 2 play.

- 1 Press the SCORING 2 button.
 - This causes the SCORING 2 indicator to appear on the display.
 - A count beat sounds and then evaluation mode starts.

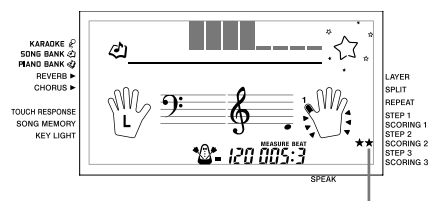

Indicator appears

- * The remainder of this procedure is identical to that for Evaluation 1.

Step 3 – Play at normal speed.

- 1 Select the tune you want to play.
- 2 Press the RIGHT/TRACK 2 button or the LEFT/TRACK 1 button to specify the part you want to practice.
 - If you want to practice both hands, press both buttons at the same time.
- 3 Press the STEP 3 button to start Step 3 play.
 - Accompaniment (left hand part) starts to play at normal speed.

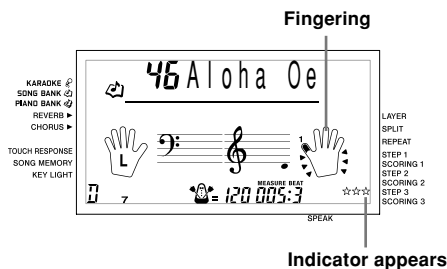

- 4 Follow the key light system to press the correct keyboard keys and play the notes.

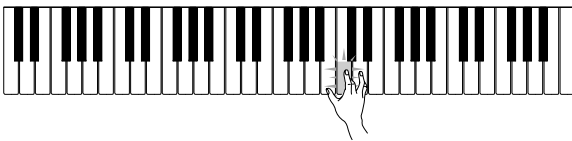

- 5 To stop play at any time, press the PLAY/STOP button.

Evaluation 3: Find out how the keyboard evaluates your Step 3 play.

- 1 Press the SCORING 3 button.
 - This causes the SCORING 3 indicator to appear on the display.
 - After the keyboard sounds a count, it enters the Evaluation Mode.
 - * The remainder of this procedure is identical to that for Evaluation 1.

Using the Phrase Practice Mode

Perform the following procedure to find out where you scored the lowest in your performance, so you can find your weak points and focus your practice on those phrases.

- 1 After displaying your evaluation results, press the PRACTICE PHRASE button.



- This displays the Phrase Practice Mode screen, which shows the phrase (start measure number and end measure number) where your evaluation mode was the lowest. This is the "practice phrase".

NOTE

- If there are multiple phrases that qualify as the lowest score, the phrase closest to the beginning of the tune is used for phrase practice.
- If there is no section that qualifies for phrase practice, "***-***" is displayed in place of the start and end measures.
- Phrase practice measures are cleared if you change to another tune or another mode.

To play back the practice phrase

- 1 While the Phrase Practice Mode screen is on the display, press the PLAY/STOP button.
 - This plays back the phrase starting from the start measure number.
 - Playback continually loops from the beginning of the practice phrase to its end.
 - To stop practice phrase playback, press the PLAY/STOP button again.

NOTE

- With some tunes, it may take a few seconds for playback to start after you press the PLAY/STOP button in the above procedure.

To practice the practice phrase

- 1 While the Phrase Practice Mode screen is on the display, press the STEP 1, STEP 2, or STEP 3 button.
 - This starts 3-Step Lesson playback of the practice phrase in accordance with the STEP button you pressed.
- 2 Play along on the keyboard.
 - Playback continually loops from the beginning of the practice phrase to its end.
 - To stop playback, press the PLAY/STOP button.

Voice Fingering Guide

Voice fingering guide uses a simulated human voice to call out fingering numbers during Step 1 and Step 2 one-hand part practice. If you need to press a key with your thumb, for example, voice fingering guide says, "One!" In the case of a chord to be played with your thumb, middle and little finger, voice fingering guide says, "One, three, five!"

Voice Fingering Guide calls out fingerings only when you do not press the proper key when you should.

Voice Fingering Guide

- One : Thumb
- Two : Forefinger
- Three : Middle finger
- Four : Ring finger
- Five : Little finger

To turn voice fingering guide on or off

Press the SPEAK button to toggle voice fingering guide on (voice fingering guide indicator displayed) and off (indicator not displayed).



NOTE

- Note that Voice Fingering is disabled in the Evaluation Mode. Pressing the SCORING 1 or SCORING 2 button automatically turns off Voice Fingering.
- Exiting the Evaluation Mode automatically restores the Voice Fingering setting that was in effect when you entered the Evaluation Mode.

Using the Metronome

The metronome feature of this keyboard produces a bell sound for the first beat of each measure, followed by click sounds for each successive beat of the measure. It is the perfect tool for practicing tunes without accompaniment (rhythm).

To start the metronome

- 1 Press the METRONOME button to start sounding the metronome.
 - This causes "Beat" to appear on the display. Perform step 2 within five seconds after "Beat" appears.



- 2 Use the number buttons or [+] and [-] to change the number of beats per measure.
 - You can specify 0, or a value from 2 to 6 as the number of beats per measure.

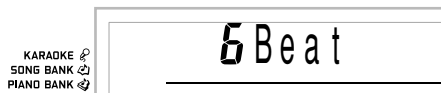

NOTE

- The bell (indicating the first beat of a measure) does not sound while one beat per measure is specified. All beats are indicated by a click sound. This setting lets you practice with a steady beat, without worrying about how many beats there are in each measure.

- 3 Use the TEMPO buttons to set the tempo.
 - Press ^ to increase the tempo (make it faster) or v to decrease it (make it slower).

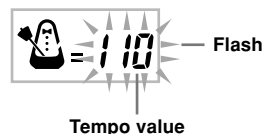

NOTE

- While the tempo value is flashing, you can also use the number buttons or [+] and [-] to input a three-digit value. Note that you must input leading zeros, so 90 is input as 090.
- Pressing both the ^ and v TEMPO buttons at the same time automatically returns the currently selected rhythm or tune to its default tempo.

- 4 To turn off the metronome, press the METRONOME button.

Using a Microphone for Karaoke

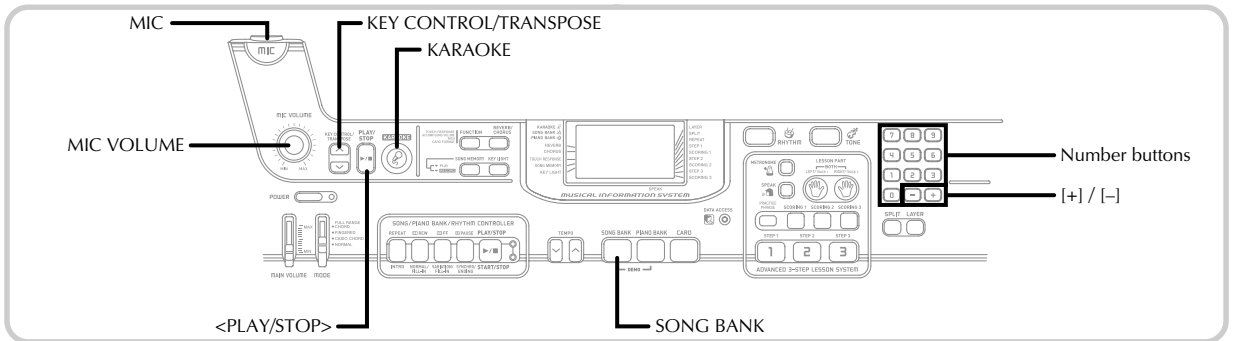

You can select any of the 50 Song Bank/Karaoke Group tunes or SMF data from a memory card, and sing along with its accompaniment.

Using the microphone jack

Connecting a commercially available microphone to the MIC jack makes it possible to sing along with the keyboard's built-in tunes or with SMF playback. When connecting a microphone, be sure to first adjust the MIC VOLUME to a relatively low setting, and then adjust to the level you want after connecting.

- 1 Set the MIC VOLUME knob setting so it is on the "MIN" side.
- 2 Turn on the microphone's on/off switch.
- 3 Use the MIC VOLUME knob to adjust microphone volume to the level you want.

[Rear Panel]

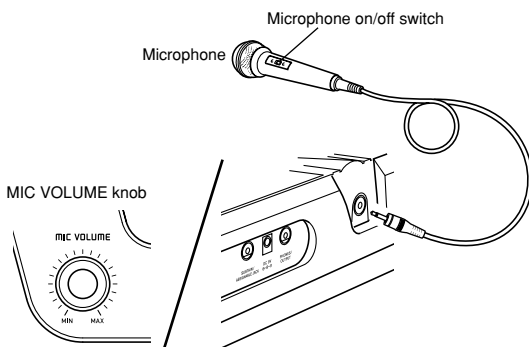

IMPORTANT!

- Be sure to use the microphone's on/off switch to turn off the microphone and to disconnect the microphone from the keyboard whenever you are not using it.

Recommended Microphone Type

- Dynamic microphone (standard plug)

IMPORTANT!

- Be sure to disconnect the microphone from the keyboard whenever you are not using it.

Howling (Feedback Noise)

Any of the following conditions can cause howling (feedback noise).

- Covering the head of the microphone with your hand
- Positioning the microphone too near to a speaker

Should howling occur, try grasping the microphone further away from the head, and move away from any nearby speaker.

Static Noise

Fluorescent lighting can cause static noise in the microphone signal. When this happens, move away from the lighting you suspect may be causing the static.

To use a microphone for Karaoke

PREPARATION

- Adjust the main volume (page E-17), accompaniment/song volume (page E-46), and microphone volume (page E-29).

- 1 Press the KARAOKE button until the KARAOKE indicator appears and enter the Karaoke Mode.

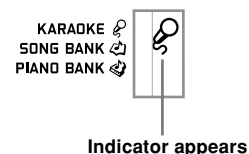

- 2 Select the karaoke source.

■ Song Bank

Press the SONG BANK button. This enters the Karaoke Song Bank Mode, and displays the Song Bank indicator.

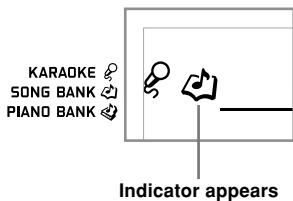

■ Card Bank

See "Reading a Memory Card" on page E-54 for information about using song data on a memory card.

- 3 Find the tune you want in the SONG BANK/KARAOKE List, and note its number.
- See page A-9 for the SONG BANK/KARAOKE List.

- 4 Use the number buttons to input the two-digit song number.
- Example:* To select "ALOHAOE", which is song number 46, input 4 and then 6.

NOTE

- The initial power on default tune setting is "00".
- You can also specify the song number using the [+] and [-] buttons.

- 5 Press the <PLAY/STOP> button to start tune play.



■ When the keyboard is connected to a TV

When you select a tune that includes lyric data, the lyrics appear on the TV screen. In this case, the keyboard's screen continues to show the song title, without changing.

- Now use the microphone to sing along with the playback.
- The Karaoke Mode is similar to the Song Bank Mode. The only difference is that the melody part in the Karaoke Mode is played back at a lower volume. Also a different tone setting is used in the Karaoke mode to make sing along easier.

- 6 Use the KEY CONTROL/TRANPOSE buttons (\wedge / \vee) to change the overall key of the playback, if you want.

- \wedge : Raises the key by one semitone
- \vee : Lowers the key by one semitone

- 7 Press the <PLAY/STOP> button to stop tune play.
- The same song plays in an endless loop until you stop it.

NOTE

- To return a tune to its default key, press both of the KEY CONTROL/TRANPOSE buttons (\wedge and \vee) at the same time.

Displaying Song Lyrics on a TV Screen

When you select and start playback of a song that includes lyric data while the keyboard is connected to a TV, a Karaoke screen showing the song lyrics will appear on the TV. You can also specify the type of alphabet that should be used for TV screen display (Russian Cyrillic or Latin). For details, see "Selecting the Alphabet Type for TV Screen Display" on page E-47.

- A microphone icon is displayed next to the song numbers on the TV screen SONG BANK/KARAOKE List that include lyric data.
- The lyrics that correspond to the accompaniment that is currently playing change color on the screen.
- Lyrics that appear on the TV screen may not perfectly match those of the original tune, so they can be matched to the built-in tune.

NOTE

- The display limit is 25 characters per line on the screen of a TV connected to the keyboard. Anything past the 25th character is not displayed.

Auto Accompaniment

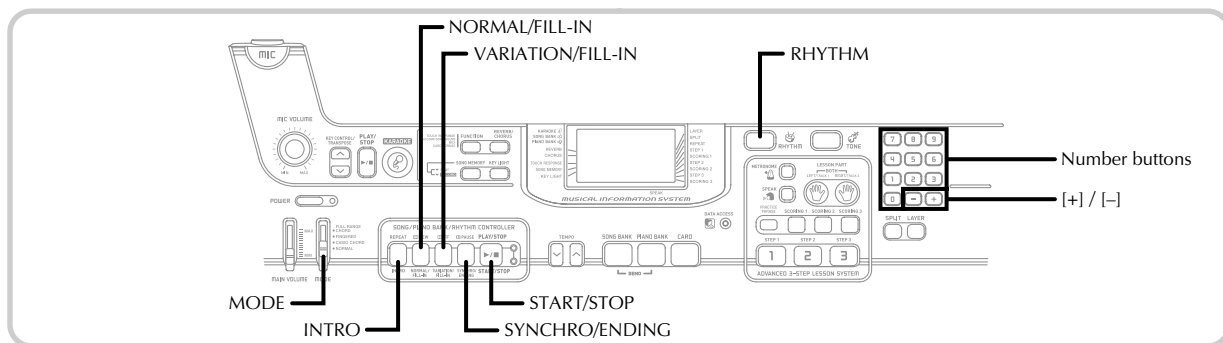

This keyboard automatically plays bass and chord parts in accordance with the chords you finger. The bass and chord parts are played using sounds and tones that are automatically selected to select the rhythm you are using. All of this means that you get full, realistic accompaniments for the melody notes you play with your right hand, creating the mood of an one-person ensemble.

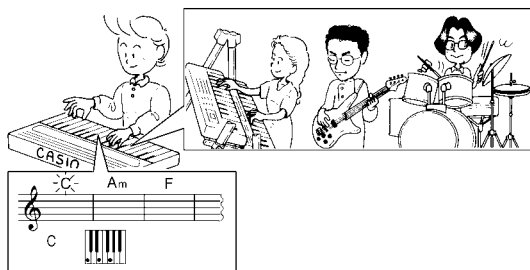

Selecting a Rhythm

This keyboard provides you with 120 exciting rhythms that you can select using the following procedure.

To select a rhythm

- 1 Find the rhythm you want to use in the RHYTHM List and note its rhythm number.
 - Not all of the available rhythms are shown on the rhythm list printed on the keyboard console. For a complete list, see the "Rhythm List" on page A-8.
- 2 Press the RHYTHM button.
- 3 Use the number buttons to input the three digit rhythm number for the rhythm you want to select.

Example: To select "075 RHUMBA", input 0, 7 and then 5.



NOTE

- You can also increment the displayed rhythm number by pressing [+], and decrement it by pressing [-].
- Some rhythms consist of chord accompaniments only, without any drums or other percussion instruments. Such rhythms do not sound unless CASIO CHORD, FINGERED, or FULL RANGE CHORD is selected as the accompaniment mode.

Playing a Rhythm

Use the following procedure to start and stop rhythm play.

To play a rhythm

- 1 Set the MODE switch to NORMAL.
- 2 Press the START/STOP button to start play of the currently selected rhythm.
- 3 To stop rhythm play, press the START/STOP button again.

NOTE

- All of the keyboard keys are melody keys while the MODE switch is set to NORMAL.

Using Auto Accompaniment

The following procedure describes how to use the keyboard's Auto Accompaniment feature. Before starting, you should first select the rhythm you want to use and set the tempo of the rhythm to the value you want.

To use Auto Accompaniment

- 1 Set the MODE switch to CASIO CHORD, FINGERED, or FULL RANGE CHORD.
- 2 Press the START/STOP button to start play of the currently selected rhythm.
- 3 Play a chord.
 - The actual procedure you should use to play a chord depends on the current MODE switch position. Refer to the following pages for details on chord play.

CASIO CHORD Page E-32
 FINGERED Page E-33
 FULL RANGE CHORD Page E-34

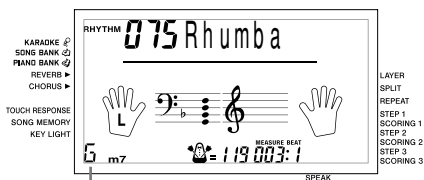

Chord name

- 4 To stop Auto Accompaniment play, press the START/STOP button again.

NOTE

- If you press the SYNCHRO/ENDING button and then the INTRO button in place of the START/STOP button in step 2, accompaniment will start with an intro pattern when you perform the operation in step 3. For details about these buttons, see pages E-35 and E-36.
- If you press the SYNCHRO/ENDING button in place of the START/STOP button in step 4, an ending pattern will play before accompaniment play is ended. For details about this button, see page E-36.
- You can adjust the accompaniment part volume level independently of the main volume. For details, see "Adjusting Accompaniment and Song Bank Volume" on page E-46.

CASIO CHORD

This method of chord play makes it possible for anyone to easily play chords, regardless of previous musical knowledge and experience. The following describes the CASIO CHORD "Accompaniment keyboard" and "Melody keyboard", and tells you how to play CASIO CHORDs.

CASIO CHORD Accompaniment Keyboard and Melody Keyboard

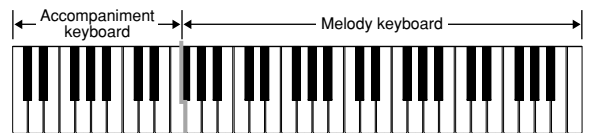

NOTE

- The accompaniment keyboard can be used for playing chords only. No sound will be produced if you try playing single melody notes on the accompaniment keyboard.
- The split point (page E-44) is the point that separates the Auto Accompaniment area and the melody area of the keyboard. You can change the location of the split point, which also changes the sizes of the keyboard areas.

Chord Types

CASIO CHORD accompaniment lets you play four types of chords with minimal fingering.

Chord Types	Example
<p>Major chords Major chord names are marked above the keys of the accompaniment keyboard. Note that the chord produced when you press an accompaniment keyboard does not change octave, regardless of which key you use to play it.</p>	<p>C Major (C)</p>
<p>Minor chords (m) To play a minor chord, keep the major chord key depressed and press any other accompaniment keyboard key located to the right of the major chord key.</p>	<p>C minor (Cm)</p>
<p>Seventh chords (7) To play a seventh chord, keep the major chord key depressed and press any other two accompaniment keyboard keys located to the right of the major chord key.</p>	<p>C seventh (C7)</p>
<p>Minor seventh chords (m7) To play a minor seventh chord, keep the major chord key depressed and press any other three accompaniment keyboard keys located to the right of the major chord key.</p>	<p>C minor seventh (Cm7)</p>

NOTE

- It makes no difference whether you press black or white keys to the right of a major chord key when playing minor and seventh chords.

FINGERED

FINGERED provides you with a total of 15 different chord types. The following describes the FINGERED "Accompaniment keyboard" and "Melody keyboard", and tells you how to play a C-root chord using FINGERED.

FINGERED Accompaniment Keyboard and Melody Keyboard

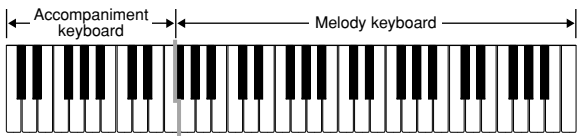

NOTE

- The accompaniment keyboard can be used for playing chords only. No sound will be produced if you try playing single melody notes on the accompaniment keyboard.
- The split point (page E-44) is the point that separates the Auto Accompaniment area and the melody area of the keyboard. You can change the location of the split point, which also changes the sizes of the keyboard areas.

See the FINGERED Chord Chart on page A-7 for details on playing chords with other roots.

- *1: Inverted fingerings cannot be used. The lowest note is the root.
- *2: The same chord can be played without pressing the 5th G.

NOTE

- Except for the chords specified in note*1 above, inverted fingerings (i.e. playing E-G-C or G-C-E instead of C-E-G) will produce the same chords as the standard fingering.
- Except for the exception specified in note*2 above, all of the keys that make up a chord must be pressed. Failure to press even a single key will not play the desired FINGERED chord.

FULL RANGE CHORD

This accompaniment method provides a total of 38 different chord types: the 15 chord types available with FINGERED plus 23 additional types. The keyboard interprets any input of three or more keys that matches a FULL RANGE CHORD pattern to be a chord. Any other input (that is not a FULL RANGE CHORD pattern) is interpreted as melody play. Because of this, there is no need for a separate accompaniment keyboard, so the entire keyboard, from end to end, can be used for both melody and chords.

FULL RANGE CHORD Accompaniment Keyboard and Melody Keyboard

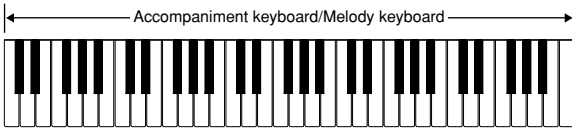

< Chords Recognized by This Keyboard >

Chord Types	Number of Types
Corresponding FINGERED Chord	15 (page E-33)
Other Chords	<p>23</p> <p>The following are examples of chords that use C as the bass note.</p> <p>C₆ • Cm₆ • C₆₉</p> <p>$\frac{C^{\sharp}}{C}$ • $\frac{D}{C}$ • $\frac{E}{C}$ • $\frac{F}{C}$ • $\frac{G}{C}$ • $\frac{A^{\flat}}{C}$ • $\frac{B^{\flat}}{C}$</p> <p>$\frac{B}{C}$ • $\frac{C^{\sharp}m}{C}$ • $\frac{Dm}{C}$ • $\frac{Fm}{C}$ • $\frac{Gm}{C}$ • $\frac{Am}{C}$ • $\frac{B^{\flat}m}{C}$</p> <p>$\frac{Ddim}{C}$ • $\frac{A^{\flat}7}{C}$ • $\frac{F7}{C}$ • $\frac{Fm7}{C}$ • $\frac{Gm7}{C}$ • $\frac{A^{\flat}add9}{C}$</p>

Example: To play the chord C major.

Any of the fingerings shown in the illustration below will produce C major.

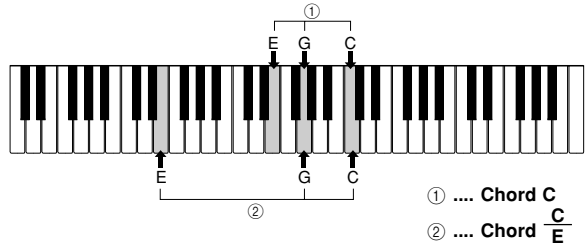

NOTE

- As with the FINGERED mode (page E-33), you can play the notes that form a chord in any combination (①).
- When the composite notes of a chord are separated by 6 or more notes, the lowest sound becomes the bass (②).

< Music Example >

Tone: Organ type
Rhythm: Ballad type
Tempo: 070

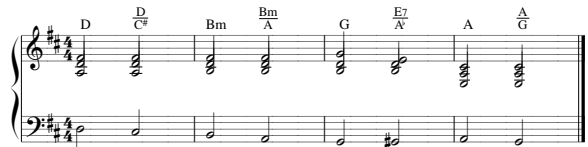



Using an Intro Pattern

This keyboard lets you insert a short intro into a rhythm pattern to make startup smoother and more natural.

The following procedure describes how to use the Intro feature. Before starting, you should first select the rhythm you want to use, and set the tempo.

To insert an intro

- 1 Press the INTRO button to start the selected rhythm with an intro pattern.
 - With the above setup, the intro pattern is played and the auto accompaniment with intro pattern starts as soon as you play chords on the accompaniment keyboard.

NOTE

- The standard rhythm pattern starts to play after the intro pattern is complete.
- Pressing the VARIATION/FILL-IN button while an intro pattern is playing causes the variation pattern to sound after the intro pattern is complete.

Using a Fill-in Pattern

Fill-in patterns let you momentarily change the rhythm pattern to add some interesting variation to your performances.

The following procedure describes how to use the Fill-in feature.

To insert a fill-in

- 1 Press the START/STOP button to start rhythm play.
- 2 Press the NORMAL/FILL-IN button to insert a fill-in pattern for the rhythm you are using.

NOTE

- The fill-in pattern does not play if you press the NORMAL/FILL-IN button while an intro pattern is playing.

Using a Rhythm Variation

In addition to the standard rhythm pattern, you can also switch to a secondary “variation” rhythm pattern for a bit of variety.

To insert the variation rhythm pattern

- 1 Press the START/STOP button to start rhythm play.
- 2 Press the VARIATION/FILL-IN button to switch to the variation pattern for the rhythm you are using.

NOTE

- To switch back to the standard rhythm pattern, press the NORMAL/FILL-IN button.

Using a Fill-in Pattern with a Variation Rhythm

You can also insert a fill-in pattern while a variation rhythm pattern is playing.

To insert a fill-in into a rhythm variation

- 1 While a variation rhythm pattern is playing, press the VARIATION/FILL-IN button to insert a fill-in pattern for the variation rhythm you are using.

Synchro Starting Accompaniment with Rhythm Play

You can set up the keyboard to start rhythm play at the same time you play the accompaniment on the keyboard.

The following procedure describes how to use synchro start. Before starting, you should first select the rhythm you want to use, set the tempo, and use the MODE switch to select the chord play method you want to use (NORMAL, CASIO CHORD, FINGERED, FULL RANGE CHORD).

To use synchro start

- 1 Press the SYNCHRO/ENDING button to put the keyboard into synchro start standby.



Flash

- 2 Playing a chord and the rhythm pattern starts to play automatically.

NOTE

- If the MODE switch is set to NORMAL, only the rhythm plays (without a chord) when you play on the accompaniment keyboard.
- If you press the INTRO button before playing anything on the keyboard, the rhythm starts automatically with an intro pattern when you play something on the accompaniment keyboard.
- Pressing the VARIATION/FILL-IN button before playing anything on the keyboard causes play to start with the variation pattern when something is played on the keyboard.
- To cancel synchro start standby, press the SYNCHRO/ENDING button one more time.

Finishing with an Ending Pattern

You can end your performances with an ending pattern that brings the rhythm pattern you are using to a natural-sounding conclusion.

The following procedure describes how to insert an ending pattern. Note that the actual ending pattern played depends on the rhythm pattern you are using.

To finish with an ending pattern

- 1 While the rhythm is playing, press the SYNCHRO/ENDING button.
 - This causes the ending pattern to play, which brings rhythm accompaniment to an end.

NOTE

- The timing when the ending pattern starts depends on when you press the SYNCHRO/ENDING button. If you press the button before the second beat of the current measure, the ending pattern starts playing immediately. Pressing the button at any point in the measure after the second beat results in the ending pattern playing from the beginning of the following measure.

Song Memory Function

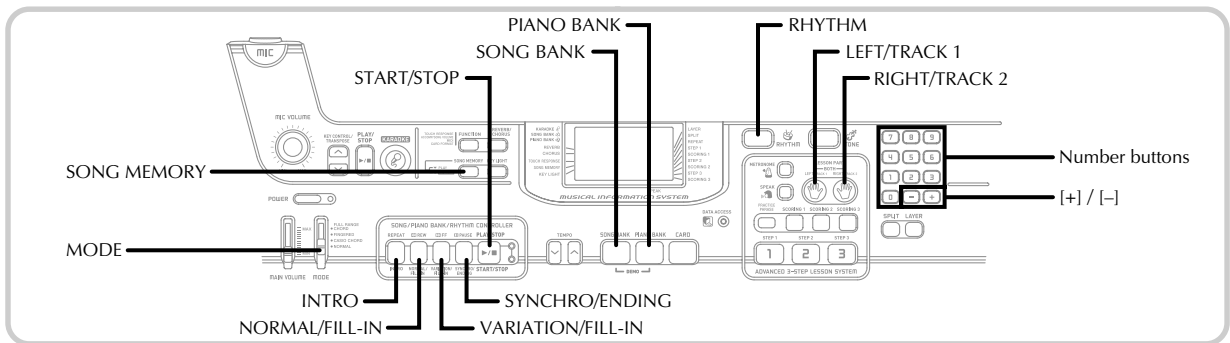

You can use Song Memory to record your lesson play (lesson recording) and to record your keyboard play along with the Auto Accompaniment you are using (performance recording).

Parts and Tracks

How data is recorded to Song Memory and the type of data that is recorded depends on whether you are performing a performance recording operation or a lesson recording operation.

Lesson Recording

With lesson recording, you use the LEFT/TRACK 1 button and the RIGHT/TRACK 2 button to select recording of only the left-hand part, only the right-hand part, or both the left-hand and right-hand parts.

Performance Recording

With performance recording, Song Memory operates like a tape recorder or sequencer. In this case, you can use the LEFT/TRACK 1 button and the RIGHT/TRACK 2 button to select the Song Memory track you want to record to. Performance recording records the data shown in the illustration below, using two memory tracks.

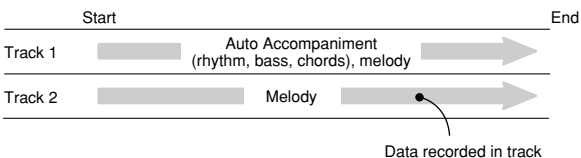

- Since each track is independent of the other, you can edit a recording by re-recording only one of the tracks.

Using the SONG MEMORY Button

When performing a performance recording or lesson recording, you will need to use the SONG MEMORY button to select recording or playback. Each press of the SONG MEMORY button cycles through the song memory options in the sequence shown below.

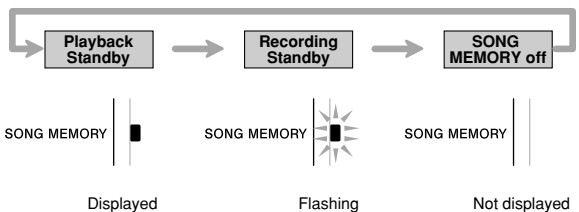

Song Memory Capacity

Song Memory can hold a total of approximately 5,200 notes, which can be divided between a lesson recording and a performance recording. Note that you can use up all 5,200 notes for either the lesson recording or the performance recording. If you do, you will not be able to record anything for the other type of recording.

- When the number of remaining notes becomes less than about 100 while you are recording, the SONG MEMORY indicator and the track/part indicator (L, R) will start to flash at high speed.
- Recording will stop automatically if Song Memory becomes full.

If you are using Auto Accompaniment or a rhythm, they will also stop playing at this time.

Recorded Data Storage

- Anything previously stored in song memory is replaced whenever you make a new recording.
- Song Memory contents are retained even when power is turned off, as long as the keyboard is being supplied battery or AC adaptor power. If you remove the batteries or should the batteries go dead while the keyboard is not being supplied power by the AC adaptor, song memory contents will be deleted. Be sure to supply power to the keyboard with the AC adaptor when replacing batteries.
- Turning off the keyboard while a record operation is in progress causes the contents of the track you are currently recording to be lost.

Recording Play Along with a Built-in Tune

You can use the lesson recording procedure to record notes you play along with one of the keyboard's built-in tunes. When you start a lesson recording, the keyboard plays the song minus the part(s) you selected as the recording part(s), and indicates the notes you need to play by lighting the keys of the keyboard.

Selecting Parts

Press the part/track button that corresponds to the part(s) you want to select as the recording part(s).

To select this part:	Press this button:
Left-hand	LEFT/TRACK 1
Right-hand	RIGHT/TRACK 2
Both hands	LEFT/TRACK 1 + RIGHT/TRACK 2

The part that is currently selected is indicated by the part/track indicators (L and R) that appear on the display as described below.

Part/Track Indicators in Playback Standby

Each press of a part/track button toggles playback of that part on (part/track indicator displayed) and off (indicator not displayed).

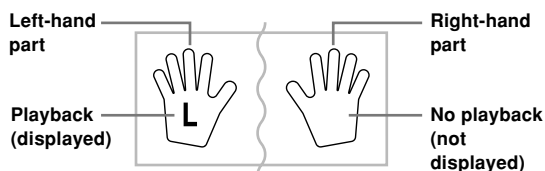

Example: The above indicates that left-hand part will be played back, while the right-hand part will not.



To record as you play along with a built-in tune

- 1 Press the SONG BANK button or PIANO BANK button to select the mode that includes the tune you want to play along with.
- 2 Use the SONG MEMORY button to select record standby.
 - This causes the SONG MEMORY indicator to flash on the display.
- 3 Select the tune you want to play along with.
 - See “To play back a Song Bank tune” on page E-19 for information about selecting Song Bank tunes, and “To play back a Piano Bank tune” on page E-20 for information about selecting Piano Bank tunes.
- 4 Use the LEFT/TRACK 1 button or RIGHT/TRACK 2 button to select the part(s) (left-hand, right-hand) you want to mute in the built-in tune playback and play along on the keyboard.
 - If you want to mute and play both parts, press both buttons at the same time.
- 5 Configure the following settings as required.
 - Tone (page E-17)
 - Tempo (page E-20)
- 6 Press the controller block START/STOP button.
 - This starts recording.
- 7 Play the notes for the part(s) you selected in step 4 on the keyboard.
- 8 To stop recording, press the controller block START/STOP button again.
 - If you want to hear what you recorded immediately, press the controller block START/STOP button again.

NOTE

- You cannot record a lesson when the lesson song is SMF data on a memory card.

Lesson Recording Data

In addition to the notes you play on the keyboard and the accompaniment of the built-in song you selected, the following data is also stored by a lesson recording operation.

- Tone setting
- Tempo setting
- Tune name
- Recording part selection
- Pedal operations
- Layer and split settings, and their tone settings
- Effect setting

Playing Back a Lesson Recording

- 1 Press the SONG BANK button or the PIANO BANK button to select the bank of the built-in tune that you originally used to record the lesson recording.
- 2 Use the SONG MEMORY button to select playback standby.
- 3 Press the controller block START/STOP button.
 - This starts playback of Song Memory lesson recording contents.
 - You can adjust the tempo at this point, if you want.
- 4 To stop playback, press the controller block START/STOP button again.

Recording a Performance

Use this procedure when you want to record what you play on the keyboard in real time. Performance recording records both the notes you play and any accompaniment patterns that you use.

Selecting a Track

Press the part/track button that corresponds to the track you want to select.

To select this track:	Press this button:
Track 1	LEFT/TRACK 1
Track 2	RIGHT/TRACK 2

The track that is currently selected is indicated by the part/track indicator (L or R) that appears on the display as described below.

Part/Track Indicators in Playback Standby

Each press of a part/track button toggles playback of that track on (part/track indicator displayed) and off (indicator not displayed).

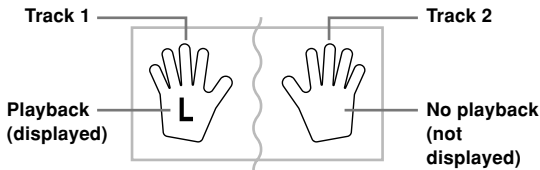

Example: The above indicates that Track 1 will be played back, while Track 2 will not.

Part/Track Indicators in Recording Standby

The part/track indicator will be displayed if its track already contains data.

Press the part/track button of the track to which you want to record (record track). This causes its part/track indicator to flash. The part/track indicator of the other track will remain displayed (without flashing) to indicate that it will playback during recording (playback track).

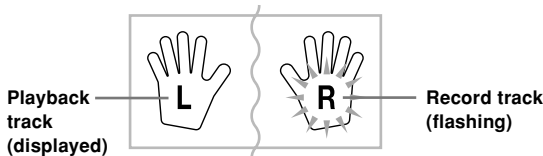

Example: The above indicates Track 1 is the playback track, and Track 2 is the record track.

To record your keyboard performances

IMPORTANT!

- Recording to a track that already contains data causes the existing data to be replaced by your new performance.

- Press the RHYTHM button to enter the rhythm mode.
- Use the SONG MEMORY button to select record standby.
 - This causes the SONG MEMORY indicator to flash on the display.
- Press the LEFT/TRACK 1 button to select Track 1.
 - This causes the L indicator to flash, indicating that Track 1 is the recording track.

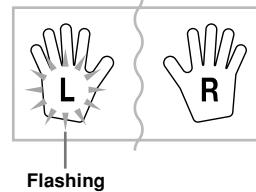

- Configure the following settings as required.
 - Tone (page E-17)
 - Rhythm (page E-31)
 - MODE switch setting (page E-32)
 - Use a slower tempo if you feel you might have trouble playing properly at a faster tempo (page E-20).
- Press the controller block START/STOP button.
 - This starts recording.
- Play the notes you want on the keyboard.
 - Besides notes, any chords you play on the keyboard are recorded, along with their Auto Accompaniment patterns. Melody notes you play are also recorded.
 - Any pedal operations you perform while playing are also recorded.
- To stop recording, press the controller block START/STOP button again.
 - If you make a mistake, you need to go back and re-record from step 2.
 - If you want to immediately hear what you recorded, press the controller block START/STOP button again.

Track 1 Data

In addition to notes played on the keyboard and chord accompaniments, the following data is also stored in Track 1 during performance recording.

- Tone number
- Rhythm number
- INTRO button, SYNCHRO/ENDING button, NORMAL/FILL-IN button, VARIATION/FILL-IN button operations
- Pedal operations
- Layer and split settings, and their tone settings
- Split point
- Tempo setting
- Effect setting

Track 1 Recording Variations

■ To record without rhythm

Skip step 5 of the above procedure.

- Recording without rhythm starts as soon as you press a keyboard key.

■ To start recording with synchro start

In place of step 5 of the above procedure, press the SYNCHRO/ENDING button.

- Now Auto Accompaniment and recording will start when you play a chord within the accompaniment keyboard range.

■ To insert an intro, ending, or fill-in into a recording

During recording, press the INTRO button, SYNCHRO/ENDING button, NORMAL/FILL-IN button, or VARIATION/FILL-IN button as required.

■ To start recording with an intro using synchro start

In place of step 5 of the above procedure, press the SYNCHRO/ENDING button and then the INTRO button.

- Now Auto Accompaniment and recording will start with an intro pattern when you play a chord within the accompaniment keyboard range.

■ To start Auto Accompaniment part way into a recording

In place of step 5 of the above procedure, press the SYNCHRO/ENDING button, and play something within the melody range of the keyboard.

- This records the melody without any accompaniment. Auto Accompaniment will start when you play a chord within the accompaniment keyboard range.

Playing Back a Performance Recording

Perform the following procedure when you want to play back a tune you recorded with performance recording.

- 1 Press the RHYTHM button to enter the rhythm mode.
- 2 Use the SONG MEMORY button to select playback standby.
- 3 Press the controller block START/STOP button.
 - This starts playback of Song Memory performance recording contents. During playback, you can press the LEFT/TRACK 1 or RIGHT/TRACK 2 button to mute either track and listen to the contents of the other track only.
 - You can adjust the tempo at this point, if you want.
- 4 To stop playback, press the controller block START/STOP button again.

NOTE

- During performance recording playback, the entire range of the keyboard operates as a melody keyboard, regardless of the MODE switch setting. You can play along with performance recording playback, if you want. You could use layer and split (page E-43 through E-45) at this time to assign multiple tones to the keyboard.
- Note that pause, skip forward, and skip back operations cannot be performed during performance recording playback.

Overdubbing a Performance Recording

You can use the following procedure to record a melody in Track 2 so it combines with a recording you previously made in Track 1.

- 1 Press the RHYTHM button to enter the rhythm mode.
- 2 Use the SONG MEMORY button to select record standby.
- 3 Press the RIGHT/TRACK 2 button to select Track 2 as the recording track.

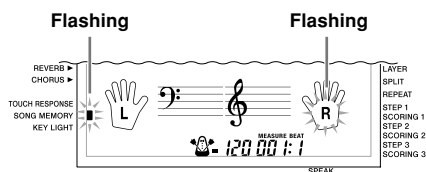

- 4 Select the tone you want to use.
- 5 Press the controller block START/STOP button.
 - This starts playback of Track 1 and recording in Track 2.
- 6 Play the melody notes you want as you listen to the playback from Track 1.
- 7 To stop recording, press the controller block START/STOP button again.
 - If you make a mistake, you need to go back and re-record from step 2.
 - If you want to immediately hear what you recorded, press the controller block START/STOP button again.

NOTE

- Track 2 is a melody-only track, which means that chord accompaniment cannot be recorded there. Because of this, the entire range of the keyboard becomes a melody keyboard when recording the Track 2, regardless of the current MODE switch setting.
- If you want to record without playback from a recorded track, enter playback standby, deselect the playback track, and then enter record standby. Note, however, that you cannot turn off rhythm and Auto Accompaniment.

Track 2 Data

In addition to notes played on the keyboard, the following data is also recorded to Track 2.

- Tone number
- Pedal operations

Deleting a Specific Part/Track

You can use the following procedure to delete a specific part/track from a lesson recording or performance recording.

Getting Ready

■ When deleting a lesson recording part

- Press the SONG BANK button or PIANO BANK button.

■ When deleting a performance recording track

- Press the RHYTHM button.

- 1 Press the SONG MEMORY button to enter record standby.
- 2 Select the part/track you want to delete by pressing the LEFT/TRACK 1 button or RIGHT/TRACK 2 button.
- 3 Hold down the SONG MEMORY button.
 - This causes a confirmation message to appear on the display.
 - To cancel the delete operation, press the [-] (NO) button.
- 4 Press the [+] (YES) button to delete the part/track.
 - This causes the keyboard to return to Song Memory playback standby.

NOTE

- Pressing the SONG MEMORY button while the part/track delete screen is on the display returns to record standby.

Keyboard Settings

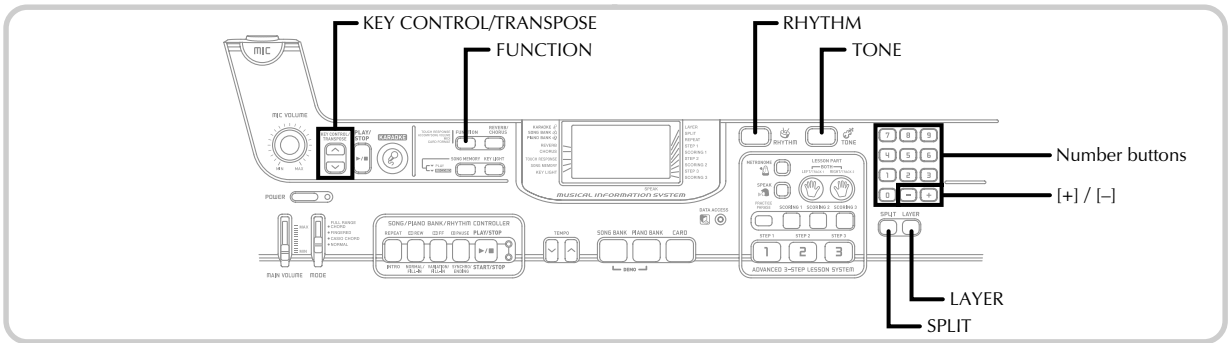

This section describes how to use layer (to play two tones with a single key) and split (to assign different tones to either end of the keyboard), and how to make touch response, transpose, and tuning settings.

Using Layer

Layer lets you assign two different tones (a main tone and a layered tone) to the keyboard, both of which play whenever you press a key. For example, you could layer the FRENCH HORN tone on the BRASS tone to produce a rich and brassy sound.

To layer tones

- 1 First select the main tone.
Example: To select "146 SLOW STRINGS 1" as the main tone, press the TONE button and then use the number buttons or [+] and [-] buttons to input 1, 4 and then 6.



- 2 Press the LAYER button.

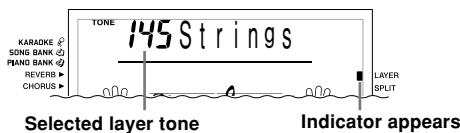

- 3 Select the layered tone.
Example: To select "177 FRENCH HORN" as the layered tone, use the number buttons or [+] and [-] buttons to input 1, 7 and then 7.



- 4 Now try playing something on the keyboard.
 - Both tones are played at the same time.
- 5 Press the LAYER button again to unlayer the tones and return the keyboard to normal.

LAYER

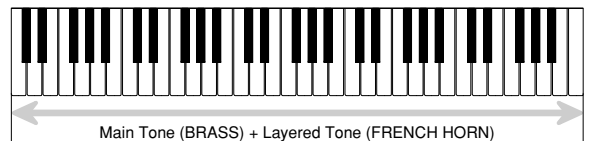

Using Split

With split you can assign two different tones (a main tone and a split tone) to either end of the keyboard, which lets you play one tone with your left hand and another tone with your right hand. For example, you could select STRINGS as the main (high range) tone and PIZZICATO STRINGS as the split (low range) tone, putting an entire string ensemble at your fingertips.

Split also lets you specify the split point, which is the location on the keyboard where the changeover between the two tones occurs.

To split the keyboard

- 1 First select the main tone.

Example: To select "145 STRINGS" as the main tone, press the TONE button and then use the number buttons or [+] and [-] buttons to input 1, 4 and then 5.

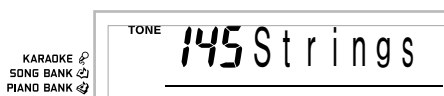

- 2 Press the SPLIT button.

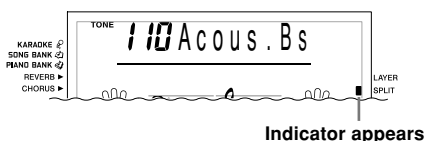

- 3 Select the split tone.

Example: To select "133 PIZZICATO STRINGS" as the split tone, use the number buttons or [+] and [-] buttons to input 1, 3 and then 3.

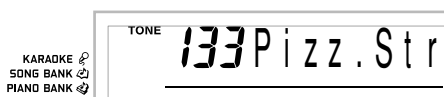

- 4 Specify the split point. While holding down the SPLIT button, press the keyboard where you want the leftmost key of the high end range to be.

Example: To specify G3 as the split point, press the G3 key.



- 5 Now try playing something on the keyboard.
 - Every key from F#3 and below is assigned the PIZZICATO STRINGS tone, while every key from G3 and above is assigned the STRINGS tone.
- 6 Press the SPLIT button again to unsplit the keyboard and return it to normal.

SPLIT

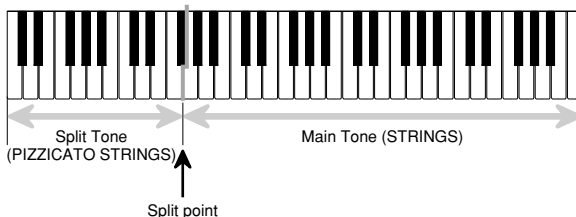

NOTE

- The split point is the point that separates the Auto Accompaniment area (pages E-32 and E-33) and the melody area of the keyboard. You can change the location of the split point, which also changes the sizes of the keyboard areas.

Using Layer and Split Together

You can use layer and split together to create a layered split keyboard. It makes no difference whether you layer tones first and then split the keyboard, or split the keyboard and then layer tones. When you use layer and split in combination, the high range of the keyboard is assigned two tones (main tone + layered tone), and the low range two tones (split tone + layered split tone).

To split the keyboard and then layer tones

- 1 Press the TONE button and then input the tone number of the main tone.



- Press the SPLIT button and then input the number of the split tone.

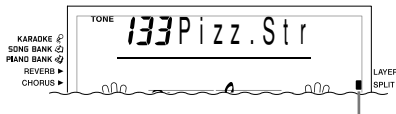

Indicator appears

- After specifying the split tone, press the SPLIT button to unsplit the keyboard.

- Press the LAYER button and then input the number of the layered tone.
 - Note that you can reverse steps 2 and 3, specifying the layered tone first and then the split tone.

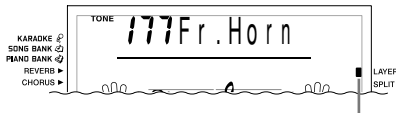

Indicator appears

- Press the SPLIT button or the LAYER button so both of the SPLIT and LAYER indicators are displayed.
- Input the number of the layered split tone.

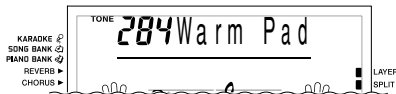

- Specify the split point.
 - While holding down the SPLIT button, press the keyboard where you want the leftmost key of the low end range to be.
- Play something on the keyboard.
 - Press the LAYER button to unlayer the keyboard, and the SPLIT button to unsplit it.

LAYER SPLIT

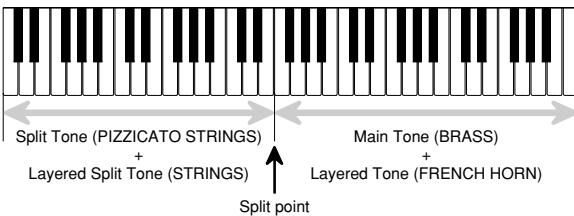

Transposing the Keyboard

Transpose lets you raise and lower the overall key of the keyboard in semitone units. If you want to play an accompaniment for a vocalist who sings in a key that's different from the keyboard, for example, simply use transpose to change the key of the keyboard.

To transpose the keyboard

- Press the RHYTHM button to enter the Rhythm Mode.
 - Note that you cannot transpose the keyboard while in the Song Bank Mode or Piano Bank Mode.
- Use the KEY CONTROL/TRANPOSE buttons (^ / v) to change the key of the keyboard.
 - ^ : Raises the key by one semitone
 - v : Lowers the key by one semitone
 - Example: To transpose the keyboard five semitones upwards.

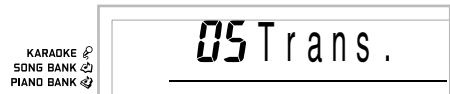

NOTE

- The keyboard can be transposed within a range of -12 (one octave downwards) to +12 (one octave upwards).
- The default transpose setting is "00" when keyboard power is turned on.
- If you leave the transpose screen on the display for about five seconds without doing anything, the screen is automatically cleared.
- The transpose setting also affects playback from memory and Auto Accompaniment.
- To return the keyboard to its default key, perform the above procedure and press both of the KEY CONTROL/TRANPOSE buttons (^ and v) at the same time in step 2. You could also use the [+] and [-] buttons to change the transpose setting to "00".
- The effect of a transpose operation depends on the pitch of each note and on the tone you are currently using. If a transpose operation causes a note to be outside of the allowable range for a tone, the same note in the nearest octave within the range will be substituted.

Using Touch Response

When touch response is turned on, the relative volume of sound output by the keyboard is varied in accordance with the amount of pressure applied, just like an acoustic piano.

Touch response provides a choice of three settings, described below.

OFF: This setting turns off touch response. Keyboard pressure does not have any effect on the output notes.

1: This setting provides touch response that is suited for normal play.

2: This setting increases touch response, so stronger keyboard pressure has a greater effect than the "1" setting.

- 1 Press the FUNCTION button until the TOUCH RESPONSE SELECT screen appears.

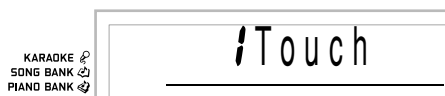

- 2 Use the [+] and [-] or [0] and [1] buttons to change the setting.

Example: To select touch response 2.

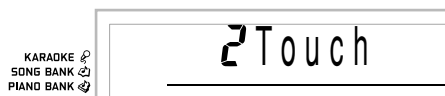

- Touch response is on when TOUCH RESPONSE indicator is on.

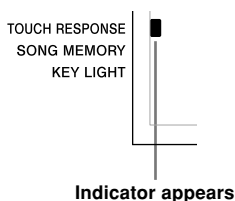

- Touch response is off when TOUCH RESPONSE indicator is off.

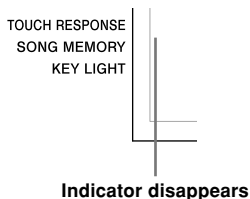

NOTE

- Touch response not only affects the keyboard's internal sound source, it also is output as sending message.
- Song memory playback and accompaniment do not affect the touch response setting.

About FUNCTION button

Each press of the FUNCTION button cycles through a total of 11 setting screens. If you accidentally pass the screen you want to use, keep pressing the FUNCTION button until the screen appears again.

Adjusting Accompaniment and Song Bank Volume

You can adjust the volume of the accompaniment and Song Bank tunes independently of the notes you play on the keyboard. You can specify a volume level in the range of 000 (minimum) to 127 (maximum).

To adjust the accompaniment volume

- 1 Press the FUNCTION button twice to display the accompaniment volume adjustment screen.



Current accompaniment volume setting

- 2 Use the number buttons or the [+] / [-] buttons to change the current volume setting value.

Example: 110



NOTE

- The current accompaniment volume value that appears in Step 1 automatically clears from the display if you do not input anything within about five seconds.
- Pressing [+] and [-] buttons at the same time automatically sets an accompaniment volume of 115.

To adjust built-in tune volume

Enter the Song Bank mode or Piano Bank mode, and then perform the procedure under "To adjust the accompaniment volume".

- In this case, a song volume screen will appear in place of the accompaniment volume screen.

To adjust volume for playback of SMF data from a memory card

Load a memory card into the card slot, and then perform the procedure under "To adjust the accompaniment volume".

- In this case, a song volume screen will appear in place of the accompaniment volume screen.

Tuning the Keyboard

Use the following procedure to fine tune the keyboard to match the tuning of another musical instrument.

To tune the keyboard

- 1 Press the FUNCTION button three times to display the tuning screen.



- 2 Use the [+], [-], and the number buttons to adjust the tuning value.

Example: To lower tuning by 20

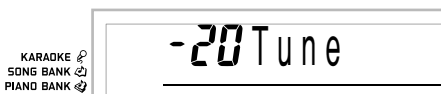

NOTE

- The keyboard can be tuned within a range of -50 cents to +50 cents.
* 100 cents is equivalent to one semitone.
- The default tuning setting is "00" when keyboard power is turned on.
- If you leave the tuning screen on the display for about five seconds without doing anything, the screen is automatically cleared.
- The tuning setting also affects playback from song memory and Auto Accompaniment.
- To return the keyboard to its default tuning, perform the above procedure and press the [+] and [-] buttons at the same time in step 2.

Selecting the Alphabet Type for TV Screen Display

You can select either Latin alphabet characters or Russian (Cyrillic) characters for display of the following text on a TV screen.

- Tune names and lyrics of tunes stored in the Song Bank user area
- Tune names and lyrics of SMF data recalled from a memory card

To specify the TV display alphabet

- 1 Press the FUNCTION button to display the alphabet type setting screen.

Example: When Latin alphabet is currently selected

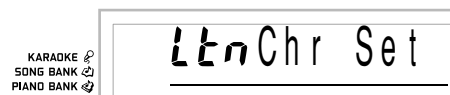

- 2 Use the [+] and [-] buttons to select the alphabet type you want.

Example: When Russian (Cyrillic) is selected

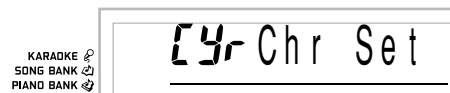

Connection to a Computer

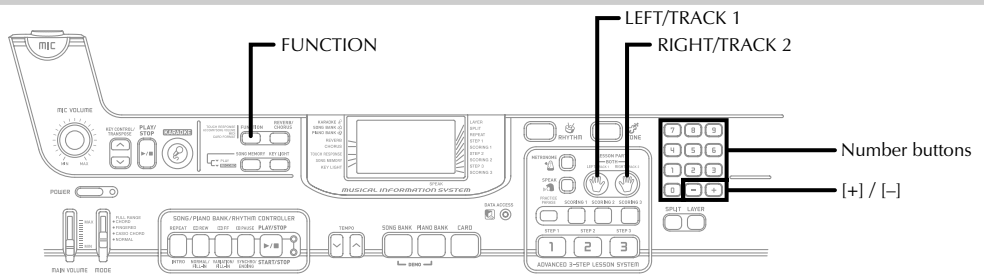

Connecting to a Computer

The keyboard's USB port makes it quick and simple to connect to a computer. After installing the USB MIDI driver onto your computer from the CD-ROM that comes with the keyboard, you will be able to use commercially available MIDI software on your computer to exchange data between the keyboard and your computer.

To install the USB MIDI driver

- 1 On the computer to which you plan to connect, install the USB MIDI driver that comes on the CD-ROM that comes bundled with the keyboard.
 - For information about installing the USB MIDI driver, see the "CASIO USB MIDI Driver User's Guide" (manual_e.pdf) on the "USB Manual and Driver CD-ROM".

NOTE

- Before starting actual installation of USB MIDI driver, be sure to read the contents of the "readme.txt" file in the "English" folder on the CD-ROM.
-
- Use Adobe Reader or Acrobat Reader to access the USB MIDI driver user's guide.*
- * You need to have Adobe Reader or Acrobat Reader installed on your computer in order to view the contents of the "CASIO USB MIDI Driver User's Guide" (manual_e.pdf). If your computer does not have either Adobe Reader or Acrobat Reader installed, use the procedure below to install it.

Installing Adobe Reader (Acrobat Reader**)

- Place the "USB Manual and Driver CD-ROM" into your computer's CD-ROM drive.
- On the CD-ROM, navigate to the folder named "Adobe", open the folder named "English", and then double-click "ar601enu.exe" ("ar505enu.exe"***). Follow the instructions that appear on your computer screen to install Adobe Reader.

** Adobe Reader cannot be installed on a computer running Windows 98. If your computer is running under Windows 98, double-click "ar505enu.exe" to install Acrobat Reader.

Minimum Computer system Requirements

Supported Operating Systems

Operation is supported under Windows® XP, Windows® 2000, Windows® Me, Windows® 98SE, and Windows® 98.

● Universal

- IBM AT or compatible computer
- USB port that provides normal operation under Windows
- CD-ROM drive (for installation)
- At least 2MB of free hard disk space (not including space required for Adobe Reader)

● Windows XP

- 300MHz or higher Pentium processor
- At least 128MB of memory

● Windows 2000

- 166MHz or higher Pentium processor
- At least 64MB of memory

● Windows Me, Windows 98SE, Windows 98

- 166MHz or higher Pentium processor
- At least 32MB of memory

Driver Signing

● Windows XP

- 1 Log on to Windows XP using a Computer administrator account. See the documentation that comes with Windows XP for information about Computer administrator accounts.
- 2 On the Windows [Start] menu, click [Control Panel].
 - If you cannot see the [System] icon on the Control Panel, click [Switch to Classic View].
- 3 Click the [System] icon. On the dialog box that appears, click the [Hardware] tab, and then click the [Driver Signing] button.
- 4 On the dialog box that appears, select [Ignore], and then click [OK].

● Windows 2000

- 1 Log on using an Administrators group account. See the documentation that comes with Windows 2000 for information about the Administrators group.
- 2 On the Windows [Start] menu, point to [Settings] and then click [Control Panel].
- 3 Click the [System] icon. On the dialog box that appears, click the [Hardware] tab, and then click the [Driver Signing] button.
- 4 On the dialog box that appears, select [Ignore], and then click [OK].

NOTE

- Company and product names used herein are trademarks of their respective owners.

Using the USB port

Note that you need to purchase a commercially available USB cable to connect the keyboard to a computer using the USB port. Once you establish a USB connection between the keyboard and a computer, you can exchange data between them.

To connect to a computer using the USB port

- 1 Use a commercially available USB cable to connect the keyboard to the computer.

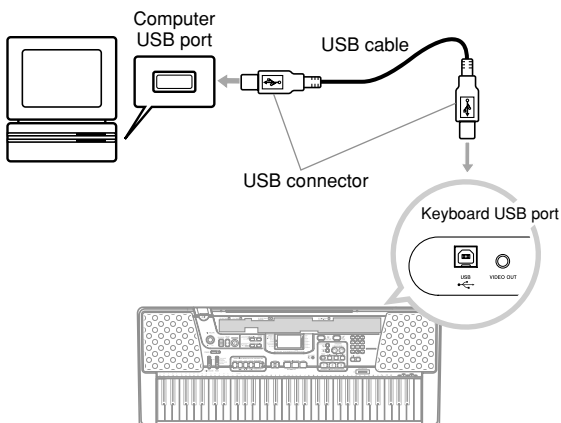

Expanding the Selections in the Song Bank Tunes

You can transfer song data from your computer to the keyboard. You can store up to 10 tunes (about 320 KB) as Song Bank tunes 50 through 59. For SMF data you purchase or create, you need to use an SMF Converter to convert it to CASIO format before transferring it to the keyboard.

To install the SMF Converter

- 1 On the computer to which you plan to connect, install the SMF Converter that comes on the CD-ROM that comes bundled with the keyboard.
 - On the CD-ROM, double-click "SMFConv-e.exe", and then follow the instructions that appear on your computer screen to install SMF Converter.

* Before installing SMF Converter, be sure to read the contents of the "smfreadme.txt" file in each language folder on the CD-ROM.

For information about using SMF Converter, double-click "index.html" in the [help] folder, which was created when you installed SMF Converter. You can also access user documentation from the Windows [Start] menu by clicking [Programs] - [CASIO] - [SMF Converter] - [manual].

* A browser that supports frames (like Internet Explorer 4 or Netscape Navigator 4.04 or higher) is required to view the SMF Converter manual.

Minimum Computer System Requirements

* Operating System:

- Windows 98SE
- Windows Me
- Windows XP

* Storage

At least 10MB free HDD space

* USB interface

- You can also obtain a copy of the SMF Converter by downloading it at the Web page shown below. After downloading, install the software on your computer.

CASIO MUSIC SITE
<http://music.casio.com/>

- In addition to the software itself, the CASIO MUSIC SITE will also provide you with information about its installation and use. You can also find out about the latest news about your keyboard and other CASIO musical instruments, and much more.

Song Data Storage

Song data saved as Song Bank tunes are retained even when power is turned off, as long as the keyboard is being supplied battery or AC adaptor power. If you remove the batteries or should the batteries go dead while the keyboard is not being supplied power by the AC adaptor, song data will be deleted. Be sure to supply power to the keyboard with the AC adaptor when replacing batteries.

NOTE

- This keyboard supports SMF 0 and 1 format data.
- Voice Fingering Guide, on-screen fingering indicators, voice announcement of evaluation points, and the Practice Phrase function are not supported for SMF data you purchase or create.

General MIDI Tone

The General MIDI standard defines the tone numbering sequence, the drum sound numbering sequence, the number of MIDI channels that can be used, and other general factors that determine the sound source configuration. Because of this, musical data produced on a General MIDI sound source can be played back using similar tones and identical nuances as the original, even when played on another manufacturers sound source.

This keyboard conforms with General MIDI standards, so it can be connected to a computer and used to play back General MIDI data that has been purchased, downloaded from the Internet, or obtained from any other source.

Changing the Settings

This section tells you how to make the settings required when connecting to a computer.

KEYBOARD CHANNEL (Default: 1)

The keyboard channel is the channel used to send messages from this keyboard to a computer. You can specify one channel from 1 to 16 as the keyboard channel.

- 1 Press the FUNCTION button until the KEYBOARD CHANNEL screen appears.



- 2 Use the [+], [-], and the number buttons to change the channel number.
Example: To specify channel 4



NAVIGATE CHANNEL (Default: 4)

When messages are received from a computer for play on this keyboard, the navigate channel is the channel whose note data appears on the display. You can select one channel from 01 to 16 as the navigate channel. Since this setting lets you use the data on any channel of commercially available SMF data to light on the on-screen keyboard guide, you can analyze how different parts of an arrangement are played.

- 1 Press the FUNCTION button until the NAVIGATE CHANNEL screen appears.



- 2 Use the [+], [-], and the number buttons [0] through [9] to change the channel number.

Example: To specify channel 2



To turn off specific sounds before playing back tune data that is being received

<<Navigate channel on/off>>

- 1 While playing tune data, press the RIGHT/TRACK 2 button.
 - This cuts the sound of the navigate channel, but on-screen keyboard guide keys continue to light in accordance with the channel's data as it is received. Press RIGHT/TRACK 2 button again to turn the channel back on.

<<Next lower channel from navigate channel on/off>>

- 1 While playing tune data, press the LEFT/TRACK 1 button.
 - This cuts the sound of the channel whose number is one less than the navigate channel, but on-screen keyboard guide keys continue to light in accordance with the channel's data as it is received. Press LEFT/TRACK 1 button again to turn the channel back on.
Example: If the navigate channel is channel 4, the above operation turns off channel 3.

LOCAL CONTROL (Default: On)

oFF: Anything played on the keyboard is output as a message from the USB port, without being sounded by the internal sound source.

- Note that no sound is produced by the keyboard if LOCAL CONTROL is turned off and no external device is connected.

- 1 Press the FUNCTION button until the LOCAL CONTROL screen appears.

Example: When LOCAL CONTROL is on



- 2 Use the [+] and [-] or [0] and [1] buttons to turn the setting on and off.

Example: To turn LOCAL CONTROL off



ACCOMP OUT (Default: Off)

on: Auto Accompaniment is played by the keyboard and the corresponding message is output from the USB port.

oFF: Auto Accompaniment messages are not output from the USB port.

- 1 Press the FUNCTION button until the ACCOMP OUT screen appears.

Example: When ACCOMP OUT is off



- 2 Use the [+] and [-] or [0] and [1] buttons to turn the setting on and off.

Example: To turn ACCOMP OUT on



GM Mode Receive

When GM off is received and the mode switch is set to a chord mode, the Auto Accompaniment chord is specified in accordance with the received message.

When GM on is received, Auto Accompaniment chords cannot be specified by received messages.

SUSTAIN/ASSIGNABLE JACK (Default: SUS)

SUS(sustain): Specifies a sustain*¹ effect when the pedal is depressed.

SoS (sostenuto): Specifies a sostenuto*² effect when the pedal is depressed.

Sft (soft): Specifies reduction of the sound's volume when the pedal is depressed.

rHy (rhythm): Specifies START/STOP button operation when the pedal is depressed.

- 1 Press the FUNCTION button until the SUSTAIN/ASSIGNABLE JACK screen appears.

Example: When sustain is currently set



- 2 Use the [+] and [-] or [0], [1], [2], and [3] buttons to change the setting.

Example: To select rhythm

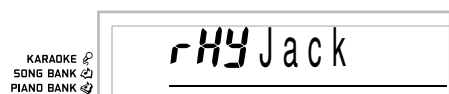

*1 Sustain

With piano tones and other sounds that decay, the pedal acts as a damper pedal, with sounds being sustained longer when the pedal is depressed. With organ tones and other continuous sounds, notes played on the keyboard continue to sound until the pedal is released. In either case, the sustain effect is also applied to any notes that are played while the pedal is depressed.

*2 Sostenuto

This effect performs the same way as sustain, except that it is applied only to notes that are sounding already when the pedal is depressed. It does not affect notes that are played after the pedal is depressed.

Using a Memory Card

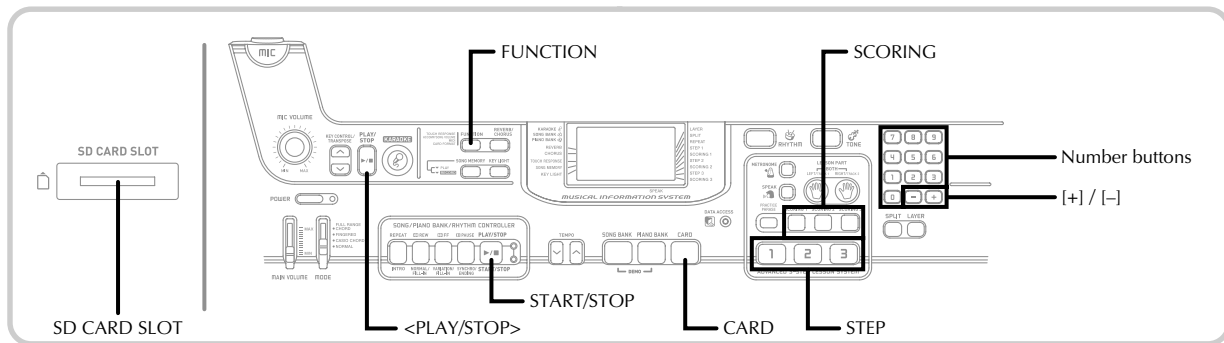

Your keyboard is equipped with a card slot that supports use of memory cards (commercially available SD memory cards or optional CASIO song data card*). This makes it possible for the keyboard to directly read commercially available SMF data, which has been saved to a memory card from your computer, for karaoke and lessons. Memory card data can be used the same way as built-in tunes.



Supported Memory Cards:

SD memory cards, optional CASIO song data cards*

Supported SD Cards:

1 GB or less (Cards with capacity greater than 1 GB are not supported.)

Maximum Number of Importable Songs: Up to 1,000

- The actual number of songs that can be imported depends on the size of each file. The actual number will be less than 1,000 when individual song files are large.

Supported Data:

SMF Format 0, CASIO Original Format CM2

IMPORTANT!

- Use only an SD memory card or an optional CASIO song data card* with this keyboard. Proper operation is not guaranteed when any other type of card is used.

Memory Card and Card Slot Precautions

IMPORTANT!

- Be sure to carefully read all documentation that comes with the memory card for important information about how to handle it.
- SD memory cards have a write protect switch, which you can use to protect against accidental deletion of data. After saving important data to an SD memory card, be sure to use the write protect switch to protect the data against accidental changes or deletion.

- Avoid storing and using memory cards in the following types of locations. Such conditions can cause corruption of data stored on the card.
 - Areas subject to high temperatures, high humidity, or corrosive agents
 - Areas subject to strong electrostatic charge or electrical noise
- Whenever handling a memory card, make sure that you never touch its contacts with your fingers.
- If the data access lamp is lit and the message "Pls Wait" is on the display, it means that data on the memory card is being accessed by a save, read, or delete operation. Never remove the memory card from the card slot or turn off the keyboard while the card is being accessed. Doing so can corrupt the data on the memory card or even damage the card slot.
- Never try to insert anything that is not an SD memory card or optional CASIO song data card* into the Keyboard's memory card slot. Doing so can cause malfunction of the keyboard.
- Inserting a memory card that is charged with static electricity into the card slot can cause malfunction of the keyboard. If this happens, turn the keyboard off and then back on again.
- A memory card that has been in the card slot for a long time may feel hot when you remove it. This is normal and does not indicate malfunction.
- Note that a memory card has a limited service life. After long use, you may not be able to store data to, read data from, and/or delete data from a card. When this happens, you will need to purchase a new memory card.

* May not be available in some geographic areas.

CASIO COMPUTER CO., LTD. assumes no responsibility for any loss or damage to you or any third party arising out of the loss or corruption of data.

Inserting and Removing a Memory Card

IMPORTANT!

- Make sure you turn off the keyboard before inserting or removing a memory card.
- Be sure to orient the card correctly when inserting it. Never try to force a memory card into the card slot when you feel resistance.
- Never remove the memory card from the card slot or turn off the keyboard while card data is being accessed by a read or format operation. Doing so can corrupt the data on the memory card or even damage the card slot.

To insert a memory card into the card slot

- 1 With the front side of the memory card facing upwards, carefully slide it into the card slot. Slide the card all the way in until you hear it click securely into place.

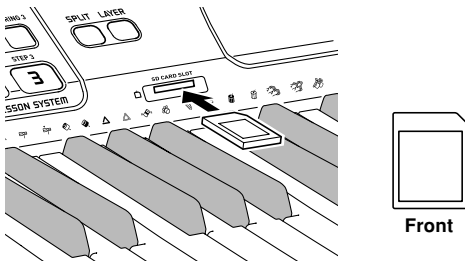

To remove a memory card from the card slot

- 1 Press the memory card into the card slot and then release it. This will cause the card to come part way out of the keyboard.
- 2 Pull the memory card out of the card slot.

Getting Ready

IMPORTANT!

- Before you can use an SD memory card with this keyboard, you need to perform the procedure below to format it. After formatting the card, transfer SMF data from your computer to the card.
- Formatting an SD memory card with this keyboard automatically creates a folder named "MUSICDAT" on the card. When transferring SMF data from your computer to the card for use by the keyboard, be sure to store it in the "MUSICDAT" folder.
- Note that formatting a card that already contains data causes all of that data to be deleted. Data deleted by the format operation cannot be recovered. Before performing the procedure below, check to make sure that the media does not contain any data you might need.

PREPARATION

- Insert the SD memory card you want to format into the keyboard's card slot. Make sure that the SD memory card's write protect is removed, which enables writing.

To format an SD memory card

- 1 Press the FUNCTION button a number of times until the card format setting screen appears.

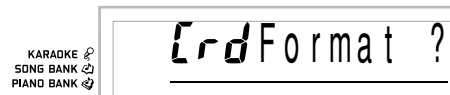

- 2 Press the [+] (YES) button.
 - This will display a confirmation message asking whether you really want to format the media.
- 3 Press the [+] (YES) button to start formatting.
 - The message "Pls Wait" will remain on the display to indicate that a procedure is being performed. Never try to perform any other operation on the keyboard while the card is being formatted. After formatting is complete, the keyboard returns to the mode you were in before you displayed the setting screen.
 - To cancel the format operation, press the [-] (NO) button. This returns to the card format setting screen.
 - If an error message appears on the display, see "Memory Card Error Messages" on page E-55. Pressing the FUNCTION button while an error message is on the display returns to the card format setting screen.

Reading a Memory Card

- 1 Press the CARD button.



Indicator appears

- 2 Use the number buttons to input the three-digit number that corresponds to the SMF data you want to select.
- 3 Perform one of the following operations.

■ To play back SMF data

- 3-1 Press the START/STOP button.
 - The keyboard will read the SMF data and play it.
 - An error message will appear if the selected SMF data file is larger than about 320 KB.

■ To sing along with SMF data

- 3-1 Press the <PLAY/STOP> button.
 - The keyboard will read the SMF data and play it in the Karaoke Mode.
 - An error message will appear if the selected SMF data file is larger than about 320 KB.
 - When you select and start playback of a song that includes lyric data while the keyboard is connected to a TV, a karaoke screen showing the song lyrics will appear on the TV.

■ To use SMF data in a 3-Step Lesson

- 3-1 Press the STEP 1, STEP 2, or STEP 3 button.
 - The keyboard will read the SMF data and start a lesson at the step you selected.
 - An error message will appear if the selected SMF data file is larger than about 320 KB.
 - If an error message appears, see “Memory Card Error Messages” on the following page for information about what you need to do.
 - The channel specified as the navigate channel is assigned to the right-hand part, while the channel that is one less than the channel specified as the navigate channel is assigned to the left-hand part.
 - Voice Fingering Guide and on-screen fingering indicators, are not supported for SMF data.

■ To evaluate your play using SMF Data

- 3-1 Press the SCORING button.
 - The keyboard will read the SMF data and enter the Evaluation Mode.
 - An error message will appear if the selected SMF data file is larger than about 320 KB.
 - If an error message appears, see “Memory Card Error Messages” on the following page for information about what you need to do.
 - The channel specified as the navigate channel is assigned to the right-hand part, while the channel that is one less than the channel specified as the navigate channel is assigned to the left-hand part.
 - On-screen fingering indicators and the Practice Phrase function are not supported for SMF data.
- 4 Press the START/STOP button to stop SMF data play.

Memory Card Error Messages

Display Message	Cause	Action
Err No Card	There is no memory card loaded in the keyboard or the memory card you are using is not loaded correctly.	Load a memory card or correctly reinsert the memory card. page E-53
Err No File	(1) The memory card song data that is supported by the keyboard is not in the MUSICDAT folder. (2) The memory card does not have a MUSICDAT folder.	(1) Move the files containing song data supported by the keyboard to the MUSICDAT folder. (2) Create a MUSICDAT folder and move the applicable files into the folder. Formatting the card will create a MUSICDAT folder automatically. page E-53
Err WrongDat	The data is damaged.	Take the necessary steps to replace the damaged data with normal data.
Err SizeOver	The file is too large to be played by this keyboard.	The maximum supported file size is 320 KB. Select a smaller file. page E-54
Err Protect	The memory card is write-protected.	Remove write protection and re-format the card. pages E-52, 53
Err Format	(1) The memory card has a format that is not supported by this keyboard. (2) The memory card has a capacity that is not supported by this keyboard. (3) There is something wrong with the memory card.	(1) Use this keyboard to format the card. page E-53 (2) This keyboard supports cards with a capacity of 1 GB or less. page E-52 (3) Use a different card.
Err Not SMF0	There is no Format 0 SMF format file. This keyboard supports Format 0 SMF files only.	Use a Format 0 SMF format file. page E-52
Err Card R/W	The memory card cannot be written to or formatted for some reason.	Use a different card.

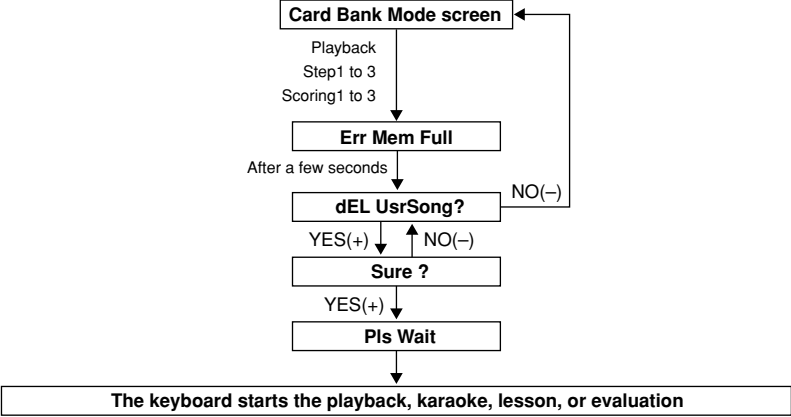
<p>Err Mem Full</p>	<p>The keyboard ran out of memory for SMF data reading during a playback, karaoke, lesson or use of the evaluation feature.</p> <p>After a few seconds, the “Err Mem Full” message will be replaced by one of the messages described below.</p> <p><“dEL UsrSong?”></p> <p>This message asks whether you want to delete the contents of Song Bank user area for storage of SMF data (10 songs) in order to make room for the SMF data you are trying to read. To clear this message and return to the Card Bank Mode screen, press the [-] (NO) button.</p> <ol style="list-style-type: none"> 1) Press the [+] (YES) button if you want to delete Song Bank user area contents. <ul style="list-style-type: none"> • This causes a confirmation message to appear on the display. • If you want to cancel the delete operation, press the [-] (NO) button. This returns you to the confirmation message. 2) Press the [+] (YES) button to delete Song Bank user area contents. <ul style="list-style-type: none"> • After Song Bank user area contents are deleted, the keyboard automatically starts reading of the SMF data you originally selected, and then starts the playback, karaoke, lesson, or evaluation. 	 <pre> graph TD A[Card Bank Mode screen] -- "Playback Step1 to 3 Scoring1 to 3" --> B[Err Mem Full] B -- "After a few seconds" --> C[dEL UsrSong?] C -- "NO(-)" --> A C -- "YES(+)" --> D[Sure ?] D -- "YES(+)" --> E[Pls Wait] E --> F[The keyboard starts the playback, karaoke, lesson, or evaluation] </pre>
----------------------------	--	---

Troubleshooting

Problem	Possible Cause	Action	See page
No keyboard sound	(1) Power supply problem. (2) Power is not turned on. (3) Volume setting is too low. (4) The MODE switch is in the CASIO CHORD or FINGERED position. (5) LOCAL CONTROL is off.	(1) Correctly attach the AC adaptor, make sure that batteries poles (+/-) are facing correctly, and check to make sure that batteries are not dead. (2) Adjust the POWER button to turn on power. (3) Use the MAIN VOLUME slider to increase volume. (4) Normal play is not possible on the accompaniment keyboard while the MODE switch is set to CASIO CHORD or FINGERED. Change the MODE switch setting to NORMAL. (5) Turn on LOCAL CONTROL.	Page E-13 Page E-17 Page E-17 Page E-32 Page E-51
Any of the following symptoms while using battery power.	Low battery power	Replace the batteries with a set of new ones or use the AC adaptor.	Page E-13
<div style="border: 1px solid black; padding: 10px;"> <ul style="list-style-type: none"> • Dim power supply indicator • Instrument does not turn on • Dim, difficult to read display • Abnormally low speaker/headphone volume • Distortion of sound output • Occasional interruption of sound when playing at high volumes • Sudden power failure when playing at high volumes • Dimming of the display when playing at high volume • Continued sound output even after you release a key • A totally different tone may sound • Abnormal rhythm pattern and demo tune play • Abnormally low microphone volume • Distortion of microphone input • Dim power supply indicator when a microphone is used • Sudden power failure when using the microphone • Dimming of keyboard lights when notes sound • Loss of power, sound distortion, or low volume when playing from a connected computer </div>			
Auto Accompaniment does not sound.	Accompaniment volume is set to 000.	Use the FUNCTION button to increase the volume.	Page E-46
Sound output does not change when key pressure is varied.	Touch response is turned off.	Press the FUNCTION button to turn it on.	Page E-46
Key light stays on.	Keyboard is waiting for play of the correct note during Step 1 or Step 2 play.	<ul style="list-style-type: none"> • Press the lit key to continue with Step 1 or Step 2 play. • Press the PLAY/STOP button to quit Step 1 or Step 2 play. 	Pages E-25, 26 Pages E-25, 26
Keys are lit though no sound is being produced.	Power on alert is reminding you that power was left on without any operation being performed.	Press any button or keyboard key to restore power to normal.	Page E-14
Cannot record Auto Accompaniment or rhythm.	Track other than Track 1 is selected as the recording track.	Use the track select buttons to select Track 1. (Track 2 is melody track.)	Page E-40
Cannot record chord accompaniment data on a computer.	ACCOMP OUT is turned off.	Turn on ACCOMP OUT.	Page E-51
Static noise when a microphone is connected.	Use of the microphone in the vicinity of fluorescent lighting.	Move the microphone away from source of the static.	Page E-29
No microphone sound	(1) Microphone volume setting is too low. (2) Microphone on/off switch is set to off.	(1) Increase the microphone volume setting. (2) Change the microphone on/off switch setting to on.	Page E-29 Page E-29

Problem	Possible Cause	Action	See page
Cannot recall data from a memory card.	<ol style="list-style-type: none"> (1) The memory card is not inserted correctly into the card slot. (2) The memory card is damaged. (3) The data has not been copied to the memory card MUSICDAT folder. 	<ol style="list-style-type: none"> (1) Correctly insert the memory card into the card slot. (2) Use a different memory card. (3) Insert a formatted memory card into the memory card slot of your computer, and copy the data you want to play back into the directory named "MUSICDAT". 	Page E-53
Song play momentarily cuts out at some points during SMF or karaoke play.	Data is fragmented.	<p>Perform either of the two following operations.</p> <ul style="list-style-type: none"> • Without deleting the original (fragmented) data, perform a "save as" operation to save the data under a different name. Next, try performing the operation using the newly saved data. • If you saved the data to the card from another location, format the card (which will delete its contents), and then save the data to the card again. Next, try performing the operation using the newly saved data. 	— Page E-53
Lyrics do not appear.	The built-in tune or the SMF data does not have any lyric data.	Select a built-in tune or SMF data that has lyric data.	Page E-30
The color of the image on the TV screen is abnormal.	The keyboard is located on top of or too close to the TV.	Move the keyboard away from the TV.	Page E-16
I can hear the audio, but the image is unclear.	The keyboard and TV are not connected correctly.	Correctly connect keyboard and TV.	Page E-16
Karaoke <PLAY/STOP> button does not work.	The keyboard is not in the Karaoke Mode.	Check to see if the Karaoke icon is shown on the display. If it isn't, use the Song/Piano Bank Controller PLAY/STOP button.	Page E-19
Auto accompaniment chords do not sound.	The keyboard is in the Song Bank mode.	Press the RHYTHM button to enter the rhythm mode, which is indicated by the rhythm indicator on the display.	Page E-31
After transferring song data from my computer, playback stops part way through.	Digital noise from the USB cable or power cord caused data communication between your computer and keyboard to be interrupted.	Stop playback, disconnect the USB cable from and then reconnect it to the keyboard's USB port, and then try playing back the tune again. If this does not correct the problem, exit the MIDI software you are using, and then disconnect the USB cable from and then reconnect it to the keyboard's USB port. Next, restart your MIDI software and try playback again.	Page E-49
A tone's quality and volume sounds slightly different depending where it is played on the keyboard.	<p>This is an unavoidable result of the digital sampling process,* and does not indicate malfunction.</p> <p>* Multiple digital samples are taken for the low range, middle range, and high range of the original musical instrument. Because of this, there may be a very slight difference in tonal quality and volume between sample ranges.</p>		

Specifications

Model:	LK-300TV
Keyboard:	61 standard-size keys, 5 octaves (with touch response; 1, 2, off)
Key Light System:	Can be turned on and off (up to 10 keys can be lit at the same time)
Tones:	514 (372 panel tones + 128 General MIDI tones + 14 drum sets); with layer and split
Digital Effects:	Reverb (4 types), Chorus (4 types)
Polyphony:	32 notes maximum (16 for certain tones)
Auto Accompaniment Rhythm Patterns: Chords: Rhythm Controller: Accomp Volume:	120 3 fingering methods (CASIO CHORD, FINGERED, FULL RANGE CHORD) START/STOP, INTRO, NORMAL/FILL-IN, VARIATION/FILL-IN, SYNCHRO/ENDING 0 to 127 (128 steps)
<Advanced 3-Step Lesson System> 3-step Lesson: Playback: Lesson Part: Evaluation Mode: Voice Fingering Guide:	3 lessons (Step 1, 2, 3) Repeat play of a single tune Left hand, right hand, both hands Scoring 1, Scoring 2, Scoring 3, Phrase Practice On/Off
Song Bank, Piano Bank Number of Tunes: Controllers:	100 (Song Bank/Karaoke: 50, Piano Bank: 50) PLAY/STOP, PAUSE, FF, REW, REPEAT
User Songs:	Number of Songs: Up to 10 download songs Capacity: Approximately 320 KB* * Calculated based on 1 KB = 1024 bytes.
Karaoke Mode Number of Tunes: Controllers:	Song Bank/Karaoke: 50 PLAY/STOP, PAUSE, FF, REW, REPEAT, KEY CONTROL (25 steps, -12 semitones to +12 semitones)
Metronome: Beat Specification:	On/Off 0, 2 to 6
Song Memory Number of Songs: Recorded Data: Recording Method: Memory Capacity:	Two (1 Lesson Recording, 1 Performance Recording) Lesson Recording: Right-hand part, left-hand part, both-hand parts Performance Recording: Track 1 (chord accompaniment), Track 2 (melody) Real-time Approximately 5,200 notes (two songs)
Other Functions Tempo: Transpose: Tuning:	Variable (226 steps, ♩ = 30 to 255) 25 steps (-12 semitones to +12 semitones) 101 steps (A4 = approximately 440Hz ±50Cents)
Card Supported Memory Cards: Supported SD Cards: Maximum Number of Importable Songs: Supported Data:	SD memory cards, optional CASIO song data cards* * May not be available in some geographic areas. 1 GB or less (Cards with capacity greater than 1 GB are not supported.) Up to 1,000 SMF Format 0, CASIO Original Format CM2

Specifications

Terminals SUSTAIN/ASSIGNABLE JACK: PHONES/OUTPUT Jack: Microphone In: USB port: VIDEO OUT Jack: SD CARD SLOT	Standard jack (sustain, sostenuto, soft, rhythm start/stop) Stereo standard jack Output Impedance: 100Ω Output Voltage: 4.5V (RMS) MAX Standard jack (with microphone volume knob) Input impedance: 3KΩ Input sensitivity: 10mV TYPE B Output Voltage: 1Vp-p MAX
Power Jack:	9V DC
Power Supply: Batteries: Battery Life: AC Adaptor: Auto Power Off:	2-way 6 D-size batteries Approximately 2.5 hours continuous operation on manganese batteries AD-5 Turns power off approximately 6 minutes after last key operation. Enabled under batter power only, can be disabled manually.
Speaker Output:	2.5W + 2.5W
Power Consumption:	9V --- 7.7W
Dimensions:	96.0 × 37.5 × 14.6 cm (37 ¹³ / ₁₆ × 14 ³ / ₄ × 5 ³ / ₄ inch)
Weight:	Approximately 5.6kg (12.4 lbs)(without batteries)

- Design and specifications are subject to change without notice.

Care of your keyboard

Avoid heat, humidity or direct sunlight.

Do not overexpose the instrument to direct sunlight, or place it near an air conditioner, or in any extremely hot place.

Do not use lacquer, thinner or similar chemicals for cleaning.

Clean the keyboard with a soft cloth dampened in a weak solution of water and a neutral detergent. Soak the cloth in the solution and squeeze until it is almost dry.

Avoid use in areas subjected to temperature extremes.

Extremely high or low temperature can cause figures on the LCD screen to become dim and difficult to read. This condition should correct itself when the keyboard is brought back to normal temperature.

NOTE

- You may notice lines in the finish of the case of this keyboard. These lines are a result of the molding process used to shape the plastic of the case. They are not cracks or breaks in the plastic, and are no cause for concern.

Tone List / Note Table

Lista de sonidos / Tabla de notas

① : No./Nº

② : Maximum Polyphony/Polifonia máxima

③ : Tone Name/Nombre de sonido

④ : Program Change/Cambio de programa

⑤ : Range Type/Tipo de gama

⑥ : Bank Select MSB/MSB de selección de banco

①	②	③	④	⑤	⑥
	PIANO				
000	STEREO GRAND PIANO	A	16	000	002
001	GRAND PIANO	A	32	000	001
002	BRIGHT PIANO	A	16	001	002
003	MELLOW PIANO	A	16	000	003
004	MODERN PIANO	A	16	001	003
005	DANCE PIANO	A	32	001	001
006	STRINGS PIANO	A	16	000	008
007	SYNTH-STR PIANO	A	16	001	005
008	HONKY-TONK	A	16	003	002
009	1 OCTAVE PIANO	A	16	003	009
010	2 OCTAVE PIANO	A	16	003	008
011	ELEC.GRAND PIANO	A	16	002	002
012	MODERN E.G.PIANO	A	16	002	003
013	STEREO PIANO	A	16	000	004
014	STEREO PIANO WIDE	A	16	000	009
015	PIANO PAD	A	16	000	005
016	HARPSICHORD	A	32	006	002
017	COUPLED HARPSICHORD	A	16	006	008
018	HARPSICHORD PAD	A	16	006	001
	ELECTRIC PIANO				
019	ELEC.PIANO 1	A	32	004	002
020	ELEC.PIANO 2	A	16	005	003
021	FM ELEC.PIANO	A	16	005	005
022	DYNO ELEC.PIANO	A	16	004	007
023	60'S ELEC.PIANO	A	16	004	005
024	CHORUS EP 1	A	16	004	009
025	CHORUS EP 2	A	16	004	006
026	MODERN E.PIANO	A	16	005	002
027	SOFT E.PIANO	A	16	004	008
028	E.PIANO PAD 1	A	16	005	008
029	SYNTH-STR. E.PIANO	A	16	004	003
030	E.PIANO PAD 2	A	16	004	001
031	CLEAN E.PIANO	A	32	004	004
032	HARPSICHORD E.PIANO	A	16	005	004
033	CLAVI	A	32	007	002
034	SOFT CLAVI	A	32	007	001
035	CLAVI & DRAWBAR	A	16	007	003
036	DETUNE CLAVI	A	16	007	008
037	SEQUENCE CLAVI	A	16	007	009
	CHROMATIC PERC				
038	CELESTA	A	32	008	002
039	GLOCKENSPIEL	B	32	009	002
040	MUSIC BOX	A	16	010	002
041	VIBRAPHONE	A	32	011	002
042	MARIMBA	A	32	012	002
043	GLOCKENSPIEL PAD	A	16	009	003
044	SYNTH-VIBRAPHONE	A	16	011	003
045	SYNTH-MARIMBA	A	16	012	003
046	VIBRAPHONE & MARIMBA	A	16	013	002

①	②	③	④	⑤	⑥
047	TUBULAR BELL	A	16	014	002
048	DULCIMER	A	16	015	002
049	BRIGHT CELESTA	A	32	008	001
050	CHORUS CELESTA	A	16	008	008
051	CHORUS GLOCKENSPIEL	B	16	009	008
052	CHORUS VIBRAPHONE	A	16	011	008
	ORGAN				
053	DRAWBAR ORGAN 1	A	16	016	002
054	DRAWBAR ORGAN 2	A	16	016	001
055	DRAWBAR ORGAN 3	A	16	016	003
056	ROTARY DRAWBAR	A	16	017	032
057	PERC.ORGAN 1	A	16	017	002
058	PERC.ORGAN 2	A	16	017	003
059	ELEC.ORGAN 1	A	16	016	008
060	ELEC.ORGAN 2	A	16	016	004
061	JAZZ ORGAN 1	A	16	017	004
062	ROCK ORGAN 1	A	16	018	002
063	CHURCH ORGAN	A	16	019	002
064	CHAPEL ORGAN	A	32	019	008
065	REED ORGAN	A	16	020	002
066	ACCORDION 1	A	16	021	002
067	OCTAVE ACCORDION	A	16	021	008
068	BANDONEON	A	16	023	002
069	HARMONICA 1	A	32	022	002
070	HARMONICA 2	A	16	022	008
071	THEATER	A	16	019	006
072	OCTAVE BANDONEON	A	16	023	003
073	DRAWBAR ORGAN 4	A	16	016	005
074	JAZZ ORGAN 2	A	16	017	006
075	ROCK ORGAN 2	A	16	018	001
076	DRAWBAR ORGAN 5	A	16	016	006
077	JAZZ ORGAN 3	A	16	017	008
078	PERC.ORGAN 3	A	16	017	001
079	8'ORGAN	A	16	017	005
080	ROCK ORGAN 3	A	16	018	003
081	ROCK ORGAN 4	A	16	018	004
082	FULL DRAWBAR	A	32	016	009
083	ORGAN PAD	A	16	017	007
084	SEQUENCE ORGAN	A	16	007	016
085	PIPE ORGAN 1	A	32	019	001
086	PIPE ORGAN 2	A	32	019	003
087	ORGAN & HARPSICHORD	A	16	019	004
088	PIPE ORGAN PAD	A	16	019	005
089	ACCORDION 2	A	32	021	003
090	BANDONEON SOLO	A	16	023	001
091	BANDONEON & VIOLIN	A	16	023	004
	GUITAR				
092	NYLON STR.GUITAR	C	32	024	002
093	STEEL STR.GUITAR	C	32	025	002
094	12 STR.GUITAR	C	16	025	008

①	②	③	④	⑤	⑥
095	JAZZ GUITAR	C	32	026	002
096	OCT.JAZZ GUITAR	C	16	026	008
097	CLEAN GUITAR	C	32	027	002
098	ELEC.GUITAR	C	16	027	001
099	MUTE GUITAR	C	32	028	002
100	CRUNCH ELEC.GUITAR	C	16	027	008
101	OVERDRIVE GT	C	32	029	002
102	DISTORTION GT	C	32	030	002
103	POWER DIST. GT	C	16	030	005
104	HARMONIZED DIST. GT	C	16	030	003
105	RHYTHM DIST. GT	C	16	030	004
106	FEEDBACK GT	C	16	031	008
107	CHORUS STEEL GT	C	16	025	009
108	DIST.GT & BASS	C	16	030	006
109	STEEL GT HARMONICS	C	16	025	003
	BASS				
110	ACOUSTIC BASS	C	32	032	002
111	RIDE BASS	C	16	032	002
112	FINGERED BASS	C	32	033	002
113	PICKED BASS	C	32	034	002
114	FRETLESS BASS	C	32	035	002
115	SLAP BASS	C	32	037	002
116	DOUBLED STRINGS BASS	C	16	037	003
117	SAW SYNTH-BASS	C	32	038	002
118	SOR SYNTH-BASS	C	32	039	002
119	VOCODER BASS	C	32	038	003
120	DIGI ROCK BASS	C	32	039	001
121	SOUL SYNTH-BASS	C	32	038	001
122	TRANCE BASS	C	32	038	004
123	MELLOW FINGERED BASS	C	32	033	003
124	BASS & KICK	C	16	039	003
125	CLAVI BASS	C	16	039	004
126	RHYTHM PICKED BASS	C	32	034	003
127	RHYTHM FINGERED BASS	C	32	033	004
128	SINE BASS	A	32	039	006
129	STR/ORCHESTRA	A	32	039	005
	STR/ORCHESTRA				
130	VIOLIN	A	32	040	002
131	SLOW VIOLIN	A	32	040	008
132	CELLO	C	32	042	002
133	PIZZICATO STRINGS	A	32	045	002
134	HARP 1	A	32	046	002
135	DOUBLE VIOLIN	A	16	040	001
136	SLOW CELLO	C	16	042	008
137	VIOLIN SECTION	A	16	040	004
138	SLOW VIOLIN SECTION	A	16	040	009
139	PIZZICATO ENSEMBLE	A	16	045	001
140	CELLO SECTION	C	16	042	004
141	OCTAVE PIZZICATO	A	16	045	003
142	DOUBLE VIOLA	A	16	041	002

Appendix/Appendice

1	2	3	4	5	6
256	SEQUENCE SQUARE	A	16	080	007
257	SEQUENCE PULSE 1	A	16	080	016
258	SQUARE LEAD 3	A	32	080	001
259	SQUARE LEAD 4	A	16	080	032
260	SAW LEAD 2	A	32	081	001
261	SLOW SAW LEAD	A	16	081	004
262	PULSE SAW LEAD	A	16	081	005
263	SLOW SAW PULSE	A	16	081	006
264	FIFTH SEQUENCE	A	16	086	001
265	SEQUENCE PULSE 2	A	16	081	009
266	SEQUENCE SAW 2	A	16	081	016
267	CALLIOPE 2	A	16	082	003
268	VENT SYNTH	A	16	082	004
269	PURE LEAD	A	16	082	001
270	DISTORTION LEAD	A	16	084	008
271	OCTAVE CHARANG	A	16	084	002
272	VOICE LEAD 2	A	16	085	003
273	CHURCH LEAD	A	16	085	004
274	DOUBLE VOICE LEAD	A	16	085	008
275	VOICE CHOR LEAD	A	16	085	005
276	EP & VOICE LEAD	A	16	085	006
277	SYNTH-VOICE LEAD	A	16	085	007
278	FIFTH SAW LEAD	A	16	086	002
279	FIFTH SQUARE LEAD	A	16	086	003
280	BASS+SAW LEAD	A	16	087	001
281	SYNTH-BASS+LEAD	A	16	087	003
SYNTH-PAD					
282	FANTASY 1	A	16	088	002
283	FANTASY 2	A	16	088	003
284	WARM PAD	A	16	089	002
285	WARM VOX	A	16	089	008
286	SINE PAD	A	16	089	003
287	POLYSYNTH 1	A	16	090	002
288	POLY SAW	A	16	090	005
289	POLYSYNTH PAD 1	A	16	090	005
290	SPACE STRINGS PAD	A	16	091	003
291	BOWED PAD	A	16	092	002
292	GLASS PAD	A	16	092	003
293	ETHNIC PAD	A	16	093	002
294	HALO PAD 1	A	16	094	002
295	HALO PAD 2	A	16	094	003
296	RAIN DROP 1	A	16	096	002
297	SOUND TRACK 1	A	16	097	002
298	RAVE	A	16	097	008
299	CRYSTAL	A	32	098	002
300	SOFT CRYSTAL	A	16	098	001
301	ATMOSPHERE	A	16	099	002
302	BRIGHTNESS 1	A	16	100	002
303	GOBLIN	A	16	101	002
304	ECHO PAD	A	16	102	002
305	STAR THEME 1	A	16	103	002
306	SPACE PAD	A	16	103	008
307	NEW AGE PAD	A	16	088	001
308	SOFT PAD	A	16	089	004
309	HORN PAD	A	16	089	005
310	THICK PAD	A	16	089	001
311	POLYSYNTH 2	A	16	090	001
312	OLD TAPE PAD	A	16	089	006
313	POLYSYNTH PAD 2	A	16	090	004

1	2	3	4	5	6
199	ALTO SAX 1	C	16	065	001
200	ALTO SAX 2	C	32	065	002
201	BREATHY A SAX	C	16	065	008
202	HARD A SAX	C	16	065	003
203	RICHA SAX	C	16	065	006
204	TENOR SAX 1	C	16	066	001
205	TENOR SAX 2	C	32	066	002
206	BREATHY T.SAX	C	16	066	008
207	T.SAXS	C	16	066	009
208	BARITONE SAX	C	32	067	002
209	OBOE	A	32	068	002
210	CLARINET	A	32	071	002
211	BREATHY S.SAX	A	16	064	008
212	SOFT A SAX	C	32	065	005
213	SOLO A SAX	C	32	065	004
214	SAX SECTION	C	16	065	009
215	SAX SECTION SFZ	C	16	065	007
216	DETUNE T.SAX	C	16	066	003
217	SOFT T.SAX	C	16	066	005
218	SOLO T.SAX	C	32	066	004
219	SOLO OBOE	A	32	068	004
220	VELO.CLARINET	A	16	071	004
PIPE					
221	PICCOLO 1	B	32	072	002
222	FLUTE 1	A	32	073	002
223	FLUTE 2	A	16	073	001
224	PURE FLUTE	A	16	073	008
225	PIPE SECTION 1	A	16	072	004
226	RECORDER	A	32	074	002
227	PAN FLUTE 1	A	32	075	002
228	BOTTLE BLOW	A	16	076	002
229	SHAKUHACHI	A	16	077	002
230	WHISTLE 1	A	32	078	002
231	OCARINA	A	32	079	002
232	PICCOLO 2	B	16	072	003
233	PIPE SECTION 2	A	16	073	004
234	SOFT FLUTE	A	32	073	005
235	WHISTLE 2	A	32	078	003
236	PAN FLUTE 2	A	16	075	003
SYNTH-LEAD					
237	SQUARE LEAD 1	A	16	080	002
238	SQUARE PULSE LEAD	A	16	080	005
239	SEQUENCE LEAD	A	16	083	005
240	SAW LEAD 1	A	16	081	002
241	MELLOW SAW LEAD	A	16	81	008
242	SEQUENCE SAW 1	A	16	081	032
243	SINE LEAD	A	32	080	008
244	VELO.SINE LEAD	A	32	080	009
245	SS LEAD	A	16	081	003
246	CALLIOPE 1	A	16	082	002
247	VENT LEAD	A	16	082	005
248	CHIFF LEAD 1	A	16	083	002
249	DROP LEAD	A	16	083	004
250	EP LEAD	A	16	083	001
251	VOICE LEAD 1	A	16	085	002
252	BASS+LEAD	A	16	087	002
253	SQUARE LEAD 2	A	16	080	003
254	SLOW SQUARE LEAD	A	16	080	004
255	SLOW SQUARE PULSE	A	16	080	006

1	2	3	4	5	6
143	HARP 2	A	32	046	001
144	CHORUS HARP	A	16	046	008
ENSEMBLE					
145	STRINGS	A	32	048	002
146	SLOW STRINGS 1	A	32	049	002
147	WIDE STRINGS	A	16	048	016
148	OCTAVE STRINGS 1	A	16	048	032
149	CHAMBER	A	16	048	003
150	STRINGS SFZ	A	32	048	008
151	SYNTH-STRINGS 1	A	32	050	002
152	SYNTH-STRINGS 2	A	32	051	002
153	SYNTH-STRINGS 3	A	32	051	003
154	CHOIR AHS	A	32	052	002
155	CHOIRS 1	A	32	052	008
156	VOICE DOO	A	32	053	002
157	SYNTH-VOICE 1	A	32	054	002
158	SYNTH-VOICE PAD	A	16	054	008
159	ORCHESTRA HIT	A	16	055	002
160	HARP & STRINGS	A	16	050	004
161	FLUTE & STRINGS	A	16	051	004
162	ORCHESTRA STRINGS	A	16	048	004
163	SLOW STRINGS 2	A	32	049	003
164	STRINGS VOICE	A	16	049	004
165	OCTAVE STRINGS 2	A	16	048	001
166	FAST SYNTH STRINGS	A	32	050	003
167	SLOW CHOR	A	32	052	009
168	CHOIR STRINGS	A	16	052	003
169	CHOIRS 2	A	16	052	004
170	VOICE UH	A	32	053	003
171	SYNTH-VOICE 2	A	32	054	001
172	CHORUS SYNTH-VOICE	A	16	054	009
BRASS					
173	TRUMPET	A	32	056	002
174	TROMBONE	C	32	057	002
175	TUBA 1	C	32	058	002
176	MUTE TRUMPET	A	32	059	002
177	FRENCH HORN	C	16	060	002
178	HORN ORCHESTRA	C	16	060	016
179	BRASS	A	32	061	002
180	BRASS SECTION 1	A	16	061	003
181	BRASS SFZ	A	16	061	008
182	BRASS & STRINGS	A	16	061	004
183	HARD BRASS	A	16	061	005
184	BRASS SECTION 2	A	32	061	006
185	ANALOG SYNTH-BRASS 1	A	16	062	008
186	SYNTH-BRASS 1	A	32	062	002
187	SYNTH-BRASS 2	A	16	063	002
188	TRANCE BRASS	A	16	062	001
189	MELLOW TRUMPET	A	32	056	008
190	VELO TRUMPET	A	32	056	004
191	VELO TROMBONE	C	16	057	004
192	MELLOW TROMBONE	C	32	057	001
193	TUBA 2	C	32	058	003
194	FRENCH HORN SOLO	C	32	060	008
195	MELLOW BRASS	A	32	061	001
196	ANALOG SYNTH-BRASS 2	A	16	062	009
197	SYNTH-BRASS PAD	A	16	063	003
REED					
198	SOPRANO SAX	A	32	064	002

1	2	3	4	5	6
430	GM TUBA	A	32	058	000
431	GM MUTE TRUMPET	A	32	059	000
432	GM FRENCH HORN	A	16	060	000
433	GM BRASS	A	32	061	000
434	GM SYNTH-BRASS 1	A	32	062	000
435	GM SYNTH-BRASS 2	A	16	063	000
436	GM SOPRANO SAX	A	32	064	000
437	GM ALTO SAX	A	32	065	000
438	GM TENOR SAX	A	32	066	000
439	GM BARITONE SAX	A	32	067	000
440	GM OBOE	A	32	068	000
441	GM ENGLISH HORN	A	32	069	000
442	GM BASSOON	A	32	070	000
443	GM CLARINET	A	32	071	000
444	GM PICCOLO	A	32	072	000
445	GM FLUTE	A	32	073	000
446	GM RECORDER	A	32	074	000
447	GM PAN FLUTE	A	32	075	000
448	GM BOTTLE BLOW	A	16	076	000
449	GM SHAKUHACHI	A	16	077	000
450	GM WHISTLE	A	32	078	000
451	GM OCARINA	A	32	079	000
452	GM SQUARE LEAD	A	16	080	000
453	GM SAW LEAD	A	16	081	000
454	GM CALLOPE	A	16	082	000
455	GM CHIFF LEAD	A	16	083	000
456	GM CHARANG	A	16	084	000
457	GM VOICE LEAD	A	16	085	000
458	GM FIFTH LEAD	A	16	086	000
459	GM BASS+LEAD	A	16	087	000
460	GM FANTASY	A	16	088	000
461	GM WARM PAD	A	16	089	000
462	GM POLYSYNTH	A	16	090	000
463	GM SPACE CHOIR	A	16	091	000
464	GM BOWED GLASS	A	16	092	000
465	GM METAL PAD	A	16	093	000
466	GM HALO PAD	A	16	094	000
467	GM SWEEP PAD	A	16	095	000
468	GM RAIN DROP	A	16	096	000
469	GM SOUND TRACK	A	16	097	000
470	GM CRYSTAL	A	16	098	000
471	GM ATMOSPHERE	A	16	099	000
472	GM BRIGHTNESS	A	16	100	000
473	GM GOBLINS	A	16	101	000
474	GM ECOES	A	16	102	000
475	GM SF	A	16	103	000
476	GM SITAR	A	16	104	000
477	GM BANJO	A	32	105	000
478	GM SHAMISEN	A	32	106	000
479	GM KOTO	A	32	107	000
480	GM THUMB PIANO	A	32	108	000
481	GM BAGPIPE	A	16	109	000
482	GM FIDDLE	A	32	110	000
483	GM SHANAI	A	32	111	000
484	GM TINKLE BELL	A	32	112	000
485	GM AOGO	A	32	113	000
486	GM STEEL DRUMS	A	16	114	000
487	GM WOOD BLOCK	D	32	115	000
488	GM TAIKO	D	32	116	000

1	2	3	4	5	6
GM TONES					
372	GM PIANO 1	A	32	000	000
373	GM PIANO 2	A	32	001	000
374	GM PIANO 3	A	32	002	000
375	GM HONKY-TONK	A	16	003	000
376	GM E.PIANO 1	A	32	004	000
377	GM E.PIANO 2	A	16	005	000
378	GM HARPSICHORD	A	32	006	000
379	GM CLAVI	A	32	007	000
380	GM CELESTA	A	32	008	000
381	GM GLOCKENSPIEL	A	32	009	000
382	GM MUSIC BOX	A	16	010	000
383	GM VIAPHONE	A	32	011	000
384	GM MARIMBA	A	32	012	000
385	GM XYLOPHONE	A	32	013	000
386	GM TUBULAR BELL	A	32	014	000
387	GM DULCIMER	A	16	015	000
388	GM ORGAN 1	A	16	016	000
389	GM ORGAN 2	A	16	017	000
390	GM ORGAN 3	A	16	018	000
391	GM PIPE ORGAN	A	16	019	000
392	GM REED ORGAN	A	32	020	000
393	GM ACCORDION	A	16	021	000
394	GM HARMONICA	A	32	022	000
395	GM BANDONEON	A	16	023	000
396	GM NYLON STR. GUITAR	A	32	024	000
397	GM STEEL STR. GUITAR	A	32	025	000
398	GM JAZZ GUITAR	A	32	026	000
399	GM CLEAN GUITAR	A	32	027	000
400	GM MUTE GUITAR	A	32	028	000
401	GM OVERDRIVE GT	A	32	029	000
402	GM DISTORTION GT	A	32	030	000
403	GM GT HARMONICS	A	32	031	000
404	GM ACOUSTIC BASS	A	32	032	000
405	GM FINGERED BASS	A	32	033	000
406	GM PICKED BASS	A	32	034	000
407	GM FRETLESS BASS	A	32	035	000
408	GM SLAP BASS 1	A	32	036	000
409	GM SLAP BASS 2	A	32	037	000
410	GM SYNTH-BASS 1	A	32	038	000
411	GM SYNTH-BASS 2	A	32	039	000
412	GM VIOLA	A	32	040	000
413	GM VCLN	A	32	041	000
414	GM CELLO	A	32	042	000
415	GM CONTRABASS	A	32	043	000
416	GM TREMOLO STRINGS	A	32	044	000
417	GM PIZZICATO	A	32	045	000
418	GM HARP	A	32	046	000
419	GM TIMPANI	A	32	047	000
420	GM STRINGS 1	A	32	048	000
421	GM STRINGS 2	A	32	049	000
422	GM SYNTH-STRINGS 1	A	32	050	000
423	GM SYNTH-STRINGS 2	A	32	051	000
424	GM CHOIR AAHS	A	32	052	000
425	GM VOICE DOO	A	32	053	000
426	GM SYNTH-VOICE	A	32	054	000
427	GM ORCHESTRAHIT	A	16	055	000
428	GM TRUMPET	A	32	056	000
429	GM TROMBONE	A	32	057	000

1	2	3	4	5	6
314	HEAVEN	A	16	091	002
315	UTOPIA	A	16	091	001
316	SQUARE PAD	A	16	092	001
317	SOFT METAL PAD	A	16	093	003
318	HARD METAL PAD	A	16	093	004
319	TIME PAD	A	16	093	001
320	CHORUS PAD	A	16	094	001
321	ORGAN CHOIR PAD	A	16	094	004
322	SWEET PAD	A	16	095	002
323	SWEET CHOIR	A	16	095	001
324	CLAVI PAD	A	16	096	001
325	RAIN DROP 2	A	16	096	003
326	SOUND TRACK 2	A	16	097	003
327	SPACE VOICE	A	16	097	001
328	CHORAL BELL	A	16	098	016
329	GLOCKENSPIEL CHIME	A	16	098	005
330	CHRISTMAS BELL	A	16	098	003
331	VIAPHONE BELL	A	16	098	008
332	NYLON+EP	A	16	099	005
333	CELESTA PAD	A	16	099	001
334	BRIGHT BELL PAD	A	16	100	001
335	BRIGHTNESS 2	A	16	100	003
336	ECHO VOICE	A	16	102	001
337	ECHO DROP	A	16	102	003
338	POLY DROP	A	16	102	004
339	STAR THEME 2	A	16	103	001
ETHNIC/CHINESE					
340	SITAR 1	A	16	104	002
341	WARM SITAR	A	16	104	001
342	BANJO	A	32	105	002
343	MUTE BANJO	A	32	105	001
344	SHAMISEN 1	A	32	106	002
345	TSUGURU	A	32	106	001
346	KOTO	A	32	107	002
347	THUMB PIANO	A	32	108	002
348	SHANAI	A	32	111	002
349	STEEL DRUMS	A	16	114	002
350	ER HU 1	A	32	110	008
351	ER HU 2	A	32	110	009
352	YANG QIN 1	A	32	015	008
353	YANG QIN 2	A	16	015	009
354	DI ZI	A	32	072	016
355	YANG QIN & ER HU	A	32	111	008
356	ZHENG	A	32	107	001
357	SUONA	A	32	111	032
358	PI PA 1	A	32	105	032
359	SHENG	A	32	109	008
360	KOTO PAD	A	16	107	005
361	SITAR 2	A	32	104	003
362	TAMBRA	A	16	104	008
363	SITAR PAD	A	16	104	004
364	RABAB	A	16	105	008
365	PI PA 2	A	16	105	004
366	SHAMISEN 2	A	16	106	003
367	DETUNE KOTO	A	16	107	004
368	SYNTH-KOTO	A	16	107	003
369	SHAMISEN & TAIKO	A	16	106	004
370	XIAO	A	16	077	032
371	SANTUR	A	32	015	016

1	2	3	4	5	6
489	GM MELODIC TOM	D	32	117	000
490	GM SYNTH-DRUM	D	32	118	000
491	GM REVERSE CYMBAL	D	32	119	000
492	GM GT FRET NOISE	A	32	120	000
493	GM BREATH NOISE	A	32	121	000
494	GM SEASHORE	D	16	122	000
495	GM BIRD	D	16	123	000
496	GM TELEPHONE	D	32	124	000
497	GM HELICOPTER	D	32	125	000
498	GM APPLAUSE	D	16	126	000
499	GM GUNSHOT	D	32	127	000
DRUM SET					
500	STANDARD SET 1	D	-	000	120
501	STANDARD SET 2	D	-	001	120
502	STANDARD SET 3	D	-	002	120
503	ROOM SET	D	-	008	120
504	POWER SET	D	-	016	120
505	ROCK SET	D	-	065	120
506	HIPHOP SET	D	-	064	120
507	ELECTRONIC SET	D	-	024	120
508	SYNTH SET 1	D	-	025	120
509	SYNTH SET 2	D	-	030	120
510	TRANCE SET	D	-	031	120
511	JAZZ SET	D	-	032	120
512	BRUSH SET	D	-	040	120
513	ORCHESTRA SET	D	-	048	120

NOTE
 • The meaning of each range type is described below.

NOTA
 • El significado de cada tipo de gama se describe debajo.

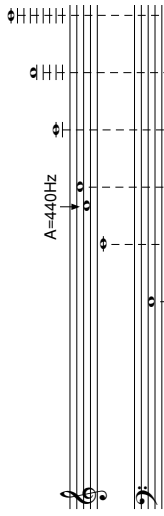

Range Type/ Tipo de gama	C-1 C0 C1 C2 C3 C4 C5 C6 C7 C8 C9 C9
A (Standard type) (Tipo estándar)	[Diagram showing a keyboard range from approximately C3 to C8]
B ("039 GLOCKENSPIEL"/ "051 CHORUS GLOCKENSPIEL"/ "1051 CHORUS GLOCKENSPIEL"/ "221 PICCOLO 1"/ "232 PICCOLO 2") ("039 GLOCKENSPIEL"/ "051 CHORUS GLOCKENSPIEL"/ "1051 CHORUS GLOCKENSPIEL"/ "221 PICCOLO 1"/ "232 PICCOLO 2")	[Diagram showing a keyboard range from approximately C3 to C8]
C (Low pitch instruments) (Instrumentos de altura tonal baja)	[Diagram showing a keyboard range from approximately C1 to C6]
D (Sound Effect) (Efecto de sonido)	No scale for tones. Sin escala para los sonidos.

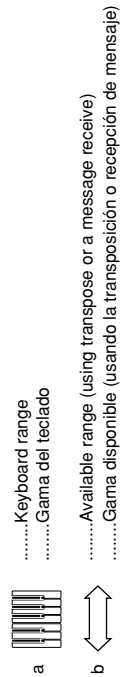

Drum Assignment List / Lista de asignación de batería

KEY/ Note/ number	DRUMS SET LIST										ORCHESTRA SET			
	STANDARD SET 1	STANDARD SET 2	STANDARD SET 3	ROOM SET	POWER SET	ROCK SET	HIP-HOP SET	ELECTRONIC SET	SYNTH SET 1	SYNTH SET 2		TRANCE SET	JAZZ SET	BRUSH SET
C-1 0														
C#-1 1														
D-1 2														
E-1 3														
F-1 4														
F#-1 5														
G-1 7														
A-1 9														
A#-1 8														
B-1 10														
B-1 11														
C0 12														
C#0 13														
D0 14														
E0 16														
F0 17														
F#0 18														
G0 19														
A0 21														
B0 23														
B0 22														
C1 24														
C1 25														
D1 26														
E1 27														
F1 28														
F1 29														
G1 31														
G1 32														
A1 33														
B1 35														
C2 36														
C#2 37														
D2 38														
E2 40														
F2 41														
G2 43														
A2 45														
B2 47														
C3 48														
C#3 49														
D3 50														
E3 52														
F3 53														
F#3 54														
G3 55														
A3 57														
B3 59														
C4 60														
C#4 61														
D4 62														
E4 64														

KEY/ Note number	DRUMS SET LIST										ORCHESTRA SET			
	STANDARD SET 1	STANDARD SET 2	STANDARD SET 3	ROOM SET	POWER SET	ROCK SET	HIP-HOP SET	ELECTRONIC SET	SYNTH SET 1	SYNTH SET 2		TRANCE SET	JAZZ SET	BRUSH SET
F4 65	High Timbale													
F#4 66	Low Timbale													
G4 67	High Ad3gp													
A4 68	Low Ad3gp													
A4 69	Cabasa													
B#4 70	Marcacas							Synth1 Marcacas						
B4 71	Short High Whistle													
C5 72	Long Low Whistle													
C#5 73	Short Guiro													
D5 74	Long Guiro													
D5 75	Claves							Synth1 Claves						
E5 76	High Wood Block													
F5 77	Low Wood Block													
F#5 78	Mute Cuica													
G5 79	Open Cuica													
A#5 80	Mute Triangle													
A5 81	Open Triangle													
B5 82	Shaker													
B5 83	Jingle Bell													
C6 84	Bell Tree													
C#6 85	Castanets													
D6 86	Mute Surdo													
E6 87	Open Surdo													
E6 88	Applause 1													
F6 89	Applause 2													
F#6 90	Fanfare													
G6 91	One													
A6 92	Two													
A6 93	Three													
B6 94	Four													
B6 95	Five													
C7 96	Bravo													
C#7 97	Grest													
D7 98	Not Bad													
E7 99	Try Again													
F7 100	Try Again													
F7 101	Good													
F#7 102	That's Close													
G7 103	Nice Try													
A7 104	Keep Trying													
A7 105	Take Your Time													
B7 107	Rank Up													
B7 107	Rank Down													
C8 108	Pko Pko													
C#8 108														
D8 110														
E8 112														
F8 113	F#8 114													
G8 115	A8 116													
A8 117	B#8 118													
B8 119														
C9 120														
C#9 121														
D8 122	E#9 123													
E9 124														
F9 125														
F#9 126														
G9 127														

NOTE

• " ← " Indicates the same sound as STANDARD SET 1.

NOTA

• " ← " Indica el mismo sonido que STANDARD SET 1.

FINGERED Chord Chart

Cuadro de acordes digitados

Chord Type Root	M	m	7	m7	dim7	M7	m7 ^b 5	dim	Chord Type Root	aug	sus4	7 sus4	m add9	m M7	7-5	add9
C									C							
C# (D ^b)									C# (D ^b)							
D									D							
E ^b (D [#])									E ^b (D [#])							
E									E							
F									F							
F# (G ^b)									F# (G ^b)							
G									G							
A ^b (G [#])									A ^b (G [#])							
A					*				A							
B ^b (A [#])					*				B ^b (A [#])	*						
B					*				B	*						

NOTE

• These chords can be fingered if you expand the accompaniment area of the keyboard by changing the split point. For details, see "Using Split" on page E-44.

NOTA

• Estos acordes se pueden digitar si expande el área de acompañamiento del teclado cambiando el punto de división. Para más información, vea "Usando la división" en la página S-44.

Rhythm List/Lista de ritmos

8 BEAT / 16 BEAT	POPS	059 MARCH 2	090 SLOW GOSPEL
000 MELLOW 8 BEAT	030 REGGAE POP	060 MARCH 3	091 PASODOBLE
001 GUITAR 8 BEAT	031 GUITAR POP	061 WALTZ 1	092 FOLKLORE
002 8 BEAT 1	032 OFF BEAT	062 WALTZ 2	093 SIRTAKI
003 8 BEAT 2	033 POP WALTZ	063 SLOW WALTZ	094 HAWAIIAN
004 8 BEAT 3	034 FOLKIE POP	064 VIENNESE WALTZ	095 ADANI
005 8 BEAT POP	035 POP ROCK	065 FRENCH WALTZ	096 BALADI
006 BASIC 8 BEAT	ROCK	066 SERENADE	097 ENKA
007 16 BEAT	036 MODERN ROCK	067 TANGO	098 SYMPHONY
008 16 BEAT SHUFFLE 1	037 SHUFFLE ROCK	LATIN	099 STR QUARTET
009 16 BEAT SHUFFLE 2	038 SIMPLE ROCK	068 BOSSA NOVA 1	FOR PIANO
010 16 BEAT SHUFFLE 3	039 SOFT ROCK	069 BOSSA NOVA 2	100 PIANO BALLAD 1
BALLAD	040 LATIN ROCK	070 BOSSA NOVA 3	101 PIANO BALLAD 2
011 MODERN BALLAD	041 60'S SOUL	071 BEGUINE	102 PIANO BALLAD 3
012 16 BEAT BALLAD	042 SLOW ROCK	072 SAMBA 1	103 EP BALLAD 1
013 SOUL BALLAD	043 50'S ROCK	073 SAMBA 2	104 EP BALLAD 2
014 POP BALLAD 1	044 NEW ORLNS R&R	074 MAMBO	105 BLUES BALLAD
015 POP BALLAD 2	045 ROCK WALTZ	075 RHUMBA	106 MELLOW JAZZ
016 6/8 BALLAD	JAZZ	076 CHA-CHA-CHA	107 JAZZ COMBO 2
017 ROCK BALLAD 1	046 SLOW SWING	077 MERENGUE	108 RAGTIME
018 ROCK BALLAD 2	047 SWING 1	078 BOLERO	109 BOOGIE-WOOGIE
019 BALLAD	048 SWING 2	079 SALSA	110 ARPEGGIO 1
DANCE	049 JAZZ WALTZ 1	080 REGGAE	111 ARPEGGIO 2
020 HIP-HOP	050 JAZZ WALTZ 2	081 PUNTA	112 ARPEGGIO 3
021 RAP POP	051 BIG BAND 1	082 CUMBIA	113 PIANO BALLAD 4
022 DISCO POP	052 BIG BAND 2	083 SKA	114 6/8 MARCH
023 TECHNO POP	053 BIG BAND 3	VARIOUS	115 MARCH 4
024 TRANCE	054 FOX TROT	084 COUNTRY 1	116 2 BEAT
025 MODERN R&B	055 JAZZ COMBO 1	085 COUNTRY 2	117 WALTZ 3
026 DANCE	EUROPEAN	086 BLUEGRASS	118 WALTZ 4
027 LATIN DISCO	056 POLKA	087 DIXIE	119 WALTZ 5
028 DISCO SOUL	057 POP POLKA	088 TEX-MEX	
029 SOUL	058 MARCH 1	089 FAST GOSPEL	

NOTE

- Rhythms 110 through 119 consist of chord accompaniments only, without any drums or other percussion instruments. These rhythms do not sound unless CASIO CHORD, FINGERED, or FULL RANGE CHORD is selected as the accompaniment mode. With such rhythms, make sure that CASIO CHORD, FINGERED, or FULL RANGE CHORD is selected before you try playing chords.

NOTA

- Los ritmos 110 al 119 consisten solamente de acompañamientos de acordes, sin ninguna batería ni otros instrumentos de percusión. Estos ritmos no suenan a menos que CASIO CHORD, FINGERED o FULL RANGE CHORD sean seleccionados como el modo de acompañamiento. Con tales ritmos, asegúrese de que se selecciona CASIO CHORD, FINGERED o FULL RANGE CHORD, antes de tratar de ejecutar los acordes.

Song List/Lista de canciones

SONG BANK/KARAOKE List

Lista SONG BANK/KARAOKE

00	WE GOT THE BEAT	26	ANNIE LAURIE
01	BEYOND THE SEA ("FINDING NEMO" THEME)	27	MY BONNIE
02	BORDERLINE	28	MY DARLING CLEMENTINE
03	WE WISH YOU A MERRY CHRISTMAS	29	HOME SWEET HOME
04	JINGLE BELLS	30	ON TOP OF OLD SMOKEY
05	SILENT NIGHT	31	I'VE BEEN WORKING ON THE RAILROAD
06	JOY TO THE WORLD	32	LITTLE BROWN JUG
07	O CHRISTMAS TREE	33	AURA LEE
08	WHEN THE SAINTS GO MARCHING IN	34	OH! SUSANNA
09	GREENSLEEVES	35	HOUSE OF THE RISING SUN
10	SWING LOW, SWEET CHARIOT	36	SHE WORE A YELLOW RIBBON
11	AMAZING GRACE	37	CAMPTOWN RACES
12	AULD LANG SYNE	38	SWANEE RIVER (OLD FOLKS AT HOME)
13	TWINKLE TWINKLE LITTLE STAR	39	JEANNIE WITH THE LIGHT BROWN HAIR
14	LIGHTLY ROW	40	YANKEE DOODLE
15	UNDER THE SPREADING CHESTNUT TREE	41	RED RIVER VALLEY
16	COME BIRDS	42	TURKEY IN THE STRAW
17	THE MUFFIN MAN	43	MY OLD KENTUCKY HOME
18	LONG LONG AGO	44	HOME ON THE RANGE
19	DID YOU EVER SEE A LASSIE?	45	JAMAICA FAREWELL
20	LONDON BRIDGE	46	ALOHA OE
21	THE FARMER IN THE DELL	47	SAKURA SAKURA
22	ON THE BRIDGE OF AVIGNON	48	SANTA LUCIA
23	SIPPIN' CIDER THROUGH A STRAW	49	WALTZING MATILDA
24	GRANDFATHER'S CLOCK		
25	MICHAEL ROW THE BOAT ASHORE	50~59	Loaded songs (user songs)/ Canciones cargadas (canciones del usuario)

PIANO BANK List/Lista PIANO BANK

CONCERT PIECES			
00	FÜR ELISE	26	LIEBESTRAUME no.3
01	TURKISH MARCH (MOZART)	27	MARCHE MILITAIRE no.1
02	PIANO SONATA op.27 no.2 "MOONLIGHT" 1st Mov.	28	BLUMENLIED
03	ETUDE op.10 no.3 "CHANSON DE L'ADIEU"	29	GRANDE VALSE BRILLANTE op.18 no.1 ETUDES
04	GYMNOPÉDIES no.1		ETUDES
05	THE ENTERTAINER	30	MINUET (J.S.BACH)
06	MAPLE LEAF RAG	31	GAVOTTE (GOSSEC)
07	HUNGARIAN DANCES no.5	32	ARABESQUE (BURGMÜLLER)
08	TRÄUMEREI	33	CHOPSTICKS
09	LA FILLE AUX CHEVEUX DE LIN	34	FRÖHLICHER LANDMANN
10	HUMORESKE (DVOŘÁK)	35	AVE MARIA (GOUNOD)
11	PROMENADE FROM "TABLEAUX D'UNE EXPOSITION"	36	AVE MARIA (GOUNOD)
12	MOMENTS MUSICAUX op.94 no.3	37	JESUS BLEIBET MEINE FREUDE
13	LE CYGNE FROM "LE CARNAVAL DES ANIMAUX"	38	CANON (PACHELBEL)
14	VALSE op.64 no.1 "PETIT CHIEN"	39	SONATINA op.36 no.1 1st Mov.
15	CHANSON DU TOREADOR FROM "CARMEN"	40	PIANO SONATA op.13 "PATHÉTIQUE" 2nd Mov.
16	LARGO (HÄNDEL)	41	PRELUDE op.28 no.7 (CHOPIN)
17	WEDDING MARCH FROM "MIDSUMMER NIGHT'S DREAM"	42	JE TE VEUX
18	AMERICAN PATROL	43	RÉVERIE
19	CSIKOS POST	44	ODE TO JOY
20	DOLLY'S DREAMING AND AWAKENING	45	SERENADE FROM "EINE KLEINE NACHTMUSIK"
21	LA CHEVALERESQUE	46	MARCH FROM "THE NUTCRACKER"
22	PIANO SONATA K.545 1st Mov.	47	GOING HOME FROM "FROM THE NEW WORLD"
23	LA PRIÈRE D'UNE VIERGE	48	BEAUTIFUL DREAMER
24	TURKISH MARCH (BEETHOVEN)	49	DANNY BOY
25	NOCTURNE op.9 no.2 (CHOPIN)		

Model LK-300TV

Version: 1.0

MIDI messages that can be sent and received using the USB port Los mensajes MIDI pueden enviarse y recibirse usando el puerto USB

Function ...	Transmitted	Recognized	Remarks
Basic Channel Default Changed	1 1-16	1-16 1-16	
Mode Default Messages Altered	Mode 3 X *****	Mode 3 X *****	
Note Number True voice	36-96 *****	0-127 12-108*1	*1: See Tone List on page A-1. *1: Vea la lista de sonidos en la página A-1.
Velocity Note ON Note OFF	0-9nH V = 1-127 X 8nH V = 64	0-9nH V = 1-127 X 9nH V = 0,8nH V = XX	XX: no relation XX: sin relación
After Touch Key's Ch's	X X	X O*2	
Pitch Bender	X	O	
Control Change 0, 32 1 6, 38 7 10 11 64 66	O X X X X X O*4 O*4	O O*2 O*3 O O O O O	Bank select Modulation Data entry Volume Pan Expression Hold1 Sostenuto

67 91 93 100, 101 120 121	O*4 X O X O O	O*4 X O X O O	O O O*3 O O O	Soft pedal Reverb send Chorus send RPN LSB, MSB All sound off Reset all controller
Program Change : True #	O 0-127 *****	O 0-127 *****	O 0-127 *****	
System Exclusive	O*5	O*5	O*5 *6	
System Common : Song Pos : Song Sel : Tune	X X X	X X X	X X X	
System Real Time : Clock : Commands	O O	O O	X X	
Aux Messages : Local ON/OFF : All notes OFF : Active Sense : Reset	X O X X	X O X X	X O O X	
Remarks	<p>**2 Modulation and after touch for each channel are the same effect. **2 La modulación y después del toque para cada canal tienen el mismo efecto.</p> <p>**3 FINE TUNE, COARSE TUNE receive, and PITCH BEND SENSE. RPN Null receive o SENSE recepción RPN. **3 FINE TUNE, recepción COARSE TUNE, y PITCH BEND SENSE, recepción RPN.</p> <p>**4 In accordance with sustain/assignable jack setting **4 De acuerdo con el ajuste de la toma asignable</p> <p>**5 • Reverb Type [F0] [7F] [04] [05] [01] [01] [01] [01] [01] [00] [w] [F7] vv=00: Room1, 01: Room2, 04: Hall1, 03: Hall2</p> <p>** Chorus Type [F0] [7F] [04] [05] [01] [01] [01] [01] [02] [00] [w] [F7] vv=00: Chorus1, 01: Chorus2, 02: Chorus3, 03: Chorus4 ** por de reverberación [F0] [7F] [04] [05] [01] [01] [01] [01] [03] [00] [w] [F7] vv=00: Chorus1, 01: Chorus2, 04: Hall1, 03: Hall2 ** Tipo de Chorus [F0] [7F] [04] [05] [01] [01] [01] [02] [00] [w] [F7] vv=00: Chorus1, 01: Chorus2, 02: Chorus3, 03: Chorus4 ** GM on/off GM.ON: [F0] [7E] [7F] [09] [01] [F7] GM.OFF: [F0] [7E] [7F] [09] [02] [F7] ** Activación/desactivación GM. GM.ON: [F0] [7E] [7F] [09] [01] [F7] GM.OFF: [F0] [7E] [7F] [09] [02] [F7]</p>			

Mode 1 : OMNI ON, POLY
Mode 3 : OMNI OFF, POLY

Mode 2 : OMNI ON, MONO
Mode 4 : OMNI OFF, MONO

O : Yes
X : No



This recycle mark indicates that the packaging conforms to the environmental protection legislation in Germany.

Esta marca de reciclaje indica que el empaquetado se ajusta a la legislación de protección ambiental en Alemania.

CASIO®

CASIO COMPUTER CO.,LTD.
6-2, Hon-machi 1-chome
Shibuya-ku, Tokyo 151-8543, Japan

MA0603-A Printed in China
LK300ES1A

Free Manuals Download Website

<http://myh66.com>

<http://usermanuals.us>

<http://www.somanuals.com>

<http://www.4manuals.cc>

<http://www.manual-lib.com>

<http://www.404manual.com>

<http://www.luxmanual.com>

<http://aubethermostatmanual.com>

Golf course search by state

<http://golfingnear.com>

Email search by domain

<http://emailbydomain.com>

Auto manuals search

<http://auto.somanuals.com>

TV manuals search

<http://tv.somanuals.com>