

CGP-700

EN/ES

USER'S GUIDE GUÍA DEL USUARIO

Please keep all information for future reference.
Guarde toda información para tener como referencia futura.

Safety Precautions

Before trying to use the Digital Piano, be sure to read the separate "Safety Precautions".

Precauciones de seguridad

Antes de intentar usar el piano digital, asegúrese de leer las "Precauciones de seguridad" separadas.

English

Español

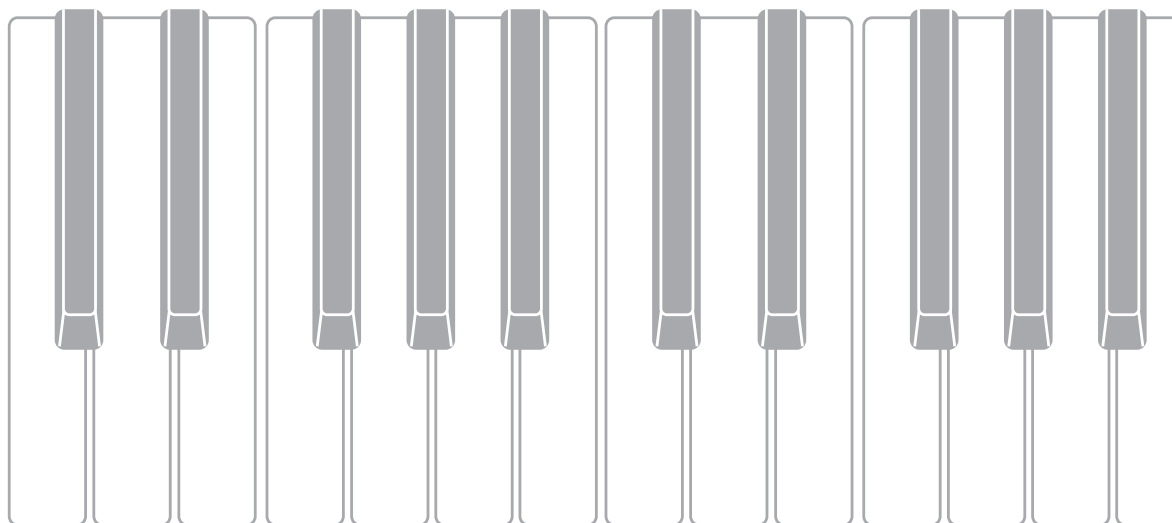

IMPORTANT SAFETY INSTRUCTIONS

1. Read these instructions.
2. Keep these instructions.
3. Heed all warnings.
4. Follow all instructions.
5. Do not use this apparatus near water.
6. Clean only with dry cloth.
7. Do not block any ventilation openings. Install in accordance with the manufacturer's instructions.
8. Do not install near any heat sources such as radiators, heat registers, stoves, or other apparatus (including amplifiers) that produce heat.
9. Do not defeat the safety purpose of the polarized or grounding-type plug. A polarized plug has two blades with one wider than the other. A grounding type plug has two blades and a third grounding prong. The wide blade or the third prong are provided for your safety. If the provided plug does not fit into your outlet, consult an electrician for replacement of the obsolete outlet.
10. Protect the power cord from being walked on or pinched particularly at plugs, convenience receptacles, and the point where they exit from the apparatus.
11. Only use attachments/accessories specified by the manufacturer.
12. Use only with the cart, stand, tripod, bracket, or table specified by the manufacturer, or sold with the apparatus. When a cart is used, use caution when moving the cart/apparatus combination to avoid injury from tip-over.
13. Unplug this apparatus during lightning storms or when unused for long periods of time.
14. Refer all servicing to qualified service personnel. Servicing is required when the apparatus has been damaged in any way, such as power-supply cord or plug is damaged, liquid has been spilled or objects have fallen into the apparatus, the apparatus has been exposed to rain or moisture, does not operate normally, or has been dropped.



The apparatus shall not be exposed to dripping or splashing and that no objects filled with liquids, such as vases, shall be placed on the apparatus.

The  (POWER) indicator being unlit does not mean the apparatus is completely disconnected from the MAINS. When you need to have the apparatus completely disconnected from the MAINS, you must unplug the power cord. For that purpose, locate the apparatus in a way that secures easy access to the power cord.

Declaration of Conformity

Model Number: CGP-700
Trade Name: CASIO COMPUTER CO., LTD.
Responsible party: CASIO AMERICA, INC.
Address: 570 MT. PLEASANT AVENUE, DOVER, NEW JERSEY 07801
Telephone number: 973-361-5400

This device complies with Part 15 of the FCC Rules, Operation is subject to the following two conditions:

(1) This device may not cause harmful interference, and (2) this device must accept any interference received, including interference that may cause undesired operation.

NOTICE

This equipment has been tested and found to comply with the limits for a Class B digital device, pursuant to Part 15 of the FCC Rules. These limits are designed to provide reasonable protection against harmful interference in a residential installation. This equipment generates, uses and can radiate radio frequency energy and, if not installed and used in accordance with the instructions, may cause harmful interference to radio communications. However, there is no guarantee that interference will not occur in a particular installation. If this equipment does cause harmful interference to radio or television reception, which can be determined by turning the equipment off and on, the user is encouraged to try to correct the interference by one or more of the following measures:

- Reorient or relocate the receiving antenna.
- Increase the separation between the equipment and receiver.
- Connect the equipment into an outlet on a circuit different from that to which the receiver is connected.
- Consult the dealer or an experienced radio/TV technician for help.

FCC WARNING

Changes or modifications not expressly approved by the party responsible for compliance could void the user's authority to operate the equipment.

Important!

Please note the following important information before using this product.

- Before using the AD-E24250LW Adaptor to power the product, be sure to check the AC Adaptor for any damage first. Carefully check the power cord for breakage, cuts, exposed wire and other serious damage. Never let children use an AC adaptor that is seriously damaged.
- The product is not intended for children under 3 years.
- Use only the CASIO AD-E24250LW adaptor.
- The AC adaptor is not a toy.
- Be sure to disconnect the AC adaptor before cleaning the product.

Declaration of Conformity According to EU Directive



Manufacturer:
CASIO COMPUTER CO., LTD.
6-2, Hon-machi 1-chome, Shibuya-ku, Tokyo 151-8543, Japan
Responsible within the European Union:
Casio Europe GmbH
Casio-Platz 1, 22848 Norderstedt, Germany
www.casio-europe.com

Contents

Getting Ready	EN-55
Assembling the Stand	EN-55
Using the Anti-tipping Brackets	EN-57
Removing the Protective Tape from the Keyboard	EN-58
Installing the Music Stand	EN-58
General Guide	EN-4
Saving Settings and Using Panel Lock	EN-6
Returning the Digital Piano to Its Factory Default Settings	EN-6
Power Outlet	EN-7
Using an AC Adaptor	EN-7
Turning Power On or Off	EN-7
Connections	EN-8
Connecting Headphones	EN-8
Connecting a Pedal	EN-8
Connecting Audio Equipment or an Amplifier	EN-9
Bundled and Optional Accessories	EN-10
Operations Common to All Modes	EN-11
Using the Display Screen	EN-11
Performing Operations	EN-12
Playing with Different Tones	EN-14
Selecting and Playing a Tone	EN-14
Splitting the Keyboard between Two Tones	EN-15
Layering Two Tones	EN-16
Splitting the Keyboard for Duet Play	EN-16
Adjusting the Keyboard Volume Balance	EN-17
Using the Metronome	EN-18
Changing the Tempo Setting	EN-18
Using the Pitch Bend Wheel	EN-19
Shifting the Pitch of the Digital Piano in Semitone Units (Transpose)	EN-19
Using Auto Accompaniment	EN-20
Playing an Auto Accompaniment	EN-20
Using Recommended Tones and Tempos (One-Touch Presets)	EN-23
Adding Harmony to Melody Notes (Auto Harmonize)	EN-24
Demo Song	EN-25
Playing the Demo Tunes	EN-25
Music Presets	EN-26
Recalling Preset Data	EN-26
Registering Tone and Rhythm Setups	EN-27
Recording and Playback	EN-29
Recording to Digital Piano Memory (MIDI Recorder)	EN-31
Recording to a USB Flash Drive (Audio Recorder)	EN-38
Configuring Digital Piano Settings	EN-41
Configuring Digital Piano Settings	EN-41
USB Flash Drive	EN-49
Connecting a USB Flash Drive to and Detaching It from the Digital Piano	EN-50
Formatting a USB Flash Drive	EN-50
Saving Standard Song Data to a USB Flash Drive	EN-50
Saving Digital Piano Data to a USB Flash Drive	EN-51
Loading Data from a USB Flash Drive to Digital Piano Memory	EN-51
Deleting Data from a USB Flash Drive	EN-52
Connecting to a Computer	EN-53
Minimum Computer System Requirements	EN-53
Using MIDI	EN-54
Reference	EN-59
Error Messages	EN-59
Troubleshooting	EN-60
Product Specifications	EN-62
Operating Precautions	EN-64

Appendix **A-1**

Tone List	A-1
Drum Assignment List	A-6
Rhythm List	A-8
Music Preset List	A-10
Fingering Guide	A-12
Parameter List	A-14
Chord Example List	A-15
Part and MIDI Channel Assignments	A-17







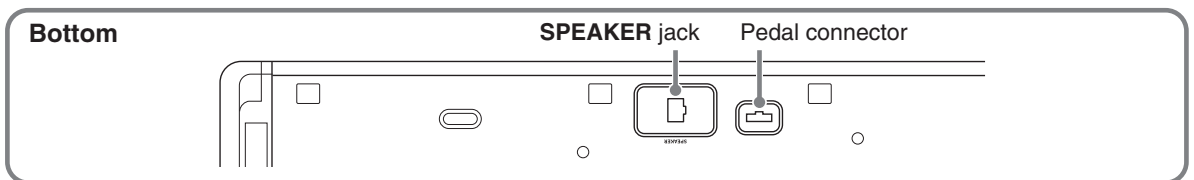
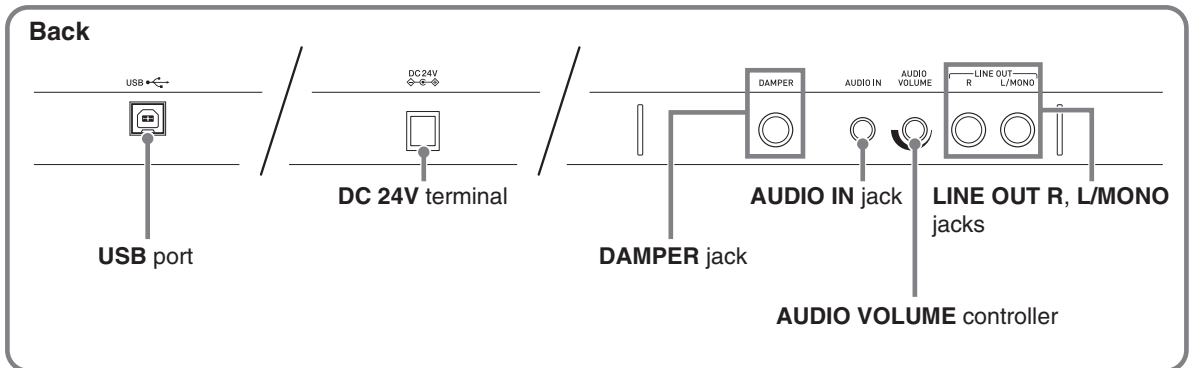
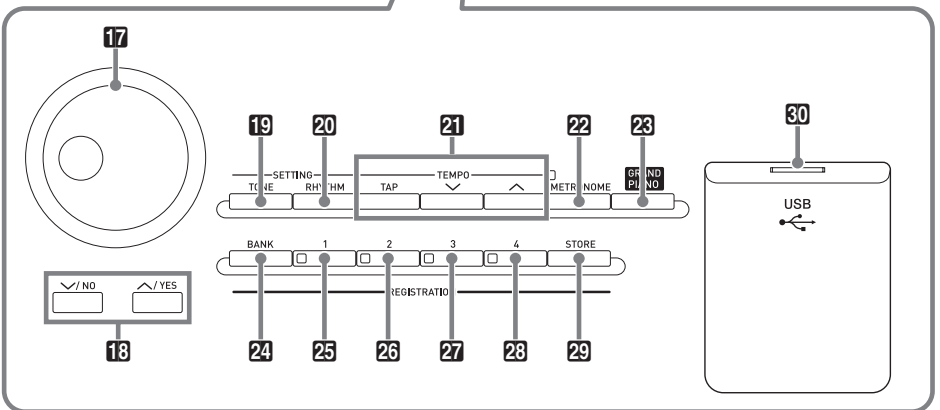
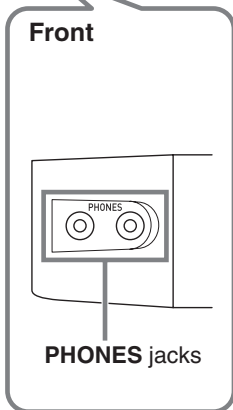
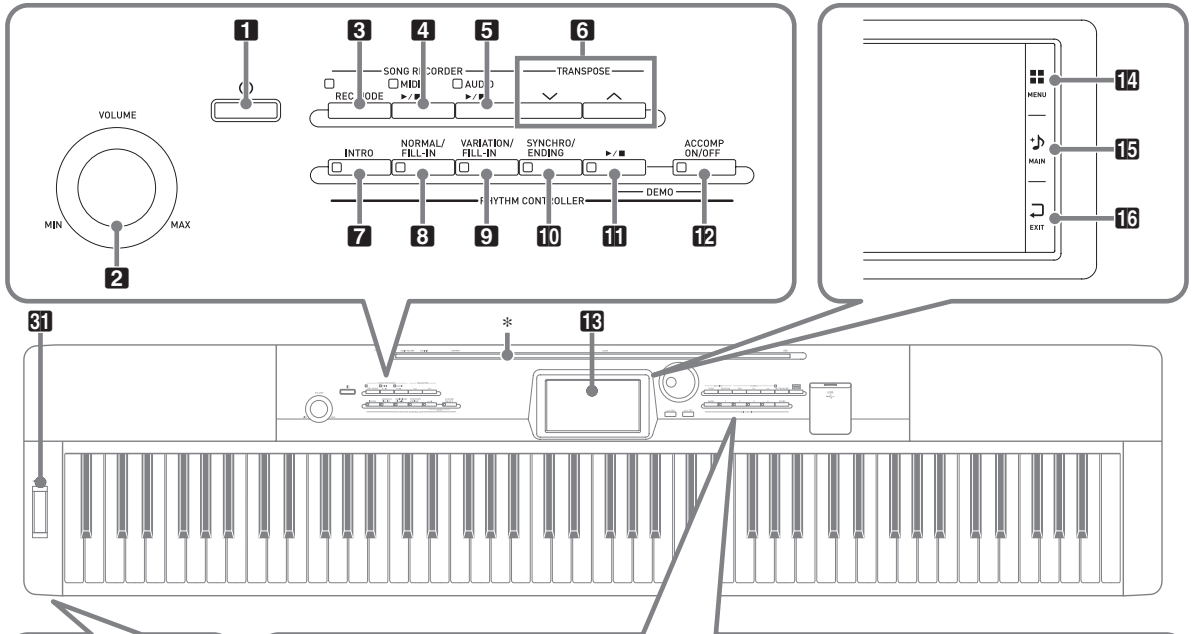

MIDI Implementation Chart

Company and product names used in this manual may be registered trademarks of others.

General Guide



- This manual uses the numbers and names below to refer to buttons and controllers.

- 1**  (Power) button
- 2** **VOLUME** controller
- 3** **REC MODE** button
- 4** **MIDI**  button
- 5** **AUDIO**  button
- 6** **TRANSPOSE** ,  button
- 7** **INTRO** button
- 8** **NORMAL/FILL-IN** button
- 9** **VARIATION/FILL-IN** button
- 10** **SYNCHRO/ENDING** button
- 11**  button
- 12** **ACCOMP ON/OFF** button
- 13** Display
- 14** **MENU**
- 15** **MAIN**
- 16** **EXIT**
- 17** Dial
- 18** ,  buttons
- 19** **TONE** button
- 20** **RHYTHM** button
- 21** **TEMPO** buttons
- 22** **METRONOME** button
- 23** **GRAND PIANO** button
- 24** **BANK** button
- 25** **REGISTRATION 1** button
- 26** **REGISTRATION 2** button
- 27** **REGISTRATION 3** button
- 28** **REGISTRATION 4** button
- 29** **STORE** button
- 30** **USB** flash drive port
- 31** **PITCH BEND** wheel

Saving Settings and Using Panel Lock

Your Digital Piano lets you save its current settings, and lock its buttons to protect against operation errors. For details, see “Auto Resume” (page EN-46) and “Operation Lock” (page EN-46).

Returning the Digital Piano to Its Factory Default Settings

Perform the following procedure when you want to return the Digital Piano’s stored data and settings to their initial factory defaults.

1. Turn off the Digital Piano.
2. While holding down the **TEMPO** \vee , \wedge buttons, press the **1** ⏻ button.
 - The Digital Piano will turn on and initialize its internal system. You will be able to use the Digital Piano in a short while.

NOTE

- See “Turning Power On or Off” (page EN-7) for information about turning power on and off.

Power Outlet

Your Digital Piano runs on standard household power. Be sure to turn off power whenever you are not using the Digital Piano.

Using an AC Adaptor

Use only the AC adaptor (JEITA Standard, with unified polarity plug) that comes with this Digital Piano. Use of a different type of AC adaptor can cause malfunction of the Digital Piano.

Specified AC Adaptor: AD-E24250LW

- Use the supplied power cord to connect the AC adaptor as shown in the illustration below.

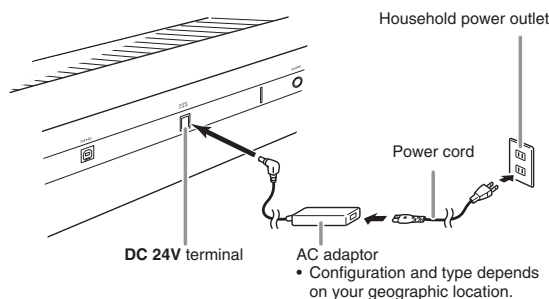

Note the following important precautions to avoid damage to the power cord.

During Use

- Never pull on the cord with excessive force.
- Never repeatedly pull on the cord.
- Never twist the cord at the base of the plug or connector.

During Movement

- Before moving the Digital Piano, be sure to unplug the AC adaptor from the power outlet.

During Storage

- Loop and bundle the power cord, but never wind it around the AC adaptor.

IMPORTANT!

- Never connect the AC adaptor (JEITA Standard, with unified polarity plug) that comes with this Digital Piano to any other device besides this Digital Piano. Doing so creates the risk of malfunction.
- Make sure the Digital Piano is turned off before plugging in or unplugging the AC adaptor.
- The AC adaptor will become warm to the touch after very long use. This is normal and does not indicate malfunction.
- Use the AC adaptor so its label surface is pointed downwards. The AC adaptor becomes prone to emitting electromagnetic waves when the label surface is facing upwards.

Turning Power On or Off

1. Press the **1**  button to turn on power.

- Do not touch the keyboard, pedals, or buttons while the startup screen is on the display. Doing so will cause malfunction.



- Use the Digital Piano's **VOLUME** controller (**2**) to adjust the volume.

2. To turn off the Digital Piano, hold down the **1**  button until the Digital Piano's display goes blank.

NOTE

- Pressing the **1**  button to turn off power actually puts the Digital Piano into a standby state. Minute amounts of current continue to flow within the Digital Piano in the standby state. If you do not plan to use the Digital Piano for a long time or if there is a lightning storm in your area, be sure to unplug the AC adaptor from the power outlet.

Auto Power Off

This Digital Piano is designed to turn off automatically to avoid wasting power after no operation is performed for a preset amount of time. The Auto Power Off trigger time is about four hours.

NOTE

- You can disable Auto Power Off, if you want. For details, see "Auto Power Off" under "SYSTEM SETTING Screen" (page EN-45).

Connections

Connecting Headphones

IMPORTANT!

- Before connecting headphones, be sure to use the Digital Piano's **2 VOLUME** controller to turn the volume down to a low level. After connecting, you can adjust the volume to the level you want.
- While sound output from the speakers is disabled,* the Digital Piano automatically optimizes sound for headphones and **LINE OUT** listening. During speaker output, it automatically switches to optimization for listening with speakers.

* Plug inserted into the **PHONES** jack or "Speaker" SYSTEM SETTING Screen (page EN-45) turned off.

Front

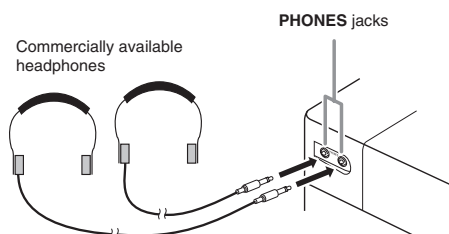

Connect commercially available headphones to the **PHONES** jacks. Connecting headphones to either of the **PHONES** jacks cuts off output to the speakers, which means you can practice even late at night without bothering others. To protect your hearing, make sure that you do not set the volume level too high when using headphones.

NOTE

- Be sure to push the headphones plug into the **PHONES** jacks as far as it will go. If you don't, you may hear sound from only one side of the headphones.
- If the plug of the headphones you are using does not match the **PHONES** jacks, use the applicable commercially available adaptor plug.
- If you are using headphones that require an adaptor plug, make sure you do not leave the adaptor plugged in when you unplug the headphones. If you do, nothing will sound from the speakers when you play.

Connecting a Pedal

Pedal Connector

You can connect the supplied 3-Pedal Unit (SP-33) to the pedal connector on the bottom of the Digital Piano. You can then use the pedals for expression that is similar to that available on an acoustic piano.

Bottom

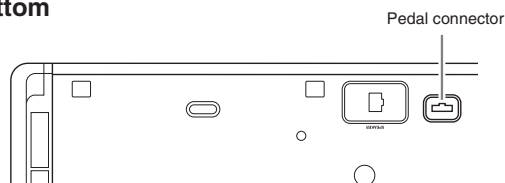

DAMPER jack

Connecting the optionally available pedal (SP-3) to the **DAMPER** jack makes it possible to use the pedal as a damper pedal.

Pressing the damper pedal while playing will cause the notes you play to reverberate for a long time.

- When a GRAND PIANO tone is selected as the tone, pressing this pedal will cause notes to reverberate just like the damper pedal on an acoustic grand piano.

Back

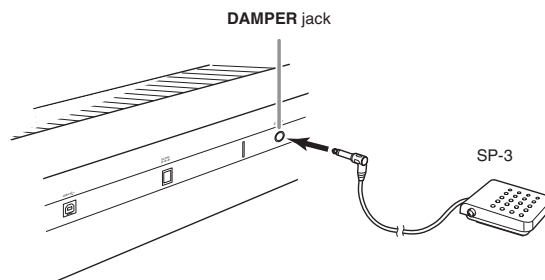

Connecting Audio Equipment or an Amplifier

You can connect audio equipment or a music amplifier to the Digital Piano and then play through external speakers for more powerful volume and better sound quality.

IMPORTANT!

- While sound output from the speakers is disabled,* the Digital Piano automatically optimizes sound for headphones and **LINE OUT** listening. During speaker output, it automatically switches to optimization for listening with speakers.
* Plug inserted into the **PHONES** jack or "Speaker" SYSTEM SETTING Screen (page EN-45) turned off.
- Whenever connecting a device to the Digital Piano, first use the **VOLUME** controller to set the volume to a low level. After connecting, you can adjust the volume to the level you want.
- Whenever you connect any device to the Digital Piano, be sure to read the user documentation that comes with the device.

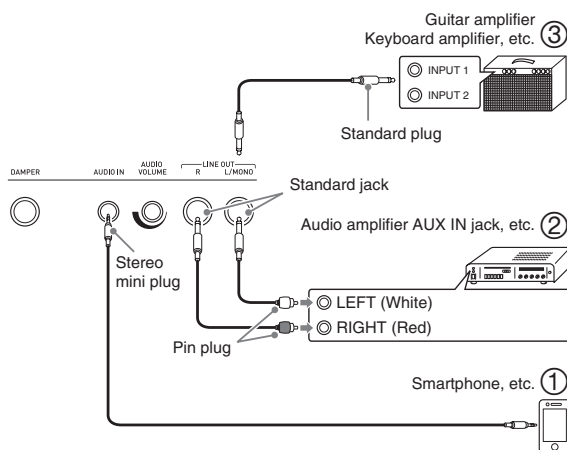

Using the Digital Piano to Produce Sounds from an External Source (Figure ①)

You can connect a smartphone or other music player to **AUDIO IN**.

Use the **AUDIO VOLUME** knob to adjust the volume level from the music player.

NOTE

- Digital Piano built-in effects (reverb, chorus, DSP) are not applied to **AUDIO IN** terminal input. **AUDIO IN** input cannot be recorded with the Audio Recorder.

Connecting to Audio Equipment (Figure ②)

Use commercially available cables to connect the external audio equipment to the Digital Piano's **LINE OUT** jacks as shown in Figure ②. **LINE OUT R** jack output is right channel sound, while **LINE OUT L/MONO** jack output is left channel sound. It is up to you to purchase connecting cables like the ones shown in the illustration for connection of audio equipment. Normally in this configuration you must set the audio equipment's input selector to the setting that specifies the terminal (such as AUX IN) to which the Digital Piano is connected. Use the Digital Piano's **VOLUME** controller to adjust the volume level.

Connecting to a Musical Instrument Amplifier (Figure ③)

Use commercially available cables to connect the amplifier to the Digital Piano's **LINE OUT** jacks as shown in Figure ③. **LINE OUT R** jack output is right channel sound, while **LINE OUT L/MONO** jack output is left channel sound. Connecting to the **LINE OUT L/MONO** jack only outputs a mixture of both channels. It is up to you to purchase a connecting cable like the one shown in the illustration for connection of the amplifier. Use the Digital Piano's **VOLUME** controller to adjust the volume level.

IMPORTANT!

- When using the **LINE OUT** jacks, also connect headphones to the **PHONES** jacks. This will switch the **LINE OUT** output to appropriate sound quality.
- If you are using the Digital Piano in a stand-alone configuration (not mounted on its stand), be sure to change the "External Speaker" **SYSTEM SETTING** to Off. For details, see "SYSTEM SETTING Screen" under "Configuring Digital Piano Settings" (pages EN-41 through EN-48).

Bundled and Optional Accessories

Use only accessories that are specified for use with this Digital Piano.

Use of unauthorized accessories creates the risk of fire, electric shock, and personal injury.

NOTE

- You can get information about accessories that are sold separately for this product from the CASIO catalog available from your retailer, and from the CASIO website at the following URL.
<http://world.casio.com/>

Operations Common to All Modes

Using the Display Screen

Display Screen Layout

When you turn on the Digital Piano, a MENU screen and a MAIN screen (which shows the current setup) appear on the display. You can use these screens to configure a variety of different functions. A quick palette of navigation icons along the right side of the display are for navigating between screens.

■ MENU screen

Touching a menu icon displays a screen for configuring tone, rhythm, and other settings.

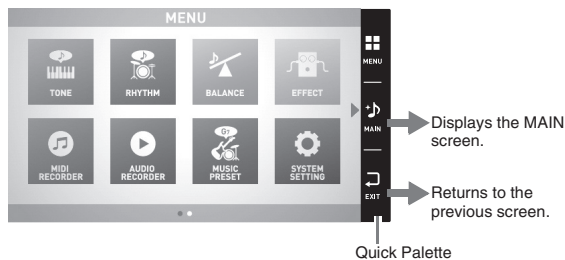

■ MAIN screen

The MAIN screen is for checking and modifying main settings. Current settings are shown along the bottom of the screen.

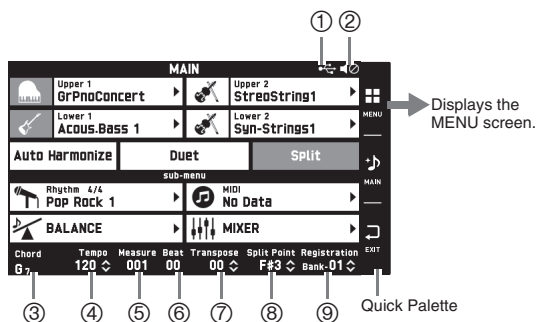

- ① USB flash drive mounted
- ② Speakers off
- ③ Chord
- ④ Tempo
- ⑤ Measure
- ⑥ Beat
- ⑦ Transpose
- ⑧ Split point
- ⑨ Registration bank

■ Quick Palette

The Quick Palette is always displayed along the right side of the screen. Touch the Quick Palette icons to navigate between screens.

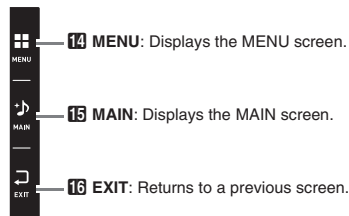

Screen Contents

You can tell the currently selected items and operation enabled icons by their colors;

- Red: Currently selected or turned on
- Blue: Operation enabled

Example: "Soft Rock" selected in the Rock group.

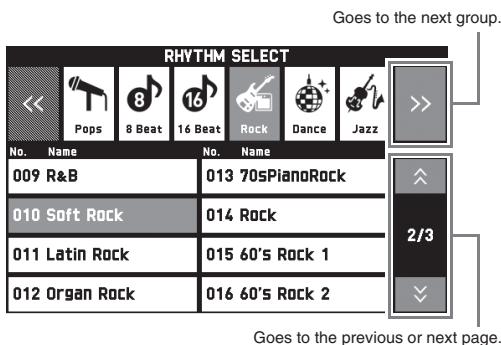

Performing Operations

To use the touch panel

Your Digital Piano has a touch panel. You can use the touch panel to configure a variety of different functions.

IMPORTANT!

- Do not perform touch panel operations with a sharp or hard pointed object. Doing so can damage the LCD.

Touch

Press the display lightly with your finger.

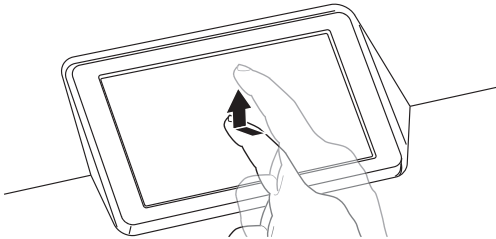

Swipe

Swipe the display from left to right with your finger. Swiping a MENU screen changes to another page of menu items.

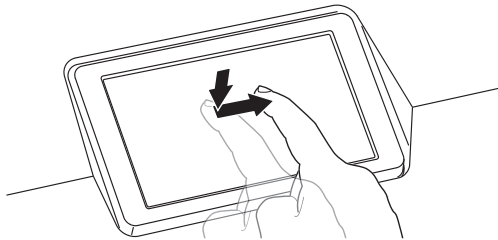

To input text characters

You can touch the keys of an on-screen touch keyboard to input data file names. The Digital Piano supports input of alpha characters and symbols.

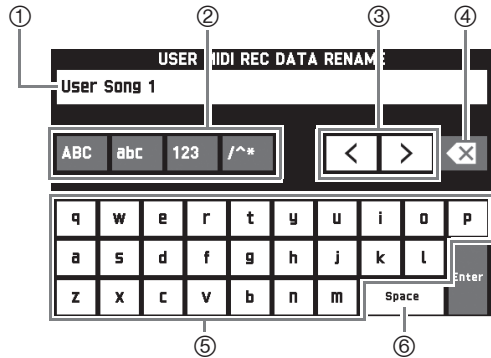

- Shows the letters you input.
- Selects the character type.
- Moves the cursor forward and back.
- Deletes the letter to the left at the cursor.
- Input letters at the cursor position.
- Inputs a space at the cursor position.

To select an item in a list

An item that can be selected using a list is indicated by the “▶” icon.

1. Touch the item whose setting you want to change.

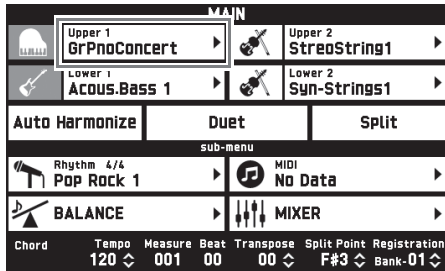

2. On the list that appears, touch the item to which you want to change.

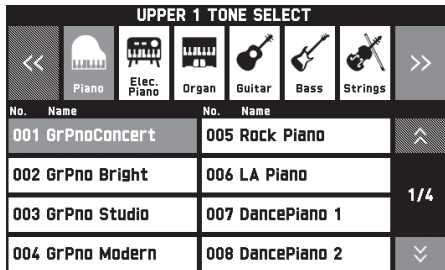

To change a setting value

A setting value that can be changed is indicated by a “◊” icon.

1. Touch the item whose setting you want to change.

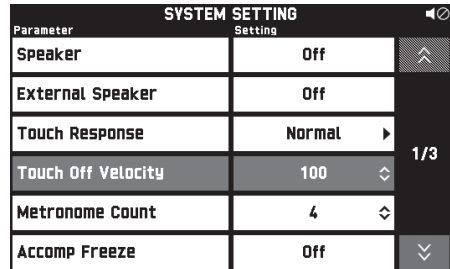

2. Use the **17** Dial or the **18** ▼, ▲ buttons to change setting value.

- Holding down either of the **18** ▼, ▲ buttons scrolls through values at high speed.

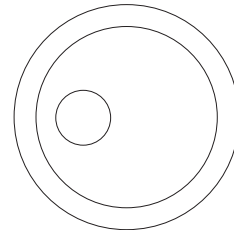

To toggle a function on or off

To toggle a function between on or off, touch its item or icon.

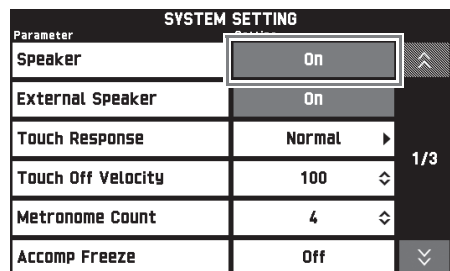

Playing with Different Tones

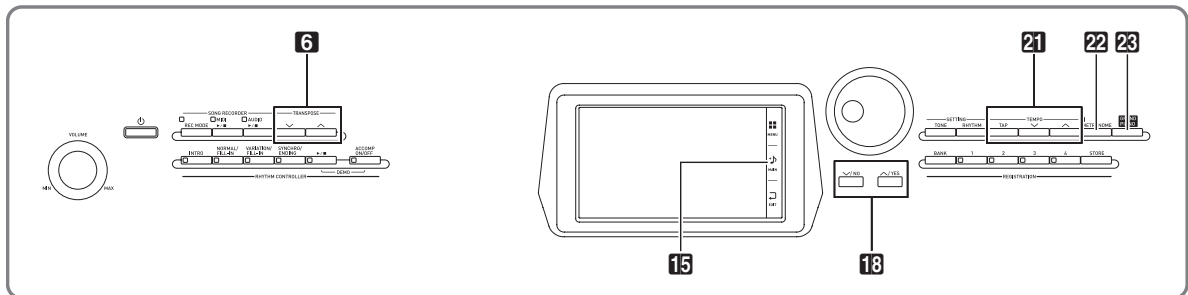

Selecting and Playing a Tone

Your Digital Piano has 550 tones. Tones are divided into 12 groups.

- For more information, see the "Tone List" (page A-1).

1. On the screen, touch **15** MAIN.

This displays the MAIN screen.

2. Touch the "Upper 1" tone.

This displays the TONE SELECT screen.

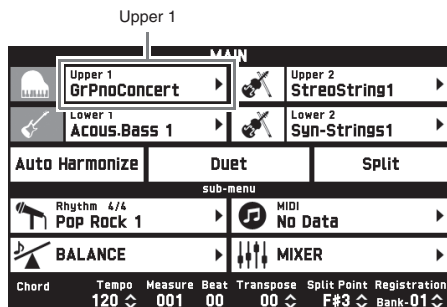

3. Touch the group that contains the tone you want to use.

- You can navigate between groups by touching "<<<" or ">>>".

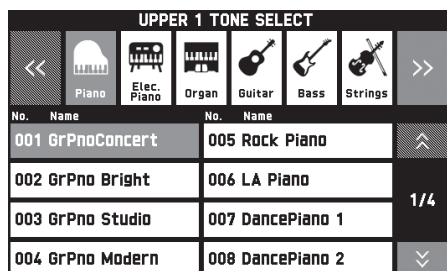

4. Touch the tone you want to use.

- You can navigate between tone list pages by touching "▲" or "▼".

5. On the screen, touch **15** MAIN to return to the MAIN screen.

NOTE

- Touching the Upper 1 icon to turn it off will deselect the keyboard tone so nothing will sound on the keyboard.
- Pressing the **23** GRAND PIANO button will switch to the grand piano tone and reconfigure Digital Piano settings so they are optimized for grand piano play. For details about these settings, see "Parameter List" (page A-14).

Splitting the Keyboard between Two Tones

You can split the keyboard so the left side (lower range) plays one tone and the right side (upper range) plays a different tone.

- On a split keyboard, a tone assigned to the low range is called a “split tone” (Lower 1).

Example: When “GM Slap Bass 1” is selected as the split tone

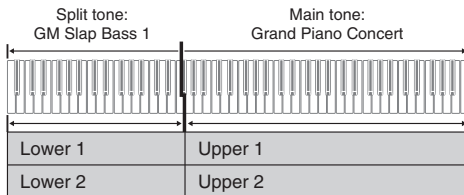

- On the screen, touch **15** MAIN.

This displays the MAIN screen.

- Select the main tone.

- On the MAIN screen, touch “Split”.

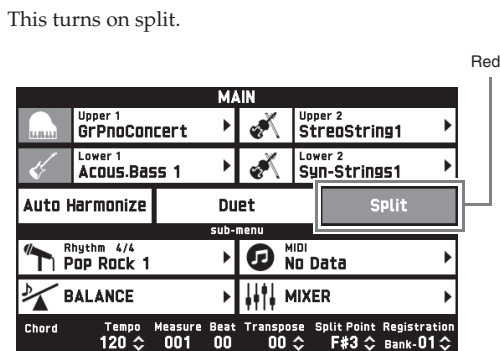

- Touch “Lower 1”.

This displays the TONE SELECT screen.

- Touch the group that contains the tone you want to use as the split tone.

- Touch the tone you want to use as the split tone.

- On the screen, touch **15** MAIN to return to the MAIN screen.

- To unsplit the keyboard and return it to a single tone, touch “Split” on the MAIN screen.

This unsplit the keyboard.

NOTE

- You can layer both the main tone and the split tone with another by turning on layer (page EN-16). You can also configure the layer setting after turning on the split.
- Turning off Upper 1, Upper 2, Lower 1, or Lower 2 by touching its icon will mute the applicable tone.
- When tones with DSP are assigned as both the main tone and the split tone, the effect of one of the tones becomes disabled.

To move the keyboard split point

You can use the procedure below to specify the location on the keyboard where it splits between the left side and the right side. That location is called the “split point”.

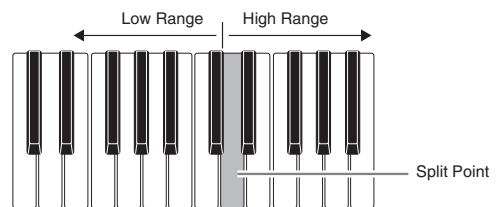

- On the screen, touch **15** MAIN.

This displays the MAIN screen.

- Touch “Split Point”.

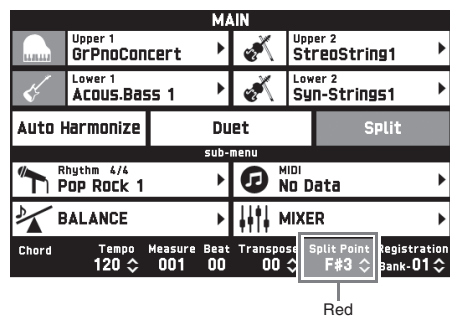

- Use the **18** ∇ , \blacktriangle buttons to specify the split point, which is the leftmost key of the upper range.

- You can also specify the split point by touching and holding “Split Point” as you press the desired keyboard key.

Layering Two Tones

You can layer two different tones so they play at the same time when you press a keyboard key.

- The Upper 1 tone is called the “main tone”, while the Upper 2 tone is called the “layered tone”.

1. On the screen, touch **15** MAIN.

This displays the MAIN screen.

2. Select the main tone.

3. Touch the Upper 2 icon.

This turns on layer and layers the two tones.

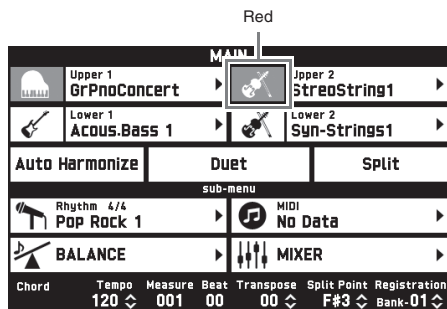

4. Touch the “Upper 2” tone.

This displays the TONE SELECT screen.

5. Touch the group that contains the tone you want to use as the layer tone.

6. Touch the tone you want to use as the layer tone.

7. On the screen, touch **15** MAIN to return to the MAIN screen.

8. To unlayer the keyboard and return to a single tone, touch the Upper 2 icon on the MAIN screen.

This unlayers the tones.

NOTE

- You can adjust the balance between the main tone and layered tone. See “Adjusting the Keyboard Volume Balance” (page EN-17).
- Touching the Upper 1 or Upper 2 icon will turn off the applicable tone so it does not sound.
- When tones with DSP are assigned as both the main tone and the layered tone, the effect of one of the tones becomes disabled.

Splitting the Keyboard for Duet Play

You can split the keyboard in the center for duet play so the left and right sides have the same ranges. The left outer pedal operates as the left side damper pedal, while the right outer pedal is the right side damper pedal.

The duet play can be used with the teacher showing how to play on the left side as the student plays the same melody on the right side.

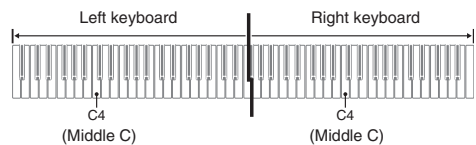

Pedals

● Using the Provided SP-33 Pedal Unit

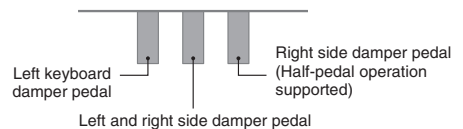

● Using the Optional SP-3 Pedal Unit

With this type of pedal, the damper effect is applied to both the left and right keyboards.

1. On the screen, touch **15** MAIN.

This displays the MAIN screen.

2. Touch “Duet”.

This turns on duet play.

- Touch “Pan” to turn on Duet Pan. While Duet Pan is enabled (on), the left side keyboard tone is output from the left speaker, while the right side keyboard tone is output from the right speaker. The effects below are not applied.
 - Acoustic Simulator
 - Reverb
 - Delay
 - Chorus
 - DSP

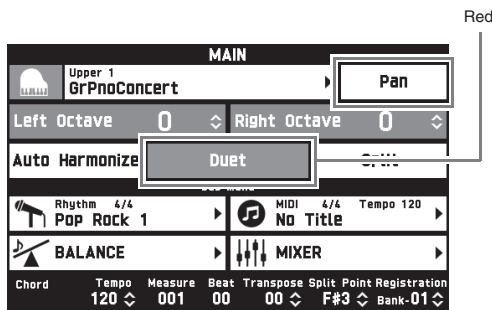

3. To turn off duet play, touch “Duet” again.

The returns to the state in effect before you turned on duet play.

To change the octave of a Duet Mode keyboard (Duet Octave Shift)

You can use the following procedure to change the octave of the left and right Duet Mode keyboards.

1. Perform steps 1 and 2 of the procedure under “Splitting the Keyboard for Duet Play”.
2. Touch “Left Octave” and then use the **18** \downarrow , \uparrow buttons to change the octave of the left keyboard.

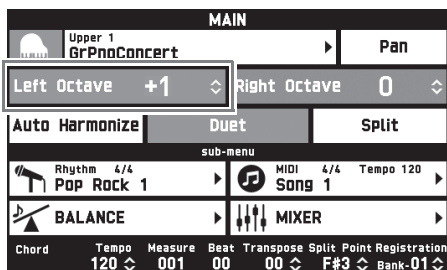

Example: The illustration below shows how changing the left octave shift setting to “+1” affects the left keyboard octave.

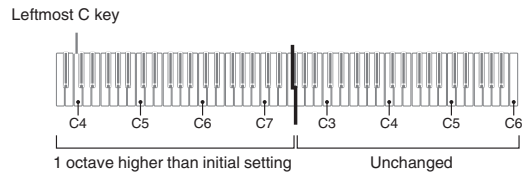

3. Touch “Right Octave” and then use the **18** \downarrow , \uparrow buttons to change the octave of the right keyboard.

NOTE

- Turning off duet play clears octave shift settings and returns the keyboard to its initial default octave settings.

Adjusting the Keyboard Volume Balance

Use this procedure to adjust the volume balance between the main tone and the layered tone.

1. On the screen, touch **15** MAIN. This displays the MAIN screen.
2. Touch “BALANCE”.
3. Touch the tone you want to adjust and then use the **18** \downarrow , \uparrow buttons to adjust volume.
 - Upper 1: Main tone
 - Upper 2: Layered tone
 - Lower 1: Split (main) tone
 - Lower 2: Split (layered) tone
4. On the screen, touch **15** MAIN to return to the MAIN screen.

NOTE

- For other BALANCE screen settings, see “BALANCE Screen” under “Configuring Digital Piano Settings” (pages EN-41 through EN-48).

Using the Metronome

1. Press the **22** METRONOME button.
This starts the metronome.

Flashes in time with the beat.

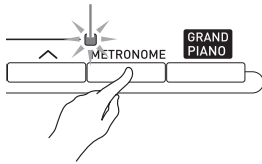

2. Press the **22** METRONOME button again to stop the metronome.
This stops the metronome.

To change the beats per measure

You can specify from 0 to nine beats per measure for the metronome.

Specifying 0 will cause each beat to be indicated by the same sound. This setting lets you practice with a steady beat.

1. On the MENU screen, touch "SYSTEM SETTING".
2. Touch "Metronome Count".
3. Use the **18** \downarrow , \uparrow buttons to select a beats per measure value.
4. On the screen, touch **15** MAIN.
This returns to the MAIN screen.

Adjusting the Balance between Metronome and Keyboard Volume (Metronome Volume)

You can use the following procedure to adjust the volume level of the metronome, without affecting the volume of keyboard output.

1. On the screen, touch **15** MAIN.
This displays the MAIN screen.
2. Touch "BALANCE".
3. Touch "Metronome Volume".
4. Use the **18** \downarrow , \uparrow buttons to adjust the metronome volume setting (0 to 127).
5. On the screen, touch **15** MAIN.
This returns to the MAIN screen.

Changing the Tempo Setting

There are two different methods you can use to change the tempo setting: using the **21** TEMPO \downarrow , \uparrow buttons for gradual change, or by tapping a beat with the **21** TEMPO TAP button (tap input).

- **Method 1:**
To adjust the tempo setting using the **21** TEMPO \downarrow , \uparrow buttons

1. Use the **21** TEMPO \downarrow , \uparrow buttons to adjust the tempo setting.

Each press of a button increases or decreases the tempo value (beats per minute) by one.

- Holding down either button changes the value at high speed.
- You can specify a tempo value in the range of 20 to 255.

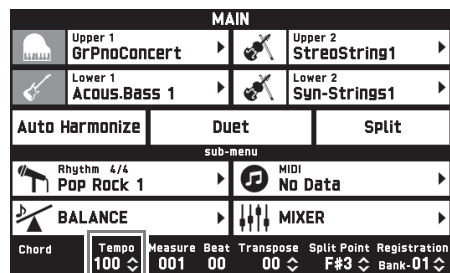

- **Method 2:**
To adjust the tempo by tapping a beat (tap input)

1. Tap the **21** TEMPO TAP button a number of times at the tempo you want to set.
 - The tempo setting will change to the average value of your taps.

Tap two or more times.

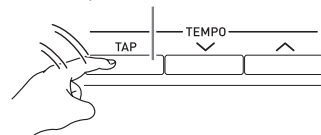

- After you use this method to specify the approximate tempo, you can then use the procedure under "To adjust the tempo setting using the **21** TEMPO \downarrow , \uparrow buttons" to adjust the setting to a more exact value.

Using the Pitch Bend Wheel

You can use the pitch bend wheel to slide the pitch of notes smoothly upwards and downwards. This capability makes it possible to reproduce saxophone and electric guitar choking effects.

1. While playing a note on the keyboard, rotate the pitch bend wheel on the left of the keyboard upwards or downwards.

The amount the note bends depends on how much you rotate the pitch bend wheel.

- Do not touch the pitch bend wheel as you turn on the Digital Piano.



NOTE

- You also can configure pitch bend wheel operation by specifying the amount of pitch change at maximum rotation in either direction. See "CONTROLLER Screen" (page EN-46) for more information.

Shifting the Pitch of the Digital Piano in Semitone Units (Transpose)

The transpose feature lets you raise or lower the overall pitch of the Digital Piano in semitone steps. You can use this feature to adjust keyboard tuning to a key that better matches a vocalist, another musical instrument, etc.

1. Use the **6** TRANSPOSE ∇ , \wedge buttons to change the setting value.
 - You can change the tuning of the keyboard within the range of -12 to 00 to +12.
 - Pressing the **6** TRANSPOSE ∇ , \wedge buttons at the same time changes the setting to 0.
 - The current transpose setting is shown on the MAIN screen.

MAIN					
	Upper 1 GrPnoConcert		Upper 2 StreoString1		
	Lower 1 Acous.Bass 1		Lower 2 Syn-Strings1		
Auto Harmonize		Duet		Split	
sub-menu					
	Rhythm 4/4 Pop Rock 1		MIDI No Data		
	BALANCE		MIXER		
Chord	Tempo 120	Measure 001	Beat 00	Transpose +02	Split Point F#3
					Registration Bank-01

Using Auto Accompaniment

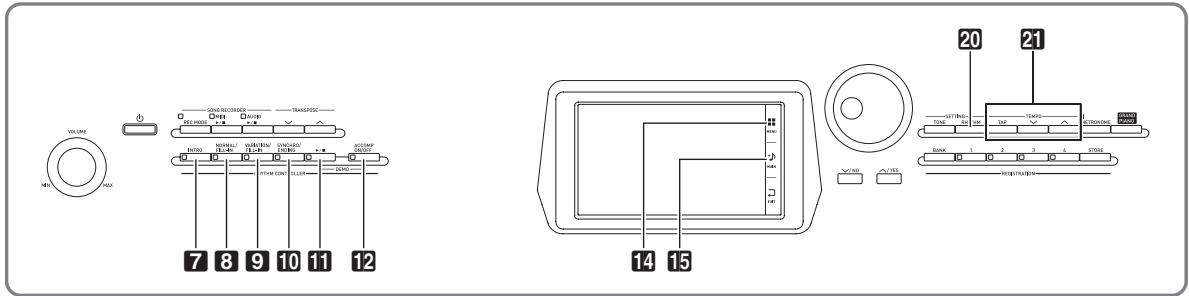

With Auto Accompaniment, simply select the accompaniment rhythm you want and the matching accompaniment (drums, guitar, etc.) will play automatically when you play a chord with your left hand. It's like having your own personal backup group along with you wherever you go.

This Digital Piano has 200 built-in Auto Accompaniment patterns, which are divided into 13 groups. For more information, see the "Rhythm List" (page A-8).

Playing an Auto Accompaniment

1. On the screen, touch **15** MAIN.

This displays the MAIN screen.

2. Touch the "Rhythm" rhythm name.

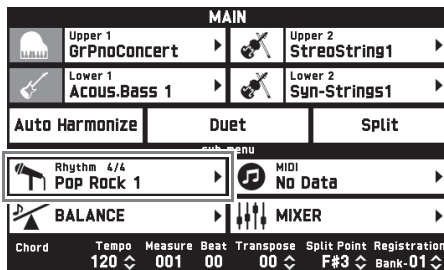

3. Touch the group that contains the rhythm you want to use.

- You can navigate between groups by touching "◀◀" or "▶▶".

RHYTHM SELECT							
<<	Pops	8 Beat	16 Beat	Rock	Dance	Jazz	>>
No.	Name	No.	Name				
009	R&B	013	70sPianoRock			⬆	
010	Soft Rock	014	Rock			2/3	
011	Latin Rock	015	60's Rock 1				
012	Organ Rock	016	60's Rock 2			⬇	

4. Touch the rhythm you want to use.

- You can navigate between rhythm list pages by touching "⬆" or "⬇".

5. Use the **21** TEMPO ∇ , \blacktriangle buttons to adjust the tempo setting.

- For information about the tempo adjustment method, see "Changing the Tempo Setting" (page EN-18).
- To return a rhythm to its recommended tempo setting, press the **21** TEMPO ∇ , \blacktriangle buttons at the same time.

6. Press the **12** ACCOMP ON/OFF button so its lamp is lit.

This turns ACCOMP on, so all accompaniment parts sound.

- Turning ACCOMP off so the ACCOMP lamp is unlit causes only the percussion instrument parts (Drums, Percussion) to sound.
- Each press of the button toggles ACCOMP between on and off.

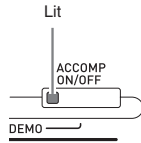

7. Press the **10** SYNCHRO/ENDING button.

This puts Auto Accompaniment into "synchro standby". Playing a chord during synchro standby will cause Auto Accompaniment to start to play automatically.

- Pressing the **7** INTRO button while Auto Accompaniment is in synchro standby will enter intro standby. Pressing the **9** VARIATION button will enter variation standby. For details about intro and variation patterns, see "Modifying Auto Accompaniment Patterns" (page EN-23).

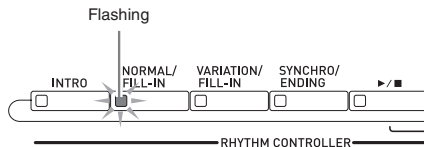

8. Play the chord you want on the chord keyboard (left keyboard keys).

Auto Accompaniment will start playing when you play the chord.

- To start percussion part play without playing a chord, press the **11** ►/■ button.

Example: To play a C chord

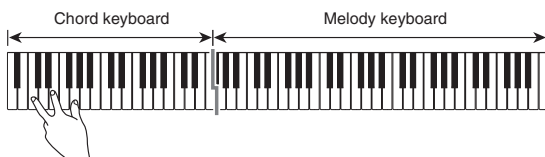

9. Play other chords with your left hand as you play the melody with your right hand.

- You can use "CASIO Chord" or other simplified chord fingering modes to play chords. For details, see "To select a chord fingering mode" in the following section.
- You can use the **8** NORMAL and **9** VARIATION buttons to modify accompaniment patterns. For details, see "Modifying Auto Accompaniment Patterns" (page EN-23).

10. When you are finished, press the **11** ►/■ button again to stop Auto Accompaniment.

- Pressing the **10** SYNCHRO/ENDING button instead of the **11** ►/■ button will play an ending pattern before stopping Auto Accompaniment play. For details about ending patterns, see "Modifying Auto Accompaniment Patterns" (page EN-23).

NOTE

- You can adjust the volume level of the Auto Accompaniment, without affecting the volume of Digital Piano output. For details, see "BALANCE Screen" (page EN-43).
- You can change the size of the chord keyboard by using the split feature to move the split point (page EN-15). The keyboard keys to the left of the split point make up the chord keyboard.

To select a chord fingering mode

You can select from among the following five chord fingering modes.

- Fingered 1
- Fingered 2
- Fingered 3
- CASIO Chord
- Full Range

1. On the MENU screen, touch "RHYTHM".
2. Touch "Chord Input Type".
3. Touch the chord input method you want to use.
This changes to the selected chord input method.

■ Fingered 1, 2, 3

With these three chord fingering modes, you play chords on the chord keyboard using their normal chord fingerings. Some chord forms are abbreviated, and can be fingered with one or two keys. For information about the types of chords you can finger and their fingerings, see the "Fingering Guide" (page A-12).



- Fingered 1: Play the component notes of the chord on the keyboard.
- Fingered 2: Unlike Fingered 1, 6th input is not possible with this mode.
- Fingered 3: Unlike Fingered 1, this mode allows input of fraction chords with the lowest keyboard note as the bass note.

■ CASIO CHORD

With "CASIO Chord", you can use simplified fingerings to play the four types of chords described below.



Chord Type	Example
Major Chords Press one key, whose note corresponds to the chord name. • To play C Major, press any C key in the chord keyboard. The octave of the note does not matter.	C (C Major) Note name J
Minor Chords Press the chord keyboard key that corresponds to the major chord, while also pressing one other chord keyboard key to the right.	Cm (C minor)
Seventh Chords Press the chord keyboard key that corresponds to the major chord, while also pressing two other chord keyboard keys to the right.	C7 (C seventh)
Minor Seventh Chords Press the chord keyboard key that corresponds to the major chord, while also pressing three other chord keyboard keys to the right.	Cm7 (C minor seventh)

When pressing more than one chord keyboard key, makes no difference whether the additional keys are white or black.

■ FULL RANGE CHORD

With this chord fingering mode, you can use the full range of the keyboard to play chords and the melody. For information about the types of chords you can finger and their fingerings, see the "Fingering Guide" (page A-12).



Modifying Auto Accompaniment Patterns

There are six different Auto Accompaniment patterns, shown below. You can switch between patterns during accompaniment play and even modify patterns. Use buttons **7** through **10** to select the pattern you want.

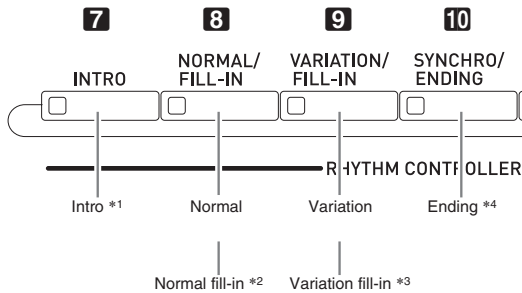

- *1 Press at the beginning of a song.
Accompaniment play proceeds with the normal pattern after the intro pattern is complete. Pressing the **9** VARIATION/FILL-IN button before the intro pattern is finished will proceed with the variation pattern after the intro pattern is complete.
- *2 Press while a normal pattern is playing to insert a fill-in pattern.
- *3 Press while a variation pattern is playing to insert a fill-in variation pattern.
- *4 Press at the end of a song.
This will play an ending pattern and then stop Auto Accompaniment.

Using Recommended Tones and Tempos (One-Touch Presets)

One-Touch Preset gives you one-touch access to tone and tempo settings that go well with the currently selected Auto Accompaniment rhythm pattern.

1. On the MENU screen, touch "RHYTHM".

This displays the RHYTHM screen.

- You can also display the RHYTHM screen by pressing the **20** RHYTHM button.

2. Touch "One Touch".

This configures tone, and other settings to match the currently selected rhythm pattern.

At this time, Auto Accompaniment play also will go into synchro standby, which means that Auto Accompaniment will start to play automatically when you finger a chord.

3. Play a chord on the keyboard.

This will start Auto Accompaniment play.

Adding Harmony to Melody Notes (Auto Harmonize)

Auto Harmonize lets you add harmony to melody notes you play with your right hand for more melodic depth. You can select any one of 12 Auto Harmonize types.

1. On the screen, touch **15 MAIN**.

This displays the MAIN screen.

2. Touch “Auto Harmonize” to turn it on.

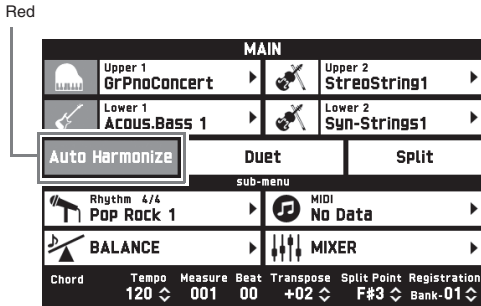

3. Touch **14 MENU**.

4. On the MENU screen, touch “RHYTHM”.

5. Touch “Auto Harmonize Type”.

6. Touch the Auto Harmonize type you want to use.

Type Name	Description
Duet 1	Adds close (separated by two to four degrees) 1-note harmony below the melody note.
Duet 2	Adds open (separated by more than 4 to 6 degrees) 1-note harmony below the melody note.
Country	Adds country style harmony.
Octave	Adds the note from the next lower octave.
5th	Adds the fifth degree note.
3-Way Open	Adds 2-note open harmony, for a total of three notes.
3-Way Close	Adds 2-note close harmony, for a total of three notes.
Strings	Adds harmony that is optimal for strings.
4-Way Open	Adds 3-note open harmony, for a total of four notes.
4-Way Close	Adds 3-note close harmony, for a total of four notes.
Block	Adds block chord notes.
Big Band	Adds big band style harmony.

7. Play chords and the melody on the keyboard.

Harmony will be added to your melody notes based on the chords you play.

Demo Song

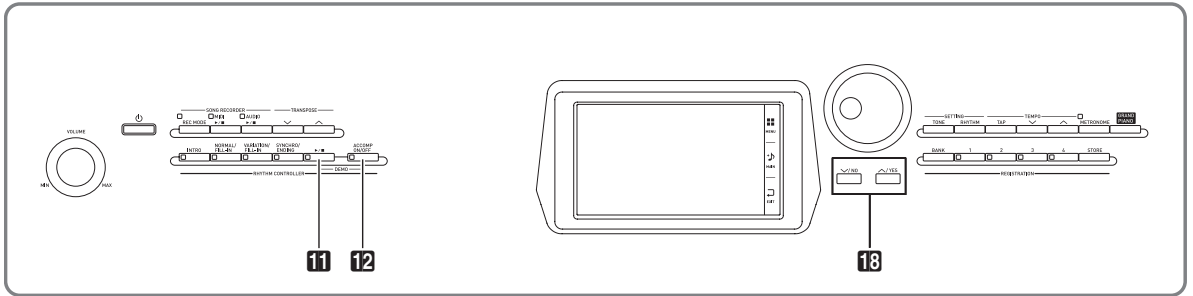

Playing the Demo Tunes

1. While holding down the **12 ACCOMP ON/OFF** button, press the **11 ►/■** button.

This will start sequential playback of the demo songs, starting from song 1.

- You can use the **13** **▼**, **▲** buttons to change to another demo song.

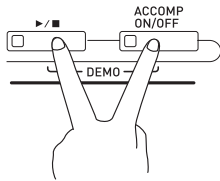

2. Press the **11 ►/■** button.

This stops demo song playback.

Playback of the demo songs will continue in an endless loop until you press the **11 ►/■** button to stop it.

NOTE

- Only the operations described above can be performed while demo song playback is in progress.

Music Presets

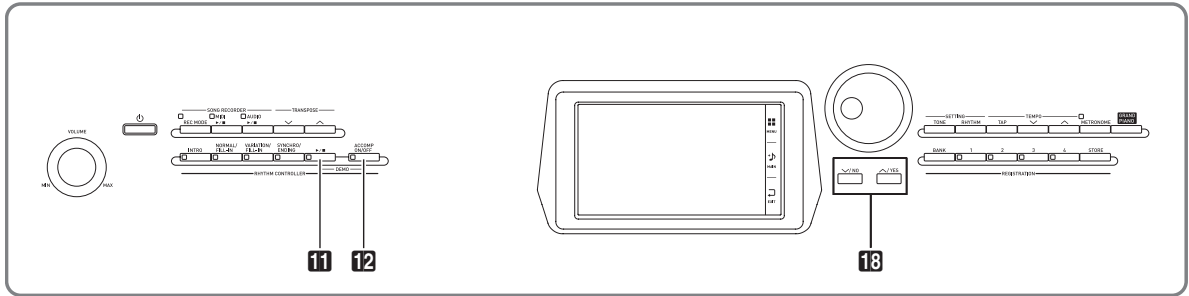

Music Presets provide you with one-touch tone, rhythm, chord, and other settings that are optimized for specific musical genres and songs.

There is a total of 305 built-in music presets, which are divided into nine groups.

- For more information, see the “Music Preset List” (page A-10).

Recalling Preset Data

1. On the MENU screen, touch “MUSIC PRESET”.

This displays the MUSIC PRESET screen and turns on Auto Chord.

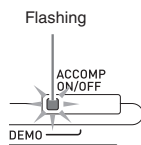

2. Touch the preset name.

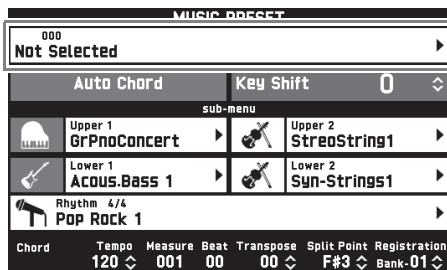

3. Touch the group that contains the preset you want to use and then touch the preset name.

This configures the Digital Piano with the settings (tone, rhythm, etc.) of the selected preset.

4. Press the **11** ►/■ button to start Auto Accompaniment with the preset chord progression. Play the melody on the keyboard.

- The preset chord progression repeats until you stop it by pressing the **11** ►/■ button again.
- Touching “Auto Chord” to turn it off turns off the preset chord progression, which enables play of the normal Auto Accompaniment pattern.
- To change the key of a preset chord progression, touch “Key Shift” and then use the **18** ▼, ▲ buttons to make the change.

NOTE

- To turn off Auto Chord, press the **12** ACCOMP button.
- For details about the settings for a recalled preset, see “Music Preset List” (page A-10).

Registering Tone and Rhythm Setups

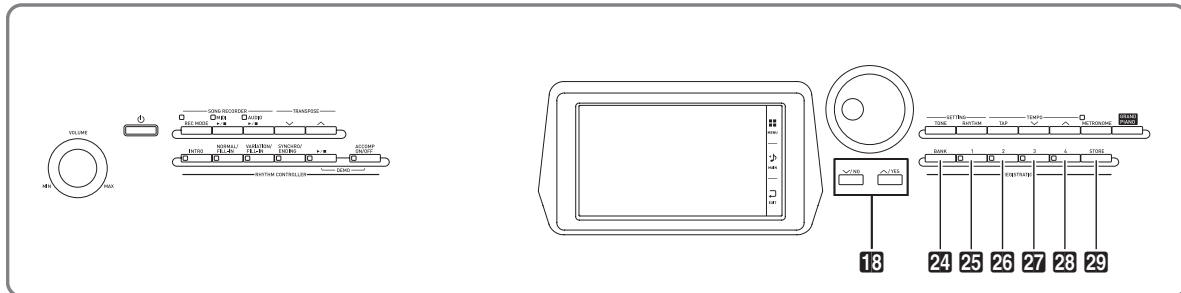

Registration memory lets you store Digital Piano setups (tone, rhythm, etc.) for instant recall whenever you need them. Registration memory simplifies performance of complex pieces that require successive tone and rhythm changes.

You can have up to 96 setups in Registration memory at one time. To select a setup, use the **24** BANK button and **REGISTRATION** buttons **25** through **28**.

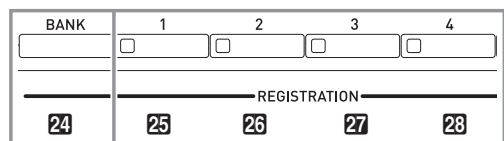

	Area 1	Area 2	Area 3	Area 4
Bank 1	Setup 1-1	Setup 1-2	Setup 1-3	Setup 1-4
Bank 2	Setup 2-1	Setup 2-2	Setup 2-3	Setup 2-4
.
Bank 24	Setup 24-1	Setup 24-2	Setup 24-3	Setup 24-4

- Press the **24** BANK button and then use the **18** ∇ , \wedge buttons to change the bank number.
- Pressing a **REGISTRATION** button (**25** through **28**) selects the corresponding area in the currently selected bank.

NOTE

- For details about these settings, see "Parameter List" (page A-14).

To save registration data

1. Configure the Digital Piano with the tone, rhythm, and other settings you want to save.
2. While holding down the **29** STORE button, perform the operation below.

Use the **18** ∇ , \wedge buttons to select the bank where you want to store the data, and then press a **REGISTRATION** button (**25** through **28**) to specify an area.

The data will be saved to the bank and area you specify.

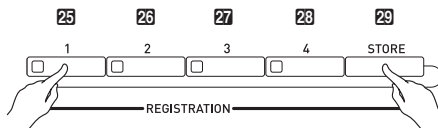

Example: Bank 4, Area 1

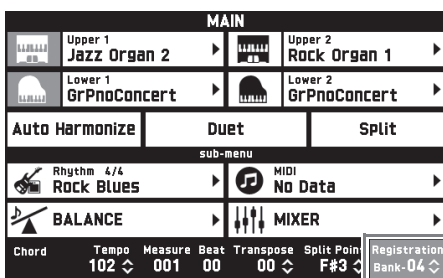

Bank

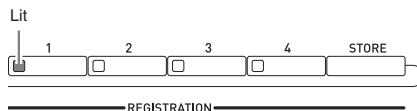

To recall a registration setup

1. Press the **24** **BANK** button to select the bank that contains the setup you want to recall.

- The currently selected bank and area numbers are shown on the MAIN screen and button lamps.

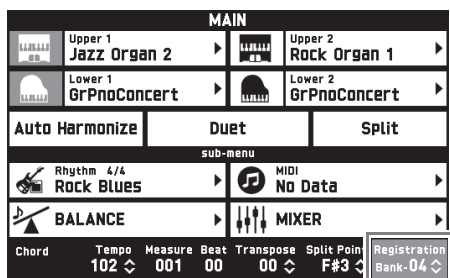
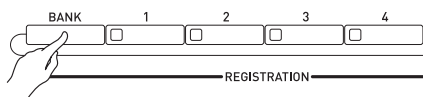

2. Use the **REGISTRATION** buttons (**25** through **28**) to select the area whose setup you want to recall.

This recalls the registration memory setup and automatically configure the Digital Piano settings accordingly.

Example: When recalling the registration data in Bank 4, Area 1





NOTE

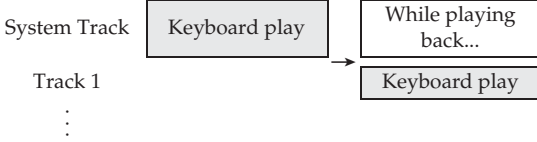

- You can use Accompaniment Freeze to specify accompaniment settings that should be left unchanged whenever a registration setup is applied. For details, see “SYSTEM SETTING Screen” under “Configuring Digital Piano Settings” (pages EN-41 through EN-48).

■ Saving Setup Registration Data to an External Device

See “Connecting to a Computer” (page EN-53).

MIDI Recorder	Audio Recorder
<p>What you can do... Record to one track while playing back from the other track</p> 	<p>What you can do... Record performance while playing back a song recorded with the MIDI Recorder</p>  <p>NOTE</p> <ul style="list-style-type: none"> • AUDIO IN terminal input is not recorded.

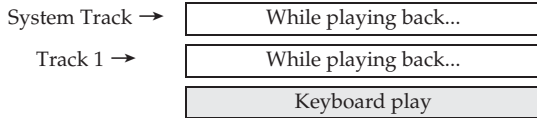
■ Playback Features

MIDI Recorder	Audio Recorder
<p>Playback plays the system track and tracks 1 through 16.</p> <ul style="list-style-type: none"> • With the MIDI Recorder, the Digital Piano automatically performs playback using its internal sound source in accordance with the performance information recorded as MIDI data. <p>What you can do... Play on the keyboard along with playback of tracks</p> 	<p>You can play back audio data from a USB flash drive.</p> <ul style="list-style-type: none"> • The Audio Recorder plays back the waveform of sound recorded as audio data. <p>What you can do... You can play along on the keyboard while the audio data is playing.</p> 

* MIDI

MIDI is short for “Musical Instrument Digital Interface”. It is a universal standard that makes it possible for musical instruments, computers, and other devices to exchange performance information (keyboard key press/release, touch pressure, etc.) regardless of manufacturer. Performance data in this case is called “MIDI data”.

Recording to Digital Piano Memory (MIDI Recorder)

Perform the steps below to record your keyboard play to Digital Piano Memory.

1. Configure the tone, rhythm, and other settings you want to use.

- The settings you configure here will be included as part of the recorded MIDI data.
- For details about what is included in the recorded MIDI data, see “System Track” (page EN-32).

2. On the MENU screen, touch “MIDI RECORDER”.

3. Touch “●”.

This turns on the recorder and enters record mode.

- Each touch of “●” cycles through modes as shown below

Playback mode

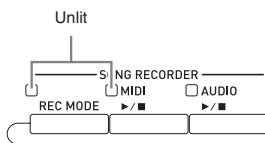
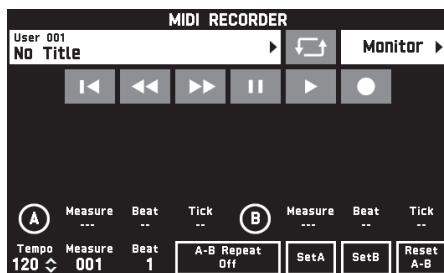

Recording mode

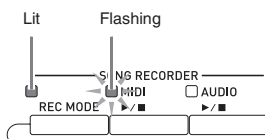
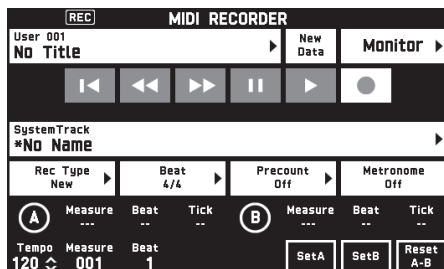

4. Touch “New Data”.

This enables recording of new data to the system track.

5. Play something on the keyboard.

Recording starts as soon as you play something.

- You can also start recording by touching “▶”.
- You also can configure the piano so Auto Accompaniment is included in the recorded data.
- The **4** MIDI ▶/■ button is lit while recording is in progress.

6. After you finish recording, touch “■”.

This causes the **3** REC MODE button and **4** MIDI ▶/■ button lamps to become unlit, and enters the playback mode.

Unlit: Playback mode

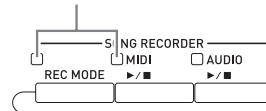

NOTE

- You can also enter the recording mode by pressing the **3** REC MODE button and then touching “MIDI RECORDER”. This method can be used to enter the recording mode only for making a new recording.
- Recording memory capacity is approximately 50,000 notes per song. When remaining capacity is 100 or fewer notes, the **4** MIDI ▶/■ button lamp will flash at high speed. Recording will stop automatically when the allowable limit is reached.

IMPORTANT!

- The Digital Piano has memory for 100 songs.
- If power to the Digital Piano is cut off while recording is in progress, everything you recorded up to that point will be lost. Take care so power is not turned off accidentally during recording operations.

To record to a specific track (Part)

You can record specific instruments, the left hand and right hand, or other parts of a song individually, and then combine them into a final song.

■ What is a track?

A “track” is a separate recorded part of a song. The MIDI Recorder of this Digital Piano has a total of 17 tracks, one of which is a system track as described below.

● System Track

In addition to notes you play on the keyboard and other performance operation data, the system track also includes a wide range of setup information for the song, including layer on/off, split on/off, tempo, Auto Accompaniment settings, reverb type, etc. When you record a single-track song to recorder memory, as shown under “Recording to Digital Piano Memory (MIDI Recorder)” (page EN-31) everything is recorded to the system track.

● Tracks 01 through 16

These tracks can be used to record notes, as well as pitch bend wheel and pedal operations, and the keyboard tone setting. These tracks can be combined with the system track and each other to create the final song.

■ Supported Track Data

The following describes the data that can be recorded to each type of track.

System Track, Tracks 01 through 16

Keyboard performance*¹, the keyboard tone setting*¹, pedal and pitch bend wheel operation, mixer settings (except for part on/off)

System Track only

Rhythm, balance setting, effect setting (reverb, chorus, delay), tempo, Auto Accompaniment performance/setting, one-touch preset, music preset performance*², registration*^{2,3}

*1 Upper 1 only for Tracks 1 through 16

*2 Recall only

*3 The Auto Accompaniment volume level and transpose setting of the recalled data is not included in the recording.

1. Record the first part to the system track.
 - Use the procedure under “Recording to Digital Piano Memory (MIDI Recorder)” (page EN-31) to record to the system track.
2. Next, select the tone of the part you want to play and record.
3. On the MENU screen, touch “MIDI RECORDER”.
4. Touch “●” to enter the recording mode.
5. Touch the track name.

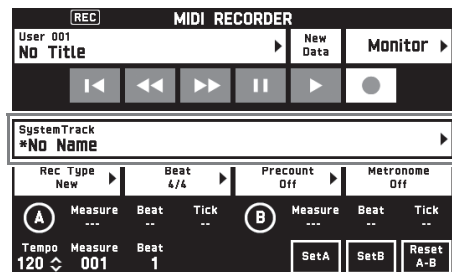

6. Touch the track (Solo Track 1 through Solo Track 16) you want to record.
7. Start playing something on the keyboard.

This starts recording along with playback of what you recorded to the system track, so you can play along with system track.

8. After you are finished playing, touch “■”.

This enters the playback mode. Touch “▶” to play back what you recorded up to this point. To stop playback, touch “■”.

- You can use the following procedure to turn specific tracks on (play enabled) and off (play disabled). This allows you to listen only to the track(s) you want when recording a new track.

(1) Touch “Monitor”.

This displays the MIDI Recorder playback properties screen.

(2) You can select “Mute” or “Solo” for each of the tracks.

Mute: Track is not played.

Solo: Selected track is played alone.

You can mute specific recorded tracks so they do not play as you record a new track.

9. Repeat steps 2 through 8 above as required to record all of the parts you need to complete your song.

NOTE

- You can re-record the currently selected track without changing any settings. Simply touch “Rec Type” on the screen that is displayed in the recording mode, and then select “Re-Recording”.

To re-record part of a recorder song (Punch-in Recording)

You can use punch-in recording to re-record a specific part of recorder song that you want to improve or correct.

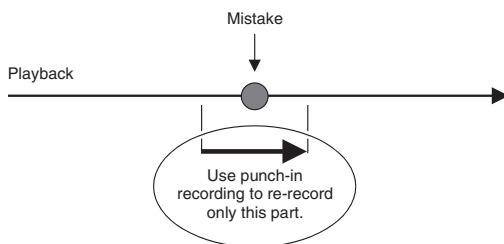

1. Enter the MIDI recorder recording mode and then select the track where you want to perform punch-in recording.

- For information about how to select a track, see steps 4 and 5 under “To record to a specific track (Part)” (page EN-32).

2. Touch “Rec Type”.

3. Touch “Punch In Sync”.

- If you want to delete all of the data in the track following the section you recorded with punch-in recording, touch “Punch Out Erase”.

4. Touch “▶”.

This will start playback of the selected track.

5. When playback reaches the point you want to re-record, play the desired note(s) on the keyboard.

This starts punch-in recording, so continue to play.

- Performing a pedal or pitch bend wheel operation also will start punch-in recording.

Besides keyboard play, you can also start punch-in recording by performing the operation below.

Touch “Punch In”^{*1}, change the tone, change the rhythm^{*2}, change the tempo^{*2}.

^{*1} Used when you want to start punch-in recording without modifying play or settings.

^{*2} System track only

- During punch-in playback, you can touch “◀◀” to skip back or “▶▶” to skip forward. This lets you jump more quickly to the location you want to record. You can also pause playback by touching “||”.

6. After you are finished punch-in recording, touch “■”.

Anything in the track following the point where you touched “■” will be retained as-is.

- If you want to cancel punch-in recording part way through and retain the original track data, touch “Cancel Punch”.

To re-record a specific range (Auto Punch-in Recording)

You can use the following procedure to specify a particular range for punch-in recording.

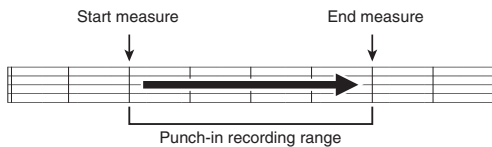

1. Enter the MIDI recorder recording mode and then select the song that contains the section you want to re-record.
2. Use “◀◀” and “▶▶” to display the first measure of the section you want to record and then touch “Set A”.

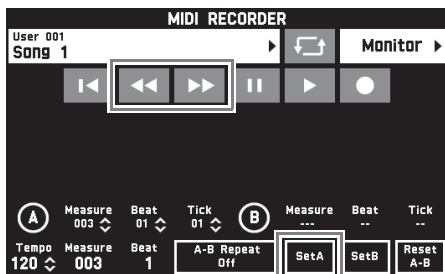

3. Use “◀◀” and “▶▶” to display the last measure and then touch “Set B”.
 4. Touch “◀” to return to the beginning of the song, or use “◀◀” and “▶▶” to adjust the position to start playback.
 5. Touch “●”.
- This enters record standby.
6. Touch “Rec Type”.
 7. Touch “Punch In A-B”.
 8. Touch “▶”.
- Punch in recording will start from the start measure and stop with the end measure automatically.

To re-record an area smaller than one measure

Use the procedure below to specify a punch-in recording area that includes a part of a measure.

Example: To re-record from beat 3 of measure 2 up to beat 1 of measure 4

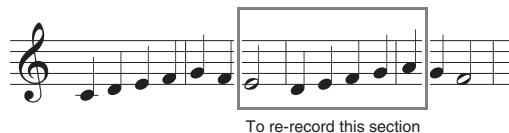

1. Use the MIDI Recorder to start playback of the song that contains the section you want to re-record.
 2. When playback reaches the point where you want to start punch-in recording, touch “Set A”.
- After touching “Measure”, “Beat”, or “Tick” for Point A, you can then use the **18** ↓, ↑ buttons to make fine adjustments to the start point.

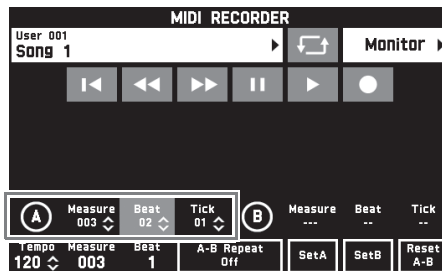

3. When playback reaches the point where you want to end punch-in recording, touch “Set B”.
- After touching “Measure”, “Beat”, or “Tick” for Point B, you can then use the **18** ↓, ↑ buttons to make fine adjustments to the end point.

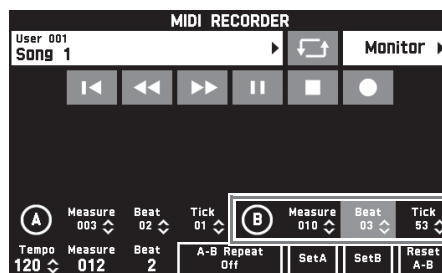

4. Touch “■” to stop playback.

5. Touch “⏮” to return to the beginning of the song, or use “◀◀” and “▶▶” to adjust the position to start playback.
6. Touch “●” to enter the recording mode and select the track where you want to perform punch-in recording.
 - For information about how to select a track, see steps 4 and 5 under “To record to a specific track (Part)” (page EN-32).
7. Touch “Rec Type”.
8. Touch “Punch In A-B”.
9. Touch “▶”.

 - Punch-in recording automatically starts when playback reaches the start point and ends when it reaches the end point you specified in step 3.

To play MIDI data

You can use the procedure below to perform auto play of MIDI data (MIDI recording data or SMF files) stored in Digital Piano memory or on a USB flash drive, and practice along on the keyboard.

- For information about loading a USB flash drive on the Digital Piano and importing MIDI data to Digital Piano memory, see “Loading Data from a USB Flash Drive to Digital Piano Memory” (page EN-51).

1. On the MENU screen, touch “MIDI RECORDER”.

This displays a MIDI RECORDER screen.

2. Touch the file name.

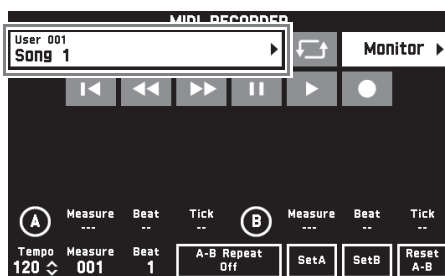

3. Touch the “User” tab to play back MIDI data stored in Digital Piano memory or the “Media” tab to play back from a USB flash drive.
4. Touch the MIDI data you want to play.

5. Touch “▶”.

This starts playback.

- You can also start playback by pressing the **4** MIDI ▶/■ button.
- The operations below are supported while MIDI data is playing back, during playback standby, or while playback is paused.

This icon:	Does this:
↺	Performs repeat play.
⏮	Returns to the beginning of a song.
◀◀	Rewinds. A single touch rewinds one measure, holding down performs continuous rewind.
▶▶	Fast forwards. A single touch fast forwards one measure, holding down performs continuous fast forward.
⏸	Pauses or resumes the currently playing MIDI data. The icon flashes while playback is paused.
▶/■	Starts playback MIDI data or stops playback.
●	Toggles between the recording mode and playback mode.

6. To stop playback, touch “■”.

- You can also stop playback by pressing the **4** MIDI ▶/■ button.

To adjust the Balance between Playback and Keyboard Volume (MIDI Volume)

You can change the volume level of the MIDI data auto play only, without affecting the volume of the keyboard. For details, see “BALANCE Screen” under “Configuring Digital Piano Settings” (pages EN-41 through EN-48).

To repeat playback of a specific section (Repeat)

You can configure the piano to repeat the section of a song you want to practice. You could, for example, specify repeat play from measure 5 to measure 8.

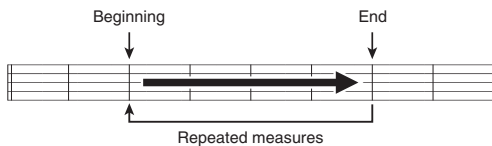

1. Touch “▶”.

This starts auto play.

2. When play reaches the beginning of the section you want to repeat, touch “Set A”.

This makes the measure where you touched “Set A” the “start measure”.

- You can also make fine adjustments to the start point. After touching “Measure”, “Beat”, or “Tick” for Point A, you can then use the **18** \downarrow , \uparrow buttons to adjust.

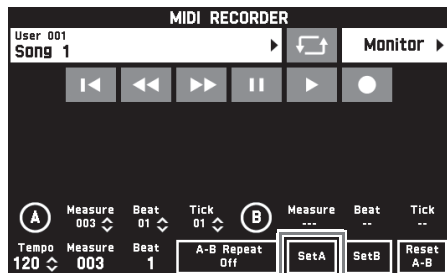

3. When play reaches the end of the section you want to repeat, touch “Set B”.

This makes the measure where you touched “Set B” the “end measure”.

- You can also make fine adjustments to the end point. After touching “Measure”, “Beat”, or “Tick” for Point B, you can then use the **18** \downarrow , \uparrow buttons to adjust.

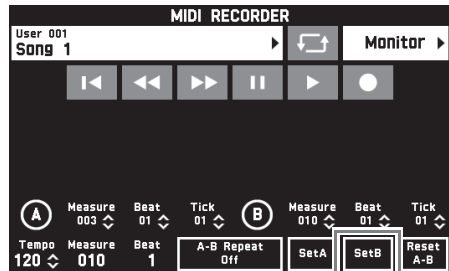

4. Touch “A-B Repeat” to enable repeat playback.

This starts repeat playback of the specified section.

5. To disable repeat playback, touch “A-B Repeat” again, which will return to normal playback.

NOTE

- To clear the start measure and end measure settings, touch “Reset A-B”.

To rename recorded MIDI data

1. On the MENU screen, touch "MIDI RECORDER".
2. Touch the data name.
3. Touch "User Data Edit".
4. Touch "Rename".
5. Touch the data you want to rename.
6. Input the new name.
7. After you are finished inputting the name, touch "Enter".
8. Touch "Yes".
 - To cancel the rename operation, touch "No".

To copy recorded MIDI data

1. On the MENU screen, touch "MIDI RECORDER".
2. Touch the data name.
3. Touch "User Data Edit".
4. Touch "Copy".
5. Touch the data you want to copy.
6. Touch "Execute".
7. Touch "Yes".
 - To cancel the copy operation, touch "No".

To delete recorded data

1. On the MENU screen, touch "MIDI RECORDER".
2. Touch the data name.
3. Touch "User Data Edit".
4. Touch "Delete".
5. Touch the data you want to delete.
6. Touch "Execute".
7. Touch "Yes".

This deletes the MIDI data you selected.

 - To cancel the delete operation, touch "No".

To rename a track

1. On the MENU screen, touch "MIDI RECORDER".
2. Touch "Monitor".
3. Touch "Edit".
4. Touch "Rename".
5. Touch the track you want to rename.
6. Input the new name.
7. After you are finished inputting the name, touch "Execute".
8. Touch "Yes".
 - To cancel the rename operation, touch "No".

To copy one track to another

1. On the MENU screen, touch "MIDI RECORDER".
2. Touch "Monitor".
3. Touch "Edit".
4. Touch "Copy".
5. In the "Source" list, touch the track you want to copy.
6. In the "Destination" list, touch the destination track.
7. Touch "Execute".
8. Touch "Yes".
 - To cancel the copy operation, touch "No".

To clear a track

1. On the MENU screen, touch "MIDI RECORDER".
2. Touch "Monitor".
3. Touch "Edit".
4. Touch "Clear".
5. Touch the track you want to clear.
6. Touch "Execute".
7. Touch "Yes".
 - To cancel the delete operation, touch "No".

Recording to a USB Flash Drive (Audio Recorder)

Anything played on the Digital Piano is recorded to the USB flash drive as audio data (WAV files*). If you play along on the Digital Piano as you play back data stored in Digital Piano memory, the memory playback and your keyboard play are both recorded to USB flash drive.

* Linear PCM, 16bit, 44.1 kHz, Stereo

- Each new recording of audio data to a USB flash drive is automatically assigned a new file name, so existing data is not overwritten.
- Never remove the USB flash drive while Audio Recorder recording or playback is in progress. Doing so can corrupt the data on the USB flash drive and damage the USB flash drive port.

To record keyboard play to a USB flash drive

PREPARATION

- Be sure to format the USB flash drive on the Digital Piano before using it. See "USB Flash Drive" on page EN-49 for more information.

1. Insert the USB flash drive into the Digital Piano's USB flash drive port.
 - When you perform a USB flash drive operation or turn on the Digital Piano while a USB flash drive is plugged in, the Digital Piano initially needs to perform a "mounting" sequence to prepare for data exchange with the USB flash drive. Digital Piano operations may be momentarily disabled while a mounting sequence is being performed. While the mounting process is in progress, the message "Media Mounting" will be displayed on the display. It may take up to 10 or 20 seconds or even longer for a USB flash drive to be mounted. Do not attempt to perform any operation on the Digital Piano while a mounting sequence is in progress. A USB flash drive needs to be mounted each time it is connected to the Digital Piano.
2. On the MENU screen, touch "AUDIO RECORDER".

3. Touch “●”.

This turns on the recorder and enters recording mode.

- Each touch of “●” cycles through modes as shown below.

Playback mode

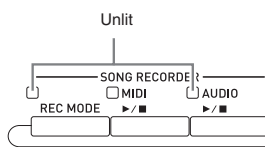
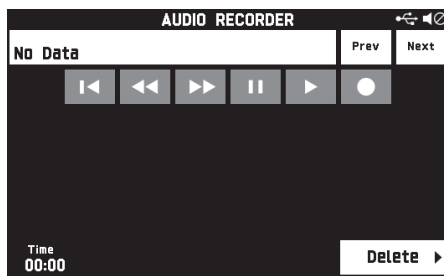

Recording mode

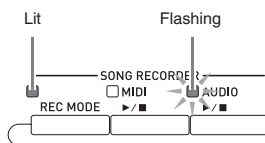
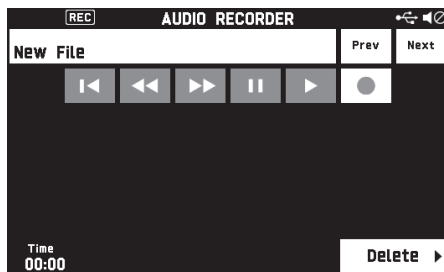

4. Start playing something on the keyboard.

This will cause recording to the USB flash drive to start.

- You can also start recording by touching “▶”.
- The **5** AUDIO ▶/■ button is lit while recording is in progress.

NOTE

- Do not remove the USB flash drive from the USB flash drive port while the **5** AUDIO ▶/■ button lamp is lit or flashing. Doing so will interrupt recording and may corrupt data.

5. To stop recording, touch “■”.

NOTE

- You can also enter the recording mode by pressing the **3** REC MODE button and then touching “AUDIO RECORDER”.

To record keyboard play with playback from Digital Piano memory

1. On the MENU screen, touch “AUDIO RECORDER”.
2. Touch “●” to enter the recording mode.

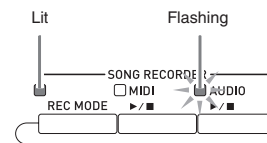

3. Touch “▶”.

4. Press the **4** MIDI ▶/■ button.

- This starts playback of the Digital Piano’s memory contents. Play along on the keyboard.

5. To stop recording, touch “■”.

To play along with data recorded on a USB flash drive

- On the MENU screen, touch “AUDIO RECORDER”.
 - The above step is not necessary if you are playing back recorded data immediately after recording it (while the AUDIO RECORDER screen is displayed).
- Touch the file name.

This displays the audio file selection screen.



- Touch the song you want to play.
- Touch “▶”.

This starts playback of the selected song.

 - You can also start playback by pressing the **5** AUDIO ▶/■ button.
 - The **5** AUDIO ▶/■ button is flashing while playback is in progress.
 - The operations below are supported while audio data is playing back, during playback standby, or while playback is paused.

Note that rewind (◀◀) and fast forward (▶▶) operations are supported only during playback.

This icon:	Does this:
PREV	Plays the previous audio data.
NEXT	Plays the next audio data.
◀◀	Returns to the beginning of a song.
◀◀	Rewinds. A single touch rewinds one second, holding down performs continuous rewind.
▶▶	Fast forwards. A single touch fast forwards one second, holding down performs continuous fast forward.
	Pauses or resumes the currently playing audio data. The icon flashes while playback is paused.
▶/■	Starts playback from the beginning of audio data or stops playback.
●	Toggles between the recording mode and playback mode.

- To stop the song, touch “■”.
 - You can also stop playback by pressing the **5** AUDIO ▶/■ button.

To delete an audio file from a USB flash drive

Files can be deleted one at time.

IMPORTANT!

- The procedure below deletes all of the data of the selected song. Note that the delete operation cannot be undone. Check to make sure you really do not need the data in Digital Piano memory before you perform the following steps.

- On the MENU screen, touch “AUDIO RECORDER”.
- Touch the file name.
- Touch “Delete”.
- Touch the data you want to delete.
- Touch “Execute”.
- Touch “Yes”.

This deletes the audio data you selected.

- To cancel the delete operation, touch “No”.

Configuring Digital Piano Settings

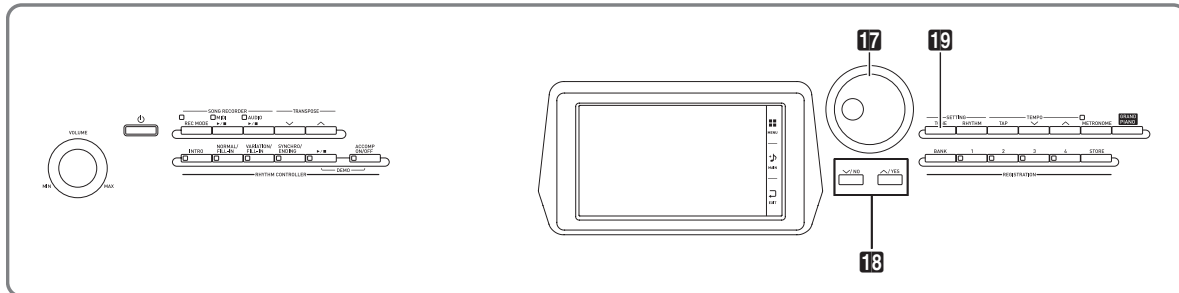

On the MENU screen, you can change the selected tone and rhythm, and also change the keyboard key and touch settings, pedal and MIDI settings, and more. This means you can tailor Digital Piano operation to suit your particular needs.

Configuring Digital Piano Settings

1. On the MENU screen, touch the menu for the settings you want to configure.

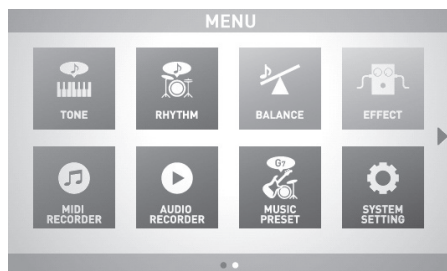

2. Touch the item whose setting you want to change.
3. Use the **17** Dial or the **18** \downarrow , \uparrow buttons to change the setting.

■ TONE Screen

Use this screen to configure tone and other keyboard settings.

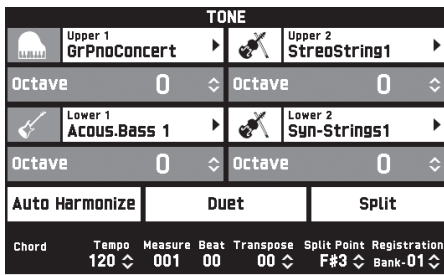

NOTE

- You can also display the TONE screen by pressing the **19** TONE button.

Item	Description	Setting
Upper 1, Upper 2, Lower 1, Lower 2	Turns each part on or off, and specifies its tone.	Off, On
Octave	Change the range of each part in octave units.	-2 to 0 to 2
Auto Harmonize	See page EN-24.	Off, On
Duet	See page EN-16.	Off, On
Split	See page EN-15.	Off, On

■ RHYTHM Screen

Use this screen to configure Auto Accompaniment settings. See "Using Auto Accompaniment" (page EN-20) for more information.

■ BALANCE Screen

Use this screen to adjust volume settings for the keyboard, Auto Accompaniment, etc.

BALANCE			
Parameter	Setting	Parameter	Setting
Upper 1 Volume	127 ⇅	Upper 2 Volume	127 ⇅
Lower 1 Volume	127 ⇅	Lower 2 Volume	127 ⇅
Keyboard Volume	127 ⇅	Accomp Volume	127 ⇅
MIDI Volume	127 ⇅		
Audio Volume	127 ⇅		
Metronome Volume	100 ⇅		

Item	Description	Setting
Upper 1 Volume	See page EN-17.	0 to 127
Upper 2 Volume	See page EN-17.	0 to 127
Lower 1 Volume	See page EN-17.	0 to 127
Lower 2 Volume	See page EN-17.	0 to 127
Keyboard Volume	Adjusts the volume levels of all parts that are controlled by the keyboard.	0 to 127
Accomp Volume	Adjusts the volume level of the Auto Accompaniment without changing the keyboard tone volume level.	0 to 127
MIDI Volume	Adjusts the volume level of the MIDI data without changing the keyboard tone volume level.	0 to 127
Audio Volume	Adjusts the volume level of audio data stored on a USB flash drive.	0 to 127
Metronome Volume	See page EN-18.	0 to 127

■ EFFECT Screen

Use this screen to apply variety of acoustic effects to notes.

EFFECT	
Parameter	Setting
Brilliance	0 ↕
Reverb Type	Room 1 ▶
Chorus Type	Chorus 1 ▶
Delay Type	Short 1 ▶

Item	Description	Setting
Brilliance	Controls the brilliance of the tone.	-3 to 0 to +3
Reverb Type	Specifies the type of reverb to be applied.	Room1, Room2, Room3, Hall1, Hall2, Hall3, Plate1, Plate2, Plate3, Delay, Pan Delay, Large Room1, Large Room2, Stadium1, Stadium2, Long Delay1, Long Delay2
Chorus Type	Specifies the type of chorus to be applied.	Chorus1, Chorus2, Chorus3, Chorus4, FB Chorus, Flanger1, Flanger2, Flanger3, Flanger4, Short Delay1, Short Delay2, Short Delay3, Short Delay4, Soft Chorus, Bright Chorus, Deep Chorus
Delay Type	Selects the delay type.	Short 1, Short 2, Echo, Short Tempo, Mid Tempo, Long Tempo

■ MIDI RECORDER Screen

Use this screen to record a performance to Digital Piano memory and to play back recordings. For more information, see "Recording to Digital Piano Memory (MIDI Recorder)" (page EN-31).

■ AUDIO RECORDER Screen

Use this screen to record a performance on a commercially available USB flash drive, and to play back recorded audio data on the Digital Piano. For more information, see "Recording to a USB Flash Drive (Audio Recorder)" (page EN-38).

■ MUSIC PRESET Screen

Music presets provide you with one-touch tone, rhythm, chord, and other settings that are optimized for specific musical genres and songs. For more information, see "Music Presets" (page EN-26).

■ SYSTEM SETTING Screen

Use this screen to configure global Digital Piano settings.

SYSTEM SETTING		
Parameter	Setting	
Speaker	On	⤴
External Speaker	On	
Touch Response	Normal	▶
Touch Off Velocity	100	◇
Metronome Count	4	◇
Accomp Freeze	Off	⤵

Item	Description	Setting
Speaker	Specifies whether sound should be output from the Digital Piano speakers (On) or muted (Off).	Off, On
External Speaker	Specifies whether or not the timbre of output should be changed to optimize for output from the speakers that are built into the stand that comes with the Digital Piano. Selecting the wrong setting can disable output from the stand's built-in speakers or result in abnormal Digital Piano output. On: Changes timbre of output to optimize for output from the stand's speakers. Off: Use this setting when not the stand's built-in speakers.	Off, On
Touch Response	Adjusts keyboard touch	Off: Disabled Light: Strong sound even with light pressure Normal: Normal key touch Heavy: Normal sound even with strong pressure
Touch Off Velocity	Specifies the velocity value when the Touch Response setting is Off.	0 to 127
Metronome Beat	Specifies the number of metronome beats per measure.	0 to 9
Accomp Freeze	You can use Accomp Freeze to specify accompaniment settings that should be left unchanged whenever a registration setup is applied. For details, see "Parameter List" (page A-14).	Off, On
Tuning	Raises or lowers the overall pitch of the Digital Piano from the standard pitch of A4 = 440 Hz in 0.1Hz units.	415.5Hz to 440.0Hz to 465.9Hz
Temperament	Changes the temperament of the keyboard and Auto Accompaniment from the standard equal temperament to another tuning more suitable for playing classics, Arabian music, etc.	Equal, Pure Major, Pure Minor, Pythagorean, Kirnberger 3, Werckmeister, Mean-Tone, Rast, Bayati, Hijaz, Saba, Dashti, Chahargah, Segah, Gurjari Todi, Chandrakauns, Charukeshi
Temperament Base Note	Pressing a keyboard key makes the pressed key the root of the temperament.	C to B (12 types)
Acmp Temperament	Turn this setting off to play Auto Accompaniment using standard equal temperament, regardless of the current scale setting selected with the Temperament Base Note parameter above.	Off, On
Stretch Tuning	Sharpens high notes and flattens low notes to achieve stretch tuning. This type of tuning is called "stretch tuning". Turn off this setting to play with normal (non-stretch) tuning.	Off, On
Brightness	Use this item to adjust display brightness.	1 to 13

Item	Description	Setting
Operation Lock	When this setting is turned on, the Digital Piano's buttons (except for the 1  button and buttons required for unlock) are locked, so no operation can be performed. Turn on operation lock when you want to protect against unintentional button and control panel operations.	Off, On
Auto Resume	When "On" is selected for this setting, the Digital Piano will remember its settings whenever it is turned off, and restore them when it is turned on again. When "Off" is selected, settings are reset to their initial defaults whenever the Digital Piano is turned on.	Off, On
Auto Power Off	Specifies if Auto Power Off (page EN-7) is enabled (On) or disabled (Off).	Off, On
Factory Reset	Use this screen to return the piano's stored data and settings to their initial factory defaults.	-

■ CONTROLLER Screen

Use this to configure pedal and pitch bend wheel settings.

CONTROLLER	
Parameter	Setting
Upper 1 Pedal	ON
Upper 2 Pedal	ON
Lower 1 Pedal	ON
Lower 2 Pedal	ON
Bend Range	02 ↕

Item	Description	Setting
Upper1 Pedal	Turn on to apply the pedal effect to the main tone when the pedal is depressed.	Off, On
Upper2 Pedal	Turn on to apply the pedal effect to the layered tone when the pedal is depressed.	Off, On
Lower1 Pedal	Turn on to apply the pedal effect to the split (main) tone when the pedal is depressed.	Off, On
Lower2 Pedal	Turn on to apply the pedal effect to the split (layered) tone when the pedal is depressed.	Off, On
Bend Range	Specifies (in semitone units) how much the pitch of the keyboard performance parts (Port A parts 1 through 5) changes when the pitch bend wheel is rotated all the way upwards or downwards.	00 to 24

■ MIXER Screen

Use this screen to change the tone of each part, and to adjust its volume and reverb.

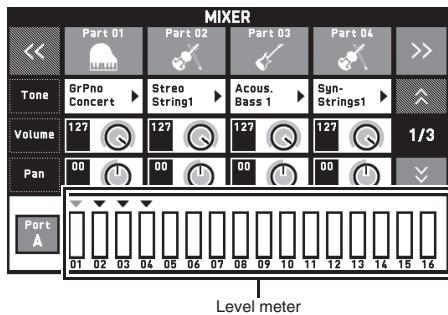

Level meter

Item	Meaning	Setting
Part	A part that is turned on is sounded. Turn off parts you do not want to sound.	Off, On
Tone	Changes the tone.	550
Volume	Adjusts the volume. The volume level of each part is shown by an on-screen level meter.	0 to 127
Pan	Specifies the stereo pan position of the sound output by the Digital Piano. 0 indicates the center, while a smaller values shifts to the left and a larger value shifts to the right.	-64 to 0 to +63
Coarse Tune	Specifies, in semitone steps, the pitch of the notes of each part.	-24 to 0 to +24
Fine Tune	Specifies, in cent steps, the pitch of the notes of each part.	-99 to 0 to +99
Bend Range	Adjusts, in semitone steps, the bend range of each part.	0 to 24
Reverb Send	Specifies how much reverb is applied to each part. No reverb is applied at all when this setting is 0, while maximum reverb is applied when it is 127.	0 to 127
Chorus Send	Specifies how much chorus is applied to each part. No chorus is applied at all when this setting is 0, while maximum chorus is applied when it is 127.	0 to 127
Delay Send	Specifies how much delay is applied to each part. No delay is applied at all when this setting is 0, while maximum delay is applied when it is 127.	0 to 127
Port	Specifies the port. For information about MIDI channels assigned to each port, see "Part and MIDI Channel Assignments" (page A-17).	Port A, Port B, Port C

■ MIDI Screen

Use this screen to configure MIDI settings.

For information about MIDI channels assigned to each port, see “Part and MIDI Channel Assignments” (page A-17).

MIDI	
Parameter	Setting
Keyboard Channel	01 ↕
Accomp Out	Off
Chord Judge	Off
Hi-Res Vel Out	On
Local Control	On
MIDI In Port	C ▶

Item	Description	Setting
Keyboard Channel	Selects the channel for sending keyboard play MIDI data to an external device (keyboard channel).	01 to 16
Accomp Out	Turn on this setting to send MIDI data corresponding to Auto Accompaniment to an external device.	Off, On
Chord Judge	Select whether chord input should be performed when a MIDI note on message to the Auto Accompaniment chord keyboard is received.	Off, On
Hi-Res Vel Out	Turns high-resolution velocity MIDI out on or off.	Off, On
Local Control	Selecting “Off” for Local Control cuts off the Digital Piano’s sound source, so no sound is produced by the Digital Piano when keys are pressed.	Off, On
MIDI In Port	Select the port to be used for input from the MIDI In .	A, B, C

■ MEDIA Screen

Use this screen to save data to a USB flash drive inserted in the Digital Piano and to import data from a USB flash drive to Digital Piano memory. For more information, see “USB Flash Drive” (page EN-49).

USB Flash Drive

Your Digital Piano supports the following USB flash drive operations.

- USB flash drive formatting
- Data storage to a USB flash drive
 - Song data recorded with the Digital Piano's MIDI recorder is stored on a USB flash drive as-is or stored as a MIDI file (SMF format 0).
 - Standard audio data from a computer (WAV files) can also be stored on a USB flash drive and played back on the Digital Piano.
 - Digital Piano play can be recorded directly to a USB flash drive.
For details, see "Recording to a USB Flash Drive (Audio Recorder)" (page EN-38).
- USB flash drive data loading to Digital Piano memory
 - MIDI files and CASIO format files stored on a USB flash drive can be loaded into the Digital Piano memory (page EN-35).
- Delete data from a USB flash drive
- Easy play back of song data from a USB flash drive

■ Types of Data

Data Type	Description (File Name Extension)	Supported Operations	
		Save to USB Flash Drive	Load from USB Flash Drive
User MIDI data (pages EN-35, EN-29)	One of the following two types of music data 1. Standard MIDI files (MID) SMF Format 0 or Format 1 2. MIDI data recorded on this Digital Piano (ZMF)	○	○
Registration (page EN-27)	Tone and rhythm setup settings (ZRM)	○	○

USB Flash Drive and USB Flash Drive Port Handling Precautions

⚠ IMPORTANT!

- Be sure to observe the precautions provided in the documentation that comes with the USB flash drive.
- Avoid using a USB flash drive under the following conditions. Such conditions can corrupt data stored on the USB flash drive.
 - Areas subjected to high temperature, high humidity, or corrosive gas
 - Areas subjected to strong electrostatic charge and digital noise
- Never remove the USB flash drive while data is being written to or loaded from it. Doing so can corrupt the data on the USB flash drive and damage the USB flash drive port.
- Never insert anything besides a USB flash drive into the USB flash drive port. Doing so creates the risk of malfunction.
- A USB flash drive can become warm after very long use. This is normal and does not indicate malfunction.
- Static electricity conducted to the USB flash drive port from your hand or from a USB flash drive can cause malfunction of the Digital Piano. If this happens, turn the Digital Piano off and then back on again.

Copyrights

You are allowed to use recordings for your own personal use. Any reproduction of an audio or music format file, without the permission of its copyright holder, is strictly prohibited under copyright laws and international treaties. Also, making such files available on the Internet or distributing them to third parties, regardless of whether such activities are conducted with or without compensation, is strictly prohibited under copyright laws and international treaties. CASIO COMPUTER CO., LTD. shall not be held in any way liable for any use of this Digital Piano that is illegal under copyright laws.

Connecting a USB Flash Drive to and Detaching It from the Digital Piano

IMPORTANT!

- Never plug any other device besides a USB flash drive into the USB flash drive port.
- When you perform a USB flash drive operation or turn on the Digital Piano while a USB flash drive is plugged in, the Digital Piano initially needs to perform a “mounting” sequence to prepare for data exchange with the USB flash drive. Digital Piano operations may be momentarily disabled while a mounting sequence is being performed. While the mounting process is in progress, the message “Media Mounting” will be displayed. It may take up to 10 or 20 seconds or even longer for a USB flash drive to be mounted. Do not attempt to perform any operation on the Digital Piano while a mounting sequence is in progress. A USB flash drive needs to be mounted each time it is connected to the Digital Piano.

■ To insert a USB flash drive

1. As shown in the illustration below, insert the USB flash drive into the Digital Piano’s USB flash drive port.
 - Carefully push the USB flash drive in as far as it will go. Do not use undue force when inserting the USB flash drive.

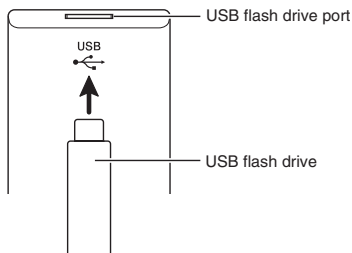

■ To remove a USB flash drive

1. Check to confirm that there is no data exchange operation being performed, and then pull the USB flash drive straight out.

Formatting a USB Flash Drive

IMPORTANT!

- Be sure to format a USB flash drive on the Digital Piano before using it for the first time.
- Before formatting a USB flash drive, make sure it does not have any valuable data stored on it.
- The format operation performed by this Digital Piano is a “quick format”. If you want to completely delete all of the data in USB flash drive, format it on your computer or some other device.

Supported USB Flash Drives

This Digital Piano supports USB flash drives formatted to FAT32. If your USB flash drive is formatted to a different file system, use the Windows format function to reformat it to FAT32. Do not use quick format.

1. Insert the USB flash drive to be formatted into the Digital Piano’s USB flash drive port.
2. On the MENU screen, touch “MEDIA”.
3. Touch “FORMAT”.
 - This displays a confirmation message (“Sure?”).
4. Touch “Yes”.
 - The message “Please Wait” remains on the display while the operation is being performed. Do not perform any operation while this message is on the display. “Complete” appears on the display after formatting is complete.
 - To cancel the format operation, touch “No”.

Saving Standard Song Data to a USB Flash Drive

Even when the file format is WAV (general audio data) or SMF (standard MIDI file), the procedure below can be used to save data to USB flash drive and play it back on the Digital Piano.

1. Connect the USB flash drive to your computer.
2. Move the song data file you want to play back to the MUSICDAT folder on the USB flash drive.
 - For information about playback see “To play along with data recorded on a USB flash drive” (page EN-40).

Saving Digital Piano Data to a USB Flash Drive

Digital Piano memory data (MIDI recorder songs) can be saved to a USB flash drive.

- MIDI Recorder songs can be converted to standard MIDI (SMF) files and stored on the USB flash drive.
- During recording of an Audio Recorder song, the data is stored directly to the USB flash drive, so the operation below is not required.

1. Insert the USB flash drive into the Digital Piano's USB flash drive port.
2. On the MENU screen, touch "MEDIA".
3. Touch "Save".
4. Touch the data type you want to save.
5. Touch the data you want to save.
6. Rename the file as required.
7. After renaming the file, touch "Enter".

This displays a confirmation message ("Sure?"). If there already a file with the same name on the USB flash drive, a confirmation message ("Replace?") will appear asking if you want to overwrite it with the new data.

8. Touch "Yes".
 - The message "Please Wait" remains on the display while the operation is being performed. Do not perform any operation while this message is on the display. "Complete" appears on the display after data save is complete.
 - To cancel the save operation, touch "No".

Loading Data from a USB Flash Drive to Digital Piano Memory

You can use the procedure below to load data from a USB flash drive into Digital Piano memory.

IMPORTANT!

- Place the data (file) you want to load into the MUSICDAT folder on the USB flash drive.

1. Insert the USB flash drive into the Digital Piano's USB flash drive port.
2. On the MENU screen, touch "MEDIA".
3. Touch "Load".
4. Touch the data type of the data you want to import.
5. On the "USB" list, touch the data you want to import.
6. On the "User Area" list, touch the import destination you want.
 - If you are importing MIDI data, you will not be able to specify an import destination.
7. Touch "Execute".

This displays an import confirmation message ("Sure?"). If there is already data in the import destination in Digital Piano memory, a message ("Replace?") will appear asking if you want to replace it with the new data.

8. Touch "Yes".
 - The message "Please Wait" remains on the display while the operation is being performed. Do not perform any operation while this message is on the display. "Complete" appears on the display after data import is complete.
 - To cancel the import operation, touch "No".

Deleting Data from a USB Flash Drive

Use the following procedure to delete USB flash drive data (files).

- 1.** Insert the USB flash drive into the Digital Piano's USB flash drive port.
- 2.** On the MENU screen, touch "MEDIA".
- 3.** Touch "Delete".
- 4.** Touch the data type of the data you want to delete.
- 5.** Touch the data you want to delete.
- 6.** Touch "Execute".
This displays a delete confirmation message ("Sure?").
- 7.** Touch "Yes".
 - The message "Please Wait" remains on the display while the operation is being performed. Do not perform any operation while this message is on the display. "Complete" appears on the display after data delete is complete.
 - To cancel the delete operation, touch "No".

Connecting to a Computer

You can connect the Digital Piano to a computer and exchange MIDI data between them. You can send play data from the Digital Piano to commercially available music software running on your computer, or you can send MIDI data from your computer to the Digital Piano for playback.

Minimum Computer System Requirements

The following shows the minimum computer system requirements for sending and receiving MIDI data. Check to make sure that your computer complies with these requirements before connecting the Digital Piano to it.

● Operating System

Windows Vista® *1

Windows® 7 *2

Windows® 8 *3

Windows® 8.1 *4

Mac OS® X (10.3.9, 10.4.11, 10.5.X, 10.6.X, 10.7.X, 10.8.X, 10.9.X)

*1: Windows Vista (32-bit)

*2: Windows 7 (32-bit, 64-bit)

*3: Windows 8 (32-bit, 64-bit)

*4: Windows 8.1 (32-bit, 64-bit)

● USB port

! IMPORTANT!

- Never connect to a computer that does not conform to the above requirements. Doing so can cause problems with your computer.

NOTE

- For the latest news about supported operating systems, visit the website at the URL below.
<http://world.casio.com/>

To connect the Digital Piano to your computer

! IMPORTANT!

- Make sure you follow the steps of the procedure below exactly. Connecting incorrectly can make data send and receive impossible.

1. Turn off the Digital Piano and then start up your computer.
 - Do not start up the music software on your computer yet!
2. After starting up your computer, use a commercially available USB cable to connect it to the Digital Piano.

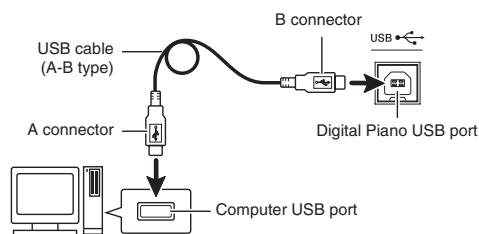

3. Turn on the Digital Piano.
 - If this is the first time you are connecting the Digital Piano to your computer, the driver software required to send and receive data will be installed on your computer automatically.
4. Start up commercially available music software on your computer.
5. Configure the music software settings to select "CASIO USB-MIDI" as the MIDI device.
 - For information about how to select the MIDI device, see the user documentation that comes with the music software you are using.

! IMPORTANT!

- Be sure to turn on the Digital Piano first before starting up your computer's music software.

NOTE

- Once you are able to connect successfully, there is no problem with leaving the USB cable connected when you turn off your computer and/or Digital Piano.
- This Digital Piano conforms to General MIDI Level 1 (GM).
- For detailed specifications and connections that apply to MIDI data send and receive by this Digital Piano, see the latest support information provided by the website at the following URL.
<http://world.casio.com/>

Using MIDI

What is MIDI?

The letters MIDI stand for Musical Instrument Digital Interface, which is the name of a worldwide standard for digital signals and connectors that makes it possible to exchange musical data between musical instruments and computers (machines) produced by different manufacturers.

For details about the MIDI specifications of this Digital Piano, see the "MIDI Implementation" document at the website located at the URL below.

<http://world.casio.com/>

NOTE

- You can alter the Digital Piano's MIDI setup by changing the MIDI data send channel or other settings. For details, see "MIDI Screen" (page EN-48).

Getting Ready

Assembling the Stand

Before assembling the stand, first take a few moments to check that all of the items shown below are present.

- This stand does not include any of the tools required for assembly. It is up to you to prepare a large Philips head (+) screwdriver for assembly.

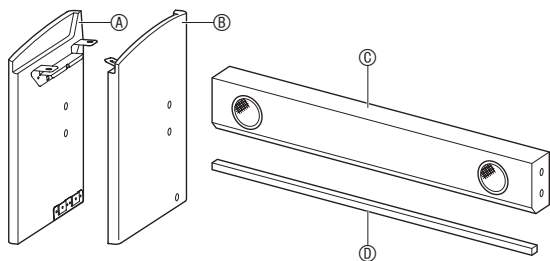

	Part	Qty
E		4
F		2
G		6
H		2
I		2
J		2

- Before starting assembly of the stand, divide the polystyrene foam packing material into four parts.

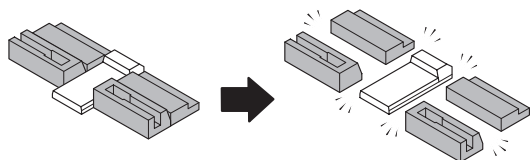

IMPORTANT!

- Do not use any screws other than those that come with the stand. Doing so risks damage to the stand and/or Digital Piano.
- You can find the screws in a plastic bag inside of the packing material.
- If anything is missing or damaged, contact your local CASIO service provider.

CAUTION

- Assembly of the stand should be performed by at least two people working together. The Digital Piano unit is particularly heavy. When moving it, get at least one other person to help you and handle with care.

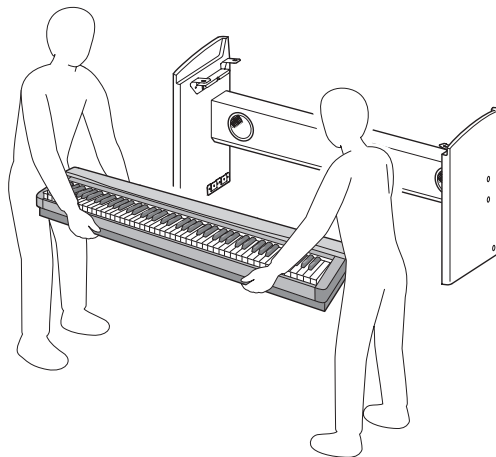

- This stand should be assembled on a flat surface.
- Take care that you do not pinch your fingers between parts when assembling them.
- Be sure to insert felt or other material between the rubber feet and flooring. Do not allow direct contact between them. Some types of flooring material may become discolored or damaged by direct contact with the rubber feet.

1. Turn over and place the piano onto a blanket, pillow, or other soft object, insert the support piece **D** into the groove along the bottom **★**, and secure it in place with two **F** screws.

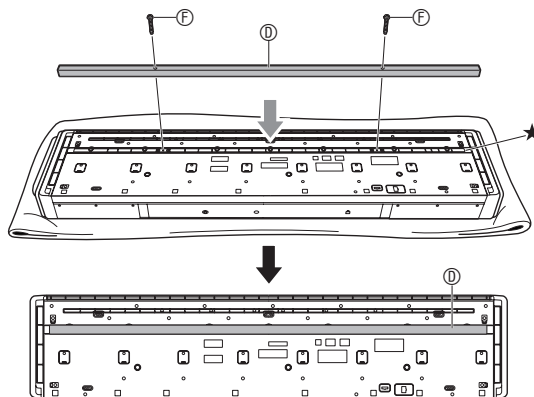

2. Use the four pieces of polystyrene foam to secure side panels (A) and (B) in place.

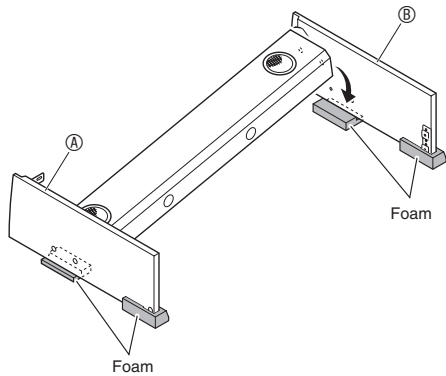

IMPORTANT!

- If you do not have any packing material available, use a magazine or some other thick item.

3. Attach side panels (A) and (B) to speaker box (C). Secure the side panels using four screws (E).

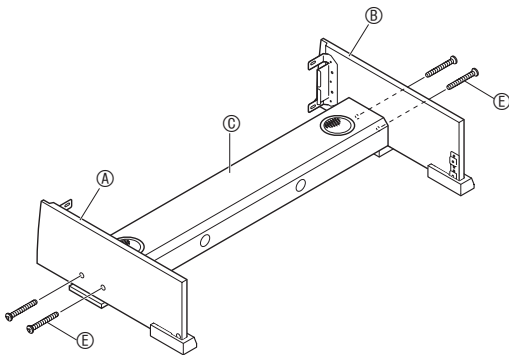

4. After ensuring that all of the screws are fully tightened, remove the packing material and stand up the stand.

- Cover the screw heads with the caps (G).

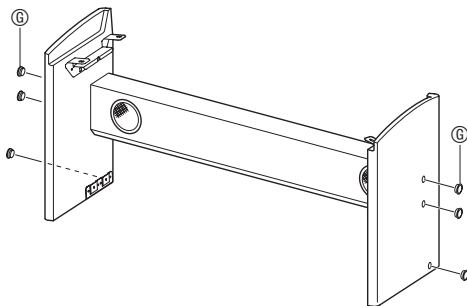

5. Place the piano onto the stand.

IMPORTANT!

- In order to ensure you do not get your fingers pinched between the piano and the stand, grasp the piano on its sides (not its ends) at the locations marked with stars (★) in the illustration.

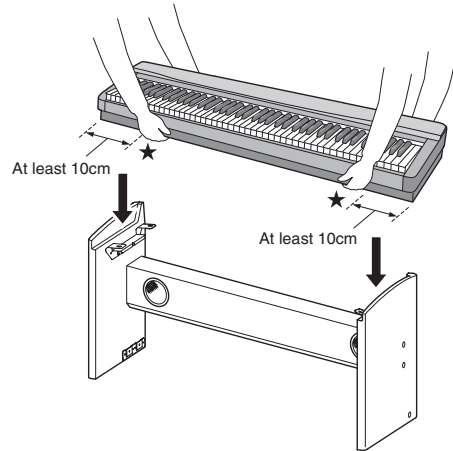

6. First, use the two butterfly screws (H) to secure the back of the piano to the stand. Next, use the two screws (I) to secure the front of the piano.

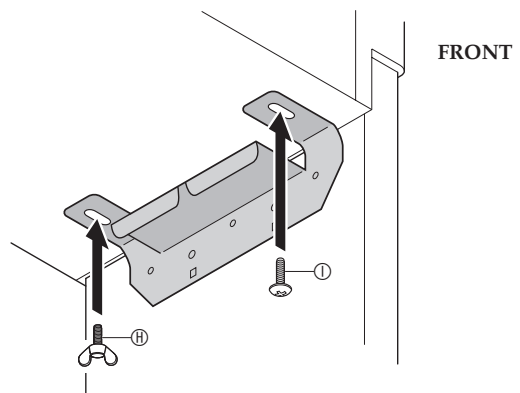

IMPORTANT!

- To prevent the chance of the piano unit falling, be sure to securely tighten the butterfly screws (H) and screws (I).

7. Connect the cable to the speaker jack and secure the cable with the clips (J).

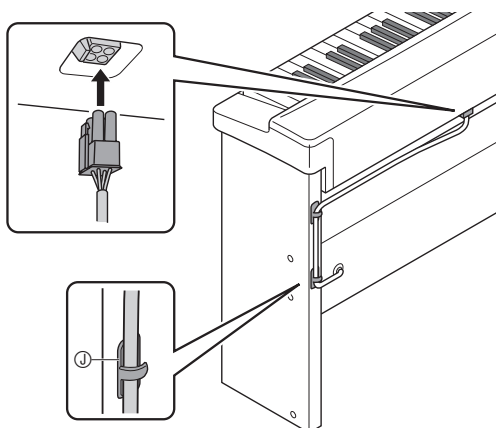

IMPORTANT!

- If you are using the Digital Piano in a stand-alone configuration (not mounted on its stand), be sure to change the "External Speaker" SYSTEM SETTING to Off. For details, see "SYSTEM SETTING Screen" under "Configuring Digital Piano Settings" (pages EN-41 through EN-48).

8. Plug the power cord of the AC adaptor that comes with the Digital Piano into a household power outlet as shown in the illustration below.

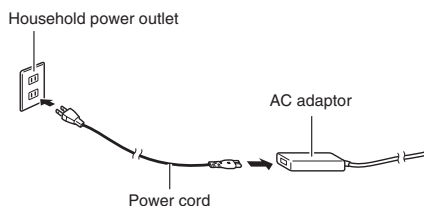

Using the Anti-tipping Brackets

Use the anti-tipping brackets to protect the stand from tipping over when it is in a location that is not against a wall, etc.

- Remove the bracket screws from the inside surfaces of the side panels (two screws each panel, four total) and then shift the position of the brackets as shown in the figure.

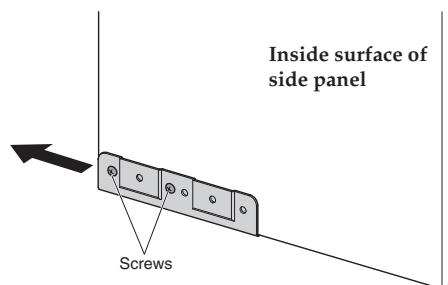

- Replace the screws you removed in step 1 above and secure the brackets in place.

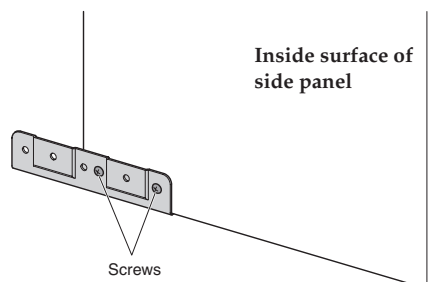

Removing the Protective Tape from the Keyboard

Protective tape is affixed to the front edges of the keyboard keys to protect them during shipment. Remove the protective tape before using the Digital Piano.

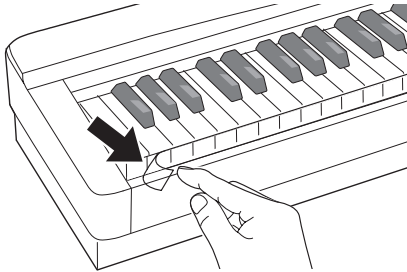

Installing the Music Stand

Insert the bottom of the music stand into the groove on the top of the Digital Piano's console.

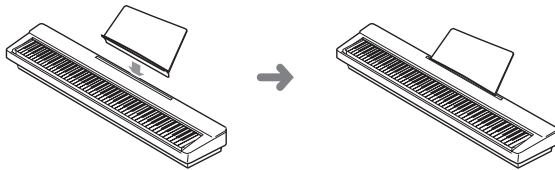

Error Messages

One of the error messages below appears on the display when a problem occurs.

- To clear an error message and return to the normal display, touch **F6 EXIT** on the display.

Display Message	Cause	Action
No Media	<ol style="list-style-type: none"> The USB flash drive is not connected to the Digital Piano's USB flash drive port. The USB flash drive was removed while some operation was in progress. The USB flash drive is write-protected. The USB flash drive has anti-virus software. 	<ol style="list-style-type: none"> Correctly plug the USB flash drive into the USB flash drive port. Do not remove the USB flash drive while any operation is in progress. Unprotect the USB flash drive. Use a USB flash drive that does not have anti-virus software.
No File	There is no loadable file or no playable file in the "MUSICDAT" folder.	Move the file you want to load or play into the appropriate location (pages EN-50, EN-51) in the "MUSICDAT" folder.
Read Only	A read-only file with the same name you are trying to use is already stored on USB flash drive.	<ul style="list-style-type: none"> Change the name and then save the new data. Remove the read-only attribute from the existing USB flash drive file and overwrite it with the new data. Use a different USB flash drive.
Media Full	There is not enough space available on the USB flash drive.	Delete some of the files on the USB flash drive to make room for new data (page EN-52) or use a different USB flash drive.
Too Many Files	<ol style="list-style-type: none"> There are too many files on the USB flash drive. There is a file named TAKE99.WAV in the "MUSICDAT" folder. 	<ol style="list-style-type: none"> Delete some of the files on the USB flash drive to make room for new data. Delete the WAV file in the "MUSICDAT" folder.
Not SMF01	You are attempting to play back SMF Format 2 song data.	This Digital Piano supports playback of SMF Format 0 or Format 1 only.
Size Over	<ol style="list-style-type: none"> The MIDI recording data on the USB flash drive cannot be played because it is too big. The SMF file on the USB flash drive cannot be played because it is too big. 	<ol style="list-style-type: none"> The Digital Piano supports playback of MIDI recording data up to approximately 700KB. The Digital Piano supports playback of SMF files up to 320 KB.
Wrong Data	<ol style="list-style-type: none"> The USB flash drive data is corrupted. USB flash drive contains data that is not supported by this Digital Piano. 	—
Memory Full	There is not enough Digital Piano memory available to convert a MIDI recorder song to SMF data and store it on the USB flash drive.	Reduce the size of the song data. Example: Delete any tracks that are not required.
Format Error	<ol style="list-style-type: none"> The USB flash drive format is not compatible with this Digital Piano. The USB flash drive is corrupted. 	<ol style="list-style-type: none"> Format the USB flash drive on the Digital Piano. Use a different USB flash drive.
Media Error	The USB flash drive is corrupted.	Use a different USB flash drive.
Measure Limit	Attempting to input MIDI recording data or music preset that has more than 999 measures.	The Digital Piano supports input of up to 999 measures.
Data Full	Attempting to store data that exceeds the maximum allowable number of data items.	Delete unneeded data.

Troubleshooting

Problem	Cause	Action	See Page
No sound is produced when I press a keyboard key.	<ol style="list-style-type: none"> 1. The VOLUME controller is set to "MIN". 2. Headphones or an adaptor plug is plugged into one of the PHONES jacks. 3. Upper 1 icon is off. 4. The "Speaker" SYSTEM SETTING is off. 	<ol style="list-style-type: none"> 1. Rotate the VOLUME controller more towards "MAX". 2. Disconnect whatever is connected to the PHONES jack. 3. Touch the Upper 1 icon to turn it on. 4. Turn on the "Speaker" SYSTEM SETTING. 	<p>☞ EN-7</p> <p>☞ EN-8</p> <p>☞ EN-14</p> <p>☞ EN-45</p>
The pitch of the Digital Piano is off.	<ol style="list-style-type: none"> 1. Digital Piano tuning is incorrect. 2. The Digital Piano's key setting is something other than "440.0 Hz". 3. A non-standard temperament setting is being used. 4. Octave shift is enabled. 	<ol style="list-style-type: none"> 1. Adjust Digital Piano tuning, or turn the Digital Piano off and then back on again. 2. Change the key setting to "440.0 Hz", or turn Digital Piano power off and then back on again. 3. Change the temperament setting to "Equal", which is the standard modern tuning. 4. Change the octave shift setting to 0. 	<p>☞ EN-19</p> <p>☞ EN-45</p> <p>☞ EN-45</p> <p>☞ EN-42</p>
Tones and/or effects sound strange. Turning power off and then back on again does not eliminate the problem. <i>Example: Note intensity does not change even though I alter key pressure.</i>	The "Auto Resume" feature is turned on.	Turn off "Auto Resume". Next, turn power off and then back on again.	☞ EN-46
I cannot transfer data after connecting the Digital Piano to a computer.	—	<ol style="list-style-type: none"> 1. Check to make sure that the USB cable is connected to the Digital Piano and computer, and that the correct device is selected with your computer's music software. 2. Turn off the Digital Piano and then exit the music software on your computer. Next, turn the Digital Piano back on and then restart the music software on your computer. 	☞ EN-53
I cannot record chord accompaniment data on my computer.	"Accomp Out" is turned off.	Turn on "Accomp Out".	☞ EN-48
I cannot store data to a USB flash drive or load data from a USB flash drive.	—	See "Error Messages".	☞ EN-59
Playback stops part way through while transferring song data from my computer.	Digital noise from the USB cable or power cord caused data communication between your computer and Digital Piano to be interrupted.	<p>Stop song playback, disconnect the USB cable from the Digital Piano, and then reconnect it. Next, try playing back the song again.</p> <p>If this does not solve the problem, quit the MIDI software you are using, disconnect the USB cable from the Digital Piano, and then reconnect it. Next, restart the MIDI software and then try playing back the song again.</p>	☞ EN-53
A tone's quality and volume sounds slightly different depending where it is played on the keyboard.	<p>This is an unavoidable result of the digital sampling process,* and does not indicate malfunction.</p> <p>* Multiple digital samples are taken for the low range, middle range, and high range of the original musical instrument. Because of this, there may be a very slight difference in tonal quality and volume between sample ranges.</p>		

Problem	Cause	Action	See Page
When I press a button, the note that is sounding cuts out momentarily or there is a slight change in how effects are applied.	Performing a button operation while playing with the Duet Mode, Auto Accompaniment, the recorder, or other functions can cause such phenomena when the Digital Piano switches internal tone effects. It does not indicate malfunction.		
Even though I play on different ranges of the keyboard, the notes do not change octaves.	The ranges of certain tones are limited, which means that octaves change normally up to a certain low note or high note. With such a tone, the notes of the lowest octave will be repeated to the left of the lowest possible note, and the highest octave will be repeated to the right of the highest possible note. This is due do limitations in the range of the original musical instrument for each tone, and does not indicate malfunction of the Digital Piano.		

Product Specifications

Model	CGP-700
Keyboard	<p>Ebony/ivory feel piano keyboard, 88-key piano keyboard</p> <ul style="list-style-type: none"> • Velocity resolution: 16,256 maximum • Layer, Split • Duet: 4 octaves (-2 to 0 to +2) • Transpose: 2 octaves (-12 to 0 to +12) • Octave shift: 4 octaves (-2 to 0 to +2)
Sound Source	<ul style="list-style-type: none"> • Number of Tones: 550 • Maximum polyphony: 128 tones • Touch Response (3 sensitivity levels, Off) • Tuning: 415.5 Hz to 440.0 Hz to 465.9 Hz (0.1 Hz units) • Temperament: Equal temperaments plus 16 other types • Stretch Tuning: On, Off
Display	5.3-inch touch panel (5.0-inch 528 × 320-dot TFT color LCD)
Acoustic Simulator	Damper Resonance
Effects	Reverb (17 types), Chorus (16 types), Delay (6 types), DSP
Auto Accompaniment	Data items: 200 preset
Music Preset	Data items: 305 preset
Demo Song	6
MIDI Recorder	<ul style="list-style-type: none"> • Functions: Real-time recording, playback • Number of Song: 100 • Number of Tracks: 17 • Capacity: Up to approximately 50,000 notes per song • Recorded Data Protection: Built-in flash memory • MIDI Recorder Volume Level: Adjustable
Audio Recorder	<ul style="list-style-type: none"> • Real-time recording and playback to USB flash drive* <ul style="list-style-type: none"> * Linear PCM, 16bit, 44.1 kHz, stereo .WAV format • Songs: 100 files • Approximately 74 minutes maximum recording per file. • Audio Recorder Volume Level: Adjustable
Registration	96 (4 setups × 24 banks)
Metronome	<ul style="list-style-type: none"> • Beats: 0 to 9 • Tempo Range: 20 to 255 • Metronome Volume Level: Adjustable
Pedals	Damper (with half-pedal operation), Soft, Sostenuto
Other Functions	<ul style="list-style-type: none"> • Dedicated piano tone buttons • Balance adjustment • Setting backup • Operation Lock
MIDI	16-channel multi-timbre receive
Pitch Bend Wheel	Pitch Bend Range: 00 to 24 semitones
USB Flash Drive	<ul style="list-style-type: none"> • Capacity: 32GB or less recommended • SMF direct playback, data storage, data loading, USB flash drive format, audio data playback and storage
Inputs/Outputs	<ul style="list-style-type: none"> • PHONES jacks: Stereo mini jacks × 2 • DAMPER jack: Standard jack • Power: 24V DC • LINE OUT R, L/MONO jacks: Standard jacks × 2 <ul style="list-style-type: none"> Output impedance: 2.3KΩ Output voltage: 1.8V (RMS) MAX • Audio In: Stereo mini jack <ul style="list-style-type: none"> Input impedance: 9.0KΩ Input voltage: 200mV • USB port: Type B • USB flash drive port: Type A • Pedal connector (for optional SP-33 only) • Speaker jack

Speakers	ϕ 12cm \times 2 + ϕ 5cm \times 2, ϕ 12cm \times 2 (stand built-in speaker) (Output 20W + 20W)
Power Requirements	AC Adaptor: AD-E24250LW <ul style="list-style-type: none"> • Auto Power Off: Approximately 4 hours after last operation. Auto Power Off can be disabled.
Power Consumption	24V \approx 20W
Dimensions	Digital Piano and Stand: 132.2 (W) \times 29.3 (D) \times 76.3 (H) cm (52 $\frac{1}{16}$ \times 11 $\frac{9}{16}$ \times 30 $\frac{1}{16}$ inch)
Weight	Digital Piano and Stand: Approximately 25.7kg (56.7 lbs)

- Specifications and designs are subject to change without notice.

Operating Precautions

Be sure to read and observe the following operating precautions.

■ Location

Avoid the following locations for this product.

- Areas exposed to direct sunlight and high humidity
- Areas subjected to temperature extremes
- Near a radio, TV, video deck, or tuner
- The above devices will not cause malfunction of the product, but the product can cause interference in the audio or video of a nearby device.

■ User Maintenance

- Never use benzine, alcohol, thinner, or other chemical agents to clean the product.
- To clean the product or its keyboard, wipe with a soft cloth moistened in a weak solution of water and a mild neutral detergent. Wring all excess moisture from the cloth before wiping.

■ Included and Optional Accessories

Use only accessories that are specified for use with this product. Use of unauthorized accessories creates the risk of fire, electric shock, and personal injury.

■ Weld Lines

Lines may be visible on the exterior of the product. These are "weld lines" that result from the plastic molding process. They are not cracks or scratches.

■ Musical Instrument Etiquette

Always be aware of others around you whenever using this product. Be especially careful when playing late at night to keep the volume at levels that do not disturb others. Other steps you can take when playing late at night are closing windows and using headphones.

- Any reproduction of the contents of this manual, either in part or its entirety, is prohibited. Except for your own, personal use, any other use of the contents of this manual without the consent of CASIO is prohibited under copyright laws.
- IN NO EVENT SHALL CASIO BE LIABLE FOR ANY DAMAGES WHATSOEVER (INCLUDING, WITHOUT LIMITATION, DAMAGES FOR LOSS OF PROFITS, BUSINESS INTERRUPTION, LOSS OF INFORMATION) ARISING OUT OF THE USE OF OR INABILITY TO USE THIS MANUAL OR PRODUCT, EVEN IF CASIO HAS BEEN ADVISED OF THE POSSIBILITY OF SUCH DAMAGES.
- The contents of this manual are subject to change without notice.

■ AC Adaptor Handling Precautions

- Use a power outlet that is easily accessible so you can unplug the AC adaptor when a malfunction occurs or whenever else you need to do so.
- The AC adaptor is intended for indoor use only. Do not use it where it might be exposed to splashing or moisture. Do not place any container, such as a flower vase, that contains liquid on the AC adaptor.
- Store the AC adaptor in a dry place.
- Use the AC adaptor in an open, well-ventilated area.
- Never cover the AC adaptor with newspaper, a table cloth, a curtain, or any other similar item.
- Unplug the AC adaptor from the power outlet if you do not plan to use the Digital Piano for a long time.
- Never try to repair the AC adaptor or modify it in any way.

- AC adaptor operating environment

Temperature: 0 to 40°C

Humidity: 10% to 90% RH

Output polarity: 

AC Adaptor Handling Precautions

Model: AD-E24250LW

1. Read these instructions.
2. Keep these instructions on hand.
3. Heed all warnings.
4. Follow all instructions.
5. Do not use this product near water.
6. Clean only with a dry cloth.
7. Do not install near radiators, heat registers, stoves, or any other source of heat (including amplifiers).
8. Use only attachments and accessories specified by the manufacturer.
9. Refer all servicing to qualified service personnel. Servicing is required after any of the following occurs: when the product is damaged, when the power supply cord or plug is damaged, when liquid is spilled into the product, when a foreign object falls into the product, when the product is exposed to rain or moisture, when the product does not operate normally, when the product is dropped.
10. Do not allow the product to be exposed to dripping or splashing liquid. Do not place any object containing liquid on the product.
11. Do not allow the electrical load output to exceed the label rating.
12. Make sure the surrounding area is dry before plugging into a power source.
13. Make sure the product is oriented correctly.
14. Unplug the product during lightning storms or when you do not plan to use it for a long time.
15. Do not allow product ventilation openings to become blocked. Install the product in accordance with the manufacturer's instructions.
16. Take care the power cord is located where it will not be stepped upon or bent severely, particularly in locations close to plugs and convenience receptacles, and in locations where it exits from the product.
17. The AC adaptor should be plugged into a power outlet as close to the product as possible to allow immediate disconnection of the plug in case of emergency.

The symbol below is an alert indicating un-insulated hazardous voltage inside the product's enclosure, which may be sufficient to constitute the risk of electric shock to users.



The symbol below is an alert indicating the presence of important operating and maintenance (servicing) instructions in the documentation that accompanies the product.



STLport

Copyright 1994 Hewlett-Packard Company

Copyright 1996,97 Silicon Graphics Computer Systems, Inc.

Copyright 1997 Moscow Center for SPARC Technology.

Permission to use, copy, modify, distribute and sell this software and its documentation for any purpose is hereby granted without fee, provided that the above copyright notice appear in all copies and that both that copyright notice and this permission notice appear in supporting documentation. Hewlett-Packard Company makes no representations about the suitability of this software for any purpose. It is provided "as is" without express or implied warranty.

Permission to use, copy, modify, distribute and sell this software and its documentation for any purpose is hereby granted without fee, provided that the above copyright notice appear in all copies and that both that copyright notice and this permission notice appear in supporting documentation. Silicon Graphics makes no representations about the suitability of this software for any purpose. It is provided "as is" without express or implied warranty.

Permission to use, copy, modify, distribute and sell this software and its documentation for any purpose is hereby granted without fee, provided that the above copyright notice appear in all copies and that both that copyright notice and this permission notice appear in supporting documentation. Moscow Center for SPARC Technology makes no representations about the suitability of this software for any purpose. It is provided "as is" without express or implied warranty.

Appendix/Apéndice

Tone List/Lista de tonos

Group Number/ Número de grupo	Tone Name/ Nombre del tono	Program Change/ Cambio de programa	Bank Select MSB/ MSB de selección de banco	DSP
Piano				
001	GRAND PIANO CONCERT	0	2	
002	GRAND PIANO BRIGHT	1	2	
003	GRAND PIANO STUDIO	0	3	○
004	GRAND PIANO MODERN	0	4	○
005	ROCK PIANO	1	3	○
006	LA PIANO	1	4	○
007	DANCE PIANO 1	1	5	
008	DANCE PIANO 2	1	6	○
009	GRAND PIANO MELLOW	0	5	○
010	MONO PIANO 1	0	6	
011	MONO PIANO 2	0	7	○
012	TACK PIANO	0	8	○
013	GRAND PIANO CLASSIC	0	9	
014	GRAND PIANO DOLCE	0	10	○
015	HONKY-TONK	3	2	
016	OCTAVE PIANO	3	3	
017	STRINGS PIANO	0	11	○
018	SYNTH-STR.PIANO	0	12	
019	PIANO PAD	0	13	
020	CHOIR PIANO	0	14	
021	PIANO CHIME	0	15	
022	ELEC.GRAND PIANO	2	2	
023	MODERN E.G.PIANO	2	3	
024	CHORUS E.G.PIANO	2	4	○
025	OFF VELO.HARPSICHORD	6	2	○
026	HARPSICHORD	6	3	
027	COUPLED HARPSICHORD	6	4	○
028	HARPSICHORD & STRINGS	6	5	
Elec.Piano				
001	ELEC.PIANO 1	4	2	
002	ELEC.PIANO 2	4	3	
003	ELEC.PIANO 3	4	4	
004	ELEC.PIANO 4	4	5	○
005	ELEC.PIANO 5	4	6	○
006	60'S E.PIANO 1	4	7	
007	60'S E.PIANO 2	4	8	
008	60'S E.PIANO 3	4	9	○
009	60'S E.PIANO 4	4	10	○
010	ELEC.PIANO 6	4	11	
011	ELEC.PIANO 7	4	12	
012	ELEC.PIANO 8	4	13	
013	ELEC.PIANO 9	4	14	
014	ELEC.PIANO 10	4	15	
015	DIGITAL E.PIANO 1	5	2	
016	DIGITAL E.PIANO 2	5	3	
017	DIGITAL E.PIANO 3	5	4	
018	DIGITAL E.PIANO 4	5	5	
019	DIGITAL E.PIANO 5	5	6	
020	DIGITAL E.PIANO 6	5	7	
021	DIGITAL E.PIANO 7	5	8	
022	DIGITAL E.PIANO 8	5	9	
023	DIGITAL E.PIANO 9	5	10	
024	DYNO ELEC.PIANO 1	4	16	
025	DYNO ELEC.PIANO 2	4	17	○
026	60'S ELEC.PIANO 5	4	18	○
027	60'S ELEC.PIANO 6	4	19	○
028	CHORUS E.PIANO 1	4	20	
029	CHORUS E.PIANO 2	4	21	
030	PHASER E.PIANO 1	4	22	○
031	PHASER E.PIANO 2	4	23	○
032	AMP E.PIANO 1	4	24	○
033	AMP E.PIANO 2	4	25	○
034	CRUNCH E.PIANO	4	26	○
035	DIZZY E.PIANO	4	27	○
036	ANALOG E.PIANO 1	5	11	○

Group Number/ Número de grupo	Tone Name/ Nombre del tono	Program Change/ Cambio de programa	Bank Select MSB/ MSB de selección de banco	DSP
037	ANALOG E.PIANO 2	5	12	○
038	OFF VELO.CLAVI 1	7	2	
039	OFF VELO.CLAVI 2	7	3	
040	CLAVI 1	7	4	
041	CLAVI 2	7	5	
042	CLAVI 3	7	6	
043	CLAVI 4	7	7	
044	WAH CLAVI 1	7	8	○
045	WAH CLAVI 2	7	9	○
046	CRUNCH CLAVI	7	10	○
047	VIBRAPHONE 1	11	2	○
048	VIBRAPHONE 2	11	3	
049	MARIMBA	12	2	
050	CELESTA	8	2	
051	BRIGHT CELESTA	8	3	○
052	GLOCKENSPIEL	9	2	
053	MUSIC BOX 1	10	2	
054	MUSIC BOX 2	10	3	○
055	XYLOPHONE	13	2	
056	TUBULAR BELL	14	2	
057	DULCIMER	15	2	
Organ				
001	DRAWBAR ORGAN 1	16	2	○
002	DRAWBAR ORGAN 2	16	3	
003	DRAWBAR ORGAN 3	16	4	
004	DRAWBAR ORGAN 4	16	5	
005	JAZZ ORGAN 1	17	2	
006	JAZZ ORGAN 2	17	3	○
007	JAZZ ORGAN 3	17	4	
008	PERC.ORGAN 1	17	5	○
009	PERC.ORGAN 2	17	6	○
010	PERC.ORGAN 3	17	7	○
011	ROCK ORGAN 1	18	2	○
012	ROCK ORGAN 2	18	3	
013	ROCK ORGAN 3	18	4	
014	ELEC.ORGAN 1	16	6	○
015	ELEC.ORGAN 2	16	7	○
016	ELEC.ORGAN 3	16	8	
017	70'S ORGAN	17	8	○
018	OVERDRIVE ORGAN 1	16	9	○
019	OVERDRIVE ORGAN 2	16	10	○
020	TREMOLO ORGAN	16	11	○
021	FULL DRAWBAR	16	12	
022	ROTARY ORGAN	17	9	
023	CLICK ORGAN	17	10	○
024	SEQUENCE ORGAN	17	11	
025	GOSPEL ORGAN	17	12	○
026	PIPE ORGAN 1	19	2	
027	PIPE ORGAN 2	19	3	
028	CHAPEL ORGAN	19	4	
029	THEATER ORGAN	16	13	
030	REED ORGAN	20	2	
031	ACCORDION 1	21	2	
032	ACCORDION 2	21	3	
033	ACCORDION 3	21	4	
034	BANDONEON SOLO	23	4	
035	BANDONEON 1	23	2	
036	BANDONEON 2	23	3	
037	HARMONICA 1	22	2	
038	HARMONICA 2	22	3	
Guitar				
001	NYLON STR.GUITAR 1	24	2	
002	NYLON STR.GUITAR 2	24	3	
003	NYLON STR.GUITAR 3	24	4	○
004	STEEL STR.GUITAR 1	25	2	
005	STEEL STR.GUITAR 2	25	3	

Group Number/ Número de grupo	Tone Name/ Nombre del tono	Program Change/ Cambio de programa	Bank Select MSB/ MSB de selección de banco	DSP
006	STEEL STR.GUITAR 3	25	4	
007	12 STR.GUITAR	25	5	
008	STEEL GT HARMONICS	31	2	
009	JAZZ GUITAR	26	2	○
010	OCT JAZZ GUITAR	26	3	
011	CLEAN GUITAR 1	27	2	○
012	CLEAN GUITAR 2	27	3	○
013	CLEAN GUITAR 3	27	4	○
014	CLEAN GUITAR 4	27	5	
015	CHORUS CLEAN GUITAR 1	27	6	○
016	CHORUS CLEAN GUITAR 2	27	7	○
017	CRUNCH ELEC.GUITAR 1	27	8	○
018	CRUNCH ELEC.GUITAR 2	27	9	○
019	CRUNCH ELEC.GUITAR 3	27	10	○
020	CHORUS CRUNCH GUITAR	27	11	○
021	MUTE GUITAR 1	28	2	
022	MUTE GUITAR 2	28	3	
023	MUTE DIST.GUITAR	28	4	○
024	OVERDRIVE GUITAR 1	29	2	○
025	OVERDRIVE GUITAR 2	29	3	○
026	DISTORTION GT 1	30	2	○
027	DISTORTION GT 2	30	3	○
028	DISTORTION GT 3	30	4	○
029	DISTORTION GT 4	30	5	○
030	STEEL GT + STRUM.NOISE M 1	25	32	
031	STEEL GT + STRUM.NOISE M 2	25	33	
032	STEEL GT + STRUM.NOISE M 3	25	34	
033	CLEAN GUITAR M	27	32	
034	CRUNCH E.GUITAR M 1	27	33	
035	CRUNCH E.GUITAR M 2	27	34	
036	DISTORTION GT M	30	32	
037	OVERDRIVE GT M 1	29	32	
038	OVERDRIVE GT M 2	29	33	
039	MUTE OVERDRIVE GT M 1	28	32	
040	MUTE OVERDRIVE GT M 2	28	33	
Bass				
001	ACOUSTIC BASS 1	32	2	
002	ACOUSTIC BASS 2	32	3	○
003	RIDE BASS	32	4	
004	FINGERED BASS 1	33	2	
005	FINGERED BASS 2	33	3	○
006	FINGERED BASS 3	33	4	
007	FINGERED BASS 4	33	5	
008	PICKED BASS 1	34	2	
009	PICKED BASS 2	34	3	
010	SYNTH-BASS 1	38	2	
011	SYNTH-BASS 2	38	3	○
012	SYNTH-BASS 3	38	4	○
013	SYNTH-BASS 4	39	2	
014	SYNTH-BASS 5	39	3	○
015	SYNTH-BASS 6	39	4	○
016	TRANCE BASS	38	5	
017	ORGAN BASS	39	5	
018	FINGERED BASS M 1	33	32	
019	FINGERED BASS M 2	33	33	
020	SAW SYNTH-BASS M	39	32	
021	SYNTH-BASS M 1	38	32	
022	SYNTH-BASS M 2	38	33	
Strings				
001	STEREO STRINGS 1	49	2	
002	STEREO STRINGS 2	48	2	
003	STEREO STRINGS 3	48	3	
004	WIDE STRINGS	48	4	
005	STRINGS	48	5	
006	STRING ENSEMBLE 1	48	6	
007	STRING ENSEMBLE 2	48	7	
008	SLOW STRINGS	49	3	
009	BRIGHT STRINGS	48	8	○
010	WARM STRINGS	48	9	
011	PIZZICATO STRINGS	45	2	
012	CHAMBER	48	10	
013	OCTAVE STRINGS	48	11	
014	ORCHESTRA PAD	48	12	

Group Number/ Número de grupo	Tone Name/ Nombre del tono	Program Change/ Cambio de programa	Bank Select MSB/ MSB de selección de banco	DSP
015	SYNTH-STRINGS 1	50	2	○
016	SYNTH-STRINGS 2	50	3	
017	SYNTH-STRINGS 3	51	2	
018	70'S SYNTH-STR.	50	4	
019	80'S SYNTH-STR.	50	5	
020	FAST SYNTH-STRINGS	50	6	
021	SLOW SYNTH-STRINGS	50	7	
022	PHASER SYNTH-STRINGS	50	8	○
023	OCTAVE SYNTH-STRINGS	51	3	
024	VIOLIN	40	2	
025	SLOW VIOLIN	40	3	
026	VIOLA	41	2	
027	CELLO	42	2	
028	SLOW CELLO	42	3	
029	CONTRABASS	43	2	
030	HARP	46	2	
031	VIOLIN SECTION	48	13	
032	HARP & STRINGS	49	4	
033	CHOIR AAHS	52	2	
034	CHOIR STRINGS	52	3	
035	STRINGS VOICE	52	4	
036	SLOW CHOIR	52	5	
037	WAH CHOIR	52	6	○
038	VOICE DOO	53	2	
039	SYNTH-VOICE 1	54	2	
040	SYNTH-VOICE 2	54	3	
041	VOICE ENSEMBLE	54	4	
042	SYNTH-VOICE PAD	54	5	
043	CHORUS SYNTH-VOICE	54	6	○
044	ORCHESTRA HIT 1	55	2	
045	ORCHESTRA HIT 2	55	3	○
Brass				
001	STEREO BRASS	61	2	○
002	BRASS	61	3	
003	BRASS SECTION 1	61	4	
004	BRASS SECTION 2	61	5	
005	HARD BRASS	61	6	
006	BRASS SFZ	61	7	
007	BRASS & SAX	61	8	
008	SYNTH-BRASS 1	62	2	
009	SYNTH-BRASS 2	63	2	
010	SYNTH-BRASS 3	62	3	
011	WARM SYNTH-BRASS	62	4	
012	ANALOG SYNTH-BRASS	62	5	
013	80'S SYNTH-BRASS	62	6	
014	TRANCE BRASS	63	3	
015	CHORUS SYNTH-BRASS	62	7	○
016	SYNTH-BRASS PAD	63	4	
017	TRUMPET 1	56	2	○
018	TRUMPET 2	56	3	
019	MELLOW TRUMPET	56	4	
020	VELO.TRUMPET	56	5	
021	MUTE TRUMPET	59	2	
022	TROMBONE	57	2	
023	VELO.TROMBONE	57	3	
024	JAZZ TROMBONE	57	4	
025	FRENCH HORN	60	2	
026	FRENCH HORN SECTION	60	3	
027	TUBA	58	2	
Reed				
001	ALTO SAX	65	2	○
002	BREATHY ALTO SAX	65	3	○
003	TENOR SAX	66	2	○
004	BREATHY TENOR SAX	66	3	○
005	SOPRANO SAX	64	2	
006	BREATHY S.SAX	64	3	
007	BARITONE SAX	67	2	
008	HARD A.SAX	65	4	
009	SOFT T.SAX	66	4	
010	T.SAXYS	66	5	
011	CLARINET	71	2	
012	VELO.CLARINET	71	3	
013	OBOE	68	2	

Group Number/ Número de grupo	Tone Name/ Nombre del tono	Program Change/ Cambio de programa	Bank Select MSB/ MSB de selección de banco	DSP
014	ENGLISH HORN	69	2	
015	BASSOON	70	2	
016	FLUTE 1	73	2	○
017	FLUTE 2	73	3	
018	JAZZ FLUTE	73	4	
019	PICCOLO	72	2	
020	RECORDER	74	2	
021	PAN FLUTE	75	2	
022	BOTTLE BLOW	76	2	
023	WHISTLE	78	2	
024	OCARINA	79	2	
025	SHAKUHACHI	77	2	
Synth				
001	SAW LEAD 1	81	2	
002	SAW LEAD 2	81	3	○
003	SAW LEAD 3	81	4	
004	MELLOW SAW LEAD	81	5	
005	SLOW SAW LEAD	81	6	
006	PULSE SAW LEAD	81	7	
007	TRANCE LEAD	81	8	
008	SS LEAD	81	9	
009	SQUARE LEAD 1	80	2	
010	SQUARE LEAD 2	80	3	
011	SQUARE LEAD 3	80	4	○
012	SLOW SQUARE LEAD	80	5	
013	PHASER SQUARE LEAD	80	6	○
014	PULSE LEAD 1	80	7	
015	PULSE LEAD 2	80	8	
016	SINE LEAD	80	9	
017	VELO.SINE LEAD	80	10	
018	SQUARE PULSE LEAD	80	11	
019	VA SYNTH 1	80	12	
020	VA SYNTH 2	80	13	
021	VA SYNTH 3	80	14	
022	VA SYNTH 4	80	15	
023	VA SYNTH 5	80	16	
024	VA SYNTH SEQ-BASS 1	81	10	
025	VA SYNTH SEQ-BASS 2	81	11	○
026	SEQUENCE SAW	81	12	
027	SAW ARPEGGIO	81	13	
028	CALLIOPE	82	2	
029	VENT LEAD	82	3	
030	PIPE LEAD	82	4	
031	CHIFF LEAD	83	2	
032	VOICE LEAD	85	2	
033	VOX LEAD	85	3	
034	CHARANG	84	2	
035	PLUCK LEAD	84	3	
036	GT SYNTH-LEAD	84	4	
037	CHURCH LEAD	85	4	
038	DOUBLE VOICE LEAD	85	5	
039	SYNTH-VOICE LEAD	85	6	
040	FIFTH LEAD	86	2	
041	FIFTH SAW LEAD	86	3	
042	FIFTH SQUARE LEAD	86	4	
043	FOURTH LEAD	86	5	
044	SEVENTH SEQUENCE	86	6	
045	BASS+LEAD	87	2	
046	SYNTH-BASS+LEAD	87	3	
047	REED LEAD	87	4	
048	FANTASY 1	88	2	
049	FANTASY 2	88	3	○
050	NEW AGE	88	4	
051	WARM VOX	89	2	
052	WARM PAD	89	3	
053	HORN PAD	89	4	
054	POLYSYNTH	90	2	
055	POLYSYNTH PAD	90	3	○
056	SYNTH-PAD	90	4	
057	VA SYNTH-PAD 1	90	6	○
058	VA SYNTH-PAD 2	90	7	○
059	VA SYNTH-PAD 3	90	8	○
060	POLY SAW	90	9	

Group Number/ Número de grupo	Tone Name/ Nombre del tono	Program Change/ Cambio de programa	Bank Select MSB/ MSB de selección de banco	DSP
061	BRIGHT SAW PAD 1	90	10	
062	BRIGHT SAW PAD 2	90	11	
063	SPACE CHOIR	91	2	
064	STAR VOICE	91	3	○
065	GLASS PAD	92	2	
066	BOTTLE PAD	92	3	
067	ETHNIC PAD	93	2	
068	METAL PAD	93	3	
069	HALO PAD	94	2	
070	SWEEP PAD	95	2	
071	RAIN DROP	96	2	
072	WOOD PAD	96	3	
073	SOUND TRACK	97	2	
074	CRYSTAL	98	2	
075	VIBRAPHONE BELL	98	3	
076	ATMOSPHERE	99	2	
077	ATMOSPHERE PAD	99	3	
078	STEEL PAD	99	4	
079	BRIGHTNESS	100	2	
080	ECHO VOICE	102	2	
081	ECHO PAD	102	3	
082	POLY DROP	102	4	
083	STAR THEME	103	2	
084	SPACE PAD	103	3	
Ethnic				
001	SITAR 1	104	2	
002	SITAR 2	104	3	
003	TANPURA 1	104	4	
004	TANPURA 2	104	5	
005	HARMONIUM 1	20	3	
006	HARMONIUM 2	20	4	
007	SAROD	105	4	
008	SHANAI	111	3	
009	TABLA	116	16	
010	ER HU 1	110	16	
011	ER HU 2	110	17	
012	ER HU 3	110	18	
013	YANG QIN 1	15	3	
014	YANG QIN 2	15	4	
015	PI PA 1	105	5	
016	PI PA 2	105	6	
017	DI ZI 1	72	3	
018	DI ZI 2	72	4	
019	ZHENG 1	107	3	
020	ZHENG 2	107	4	
021	XIAO	77	5	
022	SHENG	109	3	
023	SUO NA	111	4	
024	CHINESE HARP	46	3	
025	LOUD 1	105	7	
026	LOUD 2	105	8	
027	NEY	72	5	
028	ARABIC ORGAN	16	14	
029	ARABIC STRINGS	48	14	
030	SAZ	15	5	
031	KANUN	15	6	
032	BANJO	105	2	
033	MUTE BANJO	105	3	
034	THUMB PIANO	108	2	
035	STEEL DRUMS	114	2	
036	RABAB	105	9	
037	SHAMISEN	106	2	
038	KOTO	107	2	
GM				
001	GM PIANO 1	0	0	
002	GM PIANO 2	1	0	
003	GM ELEC.GRAND PIANO	2	0	
004	GM HONKY-TONK	3	0	
005	GM E.PIANO 1	4	0	
006	GM E.PIANO 2	5	0	
007	GM HARPSICHORD	6	0	
008	GM CLAVI	7	0	
009	GM CELESTA	8	0	

Group Number/ Número de grupo	Tone Name/ Nombre del tono	Program Change/ Cambio de programa	Bank Select MSB/ MSB de selección de banco	DSP
010	GM GLOCKENSPIEL	9	0	
011	GM MUSIC BOX	10	0	
012	GM VIBRAPHONE	11	0	
013	GM MARIMBA	12	0	
014	GM XYLOPHONE	13	0	
015	GM TUBULAR BELL	14	0	
016	GM DULCIMER	15	0	
017	GM ORGAN 1	16	0	
018	GM ORGAN 2	17	0	
019	GM ORGAN 3	18	0	
020	GM PIPE ORGAN	19	0	
021	GM REED ORGAN	20	0	
022	GM ACCORDION	21	0	
023	GM HARMONICA	22	0	
024	GM BANDONEON	23	0	
025	GM NYLON STR.GUITAR	24	0	
026	GM STEEL STR.GUITAR	25	0	
027	GM JAZZ GUITAR	26	0	
028	GM CLEAN GUITAR	27	0	
029	GM MUTE GUITAR	28	0	
030	GM OVERDRIVE GT	29	0	
031	GM DISTORTION GT	30	0	
032	GM GT HARMONICS	31	0	
033	GM ACOUSTIC BASS	32	0	
034	GM FINGERED BASS	33	0	
035	GM PICKED BASS	34	0	
036	GM FRETLESS BASS	35	0	
037	GM SLAP BASS 1	36	0	
038	GM SLAP BASS 2	37	0	
039	GM SYNTH-BASS 1	38	0	
040	GM SYNTH-BASS 2	39	0	
041	GM VIOLIN	40	0	
042	GM VIOLA	41	0	
043	GM CELLO	42	0	
044	GM CONTRABASS	43	0	
045	GM TREMOLO STRINGS	44	0	
046	GM PIZZICATO	45	0	
047	GM HARP	46	0	
048	GM TIMPANI	47	0	
049	GM STRINGS 1	48	0	
050	GM STRINGS 2	49	0	
051	GM SYNTH-STRINGS 1	50	0	
052	GM SYNTH-STRINGS 2	51	0	
053	GM CHOIR AAHS	52	0	
054	GM VOICE DOO	53	0	
055	GM SYNTH-VOICE	54	0	
056	GM ORCHESTRA HIT	55	0	
057	GM TRUMPET	56	0	
058	GM TROMBONE	57	0	
059	GM TUBA	58	0	
060	GM MUTE TRUMPET	59	0	
061	GM FRENCH HORN	60	0	
062	GM BRASS	61	0	
063	GM SYNTH-BRASS 1	62	0	
064	GM SYNTH-BRASS 2	63	0	
065	GM SOPRANO SAX	64	0	
066	GM ALTO SAX	65	0	
067	GM TENOR SAX	66	0	
068	GM BARITONE SAX	67	0	
069	GM OBOE	68	0	
070	GM ENGLISH HORN	69	0	
071	GM BASSOON	70	0	
072	GM CLARINET	71	0	
073	GM PICCOLO	72	0	
074	GM FLUTE	73	0	
075	GM RECORDER	74	0	
076	GM PAN FLUTE	75	0	
077	GM BOTTLE BLOW	76	0	
078	GM SHAKUHACHI	77	0	
079	GM WHISTLE	78	0	
080	GM OCARINA	79	0	
081	GM SQUARE LEAD	80	0	
082	GM SAW LEAD	81	0	

Group Number/ Número de grupo	Tone Name/ Nombre del tono	Program Change/ Cambio de programa	Bank Select MSB/ MSB de selección de banco	DSP
083	GM CALLIOPE	82	0	
084	GM CHIFF LEAD	83	0	
085	GM CHARANG	84	0	
086	GM VOICE LEAD	85	0	
087	GM FIFTH LEAD	86	0	
088	GM BASS+LEAD	87	0	
089	GM FANTASY	88	0	
090	GM WARM PAD	89	0	
091	GM POLYSYNTH	90	0	
092	GM SPACE CHOIR	91	0	
093	GM BOWED GLASS	92	0	
094	GM METAL PAD	93	0	
095	GM HALO PAD	94	0	
096	GM SWEEP PAD	95	0	
097	GM RAIN DROP	96	0	
098	GM SOUND TRACK	97	0	
099	GM CRYSTAL	98	0	
100	GM ATMOSPHERE	99	0	
101	GM BRIGHTNESS	100	0	
102	GM GOBLINS	101	0	
103	GM ECHOES	102	0	
104	GM SF	103	0	
105	GM SITAR	104	0	
106	GM BANJO	105	0	
107	GM SHAMISEN	106	0	
108	GM KOTO	107	0	
109	GM THUMB PIANO	108	0	
110	GM BAGPIPE	109	0	
111	GM FIDDLE	110	0	
112	GM SHANAI	111	0	
113	GM TINKLE BELL	112	0	
114	GM AGOGO	113	0	
115	GM STEEL DRUMS	114	0	
116	GM WOOD BLOCK	115	0	
117	GM TAIKO	116	0	
118	GM MELODIC TOM	117	0	
119	GM SYNTH-DRUM	118	0	
120	GM REVERSE CYMBAL	119	0	
121	GM GT FRET NOISE	120	0	
122	GM BREATH NOISE	121	0	
123	GM SEASHORE	122	0	
124	GM BIRD	123	0	
125	GM TELEPHONE	124	0	
126	GM HELICOPTER	125	0	
127	GM APPLAUSE	126	0	
128	GM GUNSHOT	127	0	
Drums				
001	STANDARD SET 1	0	120	
002	STANDARD SET 2	1	120	
003	STANDARD SET 3	2	120	
004	STANDARD SET 4	3	120	
005	DANCE SET	29	120	
006	TRANCE SET	31	120	
007	HIP-HOP SET	9	120	
008	ROOM SET	8	120	
009	POWER SET	16	120	
010	ROCK SET	17	120	
011	ELECTRONIC SET	24	120	
012	SYNTH SET 1	25	120	
013	SYNTH SET 2	30	120	
014	JAZZ SET	32	120	
015	BRUSH SET	40	120	
016	ORCHESTRA SET	48	120	
017	ETHNIC SET 1	49	120	
018	ETHNIC SET 2	50	120	

NOTE

- With some guitar tones, playing in the lowest range (far left) or highest range (far right) may result in strum noise, harmonics, or other characteristic playing sounds being included with the notes.
- See the “Drum Assignment List” on page A-6 for information about the percussion instruments assigned to each keyboard key when a drum set is selected.

NOTA

- Con algunos tonos de guitarra, si toca en el rango más bajo (extremo izquierdo) o más alto (extremo derecho), podrían escucharse sonidos de rasgueo, de armónicos, u otros sonidos de ejecución característicos incluidos en las notas.
- Consulte “Lista de asignación de batería” de la página A-6 para obtener información acerca de los instrumentos de percusión asignados a cada tecla cuando se selecciona un ajuste de batería.

Drum Assignment List/Lista de asignación de batería

Key/Nota Número de clave/ Nota	STANDARD SET 1	STANDARD SET 2	STANDARD SET 3	STANDARD SET 4	DANCE SET	TRANCE SET	HIP-HOP SET	ROOM SET	POWER SET	ROCK SET	ELECTRONIC SET	SYNTH SET 1	SYNTH SET 2	JAZZ SET	BRUSH SET	ORCHESTRA SET	ETHNIC SET 1	ETHNIC SET 2
C-11	Tabla G				Dance Kick 1													
D-13	Tabla Te				Dance Kick 2													
E-15	Tabla Na				Dance Kick 3													
F-16	Tabla Na				Dance Kick 4													
F-17	Tabla Na				Dance Kick 5													
G-18	Drum Kit				Dance Snare 1													
H-19	Drum Kit				Dance Snare 2													
A-10	Drum Kit				Dance Snare 3													
A-11	Drum Kit				Dance Snare 4													
B-11	Drum Kit				Dance Snare 5													
B-12	Drum Kit				Dance Snare 6													
C-13	Drum Kit				Dance Snare 7													
C-14	Drum Kit				Dance Snare 8													
D-15	Drum Kit				Dance Snare 9													
E-16	Drum Kit				Dance Tambourine													
F-17	Drum Kit				Hi-Hop Snare 3													
F-18	Drum Kit				Hi-Hop Snare 4													
F-19	Drum Kit				Hi-Hop Rim Shot													
G-20	Drum Kit				Hi-Hop Snare 3 Rev.													
A-21	Drum Kit				Synth2 Kick 1 Rev.													
B-22	Drum Kit				Synth2 Kick 2 Rev.													
B-23	Drum Kit				Hi-Hop Snare 4 Gable													
B-24	Drum Kit				Hi-Hop Snare 3 Gable													
C-25	Drum Kit				Techno Snare Gate													
D-26	Drum Kit				Hi-Hop Snare 3 Gable													
E-27	Drum Kit				Hi-Hop Snare 4 Gable													
F-28	Drum Kit				Hi-Hop Snare 3 Gable													
G-29	Drum Kit				Hi-Hop Snare 4 Gable													
H-30	Drum Kit				Hi-Hop Snare 3 Gable													
I-31	Drum Kit				Hi-Hop Snare 4 Gable													
J-32	Drum Kit				Hi-Hop Snare 3 Gable													
K-33	Drum Kit				Hi-Hop Snare 4 Gable													
L-34	Drum Kit				Hi-Hop Snare 3 Gable													
M-35	Drum Kit				Hi-Hop Snare 4 Gable													
N-36	Drum Kit				Hi-Hop Snare 3 Gable													
O-37	Drum Kit				Hi-Hop Snare 4 Gable													
P-38	Drum Kit				Hi-Hop Snare 3 Gable													
Q-39	Drum Kit				Hi-Hop Snare 4 Gable													
R-40	Drum Kit				Hi-Hop Snare 3 Gable													
S-41	Drum Kit				Hi-Hop Snare 4 Gable													
T-42	Drum Kit				Hi-Hop Snare 3 Gable													
U-43	Drum Kit				Hi-Hop Snare 4 Gable													
V-44	Drum Kit				Hi-Hop Snare 3 Gable													
W-45	Drum Kit				Hi-Hop Snare 4 Gable													
X-46	Drum Kit				Hi-Hop Snare 3 Gable													
Y-47	Drum Kit				Hi-Hop Snare 4 Gable													
Z-48	Drum Kit				Hi-Hop Snare 3 Gable													
AA-49	Drum Kit				Hi-Hop Snare 4 Gable													
AB-50	Drum Kit				Hi-Hop Snare 3 Gable													
AC-51	Drum Kit				Hi-Hop Snare 4 Gable													
AD-52	Drum Kit				Hi-Hop Snare 3 Gable													
AE-53	Drum Kit				Hi-Hop Snare 4 Gable													
AF-54	Drum Kit				Hi-Hop Snare 3 Gable													
AG-55	Drum Kit				Hi-Hop Snare 4 Gable													
AH-56	Drum Kit				Hi-Hop Snare 3 Gable													
AI-57	Drum Kit				Hi-Hop Snare 4 Gable													
AJ-58	Drum Kit				Hi-Hop Snare 3 Gable													
AK-59	Drum Kit				Hi-Hop Snare 4 Gable													
AL-60	Drum Kit				Hi-Hop Snare 3 Gable													
AM-61	Drum Kit				Hi-Hop Snare 4 Gable													
AN-62	Drum Kit				Hi-Hop Snare 3 Gable													
AO-63	Drum Kit				Hi-Hop Snare 4 Gable													
AP-64	Drum Kit				Hi-Hop Snare 3 Gable													
AQ-65	Drum Kit				Hi-Hop Snare 4 Gable													
AR-66	Drum Kit				Hi-Hop Snare 3 Gable													
AS-67	Drum Kit				Hi-Hop Snare 4 Gable													
AT-68	Drum Kit				Hi-Hop Snare 3 Gable													
AU-69	Drum Kit				Hi-Hop Snare 4 Gable													
AV-70	Drum Kit				Hi-Hop Snare 3 Gable													
AW-71	Drum Kit				Hi-Hop Snare 4 Gable													
AX-72	Drum Kit				Hi-Hop Snare 3 Gable													
AY-73	Drum Kit				Hi-Hop Snare 4 Gable													
AZ-74	Drum Kit				Hi-Hop Snare 3 Gable													
BA-75	Drum Kit				Hi-Hop Snare 4 Gable													
BB-76	Drum Kit				Hi-Hop Snare 3 Gable													
BC-77	Drum Kit				Hi-Hop Snare 4 Gable													
BD-78	Drum Kit				Hi-Hop Snare 3 Gable													
BE-79	Drum Kit				Hi-Hop Snare 4 Gable													
BF-80	Drum Kit				Hi-Hop Snare 3 Gable													
BG-81	Drum Kit				Hi-Hop Snare 4 Gable													
BH-82	Drum Kit				Hi-Hop Snare 3 Gable													
BI-83	Drum Kit				Hi-Hop Snare 4 Gable													
BJ-84	Drum Kit				Hi-Hop Snare 3 Gable													

Key Note Number/ Numerical Clave/ nota	STANDARD SET 1	STANDARD SET 2	STANDARD SET 3	STANDARD SET 4	DANCE SET	TRANCE SET	HIP-HOP SET	ROOM SET	POWER SET	ROCK SET	ELECTRONIC SET	SYNTH SET 1	SYNTH SET 2	JAZZ SET	BRUSH SET	ORCHESTRA SET	ETHNIC SET 1	ETHNIC SET 2
C6 B5	Bell Tree	←	←	←	Hip-Hop Kick 3	←	←	←	←	←	←	←	←	←	←	←	←	Xiao Bo
C6 B5	Tubaan 2	←	←	←	Hip-Hop Kick 6	←	←	←	←	←	←	←	←	←	←	←	←	Mid Bang Gu
D6 F7	Ma Suro	←	←	←	Dance Sna 10	←	←	←	←	←	←	←	←	←	←	←	←	Mid Bang Gu
E6 B8	Open Suro	←	←	←	Hand Clap 3	←	←	←	←	←	←	←	←	←	←	←	←	High Ting Gu
E6 B8	Apause 1	←	←	←	Dance Sna 11	←	←	←	←	←	←	←	←	←	←	←	←	←
F6 B9	Apause 2	←	←	←	Elec Low Tom 2	←	←	←	←	←	←	←	←	←	←	←	←	←
G6 B9		←	←	←	Elec Low Tom 1	←	←	←	←	←	←	←	←	←	←	←	←	←
A6 B9		←	←	←	Hip-Hop Pedal H-Hat	←	←	←	←	←	←	←	←	←	←	←	←	←
A6 B9		←	←	←	Elec Mid Tom 2	←	←	←	←	←	←	←	←	←	←	←	←	←
A6 B9		←	←	←	Elec Mid Tom 1	←	←	←	←	←	←	←	←	←	←	←	←	←
C7 B7		←	←	←	Elec H. Tom 2	←	←	←	←	←	←	←	←	←	←	←	←	←
D7 B7		←	←	←	Elec H. Tom 1	←	←	←	←	←	←	←	←	←	←	←	←	←
E7 B7		←	←	←	Techno Cymbal	←	←	←	←	←	←	←	←	←	←	←	←	←
E7 B7		←	←	←	Techno Hi-Hat	←	←	←	←	←	←	←	←	←	←	←	←	←
E7 B7		←	←	←	Techno Ride	←	←	←	←	←	←	←	←	←	←	←	←	←
F7 B7		←	←	←	Low Tom 2	←	←	←	←	←	←	←	←	←	←	←	←	←
F7 B7		←	←	←	Crash Cymbal	←	←	←	←	←	←	←	←	←	←	←	←	←
G7 B7		←	←	←	Low Tom 1	←	←	←	←	←	←	←	←	←	←	←	←	←
A7 B7		←	←	←	Pedal H-Hat	←	←	←	←	←	←	←	←	←	←	←	←	←
B7 B7		←	←	←	Mid Tom 2	←	←	←	←	←	←	←	←	←	←	←	←	←
B7 B7		←	←	←	Mid Tom 1	←	←	←	←	←	←	←	←	←	←	←	←	←
B7 B7		←	←	←	Open H-Hat	←	←	←	←	←	←	←	←	←	←	←	←	←
B7 B7		←	←	←	Mid Tom	←	←	←	←	←	←	←	←	←	←	←	←	←
C8 B8	Tubaan 1	←	←	←	High Tom 2	←	←	←	←	←	←	←	←	←	←	←	←	←
D8 B8	Tubaan 2	←	←	←	Crash Cymbal 1	←	←	←	←	←	←	←	←	←	←	←	←	←
E8 B8	Ma Suro 3	←	←	←	High Tom 1	←	←	←	←	←	←	←	←	←	←	←	←	←
F8 B8	Dal 1	←	←	←	High Cymbal 1	←	←	←	←	←	←	←	←	←	←	←	←	←
F8 B8	Dal 2	←	←	←	Tomboone 2	←	←	←	←	←	←	←	←	←	←	←	←	←
G8 B8	Rq 1	←	←	←	Tomboone 3	←	←	←	←	←	←	←	←	←	←	←	←	←
G8 B8	Rq 2	←	←	←	Tomboone 4	←	←	←	←	←	←	←	←	←	←	←	←	←
A8 B8	Rq 3	←	←	←	Minacas 2	←	←	←	←	←	←	←	←	←	←	←	←	←
B8 B8	Dawl 1	←	←	←	Claves 2	←	←	←	←	←	←	←	←	←	←	←	←	←
B8 B8	Dawl 2	←	←	←	Mute Triangle 2	←	←	←	←	←	←	←	←	←	←	←	←	←
C9 B9	Dawl 3	←	←	←	Mute Triangle 1	←	←	←	←	←	←	←	←	←	←	←	←	←
D9 B9	Zil 1	←	←	←	Shaker 2	←	←	←	←	←	←	←	←	←	←	←	←	←
D9 B9	Zil 2	←	←	←	Shaker 1	←	←	←	←	←	←	←	←	←	←	←	←	←
E9 B9	Ban Gu	←	←	←	Hand Clap 2	←	←	←	←	←	←	←	←	←	←	←	←	←
F9 B9	Hu Yin Luo	←	←	←	Hand Clap 1	←	←	←	←	←	←	←	←	←	←	←	←	←
F9 B9	Xiao Bao	←	←	←	Hand Clap 2	←	←	←	←	←	←	←	←	←	←	←	←	←
G9 B9	Low Bang Gu	←	←	←	Hand Clap 1	←	←	←	←	←	←	←	←	←	←	←	←	←
G9 B9	Mid Bang Gu	←	←	←	Hand Clap 2	←	←	←	←	←	←	←	←	←	←	←	←	←
G9 B9	High Ting Gu	←	←	←	Hand Clap 1	←	←	←	←	←	←	←	←	←	←	←	←	←

• “←” indicates a key is assigned the same tones as it is for STANDARD SET 1.

• “←” indica una clave asignada a los mismos tonos que para STANDARD SET 1.

Rhythm List/Lista de ritmos

Group Number/ Número de grupo	Rhythm name/ Nombre del ritmo
Pops	
001	POP ROCK 1
002	POP
003	ELECTROPOP
004	FUNK 8 BEAT
005	UK BEAT
006	6/8 POP
007	ACOUSTIC GUITAR POP
008	POP ROCK 2
009	SLOW SOUL
010	FAST SOUL
011	60's SOUL
012	OLDIES SOUL
013	60's POP
014	60's SHUFFLE
015	POP SHUFFLE
8 Beat	
001	STRAIGHT 8 BEAT
002	MELLOW 8 BEAT
003	GUITAR 8 BEAT
004	FAST 8 BEAT
005	8 BEAT
006	OLDIES 8 BEAT
007	60's 8 BEAT
16 Beat	
001	16 BEAT
002	FUNK 16 BEAT
003	16 BEAT SHUFFLE
004	FUNK SHUFFLE
005	LATIN FUSION
Rock	
001	STRAIGHT ROCK
002	SHUFFLE ROCK
003	6/8 ROCK
004	SHUFFLE BLUES
005	SLOW BLUES
006	ROCK BLUES
007	6/8 BLUES
008	EP BLUES
009	R&B
010	SOFT ROCK
011	LATIN ROCK
012	ORGAN ROCK
013	70's PIANO ROCK
014	ROCK
015	60's ROCK 1
016	60's ROCK 2
017	OLDIES ROCK
018	SLOW ROCK
019	ROCK & ROLL
020	50's PIANO ROCK
021	50's ROCK
022	NEW ORLNS R&R
Dance	
001	PIANO HIP-HOP
002	HIP-HOP
003	DANCE POP
004	DISCO POP
005	TECHNO POP
006	TRANCE

Group Number/ Número de grupo	Rhythm name/ Nombre del ritmo
007	MODERN R&B
008	MODERN DANCE
009	DISCO SOUL
Jazz	
001	SLOW BIG BAND
002	MIDDLE BIG BAND
003	FAST BIG BAND
004	ORCHESTRA SWING
005	SWING
006	SLOW SWING
007	JAZZ WALTZ
008	FOX TROT
009	QUICKSTEP
010	JAZZ COMBO 1
European	
001	SCHLAGER
002	POLKA
003	WALTZ 1
004	WALTZ 2
005	SLOW WALTZ
006	VIENNESE WALTZ
007	FRENCH WALTZ
008	SERENADE
009	TANGO
010	MARCH 1
011	MARCH 2
Latin	
001	BOSSA NOVA
002	SLOW BOSSA NOVA
003	BEGUINE
004	SAMBA 1
005	SAMBA 2
006	MAMBO
007	RHUMBA
008	CHA-CHA-CHA
009	MERENGUE
010	BOLERO
011	SALSA 1
012	SALSA 2
013	REGGAE
014	POP REGGAE
015	SKA
016	REGGAETON 1
017	REGGAETON 2
018	CUMBIA
019	CALYPSO
020	FORRO
021	PAGODE
022	BANDA
023	PASILLO
024	ARGENTINE CUMBIA
025	PUNTA
026	BACHATA
World	
American	
001	DIXIE
002	TEX-MEX
003	FAST GOSPEL
004	SLOW GOSPEL
005	HAWAIIAN

Group Number/ Número de grupo	Rhythm name/ Nombre del ritmo
Spanish/Eastern European	
006	PASODOBLE
007	CAUCASIAN
008	RUSSIAN CHANSON 1
009	RUSSIAN CHANSON 2
010	POLISH WALTZ
Arabic/Oriental	
011	MALFOUF
012	BALADI
013	KHALJI
014	ADANI
015	MUS
016	SIRTAKI
Indian	
017	BHANGRA
018	DADRA
019	GARBA
020	KEHARWA
021	DANDIYA
022	TEEN TAAL
023	BHAJAN
Chinese	
024	GUANGDONG
025	JIANGNAN
026	BEIJING
027	DONGBEIJANGGE
028	JINGJU
029	HUANGMEIXI
030	QINQIANG
031	YUJU
032	YAOZU
033	DAIZU
034	MIAOZU
035	MENGGU
036	XINJIANG
037	ZANGZU
038	CHINESE POP
Southeast Asian	
039	KRONCONG
040	DANGDUT
Japanese	
041	ENKA
Country	
001	MODERN COUNTRY
002	COUNTRY 8 BEAT
003	COUNTRY 16 BEAT
004	COUNTRY BALLAD
005	COUNTRY SHUFFLE 1
006	COUNTRY SHUFFLE 2
007	FINGER PICKING COUNTRY
008	COUNTRY WALTZ
009	BLUEGRASS
Various	
001	CHRISTMAS SONG
002	CHRISTMAS WALTZ
003	SCREEN SWING
004	SYMPHONY
005	STR QUARTET
Ballad	
001	PIANO ROCK BALLAD
002	90's BALLAD
003	MODERN BALLAD
004	ELECTRIC BALLAD
005	SLOW BALLAD 1

Group Number/ Número de grupo	Rhythm name/ Nombre del ritmo
006	SLOW BALLAD 2
007	R&B BALLAD
008	16 BEAT BALLAD
009	BRUSH BALLAD
010	POP BALLAD
011	PIANO WALTZ BALLAD
012	90's 6/8 BALLAD
013	6/8 BALLAD 1
014	6/8 BALLAD 2
015	EASY LISTENING BALLAD
016	UNPLUGGED BALLAD
017	ROCK BALLAD 1
018	ROCK BALLAD 2
019	6/8 ROCK BALLAD
020	OLDIES BALLAD
Piano Rhythms	
001	PIANO 8 BEAT
002	PIANO BALLAD 1
003	PIANO BALLAD 2
004	EP BALLAD 1
005	EP BALLAD 2
006	BLUES BALLAD
007	JAZZ COMBO 2
008	JAZZ COMBO 3
009	RAGTIME
010	BOOGIE-WOOGIE
011	PIANO ROCK & ROLL
012	ARPEGGIO 1
013	ARPEGGIO 2
014	ARPEGGIO 3
015	PIANO MARCH 1
016	PIANO MARCH 2
017	STRIDE PIANO
018	WALTZ 3
019	WALTZ 4
020	WALTZ 5

NOTE

- The rhythms of Piano Rhythms 011 to 020 do not sound unless a chord is being played.

NOTA

- Los ritmos de piano 011 a 020 no suenan a menos que se toque un acorde.

Music Preset List/Lista de preajustes musicales

Group Number/ Número de grupo	Preset Name/ Nombre de preajuste
Pops	
001	Soft Pop
002	Winter Pop
003	Oldies Pop
004	Alpine Flora
005	Gypsy
006	Rain Pop
007	Movie Waltz
008	Funky Pop
009	Love Pop
010	60's Pop
011	Rising Sun
012	Pop Ska
013	Weep Blues
014	Cartoon
015	Carol
016	My Life
017	Blue Love
018	Xmas Pop
019	Shuffle Pop1
020	Shuffle Pop2
021	70's Soul
022	70's Pop
023	West Coast
024	Bossa Pop
025	Radio Pop
026	Crazy Roll
027	80's Pop 1
028	80's Pop 2
029	UK Pop 1
030	UK Pop 2
031	A Feeling
032	Calling
033	80's EuroPop
034	The World
035	Mexican Pop
036	Guitar Pop
037	90's Pop
038	Wonder
039	Modern Pop 1
040	Modern Pop 2
041	MdmPopRock
042	Basic 1
043	Basic 2
044	Basic 3
045	Basic 4
046	Basic 5
Dance	
001	Funky Disco
002	Funky Clavi
003	Disco Soul
004	70's Disco
005	Disco Lady
006	Staying
007	Up&Down
008	80's Disco
009	80'sDancePop
010	Bb Girl
011	Blv Disco
012	Lady Jam
013	Into Your H
014	Euro Pop
015	Modern Dance
016	Trance
017	ShuffleDance
Rock	
001	50's Rock 1
002	50's Rock 2
003	Heartache
004	EP R&R
005	Pop R&B
006	60's Rock 1
007	60's Rock 2
008	60's Rock 3
009	60's Rock 4
010	60's Rock 5
011	Get Rock













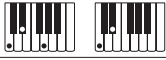























Group Number/ Número de grupo	Preset Name/ Nombre de preajuste
012	Honky Rock
013	Wild Rock
014	Alligator
015	Movie Rock
016	Pop Rock
017	16Bt Shuffle
018	Heat Up
019	Hard Rock
020	Grunge Rock
021	Modern Rock
022	R&R
023	Piano R&R
024	Blues
025	8 Bars Blues
026	Riff Rock 1
027	Riff Rock 2
028	Riff Rock 3
Jazz	
001	My Swing
002	Your Things
003	Angel
004	Time Passes
005	Piano Trio
006	Goodbye
007	Marine Dance
008	Vine Days
009	TraneChanges
010	RhythmChange
011	Swing Mood
012	The Big Mood
013	Brown Jug
014	Jazz Club
015	All Day Long
016	Avenue
017	Big Band 1
018	Big Band 2
019	Jazz Waltz 1
020	Jazz Waltz 2
021	Jazz Waltz 3
022	Mode Jazz
023	Tea Time
024	Welcome Home
025	Jazz Opera
026	NY City
027	Soul & Jazz
028	Loneliness
029	Foggy
030	Moon Swing
031	Jazz Ballad1
032	Jazz Ballad2
033	Jazz Ballad3
034	PatheticTrip
035	Night Sky
036	Twilight
037	Blues in F
038	Blues in Bb
039	Blues in C
040	Il-V
041	Il-V-I
042	Minor Blues
Classic	
001	Canon
002	Air G String
003	Je Te Veux
004	Adagio
005	Spring
006	Ave Maria
007	JesusBleibet
008	Symphony 25
009	Symphony 40
010	HungriaDance
011	Eine Kleine
012	Pathetique
013	Moonlight
014	PstlSymphony
015	Ode To Joy
016	Le Cygne

Group Number/ Número de grupo	Preset Name/ Nombre de preajuste
017	Swan Lake
018	Valse Fleurs
019	Habanera
020	Nocturne
021	Etude
022	FrenchCancan
023	Fantaisielmp
024	Humoresque
025	Pavane
026	Hope & Glory
027	Moldau
028	FromNewWorld
029	Reverie
030	Nutcracker
031	Liebestraume
032	Gymnopedies
033	Jupiter
034	Entertainer
035	MapleLeafRag
Trad	
001	Michael Row
002	GrndpasClock
003	Troika
004	AuldLangSyne
005	Aloha Oe
006	O Sole Mio
007	Furusato
008	SziaDziweczka
009	Battle Hymn
010	Condor
011	ScarboroFair
012	Danny Boy
013	Greensleeves
014	Annie Laurie
015	AmazingGrace
016	WeWishU Xmas
017	Silent Night
018	Joy To World
019	YankeeDoodle
020	Clarnt Polka
021	TaRaRaBoom
022	Double Eagle
023	Blauen Donau
024	Yellow Rose
025	BeautDreamer
Latin	
001	Satellite
002	Rio
003	Aqua
004	Single
005	Sea Shore
006	Poor Pitch
007	Mountain
008	Heartless
009	Carnival
010	Mythology
011	Tico-Tico
012	Beguine
013	Amapola
014	La Paloma
015	Banana Boat
016	Peanut
017	A Cup Of
018	Jamaica
019	60's Movie 1
020	60's Movie 2
021	The No.5
022	Everyday
023	Kiss Me
024	El Tango
025	El Choclo
026	Reggae 1
027	Reggae 2
028	Pop Reggae 1
029	Pop Reggae 2
030	Latin Rock 1
031	Latin Rock 2
032	Modern Latin
Country	
001	US Folk 1
002	US Folk 2
003	50's Country

Group Number/ Número de grupo	Preset Name/ Nombre de preajuste
004	70's Country
005	60's Folk
006	Tree
007	A Friend
008	Cowboy
009	Country Bld1
010	Country Bld2
011	Country Bld3
012	CountryWaltz
013	Mdm Country
Ballad	
001	Love Ballad
002	R&B Ballad
003	Soul Ballad
004	Blues Ballad
005	MovieBallad1
006	MovieBallad2
007	MovieBallad3
008	Xmas Ballad
009	Love Me
010	Oldies Bld 1
011	Oldies Bld 2
012	Oldies Bld 3
013	Oldies Bld 4
014	E World
015	Guitar Bld 1
016	Guitar Bld 2
017	Moon Waltz
018	Theme
019	Paradise
020	60's Ballad1
021	60's Ballad2
022	Baroque Bld
023	FrenchBallad
024	Everywhere
025	Wonderful
026	70's Ballad1
027	70's Ballad2
028	70's Ballad3
029	My Song
030	Peace
031	Without
032	Soundtrack
033	Soft Ballad
034	Memories
035	Minor Ballad
036	Pop Ballad 1
037	Pop Ballad 2
038	PianoBallad1
039	PianoBallad2
040	Musical Bld
041	R Ballad
042	Love Song
043	80's Ballad1
044	80's Ballad2
045	80's Ballad3
046	80's Ballad4
047	Friends
048	Rock Ballad1
049	Rock Ballad2
050	Two Flames
051	90's Ballad1
052	90's Ballad2
053	90's Ballad3
054	90's SoulBld
055	I Always
056	6/8 Ballad
057	Wind Ballad
058	90's 6/8 Bld
059	My Ballad
060	MdmSoulBld1
061	MdmSoulBld2
062	Mdm Pf Bld
063	Rap Ballad
064	Dance Ballad
065	MdmRock Bld
066	Slow Ballad
067	90's R&B Bld

Fingering Guide/Guía de digitación

Fingered 1, Fingered 2 Chords/Acordes Fingered 1, Fingered 2

C		C6 *1 *3	
Cm		Cm6 *2 *3	
Cdim		Cadd9	
Caug *3		Cmadd9	
C_b5		C69 *3	
Csus4 *3		Cm69 *3	
Csus2 *3		C7 (b9)	
C7		C7 (9)	
Cm7 *3		C7 (#9)	
CM7		C7 (#11)	
CmM7		C7 (b13)	
Cdim7 *3		C7 (13)	
CdimM7		Cm7 (9)	
C7_b5 *3		Cm7 (11) *3	
Cm7_b5 *3		CM7 (9)	
CM7_b5		CmM7 (9)	
Caug7		C5 (Root and 5th only) *4 (La raíz y la 5ta. solamente) *4	
CaugM7		C8 (Root only, or root plus octave) *4 (La raíz solamente o la raíz más la octava) *4	
C7sus4			

*1 With Fingered 2, interpreted as Am7.

*2 With Fingered 2, interpreted as Am7⁵.

*3 Inverted form not supported in some cases.

*4 Full Range Chord not supported.

*1 Con Fingered 2, se interpreta como Am7.

*2 Con Fingered 2, se interpreta como Am7⁵.

*3 En algunos casos no se puede usar de forma invertida.

*4 No es compatible con Full Range Chord.

Fingered 3, Full Range Chords/ Acordes Fingered 3, Full Range

In addition to the chords that can be fingered with Fingered 1 and Fingered 2, the following chords also are recognized.

Además de los acordes que se pueden digitar con Fingered 1 y Fingered 2, también se pueden reconocer los siguientes acordes.

$\frac{C\#}{C}$	$\frac{D}{C}$	$\frac{F}{C}$	$\frac{F\#}{C}$	$\frac{G}{C}$	$\frac{A^b}{C}$	$\frac{A}{C}$	$\frac{B^b}{C}$	$\frac{C\#m}{C}$	$\frac{Dm}{C}$	$\frac{Fm}{C}$
$\frac{F\#m}{C}$	$\frac{Gm}{C}$	$\frac{A^bm}{C}$	$\frac{Am}{C}$	$\frac{B^bm}{C}$	$\frac{Bm}{C}$	$\frac{C\#dim}{C}$	$\frac{Ddim}{C}$			
$\frac{Fdim}{C}$	$\frac{F\#din}{C}$	$\frac{Gdim}{C}$	$\frac{A^bdin}{C}$	$\frac{Adin}{C}$	$\frac{Bdin}{C}$	$\frac{A^b7}{C}$	$\frac{F7}{C}$			
$\frac{Fm7}{C}$	$\frac{FM7}{C}$	$\frac{A^bM7}{C}$	$\frac{F\#m7^b5}{C}$	$\frac{Gm7}{C}$	$\frac{A^badd9}{C}$					

NOTE

- With Fingered 3, the lowest note fingered is interpreted as the base note. Inverted forms are not supported.
- With Full Range Chord, when the lowest fingered is a certain distance from the neighboring note, the chord is interpreted as a fraction chord.
- Unlike Fingered 1, 2, and 3, Full Range Chord requires pressing of at least three keys to form a chord.

NOTA

- Con Fingered 3, la nota más baja digitada se interpreta como nota base. No se pueden usar formas invertidas.
- Con Full Range Chord, cuando la nota digitada más baja se encuentre a cierta distancia de la nota adyacente, el acorde se interpreta como un acorde bitonal.
- A diferencia de Fingered 1, 2, y 3, Full Range Chord requiere la pulsación de tres teclas como mínimo para formar un acorde.

Parameter List/Lista de parámetros

To check this setting item:/Para comprobar este elemento de ajuste:	Refer to this column in the table below:/ Vea esta columna de la siguiente tabla:
Setting items that are always saved when power is turned off/ Elementos de ajuste que se almacenan siempre al cortar la alimentación	①
When "On" is selected for the "Auto Resume" setting (page EN-46), setting items that are restored to those in effect the last time power was turned off/ Cuando se selecciona "On" para el ajuste "Auto Resume" (página ES-46), los elementos de ajuste se restablecen a los que estaban en efecto la última vez que se desconectó la alimentación	②
Setting items stored by Registration (page EN-27)./ Elementos de ajuste que se almacenan mediante Registro (página ES-27).	③
Setting items changed by One Touch Preset (page EN-23)./ Elementos de ajuste que se modifican mediante Preajuste de un toque (página ES-23).	④
Setting items changed when a Grand Piano tone is selected (page EN-14)./ Elementos de ajuste que se modifican cuando se seleccionan tonos de piano de cola (página ES-14).	⑤
Setting items changed by Music Preset (page EN-26)./ Elementos de ajuste que se modifican mediante Preajuste musical (página ES-26).	⑥

Setting Item/ Elemento de ajuste	①	②	③	④	⑤	⑥
System Setting						
Speaker		○				
External Speaker	○					
Touch Response		○	○			
Touch Off Velocity		○	○			
Metronome Count		○				
Accomp Freeze		○				
Tuning		○				
Temperament		○				
Temperament Base Note		○				
Accomp Temperament		○				
Stretch Tuning		○				
Brightness	○					
Operation Lock		○				
Auto Resume	○					
N.Gate Thrash		○				
Duet						
On/Off		○	○	○	○	○*3
Octave		○	○			
Duet Pan		○	○			
Controller						
Upper 1 Pedal		○	○			
Upper 2 Pedal		○	○			
Lower 1 Pedal		○	○			
Lower 2 Pedal		○	○			
Bend Range		○	○			
MIDI						
Keyboard Channel		○				
Accomp Out		○				
Chord Judge		○				
Hi-Res Vel Out		○				
Local Control						
MIDI In Port		○				
Main/Tone Setting						
Split Point		○	○			
Transpose		○	○			
Part On/Off		○	○	○	○	○
Part Octave		○	○	○	○	○
Mixer (Mixer setting for Part 1 to Part 5 of Port A/ Ajuste del mezclador de la Parte 1 a la Parte 5 del puerto A)						
Tone		○	○	○	○	○
Volume		○	○	○	○	○
Pan		○	○	○	○	○
Coarse Tune		○	○	○	○	○

Setting Item/ Elemento de ajuste	①	②	③	④	⑤	⑥
Fine Tune		○	○	○	○	○
Bend Range		○	○	○	○	○
Reverb Send		○	○	○	○	○
Chorus Send		○	○	○	○	○
Delay Send		○	○	○	○	○
Part On/Off						
Effect						
Brilliance		○	○	○	○	○
Reverb Type		○	○	○	○	○
Chorus Type		○	○	○	○	○
Delay Type		○	○	○	○	○
Rhythm						
Rhythm No		○	○*1		○	○
Accomp On/Off		○	○*1	○	○	
Chord input Type		○	○*1		○	
Synchro state			○*1	○	○	○
Tempo		○	○*1	○	○	○
Accomp Part on/off		○	○*1		○	○
Harmonize on/off		○	○		○	○
Harmonize Type		○	○		○	○
Auto Chord		○	○*1	○	○	
Music Preset Key Shift		○	○*1			
Music Preset			○*1&2			○*2
Balance						
Accomp Volume		○	○*1			
MIDI Volume		○				
Keyboard Volume		○				
Audio Volume		○				
Metronome Volume		○				
Other						
Registration Bank		○				

*1 Not changed when Accomp Freeze is enabled.

*2 Recalls chord progression stored to the applicable number.

*3 Selecting a Music Preset exits the Duet Mode.

*1 No se modifica con "Accomp Freeze" (Acompañamiento congelado) habilitado.

*2 Llama la progresión de acordes correspondiente al número aplicable.

*3 Si se selecciona un preajuste musical se sale del modo dúo.

Chord Example List/Lista de ejemplos de acordes

Root Chord Type	C	C [#] /(D ^b)	D	(D [#])/E ^b	E	F	F [#] /(G ^b)	G	(G [#])/A ^b	A	(A [#])/B ^b	B
M												
m												
dim												
aug												
♭5												
sus4												
sus2												
7												
m7												
M7												
mM7												
dim7												
dimM7												
7 ^{♭5}												
m7 ^{♭5}												
M7 ^{♭5}												
aug7												
augM7												
7sus4												

Root Chord Type	C	C \sharp /(D \flat)	D	(D \sharp)/E \flat	E	F	F \sharp /(G \flat)	G	(G \sharp)/A \flat	A	(A \sharp)/B \flat	B
6												
m6												
add9												
madd9												
69												
m69												
7 (9)												
7 (9)												
7 (#11)												
7 (b13)												
7 (13)												
m7 (9)												
m7 (11)												
M7 (9)												
mM7 (9)												
5												
8												

- Since the chord input range is limited, this model may not support some of the chords shown above.
- Debido a que el rango de entrada de acordes es limitado, es posible que este modelo no admita algunos de los acordes mostrados arriba.

Part and MIDI Channel Assignments/ Asignaciones de las partes y de los canales MIDI

■ Port A: Keyboard, Auto Accompaniment play, other/ Puerto A: Teclado, reproducción del acompañamiento automático, otros

Part No./ Nº de la parte	MIDI Channel/ Canal MIDI *1	Function/Función
1	In:1 Out:01 *2	Upper1
2	In:2 Out:02	Upper2
3	In:3 Out:03	Lower1
4	In:4 Out:04	Lower2
5	In:5 Out:05	Auto Harmonize
6	In:6	–
7	In:7	–
8	In:8	Metronome
9	In:9 Out:09	Accomp Percussion *3
10	In:10 Out:10	Accomp Drum *3
11	In:11 Out:11	Accomp Bass *3
12	In:12 Out:12	Accomp Chord1 *3
13	In:13 Out:13	Accomp Chord2 *3
14	In:14 Out:14	Accomp Chord3 *3
15	In:15 Out:15	Accomp Chord4 *3
16	In:16 Out:16	Accomp Chord5 *3

■ Port B: MIDI Recorder system track playback/ Puerto B: Reproducción de la pista del sistema del grabador MIDI

Part No./ Nº de la parte	MIDI Channel/ Canal MIDI *1	Function/Función
1	In:1	MIDI Recorder System Track Upper1
2	In:2	MIDI Recorder System Track Upper2
3	In:3	MIDI Recorder System Track Lower1
4	In:4	MIDI Recorder System Track Lower2
5	In:5	MIDI Recorder System Track Auto Harmonize
6	In:6	–
7	In:7	–
8	In:8	–
9	In:9	–
10	In:10	–
11	In:11	–
12	In:12	–
13	In:13	–
14	In:14	–
15	In:15	–
16	In:16	–

■ Port C: MIDI Recorder solo track playback/ Puerto C: Reproducción de solo pista del grabador MIDI

Part No./ Nº de la parte	MIDI Channel/ Canal MIDI *1	Function/Función
1	In:1	MIDI Recorder Solo Track 1
2	In:2	MIDI Recorder Solo Track 2
3	In:3	MIDI Recorder Solo Track 3
4	In:4	MIDI Recorder Solo Track 4
5	In:5	MIDI Recorder Solo Track 5
6	In:6	MIDI Recorder Solo Track 6
7	In:7	MIDI Recorder Solo Track 7
8	In:8	MIDI Recorder Solo Track 8
9	In:9	MIDI Recorder Solo Track 9
10	In:10	MIDI Recorder Solo Track 10
11	In:11	MIDI Recorder Solo Track 11
12	In:12	MIDI Recorder Solo Track 12
13	In:13	MIDI Recorder Solo Track 13
14	In:14	MIDI Recorder Solo Track 14
15	In:15	MIDI Recorder Solo Track 15
16	In:16	MIDI Recorder Solo Track 16

*1 The port that accepts MIDI In messages depends on the MIDI In port setting.

*2 The MIDI Out channel number of Port A Part 1 depends on the keyboard channel setting.

*3 Also used for Auto Accompaniment play by MIDI Recorder system track playback.

*1 El puerto que acepta los mensajes de entrada MIDI depende del ajuste del puerto de entrada MIDI.

*2 El número del canal de salida MIDI del Puerto A Parte 1 depende del ajuste del canal del teclado.

*3 También se utiliza para la ejecución del acompañamiento automático mediante la reproducción de la pista del sistema del grabador MIDI.

- Cut this page along the dashed line so you can have it on hand as you read the contents of the manual.
- Recorte esta página por la línea de puntos para tenerla a mano mientras continúa leyendo este manual.

CGP-700

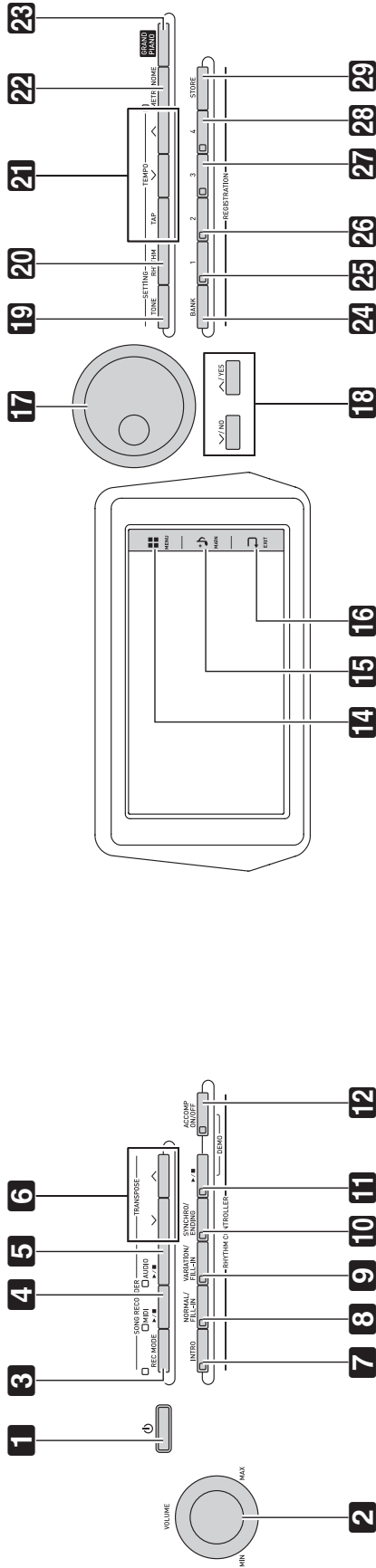

MIDI Implementation Chart

Function	Transmitted	Recognized	Remarks
Basic Channel Default Changed	1 - 16 1 - 16	1 - 16 1 - 16	
Mode Default Messages Altered	Mode 3 X * * * * * * * * * *	Mode 3 X * * * * * * * * * *	
Note Number True voice	0 - 127 * * * * * * * * * *	0 - 127 0 - 127*1	
Velocity Note ON Note OFF	0 9nH v = 1 - 127 X 8nH v = 64	0 9nH v = 1 - 127 X 9nH v = 0, 8nH v = **	** : no relation ** : sin relation
After Touch Key's Ch's	X X	X O	
Pitch Bender	O	O	
Control Change	0,32 1 5 6,38 7 10 11 19 19 18 19 64 65 66	O X X O O X X X X X X X X X O X O	Bank select Modulation Portamento Time Data entry LSB, MSB*2 Volume Pan Expression Parameter0*2 Parameter1*2 DSP Parameter*2 DSP Parameter2*2 DSP Parameter3*2 Damp Portamento Switch Sostenuto

67 76 77 80 81 82 83 84 88 91 92 94 100, 101	<input checked="" type="checkbox"/> <input checked="" type="checkbox"/> <input checked="" type="checkbox"/> <input checked="" type="checkbox"/> <input checked="" type="checkbox"/> <input checked="" type="checkbox"/> <input checked="" type="checkbox"/> <input checked="" type="checkbox"/> <input checked="" type="checkbox"/> <input checked="" type="checkbox"/> <input checked="" type="checkbox"/> <input checked="" type="checkbox"/> <input checked="" type="checkbox"/> <input checked="" type="checkbox"/>	<input type="checkbox"/> <input type="checkbox"/> <input type="checkbox"/> <input type="checkbox"/> <input type="checkbox"/> <input type="checkbox"/> <input type="checkbox"/> <input type="checkbox"/> <input type="checkbox"/> <input type="checkbox"/> <input type="checkbox"/> <input type="checkbox"/> <input type="checkbox"/>	Soft pedal Vibrato rate Vibrato depth Vibrato delay Vibrato parameter4*2 DSP Parameters*2 DSP Parameters*2 DSP Parameters*2 DSP Parameter7*2 Portamento Control High resolution velocity prefix *3 Reverse send Chorus send Delay send RPN(LSB, MSB)*2
Program Change : True #	<input type="checkbox"/> * * * * * <input type="checkbox"/> * * * * * <input type="checkbox"/> * * * * * <input type="checkbox"/> * * * * *	<input type="checkbox"/> <input type="checkbox"/> 0 - 127 <input type="checkbox"/>	
System Exclusive	<input type="checkbox"/> * * * * * <input type="checkbox"/> * * * * * <input type="checkbox"/> * * * * *	<input type="checkbox"/> <input type="checkbox"/> 0 - 127 <input type="checkbox"/>	*2
System Common : Song Pos : Song Sel : Tune	<input checked="" type="checkbox"/> * * * * * <input checked="" type="checkbox"/> * * * * * <input checked="" type="checkbox"/> * * * * *	<input checked="" type="checkbox"/> <input checked="" type="checkbox"/> X <input checked="" type="checkbox"/> X <input checked="" type="checkbox"/> X	
System Real Time : Clock : Commands	<input type="checkbox"/> * * * * * <input type="checkbox"/> * * * * *	<input checked="" type="checkbox"/> <input checked="" type="checkbox"/> X	
Aux Messages : All sound off : Reset all controller : Local ON/OFF : All notes OFF : Active Sense : Reset	<input type="checkbox"/> * * * * * <input type="checkbox"/> * * * * * <input type="checkbox"/> * * * * * <input checked="" type="checkbox"/> * * * * * <input checked="" type="checkbox"/> * * * * *	<input type="checkbox"/> <input type="checkbox"/> O <input type="checkbox"/> O <input type="checkbox"/> X <input type="checkbox"/> O <input type="checkbox"/> O <input type="checkbox"/> O <input checked="" type="checkbox"/> X	
Remarks	*1 : Depends on tone *2 : For details, see MIDI Implementation at http://world.casio.com/ . *3 : Note on only *1 : Depende del tono *2 : Si desea más información, vea implementación MIDI en http://world.casio.com/ . *3 : Nota activada solamente		

Mode 1 : OMNI ON, POLY
Mode 2 : OMNI ON, MONO
Mode 3 : OMNI OFF, POLY
Mode 4 : OMNI OFF, MONO

O : Yes
X : No

CASIO®

CASIO COMPUTER CO., LTD.
6-2, Hon-machi 1-chome
Shibuya-ku, Tokyo 151-8543, Japan

MA1503-A Printed in China



CGP700-ES-1A

© 2015 CASIO COMPUTER CO., LTD.

Free Manuals Download Website

<http://myh66.com>

<http://usermanuals.us>

<http://www.somanuals.com>

<http://www.4manuals.cc>

<http://www.manual-lib.com>

<http://www.404manual.com>

<http://www.luxmanual.com>

<http://aubethermostatmanual.com>

Golf course search by state

<http://golfingnear.com>

Email search by domain

<http://emailbydomain.com>

Auto manuals search

<http://auto.somanuals.com>

TV manuals search

<http://tv.somanuals.com>