



CASSIOPEIA

E-125

Getting Started with the CASSIOPEIA

(Hardware Manual)



User documentation consists of two manuals:
Pocket PC User's Guide and this booklet. Be sure
to read this manual first.

Be sure to read the Safety Precautions contained in
this manual to ensure proper operation of this
product.

Keep this manual in a safe place for future
reference.

E

CASIO[®]

To reset the Pocket PC

If your Pocket PC responds slowly, stops responding as expected, or “freezes,” try resetting it. A reset causes the Pocket PC to restart and re-adjust memory allocation. Unsaved data in open windows may be lost.

- Use the stylus to press and hold the Reset button for about two seconds.

- Microsoft, ActiveSync, Outlook, Pocket Outlook, Windows, Windows NT and the Windows logo are either registered trademarks or trademarks of Microsoft Corporation in the United States and/or other countries.
- Pentium is a registered trademark of Intel Corporation.
- CompactFlash is a registered trademark of SanDisk Corporation.
- All other product and company names mentioned herein may be the trademarks of their respective owners.

- Data can be uploaded from this unit to a personal computer for storage on a hard disk, floppy diskette, or other storage medium. Be sure to make multiple copies of all important data to protect against its accidental loss.
- CASIO COMPUTER CO., LTD. assumes no responsibility for any damage or loss resulting from the use of this manual.
- CASIO COMPUTER CO., LTD. assumes no responsibility for any loss or claims by third parties which may arise through the use of this product.
- CASIO COMPUTER CO., LTD. assumes no responsibility for any damage or loss caused by deletion of data as a result of malfunction, repairs, or battery replacement. Be sure to back up all important data on other media to protect against its loss.
- The contents of this manual are subject to change without notice.
- No part of this manual may be reproduced in any form without the express written consent of the manufacturer.

この装置は、情報処理装置等電波障害自主規制協議会(VCCI)の基準に基づくクラスB情報技術装置です。この装置は、家庭環境で使用することを目的としていますが、この装置がラジオやテレビジョン受信機に近接して使用されると、受信障害を引き起こすことがあります。

取扱説明書に従って正しい取り扱いをしてください。

Safety Precautions

Congratulations upon your selection of the CASSIOPEIA. Be sure to read the following Safety Precautions before trying to use it for the first time.

Note

All mentions of “the unit” in the following precautions refer to the CASSIOPEIA.

Markings and Symbols

The following are the meanings of the markings and symbols used in these Safety Precautions.



Danger

This symbol indicates information that, if ignored or applied incorrectly, creates the danger of death or serious personal injury.



Warning

This symbol indicates information that, if ignored or applied incorrectly, creates the possibility of death or serious personal injury.



Caution

This symbol indicates information that, if ignored or applied incorrectly, creates the possibility of personal injury or property damage.



- A diagonal line indicates something you should not do. The symbol shown here indicates you should not try to take the unit apart.



- A black circle indicates something you should do. The symbol shown here indicates you should unplug the unit from the wall outlet.

Health Precautions



Warning



- Long continuous use of the unit when you are tired is not good for your health, and should be avoided.



Caution



- Be sure to allow for adequate rest when using the unit for long periods. As a general rule, you should allow for 10 to 15 minutes of rest per hour.

Precautions During Use

Warning

Abnormal Conditions



- Continued use of the unit while it is emitting smoke or strange odor creates the danger of fire and electrical shock. Immediately turn off power, unplug the AC adapter from the wall outlet, remove batteries, and contact your original dealer or an authorized CASIO service provider to request servicing.

Water and Foreign Matter



- Should any foreign matter (metal, water or other liquid) ever get into the unit, immediately turn off power, unplug the AC adapter from the wall outlet, remove batteries, and contact your original dealer or an authorized CASIO service provider to request servicing.

Dropping and Damage



- Should the unit ever fall or otherwise become damaged, unplug the AC adapter from the power outlet, remove batteries, and contact your original dealer or an authorized CASIO service provider. Continued use creates the danger of fire and electrical shock.

Disassembly



- Never try to take the unit apart or modify it in any way. Doing so creates the danger of fire and electrical shock.

Magnetic Force



- If you are fitted with a pacemaker, keep the unit away from your chest area. In particular, do not carry the unit in your breast pocket. Magnetic force generated by the speaker built into the unit could possibly affect operation of a pacemaker. Should you ever suspect a problem, immediately move away from the unit and contact your physician.

Caution

Memory Protection



- Be sure to keep separate copies of all important data by saving it on a computer hard disk or other medium. Note that all data stored in unit memory is deleted whenever batteries go dead. Memory contents can also become lost or corrupted due to malfunction and repair of the unit.

Location



- Do not locate the unit in an area subjected to large amounts of humidity or dust. Doing so can create the danger of fire and electrical shock.



- Keep the unit away from food preparation area, stoves, and anywhere else it might be exposed to oil smoke or steam. Such conditions can create the danger of fire and electrical shock.

Caution

Avoid unstable surfaces.



- Never place the unit on an unstable surface, on a high shelf, or in any other unstable location. Doing so can create the danger of the unit falling and causing personal injury.

Magnetic Force



- Keep the unit away from ATM cards, credit cards, and any other magnetic card during transport and storage. Magnetic force generated by its speaker can render magnetic cards unusable.
- Keep the unit away from televisions and other radio wave receivers. Magnetic force generated by its speaker can cause interference with radio wave reception.

Rechargeable Battery Pack

Danger





- Never try to take apart the battery pack or modify it in any way. The battery pack has built-in safety and protection mechanisms that ensure safe operation. Damaging these mechanisms creates the danger of fire, smoke emission, and explosion.





- Never allow the positive (+) and negative (–) terminals of the battery pack to become connected by metal. Never transport or store the battery pack together with a necklace, hairpins or other metal objects. Doing so can short the battery pack, which creates the danger of fire, overheating, and explosion.
- Never use or leave the battery pack next to open flame, near a stove, or any other area exposed to temperatures of 80°C/170°F or greater. Doing so creates the danger of fire and explosion.
- Never charge the battery pack near a stove, under direct sunlight, in an automobile parked in the sun, or any other area subject to high temperatures. High temperature can cause the battery pack's safety mechanism to operate making it impossible to achieve a full charge. Heat can also cause an abnormal chemical reaction, which creates the danger of fire and explosion.
- Never pierce the battery pack with nails, hit it with a hammer, step on it, or throw it. Doing so can cause internal shorting, which creates the danger of fire and explosion.
- Never use a battery pack whose exterior is extremely damaged or deformed. Use of such a battery pack creates the danger of fire, overheating, and explosion.
- Never use the battery pack with any device other than this product. Doing so can cause abnormal current that damages the battery pack and creates the danger of fire.
- Keep a battery pack that is emitting a strange odor or leaking fluid away from open flame. Fluid leaking from the battery pack is highly flammable. It creates the danger of fire and explosion.

Warning

-  • Never expose the battery pack to direct flame, do not throw it into fire, fresh water, or seawater. Doing so can damage the built in safety and protection mechanisms, and cause battery fluid to ignite, creating the danger of fire and explosion.
-  • Should fluid from the battery pack ever accidentally get into your eyes, do not rub them. Rinse your eyes with tap water and then consult your physician immediately.
-  • If the battery pack does not achieve full charge after the normal charge time, stop charging. Continued charging creates the danger of fire, overheating, and explosion.

Batteries

Warning

-  • Never try to charge backup battery, take it apart, or allow it to become shorted. Do not apply solder to battery or expose it to heat, and never throw battery into fire or water.
-  • While the lithium battery is removed from the unit, take care to keep it in a place where there is no danger of it being accidentally swallowed. Be especially careful around young children.
- Keep batteries out of the reach of young children. If a battery is accidentally swallowed, consult a physician immediately.
- Should fluid from the battery accidentally get into your eyes, do not rub them. Rinse your eyes with water and then consult your physician immediately.



Caution

Misuse of batteries can cause them to leak, which damages and corrodes the area around the battery and creates the danger of fire and personal injury. Be sure to observe the following precautions.



-  • When loading batteries, make sure their positive (+) and negative (-) poles are facing correctly.
- Remove battery from the unit if you do not plan to use it for a long time.
- Use only battery types that are specified for this unit.

AC Adapter

Warning

-  • Never use a voltage that is different from that for which the AC adapter is rated. Also, do not plug the unit into a power outlet that is shared by other devices. Doing so creates the danger of fire and electrical shock.
- Never modify the power cord or excessively bend, twist, or pull it. Doing so creates the danger of fire and electrical shock.
- Do not allow the power cord to become damaged. Do not place heavy objects on the power cord or expose it to heat. A damaged power cord creates the danger of fire and electrical shock.
-  • Never touch the AC adapter while your hands are wet. Doing so creates the danger of electrical shock.
-  • Should the power cord ever become seriously damaged (internal wiring exposed or shorted), contact your original dealer or an authorized CASIO service provider to request servicing. Continued use of a seriously damaged power cord creates the danger of fire and electrical shock.
- Use only the AC adapter specified for this unit. Use of another type of AC adapter can damage the battery pack and create the danger of fire and personal injury.

Caution

-  • Unplug the AC adapter from the wall outlet whenever leaving the unit unattended for long periods.
- At least once a year, unplug the AC adapter from the power outlet and clean the area around the prongs of the plug. Dust build up around the prongs can create the danger of fire.
- Be sure to unplug the AC adapter from the wall outlet before attempting to move the unit to another location.
-  • Be sure to grasp the AC adapter when unplugging it from a wall outlet. Pulling on the power cord can damage it, and create the danger of fire and electrical shock.
- Keep the power cord away from stoves and other sources of heat. Heat can melt the insulation of the power cord and create the danger of fire and electrical shock.

Operating Precautions

The CASSIOPEIA is a precision digital instrument. Incorrect operation and rough handling can cause data storage problems and other malfunction. Be sure to read the following precautions to ensure proper operation.

- Charge the battery pack as soon as possible when they start to become weak. Continued use while power is low can lead to loss of memory data.

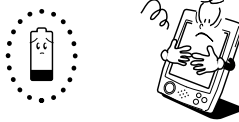

- Do not leave dead batteries in the CASSIOPEIA for long periods. Doing so can result in battery leakage, which can damage the CASSIOPEIA and cause malfunction.

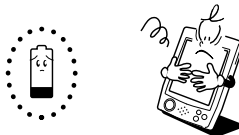

- Use the CASSIOPEIA under the conditions listed below.
 - Temperature: 0°C to 40°C (32°F to 104°F)
 - No condensationConditions other than those above can cause malfunction.
- Avoid using the CASSIOPEIA in areas subjected to the following conditions.
 - Static electricity
 - Extreme heat or cold
 - High humidity
 - Sudden temperature changes
 - Large amounts of dust
- If you drop the CASSIOPEIA and damage it, immediately turn off power and contact your original dealer or an authorized CASIO service provider. Never continue using a damaged unit.
- Never place heavy objects on top of the CASSIOPEIA.



-
- Never try to take the CASSIOPEIA apart. Doing so can cause malfunction.

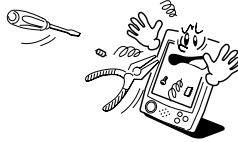

- Never insert foreign objects into connectors, slots, or other openings.



- Take care to avoid spilling water or drinks on the CASSIOPEIA.



- Use only the stylus that comes with the CASSIOPEIA to press the RESET button.
- Never use a pen, pencil, or other sharp writing implement. Doing so can scratch the touch screen and cause malfunction.
- Never use thinner, benzene, cosmetics, or other volatile agents to clean the exterior of the CASSIOPEIA. Use only a dry soft cloth or a soft cloth moistened with a weak solution of water and mild neutral detergent.
- Be sure to use the soft case to protect the display panel of your CASSIOPEIA while carrying it.

Important

- The TFT color LCD is a product of the latest color LCD manufacturing technology. However, virtually all TFT color LCDs have a very small number of pixels (about 0.01% of the total number of pixels) that do not turn on or always remain turned on. This is normal and does not indicate malfunction.
- Playing back movies, digital camera images, and audio files consumes large amounts of power and may cause the CASSIOPEIA to become warm to the touch. This is normal and does not indicate malfunction.
- Inserting or removing a CompactFlash card while the CASSIOPEIA is off causes power to turn on automatically. This is done so the CASSIOPEIA can detect the card slot status.

Contents

Safety Precautions	3
Markings and Symbols	3
Health Precautions	3
Precautions During Use	4
Rechargeable Battery Pack	5
Batteries	6
AC Adapter	7
Operating Precautions	8
Terms and Symbols used in this manual	11
Getting Ready	12
Initial Setup	12
Where to go for information.....	13
Operations	14
General Guide	14
Using the Stylus	16
Recalibrating the Touch Screen	16
Adjusting Display Contrast	17
Adjusting Display Brightness	17
Adjusting Auto Dimming Settings	17
Changing Applications Assigned to the Program Button	17
Using the Cradle	18
To remove the CASSIOPEIA from the cradle	19
Connecting the Cradle to a Computer	20
Using the CASSIOPEIA USB Cable	20
To connect to a computer using the CASSIOPEIA USB cable	21
Required System Configuration	21
Using the AC Adapter	23
Infrared Communications	24
Using a CompactFlash Card	24
Removing the Card Slot Cover	25
Replacing the Card Slot Cover	25
Digital Phone Connection Cable	26
About Modem Adapter (JK-720MA) and CompactFlash type modem card (JK-711MC56) (U.S. and Canada Only)	27
About the Digital Camera Card	27
Software Applications	28

User Maintenance	29
Batteries	29
Replacing the Main Battery	30
Replacing the Backup Battery	31
Charging the Battery Pack	33
Resetting the Unit	34
Performing a Reset	34
Memory Error Message	35
Full Reset (Memory Initialize)	36
Performing a Full Reset	36
Errors Following a Full Reset	37
Troubleshooting	38
Appendix	42
Button Operations	42
Specifications	43
Regulatory Information	44

Terms and Symbols used in this manual

- The term “unit” in this manual refers to the CASSIOPEIA.
- The symbol “**Important** ” indicates important information about a procedure that can result in problems if not performed correctly. Be sure to read such information carefully.

Getting Ready

Initial Setup

After you first unpack your CASSIOPEIA, perform the following initial setup procedure before using it for the first time.

1. Load the main battery (rechargeable battery pack) (page 29).

Important ⚠

Be sure to use the AC Adapter to charge the battery pack before doing anything else. Your CASSIOPEIA will not operate correctly if you load the backup battery before charging the battery pack.

2. Use the AC Adapter to charge the battery pack.
3. Load the backup battery.
4. Press the [Power] button.
 - After a few moments the welcome screen appears.
5. Follow the steps in the Welcome Wizard.
6. When finished, you'll see the Today screen.
 - See "Pocket PC Basics" at the back of *Quick Start Guide* for information about the Today screen and other Pocket PC Basics.
 - You also need to install ActiveSync before you can communicate with a desktop computer.

Important ⚠

- If the touch panel does not respond when you tap it or if nothing appears on the display, try performing a full reset (page 36). If this does not restore proper operation, remove the main battery and the backup battery and wait for about five minutes. Reload the main battery first and then the backup battery, and perform the above procedure again from step 4.
- If the message "**A problem with memory contents has been found...**" appears on the display, perform a full reset (page 36).

Where to go for information...

Your CASSIOPEIA comes with two manuals: this *Hardware Manual* and a separate *Pocket PC User's Guide*. Be sure to read the contents of this *Hardware Manual* first.

What should I do after reading this *Hardware Manual*?

Read the *Pocket PC User's Guide* next to find out about the powerful software features and functions available on the CASSIOPEIA.

What should I do if I run into problems?

Check the troubleshooting guides on page 38 of this *Hardware Manual* and in the *Pocket PC User's Guide*.

Where can I find out about the bundled software?

Your CASSIOPEIA comes with a collection of standard Pocket PC programs from Microsoft, plus a collection of original programs from CASIO.

■ Microsoft Programs

See the *Pocket PC User's Guide* for details on Pocket Outlook (Calendar, Contacts, Tasks, Inbox), Pocket Excel, Pocket Word, Pocket Internet Explorer, and Notes from Microsoft. You can find other Microsoft programs in the Extras folder on the ActiveSync CD.

■ CASIO Programs

See the user documentation (PDF file) on the *CASSIOPEIA Applications CD-ROM* for information about Menu, Mobile Calendar, Mobile Address Book, Mobile Picture & Video Player with Camera, CardBackup Tool, and other CASIO programs.

How can I connect my CASSIOPEIA to a desktop computer?

See page 20 of this *Hardware Manual* for details about how to connect and the type of computer you can connect to. For information on installing ActiveSync, see the booklet accompanying the ActiveSync CD-ROM. For information on using ActiveSync, see *ActiveSync Help* on the desktop computer.

How can I install the software on the CASSIOPEIA Applications CD-ROM?

See the documentation contained on the CD-ROM.

Important

The optionally available modem adapter and modem card mentioned in this and the other manuals are intended for use in the U.S. and Canada only.

Operations

General Guide

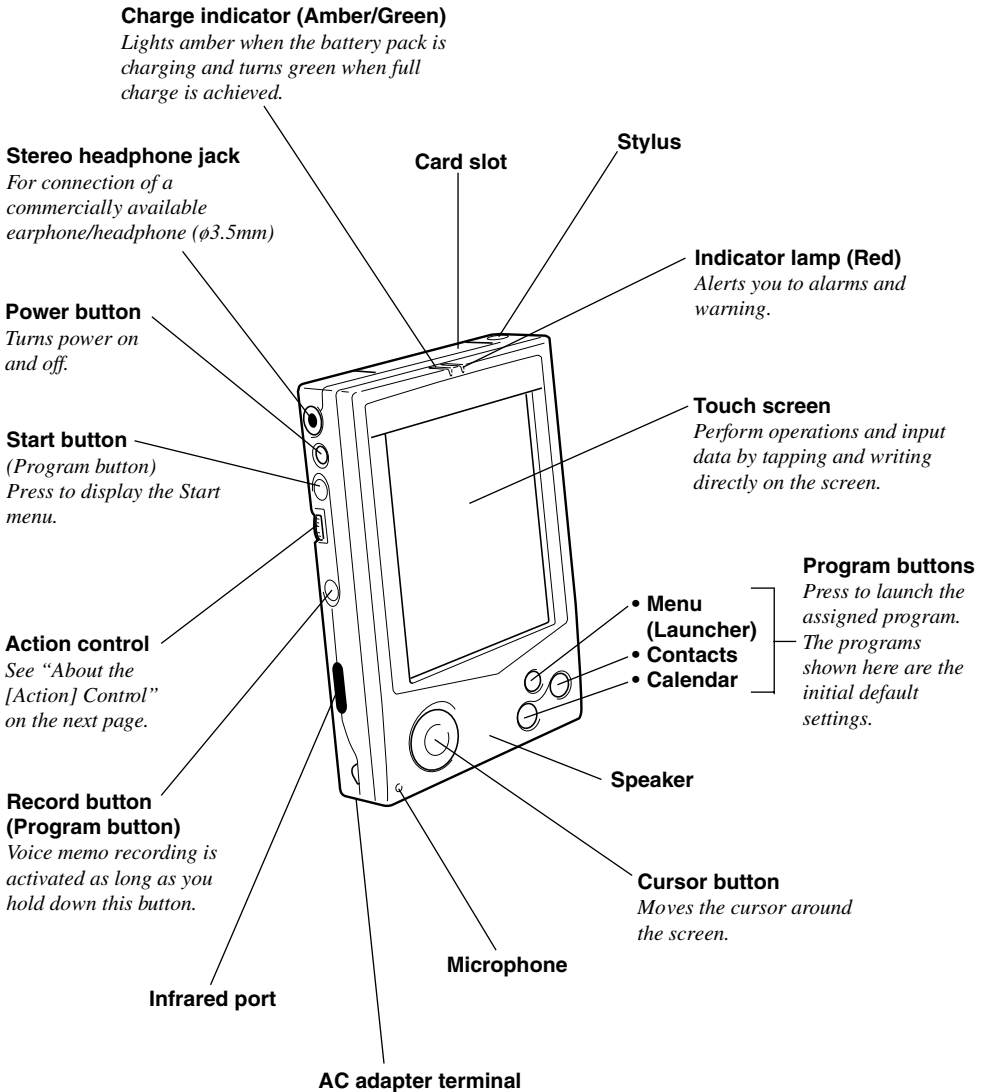

Card lock switch

If the inserted card has a lock, this switch locks the card in place so it does not come out accidentally.

RESET button

Battery cover switch

Backup battery cover

Main battery cover

Serial connector

For connection of the cradle, the CASSIOPEIA USB cable, or the RS-232C serial cable.

About the [Action] Control

Operations can be performed by pressing and rotating the [Action] control.

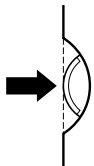

Pressing the [Action] control performs an operation similar to the Enter key of a computer keyboard.



Rotating the [Action] control performs operations similar to the up and down arrow keys of a computer keyboard.

See Pocket PC online help for information about using the [Action] control with each application. The text in the online help indicates an [Action] control press operation as “Action,” and an [Action] control rotate operation as “Up/Down control.”

Using the Stylus

Data input and virtually all other operations are performed using a stylus, which is housed inside the stylus holder in the higher right corner of the CASSIOPEIA.

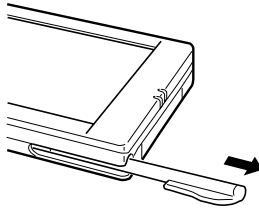

The following defines the various operations that you can perform with the stylus.

- Tap Touch the screen once with the stylus to open items and select options.
- Drag Hold the stylus on the screen and drag across the screen to select text and images. Drag in a list to select multiple items.
- Tap-and-hold Tap and hold the stylus on an item to see a list of actions available for that item. On the pop-up menu that appears, tap the action you want to perform.

Important

- Take care that you do not misplace or otherwise lose the stylus by always storing it in the stylus holder when you are not using it.
- Take care to avoid breaking the tip of the stylus.
- Use only the stylus that comes with the CASSIOPEIA, or some other stylus type instrument* to perform touch screen operations. Never use a pen, pencil, or other sharp writing implement.
*(with a soft, blunt point)

Recalibrating the Touch Screen

You should recalibrate the touch screen whenever touch screen response is bad, or when the operation performed is different from the operation you expected when tapping on the touch screen.

To recalibrate the touch screen, press the [Action] control while holding down the [Power] button (or tap  **Settings**, the **System** tab, and then the **Align Screen**). Next, follow the instructions that appear on the screen.

Adjusting Display Contrast

Perform the following operations to adjust display contrast and make figures on the display darker or lighter.

- Tap  and then **Settings**. On the **System** tab, tap **Brightness**. Follow the instructions on your screen for adjusting the contrast.
- You can also adjust contrast by holding down [Action] and pressing the top of the cursor button to make contrast darker, and the bottom of the cursor button to make it lighter.

Adjusting Display Brightness





Use the following operations to adjust display brightness to make it easier to read.

- Tap  and then **Settings**. On the **System** tab, tap **Brightness**. On the dialog box that appears, tap the **Brightness** tab.
- While holding down the [Action] button, press the right side of the cursor button to make the screen brighter, or the left side of the cursor button to make it dimmer.

Adjusting Auto Dimming Settings

1. Tap  and then **Settings**. On the **System** tab, tap **Brightness**.
 2. On the dialog box that appears, tap the **Auto Dim** tab.
 3. Follow the instructions that appear on the screen to make auto dimming settings.
- You can make separate auto dimming settings for battery power and AC adapter power by checking the appropriate check box.

Changing Applications Assigned to the Program Button

- Tap  and then **Settings**. On the **Personal** tab, tap **Button**, and then follow the instructions that appear on the display.
- Button Assignment Utility makes it easy to assign CASIO Mobile Calendar to the  button and CASIO Mobile Address Book to the  button. To use Button Assignment Utility, tap , **Programs, Utility**, and then **Button Assignment**.

Using the Cradle

The cradle provides quick and easy connection between your CASSIOPEIA and a personal computer. CASSIOPEIA can also be powered from an AC power source when it is placed on the cradle.

- The battery pack charges while the CASSIOPEIA is on the cradle. See page 33 for more information.

Important ⚠

Make sure that CASSIOPEIA power is turned off before you place it onto or remove it from the cradle.

Use the following procedure to place the unit onto the cradle.

1. Place the cradle on a desk or other flat, level surface.
2. Turn off the CASSIOPEIA.
3. Slide the CASSIOPEIA's serial connector cover to open it.

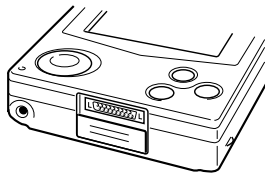

4. Orient the CASSIOPEIA in relation to the cradle as shown in the illustration below.

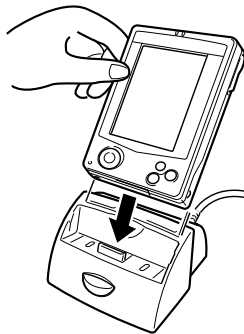

-
5. Taking care to align the serial connector on the bottom of the CASSIOPEIA with the connector on the cradle, lower the CASSIOPEIA into the cradle as shown in the illustration below.

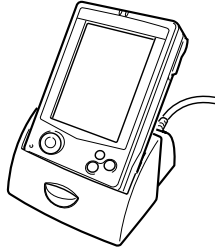

Important ⚠

Make sure the CASSIOPEIA lowers securely into the cradle as far as it can go.

To remove the CASSIOPEIA from the cradle

1. Press the cradle's eject button.
2. Slide the CASSIOPEIA straight up from the cradle.

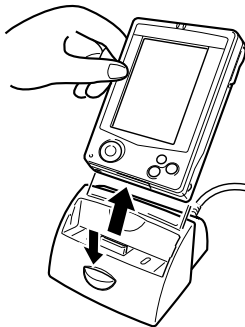

Connecting the Cradle to a Computer

The cradle has a USB cable for connection to a personal computer. Connect the end of the cable to a USB port of the computer to which you want to connect.

Important

- See “Required System Configuration” on page 21 for details on the type of computer system required for use with the cradle.

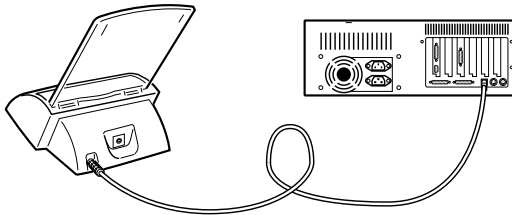

- The above illustration is one example of possible connection configurations. The locations and layouts of USB ports vary from computer to computer. See the documentation that comes with your computer for full details on connecting cables to it.
- Note that after connecting the cradle to your computer, you also need to make certain ActiveSync settings on your computer to enable data transfers. See the *ActiveSync Help* for details about setting up and using ActiveSync.

Using the CASSIOPEIA USB Cable

You can use the CASSIOPEIA USB cable to connect the CASSIOPEIA directly to a computer.

Important

- See “Required System Configuration” on page 21 for the computer system that is required for direct USB connection.
- The illustration below is just one possible connection configuration. The location and layout of USB ports vary from computer to computer. See the documentation that comes with your computer for full details on connecting cables to it.
- You must have ActiveSync installed on your computer in order to exchange data with the CASSIOPEIA over a USB connection. See the *Pocket PC User’s Guide* for information on installing and using ActiveSync.

To connect to a computer using the CASSIOPEIA USB cable

1. Plug the USB cable into the USB port of your computer.
2. Turn off your CASSIOPEIA.
3. Connect the other end of the USB cable to your CASSIOPEIA.

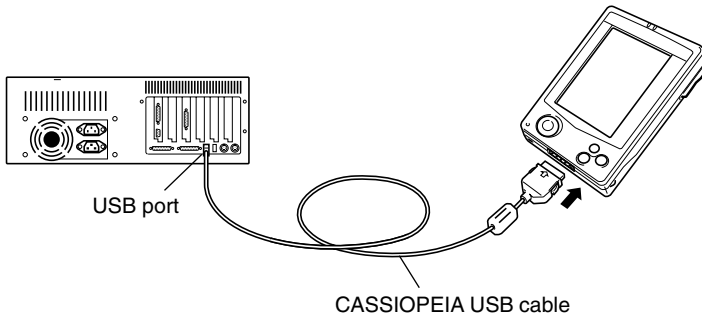

Required System Configuration

The minimum system configuration required for running ActiveSync® 3.1 is described below.

ActiveSync® 3.1 System Requirements

- Microsoft® Windows® 2000, Windows NT® Workstation 4.0 with **Service Pack 3 or greater**, or Windows 95/98. (U.S. version)
- Desktop computer with a Pentium processor for Windows NT (166MHz required for Windows 2000)
- Desktop computer with a 486/66 DX or higher processor (Pentium P90 recommended) for Windows 95/98
- 16MB of memory for Windows 95/98 (more memory will give improved performance) or Windows NT Workstation 4.0 (32MB recommended for Windows NT, 64MB recommended for Windows 2000)
- Hard disk drive with 10 to 50MB of available hard disk space (actual requirements will vary based on selection of features and user's current system configuration)
- Available 9 or 25-pin communications port (adapter required for 25-pin communication port), Infrared port, or USB port (available for Windows 95/98 or Windows 2000 only).
- One CD-ROM drive
- VGA graphics card or compatible video graphics adapter at 256 color or higher
- Keyboard
- Microsoft Mouse or compatible pointing device

PC Companion Device Requirements

- **Handheld PC:** Windows CE Handheld PC versions 2 and 3 with Windows CE Core System version 2.0 or greater
- **Palm-size PC:** All models and versions
- **Pocket PC:** All models and versions

Options for Windows 2000, Windows NT Workstation 4.0 or Windows 95/98

- Audio card/speakers for sound
- Microsoft Office 95 or Microsoft Office 97 or Microsoft Office 2000
- Modem for remote synchronization
- Ethernet LAN connection for remote synchronization

Requirements for Mobile Channels or Mobile Favorites Support

Microsoft Internet Explorer 4.0 or higher. Internet Explorer 5.0 is included on the CD, which requires 56-98MB of hard disk space.

Requirements for Microsoft Outlook® 2000

Microsoft Outlook 2000 requires 153 MB of disk space for a full installation. 24 MB system RAM recommended.

Note

- Different minimum system requirements are required when using the applications included on the *CASSIOPEIA Applications CD-ROM*. See the documentation contained on the CD-ROM for full details.
- The cradle that comes with your CASSIOPEIA is designed for USB connection only. If your computer does not have a USB port, you will need to purchase the separate serial connection cradle (JK-512CR) or the serial connection cable (JK-580CA), which allows direct connection between the CASSIOPEIA and your computer's serial port.

Important

- When installing ActiveSync on a computer, check to make sure that the specified COM port number correctly indicates the serial port to which the cradle is connected.
- Some laptop and sub-compact computers with built-in infrared ports and modems are initially configured so the COM port is not always used as a serial port. In such a case, you must change the setting so the COM port is always used as a serial port. See the documentation that comes with your computer for full details on COM port numbers and settings.

Using the AC Adapter

You can use the AC adapter to directly power the CASSIOPEIA or to supply power through the cradle. The battery pack charges while the CASSIOPEIA is directly connected to a power source by the AC adapter or while it is on the cradle. See page 33 for more information.

■ Direct Connection

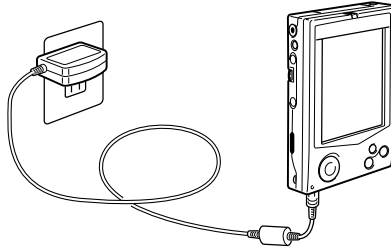

■ Cradle Connection

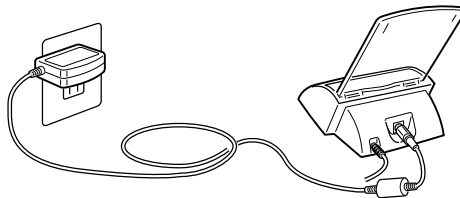

Warning ⚠

Use only the AC adapter that is specified for this unit. Use of another type of AC adapter creates the danger of malfunction and bursting of battery.

Important ⚠

- Power also will not turn on if the main battery loaded in the CASSIOPEIA is dead.
- Long term use of the AC adapter can cause it to become warm to the touch. This is normal and does not indicate malfunction.
- Be sure to unplug the AC adapter from the power outlet whenever you are not using it.
- The AC adapter is designed for indoor use only. It should not be used outdoors.

Infrared Communications

The infrared port of this unit can be used to exchange data with another CASSIOPEIA, or with another device equipped with infrared communication capabilities. Remember that the two infrared ports must be pointed directly at each other when performing communications. The distance between the two infrared ports must be less than 20 cm. See the *Pocket PC User's Guide* for full details on performing infrared communications. For infrared data communications with another device, the other device must conform with IrDA 1.2 standards, and it must specifically support infrared data communication with a CASSIOPEIA.

Important

- Take care so either of the units does not move while infrared data communications are in progress.
- Infrared data communications may be impossible under strong sunlight or inverter type fluorescent lighting.
- Infrared data communication problems can be caused by the distance between the two ports, the angle between the two ports, outdoor sunlight, and low batteries.
- Dirt and dust on the infrared port surface can cause communications errors and other problems. Use a soft, dry cloth to wipe the port clean of dirt and dust.

Using a CompactFlash Card

Your CASSIOPEIA supports Type I and Type II CompactFlash cards (3.3V).

Important

- The card slot cover will not close when certain types of cards are in the slot. Remove the card slot cover and keep it in a safe place so you can replace it when you remove the card.
- Gently but firmly slide the card into place as far as it will go, but do not force it. Forcing a card can damage connectors. If you have problems inserting a card, pull it out and check to make sure it is oriented correctly.
- We strongly recommend that you store all unsaved data you are inputting or editing before performing this procedure.
- Sometimes, your CASSIOPEIA may not be able to detect a CompactFlash card. This is indicated when a program on the card does not start up normally. When this happens, remove the card, reinsert it, and then press the CASSIOPEIA RESET button.
- Your CASSIOPEIA supports 3.3V CompactFlash cards only. Cards that can operate on 5.0V only are not supported.
- Use of an IO card that requires large amounts of power can cause the CASSIOPEIA to restart when CASSIOPEIA battery power is low.

1. Make sure your CASSIOPEIA is turned off.

- Press the [Power] button to turn off power.

2. Pressing upward at the point indicated in the illustration, slide the cover up to open it.

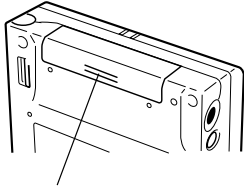

Press upward here.

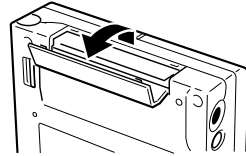

Important ⚠

Pull the cover out as far as it will go and then swing it open.

3. If there is already a card in the slot, remove it.

4. Slide the card you want to use into the card slot.

- Make sure the top of the card is facing towards the top of the CASSIOPEIA unit. A card that is not oriented correctly will not slide all the way into the slot.

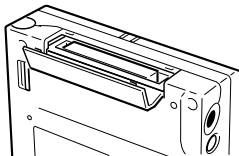
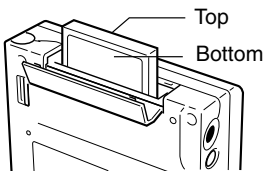

Carefully slide the card into the slot as far as it will go.

5. Close the card slot cover.

Removing the Card Slot Cover

Remove the card slot cover when using a card that protrudes from the slot when fully inserted. To remove the cover, pull it up part way open, and then slide it from the unit as shown in the illustration below.

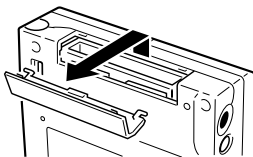

Important ⚠

Handle the cover carefully and do not force it! Using too much force can cause the cover hooks to break off!

Replacing the Card Slot Cover

Reverse the above removal operation to replace the card slot cover.

Digital Phone Connection Cable

- U.S. and Canada: Use a cdma digital phone connection cable (JK-541CA).
- For a GSM type digital phone, use a commercially available cable that is compatible with the CASSIOPEIA connector.
- After you connect the CASSIOPEIA to your digital telephone, you can dial up our Internet service provider or company server.

The following shows how to connect the CASSIOPEIA to a digital telephone.

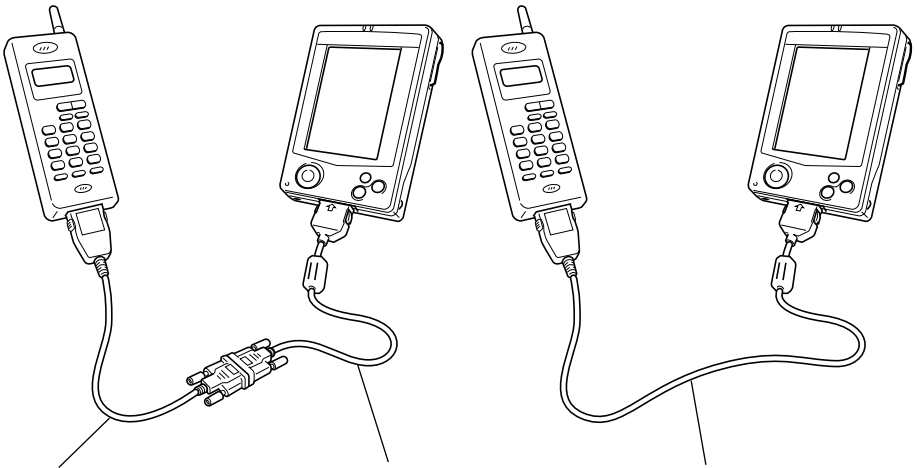

- Separately available cable (D-sub 9-pin) for your particular telephone model, available from your phone manufacturer
- Optionally available digital telephone cable (9-pin), available from your CASIO dealer
- Commercially available GSM connecting cable

To disconnect the digital telephone cable from the CASSIOPEIA, squeeze the release buttons on the sides of the connector and unplug it.

Important

- Make sure your CASSIOPEIA is turned off before connecting the digital telephone cable.
- See the *Pocket PC User's Guide* for information about settings, operations, and precautions when connecting to a company network or the Internet.
- Make sure you are in an area where your telephone signal is strong before trying to dial in to a computer.

Data communication may not be possible if you are within an area with poor signal reception, even though it is within the service area of your telephone service provider. Also note that noise can cause errors and make communication impossible, even though the signal is strong. If this happens, try again.

- Never unplug the cables or turn off power while data communication is in progress.
- You may not be able to establish a connection with another computer that is also using a portable telephone for communication.
- Whenever you disconnect the digital telephone cable from the CASSIOPEIA, wait at least three seconds before you connect it again. Disconnecting the cable and immediately reconnecting it again can make subsequent data communications impossible.
- Disconnect the digital telephone cable from the CASSIOPEIA when you are finished with data communication.
- See the documentation that comes with your digital telephone for information about its operations.

About the Modem Adapter and Modem Card (U.S. and Canada Only)

The Modem Adapter (JK-720MA) and CompactFlash type Modem Card (JK-711MC56) make it possible to use your CASSIOPEIA to access the Internet over an analog dial-up connection. See the documentation that comes with the modem card for information about how to use it.

Important

Check to make sure that the battery pack is charged before using the modem adapter and modem card. Low battery power can cause sudden interruption of communications, unstable communications, and loss of data.

About the Digital Camera Card

Installing the optionally available CompactFlash type digital camera card (JK-710DC) makes it possible for your CASSIOPEIA to record and playback both movies and snapshots. For full details on how to use the digital camera card, see the documentation that comes with it.

Important

- Do not install the Mobile Camera application from the CD-ROM that comes with the digital camera card (JK-710DC)! Your CASSIOPEIA will not operate properly with this version of Mobile Camera.
- When using the optionally available digital camera card (JK-710DC), be sure to install the Mobile Picture & Video Player with Camera application from the CD-ROM that comes bundled with your CASSIOPEIA.

Software Applications

Software applications are available for purchase from Microsoft and third parties who support Windows CE. For details on commercially available software applications, contact your local retailer or visit the Microsoft Web site at <http://www.microsoft.com>.

Your Pocket PC also comes with a *CASSIOPEIA Applications CD-ROM* that contains a number of useful applications. Note that you must install the applications you need from the CD-ROM before you can use them. See the documentation contained on the CD-ROM for details on using the software applications.

Important

- Whenever purchasing software applications, always double-check to make sure that it is compatible with the CASSIOPEIA.
- Some applications written for a Palm-size PC (Windows CE 2.11) may not run on a Pocket PC. Contact the producer of the application for information about an upgrade to the Pocket PC version.

User Maintenance

Batteries

Your CASSIOPEIA is powered by a dual power supply that consists of a main battery (rechargeable battery pack) and a backup battery (CR2032 lithium battery).

- We recommend that you use the Power Properties to keep informed about the current levels of your main and backup batteries. See the separate *Pocket PC User's Guide* and Pocket PC online help for more information about this properties.

Important

The following messages appear whenever battery power drops below a certain level.

Main Battery

Recharge the battery pack as soon as possible after the following message appears.

“Main Batteries Very Low

To prevent possible data loss, replace or recharge your main batteries according to the owner’s manual.”

Backup Battery

Replace the backup battery as soon as possible after the following message appears.

“Backup Battery Very Low

To prevent possible data loss, replace or recharge your backup battery according to the owner’s manual.”

- You can monitor the current battery power level accessing Power Properties or by checking the battery icon in the command bar of the Today screen.
- Whenever the low battery warning message appears, especially if it appears right after you turn on power, follow the instructions that appear on the screen and replace batteries as soon as possible. Continued use under low battery power can cause unstable performance of your Pocket PC.
- Data stored in memory can be lost if you continue operation after the low battery message appears or if you incorrectly load batteries. Be sure to always back up important data on your desktop computer hard disk or on a CompactFlash card. See *ActiveSync Help* for information about backing up files to a desktop computer.
- See the *Card Backup Tool* manual (PDF file) on the *CASSIOPEIA Application CD-ROM* for information about backing up data to a CompactFlash card for information about using the Card Backup Tool program to back up data to a CompactFlash card.
- Never remove the main battery and backup battery from the CASSIOPEIA at the same time. Doing so causes all data stored in memory to be deleted.
- Should the main battery and the backup battery both require replacement, be sure to always replace the main battery first.
- Use the rechargeable battery pack for the main battery and a CR2032 lithium battery for the backup battery. Never use any other type of batteries.

If unit power turns off due to insufficient power, the following warning message appears on the display the next time you turn on unit power.

“Warning

Due to high current demand by the hardware, the system powered down in order to protect memory contents...”

If unit power turns off due to sudden power drain by a CompactFlash card, the following warning message appears on the display the next time you turn on unit power.

“Warning

Due to high current demand by the card, the system powered down in order to protect memory contents...”

Important 

Be sure to observe the following important battery handling precautions. Failure to do so can cause batteries to leak, resulting in damage to surrounding items and create the danger of fire and electrical shock.

- Always make sure that the positive (+) and negative (–) poles of the batteries are oriented correctly.
- Use only the types of batteries specified for use with this unit.
- Charge the battery pack in an area where the temperature is between **10°C (50°F)** and **35°C (95°F)**. Charging in areas that are very cold or exposed to direct sunlight can cause deterioration and leaking of the battery pack.
- To avoid deterioration and leaking, the battery pack is designed to discharge even when you do not use the CASSIOPEIA. Be sure to recharge the battery pack at least once every three months, regardless of how much you use the CASSIOPEIA during that time.
- A battery pack that loses power too quickly after it is charged is probably near the end of its service life. In such a case, you have to purchase a new battery pack.

Replacing the Main Battery

1. Make sure your CASSIOPEIA is turned off.
 - Press the [Power] button to turn off power.
2. Turn the CASSIOPEIA over.

3. Slide the battery cover switch to MAIN, and then remove the main battery cover.

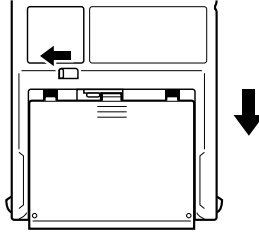

4. Pull on the tape to raise the main battery.

5. Remove the main battery and then load a new battery pack.

- Make sure that the battery pack is oriented correctly.
- When you load the battery pack, make sure the end of the tape is sticking out above the battery pack.

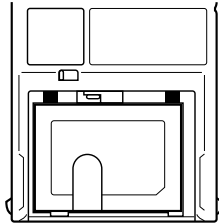

6. Replace the main battery cover.

7. Slide the battery cover switch to LOCK.

Replacing the Backup Battery

Important

- Never remove the main battery and backup battery from the CASSIOPEIA at the same time. Doing so causes all data stored in memory to be deleted.
- Should the main battery and the backup battery both require replacement, be sure to always replace the main battery first.
- Be sure to replace the backup battery as soon as possible whenever the following message appears on the display: **“Backup Battery Very Low To prevent possible data loss, replace or recharge your backup battery according to the owner’s manual.”**

-
1. Make sure your CASSIOPEIA is turned off.
 - Press the [Power] button to turn off power.
 2. Turn the CASSIOPEIA over.
 3. Slide the battery cover switch to **BACK UP**, and then remove the backup battery cover.

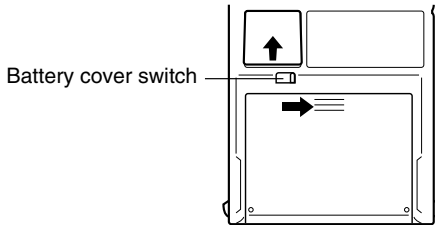

4. Remove the old battery.
5. Wipe off a new lithium battery (CR2032) with a dry cloth, and load it into the CASSIOPEIA.

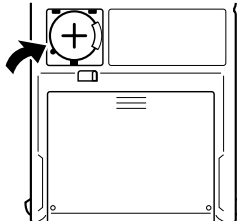

Make sure the positive side is facing up, so you can see it.

6. Replace the backup battery cover.
7. Slide the battery cover switch back to **LOCK**.

Charging the Battery Pack

1. Install the battery pack into the CASSIOPEIA.
2. Attach the AC adapter to the cradle and place the CASSIOPEIA onto the cradle.

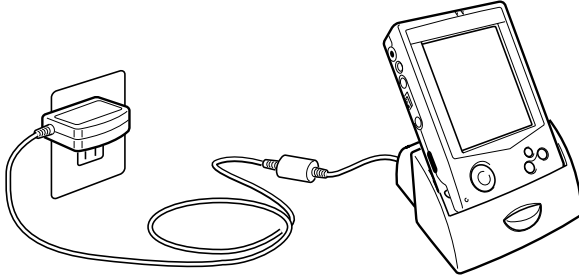

- Charging starts automatically as soon as you place the CASSIOPEIA onto the cradle.
- The charge indicator is amber while charging is in progress, and turns green when charging is complete.
- It takes about **five or six hours** to reach full charge.
- You can use your CASSIOPEIA while the battery pack is charging.

Important

- Do not use the CASSIOPEIA while it is charging for the first time after you purchased it or for the first time after you installed a newly purchased battery pack.
- If the battery pack does not achieve full charge after the normal charge time, unplug the AC adapter from the CASSIOPEIA to stop charging.

Remove the CASSIOPEIA from the cradle after charging is complete.

The following illustration shows how to connect the AC adapter directly to the CASSIOPEIA for charging.

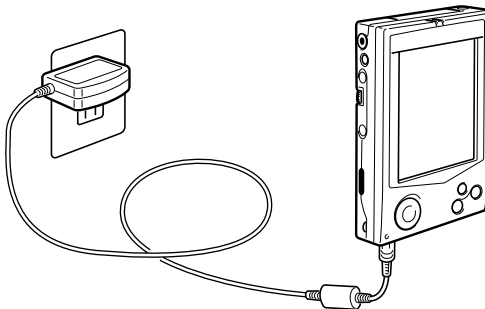

- Charging starts automatically as soon as you attach the AC adapter to the CASSIOPEIA.
- Direct connection charging conditions are the same as those described for cradle charging above.

Resetting the Unit

“Reset” is similar to a computer reboot. Performing a reset deletes any data that is in the process of being input or edited, without yet being saved. Data stored in memory and all settings, however, are retained.

Perform the reset operation whenever the unit fails to operate correctly due to operational error or some other abnormality. Any of the following symptoms indicate that reset is required.

- Failure of the unit to respond when the screen is tapped or a button is pressed
- The hourglass icon remaining on the screen

Performing a Reset

1. Use the stylus to press the RESET button.
 - The unit performs a reset followed by a memory check operation. If no data error is found, the following two screens appear on the display in succession.
 - Startup screen
 - Desktop
2. Normal unit operation is possible after the desktop appears.
 - Memory data and settings are retained when you reset the Pocket PC.

Important

If the above operation does not solve the problem, perform a full reset (memory initialize, page 36).

Memory Error Message

If the memory check operation that the unit performs when the RESET button is pressed detects a data error, the following message appears on the screen instead of the startup screen.

“A problem with memory contents has been found. Press [Action] to continue with the reset procedure, which restores normal system operation.

Note that if the system determines that user memory cannot be repaired, it will delete all user data currently in memory.

See the User’s Guide for details about initializing memory.”

This message indicates that the memory error is fatal and so recovery is impossible. Press the [Action] control to execute a full reset (memory initialize), which deletes all data stored in memory.

- Pressing the [Action] control should display the Startup screen followed by the touch screen calibration screen. Perform steps 5 through 6 under “Initial Setup” on page 12 to set up the unit.
- If pressing the [Action] control returns to the desktop without displaying the startup screen first, see the following explanation for the procedure you need to follow.

What to do if the startup screen does not appear when you press the

[Action] control

Even though the desktop appears when you press the [Action] control, there is still a data error in memory and you have to perform a full reset (memory initialize). Before you do, however, there is the chance that some of the data in memory can be recalled and even transferred to a computer. Try recalling the data you need before performing the procedure described on the next page to perform a full reset.

Important

Do not use the ActiveSync backup function to back up data to a computer when you suspect a data error. Doing so may also include the corrupted data that is causing your problem, which means the problem will reappear when you restore the data.

Full Reset (Memory Initialize)

Full reset (memory initialize) deletes all data, and resets all unit parameters to their initial defaults.

The following are conditions when you should perform a full reset.

- When you want to delete all memory data and return unit settings to their factory defaults
- When you forget your password and need to clear it
- When a data error causes operational problems
- Appearance of the message: **“A problem with memory contents has been found...”**

Performing a Full Reset

Important

- The following procedure deletes all data in memory. Be sure that data is backed up or that you no longer need it before performing the following procedure.
- If there is a CompactFlash card in the CASSIOPEIA's slot, remove the card before performing the full reset.

1. Make sure that unit power is turned on.

2. While holding down the [Power] button, use the stylus to hold down the RESET button for about two seconds.

- This causes the following message to appear on the display screen.

“Proceeding with this operation initializes memory. Press [Action] to proceed or [Record] to cancel.”

3. Press the [Action] control.

- This causes the following message to appear on the display screen.

“Proceeding with this operation deletes all data stored in memory. Press [Action] to proceed or [Record] to cancel.”

4. Press the [Action] control again.

- This starts the full reset operation, which deletes all data in memory.
- Pressing the [Action] control displays the Startup screen. Perform steps 5 through 6 under “Initial Setup” on page 12 to set up the unit.

You can abort the full reset operation while the messages in steps 2 and 3 are on the display by pressing the [Record] button.

Errors Following a Full Reset

Either of the following two conditions can cause errors to continue, even after you perform a full reset.

- Hardware defect
- System problem caused by failure by you to correctly perform the reset procedure before using the unit for the first time

If you suspect that the problem is being caused because you did not properly reset the unit before using it for the first time, perform the procedure on page 41 of this manual. This should correct the problem.

Troubleshooting

Before assuming malfunction and contacting your service provider when experiencing operational problems, be sure to check the following information as well as the troubleshooting section of the *Pocket PC User's Guide* first.

Nothing happens when the [Power] button is pressed.		
Possible Cause	Recommended Action	Page
Main battery is weak.	Charge the battery pack.	33
Internal malfunction	Reset the unit. If resetting the unit does not correct the problem, perform a full reset (memory initialize).*	34 36

Operation is disabled when the AC adapter is connected.		
Possible Cause	Recommended Action	Page
Main battery is weak.	Charge the battery pack.	33
The unit is not mounted on the cradle correctly.	Mount the unit on the cradle correctly.	18

Replacing the main battery caused malfunction.		
Possible Cause	Recommended Action	Page
Main battery is not loaded correctly.	Remove and then reload the main battery. <ul style="list-style-type: none">• Make sure the positive (+) and negative (-) poles are oriented correctly.	30
The battery replacement procedure was not followed correctly.	Perform a full reset (memory initialize).* <ul style="list-style-type: none">• If the above action does not solve the problem, remove the main battery and contact your original dealer or an authorized CASIO service provider.	36

Rechargeable battery pack life is very short after each charge.		
Possible Cause	Recommended Action	Page
Battery pack is damaged or has reached the end of its service life.	Purchase a new battery pack.	–

The low backup battery message continues to appear even after replacement of the backup battery.		
Possible Cause	Recommended Action	Page
The backup battery is upside down.	Remove the backup battery, turn it over, and reload it.	31
The backup battery was loaded before the main battery.	Remove the backup battery, and reload it.	31
Power was left on while the battery pack was replaced.	Turn power off and then back on again.	–

Nothing happens when the touch screen is touched.		
Possible Cause	Recommended Action	Page
The touch screen is out of calibration.	Recalibrating the touch screen.	16
Static electricity or some other problem has caused the touch screen to malfunction.	Reset the unit.	34
The touch screen is damaged.	Contact your original dealer or an authorized CASIO service provider.	–

The screen is locked up.		
Possible Cause	Recommended Action	Page
Internal malfunction	Reset the unit. If resetting the unit does not correct the problem, perform a full reset (memory initialize).*	34 36

A message about a data error is on the screen.		
Possible Cause	Recommended Action	Page
Internal malfunction	Follow the instructions that appear on the screen.	–

* Perform the procedure on page 41 when the full reset (memory initialize) does not correct the problem.

-
- Perform the following procedure if your CASSIOPEIA remains locked up even after you perform a full reset.

Important 

- The following operation deletes all data in CASSIOPEIA memory.
 - If you previously backed up your CASSIOPEIA data to your desktop computer hard disk or a CompactFlash card, you will be able to restore the data after performing the following operation.
 - If backed up data includes data that is the cause of the original problem, your CASSIOPEIA may start malfunctioning again after data is restored. In this case, you will not be able to use the backed up data.
 - To protect against backing up corrupted data that can cause problems when restored, first synchronize Pocket Outlook program data between your CASSIOPEIA and desktop computer. Next, use drag and drop to copy other files to you computer. See *ActiveSync Help* for information about synchronizing data and copying files.
1. Remove both the main battery and the backup battery from the CASSIOPEIA.
 2. Wait for about **five minutes**.
 3. Reload the main battery.
 - Be sure to load the main battery first. The CASSIOPEIA will not operate properly if you load the backup battery first. If you inadvertently load the backup battery first, start over from step 1 above.
 4. Attach the AC adapter and charge the battery pack.
 5. Reload the backup battery.
 6. Make sure the battery cover switch is in the LOCK position.
 7. Wait for about **five seconds** and then press the [Power] button to turn on your CASSIOPEIA.
 - Turning on power displays the startup screen, following by the touch panel calibration screen.
 8. Follow the instructions that appear on the screen to make initial settings.
 9. After setting up your CASSIOPEIA, turn it off.
 - After completing the above procedure, you can restore data you have backed up on your desktop computer hard disk or CompactFlash card. See *ActiveSync Help* for information about restoring backed up.
 - See the *Card Backup Tool* manual (PDF file) on the *CASSIOPEIA Application CD-ROM* for information about using the Card Backup Tool program to restore data from a CompactFlash card.
 - If your CASSIOPEIA does not operate correctly, contact your original dealer or your nearest authorized CASIO service provider.

Appendix

Button Operations

The following shows the function of each button under various conditions.

Unit Power Off

- [Power] Button Turns on power.
- [Record] Button Turns on power, launches Notes application, starts recording.
- [Calendar] Button Turns on power, displays Calendar screen.
- [Contacts] Button Turns on power, displays Contacts screen.
- [Menu] Button Turns on power, displays Menu screen.

Unit Power On

- [Start] Button Opens the  menu*.
- [Power] Button + press [Action] control Launches the touch screen calibration procedure.
- [Action] Button + Cursor up Makes contrast darker.
- [Action] Button + Cursor down Makes contrast lighter.
- [Action] Button + Cursor right Increases brightness.
- [Action] Button + Cursor left Decreases brightness.

* See the *Pocket PC User's Guide* for details on the  menu.

Specifications

Model: E-125
Display: 240 × 320 dots
TFT Color LCD (65,536 colors)
CPU: VR4122
Memory: 32MB
Interfaces: Serial: RS-232C, 115.2 kbps max.
Infrared: IrDA Ver. 1.2
Range: 20 cm max.
USB (Client)

Card Slot: CompactFlash card, 3.3V Type I / Type II

Headphone jack: ø 3.5 mm stereo output

Accepts monaural earphone, stereo earphones/headphones.

Power Supply

Main: Rechargeable battery pack JK-210LT (Lithium-Ion battery)
AC adapter (AD-C59200)

Backup: One CR2032 lithium battery

Power Consumption: 4.0W

Approximate Battery Life (Normal Temperature)

Main: (Actual time may be shorter due to conditions when charging.)

8 hours: Continuous input and data display at a ratio of 1:10, with screen brightness at lowest possible level.

3 hours: Continuous communication using the optional modem card (JK-711MC56, US and Canada only), with screen brightness at lowest possible level.

- Even when the unit is turned off, small amounts of power are required to retain memory contents, etc. This can cause batteries to go dead even when you do not use the unit.
- The actual amount of operation time that can be expected from batteries depends on operating conditions, settings, and other variables.

Backup: 5 years: Main battery is charged or replaced immediately after appearance of message to replace main battery.

1 week: No battery replacement after appearance of message to replace main battery.

Approximate Charge Time (Normal Temperature)

5 to 6 hours: Charge time is longer for the first charges after purchasing the unit or installing a new battery pack.

Operating Temperature: 0°C to 40°C (32°F to 104°F)

Charging Temperature: 10°C to 35°C (50°F to 95°F)

Dimensions: 20H × 83.6W × 131.2D mm (³/₄"H × 3¹/₄"W × 5¹/₈"D)

Weight: Approximately 250 g (8.8 oz)

Regulatory Information

GUIDELINES LAID DOWN BY FCC RULES FOR USE OF THIS UNIT IN THE U.S.A. (not applicable to other areas).

NOTICE

This equipment has been tested and found to comply with the limits for a Class B digital device, pursuant to Part 15 of the FCC Rules. These limits are designed to provide reasonable protection against harmful interference in a residential installation. This equipment generates, uses and can radiate radio frequency energy and, if not installed and used in accordance with the instructions, may cause harmful interference to radio communications. However, there is no guarantee that interference will not occur in a particular installation. If this equipment does cause harmful interference to radio or television reception, which can be determined by turning the equipment off and on, the user is encouraged to try to correct the interference by one or more of the following measures:

- Reorient or relocate the receiving antenna.
- Increase the separation between the equipment and receiver.
- Connect the equipment into an outlet on a circuit different from that to which the receiver is connected.
- Consult the dealer or an experienced radio/TV technician for help.

FCC WARNING

Changes or modifications not expressly approved by the party responsible for compliance could void the user's authority to operate the equipment.

Proper connectors must be used for connection to host computer and/or peripherals in order to meet FCC emission limits.

Connector E-125 unit to Cradle
Connector cable that comes with E-125
..... E-125 unit to desktop computer

Declaration of Conformity

Model Number: E-125
Trade Name: CASIO COMPUTER CO., LTD.
Responsible party: CASIO, INC.
Address: 570 MT. PLEASANT AVENUE, DOVER, NEW JERSEY 07801
Telephone number: 973-361-5400

This device complies with Part 15 of the FCC Rules, Operation is subject to the following two conditions: (1) This device may not cause harmful interference, and (2) this device must accept any interference received, including interference that may cause undesired operation.



Tested To Comply With FCC Standards
FOR HOME OR OFFICE USE

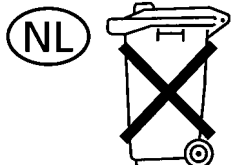

**Batterij niet weggooien,
maar inleveren als
KCA**



CASIO ELECTRONICS CO., LTD.
Unit 6, 1000 North Circular Road
London NW2 7JD, U.K.

CASIO®

CASIO COMPUTER CO., LTD.

6-2, Hon-machi 1-chome
Shibuya-ku, Tokyo 151-8543, Japan

PN411438-001
MO0007-A

Free Manuals Download Website

<http://myh66.com>

<http://usermanuals.us>

<http://www.somanuals.com>

<http://www.4manuals.cc>

<http://www.manual-lib.com>

<http://www.404manual.com>

<http://www.luxmanual.com>

<http://aubethermostatmanual.com>

Golf course search by state

<http://golfingnear.com>

Email search by domain

<http://emailbydomain.com>

Auto manuals search

<http://auto.somanuals.com>

TV manuals search

<http://tv.somanuals.com>