

DATA PROJECTOR

XJ-A135/XJ-A145/XJ-A155/ XJ-A245/XJ-A255

Data Projector USB Function Guide

- Be sure to read the precautions in the separate User's Guide (Basic Operations). For details about setting up the Data Projector, see the User's Guide (Basic Operations).
- Be sure to keep all user documentation handy for future reference.

- Microsoft, Windows, Windows Vista and PowerPoint are registered trademarks or trademarks of Microsoft Corporation in the United States and other countries.
- ArcSoft and the ArcSoft logo are trademarks or registered trademarks of ArcSoft, Inc. in the United States and other countries.
- Macintosh and Mac OS are trademarks or registered trademarks of Apple, Inc. in the United States and other countries.
- Other company and product names may be registered product names or trademarks of their respective owners.

- The contents of this manual are subject to change without notice.
- Copying of this manual, either in part or its entirety, is forbidden. You are allowed to use this manual for your own personal use. Any other use is forbidden without the permission of CASIO COMPUTER CO., LTD.
- CASIO COMPUTER CO., LTD. shall not be held liable for any lost profits or claims from third parties arising out of the use of this product, the included software or this manual.
- CASIO COMPUTER CO., LTD. shall not be held liable for any loss or lost profits due to loss of data due to malfunction or maintenance of this product, or any other reason.
- The sample screens shown in this manual are for illustrative purposes only, and may differ somewhat from the screens actually produced by the product.

CASIO®

Contents

About this manual.....	4
Terms and Conventions.....	4
About the Data Projector's USB Functions	5
Connecting a USB Device to the Data Projector	7
Installing the Software.....	8
Minimum System Requirements.....	8
To install EZ-Converter FA.....	9
To install ArcSoft MediaConverter 3 for CASIO Projector	10
Installing Multi Projection Camera Update Software.....	11
Projecting the Contents of Files on a Memory Device.....	12
Using EZ-Converter FA to Convert PowerPoint Files to ECA Files.....	12
Starting Up and Exiting EZ-Converter FA.....	13
Converting a PowerPoint File to an ECA File.....	14
Using Viewer to Project the Contents of a File on a Memory Device	18
Connecting a Memory Device to the Data Projector	18
Starting Projection with Viewer	20
Projecting an ECA (Presentation) File	22
Projecting an Image File	25
Projecting a Slideshow	26
Projecting a Movie File.....	27
File Menu Operations.....	30
Configuring Viewer Settings	33
Viewer Troubleshooting.....	36
Memory Devices	36
File Display and Playback.....	37
Viewer Error Messages.....	38

Performing a Presentation Using the YC-400/YC-430 Document Camera.....	39
YC Camera Application Function and Operation Overview	39
Connecting the Document Camera to the Data Projector.....	39
YC Camera Application Operations	42
YC Camera Application Projection Operations	42
Configuring YC Camera Application Setup Menu Settings	46
 Projecting the Screen Image of a Graphing Calculator.....	 50
To project the screen image of a graphing calculator	50

About this manual...

This manual explains function and operations when any one of the following devices is connected to the USB port of the CASIO Data Projector.

- USB memory device
- CASIO Multi Projection Camera (YC-400/YC-430)
- CASIO Graphing Calculator (fx-9860G Series)



Note

- Use of a memory device (page 5) requires separate purchase of commercially available USB memory or other memory.
- Use of a CASIO Multi Projection Camera or graphic scientific calculator requires separate purchase of the required device by you. Note that these products may not be available in some geographic areas. For full details, contact the retailer where you purchased this Data Projector or authorized CASIO dealer.

Terms and Conventions

In this manual, there are many procedures that require parallel operations on the Data Projector and your computer. The following are special terms and conventions used in this manual to differentiate between the Data Projector and computer.

- **Projection area**

This is the entire rectangular area that is projected by the Data Projector. Certain Data Projector operations will cause messages and menus to appear within the projection area.

- **Computer screen**

This is the physical display device of your computer.

About the Data Projector's USB Functions

The USB port that is built into the Data Projector lets you connect an external USB device and use it as an input source for image projection.

USB Memory Device or Memory Card

After you connect a memory device to the Data Projector's USB port, you can playback (project) the following types of files.

- ECA files (special projector presentation files)

The EZ-Converter FA software that comes with the Data Projector can be used to convert PowerPoint files to ECA (.eca) files for playback.

Note that unconverted PowerPoint files cannot be played back.

- Image Files

Playback is supported JPEG (jpg, jpeg, jpe; excluding progressive format) format or BMP (bmp) format image files up to about 8 MB in size.

- Movie Files

Playback is supported for the following type of movie files.

- Motion JPEG format (.avi)
- Resolution: 1280 × 720, 640 × 480, 320 × 240
- Maximum Data rate: 15 Mbps
- Frame rate: 24 fps maximum
- Audio Format: ADPCM

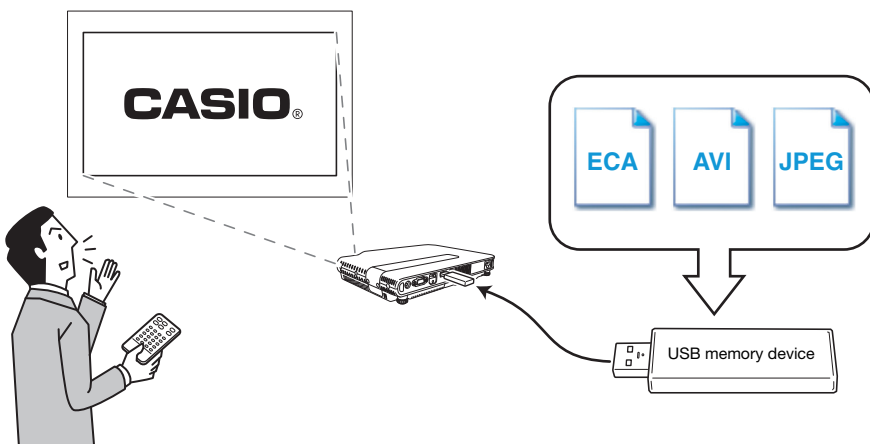

Refer to the following for details.

For more information about this:	Refer to this section of this manual:
Converting PowerPoint files to files that can be played back with the Data Projector	"Using EZ-Converter FA to Convert PowerPoint Files to ECA Files" (page 12)
Memory devices that can be connected to the Data Projector's USB port	"Connecting a Memory Device to the Data Projector" (page 18)
Operations for projecting the contents of files on a memory device	"Using Viewer to Project the Contents of a File on a Memory Device" (page 18)

Document Camera (CASIO YC-400/YC-430)

You can connect a CASIO Document Camera to the Data Projector's USB port and project the images of documents placed on the document stage of the YC-400/YC-430.

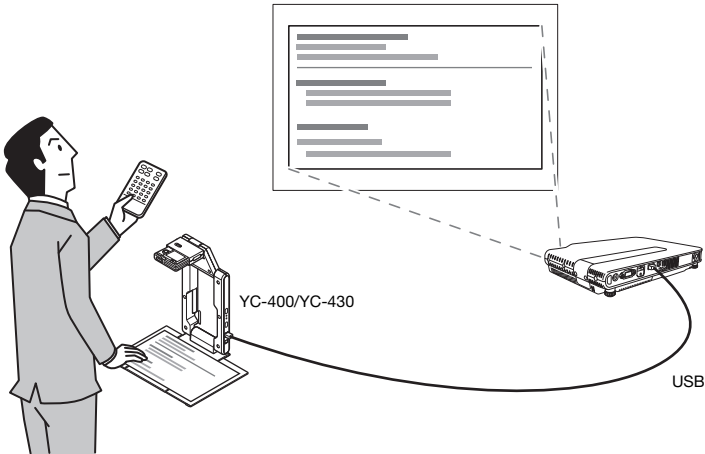

For more information, see “Performing a Presentation Using the YC-400/YC-430 Document Camera” on page 39.

Graphing Calculator (CASIO fx-9860G Series)

You can connect a CASIO fx-9860G series graphing calculator to the Data Projector's USB port and project calculator screen images with the projector.

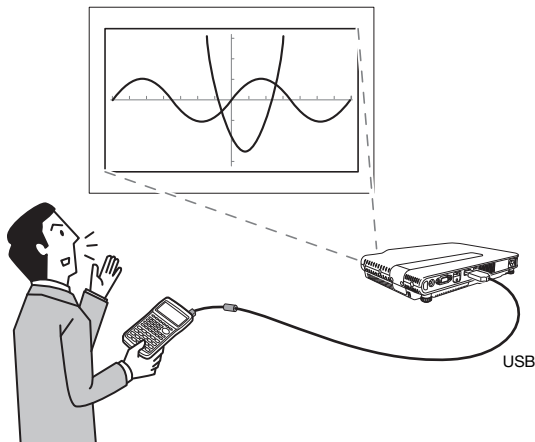

For details, see “Projecting the Screen Image of a Graphing Calculator” (page 50).

Connecting a USB Device to the Data Projector

What happens when you connect a USB device while the Data Projector is turned on depends on the current configuration of the Data Projector's plug-and-play setting. Plug-and-play is enabled under the Data Projector's initial default settings. For more details about the plug-and-play setting, see "Setup Menu Contents" in the User's Guide.

If you connect a USB device to the Data Projector's USB port while it is turned on, it will perform one of the following operations (depending on its current plug-and-play setting).

When plug-and-play is enabled:

When this type of device is connected:	The Data Projector does this automatically:
USB memory device or USB card reader with memory card loaded	Starts up Viewer (page 18) and projects the Viewer screen.
YC-400/YC-430 Document Camera	Starts up the YC Camera application (page 39) when the Document Camera is turned on and projects the YC Camera application screen.

When plug-and-play is disabled:

In this case, the image that is currently being projected does not change. However, Viewer, or the YC Camera Application will start up in the background, depending upon the type of USB device that is connected to the Data Projector.

Installing the Software

The following USB expansion function software is included on the CD-ROM that comes with the projector.

Software Name	Description
EZ-Converter FA	Software for converting a PowerPoint file to an ECA file that can be played back on the projector.
ArcSoft MediaConverter 3 for CASIO Projector	Software for converting movie files.
Multi Projection Camera Update Software	Software for updating the firmware of the YC-400 Multi Projection Camera.

Minimum System Requirements

- Operating System: Microsoft® Windows® 7, Windows Vista® SP2, or Windows® XP SP3
- Computer : IBM PC/AT or compatible that conforms to the following conditions
 - Windows® 7, Windows Vista®, or Windows® XP pre-installed
 - PowerPoint 2003, or 2007 installed (to use EZ-Converter FA)
 - **CPU:** Pentium® M 1.6GHz or higher; CPU recommended for your computer's operating system
 - **Memory:** The amount of memory recommended for operating system being run
 - **Display:** Full-color display with resolution of at least 1024 × 768 that is supported by above operating systems and the computer being used.
 - **Input Device:** Keyboard or other pointing device (mouse supported by the above operating system or equivalent device)
- Normal operation may not be possible under certain hardware configurations.
- Operation is not supported on a computer running Windows® 2000, NT, Me, 98SE, 98, 95, or 3.1, or on a Macintosh or Mac OS computer.
- Operation on a computer upgraded to Windows® 7, Windows Vista®, or Windows® XP from another operating system is not supported.
- Operation on a computer running Windows® XP Professional x64 Edition is not supported.

To install EZ-Converter FA

- 1. Place the CD-ROM that comes with the projector into your computer's CD-ROM drive.**
 - This will automatically display the CD-ROM menu screen.
- 2. On the menu screen, click the [Install] button to the right of "EZ-Converter FA".**
 - Follow the instructions on the dialog boxes that appear on the screen.
 - If you are running Windows 7 and the "User Account Control" message appears while installing, click [Yes].
 - If you are running Windows Vista and the "User Account Control" message appears while installing, click [Continue].
 - If you are running Windows XP and message shown below appears while installing, click [Continue Anyway].



To install ArcSoft MediaConverter 3 for CASIO Projector

1. Place the CD-ROM that comes with the projector into your computer's CD-ROM drive.
 - This will automatically display the CD-ROM menu screen.
2. On the menu screen, click the [Install] button to the right of "ArcSoft MediaConverter 3 for CASIO Projector".
 - Follow the instructions on the dialog boxes that appear on the screen.
 - If you are running Windows 7 and the "User Account Control" message appears while installing, click [Yes].
 - If you are running Windows Vista and the "User Account Control" message appears while installing, click [Continue].
 - If you are running Windows XP and message shown below appears while installing, click [Continue Anyway].



Note

For information about ArcSoft MediaConverter 3 for CASIO Projector operation and convertible movie file formats, see the software's help after you install it. To display help, click the  button in the upper right corner of the ArcSoft MediaConverter 3 for CASIO Projector window. On the menu that appears, select [Help].

Installing Multi Projection Camera Update Software

A YC-400 Multi Projection Camera can be connected to the Data Projector only if it is running firmware version 1.1 or higher. For information about how to check the firmware version of a camera, see the file named “YC-Update_Guide_English.pdf” in the “English” folder inside the “User’s Guide” folder on the CD-ROM that comes with the projector.

To install Multi Projection Camera Update Software

- 1. Place the CD-ROM that comes with the projector into your computer’s CD-ROM drive.**
 - This will automatically display the CD-ROM menu screen.
- 2. On the menu screen, click the [Open Folder] button to the right of “Multi Projection Camera Update Software”.**
 - This will open the folder on the CD-ROM that contains the file named “YC-400.exe”.
- 3. Double-click “YC-400.exe”.**
 - Follow the instructions on the dialog boxes that appear on the screen.



Note

Completing the above steps will create a file named “YC-400.bin” in the folder you specify. For information about how to use the file to update the firmware version of a camera, see the file named “YC-Update_Guide_English.pdf” in the “English” folder inside the “User’s Guide” folder on the CD-ROM that comes with the projector.

Projecting the Contents of Files on a Memory Device

This section explains how to perform the following operations.

- How to use EZ-Converter FA computer software to convert PowerPoint files to files that can be played back with the Data Projector's Viewer function.
- How to project the contents of files stored on a memory devices with the Data Projector's Viewer function.

Viewer is one of the Data Projector's built-in applications. It lets you play back and project the contents of files from a memory device connected to the Data Projector.

Using EZ-Converter FA to Convert PowerPoint Files to ECA Files

EZ-Converter FA is computer software for converting PowerPoint files to ECA files that can be played back and projected by the Data Projector. EZ-Converter FA supports conversion of file created with Microsoft Office PowerPoint 2003 and 2007. Save for certain exceptions (described below), playback and projection of an ECA file normally should be able to reproduce transitions, animations, and other special effects of the original PowerPoint file.

- Conversion of OLE objects (movies, audio, etc.) and VBA objects in a PowerPoint file is not supported.
- Conversion of timer and repeat operations in a PowerPoint file animation are not supported.
- Animation length is limited by the setting you configure under "To specify the maximum animation display time" (page 16). If a PowerPoint file has an animation that is longer, the conversion process will convert only up to the currently specified maximum animation display time and then advance to the next step.
- Pauses are limited to three seconds. If a PowerPoint file has a pause that is longer, the conversion process will allow three seconds and then advance to the next step.



Important!

In order to perform the procedures in this section, you will first need to install the EZ-Converter FA software from the CD-ROM that comes with the Data Projector onto your computer. For more information, see "Installing the Software" (page 8).

Starting Up and Exiting EZ-Converter FA

To start up EZ-Converter FA

Perform either of the following operations to start up EZ-Converter FA on the computer.

- Double-click the  icon on your Windows desktop.
- On your computer's Windows Start menu, select [All Programs] - [CASIO] - [EZ-Converter FA].



Important!

If your computer is running Windows Vista or Windows 7, starting up EZ-Converter FA will cause the "User Account Control" message to appear. When it does, click [Allow].

EZ-Converter FA Window

The following shows the window that appears while EZ-Converter FA is running.

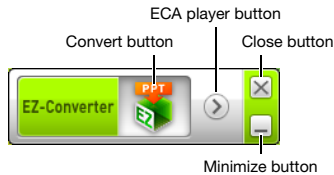

To display EZ-Converter FA help

Right-click the left side of the window and then select "Help" on the menu that appears.

To display EZ-Converter FA version information

Right-click the left side of the window and then select "About" on the menu that appears.

To close EZ-Converter FA

Click the close button in the upper right corner of the EZ-Converter FA window.

Converting a PowerPoint File to an ECA File



Important!

- Before performing any of the operations here, you will need to have a file created using Microsoft Office PowerPoint 2003 or 2007 on hand.
- Conversion of a PowerPoint file to an ECA file requires playback of the original file from beginning to end. Note that the time required for conversion will roughly correspond to the time required for playback.



Note

- Starting a conversion operation with EZ-Converter FA will temporarily change the screen settings of your computer as shown below. Screen settings will revert back to what they were after the conversion operation is complete.

Operating System:	Changes:
Windows XP	<ul style="list-style-type: none">● Screen resolution changes to 1280 × 800 or 1024 × 768.● Display card hardware acceleration is disabled.
Windows Vista or Windows 7	<ul style="list-style-type: none">● Screen resolution changes to 1280 × 800 or 1024 × 768.● Windows changes to the Basic mode (Windows Aero™ disabled).

- The screen resolution of the ECA file will be the resolution specified by EZ-Converter FA setting (1280 × 800 or 1024 × 768) when the file conversion operation starts. For information about configuring this setting, see “To specify the screen resolution of the ECA file” (page 16).

To convert a PowerPoint file to an ECA file

1. Turn on your computer and start up Windows.

2. Connect the USB memory (or memory card) where you want to store the converted ECA file to your computer.

- You can skip this step if you want to save the ECA file to your computer’s local hard disk.

3. On your computer, start up EZ-Converter FA.

- If your computer is running Windows Vista or Windows 7, starting up EZ-Converter FA will cause the “User Account Control” message to appear. When it does, click [Allow].
- This will display EZ-Converter FA window.



4. Configure the following settings as required.

- Specify the ECA file screen display resolution. See “To specify the screen resolution of the ECA file” (page 16).
- If the original file contains an animation, specify the maximum animation display time. See “To specify the maximum animation display time” (page 16).

5. Click the button at the top of the EZ-Converter FA window.

- This displays a dialog box for opening files.

6. Select the PowerPoint file you want to convert from and then click the [Open] button.

- This will display a dialog box like the one shown below for specifying the ECA file settings.

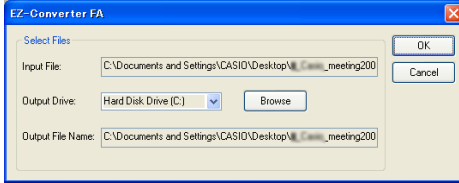

7. Configure the settings as required on the dialog box.

- The following describes the meanings and settings of each of the items that appear on the dialog box.

Dialog Box Item	Description
Input File	Shows the name of the PowerPoint file selected in step 6. The setting of this item cannot be changed.
Output Drive	Shows the drive name of the removable disk (USB memory or memory card) connected to the computer in step 2. When you have multiple removable disks connected to your computer, you can click the [▼] button and select the name of the drive where you want to save the converted file. The converted ECA file will be saved in a folder named "ECA" on the drive you specify here. Under initial default settings, if there are no removable disks connected to the computer, the resulting ECA file will be saved in the same location (drive and folder) as the original PowerPoint file. Click the [Browse] button and change the save destination, if you want.
Output File Name	Shows the file name of the converted ECA file, along with the path from the drive name. Except for the extension, the file name is the same as the PowerPoint file name. The setting of this item cannot be changed.

8. After configuring all the settings you want, click [OK].

- This will start playback of the PowerPoint file and start converting it to an ECA file.
- The "Conversion complete." message will appear when file conversion is complete.
- If you have other PowerPoint files you want to convert, repeat steps 4 through 7.
- To check the contents of an ECA file, perform the procedure under "To play back an ECA file on your computer" (page 16).

9. After you are finished converting all the files you want, click the close button in the upper right corner of the EZ-Converter FA window.

To specify the screen resolution of the ECA file

1. Right-click the left side of the EZ-Converter FA window.
2. On the menu that appears, click “Output Resolution”.
3. On the sub-menu that appears, select the resolution you want.
 - The following shows the resolution settings that should be used for each Data Projector model.

Model	Resolution
XJ-A135, XJ-A145, XJ-A155	1024 × 768
XJ-A245, XJ-A255	1280 × 800

- Your computer may not support the 1280 × 800 option, depending on its display resolution.
- The setting you select here remains in effect until you change it.

To specify the maximum animation display time

1. Right-click the left side of the EZ-Converter FA window.
2. On the menu that appears, click “Max Animation Display Time”.
3. On the sub-menu that appears, select a maximum animation display time value (in seconds).
 - Available sub-menu options are 10 seconds, 20 seconds, 30 seconds, and 60 seconds.
 - The option you select remains in effect until you change it.

To play back an ECA file on your computer

1. On your computer, start up EZ-Converter FA.
 - This will display EZ-Converter FA window.



2. Click the  button at the top of the EZ-Converter FA window.
 - This will display two more buttons as shown below.







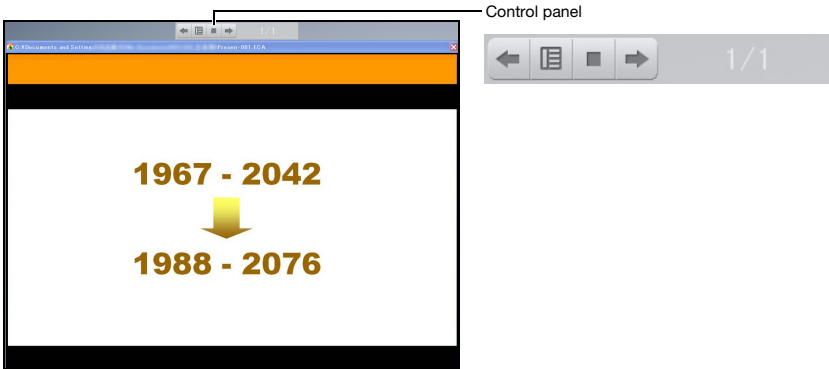

3. Click the  button.
 - This displays a dialog box for opening files.
4. Select the ECA file you want to play back and then click the [Open] button.

5. Click the button to start playback.

- This will display a control panel at the top of the screen.



- During file playback, you can use the control panel buttons to perform the operations described below.

To do this:	Perform this operation:
Go to the previous page	Click the  button.
Go to the next page	Click the  button.
Stop playback	Click the  button.
Jump to a specific page	1. Click the  button and then click "Slide Viewer" on the menu that appears. 2. On the page menu that appears, click the thumbnail of the destination page and then click [OK].
Display help	Click the  button and then click "Help" on the menu that appears.
Stop playback	Click the  button and then click "Exit" on the menu that appears. You could also press the [ESC] button on your computer keyboard to stop playback.

Using Viewer to Project the Contents of a File on a Memory Device

Use the Data Projector's Viewer application to project the contents of a file on a memory device. Viewer starts up automatically whenever you connect a memory device that is supported by the Data Projector into the Data Projector's USB port.

Connecting a Memory Device to the Data Projector

The Data Projector's USB port supports connection of a FAT/FAT32 format memory device supported by the USB interface. The following are supported memory devices.

- USB memory
- Memory cards
A commercially available USB card reader is required to connect a memory card to the Data Projector.
- USB storage class (USB Mass Storage Class) compatible digital cameras



Important!

The Data Projector does not support connection of all commercially available USB memory devices, memory cards, and digital cameras. For details about specific supported memory devices, contact your original retailer or your nearest authorized CASIO dealer.

To connect USB memory to the Data Projector

Connect USB memory to the Data Projector's USB port as shown below.

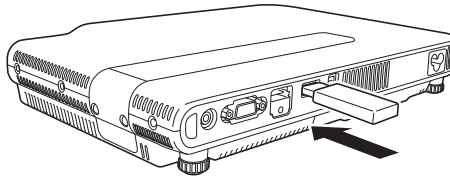

To connect a memory card to the Data Projector

1. Connect a USB card reader that supports the memory card you are using to the Data Projector's USB port.

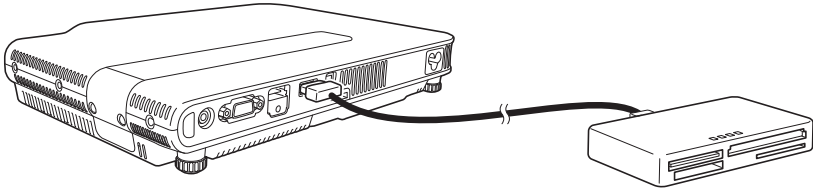

2. Load the memory card into the USB card reader's card slot.
 - For details about how to load a memory card into the USB card reader, see the user documentation that comes with the reader.

To connect a digital camera to the Data Projector

1. If necessary, configure the digital camera's USB mass storage class setting.
2. Turn off the digital camera and connect a USB cable to it.
3. Connect the other end of the USB cable (Type A connector) to the Data Projector's USB port.
4. Turn on the digital camera.



Note

For details about steps 1, 2, and 4, see the user documentation that comes with your digital camera.

Starting Projection with Viewer

If the Data Projector is turned on and you are performing the procedure under “Connecting a Memory Device to the Data Projector” (page 18) to connect USB memory to the Data Projector will cause the main Viewer window shown below to be projected.



Menu Item	Function	Refer to:
Presentation	Enters the Presentation Mode for projection of ECA files.	“Projecting an ECA (Presentation) File” (page 22) “Converting a PowerPoint File to an ECA File” (page 14)
Slides	Enters the Slide Mode for projection of images files.	“Projecting an Image File” (page 25)
Movie	Enters the Movie Mode for projection of movie files.	“Projecting a Movie File” (page 27)
Viewer Setup	Displays the Viewer setup menu.	“Configuring Viewer Settings” (page 33)



Note

If Viewer projection does not start automatically at this time, perform the following steps to select “Viewer” as the input source.

- 1. Press the [INPUT] key.**
 - This displays the input source selection screen.
- 2. Use the [▲] and [▼] keys to move the highlighting to “Viewer” and then press the [ENTER] key.**

Drive Menu

Entering the Presentation Mode, Slide Mode, or Movie Mode while there are multiple memory devices connected to the Data Projector (multiple USB memory devices connected via a USB hub, multiple memory cards loaded in the memory card reader connected to the Data Projector, etc.) will cause a menu like the one shown below to appear on the projection screen.



When this happens, use the cursor keys to move the highlighting to the drive you want to use and then press the [ENTER] key. This will display a menu of files for the mode you are entering.



Note

The Data Projector can recognize up to four drives.

Projecting an ECA (Presentation) File

Use the Viewer Presentation Mode to project ECA files.

To project an ECA file

1. Connect the memory device where the ECA file you want to project is stored to the Data Projector.

- This will project the main Viewer window. If the main Viewer window does not appear, press the [INPUT] key and select “Viewer” as the input source.

2. Use the cursor keys to move the highlighting to “Presentation” and then press the [ENTER] key.

- This will project a file menu like the one shown below.

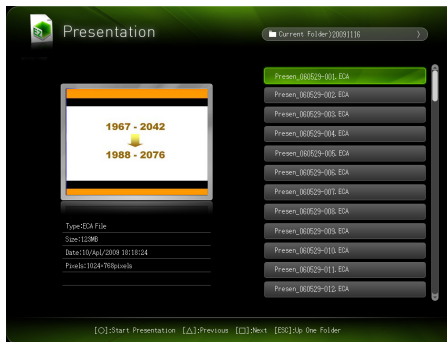

- If the ECA file you want to play back is located in a particular folder, use the cursor keys to move the highlighting to that folder and then press the [ENTER] key.

3. Use the cursor keys to move the highlighting to the ECA file you want to play back and then press the [ENTER] key (or the [O] key).

- This will start playback of the selected ECA file.

4. Perform page change and other operations as required.

- For details about operations you can perform during projection of an ECA file, see “Operations during ECA File Projection” (page 23).
- To stop ECA file playback and return to the file menu, press the [ESC] key.
- If you allow ECA file playback to proceed to the end, the file menu will appear on the projection screen after the end of the file is reached.

Operations during ECA File Projection

The operations described below can be performed while an ECA file is playing.

To do this:	Perform this operation:
Go to the previous page	Press the [◀] key.
Go to the next page	Press the [▶] key.
Pause ECA file playback	<ol style="list-style-type: none">1. Press the [FUNC] key.2. On the function menu that appears, use the cursor keys to move the highlighting to "Pause" and then press the [ENTER] key.
Jump to a specific page	<ol style="list-style-type: none">1. Press the [○] key to display a page menu.2. Use the cursor keys to move the highlighting to the thumbnail of the page where you want to start playback of the presentation and then press the [ENTER] key. <ul style="list-style-type: none">● For information about the other operations you can perform while the page menu is displayed, see "Page Menu Operations" (page 24).
Stop playback and return to the file menu	Press the [ESC] key.

The operations described below can be performed while ECA file playback is paused.

To do this:	Perform this operation:
Resume ECA file playback from where it was paused	Press the [ENTER] key.

Page Menu Operations

Pressing the [O] key while an ECA file is being played will project a page menu like the one shown below.

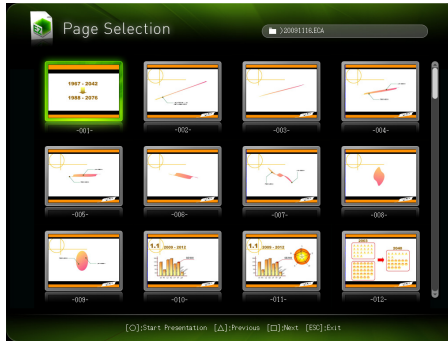

The operations described below can be performed while the page menu is being projected.

To do this:	Perform this operation:
Re-start file playback from a particular page	Use the cursor keys to move the highlighting to the thumbnail of the page where you want to start playback of the presentation and then press the [ENTER] key.
Scroll to the next screen	Press the [□] key.
Scroll to the previous screen	Press the [Δ] key.
Re-start file playback from the page that was being projected when you pressed [ENTER] to project the page menu	Press the [ESC] key.

Projecting an Image File

Use the Viewer Slide Mode to project image files. You can also group image files and project them in a specific sequence as a slideshow.

To project an image file

1. Connect the memory device where the image file you want to project is stored to the Data Projector.

- This will project the main Viewer window. If the main Viewer window does not appear, press the [INPUT] key and select “Viewer” as the input source.

2. Use the cursor keys to move the highlighting to “Slides” and then press the [ENTER] key.

- This will project a file menu like the one shown below.

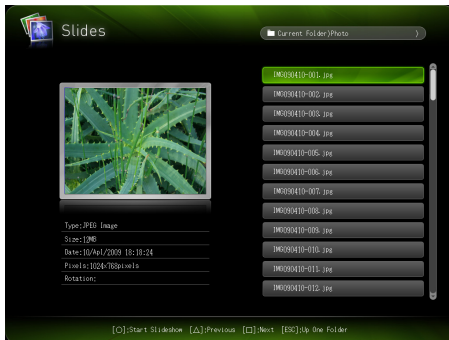

- If the image file you want to project is located in a particular folder, use the cursor keys to move the highlighting to that folder and then press the [ENTER] key.

3. Use the cursor keys to move the highlighting to the image file you want to project and then press the [ENTER] key.

- This will project the selected image file.

4. Perform the operations described below as required.

To do this:	Press this key:
Scroll back to the previous image	[◀]
Scroll forward to the next image	[▶]
Rotate the image right 90 degrees	[△]
Rotate the image left 90 degrees	[□]
Start a slideshow from the image file	[O]

5. To stop image projection and return to the file menu, press the [ESC] key.

Projecting a Slideshow

The Data Projector's Slide Mode lets you group multiple image files and project them in sequence as a slideshow. You can select either manual playback or auto playback for slideshow image display. The initial default setting is manual playback.

To prepare image files for slideshow play

Note the following points when preparing your slideshow on your computer.

- All of the image files in the slideshow must be in the same folder.
- Images will appear during a slideshow in the file name sequence the image files are arranged in the folder. To display images in a specific sequence, adjust their file names so they are listed in the folder in the sequence you want.
- Copy the folder with the slideshow images to a memory device.

To project image files as a slideshow

- 1. Connect the memory device where the image files of the slideshow are stored to the Data Projector.**
 - This will project the main Viewer window. If the main Viewer window does not appear, press the [INPUT] key and select "Viewer" as the input source.
- 2. Select either manual or auto scroll, and configure other slideshow settings.**
 - For more information, see "Configuring Viewer Settings" (page 33).
- 3. Use the cursor keys to move the highlighting to "Slides" and then press the [ENTER] key.**
 - This will project a file menu.
- 4. Use the cursor keys to move the highlighting to the folder that contains the image files that make up your slideshow and then press the [ENTER] key.**
- 5. Use the cursor keys to move the highlighting to the image file you want to start the slideshow from and then press the [O] key.**
 - This will project the selected image file and start the slideshow.

6. Perform the operations described below as required.

To do this:	Perform this operation:
Scroll back to the previous image	Press the [◀] key.
Scroll forward to the next image	Press the [▶] key.
Pause the slideshow (This option is available only when "Auto" is specified for the "Image Switching" setting on the setup menu.)	1. Press the [FUNC] key. 2. On the function menu that appears, use the cursor keys to move the highlighting to "Pause" and then press the [ENTER] key.
Rotate the image right 90 degrees	Press the [△] key.
Rotate the image left 90 degrees	Press the [□] key.

- The following operations can be performed while a slideshow is paused.

To do this:	Press this key:
Scroll back to the previous image	[◀]
Scroll forward to the next image	[▶]
Rotate the image right 90 degrees	[△]
Rotate the image left 90 degrees	[□]
Resume the slideshow	[○]

7. To return to the file menu after the slideshow is complete, press the [ESC] key.

Projecting a Movie File

Use the Viewer Movie Mode to project movie files.



Note

- Viewer supports playback of Motion JPEG format AVI movie files (see page 5 for details). Playback of other format movie files is not supported.
- The CD-ROM that comes with the Data Projector contains software (ArcSoft MediaConverter 3 for CASIO Projector) for converting some movie file formats to the supported format. For information about installing this software, see "Installing the Software" (page 8).

To project a movie file

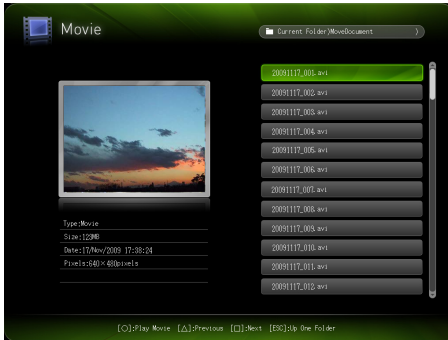

- 1. Connect the memory device where the movie file you want to project is stored to the Data Projector.**
 - This will project the main Viewer window. If the main Viewer window does not appear, press the [INPUT] key and select “Viewer” as the input source.
- 2. Use the cursor keys to move the highlighting to “Movie” and then press the [ENTER] key.**
 - This will project a file menu like the one shown below.



- If the movie file you want to play back is located in a particular folder, use the cursor keys to move the highlighting to that folder and then press the [ENTER] key.
- 3. Use the cursor keys to move the highlighting to the movie file you want to play back and then press the [ENTER] key (or the [O] key).**
 - This will start playback of the selected movie file.
- 4. Perform pause and other operations as required.**
 - For details about operations you can perform during projection of a movie file, see “Operations during Movie File Projection” (page 29).
 - To stop movie file playback and return to the file menu, press the [ESC] key.
 - When playback reaches the end of the movie file, the projection image will show a still image of the final movie frame.
- 5. To return to the file menu after movie playback is complete, press the [ESC] key.**

Operations during Movie File Projection

The operations described below can be performed while a movie file is playing or paused.



To do this:	Perform this operation:
Pause and resume movie playback	Press the [ENTER] key. <ul style="list-style-type: none"> A pause icon () is displayed in the upper left corner of the projection screen while movie projection is paused.
Re-play the file from the beginning	1. Press the [FUNC] key. 2. On the function menu that appears, use the cursor keys to move the highlighting to "Play from beginning" and then press the [ENTER] key.
Display the play time in the upper left corner of the projection screen 	Press the [O] key. <ul style="list-style-type: none"> Each press of the [O] key toggles the time indicator between show and hide.
Fast forward*	Press the [▶] key.
Fast reverse*	Press the [◀] key.
Stop ECA file playback and return to the file menu	Press the [ESC] key.







* For details about fast forward and fast reverse, see "To perform fast forward and fast reverse during movie playback", below.

To perform fast forward and fast reverse during movie playback

1. Perform steps 1 through 3 under "To project a movie file" (page 28) to start playback of the movie file.

2. Press the [▶] key for fast forward or the [◀] key for fast reverse.

- This starts the corresponding operation and displays an icon ( for fast forward,  for fast reverse) in the upper left corner of the projection screen.
- Each press of the [▶] or [◀] key cycles the corresponding operation between three speeds.

This icon:	Indicates this:
	Fast forward (10-second increment)
	6X fast forward (60-second increment)
	60X fast forward (10-minute increment)
	Fast reverse (10-second increment)
	6X fast reverse (60-second increment)
	60X fast reverse (10-minute increment)

- Movie playback stops automatically when a fast forward or fast reverse operation reaches the last or the first frame of the movie file.

3. Perform the operations described below as required.

To do this:	Press this key:
Quit a fast forward or fast reverse operation and resume normal playback	[ENTER]
Toggle display of the playback time between show and hide	[O]
Stop playback and return to the file menu	[ESC]

File Menu Operations

This section explains operations you can perform while the file list is displayed in the Presentation, Slide, or Movie Mode.

List View and Icon View

There are two different views for the Viewer file menu: a list view and an icon view.

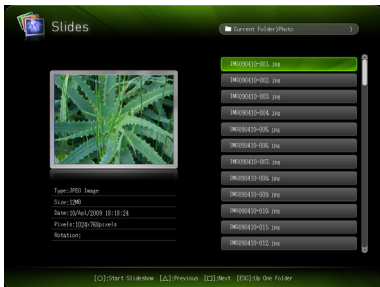

List view

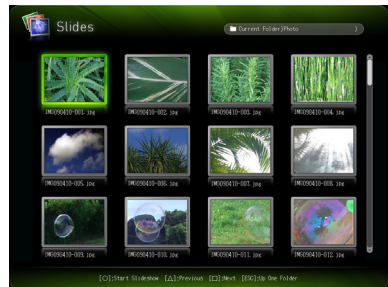

Icon view

List view:

This view lists the names of the folders and files on a memory device. This is the initial default view for the Presentation, Slide, or Movie Mode.

Icon view:

This view shows both icons and names for the folders and files on a memory device. Thumbnails are displayed for all of the files that can be played back by the Viewer.

To toggle the file menu between the list view and icon view

Press the [FUNC] key and then the [ENTER] key.



Note

You can specify either the list view or icon view as the default view. For more information, see “Configuring Viewer Settings” on page 33.

To scroll the file menu

Press the [□] key to scroll forward, and the [△] key to scroll back.

To open a folder

Use the cursor keys to move the highlighting to the folder you want to open and then press the [ENTER] key.



Note

Counting the root directory of the memory device as the first level you can open nested folders up to 10 levels.

To exit the current folder and move up to the next level

Press the [ESC] key.

To view file properties

1. Display the file menu list view.
2. Use the [▼] and [▲] keys to move the highlighting to the file whose properties you want to view.

- A thumbnail and the properties of the currently highlighted file will appear on the left side of the file menu.



- The following explains the information that appears in file properties.

Presentation Mode

This item:	Shows this:
Type	"ECA File" (Presentation file converted with EZ-Converter FA)
Size	File size
Date	Date and time the file was last modified
Pixels	Number of pixels in the file

Slide Mode

This item:	Shows this:
Type	Image type ("JPEG Image" or "BMP Image")
Size	File size
Date	Date and time the file was last modified
Pixels	Number of pixels in image data included in the file
Rotation	This item appears only for image files that include Exif format orientation information. "Right side - Top" indicates 90-degree rotation right, while "Left side - Bottom" indicates 90-degree rotation left.

Movie Mode

This item:	Shows this:
Type	"Movie"
Size	File size
Date	Date and time the file was last modified
Pixels	Number of movie pixels in the file

To return to the main Viewer window

1. Press the [FUNC] key.
2. On the function menu that appears, use the cursor keys to move the highlighting to “Back to Viewer Selection” and then press the [ENTER] key.

Configuring Viewer Settings

You can use the Viewer setup menu to configure the Viewer function settings described below. The initial default setting for each item is indicated by an asterisk (*).

Setting Name	Description
Image Zoom	Zoom*: Causes images to be projected at the Data Projector’s maximum possible size while maintaining the aspect ratio of the image file. No Zoom: Causes images to be projected at the actual size.
Display Sequence Setup	Specifies the sequence of images in the file menu. File Names (Ascending)*: Displays files in file name ascending order. File Names (Descending): Displays files in file name descending order Time (New-to-Old): Displays files by the time they were last modified, from the newest to the oldest. Time (Old-to-New): Displays files by the time they were last modified, from the oldest to the newest.
Startup Mode	Specifies whether the default view when a mode is entered from the main Viewer window is the list view or icon view. List View*: Specifies list view as the default view. Icon View: Specifies icon view as the default view.
Image Switching	Manual*: Specifies manual image scrolling. Auto: Specifies auto image scrolling.
Slideshow Display Interval	Specifies how long each image will remain displayed during a slideshow. 5 seconds*, 10 seconds, 30 seconds, 1 minute, 5 minutes
Slideshow Repeat	Repeat: Loops playback of a slideshow or movie. No Repeat*: Automatically stop playback when the end of a slideshow or movie is reached.
Movie Display	Zoom*: Causes movies to be played back at the Data Projector’s maximum possible size while maintaining the aspect ratio of the movie file. No Zoom: Causes movie files to be played back at their original sizes.
Initialize Viewer Setup	Returns all Viewer settings to their initial factory defaults.

To display the Viewer setup menu



Perform either of the following operations.

Operation 1

1. Project the main Viewer window.

- If you are playing a file in the Presentation, Slide, or Movie Mode, pause playback and return to the file menu. Next, press [FUNC], then [▼], then [ENTER].

2. Use the cursor keys to move the highlighting to “Viewer Setup” and then press the [ENTER] key.

Operation 2

1. While the Viewer is being projected, press the [MENU] key.

- If you are playing a file in the Presentation, Slide, or Movie Mode, pause playback before pressing the [MENU] key.

2. Use the [▼] key to move the highlighting to “USB” and then press the [ENTER] key.

3. Use the [▼] key to move the highlighting to “Setup” and then press the [ENTER] key.

To configure Viewer settings

1. Display the Viewer setup menu.
2. Use the [▼] and [▲] keys to move the highlighting to the item whose setting you want to change.
3. Use the [◀] and [▶] keys to display the available settings.
4. After configuring all the settings you want, press the [ESC] key (or press the [FUNC] key and then the [ENTER] key).
 - This will return to the main Viewer window.

To return Viewer settings to their initial defaults

1. Display the Viewer setup menu.
2. Use the [▼] key to move the highlighting to “Initialize Viewer Setup” and then press the [ENTER] key.
 - This will cause a “Do you want to restore defaults for the Viewer setup?” confirmation dialog box to appear.
3. Use the [▲] key to move the highlighting to “Yes” and then press the [ENTER] key.
 - This will return Viewer settings to their initial factory defaults.
 - For information about the Viewer initial factory default settings, see “Configuring Viewer Settings” (page 33).

Viewer Troubleshooting

Refer to the following whenever Viewer operations are not what you expect.

Memory Devices

Problem	Cause and Required Action
Viewer does not appear when I connect USB memory to the Data Projector's USB port.	<ul style="list-style-type: none">● The USB memory you are connecting may have a format that cannot be recognized by the Data Projector. Connect the USB memory to your computer to check if its file system is FAT or FAT32. If it isn't, reformat the USB memory to FAT or FAT32. Note that doing so will delete all of the data currently in USB memory. If the Data Projector cannot recognize the USB memory even though its file system is FAT or FAT32, the USB memory itself may be incompatible. Try using different USB memory.● "Off" may be selected for the Data Projector's "Plug and Play" setting. Use the procedure in the "Configuring Advanced Projector Settings" section of the User's Guide on the CD-ROM to change the "Plug and Play" setting to "On".
Some folders and/or files are not displayed in the file menu.	<ul style="list-style-type: none">● All the folders and/or files contained in a folder will not be displayed if there are more than 999 folder and/or files inside the folder. If this happens, reduce the number of folders and/or files in the folder.● Viewer will not display folder contents past 10 folder nesting levels. When nesting folders on a memory device that you plan to connect to the Data Projector, make sure that nesting levels do not exceed 10.
There are multiple devices connected to the Data Projector via a USB hub or USB card reader, but some of the devices are not recognized.	The Data Projector can recognize up to four drives. If the number of connected drives is greater than four, the Data Projector will not recognize the fifth and subsequent drives. Connect memory devices while ensuring that no more than four drives are connected.
When I connect my digital camera to the Data Projector via USB, digital camera memory contents do not appear.	<ul style="list-style-type: none">● The digital camera's USB mass storage class setting may not be configured correctly, or you may need to perform some operation on the camera. Consult the user documentation for your digital camera for information about the required settings and operations.● The digital camera may not support USB mass storage class. If it does not, you will not be able to use Viewer to view digital camera memory contents.

File Display and Playback

Problem	Cause and Required Action
ECA files converted from PowerPoint files using EZ-Converter FA do not appear in the file menu.	Viewer may be in a mode other than the Presentation Mode. To enter the Presentation Mode, highlight "Presentation" on the main Viewer window (page 20) and then press the [ENTER] key.
Image files do not appear in the file menu.	<ul style="list-style-type: none"> ● Viewer may be in a mode other than the Slide Mode. To enter the Slide Mode, highlight "Slides" on the main Viewer window (page 20) and then press the [ENTER] key. ● The files may not be of a format that can be recognized by the Data Projector. Image files require the following file name extensions: .jpg, .jpeg, .jpe, or .bmp. For details about image file formats supported for Data Projector playback, see "About the Data Projector's USB Functions" (page 5).
Movie files do not appear in the file menu.	<ul style="list-style-type: none"> ● Viewer may be in a mode other than the Movie Mode. To enter the Movie Mode, highlight "Movie" on the main Viewer window (page 20) and then press the [ENTER] key. ● The files may not be of a format that can be recognized by the Data Projector. Movie files require the file name extensions .avi. For details about the movie file format supported for Data Projector playback, see "About the Data Projector's USB Functions" (page 5).
On the Slide Mode file menu, question marks (?) appear in place of thumbnails.	Question marks are displayed in place of thumbnails of images that cannot be projected by Viewer (JPEG files larger than 8MB, etc.).
I cannot play ECA files I select on the Presentation Mode file menu.	The file you are trying to play may be corrupted. Re-convert the PowerPoint files using the procedure under "To convert a PowerPoint file to an ECA file" (page 14).
I cannot play image files I select on the Slide Mode file menu.	<ul style="list-style-type: none"> ● The file you are trying to play may be corrupted. If you have the original file on your computer, check to see if it is normal. If it is, copy the original file to the memory device and try playing it again. ● If the message "Cannot display an image file." appears, refer to "Viewer Error Messages" (page 38).
I cannot play movie files I select on the Movie Mode file menu.	<ul style="list-style-type: none"> ● The file you are trying to play may be corrupted. If you have the original file on your computer, check to see if it is normal. If it is, copy the original file to the memory device and try playing it again. ● If the message "This movie file cannot be played back." appears, refer to "Viewer Error Messages" (page 38).

Viewer Error Messages

Problem	Cause and Required Action
Folder does not contain any image files.	There is no displayable folder, ECA file, image file, or movie file in the folder you are trying to access with Viewer. Use your computer to check the contents of the folder. For details about file formats supported for Data Projector playback, see "About the Data Projector's USB Functions" (page 5).
This ECA file cannot be played back.	There may be an error in the ECA file itself. Play back the ECA file using the EZ-Converter FA on your computer and check it.
Cannot display an image file.	<ul style="list-style-type: none"> ● The image file may be too large to play back. Use image files that are no larger than 8MB. ● The image file may be a progressive JPEG file. The Data Projector does not support playback of progressive JPEG files. Use normal (non-progressive) JPEG format files. ● There may be an error in the image file itself. Open the image file on your computer and check it.
This movie file cannot be played back.	<ul style="list-style-type: none"> ● The movie file may be a format that is not supported for Data Projector playback. For details about the movie file format supported for Data Projector playback, see "About the Data Projector's USB Functions" (page 5). Some movie file formats can be converted to a format supported for Data Projector playback using software (ArcSoft MediaConverter 3 for CASIO Projector) included on the CD-ROM that comes with the Data Projector. ● There may be an error in the movie file itself. Open the movie file on your computer and check it.

Performing a Presentation Using the YC-400/YC-430 Document Camera

This section explains how to connect the CASIO YC-400/YC-430 Multi Projection Camera (document camera) to the Data Projector in order to project the images of documents placed on the document stage of the document camera. The Data Projector's built-in application named YC Camera is used to project document images.



Important!

A YC-400 document camera can be connected to the Data Projector only if it is running firmware version 1.1 or higher. Firmware updating software is included on the CD-ROM that comes with the projector. For more information, see "Installing the Software" (page 8).

YC Camera Application Function and Operation Overview

YC Camera is an application built into the Data Projector that makes it possible to control the YC-400/YC-430 document camera from the Data Projector. With the YC Camera application you can project the image of documents placed on the document stage of the document camera. Connecting the document camera to the Data Projector's USB port and turning on the document camera will cause the YC Camera application to start up automatically.

Connecting the Document Camera to the Data Projector

This section provides the basic steps you need to perform in order to connect the document camera to the Data Projector and project the image of documents placed onto the document camera's document stage.



Important!

- The procedure below assumes that the Data Projector's plug-and-play feature is turned on (which is the initial default setting). If you have turned off plug-and-play, turn it back on before performing the procedure below. For more details about the plug-and-play setting, see "Setup Menu Contents" in the User's Guide.
- The resolution of recorded images is fixed at 4 megapixels when a YC-400/YC-430 Document Camera is connected to the Data Projector. The resolution setting cannot be changed in this case.

To connect the document camera to the Data Projector and project the image of a document

1. Turn on the Data Projector.

- Wait until the Data Projector's POWER/STANDBY indicator is lit green.

2. Connect the document camera to the Data Projector using the USB cable that comes bundled with the document camera.

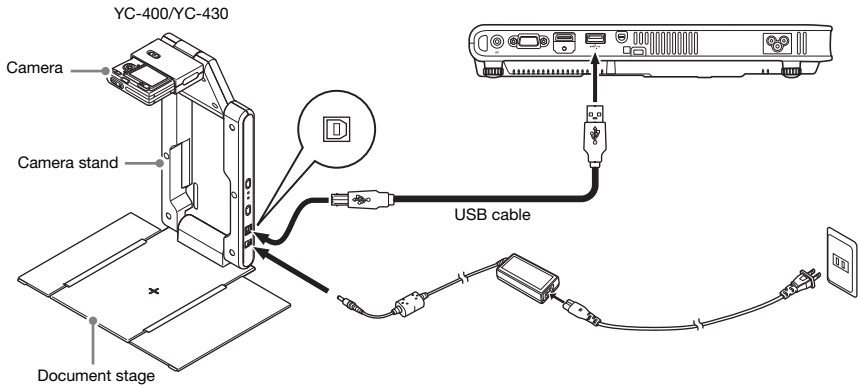

3. With nothing on the document stage, press the [⏻] (power) button on the camera stand.

- This will turn on the document camera, which will cause its lens to extend.
- The Data Projector will recognize the document camera and start up the YC Camera application automatically. When the YC Camera application starts up, the Data Projector will project an image of the document stage along with a dialog box for adjusting the document camera position.

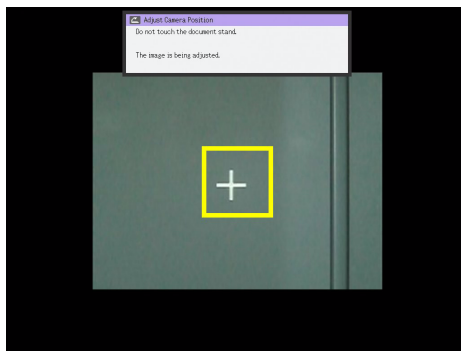

- If the document camera is positioned correctly, position adjustment will end automatically and the dialog box will close. At this time the monitor screen (the image being picked up by the document camera) will be projected.
- If the document camera is not positioned correctly, a message prompting you to adjust the document camera position will appear. Follow the instructions shown in the message to adjust the document camera position.

4. Place the document whose image you want to project onto the document camera's document stage.

- Be sure to place the document in the center of the stage, and do not let any part of the document extend off the edges of the stage.
- When placing a landscape orientation document onto the document stage, the top of the page should face towards the camera stand.
- Initially the monitor image will be projected, and so the image will appear a bit fuzzy.

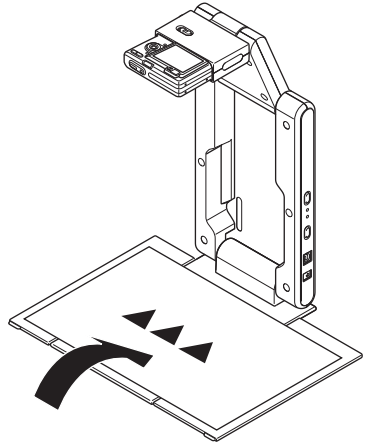

- When the document camera senses that the document on the stage is not being moved, it will record its image and switch from the fuzzy monitor image to a high-resolution image (recorded image) automatically.



Rough (Monitor) Image

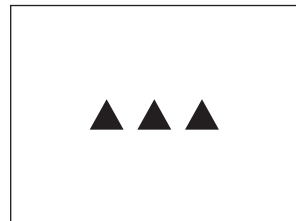

Recorded Image

5. Now you can replace the document currently on the stage with another one.

- This will switch to the recorded image of the next document automatically.



Note

Step 5 above is what happens while the Data Projector's YC Camera application is configured with its initial default settings. The recorded image will not switch automatically if you have changed the "Operation Mode" setting of the YC Camera application to "Manual Capture". For more information, see "YC Camera Application Setup Menu Contents" on page 48.

YC Camera Application Operations

This section explains the various types of projection operations you can perform with the YC Camera application and how to configure YC Camera application settings.



Important!

The procedures in this section assume that you have already connected the Document Camera to the Data Projector as explained under “Connecting the Document Camera to the Data Projector” (page 39), and that the Data Projector’s YC Camera application is running.

YC Camera Application Projection Operations

The operations in this section are performed using the YC Camera function menu, which appears when you press the [FUNC] key while the YC Camera application is running.

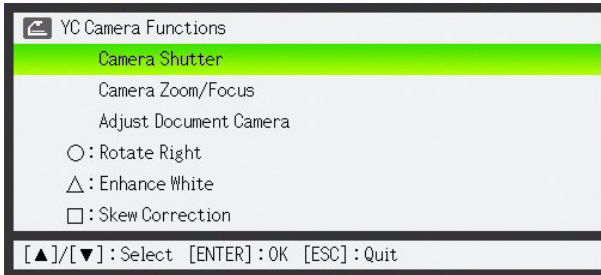

Some operations can be performed using the remote controller’s [○], [△], and [□] keys.

To release the document camera shutter manually

- 1. Press the [FUNC] key to display the YC Camera application function menu.**
 - The “Camera Shutter” item should be highlighted by default.
- 2. Press the [ENTER] key to release the document camera shutter.**
 - This will cause the image recorded with the document camera to be projected.



Note

While a rough monitor image or recorded image is projected, you can release the shutter manually by pressing the [ENTER] key, without pressing the [FUNC] key.

To adjust the document camera's zoom setting

1. Press the [FUNC] key to display the YC Camera application function menu.
2. Use the [▼] key to move the highlighting to “Camera Zoom/Focus” and then press the [ENTER] key.
 - This causes the YC Camera Zoom/Focus dialog box to appear in the projection area. The “Optical Zoom” item should be highlighted by default.

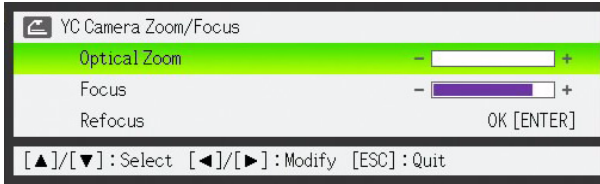

3. Use the [▶] and [◀] keys to adjust the document camera's zoom setting.
4. After the zoom setting is the way you want, press the [ESC] key.
 - This will close the YC Camera Zoom/Focus dialog box.

To adjust document focus manually

1. Press the [FUNC] key to display the YC Camera application function menu.
2. Use the [▼] key to move the highlighting to “Camera Zoom/Focus” and then press the [ENTER] key.
 - This causes the YC Camera Zoom/Focus dialog box to appear in the projection area.

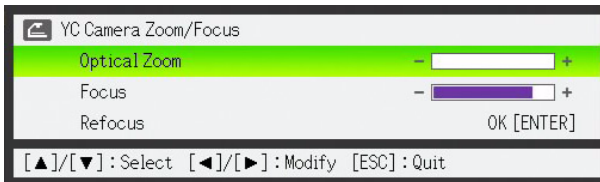

3. Press the [▼] key to move the highlighting to “Focus”.
4. Use the [▶] and [◀] keys to adjust the document camera's focus.
5. After the focus is the way you want, press the [ESC] key.
 - This will close the YC Camera Zoom/Focus dialog box.

To adjust the camera position

1. Remove all documents and objects from the document stage.
2. Press the [FUNC] key to display the YC Camera application function menu.
3. Use the [▼] key to move the highlighting to “Adjust Camera Position” and then press the [ENTER] key.
 - This displays the camera position adjustment dialog box.
4. Point the document camera downwards so the lens is pointed towards the document stage.
 - Aim the camera as instructed by the text that appears in the projection area.



- When the document camera is positioned correctly, position adjustment will end and the dialog box will close. At this time the monitor screen (the image being picked up by the document camera) will be projected.

To rotate the currently projected image

1. Press the [FUNC] key to display the YC Camera application function menu.
2. Use the [▼] key to move the highlighting to “Rotate Right” and then press the [ENTER] key.
 - This will rotate the projected image 90 degrees to the right.
 - Instead of steps 1 and 2 above, you can also rotate the projected image by pressing the [O] key.



Note

This operation will affect only the image that is currently being projected. The projection image produced the next time you release the shutter will be projected in accordance with the settings on the YC Camera Application Setup Menu (page 46).

To perform white enhancement on the currently projected image



Note

- White enhancement causes the background of the projected image to be white enhanced, which helps to make the text on a document easier to read.
- This operation will affect only the image that is currently being projected. The projection image produced the next time you release the shutter will be projected in accordance with the settings on the YC Camera Application Setup Menu (page 46).



Important!

You can perform white enhancement only on a projected image that has been skew corrected. For more information, see the note under “To perform manual skew correction on the currently projected image” (page 45).

- 1. Press the [FUNC] key to display the YC Camera application function menu.**
- 2. Use the [▼] key to move the highlighting to “Enhance White” and then press the [ENTER] key.**
 - This will enhance the white of the projected image.
 - Instead of steps 1 and 2 above, you can also white enhance the projected image by pressing the [△] key.

To perform manual skew correction on the currently projected image



Note

- Skew correction automatically straightens the image of a document that is misaligned on the document stage of the document camera. Under its initial defaults, the YC Camera application is configured to perform skew correction automatically. You can also turn off auto skew correction. If you do, you can use the following procedure to adjust image alignment manually.
- This operation will affect only the image that is currently being projected. The projection image produced the next time you release the shutter will be projected in accordance with the settings on the YC Camera Application Setup Menu (page 46).

- 1. Press the [FUNC] key to display the YC Camera application function menu.**
- 2. Use the [▼] key to move the highlighting to “Skew Correction” and then press the [ENTER] key.**
 - This will straighten the projected image.
 - Instead of steps 1 and 2 above, you can also perform skew correction of the projected image by pressing the [□] key.

Configuring YC Camera Application Setup Menu Settings

You can use the YC Camera setup menu to configure various YC Camera application operation settings.

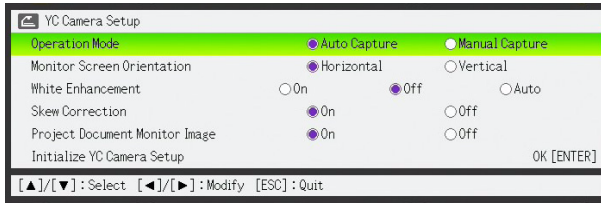

To configure YC Camera application setup menu settings

1. Press the [MENU] key to display the setup menu.
2. Press the [▼] key to move the highlighting to “USB” and then press the [ENTER] key.
3. Press the [▼] key once to move the highlighting to “Setup” and then press the [ENTER] key.
 - This will display the YC Camera application setup menu.
4. Use the [▼] and [▲] keys to select the menu item whose setting you want to change.
5. Press the [◀] or [▶] key to select the setting you want (so its button is ●).
6. Repeat steps 4 and 5 to configure other settings, if you want.
7. After you are finished, press the [ESC] key to exit the setup menu.



Note

Anytime you change the “White Enhancement” or “Skew Correction” setting, the new setting goes into effect from the next image you record with the document camera after exiting the setup menu. Other settings go into effect as soon as you exit the setup menu.

To restore all settings on the YC Camera application setup menu to their initial factory defaults

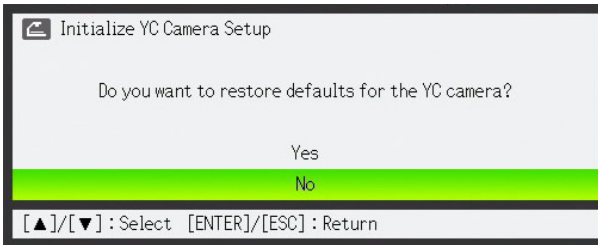

1. Press the [MENU] key to display the setup menu.
2. Press the [▼] key to move the highlighting to “USB” and then press the [ENTER] key.
3. Press the [▼] key once to move the highlighting to “Setup” and then press the [ENTER] key.
 - This will display the YC Camera application setup menu.
4. Press the [▼] key to move the highlighting to “Initialize YC Camera Setup” and then press the [ENTER] key.
 - This displays the dialog box shown below.



5. Use the [▲] key to select “Yes”.
6. To restore all the settings to their initial defaults, press the [ENTER] key.
 - To exit the operation without doing anything, press the [ESC] key instead of the [ENTER] key.
7. After you are finished, press the [ESC] key to exit the setup menu.

YC Camera Application Setup Menu Contents

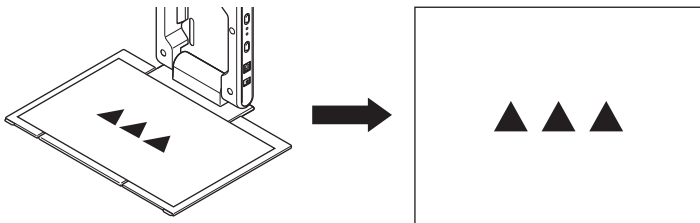
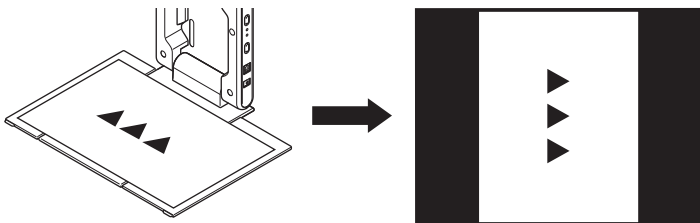
This section provides detailed explanations of all of the items included on the YC Camera application setup menu. The initial default setting for each item is indicated by an asterisk (*).

Setting Name	Description
Operation Mode	<p>Specifies whether recording of documents placed on the document stage of the document camera should be performed automatically or manually.</p> <p>Auto Capture*: Automatically records the image of a document whenever it is placed on the document stage.</p> <p>Manual Capture: Requires manual release of the shutter each time a document is placed on the document stage.</p>
Monitor Screen Orientation	<p>Switches the monitor screen orientation.</p> <p>Horizontal*: Records the document on the document stage horizontally.</p>  <p>Vertical: Records the document on the document stage vertically.</p> 
White Enhancement	<p>Specifies whether or not white enhancement should be performed on the projected image.</p> <p>Off*: Turns off white enhancement.</p> <p>On: Turns on white enhancement.</p> <p>Auto: The decision whether or not to perform white enhancement is made automatically in accordance with the image being recorded.</p> <p> Important! _____ White enhancement cannot be performed while the “Skew Correction” setting is “Off”.</p>

Setting Name	Description
Skew Correction	<p>Specifies whether or not skew correction should be performed automatically on the projected image.</p> <p>On*: Turns on automatic skew correction.</p> <p>Off: Turns off automatic skew correction.</p>
Project Document Monitor Image	<p>Specifies whether or not the camera's monitor image should be projected when a document is removed from the document stage.</p> <p>On*: Displays the monitor image.</p> <p>Off: Does not display the monitor image.</p>
Initialize YC Camera Setup	<p>Returns all YC Camera application setup menu items to their initial default settings. For details, see "To restore all settings on the YC Camera application setup menu to their initial factory defaults" on page 47.</p>

Projecting the Screen Image of a Graphing Calculator

You can connect a CASIO graphing calculator to the Data Projector using a USB cable and project the calculator's screen image with the Data Projector. USB connection of the following CASIO graphing calculators is supported.

- fx-9860G Series

To project the screen image of a graphing calculator

1. Set the graphing calculator up for data communication.

Enter the LINK Mode, and configure the "Wakeup" and "Capture" settings as shown below.



- Be sure to configure these communication settings before you connect the calculator to the Data Projector.
- See the user documentation that comes with your calculator for details about configuring these settings.

2. Turn on the Data Projector.

3. Use the USB cable that came with the graphing calculator to connect it to the Data Projector as illustrated below.

- This will project an image of the graphing calculator from the Data Projector.

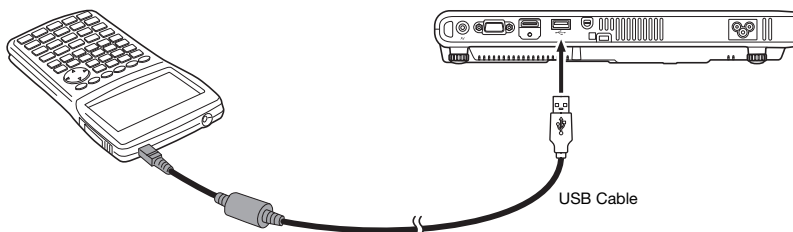

* The illustration shows the fx-9860G as an example.



Important!

- If an hourglass figure appears in the image projected from the Data Projector when you connect the calculator, perform some operation on the calculator. This should cause the hourglass to disappear and enable normal projection.
- If the calculator does not operate properly after you connect it to the Data Projector, try disconnecting the USB cable from the calculator and then reconnecting it. If this does not correct the problem, disconnect the USB cable from both the Data Projector and the calculator. Turn the Data Projector off and then back on again, and then re-connect the calculator.

CASIO®

CASIO COMPUTER CO.,LTD.
6-2, Hon-machi 1-chome
Shibuya-ku, Tokyo 151-8543, Japan

MA0912-A

Free Manuals Download Website

<http://myh66.com>

<http://usermanuals.us>

<http://www.somanuals.com>

<http://www.4manuals.cc>

<http://www.manual-lib.com>

<http://www.404manual.com>

<http://www.luxmanual.com>

<http://aubethermostatmanual.com>

Golf course search by state

<http://golfingnear.com>

Email search by domain

<http://emailbydomain.com>

Auto manuals search

<http://auto.somanuals.com>

TV manuals search

<http://tv.somanuals.com>