

COBY®

Portable 2.4"
Digital Photo Album with
MP3 Playback



DP-240



Instruction Manual

Please read this manual carefully before operation

Precautions

	CAUTION WARNING: SHOCK HAZARD, DO NOT OPEN. AVIS: RISQUE DE CHOC ELECTRIQUE. NE PAS OUVRIR	
CAUTION: TO REDUCE THE RISK OF FIRE AND ELECTRIC SHOCK, DO NOT REMOVE THE COVER (OR BACK) OF THE UNIT. REFER SERVICING ONLY TO QUALIFIED SERVICE PERSONNEL.		



The lightning flash with arrowhead symbol within an equilateral triangle is intended to alert the user to the presence of uninsulated "dangerous voltage" within the product's enclosure that may be of sufficient magnitude to constitute a risk of electric shock.



The exclamation point within an equilateral triangle is intended to alert the user to the presence of important operation and servicing instructions in the literature accompanying the appliance.

For Customer Use:

Enter below the serial number that is located on the rear of the unit. Retain this information for future reference.

Model No. _____

Serial No. _____

WARNING: To prevent fire or shock hazard, do not expose this device to rain or moisture. Dangerous high voltage is present inside the enclosure. Do not open the cabinet.

CAUTION: To prevent electric shock, match wide blade of plug to wide slot of outlet and fully insert.

WARNING: Handling the cords on this product will expose you to lead, a chemical known to the State of California to cause cancer, and birth defects or other reproductive harm. **Wash hands after handling.**

Precautions

Protect your hearing: Hearing experts advise against the constant use of personal stereos played at high volume. Constant exposure to high volumes can lead to hearing loss. If you should experience ringing in the ears or hearing loss, discontinue use and seek medical advice.

Note: If the product suddenly has no response or powers off, an electrostatic discharge may be the cause. In this circumstance, please follow the procedures below for recovery:

- Use a paper clip to press the Reset button located on the rear of the unit.
- Turn the unit on again

Note:

SD is a trademark of the SD Card Association. SDHC Logo is a trademark of SD-3C, LLC.



For recycling or disposal information about this product, please contact your local authorities or the Electronics Industries Alliance: www.eiae.org.

Precautions

FCC Statement:

This device complies with Part 15 of the FCC Rules. Operation is subject to the following two conditions:

- (1) This device may not cause harmful interference, and
- (2) This device must accept any interference received, including interference that may cause undesired operation.

Note: This equipment has been tested and found to comply with the limits for Class B digital devices, pursuant to Part 15 of the FCC rules. These limits are designed to provide reasonable protection against harmful interference in a residential installation. This equipment generates, uses and can radiate radio frequency energy and, if not installed and used in accordance with the instructions, may cause harmful interference to radio communications. However, there is no guarantee that interference will not occur in a particular installation. If this equipment does cause harmful interference to radio or television reception, which can be determined by turning the equipment off and on, the user is encouraged to try to correct the interference by one or more of the following measures:

- Reorient or relocate the receiving antenna.
- Increase the separation between the equipment and receiver.
- Connect the equipment into an outlet on a circuit different from that to which the receiver is connected.
- Consult the dealer or an experienced radio/TV technician for help

Use of shielded cable is required to comply with Class B limits in Subpart B of Part 15 of the FCC rules.

Do not make any changes or modifications to the equipment unless otherwise specified in the manual. If such changes or modifications should be made, you could be required to stop operation of the equipment.

Important Safety Instructions

1. **Read Instructions:** All the safety and operating instructions should be read before the product is operated.
2. **Retain Instructions:** The safety and operating instructions should be retained for future reference.
3. **Heed Warnings:** All warnings on the product and in the operating instructions should be adhered to.
4. **Follow Instructions:** All operating and usage instructions should be followed.
5. **Cleaning:** Unplug this product from the wall outlet before cleaning. Do not use liquid cleaners or aerosol cleaners. Use a damp cloth for cleaning.
6. **Attachments:** Use only attachments recommended by the manufacturer. Use of other attachments may be hazardous.
7. **Water and Moisture:** Do not use this product near water (e.g., near a bath tub, washbowl, kitchen sink, laundry tub, in wet basements, or near a swimming pool and the like).

8. **Accessories:** Do not place this product on an unstable cart, stand, tripod, bracket, or table. Use only with carts, stands, tripods, brackets, or tables recommended by the manufacturer or sold with the product. Any mounting of the product should follow the manufacturer's instructions and should use a mounting accessory recommended by the manufacturer.



A product and cart combination should be moved with care. Quick stops, excessive force, and uneven surfaces may cause the product and cart combination to overturn.

9. **Ventilation:** Slots and openings in the cabinet are provided for ventilation to ensure reliable operation of the product and to protect it from overheating. These openings should never be blocked by placing the product on a bed, sofa, rug, or other similar surface. This product should not be placed in a built-in installation such as a bookcase or rack unless proper ventilation is provided or the manufacturer instructions have been adhered to.
10. **Power Sources:** This product should be operated only from the type of power source indicated on the rating label. If you are not sure of the type of power supply to your home, consult your product dealer or local power company. For products intended to operate from battery power or other sources, refer to the operating instructions.
11. **Grounding or Polarization:** This product may be equipped with a polarized alternating-current line plug that has one blade wider than the other.

Important Safety Instructions

This plug will only fit into the power outlet in one direction. This is a safety feature. If you are unable to insert the plug fully into the outlet, try reversing the direction of the plug. If the plug should still fail to fit, contact an electrician to replace the obsolete outlet. Do not defeat the safety purpose of the polarized plug.

12. **Power-Cord Protection:** Power supply cords should be routed so that they are not likely to be walked on or pinched by items placed upon or against them, paying particular attention to cords at plugs, convenience receptacles, and at the point which they exit from the product.
13. **Protective Attachment Plug:** The product may be equipped with an attachment plug with overload protection. This is a safety feature. See the operating instructions for replacement or directions to reset the protective device. If replacement of the plug is required, be sure the service technician has used a replacement plug that has the same overload protection as the original plug as specified by the manufacturer.
14. **Outdoor Antenna Grounding:** If an outside antenna is connected to the product, be sure the antenna system is grounded so as to provide some protection against voltage surges and built-up static charges. Article 810 of the National Electrical Code, ANS/NFPA 70 provides information with regard to proper grounding of the mast and supporting structure, grounding of the lead-in wire to an antenna-discharge unit, size of grounding conductors, location of antenna-discharge unit, connection to grounding electrodes, and requirements for the grounding electrode (see figure).

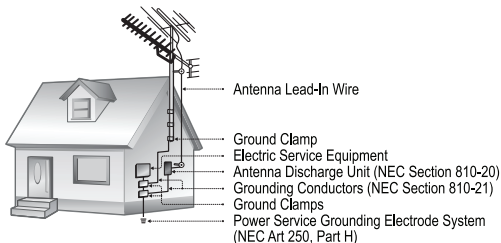

15. **Lightning:** For added protection for this product, unplug it from the wall outlet and disconnect the antenna or cable system during a lightning storm or when it is left unattended and unused for long periods of time. This will prevent damage to the product due to lightning or power-line surges.

Important Safety Instructions

16. **Power Lines:** An outside antenna system should not be located in the vicinity of overhead power lines or other electric light or power circuits, or where it can fall into such power lines or circuits. When installing an outside antenna system, extreme care should be taken to keep from pressing such power lines or circuits, as contact with them might be fatal.
17. **Overloading:** Do not overload wall outlets, extension cords, or integral convenience receptacles as this can result in a risk of fire or electric shock.
18. **Object and Liquid Entry:** Never push objects of any kind into this product through openings as they may press dangerous voltage points or shout-out parts that could result in a fire or electric shock. Never spill liquid of any kind on the product.
19. **Servicing:** Do not attempt to service this product yourself as opening or removing covers may expose you to dangerous voltage or other hazards. Refer all servicing to qualified service personnel.
20. **Damage Requiring Service:** Unplug this product from the wall outlet and refer servicing to qualified service personnel under the following conditions: a) when the power-supply or plug is damaged; b) if liquid has been spilled or if objects have fallen into the product; c) if the product has been exposed to rain or water; d) if the product does not operate normally by following the operating instructions. Adjust only those controls that are covered by the operating instructions as improper adjustment of other controls may result in damage and will often require extensive work by a qualified technician to restore the product to its normal operation; e) if the product has been dropped or damaged in any way; f) when the product exhibits a distinct change in performance—this indicates a need for service.
21. **Replacement Parts:** When replacement parts are required, be sure that your service technician has used replacement parts specified by the manufacturer or have the same characteristics as the original part. Unauthorized substitutions may result in fire, electric shock, or other hazards.
22. **Safety Check:** Upon completion of any service or repairs to this product, ask the service technician to perform safety checks to ensure that the product is in proper operating condition.
23. **Wall or Ceiling Mounting:** The product should be mounted to a wall or ceiling only as recommended by the manufacturer.
24. **Heat:** The product should be situated away from heat sources such as radiators, heat registers, stoves, or other products (including amplifiers) that produce heat.

Table of Contents

PRECAUTIONS	2
IMPORTANT SAFETY INSTRUCTIONS	5
TABLE OF CONTENTS	8
PACKAGE CONTENTS	10
FEATURES	11
GETTING STARTED	12
Controls at a Glance	12
Powering Your Photo Album.....	13
Charging Your Photo Album	13
Turning Your Photo Album On/Off	14
Resetting Your Photo Album.....	14
Installing a SD Memory Card (optional)	14
MAIN MENU	15
PHOTO MODE	16
Photo Browser Controls.....	16
Photo Viewer Controls	17
Photo Viewer Options.....	17
MUSIC MODE	18
Music Player Controls.....	19
Music Player Options	20
SETUP MODE	21
USB CONNECTIONS	24
Connecting to a Computer.....	24
Transferring Files.....	24
Microsoft Windows	25
Macintosh OS X.....	25
Disconnecting from a Computer	26

Table of Contents

FIRMWARE UPGRADES.....	28
TROUBLESHOOTING.....	29
SPECIFICATIONS	32

Package Contents

Please make sure that the items shown below are included in the package. Should an item be missing, please contact the local retailer from which you purchased this product.

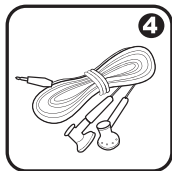
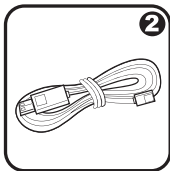





1. COBY Photo Album
2. USB Cable
3. Instruction Manual
4. Stereo Earphones
5. Carrying Case

Features

- ✦ 2.4" TFT LCD Display (320 x 240)
- ✦ Integrated 1GB Flash Memory
- ✦ Display JPEG and GIF Image files
- ✦ Plays MP3 and WMA Audio Files
- ✦ Photo Slideshow Mode
- ✦ Integrated SD/MMC Card Slot (SDHC compatible)
- ✦ USB 2.0 Hi-Speed for Fast File Transfers
- ✦ Integrated Rechargeable Battery
- ✦ Attractive Carrying Case

Getting Started

Controls at a Glance

1. MENU 
2. Left / Previous 
3. Right / Next 
4. Option 
5. Play / Pause 
6. Reset Button
7. LCD Screen
8. Neckstrap Hole
9. Earphone Jack
10. USB Port
11. SD/MMC Card Slot

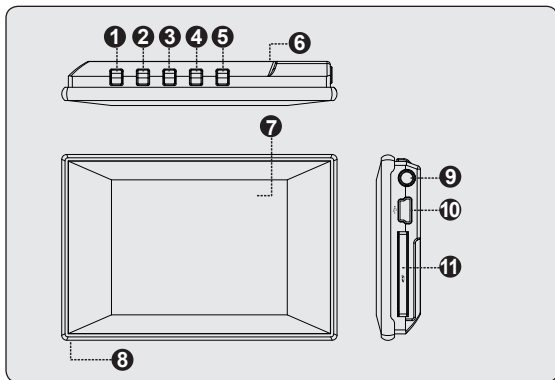

Getting Started

Powering Your Photo Album

Your photo album has an integrated rechargeable battery. Typical music playtime is up to 5 hours (when playing an MP3 encoded at 128 kbps and the battery is fully charged).



Upon initial use, the battery should be charged fully (8 hours) to ensure optimal performance and battery life.

Playing time is an estimated value. Actual play time may vary depending on encoding method used and other factors.

Charging Your Photo Album

Your photo album can be charged through a PC USB connection. Plug one end of the USB cable into the album's USB Port and plug the other end into the USB port of a powered-on computer.



When connected to a USB hub, the hub must be self-powered to charge the album's battery.



The battery used in this device may present a fire or chemical burn if mistreated. Do not disassemble, incinerate, or heat the battery.

Do not connect the album to a power source other than that which is indicated here or on the label as this may result in the risk of fire or electric shock.

Getting Started

Turning Your Photo Album On/Off

- ✦ To turn the album on, press and hold **POWER/ENTER** until you see the “COBY” screen.
- ✦ To turn the album off, press and hold **POWER/ENTER** until you see “Good Bye!”.

Resetting Your Photo Album

If the album should freeze or otherwise work improperly, use a paper clip to press the reset button located on the rear of the device.

Installing a SD Memory Card (optional)

You can upgrade the memory capacity of your album by adding an SD, SDHC, or MMC memory card.

- ✦ Insert the card into the slot with the metal contacts facing up (see the illustration below).
 - ✧ This album supports SD and MMC cards up to 2GB in size.
 - ✧ This album supports SDHC cards up to 32GB in size.

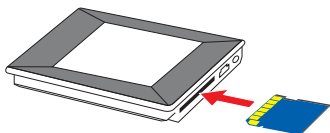

Main Menu

The Main Menu gives you access to the different function modes of your album. To access the Main Menu at any time, press and hold **MENU**.

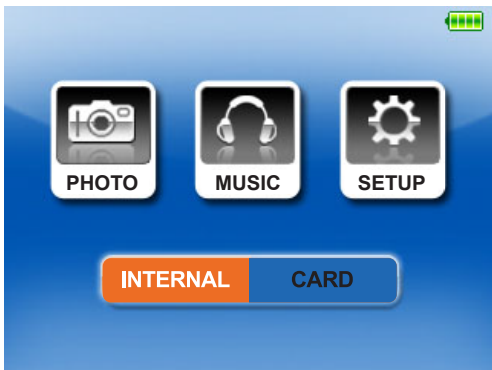

- ✦ If a memory card has been installed, press **MODE** to toggle between the unit's internal memory and the card.
- ✦ Press **<** or **>** to select a mode (Photo, Music, Setup) and then press **POWER/ENTER** to confirm.

Photo Mode

Enter PHOTO mode from the Main Menu to find and display JPG, GIF, and BMP photo files loaded on your album.

To enter Photo mode, select and confirm PHOTO from the Main Menu. The Photo Browser will appear on screen, and all available photos will display as thumbnail images.

Photo Browser Controls

Use the Photo Browser to navigate all folders and photo files loaded on your album.

✦ Press **<** to move the selection left; press **>** to move the selection right. Press **POWER/ENTER** to confirm the selection.

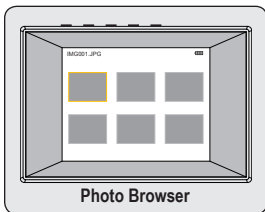

- ✧ Select a folder display its contents. Press **MENU** to exit the folder and return to the previous screen.
- ✧ Select "ALL PHOTOS" to launch the Photo Viewer to display all photos loaded on your album, regardless of the folder it is in.
- ✧ Select a photo to launch the Photo Viewer.
- ✦ Hold **MENU** to cancel and return to the Main Menu.

Photo Mode

Photo Viewer Controls

When you select a photo from the Photo Browser, the Photo Viewer will launch to display your photos.

- ✦ Press **<** or **>** to view the previous or next photo, respectively.
- ✦ Press **POWER/ENTER** to toggle slideshow mode on or off.
- ✦ Press and hold **MODE** to access the Photo Viewer options.
- ✦ Press **MENU** to return to the Photo Browser.

Photo Viewer Options

Press and hold **MODE** to access the Photo Viewer options.

- ✦ Press **<** or **>** to select an option and press **POWER/ENTER** to confirm.
- ✦ Press **MENU** to cancel and return to the previous screen.

Item	Description
Slide Mode	Set the slideshow mode on or off.
Slide Delay	Set the time interval between photos in slideshow mode.
Slide Effects	Set the slide transition effects.

Music Mode

Enter Music mode from the Main menu to play your MP3, WMA, or WAV music files.

To enter MUSIC mode, select and confirm MUSIC from the Main Menu. The Music Player will appear on screen.

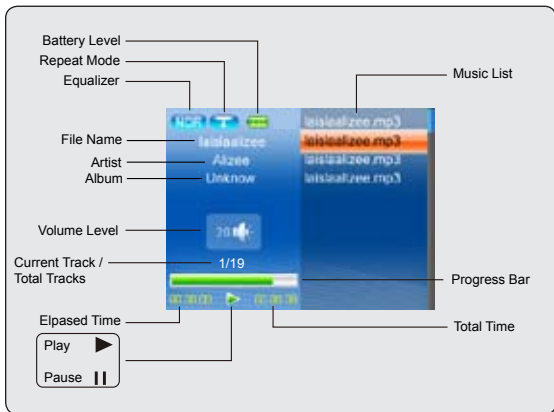

Music Mode

Music Player Controls

The Music Player allows you to view and play all compatible music files loaded on the unit.

Use the following controls during music playback.

Key	Function
Press POWER/ENTER	Start/Resume track playback. During playback, press POWER/ENTER to pause playback.
Press >	Play the next track (up).
Hold >	Fast-forward through the current track.
Press <	Play the previous track (down).
Hold <	Reverse through the current track.
Press MODE and then press >	Increase the volume level.
Press MODE and then press <	Decrease the volume level.
Hold MODE	Access the Music Player options.
Press MENU	Return to Main Menu.

Music Mode

Music Player Options

Press and hold **MODE** to access the Music Player options.

- ✦ Press **<** or **>** to select an option and press **POWER/ENTER** to confirm.
- ✦ Press **MENU** to cancel and return to the previous screen.

Item	Description
EQ	Set a digital equalizer preset (Normal, Classic, Jazz, Rock, Pop, Bass).
Repeat	Set the Repeat playback mode: Normal (Play all tracks once) Repeat One (Repeat the current track) Repeat All (Repeat all tracks) Random (Shuffle all tracks).

Setup Mode

Enter the Setup mode to set your album's system options.

To enter Setup mode, select and confirm SETUP in the Main menu.

- ✦ To select an option, press **<** or **>**. To confirm and enter, press **POWER/ENTER**.
- ✦ Press **MENU** to cancel and return to the previous screen.
- ✦ To exit the Setup Menu, press and hold **MENU**.

The Setup menu contains the following options: Photo, Music, Display, Language, Date & Time, and System.

Item		Description
Photo	Slide Delay	Set the time interval between photos in slide-show mode (in seconds).
	Slide Effect	Set the slide transition effects.
Music	Equalizer	Set a digital equalizer preset (Normal, Classic, Jazz, Rock, Pop, Bass).
	Repeat Mode	Set the Repeat playback mode: Normal (Play all tracks once) Repeat One (Repeat the current track) Repeat All (Repeat all tracks) Random (Shuffle all tracks).

Setup Mode

Item		Description
Display	Backlight	Adjust the duration of time (in seconds) that the backlight will remain on after a key press. A setting of "Always On" will keep the backlight on continuously.
	Brightness	Adjust the brightness of the display.
Language		Set the Language that the on-screen menus appear in (English, Spanish, German, Portuguese, French).
Date & Time	Date	Set the internal Date of the album. <ul style="list-style-type: none">• Press MODE to select a field to adjust (Month, Date, Year).• Press < or > to adjust the selected field.• Press POWER/ENTER when you are finished to save the settings.
	Time	Set the internal Time of the album. <ul style="list-style-type: none">• Press MODE to select a field to adjust (Hour, Minute, AM/PM).• Press < or > to adjust the selected field.• Press POWER/ENTER when you are finished to save the settings.

Setup Mode

Item		Description
System	Information	View the Memory and Firmware information of your album.
	Auto Play	Set the Auto Play feature on or off. When Auto Play is active, photos saved to internal memory will be displayed automatically when the album is turned on.
	Default	Restore all of the album's options to their factory-default state.

USB Connections

Connect the Coby photo album to a computer with a USB cable to:

- ✦ Transfer files to and from your album
- ✦ Perform basic file management functions.

Connecting to a Computer

Connect the album to your computer with a USB cable. Upon connection:

- ✦ Your computer will be detected as a “Removable Disk” when you open “My Computer”.
- ✦ It may take your computer several minutes to recognize and set up the device the first time it is connected depending on your hardware configuration.

Transferring Files

The USB 2.0 Hi-Speed connection makes it easy to transfer music, video, photo, and text files (or any other data) quickly between the album and your computer. Simply use the album as you would a floppy disk using basic operating system commands.

If you need further assistance with transferring files, please refer to your operating system’s instruction manual or on-screen help.

USB Connections



Do not disconnect or otherwise interrupt the device during transmission - this could damage or corrupt the album's firmware or your files. If the album is accidentally disconnected and is not working properly, reset your device (press the Reset button located on the rear of the album).

Microsoft Windows

1. Double-click the "My Computer" icon on your desktop and then double-click the album's icon (Removable Disk).



2. Locate the files you would like to transfer from your computer. Use your mouse to select the files to transfer and then drag-and-drop them onto the "Removable Disk" icon that represents your album.
 - ✧ You may also transfer files from your album to the computer.

Macintosh OS X

1. Open a finder window. Click on the Removable Disk icon located on the left side of the finder window. The computer will display all files and folders currently stored in the album.



USB Connections

2. Locate the files you would like to transfer from your computer. Use your mouse to select the files to transfer and then drag-and-drop them onto the Removable Disk icon that represents your album.

Disconnecting from a Computer

Disconnect your album as instructed below to detect data loss or file/firmware corruption.

Microsoft Windows

1. Double-click the green arrow in the taskbar located on the lower-right side of the computer screen (Safely Remove Hardware).



2. **Safely Remove Hardware:** Select "USB Mass Storage Device" from the list that appears and then click on "Stop".



Stop a Hardware

Device: Select "USB Mass Storage Device" from the list that appears and then click on "OK".

3. When the "Safe to Remove Hardware" window appears, click the OK button and disconnect the USB cable from the album and your computer.

USB Connections

Macintosh OS X

1. On the left side of the Finder Window, identify the appropriate Removable Disk icon.
2. Click on the “Eject” arrow on the right of the Removable Disk icon.
3. Disconnect the USB cable from the album and your computer.



Firmware Upgrades

From time to time, COBY may release firmware upgrades to improve the performance of the device or to add additional features. Please check the COBY website periodically at www.cobyusa.com to see if new firmware has been released for your device. If you are experiencing abnormal behavior with your device, you may choose to restore (format) your device before updating its firmware.



Do not interrupt the firmware upgrade process—doing so could damage your device and render it inoperable.

See the documentation that is included with the firmware upgrade file for detailed instructions.

Troubleshooting

If you have a problem with this device, please read the troubleshooting guide below and check our website at www.cobyusa.com for Frequently Asked Questions (FAQs) and firmware updates. If these resources do not resolve the problem, please contact Technical Support.

Address	COBY Electronics Technical Support 56-65 Rust Street Maspeth, NY 11378	
Email	techsupport@cobyusa.com	
Web	www.cobyusa.com	
Phone	800-727-3592:	Weekdays 8:00AM–11:00PM EST Weekends 9:00AM–5:30PM EST
	718-416-3197:	Weekdays 8:00AM–5:30PM EST

The player does not turn on.

- ✦ Ensure that the player is fully charged. Try charging the player overnight.
- ✦ Reset the player (use a paper clip to press the Reset button on the rear of the player) and try again.

The buttons do not work.

- ✦ Ensure that the player is fully charged. Try charging the player overnight.
- ✦ Reset the player (use a paper clip to press the Reset button on the rear of the player) and try again.

Troubleshooting

I cannot transfer files to the player.

- ✦ Ensure that your computer is running a supported operating system.
- ✦ If you are using a USB extension cable, ensure that it is securely attached to the player and the PC, or try using another USB cable.
- ✦ If you have connected the player through a USB hub, try connecting the player directly to your computer.
- ✦ Ensure that the player's memory capacity is not full.

There is no sound during playback.

- ✦ Check the volume level.
- ✦ Ensure that the headphones are attached securely to the player.

The sound quality of the music is poor.

- ✦ Try playing the file on your computer. If the sound quality is still poor, try downloading the file again or re-encoding the file yourself.
- ✦ Ensure that the bit rate of the file is not too low. The higher the bit rate of the file, the better it will sound. The minimum recommended bitrate is 128kbps for MP3s and 96kbps for WMAs.
- ✦ Try lowering the volume of the player.
- ✦ Ensure that the headphones are attached securely to the player.

Troubleshooting

The player will not play my music file.

- ✦ Ensure that the file is in a compatible format.
- ✦ The file may be copy-protected and you no longer have authorization to play this file. If you feel this is in error, please contact the service from which you downloaded the file.

The LCD characters are corrupted or something is wrong with the display.

- ✦ Ensure that the correct menu language has been set.
- ✦ Reset the player (use a paper clip to press the Reset button on the rear of the player) and try again.

The player has malfunctioned.

- ✦ Reset the player (use a paper clip to press the Reset button on the rear of the player) and try again.
- ✦ Try updating the player's firmware. Please refer to the [Firmware Upgrades](#) section of this manual for instructions.

Specifications

Display Type	2.4" Full-Color TFT @ 320x240
Memory	Integrated 1GB Flash SD or MMC memory cards (2GB max) SDHC memory cards (32GB max)
Audio Format Support	MP3, WMA, WAV
Photo Format Support	JPEG, GIF, BMP
PC Interface	USB 2.0
Plug and Play Support	Windows 2000/XP or newer Mac OS X
Audio Output	3.5mm Stereo (Headphone)
Power Supply	Rechargeable Lithium-Polymer Battery USB Charge
Unit Dimensions	3.27" x 2.2" x 0.5" (WHD)

Specifications and manual are subject to change without notice.

Coby Electronics Corporation

56-65 Rust Street
Maspeth, NY 11378

www.cobyusa.com

www.ecoby.com

Coby is a registered trademark of
Coby Electronics Corporation.

Printed in China.

Free Manuals Download Website

<http://myh66.com>

<http://usermanuals.us>

<http://www.somanuals.com>

<http://www.4manuals.cc>

<http://www.manual-lib.com>

<http://www.404manual.com>

<http://www.luxmanual.com>

<http://aubethermostatmanual.com>

Golf course search by state

<http://golfingnear.com>

Email search by domain

<http://emailbydomain.com>

Auto manuals search

<http://auto.somanuals.com>

TV manuals search

<http://tv.somanuals.com>