

INSTALLER: THESE INSTRUCTIONS MUST BE CONVEYED TO AND REMAIN WITH THE HOMEOWNER.

CERTIFIED UNDER CANADIAN AND AMERICAN NATIONAL STANDARDS, CSA 2.33, ANSI Z21.88 FOR VENTED GAS FIREPLACE HEATERS



GAS-FIRED DIRECT VENT INSERT

**INSTALLATION AND OPERATION INSTRUCTIONS FOR:
VENTED GAS FIREPLACE HEATER**

**NATURAL GAS MODELS CDIZC - N
PROPANE GAS MODELS CDIZC - P**

CERTIFIED FOR CANADA AND UNITED STATES USING ANSI / CSA METHODS

WARNING: If the information in these instructions is not followed exactly, a fire or explosion may result causing property damage, personal injury or death.

FOR YOUR SAFETY

Do not store or use gasoline or other flammable vapours and liquids in the vicinity of this or any other appliance.

WHAT TO DO IF YOU SMELL GAS:

- Do not try to light any appliance.
- Do not touch any electrical switch.
- Do not use any phone in your building.
- Immediately call your gas supplier from a neighbour's phone. Follow the gas supplier's instructions.
- If you cannot reach your gas supplier, call the fire department.

Installation and service must be performed by a qualified installer, service agency or the gas supplier.



Wolf Steel Ltd., 24 Napoleon Rd., Barrie, ON L4M 4Y8 Canada • (705)721-1212 • fax(705)722-6031
www.continentalfireplaces.com • ask@continentalfire.com

W415-0224/D/01.15.04

TABLE of CONTENTS

Pg 2-4	INTRODUCTION Warranty General Instructions General Information Care of Glass & Plated Parts	Pg 9	OPERATION / MAINTENANCE Operating Instructions Maintenance
5-7	INSTALLATION Insert Vent Connection Chimney Connection Wall Switch / Thermostat Gas Pipe Installation	10	REPLACEMENT BLOWER
7-8	FINISHING Trim Extrusion Installation Log Placement Door Installation Mantle Clearances Logo Placement	11	ADJUSTMENTS Pilot Burner Adjustment Vent Restrictions Venturi Adjustments
		12-13	REPLACEMENTS Ordering Replacement Parts Replacement Parts Terminal Kits Accessories
		14-15	TROUBLE SHOOTING GUIDE
		16	SERVICE HISTORY

PLEASE RETAIN THIS MANUAL FOR FUTURE REFERENCE

WARNING

- The fireplace insert is a vented gas-fired heater. Do not burn wood or other materials in this fireplace insert.
- Adults and especially children should be alerted to the hazards of high surface temperatures and should stay away to avoid burns or clothing ignition. Supervise young children when they are in the same room as the fireplace insert.
- Due to high temperatures, the fireplace insert should be located out of traffic and away from furniture and draperies.
- Clothing or other flammable material should not be placed on or near the fireplace insert.
- Any safety screen or guard removed for servicing must be replaced prior to operating the fireplace insert.
- It is imperative that the control compartments, burners and circulating blower and its passageway in the fireplace insert and venting system are kept clean. The fireplace insert and its venting system should be inspected before use and at least annually by a qualified service person. More frequent cleaning may be required due to excessive lint from carpeting, bedding material, etc. The fireplace insert area must be kept clear and free from combustible materials, gasoline and other flammable vapours and liquids.
- Under no circumstances should this fireplace insert be modified.
- This fireplace insert must not be connected to a chimney flue pipe serving a separate solid fuel burning appliance.
- Do not use this fireplace insert if any part has been under water. Immediately call a qualified service technician to inspect the fireplace insert and to replace any part of the control system and any gas control which has been under water.
- Do not operate the fireplace insert with the glass door opened, cracked or broken. Replacement of the glass should be done by a licensed or qualified service person.
- Do not strike or slam shut the fireplace insert glass door.
- This fireplace uses and requires a fast acting thermocouple. Replace only with a fast acting thermocouple supplied by Wolf Steel Ltd.

NOTE: changes, other than editorial, are denoted by a vertical line in the margin.

CONTINENTAL gas fireplaces are manufactured under the strict Standard of the world recognized ISO 9001 : 2000 Quality Assurance Certificate.

CONTINENTAL products are designed with superior components and materials, assembled by trained craftsmen who take great pride in their work. The burner and valve assembly are leak and test-fired at a quality test station. Once assembled the complete fireplace is thoroughly inspected by a qualified technician before packaging to ensure that you, the customer, receives the quality product that you expect from WOLF STEEL Ltd..

CONTINENTAL GAS FIREPLACE PRESIDENT'S LIFETIME LIMITED WARRANTY

The following materials and workmanship in your new CONTINENTAL gas fireplace are warranted against defects for as long as you own the fireplace. This covers: combustion chamber, heat exchanger, stainless steel burner, phazer™ logs and embers, ceramic glass (thermal breakage only), gold plated parts against tarnishing, porcelainized enamelled components and aluminium extrusion trims.

Electrical (110V and millivolt) components and wearable parts such as blowers, gas valves, thermal switch, switches, wiring, remote controls, igniter, gasketing, and pilot assembly are covered and WOLF STEEL LTD. will provide replacement parts free of charge during the first year of the limited warranty.

Any labour related to warranty repair is not covered.

CONDITIONS AND LIMITATIONS

WOLF STEEL LTD. warrants its products against manufacturing defects to the original purchaser only – i.e., the individual or legal entity (registered customer) whose name appears on the warranty registration card filed with WOLF STEEL Ltd. -- provided that the purchase was made through an authorized CONTINENTAL dealer and is subject to the following conditions and limitations:

This factory warranty is nontransferable and may not be extended whatsoever by any of our representatives.

The gas fireplace must be installed by a licenced, authorized service technician or contractor. Installation must be done in accordance with the installation instructions included with the product and all local and national building and fire codes.

This limited warranty does not cover damages caused by misuse, lack of maintenance, accident, alterations, abuse or neglect and parts installed from other manufacturers will nullify this warranty.

This limited warranty further does not cover any scratches, dents, corrosion or discolouring caused by excessive heat, abrasive and chemical cleaners nor chipping on porcelain enamel parts, mechanical breakage of PHAZER™ logs and embers, nor any venting components used in the installation of the fireplace.

WOLF STEEL Ltd. warrants its stainless steel burners against defects in workmanship and material for life, subject to the following conditions: During the first 10 years WOLF STEEL Ltd. will replace or repair the defective parts at our option free of charge. From 10 years to life, WOLF STEEL LTD. will provide replacement burners at 50% of the current retail price.

In the first year only, this warranty extends to the repair or replacement of warranted parts which are defective in material or workmanship provided that the product has been operated in accordance with the operation instructions and under normal conditions.

After the first year, with respect to this President's Limited Lifetime Warranty, WOLF STEEL LTD. may, at its discretion, fully discharge all obligations with respect to this warranty by refunding to the original warranted purchaser the wholesale price of any warranted but defective part(s).

WOLF STEEL Ltd. will not be responsible for installation, labour, or any other costs or expenses related to the reinstallation of a warranted part, and such expenses are not covered by this warranty.

Notwithstanding any provisions contained in this President's Limited Lifetime Warranty, WOLF STEEL'S responsibility under this warranty is defined as above and it shall not in any event extend to any incidental, consequential or indirect damages.

This warranty defines the obligations and liability of WOLF STEEL Ltd. with respect to the CONTINENTAL gas fireplace and any other warranties expressed or implied with respect to this product, its components or accessories are excluded.

WOLF STEEL Ltd. neither assumes, nor authorizes any third party to assume, on its behalf, any other liabilities with respect to the sale of this product. WOLF STEEL Ltd. will not be responsible for: over-firing, downdrafts, spillage caused by environmental conditions such as rooftops, buildings, nearby trees, hills, mountains, inadequate vents or ventilation, excessive venting configurations, insufficient makeup air, or negative air pressures which may or may not be caused by mechanical systems such as exhaust fans, furnaces, clothes dryers, etc.

Any damages to fireplace, combustion chamber, heat exchanger, brass trim or other component due to water, weather damage, long periods of dampness, condensation, damaging chemicals or cleaners will not be the responsibility of WOLF STEEL Ltd.

The bill of sale or copy will be required together with a serial number and a model number when making any warranty claims from your authorized dealer. The warranty registration card must be returned within fourteen days to register the warranty.

WOLF STEEL Ltd. reserves the right to have its representative inspect any product or part thereof prior to honouring any warranty claim.

ALL SPECIFICATIONS AND DESIGNS ARE SUBJECT TO CHANGE WITHOUT PRIOR NOTICE DUE TO ON-GOING PRODUCT IMPROVEMENTS. CONTINENTAL® IS A REGISTERED TRADEMARK OF WOLF STEEL LTD. PATENTS U.S. 5.303.693.801 - CAN. 2.073.411, 2.082.915. © WOLF STEEL LTD.

GENERAL INSTRUCTIONS

THIS GAS FIREPLACE INSERT SHOULD BE INSTALLED AND SERVICED BY A QUALIFIED INSTALLER to conform with local codes. Installation practices vary from region to region and it is important to know the specifics that apply to your area,

for example: in Massachusetts State:

- The fireplace damper must be removed or welded in the open position prior to installation of a fireplace insert or gas log.
- The appliance off valve must be a "T" handle gas cock.
- The flexible connector must not be longer than 36 inches.
- The appliance is not approved for installation in a bedroom or bathroom unless the unit is a direct vent sealed combustion product.
- **WARNING:** This product must be installed by a licensed plumber or gas fitter when installed within the commonwealth of Massachusetts.

In absence of local codes, install to the current CAN1-B149 Installation Code in Canada or to the National Fuel Gas Code, ANSI Z223.1, and NFPA 54 in the United States. Mobile home installation must conform with local codes. In the absence of local codes, install to the current standard for gas equipped mobile housing CAN/CSA Z240 MH Series in Canada or the manufactured home construction and safety standard, Title 24 CFR, part 3280, or the Fire Safety Criteria for manufactured home installations, Sites and Community Standard ANSI/NFPA 501A in the United States.

Purge all gas lines with the glass door of the fireplace insert opened. Assure that a continuous gas flow is at the burner before closing the door.

Under extreme vent configurations, allow several minutes (5-15) for the flame to stabilize after ignition.

The fireplace insert and its individual shutoff valve must be disconnected from the gas supply piping system during any pressure testing of that system at test pressures in excess of 1/2 psig (3.5 kPa). The fireplace insert must be isolated from the gas supply piping system by closing its individual manual shutoff valve during any pressure testing of the gas supply piping system at test pressures equal to or less than 1/2 psig (3.5 kPa).

A 1/8 inch NPT plug, accessible for test gauge connection, must be installed immediately upstream of the gas supply connection to the fireplace insert.

The fireplace insert must be electrically connected and grounded in accordance with local codes. In the absence of local codes, use the current CSA C22.1 CANADIAN ELECTRICAL CODE in Canada or the ANSI/NFPA 70-1990 NATIONAL ELECTRICAL CODE in the United States. The blower power cord must be connected into a properly grounded receptacle. The grounding prong must not be removed from the cord plug.

GENERAL INFORMATION

FOR YOUR SATISFACTION, THIS FIREPLACE INSERT HAS BEEN TEST-FIRED TO ASSURE ITS OPERATION AND QUALITY!

Minimum inlet gas supply pressure is 4.5 inches water column for natural gas and 11 inches water column for propane. Maximum inlet gas pressure is 7 inches water column for natural gas and 13 inches water column for propane. Manifold pressure under flow conditions is 3.5 inches water column for natural gas and 10 inches water column for propane. When the fireplace is installed at elevations above 4,500ft, and in the absence of specific recommendations from the local authority having jurisdiction, the certified high altitude input rating shall be reduced at the rate of 4% for each additional 1,000ft.

Expansion / contraction noises during heating up and cooling down cycles are normal and to be expected.

Maximum input is 24,000 BTU/hr for natural gas and propane. Maximum output for natural gas and propane is 20,400 BTU/hr at an efficiency of 85% with the fan on. Maximum A.F.U.E. (annual fuel utilization efficiency) rating is 79 % for natural gas and propane. This fireplace insert is not approved for closet or recessed installations. It is approved for bathroom, bedroom and bed-sitting room installations and is suitable for mobile homes. The natural gas model is suitable for installation in a mobile home that is permanently positioned on its site and fuelled with natural gas.

This insert must be recessed into a vented noncombustible wood-burning fireplace (prefabricated or masonry) only. The minimum fireplace opening size in which the heater is to be installed is:

HEIGHT	14½	inches
WIDTH	25	inches
DEPTH	11	inches

The minimum allowable chimney flue size is 6" round.

The minimum distance, from the bottom of a combustible mantle projecting 3" maximum from the wall to the top of the aluminium trim, is 3".

CARE OF GLASS, AND PLATED PARTS

Do not use abrasive cleaners to clean these parts. Buff lightly with a clean dry cloth.

The glass is 3/16" ceramic glass available from your Continental / Wolf Steel Ltd. dealer. **DO NOT SUBSTITUTE MATERIALS.** Clean the glass after the first 10 hours of operation with a recommended gas fireplace glass cleaner. Thereafter clean as required. **DO NOT CLEAN GLASS WHEN HOT!** If the glass is not kept clean permanent discolouration and / or blemishes may result.

INSTALLATION

Provide adequate ventilation air.

Provide adequate accessibility clearance for servicing and operating the fireplace insert.

Never obstruct the front opening of the fireplace insert.

Objects placed in front of the fireplace must be kept a minimum of 48" away from the front face of the unit.

Clean out ashes from the inside of the wood-burning fireplace. Make sure that the chimney and wood-burning fireplace are in a clean and sound condition and constructed of non-combustible materials. If necessary have any repair work done by a qualified person before installing the insert. Remove the existing fireplace damper or lock into an open position.

Using screws, attach the fireplace warning tag (W385-0199) to the inside of the firebox of the fireplace into which the insert is being installed.

FIGURES 1a-c

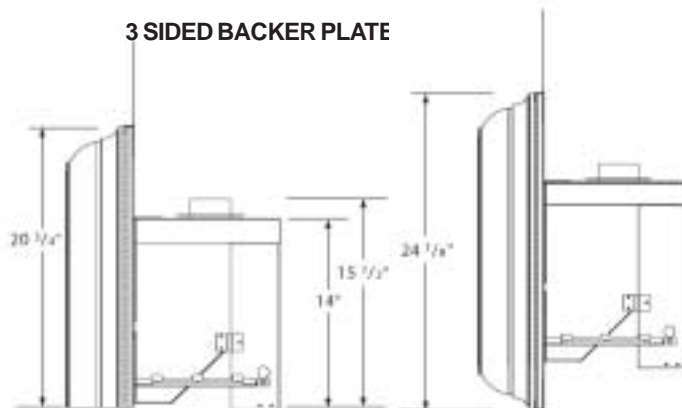
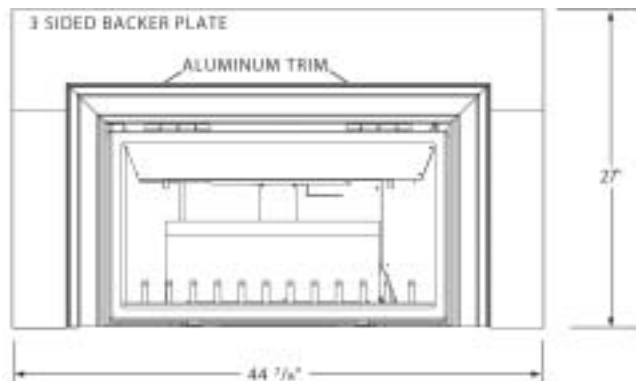

3 & 4 SIDED BACKER PLATES - SIDE VIEWS

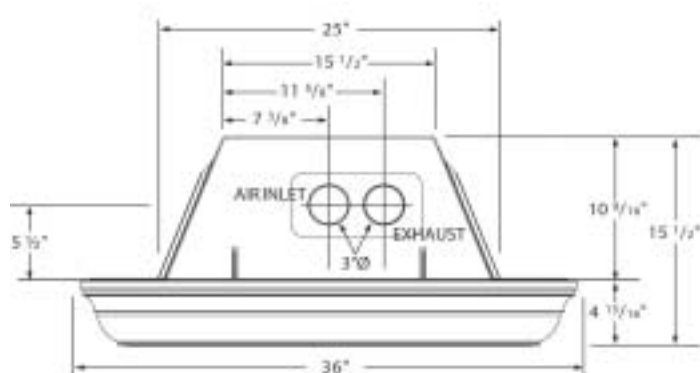

TOP VIEW

WARNING: THIS FIREPLACE HAS BEEN CONVERTED FOR USE WITH A GAS FIREPLACE INSERT ONLY AND CANNOT BE USED FOR BURNING WOOD OR SOLID FUELS UNLESS ALL ORIGINAL PARTS HAVE BEEN REPLACED AND THE FIREPLACE IS RE-APPROVED BY THE AUTHORITY HAVING JURISDICTION.

ATTENTION: CE FOYER A ETE CONVERTI AFIN D'ETRE UTILISE SEULEMENT COMME FOYER ENCASTRE AU GAZ ET NE PEUT ETRE UTILISE POUR BRULER DU BOIS OU TOUT AUTRE COMBUSTIBLE SOLIDE, SANS QUE TOUTES LES PIECES ORIGINALES AIENT ETE REMPLACEES ET QUE LE FOYER SOIT APPROUVE DE NOUVEAU PAR LES AUTORITES AYANT JURISDICTION.

W385-0199

The sheet-metal parts of the fireplace, in which the gas fireplace insert is to be installed, must not be cut.

If the wood-burning factory-built fireplace has no gas access hole(s) provided, an access hole of 1½ inch or less may be drilled through the lower sides or bottom of the fireplace in a proper workman like manner. This access hole must be plugged with non-combustible insulation after the gas supply line has been installed.

Ensure that existing chimney cleanouts fit properly.

The refractory, glass doors, screen rails, screen mesh and log grates may be removed from the fireplace before installing the gas fireplace insert.

Smoke shelves, shields and baffles may be removed if attached by mechanical fasteners.

The ventilation openings in the fireplace may be obstructed by the backer plates, aluminium trim etc. but these parts are not to be applied so as to have an airtight seal.

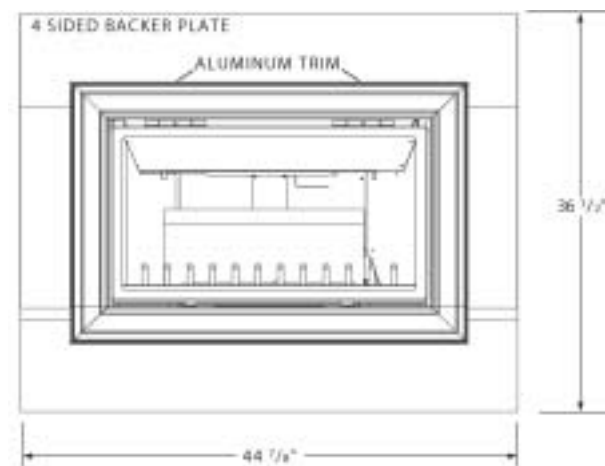

4 SIDED BACKER PLATE - FRONT VIEW

INSERT VENT CONNECTION

Move the insert close to its final position inside the wood-burning fireplace. This unit is equipped with 6 levelling screws located as follows: two are on either side of the circulation blower on the rear panel; four are located front and back on either side beneath the log support. Level using four of the levelling screws. See Figure 1a. Levelling the unit will eliminate rocking or excessive noise when the fan is in operation. Once the unit is level, move it partially into place within the fireplace to allow for all connections to be made. *It is not practical to level the insert once it has been installed. Determine the required depth prior to installing the unit and adjust the four levelling screws accordingly.*

CHIMNEY CONNECTION

Chimney installation must conform to both national and local code requirements. The chimney must be lined with one 2" or 3" diameter liner for intake and one 3" diameter liner for exhaust. The minimum and maximum vent lengths are 10 and 35 feet respectively. Recommended Continental kits come in 3 lengths: While the liners must be continuous from the fireplace to the terminal, to achieve the needed length, they may be coupled, using an aluminium coupler, provided installation is sealed & secured.

1-2" & 1-3" DOUBLE PLY ALUMINUM LINER-INLET AND EXHAUST & 2-3" TO 2" REDUCER:

GDI-2320KT	VENT KIT 20FT
GDI-2325KT	VENT KIT 25FT
GDI-2335KT	VENT KIT 35FT

2-3" DOUBLE PLY ALUMINUM LINER-INLET AND EXHAUST:

GDI-320KT	VENT KIT 20FT
GDI-325KT	VENT KIT 25 FT
GDI-335KT	VENT KIT 35 FT

We recommend that exhaust vents that pass through unheated spaces, such as a garage or attic, be wrapped in a protective sleeve to minimize condensation and reverse flow symptoms. See Trouble Shooting for details.

This unit is approved for use with a 2" liner for air intake and a 3" liner for exhaust. For best performance, however, it is recommended to use two 3" liners.

If a 2" liner is used for the intake, it is necessary to adjust the primary air shutter. See "Air Shutter Settings" on page 11.

1. **OUTSIDE:** Slip one end of a liner a minimum of 2" over one of the collars of the terminal. Secure using 3 screws. Then seal the joint and screw heads with high temperature sealant. Repeat with the other liner.

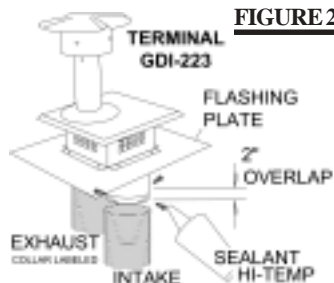

FIGURE 2

NOTE: We recommend that the other end of the exhaust liner be marked to eliminate the exhaust liner being connected to the intake collar at the unit.

2. Gently stretch the liners to the required lengths and insert into the chimney. Place the terminal onto the top of the chimney cap and fit the flashing plate to suit. Make weather tight by sealing with caulking (not supplied) and fasten to the chimney with screws and plugs (not supplied)

3. **INSIDE:** Attach and secure the flex liners to the vent connection assembly using the same procedure as before, **ensuring that the marked exhaust liner is attached to the exhaust collar.**

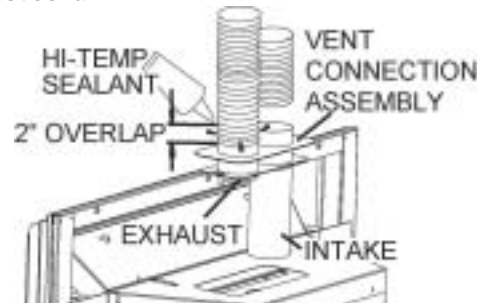

FIGURE 3

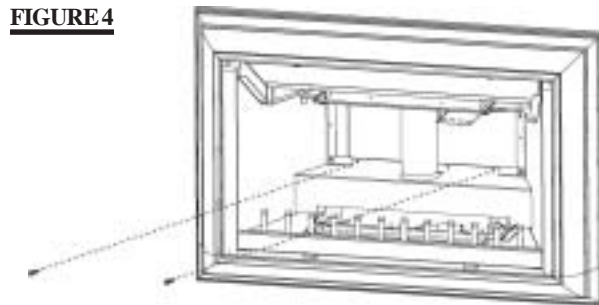

FIGURE 4

4. Detach the two screws from the back of the firebox and remove the panel, as illustrated.

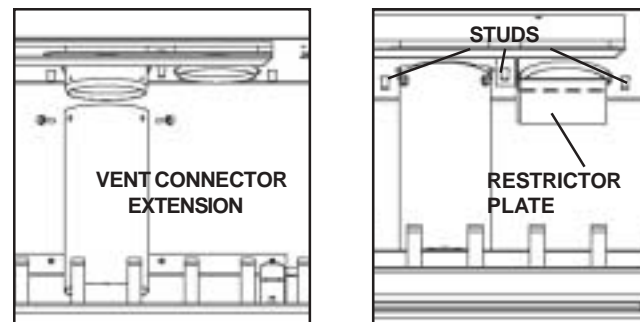

FIGURE 5a-b

5. Reaching in through the insert, manoeuvre the vent connection assembly through the openings in the firebox top, taking care not to damage the gasket. In case of a low ceiling fireplace, the extension should be removed and reinstalled after the vent connection is secured to the firebox. Attach the restrictor plate to the centre stud and secure the assembly using the three studs and 1/4-20 hex nuts.

WALL SWITCH / THERMOSTAT

For ease of accessibility, an optional remote wall switch or millivolt thermostat may be installed in a convenient location. Route 2-strand solid core millivolt wire from the gas fireplace insert to the wall switch / millivolt thermostat. The recommended maximum lead length depends on the wire size:

WIRE SIZE	MAX. LENGTH
14gauge	100 feet
16gauge	60 feet
18gauge	40 feet

Do not connect either the wall switch, thermostat or gas valve to electricity (110 VOLTS).

GAS INSTALLATION

Install suitable supply piping connection to the $\frac{3}{8}$ " flex connector supplied (as per local gas codes).

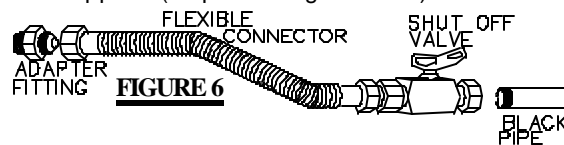

The insert may now be pushed into its final position inside the wood-burning fireplace. Secure the insert to the fireplace using perforated strapping attached to the two securing holes on either side of the unit as shown. We recommend that the trim be installed before the unit is placed into its final position.

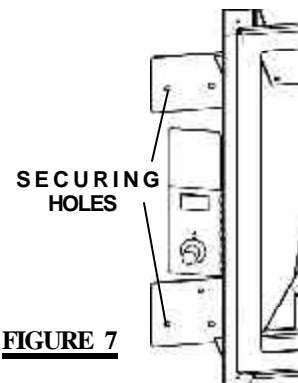

FINISHING

In order to close off the fireplace opening or if the opening is larger than the 3- or 4-sided aluminium extrusion trim kits, it is recommended to reduce the opening using a non-combustible material such as ceramic tile, marble, etc or the GIZBP6-3 or GIZBP6-4 backer plate kits. The outside edge of the backer plate is finished off with gold trim included in each kit. A deluxe flashing kit complete with marquis trim may also be used to complete the installation. These flashing and trim combinations are available in 6 and 9 inch widths as well as many finishes to accent any room decor. Mounting brackets, GIZBRKT, are required to install the deluxe flashing. Detailed installation instructions are included with each kit.

If this unit is being installed into an existing wood burning, zero clearance fireplace, then be aware of this precaution: **Any circulation air opening may be covered (with non-combustible material) but not sealed!**

ALUMINIUM EXTRUSION TRIM KIT INSTALLATION

The insert can be equipped with either a 3- or 4-sided trim kit to finish off the fireplace opening. Slide the trim assembly over the keyholes (2 per side) and drop into place. If installing the optional 3- or 4-sided backer plate (GIZBP6-3 or GIZBP6-4), it must be hung prior to the trim kit installation using the same keyholes.

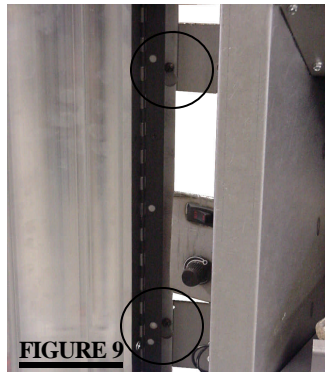

To adjust the trim: If the mitre is out of alignment, open each side and loosen the two screws at either side trim hinge. Slide the trim up or down to adjust and re-tighten screws. There is also a very slight in/out adjustment that can be made.

Note: Since the side panels open and close, to access the controls, a gap is necessary at the mitre joint.

The top trim piece has an adjustable securing bracket which enables the trim to be secured to the firebox shell.

LOG PLACEMENT

Positioning the logs improperly will cause flame impingement and carboning.

PHAZER™ logs and glowing embers, exclusive to Continental Fireplaces, glow when exposed to direct flame and provide a unique and realistic glowing effect that is different in every installation. Take the time to carefully position the glowing embers for a maximum glowing effect. Use only certified **PHAZER™** logs available from your Continental / Wolf Steel Ltd. dealer.

1. Place the rear log (#1) onto the two log supports and against the air intake pipe.

FIGURE 12



2. Position logs #2 and #3 against the grate posts and line up the studs located on the burner with the holes on the bottom of the logs. *Keep slightly back of the front row of ports.*

FIGURE 13



3. Fit the centre log (#4) into place behind log #3 and into the pocket provided on the back log.

FIGURE 14



FIGURE 15

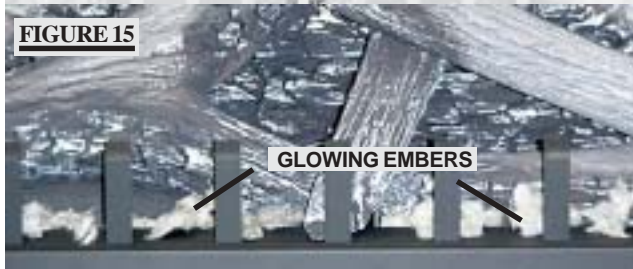

4. Tear the glowing embers into pieces and place along the front row of ports covering all of the burner area in front of the logs. Care should be taken to shred the embers into thin, small irregular pieces as only the exposed edges of the fibre hairs will glow. *The ember material will only glow when exposed to direct flame; however, care should be taken to not block the burner ports.* Blocked burner ports can cause an incorrect flame pattern, carbon deposits and delayed ignition.

Log colours may vary. During the initial use of the fireplace, the colours will become more uniform as colour pigments burn in during the heat activated curing process.

W415-0224/D/01.15.04

DOOR INSTALLATION

Place the door into the two lower door brackets, and secure at the top of the unit with two #10-24 machine screws.

FIGURE 16

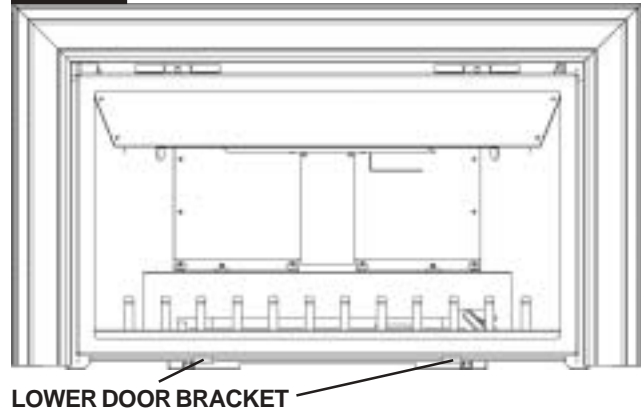

MANTLE CLEARANCE

This can vary according to the mantle depth. Use the graph to help evaluate the clearance needed.

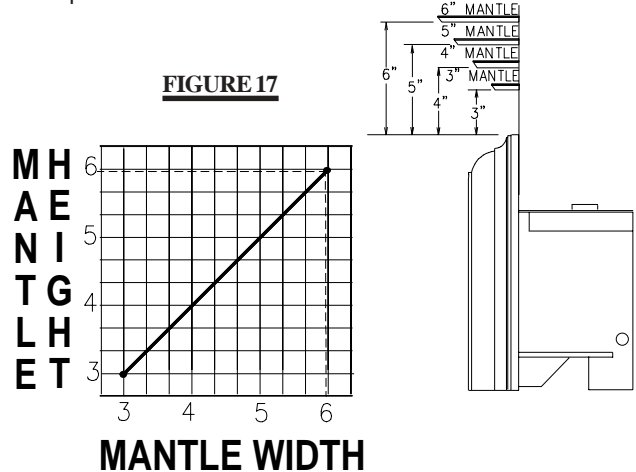

LOGO PLACEMENT

Remove the backing of the logo supplied and place on the glass viewing door, as indicated.

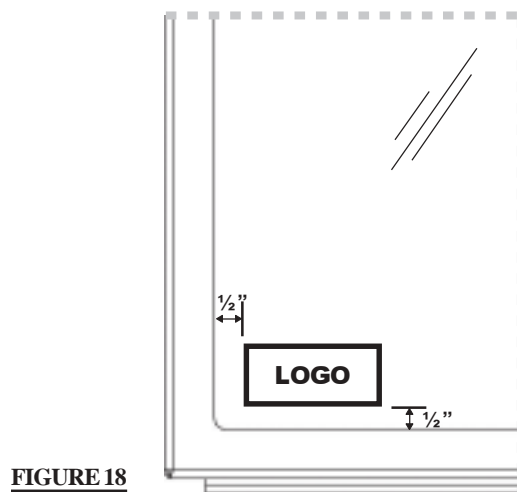

OPERATION / MAINTENANCE

OPERATING INSTRUCTIONS

The on-off switch is located behind the left side control door.

Purge all gas lines with the glass door open. Assure that a continuous gas flow is at the burner before closing the door. Allow several minutes (5-15) for the flame to stabilize after ignition.

Do not operate the main burner of the insert with the door removed.

When lit for the first time, the fireplace will emit a slight odour for a few hours. This is a normal temporary condition caused by the "burn-in" of paints and lubricants used in the manufacturing process and will not occur again. Simply open a window to sufficiently ventilate the room. After extended periods of non-operation such as following a vacation or a warm weather season, the fireplace may emit a slight odour for a few hours. This is caused by dust particles in the heat exchanger burning off. Open a window to sufficiently ventilate the room.

PURGE THE GAS LINE WITH THE GLASS DOOR OPEN.

FOR YOUR SAFETY READ BEFORE LIGHTING:

- This fireplace is equipped with a pilot which must be lit by hand. While following these instructions exactly.
- Before operating smell all around the fireplace area for gas and next to the floor because some gas is heavier than air and will settle on the floor.
- Use only your hand to turn the gas control knob. Never use tools. If the knob will not turn by hand, do not try to repair it. Call a qualified service technician. Force or attempted repair may result in a fire or explosion.
- Do not use this fireplace if any part has been under water. Immediately call a qualified service technician to inspect the fireplace and replace any part of the control system and any gas control which has been under water.

WHAT TO DO IF YOU SMELL GAS:

- Turn off all gas to the fireplace.
- Open windows.
- Do not try to light any appliance.
- Do not touch any electric switch; do not use any phone in your building.
- Immediately call your gas supplier from a neighbour's phone. Follow the gas supplier's instructions.
- If you cannot reach your gas supplier, call the fire department.

FIGURE 19

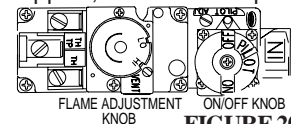
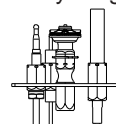





FIGURE 20

LIGHTING INSTRUCTIONS

When lighting and re-lighting, the gas knob cannot be turned from pilot to off unless the knob is **depressed slightly**.

- Stop!** Read the above safety information on this label.
- Turn off all electric power to the fireplace.
- Turn the gas knob clockwise  to off.
- Wait five (5) minutes to clear out any gas. If you smell gas including near the floor. Stop! Follow "B" in the above safety information on this label. If you don't smell gas go the next step.
- If fireplace is equipped with flame adjustment valve turn clockwise to off.
- Find pilot located in front of back log.

- Turn gas knob counter-clockwise  to pilot.
- Depress slightly and hold gas knob while lighting the pilot with the push button ignitor. Keep knob depressed for one minute, then release. If pilot does not continue to burn, repeat steps 3 through 7.
- With pilot lit, depress and turn gas knob counter-clockwise  to on.
- If equipped with flame adjustment valve, push and turn knob to high.
- If equipped with remote on-off switch/thermostat, main burner may not come on when you turn valve to on. Remote switch must be in the on position to ignite burner.
- Turn on all electric power to the fireplace.

TO TURN OFF GAS

- Turn off all electrical power to the unit if service is to be performed.

- Push in gas control knob slightly and turn clockwise  to off. **Do not force.**

MAINTENANCE

TURN OFF THE GAS AND UNPLUG ELECTRICAL POWER BEFORE SERVICING THE FIREPLACE INSERT!

CAUTION: Label all wires prior to disconnection when servicing controls. Wiring errors can cause improper and dangerous operation. Verify proper operation after servicing. This insert and its venting system should be inspected before use and at least annually by a qualified service person. The fireplace area must be kept clear and free of combustible materials, gasoline or other flammable vapours and liquids. The flow of combustion and ventilation air must not be obstructed.

- In order to properly clean the burner and pilot assembly, remove the logs exposing both assemblies.

- Keep the control compartment, logs, burner, air shutter opening and the area surrounding the logs clean by vacuuming or brushing, at least once a year.
- Check to see that all burner ports are burning. Clean out any of the ports which may not be burning or are not burning properly.
- Check to see that the pilot flame is large enough to engulf the thermocouple on one leg and reaches toward the burner on the other leg.
- Replace the cleaned logs.
- Check to see that the main burner ignites completely on all openings when the gas knob for the burner is turned on. A 5-10 second total light-up period is satisfactory. If ignition takes longer, consult your Continental dealer/distributor.
- Check that the door gasketing is not broken or missing. Replace if necessary.

W415-0224/D/01.15.04

REPLACEMENT BLOWER INSTALLATION

The Napoleon gas fireplace insert comes standard with a blower, a heat sensor, variable on/off speed control and a power cord. Because the blower is thermally activated, when turned on, it will automatically start approximately 15 minutes after lighting the fireplace and will run for approximately 30 minutes after the fireplace has been turned off. Use of the fan increases the output of heat. Air, drawn in through the lower slot, is driven up the back of the firebox, and exhausted as hot air through the upper slot.

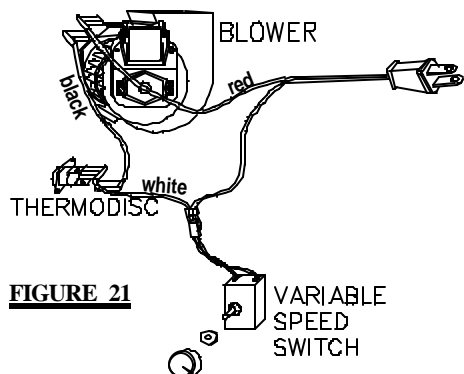
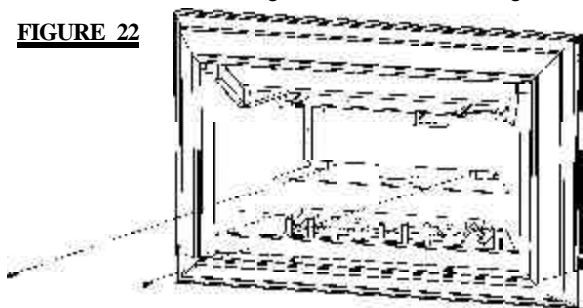

FIGURE 21

1. Turn off the electrical power and the gas supply to the fireplace insert.
2. Remove the fire viewing door. Remove the logs.

FIGURE 22



3. Detach the two screws from the back of the firebox and remove the panel, as illustrated.

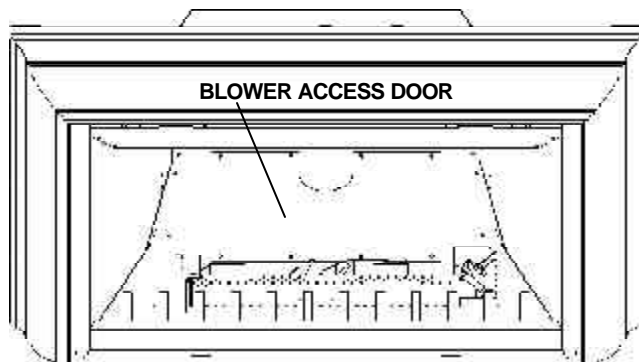

FIGURE 23

4. Remove the blower access door held on with the remaining 8 screws. Replace the blower access door gasket when changing the blower.

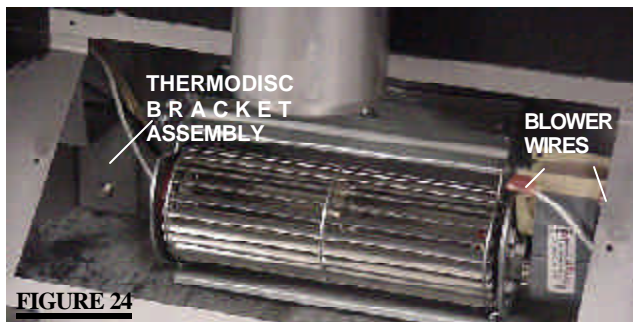

FIGURE 24

4. Disconnect the two blower wires. Remove the blower bracket secured with one wing nut and lock washer. For thermodisc replacement: Remove the "Z" shaped mounting bracket secured to the firebox wall to the left of the blower. Remove the thermodisc from the bracket and replace.

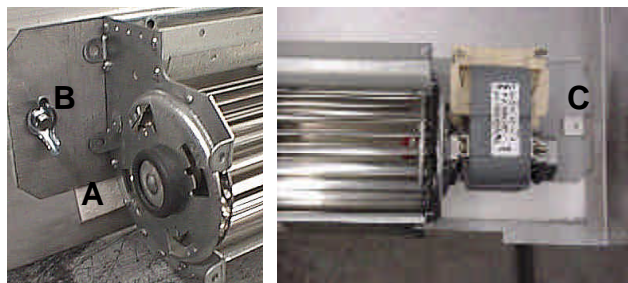

FIGURE 25

FIGURE 26

5. Replace the blower using the existing bracket. Slide the vibration reducing pad (A) into the clip (C) and up against the threaded stud (B) at the other end. The blower must be able to be positioned entirely onto the pad.

Slide the blower into the clip (C). Secure to the threaded stud using the existing lock washer and wing nut. Ensure that the blower does not touch the fireplace base or the firebox.

6. Reconnect the two wires. Holding the replacement gasket in place, reattach the blower access door and panel. Replace the logs. Re-install the fire viewing door.
7. Turn the gas supply and electricity back on.

Drywall dust will penetrate into the blower bearings causing irreparable damage and must be prevented from coming into contact with the blower or its compartment. Any damage resulting from this condition is not covered by the warranty policy.

ADJUSTMENTS

PILOT BURNER ADJUSTMENT

Remove the pilot screw cap. Adjust the pilot screw to provide properly sized flame. Turn in a clockwise direction to reduce the gas flow. Replace the pilot screw cap.

FIGURE 27

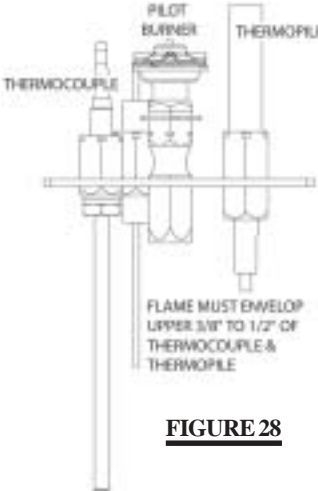
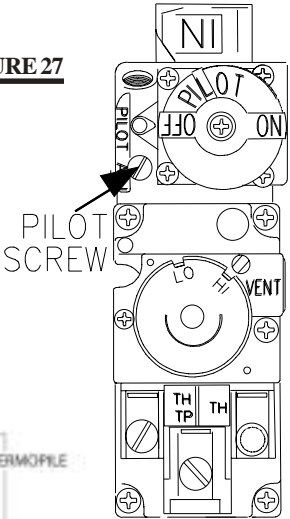

FIGURE 28

VENT RESTRICTION

Some vent configurations may display a very active flame. If this appearance is not desirable, the vent exit may be restricted using the restrictor plate shown in **FIGURE 6b**. Bend the flap up as shown to reduce the velocity of the exhaust gases, slowing down the flame pattern and creating a more traditional appearance.

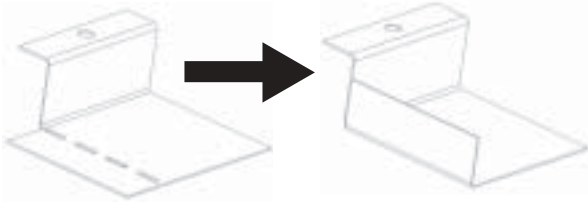

FIGURE 29

VENTURI ADJUSTMENT

This unit is approved for use with a 2" liner for air intake and a 3" liner for exhaust. For best performance, however, it is recommended to use two 3" liners.

Air shutter settings will differ depending on the liner system used. Use the charts below to determine the correct air shutter setting:

3"/3" LINER SYSTEM	
NG	1/16"
LP	3/16"
AIR SHUTTER SETTING	

2"/3" LINER SYSTEM	
NG	1/8"
LP	5/16"
AIR SHUTTER SETTING	

Closing the air shutter will cause a more yellow flame, but can lead to carboning. Opening the air shutter will cause a more blue flame, but can cause flame lifting from the burner ports. The flame may not appear yellow immediately; allow 15 to 30 minutes for the final flame colour to be established.

Air shutter adjustment must only be done by a qualified gas installer!

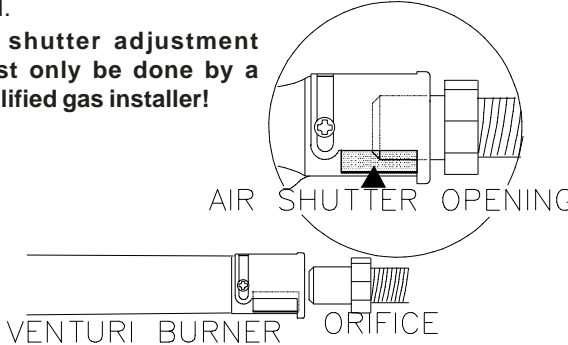
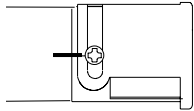

FIGURE 30

HELPFUL HINT:

A mirror will let you see the opening of the air shutter without removing the burner. Scribe a line along the venturi tube and air shutter cap. Open or close according to the original opening by using the scribed line as your datum.



REPLACEMENTS

Contact your dealer for questions concerning prices and availability of replacement parts. Normally all parts can be ordered through your Continental dealer or distributor.

* IDENTIFIES ITEMS WHICH ARE NOT ILLUSTRATED. FOR FURTHER INFORMATION, CONTACT YOUR CONTINENTAL DEALER.

When ordering replacement parts always give the following information:

1. MODEL & SERIAL NUMBER OF FIREPLACE
2. INSTALLATION DATE OF FIREPLACE
3. PART NUMBER
4. DESCRIPTION OF PART
5. FINISH

FOR WARRANTY REPLACEMENT PARTS, A PHOTOCOPY OF THE ORIGINAL INVOICE WILL BE REQUIRED TO HONOUR THE CLAIM.

REPLACEMENT PARTS

1	W725-0039	RBT SHAW VALVE - NG
1	W725-0040	RBT SHAW VALVE - LP
2	W100-0068	BURNER
3	W455-0017	#42 BURNER ORIFICE - NG
3	W455-0059	#53 BURNER ORIFICE - LP
4	W010-0800	PILOT ASSEMBLY - LP
4	W010-0801	PILOT ASSEMBLY - NG
5	W455-0069	PILOT INJECTOR - NG
5	W455-0067	PILOT INJECTOR - LP
6	W680-0005	THERMOCOUPLE
7	W680-0004	THERMOPILE
8*	W573-0008	HIGH TEMPERATURE SEALANT
9*	W357-0001	PIEZO IGNITOR
10	GL-631	LOG SET
11	W135-0136	REAR LOG
12	W135-0138	RIGHT LOG
13	W135-0137	LEFT LOG
14	W135-0139	CENTER LOG
15*	W361-0016	GLOWING EMBERS
16	GZ552	BLOWER
17*	W385-0131	CONTINENTAL LOGO
18*	W010-0804	DOOR GLASS c/w GASKET
19*	W225-0095	DOOR FRAME
20	W010-0802	DOOR c/w GLASS
21*	W290-0063	BLOWER ACCESS GASKET
22*	W430-0013	MAGNETIC CLOSURE
23*	W660-0009	ON/OFF SWITCH
24*	W690-0002	THERMODISC
25*	W380-0002	VARIABLE SPEED SWITCH KNOB
26*	KB35	VARIABLE SPEED SWITCH
27	W080-0451	RESTRICTOR BRACKET

TERMINAL KITS

28	GDI-223	TERMINAL KIT
----	---------	--------------

VENT KITS

1-2" & 1-3" DOUBLE PLY ALUMINUM LINER-INLET AND EXHAUST & 2-3" TO 2" REDUCER:

29*	GDI-2320KT	VENT KIT 20FT
29*	GDI-2325KT	VENT KIT 25FT
29*	GDI-2335KT	VENT KIT 35FT

2-3" DOUBLE PLY ALUMINUM LINER-INLET AND EXHAUST:

30*	GDI-320KT	VENT KIT 20FT
30*	GDI-325KT	VENT KIT 25 FT
30*	GDI-335KT	VENT KIT 35 FT

ACCESSORIES:

31*	W690-0001	MILLIVOLT THERMOSTAT
32*	W660-0010	REMOTE CONTROL - ADVANTAGE
32*	W660-0011	REMOTE CONTROL - ADVANTAGE PLUS
33*	GD660	REMOTE WALL SWITCH c/w 20FT WIRE
34	GI-790KT	DECORATIVE BRICK PANELS
35*	W175-0162	CONVERSION KIT - NG-LP
35*	W175-0192	CONVERSION KIT - LP-NG
36*	GIZBP6-3	3 SIDED BACKER PLATE c/w ACCENT TRIM
37*	GIZBP6-4	4 SIDED BACKER PLATE c/w ACCENT TRIM
38*	GIZTRM3	ALUMINIUM EXTRUSION - MATTE BLACK
38*	GIZTRM3-K	ALUMINIUM EXTRUSION - POLISHED BLACK
38*	GIZTRM3-B	ALUMINIUM EXTRUSION - POLISHED BRASS
39	GIZTRM4	ALUMINIUM EXTRUSION - MATTE BLACK
39	GIZTRM4-K	ALUMINIUM EXTRUSION - POLISHED BLACK
39	GIZTRM4-B	ALUMINIUM EXTRUSION - POLISHED BRASS
40	GIZUT-B	UPPER DOOR TRIM - BRASS
40	GIZUT-G	UPPER DOOR TRIM - GOLD
41	GI-900K6	6" DELUXE FLASHING W MARQUIS TRIM - BLACK
41	GI-900B6	6" DELUXE FLASHING W MARQUIS TRIM - POLISHED BRASS
41	GI-900AB6	6" DELUXE FLASHING W MARQUIS TRIM - ANTIQUE BRASS
41	GI-900SS6	6" DELUXE FLASHING W MARQUIS TRIM - BRUSHED STAINLESS STEEL
41	GI-909S6	6" DELUXE FLASHING W MARQUIS TRIM - PORCELAIN ALMOND
41	GI-909K6	6" DELUXE FLASHING W MARQUIS TRIM - PORCELAIN BLACK
41	GI-909F6	6" DELUXE FLASHING W MARQUIS TRIM - PORCELAIN GREEN
41	GI-900K9	9" DELUXE FLASHING W MARQUIS TRIM - BLACK
41	GI-900B9	9" DELUXE FLASHING W MARQUIS TRIM - POLISHED BRASS
41	GI-900AB9	9" DELUXE FLASHING W MARQUIS TRIM - ANTIQUE BRASS
41	GI-900SS9	9" DELUXE FLASHING W MARQUIS TRIM - BRUSHED STAINLESS STEEL
41	GI-909S9	9" DELUXE FLASHING W MARQUIS TRIM - PORCELAIN ALMOND
41	GI-909K9	9" DELUXE FLASHING W MARQUIS TRIM - PORCELAIN BLACK
41	GI-909F9	9" DELUXE FLASHING W MARQUIS TRIM - PORCELAIN GREEN
42*	GIZBRKT	MOUNTING BRACKETS (REQUIRED FOR THE 900 SERIES FLASHING KITS)
43	CISK-A	CAST IRON SURROUND KIT - PAINTED BLACK
43	CISKK-A	CAST IRON SURROUND KIT - PORCELAIN ENAMEL BLACK
43	CISKN-A	CAST IRON SURROUND KIT - PORCELAIN ENAMEL MAJOLICA BROWN
43	CISKF-A	CAST IRON SURROUND KIT - PORCELAIN ENAMEL MAJOLICA GREEN
44*	AK-4	ADAPTOR KIT FOR CAST IRON SURROUND
45	ANI-K	ANDIRON - PAINTED BLACK
45	ANI-G	ANDIRON - GOLD PLATED

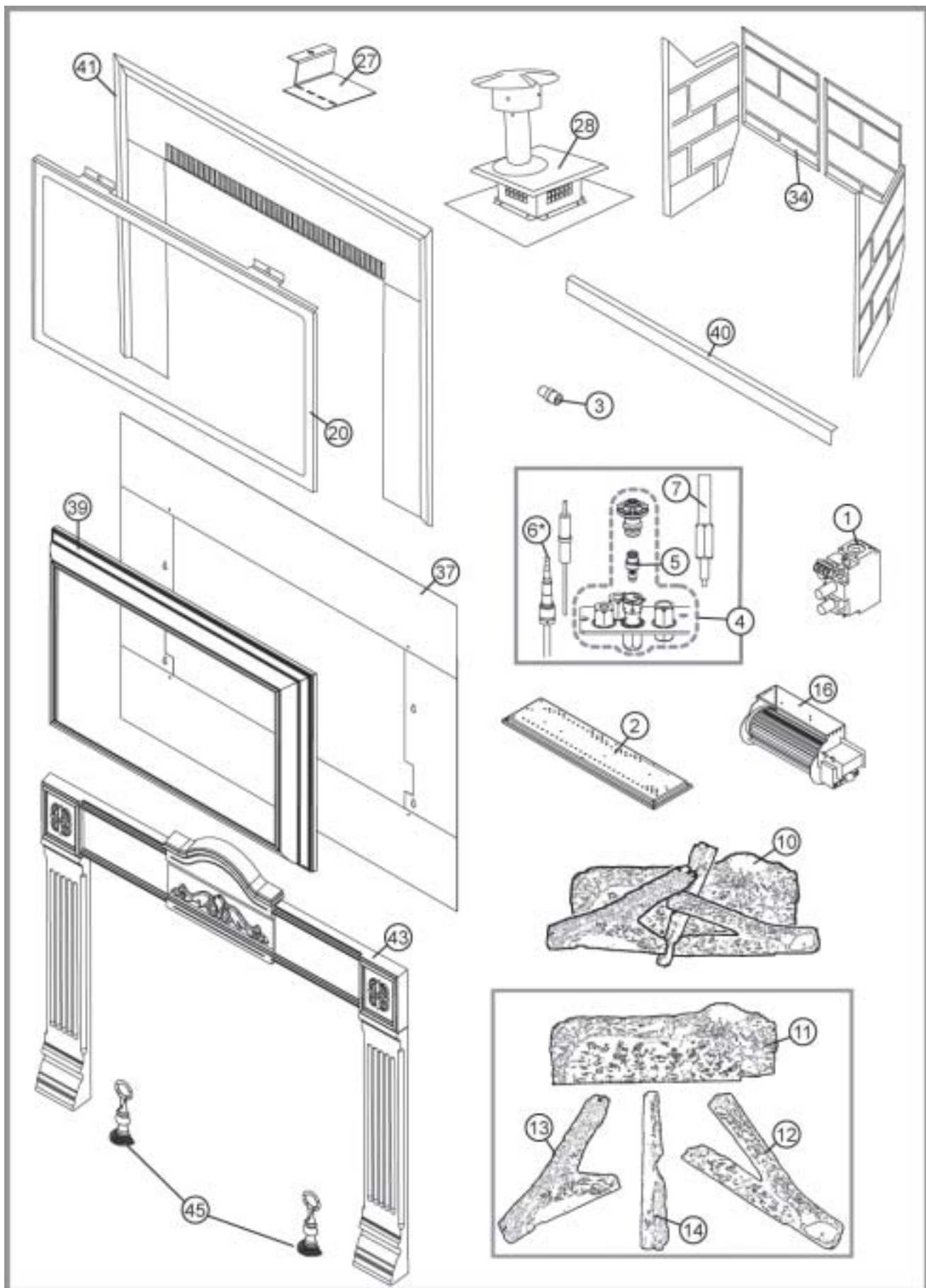

* **WARNING:** This is a fast acting thermocouple. It is an integral safety component. Replace only with a fast acting thermocouple supplied by Wolf Steel Ltd. W415-0224/D/01.15.04

TROUBLE SHOOTING GUIDE

BEFORE ATTEMPTING TO TROUBLESHOOT, PURGE YOUR UNIT AND INITIALLY LIGHT THE PILOT AND THE MAIN BURNER WITH THE GLASS DOOR REMOVED.

SYMPTOM	PROBLEM	TEST SOLUTION
---------	---------	---------------

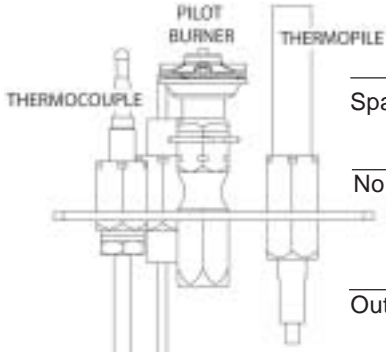

Pilot will not light.	No spark at pilot burner	<ul style="list-style-type: none"> - check if pilot can be lit by a match - check that the wire is connected to the push button ignitor. - check if the push button ignitor needs tightening. - replace the push button ignitor.
	Spark gap is incorrect	<ul style="list-style-type: none"> - spark gap should be 0.150" to 0.175" (5/32" to 11/64" approx.) from the electrode tip and the pilot burner.
	No gas at the pilot burner	<ul style="list-style-type: none"> - check that the manual valve is turned on. - check the pilot orifice for blockage. - replace the valve. - call the gas distributor.
	Out of propane gas.	<ul style="list-style-type: none"> - fill the tank.
Pilot goes out when the gas knob is released.	System is not correctly purged.	<ul style="list-style-type: none"> - purge the gas line with the glass door open.
	Out of propane gas	<ul style="list-style-type: none"> - fill the tank.
	Pilot flame is not large enough	<ul style="list-style-type: none"> - turn up the pilot flame.
	Pilot flame is not engulfing the thermocouple.	<ul style="list-style-type: none"> - turn up pilot flame. - replace pilot assembly.
	Thermocouple shorting.	<ul style="list-style-type: none"> - loosen and tighten thermocouple. - clean thermocouple and valve connection. - replace thermocouple. - replace valve.
	Faulty thermocouple.	<ul style="list-style-type: none"> - replace.
	Faulty valve.	<ul style="list-style-type: none"> - replace.
Pilot burning; no gas to main burner; gas knob is on 'HI'; wall switch / thermostat is on.	Main burner orifice is plugged.	<ul style="list-style-type: none"> - remove stoppage in orifice.
	Faulty thermopile.	<ul style="list-style-type: none"> - replace.
	Faulty thermostat or switch.	<ul style="list-style-type: none"> - connect a jumper wire across the wall switch terminals; if main burner lights, replace thermostat. - disconnect the switch wires & connect a jumper wire across terminals 1 & 3; if the main burner lights, check the wires for defects and / or replace wires.
	Faulty valve.	<ul style="list-style-type: none"> - replace.
Pilot goes out while standing; Main burner is in 'OFF' position.	Gas piping is undersized.	<ul style="list-style-type: none"> - turn on all gas appliances and see if pilot flame flutters, diminishes or extinguishes, especially when main burner ignites. Monitor supply pressure. - check if supply piping size is to code. Correct all undersized piping.
Main burner goes out; pilot stays on.	Pilot flame is not large enough or not engulfing the thermopile.	<ul style="list-style-type: none"> - turn up pilot flame. - replace pilot assembly.
	Thermopile shorting	<ul style="list-style-type: none"> - clean thermopile and thermopile connection to valve.
	Remote wall switch wire is too long, too much resistance in the system	<ul style="list-style-type: none"> - shorten wire to correct length or wire gauge.
	Faulty thermostat or switch	<ul style="list-style-type: none"> - replace

SYMPTOM	PROBLEM	TEST SOLUTION
Main burner goes out; pilot goes out.	REFER TO "MAIN BURNER GOES OUT; PILOT STAYS ON"	
	Vent re-circulating	- check joint seals and installation.
	Thermocouple shorting or faulty.	- loosen and tighten thermocouple - clean thermocouple and valve connection. - replace thermocouple. - replace valve.
	Vent is reversing	- check all venting and insert seals. - check that door is properly sealed. If the insert is allowed to burn with the door off when purging the unit, exhaust products may escape through the air intake pipe and reverse the venting action. Let the unit cool down to correct the reversed venting action.
Exhaust fumes smelled in room, headaches.	Fireplace is spilling.	- check all seals.
Carbon is being deposited on glass, logs or combustion chamber surfaces.	Air shutter has become blocked	- ensure air shutter opening is free of lint or other obstructions.
	Flame is impinging on the logs or combustion chamber.	- check that the logs are correctly positioned. - open air shutter to increase the primary air. - check the input rate: check the manifold pressure and orifice size as specified by the rating plate values. - check that the door gasketing is not broken or missing and that the seal is tight. - check that both vent liners are free of holes and well sealed at all joints.
	Air shutter is not set to specifications.	- check and adjust air shutter to correspond with the fuel type and air intake size.
Main burner flame is a blue, lazy, transparent flame.	Blockage in vent.	- remove blockage. In really cold conditions, ice buildup may occur on the terminal and should be removed as required.
	Incorrect installation.	- vent liners are reversed. Refer to Figure 2. - check all venting and insert seals.
White / grey film forms.	Sulphur from fuel is being deposited on glass, logs or combustion chamber surfaces.	- clean the glass with a recommended gas fireplace glass cleaner. DO NOT CLEAN GLASS WHEN HOT. If deposits are not cleaned off regularly, the glass may become permanently marked.

Free Manuals Download Website

<http://myh66.com>

<http://usermanuals.us>

<http://www.somanuals.com>

<http://www.4manuals.cc>

<http://www.manual-lib.com>

<http://www.404manual.com>

<http://www.luxmanual.com>

<http://aubethermostatmanual.com>

Golf course search by state

<http://golfingnear.com>

Email search by domain

<http://emailbydomain.com>

Auto manuals search

<http://auto.somanuals.com>

TV manuals search

<http://tv.somanuals.com>