

CREATIVE
DC-CAM

3200Z



User Guide

Table of Contents

1 Getting Started	- 1 -
Package Contents.....	- 1 -
System Requirements.....	- 2 -
Safety Tips.....	- 2 -
FCC Compliance and Advisory	- 3 -
Camera Components	- 4 -
Front.....	- 4 -
Rear.....	- 4 -
Side	- 4 -
Using the Accessories.....	- 5 -
Attaching the Wrist Strap.....	- 5 -
Using the Soft Case.....	- 5 -
2 Preparing to Take Pictures	- 6 -
Installing the Batteries.....	- 6 -
Low Battery Indicator	- 7 -
Turning the Power On.....	- 7 -
Setting the Date and Time	- 8 -
Language Settings.....	- 8 -
TV Out Settings.....	- 9 -
Setting the Beep Sound	- 9 -
Setting the Power Save Function.....	- 10 -
SD Memory Cards	- 11 -
Inserting.....	- 11 -
Removing	- 11 -
Camera Mode Setting	- 12 -
Photo Mode.....	- 12 -
Playback Mode.....	- 12 -
Video Mode	- 12 -
3 Taking Pictures	- 13 -
Previewing a Picture	- 13 -
Taking a Picture	- 13 -
Setting the LCD Display Mode.....	- 13 -
Setting Image Quality and Resolution.....	- 14 -
Using the Zoom Function.....	- 15 -
Using the Flash.....	- 16 -
Adjusting the Exposure	- 16 -
Using Different Metering Options	- 17 -
Setting the White Balance.....	- 17 -
White Balance Settings Explained.....	- 18 -

Using Macro Mode	- 19 -
Using the Self-Timer	- 19 -
Using the Date Stamp Function	- 20 -
Using Long Shutter Speeds	- 20 -
Recording Video Clips	- 21 -
Setting Quick View	- 21 -
4 Reviewing Photos and Videos.....	- 22 -
Viewing Pictures	- 22 -
Viewing Pictures in Thumbnail Mode	- 23 -
Protecting Stored Images.....	- 23 -
Erasing a Stored Image	- 24 -
Erasing all Images	- 24 -
Slide Show	- 25 -
Copy to Card.....	- 25 -
Formatting the Camera Memory or SD Card	- 25 -
5 File Names & Printing.....	- 26 -
Folder Names	- 26 -
File Names.....	- 27 -
DPOF Print Settings.....	- 27 -
Print Order Setting.....	- 27 -
6 Making Connections.....	- 28 -
Viewing Images on the TV	- 28 -
Selecting the Video Out Signal Mode	- 28 -
Downloading Images to a Computer.....	- 29 -
Using a Flash Card Memory Reader	- 29 -
Connecting to a Computer Using USB	- 30 -
Understanding Camera Memory	- 31 -
Internal Memory	- 31 -
Optional SD Memory Card	- 31 -
DCF Protocol.....	- 31 -
7 Software Installation.....	- 32 -
Software Driver	- 32 -
Roxio PhotoSuite 5 / Roxio VideoWave Movie Creator.....	- 32 -
8 Appendix	- 33 -
Troubleshooting	- 33 -
Specifications.....	- 34 -

1 Getting Started

Package Contents

Contact your dealer immediately if any of the items listed below is missing or damaged.

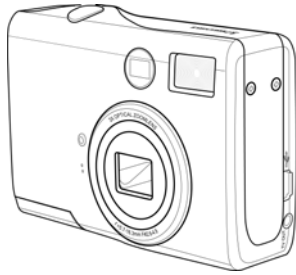

Camera

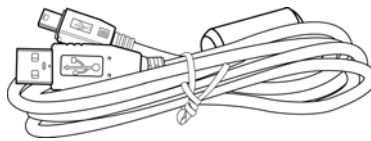

USB Cable

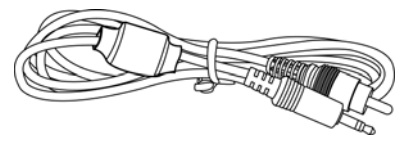

TV Out Cable

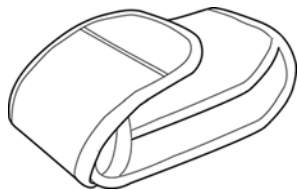

Soft Case



Strap

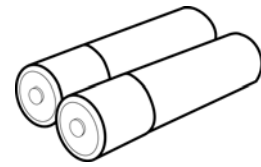

2 x AA Batteries

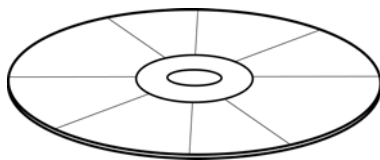

Installation CD

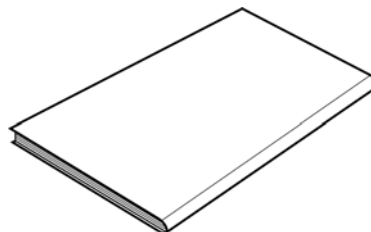

Quick Start Booklet

System Requirements*

Windows:

- Intel® Pentium® II 266 MHz or better
- Windows® XP/2000/ME/98SE
- Minimum 64 MB RAM
- USB port
- CD-ROM/DVD-ROM drive
- 16-bit color display compatible monitor (800x600 pixels)

Macintosh**:

- Power Mac® G3 or later
- Mac® OS 9.0, 9.1, 9.2 and OS X
- Minimum 64 MB RAM
- USB port
- CD-ROM/DVD-ROM drive
- 16-bit color display compatible monitor (800x600 pixels)

* Specifications are subject to change without prior notice.

** Only file transfers are supported on Macintosh systems.

Safety Tips

- Do not try to open the case of the camera or attempt to modify this camera in any way. High-voltage internal components create the risk of electric shock when exposed. Maintenance and repairs should be carried out by authorized service providers.
- Do not fire the flash too close to animals or people's eyes, especially young children. Eye damage may be caused.
- Keep the camera away from water and other liquids. Do not use the camera with wet hands. Never use the camera in the rain or snow. Moisture creates the danger of fire and electric shock.
- Keep the camera and its accessories out of the reach of children and animals to prevent accidents or damage to the camera.

FCC Compliance and Advisory

This device complies with Part 15 of the FCC Rules. Operation is subject to the following two conditions: 1.) this device may not cause harmful interference, and 2.) this device must accept any interference received, including interference that may cause undesired operation.

This equipment has been tested and found to comply with the limits for a Class B peripheral, pursuant to Part 15 of the FCC Rules. These limits are designed to provide reasonable protection against harmful interference in a residential installation. This equipment generates, uses, and can radiate radio frequency energy and, if not installed and used in accordance with the instructions, may cause harmful interference to radio communication. However, there is no guarantee that interference will not occur in a particular installation. If this equipment does cause a harmful interference to radio or television reception, which can be determined by turning the equipment off and on, the user is encouraged to try to correct the interference by one or more of the following measures.

- Reorient or relocate the receiving antenna.
- Increase the separation between the equipment and receiver.
- Connect the equipment to an outlet on a circuit different from that to which the receiver is connected.
- Consult the dealer or an experienced radio/TV technician for help.

Any changes or modifications not expressly approved by the party responsible for compliance could void the user's authority to operate the equipment. Where shielded interface cables have been provided with the product or specified additional components or accessories elsewhere defined to be used with the installation of the product, they must be used in order to ensure compliance with FCC regulation.

Camera Components

Front

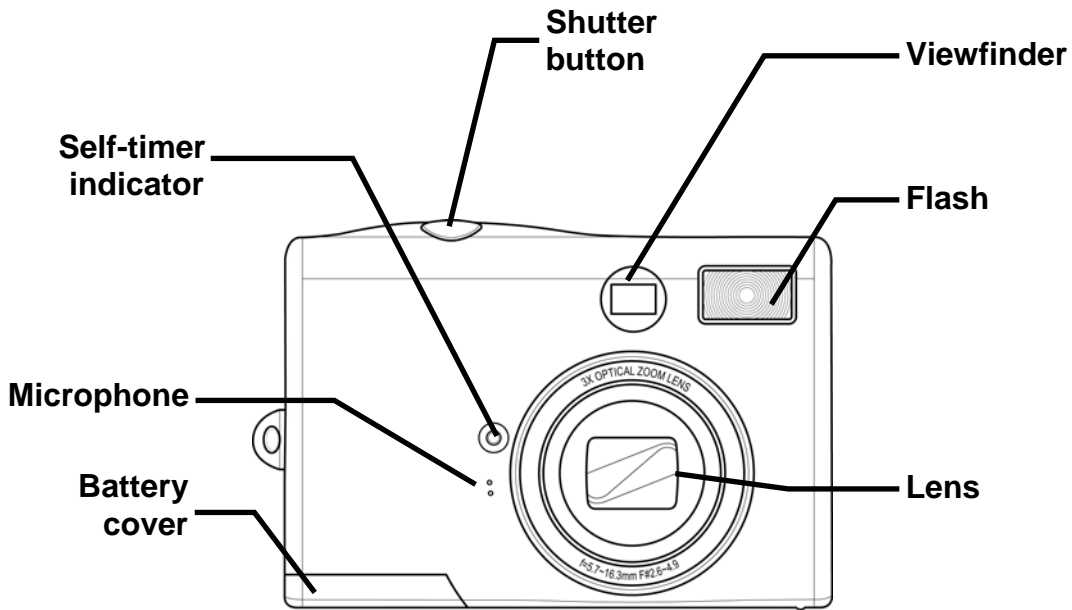

Rear

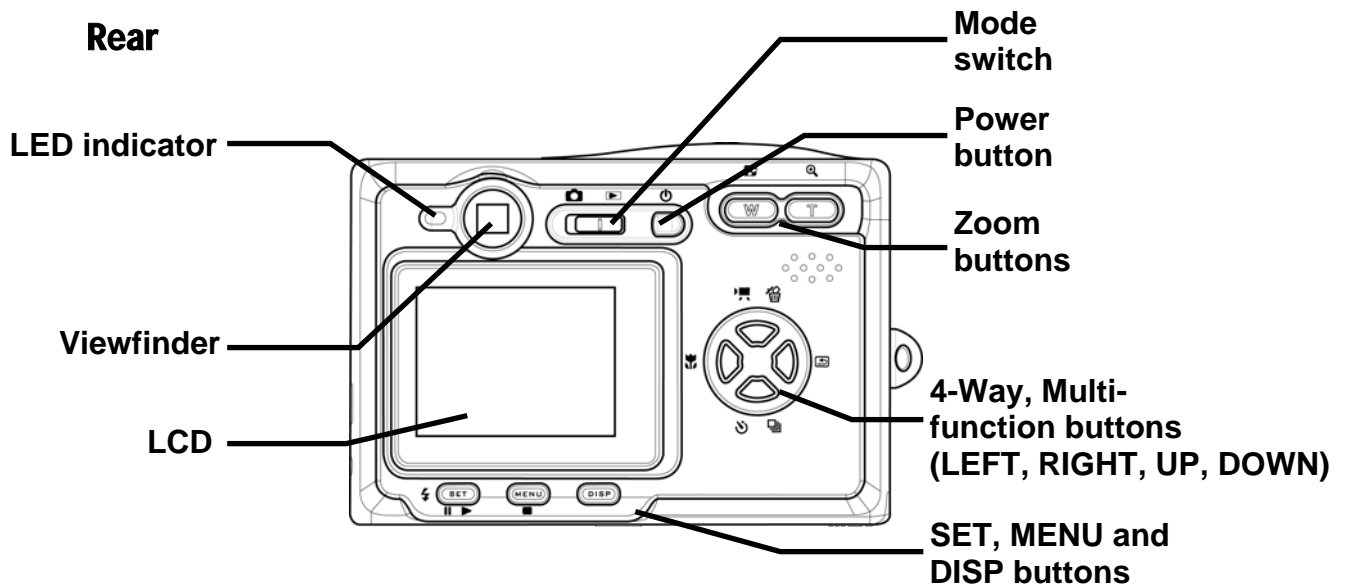

Side

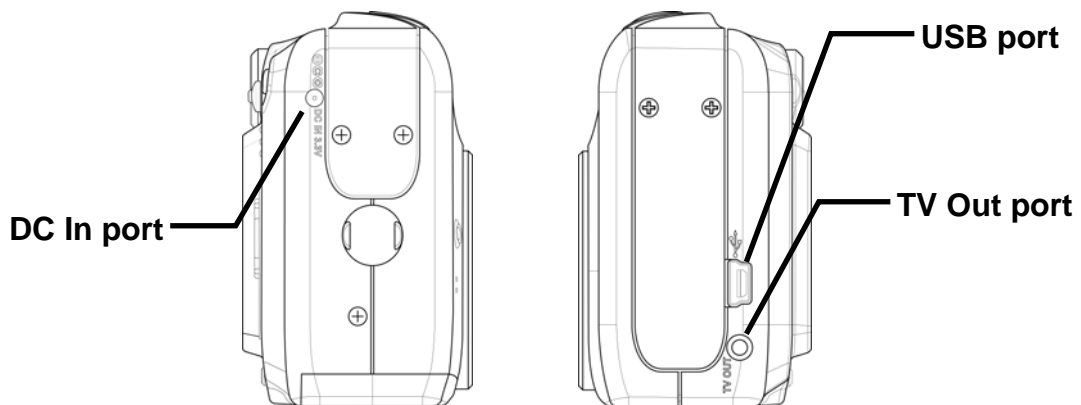

Using the Accessories

Attaching the Wrist Strap

Attach the wrist strap to your camera as shown in the illustration to the right.

NOTE:

Do not swing the camera when carrying it by the wrist strap.

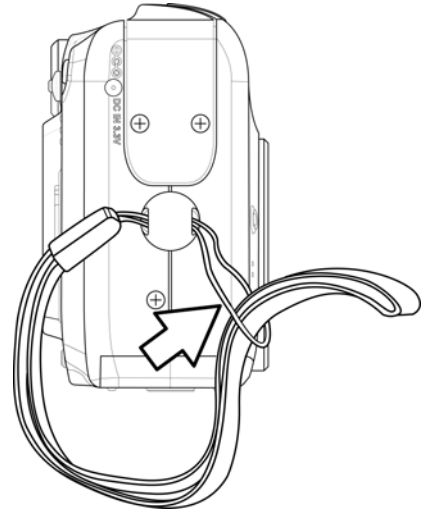

Using the Soft Case

- Store the camera in the soft case provided when not in use.
- Slide the camera into the case, making sure there are no sharp objects inside that may damage the camera.

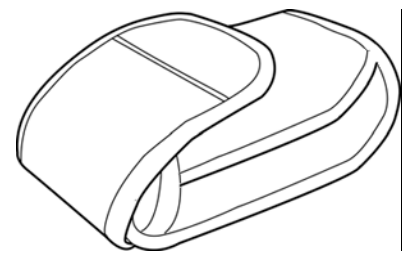

2 Preparing to Take Pictures

Installing the Batteries

The camera is powered by two AA-size alkaline batteries or rechargeable NiMH (min. 550 mAh / 1.2V) batteries (available separately).

Follow these instructions to insert batteries into the camera.

1. Slide the battery cover in the direction of the arrow.

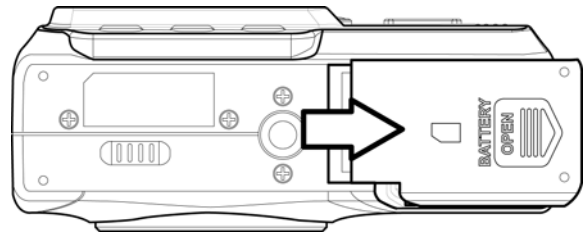

2. Swing the battery cover open.

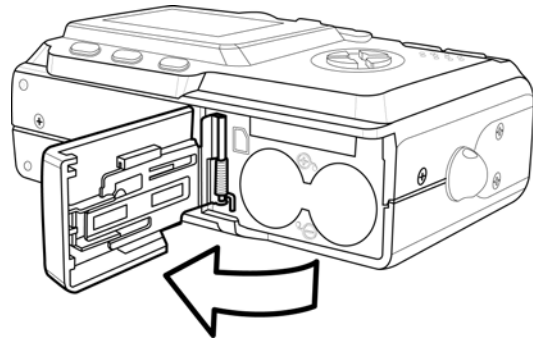

3. Insert two AA-size alkaline batteries with the positive (+) and negative (-) poles matching the directions indicated inside the battery cover.

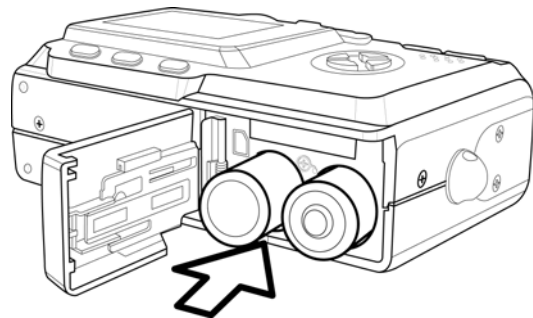

4. Slide the battery cover back into the closed position.

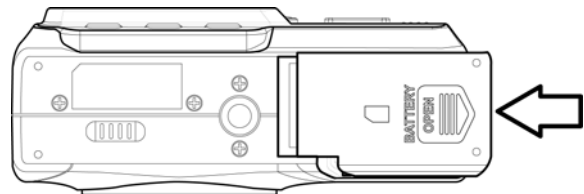

Low Battery Indicator

The low battery indicator  on the LCD screen means that the batteries are nearly exhausted. Batteries should be replaced when you see the low battery indicator.

NOTES:

- Do not use manganese batteries. Manganese batteries cannot supply sufficient power to support camera operation.
- Replace all batteries at the same time. Never mix old and new batteries.
- Remove batteries from the camera if you do not plan on using it for more than two weeks.
- The camera body may feel warm after extended use. This is normal.

Turning the Power On

Press the Power button. The LED indicator begins flashing green. It takes about 3 seconds to power on the camera.

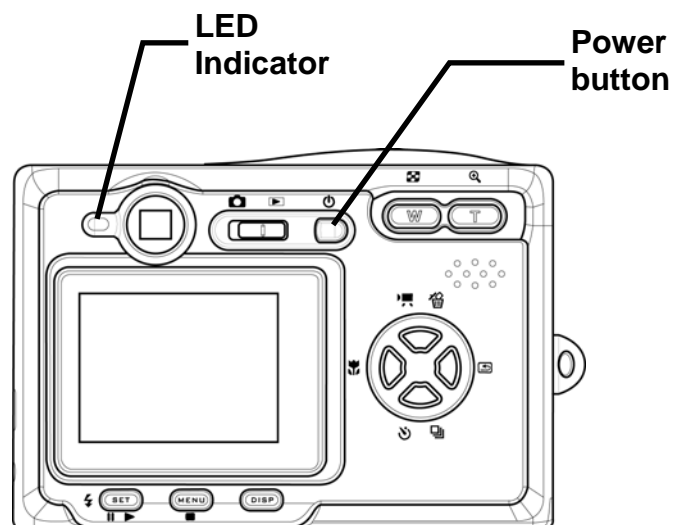

NOTE:

Set the date and time after turning the camera on for the first time. See the next section for details.

Setting the Date and Time

1. Turn on the camera.
2. Press the MENU button.
3. Press the RIGHT button to select the SETUP menu.
4. Press the UP or DOWN buttons to select the Date & Time option.
5. Press the RIGHT button to enter the Date & Time submenu.
6. Press the UP or DOWN buttons to change the values.
7. Press the LEFT or RIGHT buttons to advance to the next field.
8. Change the date style setting if desired.
9. Press the UP or DOWN buttons to select the desired date format: YY/MM/DD, MM/DD/YY, or DD/MM/YY.
10. Press SET to exit the Date & Time submenu or press MENU to cancel.

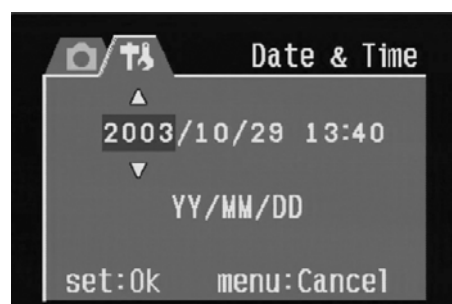

Language Settings

The camera can display menus and other information in a number of different languages.

1. Turn the camera on.
2. Press the MENU button.
3. Press the RIGHT button to select the SETUP menu.
4. Press the UP or DOWN buttons to select Language.
5. Press the RIGHT button to enter the Language submenu.
6. Press the UP or DOWN buttons to select the desired language.
7. Press the SET button to save your choice.
8. Press the MENU button to leave the Language submenu.



NOTE:

The default language setting is English.

TV Out Settings

Your camera can be connected to a TV as described in Chapter 6 Making Connections. Connecting to a TV allows you to preview photos and video clips on the television screen. TV Out should be set to either NTSC or PAL depending on your region. The default setting varies according to the country of purchase.

1. Turn the camera on.
2. Press the MENU button.
3. Press the RIGHT button to select the SETUP menu.
4. Press the UP or DOWN buttons to select TV Out.
5. Press the RIGHT button to enter the TV Out submenu.
6. Press the UP or DOWN buttons to select NTSC or PAL.
7. Press the SET button to save your choice or the MENU button to cancel.

NOTE:

NTSC: Japan, Korea, Taiwan, USA

PAL: Australia, China, EU, Kuwait, Singapore



Setting the Beep Sound

The camera beep sound can be turned on (default) or off as required.

1. Turn the camera on.
2. Press the MENU button.
3. Press the RIGHT button to select the SETUP menu.
4. Press the UP or DOWN keys to select the Beep option.
5. Press the RIGHT key to enter the Beep submenu.
6. Press the UP or DOWN buttons to choose on or off.
7. Press the SET button to save your option.
8. Press the MENU button to leave the Beep submenu.

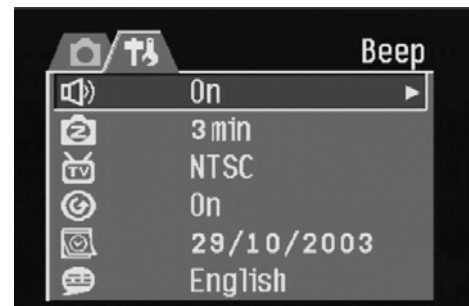

Setting the Power Save Function

To save battery power, your camera can be set to turn itself off after 1, 3 (default), or 5 minutes of inactivity. The period can be set in the SETUP menu.

1. Turn the camera on.
2. Press the MENU button.
3. Press the RIGHT button to select the SETUP menu.
4. Press the UP or DOWN buttons to select the Power Save option.
5. Press the RIGHT button to enter the Power Save submenu
6. Press the UP or DOWN buttons to select 1, 2 or 3 mins. The camera will turn itself off automatically if not used for the specified period. You can also turn the function off completely.
7. Press SET button to save your option
8. Press the MENU button to leave the Power Save submenu.

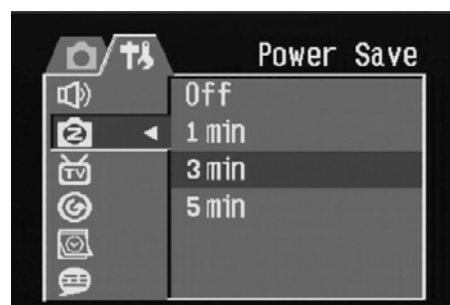
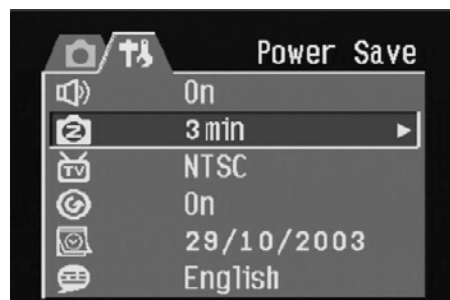

Note:

The Power Save function will work only when the camera is powered by batteries. If a DC power supply is used, the camera will not turn off automatically.

SD Memory Cards

The SD memory card slot is located beneath the battery cover, adjacent to the battery compartment.

Inserting

1. Slide the battery cover open.
2. Slide the SD card into the slot as shown.
3. Close the battery compartment.

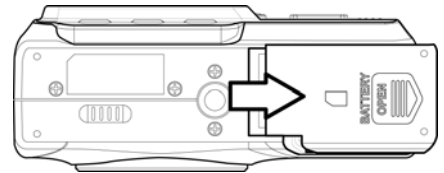

Removing

1. Slide the battery cover open.
2. Push and release the SD card. It will eject part way from the slot.
3. Pull the SD card from the slot.
4. Close the battery cover.

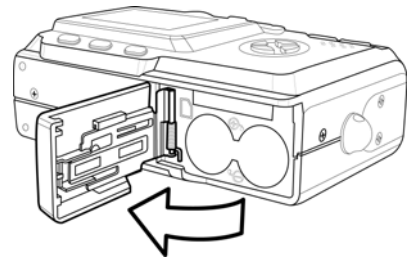

When a memory card is inserted, an icon appears in the LCD.



Memory Card icon

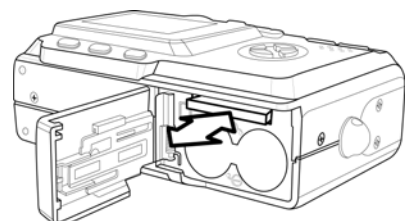
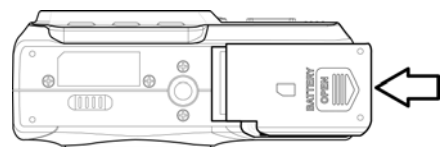
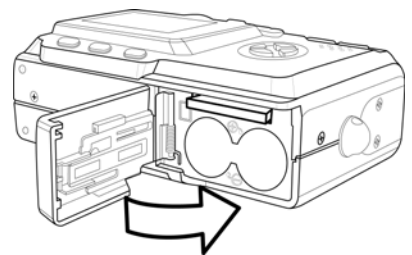
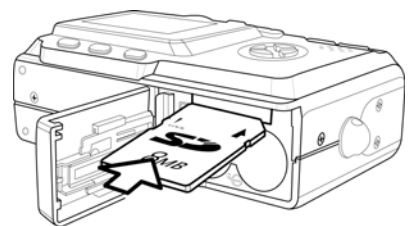

Images and video files are automatically saved to the SD memory card whenever it is inserted in the camera.

Camera Mode Setting

Your camera can be set in various modes for different situations.

Photo Mode



In Photo mode, the camera automatically adjusts exposure and white balance to suit the shooting environment.

Playback Mode



In Playback mode you can review, erase, and protect photos and video clips.

Video Mode



Your camera can record video clips with audio in Video mode. White balance and exposure can be set before recording a video clip.

NOTE:

When the camera is connected to a computer with the included USB cable, the camera acts as a mass storage device, regardless of the mode setting.

3 Taking Pictures

Previewing a Picture

Preview photos on the LCD screen before pressing the shutter button.

1. Turn on the camera.
2. The LED indicator next to the viewfinder flashes green.
3. Select Photo mode. 
4. The image automatically appears on the LCD screen together with information about current camera settings.

Taking a Picture

1. Turn the camera on and make sure it is in Photo mode. 
2. Capture the photo by pressing the shutter button down until the camera beeps.
3. The photo is captured and stored on the camera's internal memory, or on the SD card if inserted.

The green LED Flashes while the image is being stored.

NOTES:

- When the shutter button is pressed halfway down, check the exposure value that appears on the LCD screen to make sure that it is appropriate for the lighting conditions.
- The beep does not sound if the beep setting is turned off in the Set menu.

Setting the LCD Display Mode



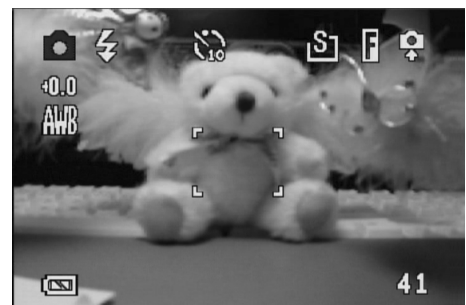

Turn the LCD screen display on or off by pressing DISP. There are 2 LCD screen display in Playback and Video modes. There are 3 LCD screen display in Photo mode.

1. In Playback mode and Video modes, press DISP once to turn the on-screen information display (OSD) off and press again to restore OSD.
2. In Photo mode, press DISP once to turn the OSD off, press again to turn the LCD off, and press a third time to turn the LCD and OSD back on.



OSD mode: The image and on-screen information OSD are shown on the LCD screen.

Setting Image Quality and Resolution

1. Turn on the camera and press the MENU button.
2. Use the UP or DOWN keys to select Resolution from the REC Menu.
3. Press the RIGHT key to enter the Resolution submenu.
4. Use the UP or DOWN keys to select a resolution from the list.
 -  2048 x 1536 (Large)
 -  1600 x 1200 (Medium 1)
 -  1024 x 768 (Medium 2)
 -  640 x 480 (Small)
5. Press SET to save your setting. The camera returns to Photo mode.
6. Press Menu again to return to REC Menu.
7. Use the UP or DOWN keys to select Quality from the REC Menu.
8. Press the RIGHT key to enter the Quality submenu.
9. Select Fine or Normal quality from the submenu.
10. Press SET to save your selection.

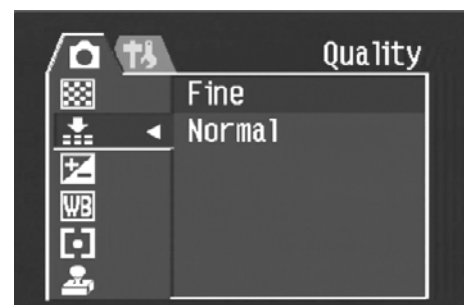
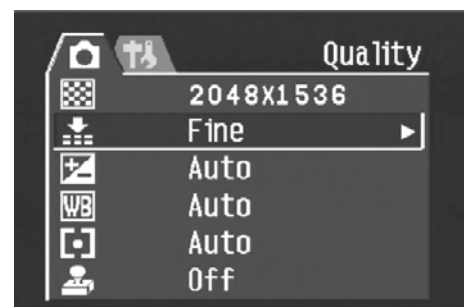
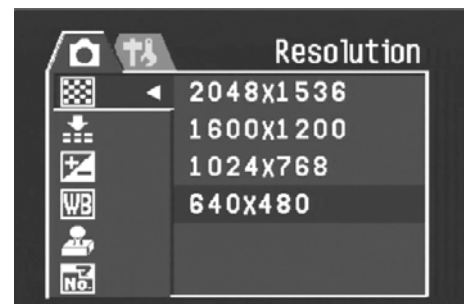
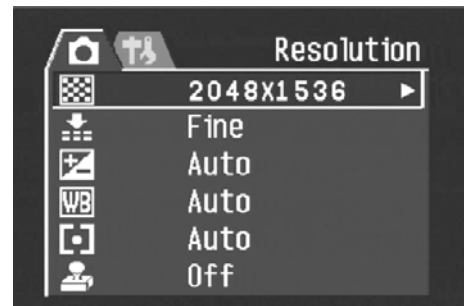

Size

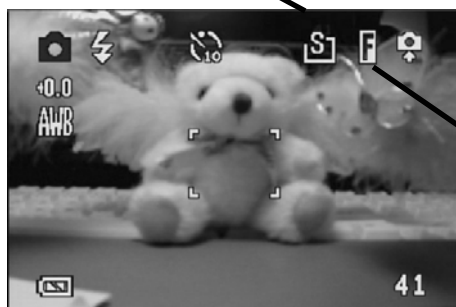

Quality

The image size and quality are displayed on the LCD.

Using the Zoom Function

Your camera has a combination of optical and digital zoom functions that allow you to zoom in on far away subjects or zoom out for a wide angle shot.

The optical zoom is achieved by mechanically adjusting the lens of the camera. The digital zoom enlarges or shrinks the image using a software process.

Press **W** to zoom out for a wide angle shot (subject appears further away).

Press **T** to zoom in for a telephoto shot (subject appears closer).

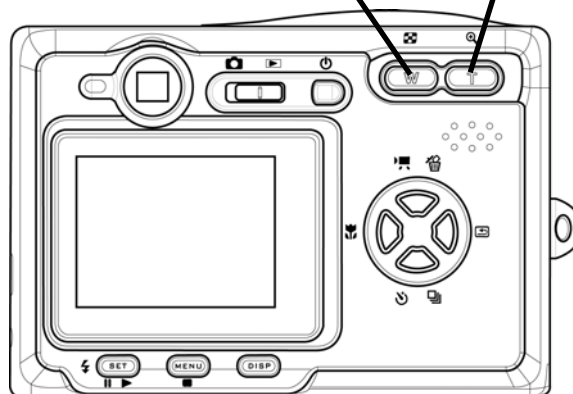

Digital zoom works by enlarging the center portion of an image through a software interpolation process. The digital zoom is used to achieve magnification levels up to 4X.

In Photo mode, press **T** to zoom in. Continue pressing **T** until the digital zoom indicator is displayed. Press **T** to digitally zoom in on a subject in increments of 0.2X.

NOTES:

- The digital zoom does not work in Video mode.
- In Photo mode, you can zoom in and out in steps of 0.2X.
- In Playback mode, you can zoom in and out in steps of 0.1X.

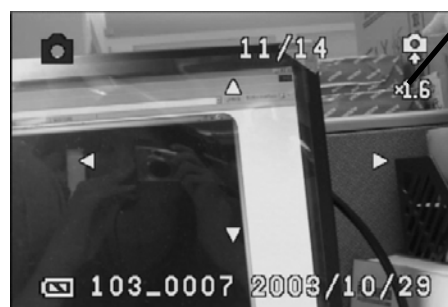

Digital zoom ratio

Using the Flash

Pressing the flash button cycles your camera through the various flash modes.

A symbol appears on the LCD screen to indicate the flash mode. The flash cannot be used in Video mode. 

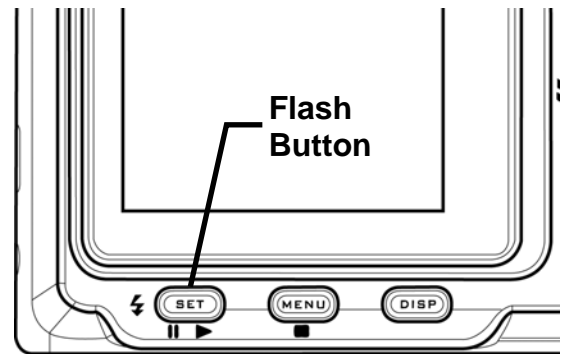

The following list describes each flash mode.

 Automatic – Flash fires when conditions require extra lighting.

 Always on – Flash fires every time you take a photo, regardless of lighting conditions.

 RedEye – Flash strobes to let the subject's eyes adjust to the flash, then fires again when the photo is taken.

 Always off – The flash never fires.

Adjusting the Exposure

Set the exposure value (EV value)  manually to compensate for unusual lighting conditions such as indirect indoor lighting, dark backgrounds, and strong backlighting.

1. Turn on the camera and press the MENU button.
2. Use the UP or DOWN buttons to select the Exposure option.
3. Press the RIGHT button to enter the Exposure submenu.
4. Use the LEFT and RIGHT buttons to set the desired exposure compensation value.
5. Press the SET button to save your selection or MENU button to cancel.

The flash mode and exposure value are displayed in the OSD screen.

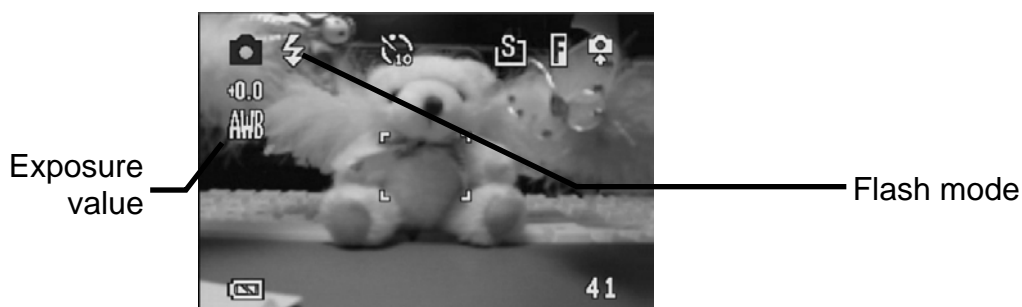
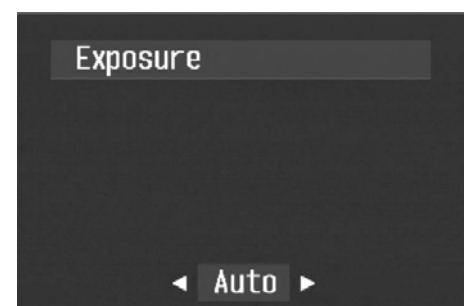
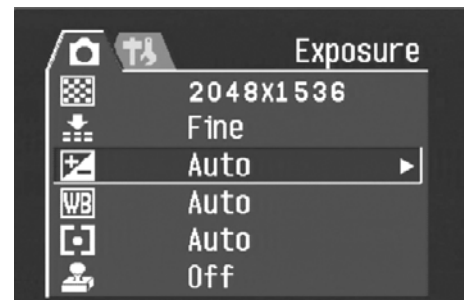

Using Different Metering Options

There are 3 different light metering options available on your camera. Auto Metering automatically selects the best exposure for you, Multi Metering selects an exposure based on readings from multiple points in the subject area and Spot Metering selects an exposure based on a single reading taken from the center of your picture.

1. Turn the camera on, select Photo mode and press the MENU button.
2. Use the UP or DOWN buttons to select the Metering option.
3. Press the RIGHT button to enter the Metering submenu.
4. Use the UP or DOWN buttons to select a metering option from the list.
5. Press the SET button to confirm your choice or press the MENU button to leave the menu.

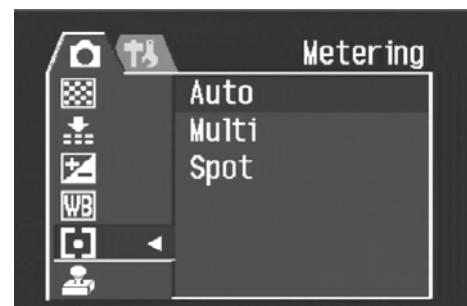
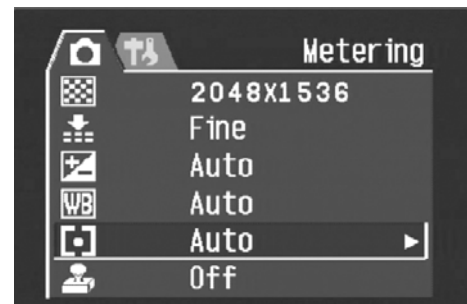

Setting the White Balance

Adjust the white balance to match different light sources such as sunlight, incandescent (tungsten) lighting or, fluorescent lighting.

1. Turn the camera on and press MENU.
2. Use the UP or DOWN keys to select the White Balance option.
3. Press the RIGHT key to enter the White Balance submenu.
4. Use the LEFT or RIGHT keys to select an option from the list.
5. Press the SET button to save your selection or MENU button to cancel.

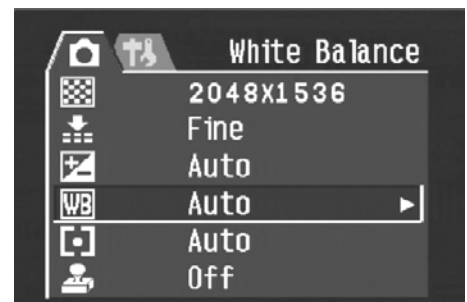

Taking Pictures

White Balance Settings Explained

 **Auto:** Automatically corrects white balance. Ideal for general photography.

 **Daylight:** Adjusts for bright sun conditions, or natural light conditions.

 **Shade:** Adjusts for cloudy days or twilight conditions.

 **Tungsten:** Adjusts for normal indoor lighting conditions. Corrects the orange hue of household light bulbs. Ideal for indoor photos under tungsten or halogen lighting without a flash.

 **Fluorescent:** Adjusts for fluorescent lighting. Corrects the green hue of fluorescent lighting. Ideal for indoor photos under fluorescent lighting without a flash.

 **Black & White:** Sets the white balance for black and white photography.

The white balance icon is displayed on the LCD screen.

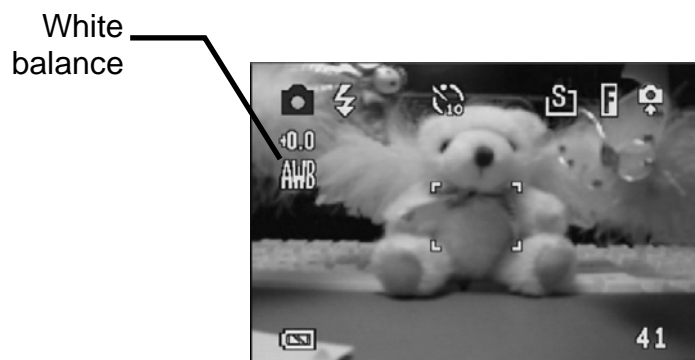



NOTE:

The flash can be used with any of the white balance settings.

Using Macro Mode

Your camera is equipped with a macro function that allows you to focus on very close subjects. In macro mode you can focus on subjects 10 cm from the lens when in the maximum wide angle (zoomed out) setting and 50 cm in the maximum telephoto (zoomed in) setting.

When in Photo mode, press the MACRO button  on the back of the camera to enter Macro mode. The macro mode icon  appears on the LCD screen when in Macro mode.

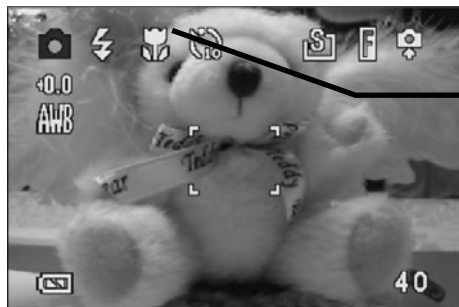

Macro mode icon

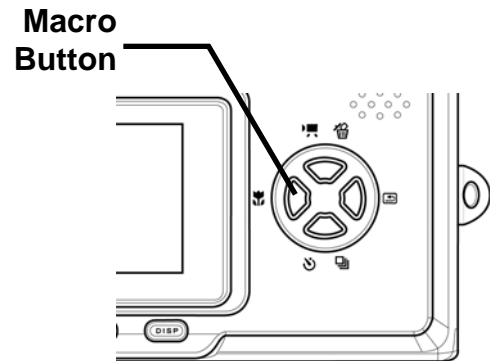

To leave Macro Mode, press the MACRO button again.

NOTES:

- Distances referred to measure the distance between the camera lens surface and the subject.
- Auto and Red-Eye Reduction flash modes cannot be used in Macro mode.

Using the Self-Timer

Your camera has a self-timer that allows you to take pictures of yourself. When the self-timer function is enabled, there is a 10 second delay between the shutter being pressed and the picture being taken.

1. To enable the self-timer function, press the self-timer button until the self-timer symbol appears on the LCD display.
2. Place the camera in a stable position, preferably on a tripod.
3. Compose your shot as normal.
4. When you are happy with the picture, press the shutter button.
5. The camera takes a picture 10 seconds after you press the shutter button. You will hear some beeps, indicating that the self-timer is active.

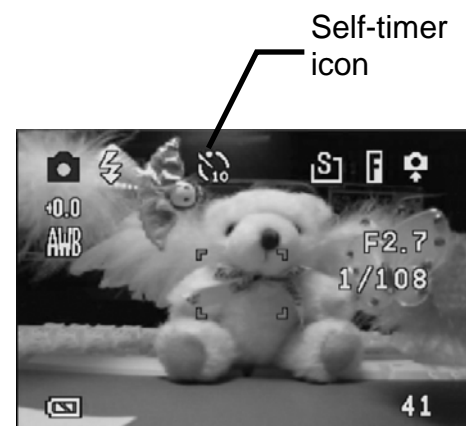

Using the Date Stamp Function

The Date Stamp function can be used to add a date to your pictures as you take them.

1. To enable the Date Stamp, turn the camera on and press the MENU key.
2. Use the UP or DOWN keys to select the Date Stamp option.
3. Press the RIGHT key to enter the Date Stamp submenu.
4. Use the UP or DOWN keys to select Off or On.
5. Press the SET button to save your setting or MENU button to cancel.

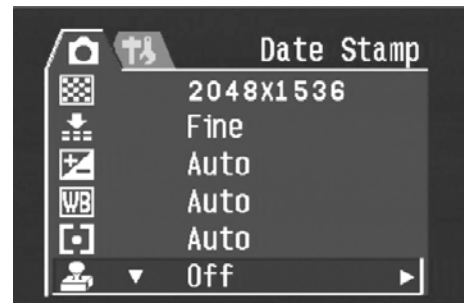

Using Long Shutter Speeds

Under certain conditions, you may want to use long shutter speeds either for special effects or when working in low light conditions. Your camera is equipped with a set of long shutter speeds which can be set from the REC menu.

1. To set a long shutter speed, turn on the camera and press the MENU button.
2. Use the UP or DOWN buttons to select the Long Shutter Speed option
3. Press the RIGHT button to enter the Long Shutter Speed submenu.
4. Use the UP or DOWN buttons to select the speed you require.
5. Press the SET button to save your selection or the MENU button to cancel.

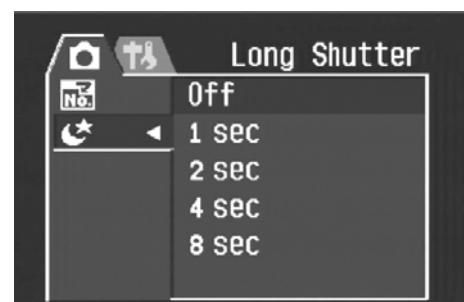

Long shutter speeds of 1, 2, 4 or 8 seconds are available.

If the shutter speed is slower than 1/32 second (due to low light conditions), the camera shake icon  appears. This means that any movement when taking a picture will result in a blur image. To prevent this, make sure you turn on the flash, use an extra light source and/or use a tripod. Note that any movement by the subject will also result in a blur image.

Recording Video Clips

Your camera can record short video clips with audio.

1. Make sure that the camera is in Photo mode.
2. Press the Video Button on the rear of the camera.
3. The video icon appears on the LCD screen.

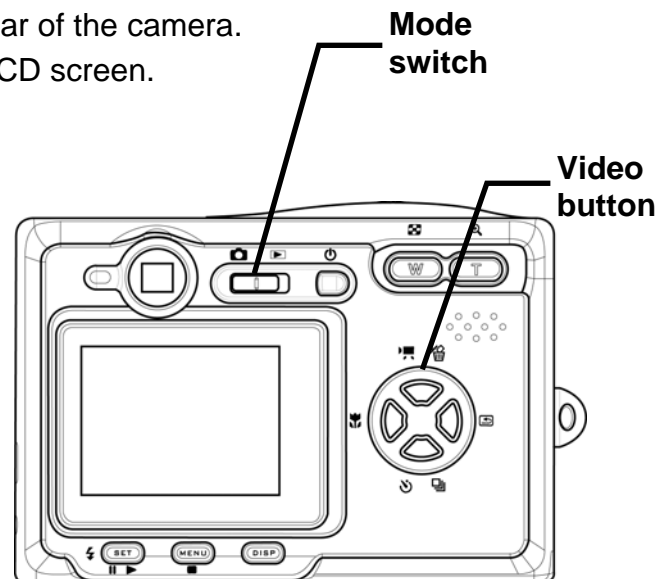
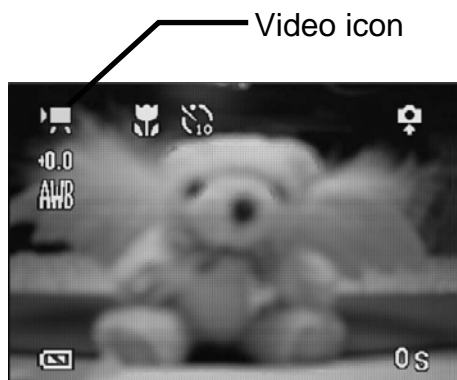

4. Press the shutter to start recording.
5. Press the shutter again to end recording.

Setting Quick View

When Quick View is enabled, you can view an image for a few seconds after you have taken it.

1. To set Quick View, turn on the camera and press the MENU button.
2. Press the RIGHT button to select the SETUP menu.
3. Press the UP or DOWN button to select Quick View.
4. Press the RIGHT button to enter the Quick View submenu.
5. Press the UP or DOWN buttons to select On to enable Quick View, or Off to disable it.
6. Press the SET button to save your selection or the MENU button to cancel.

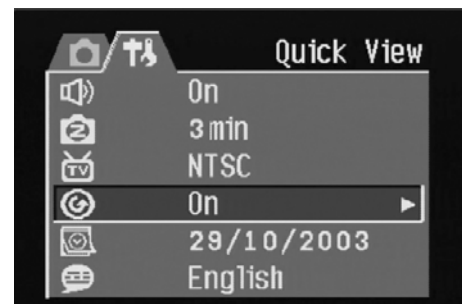

4 Reviewing Photos and Videos



Viewing Pictures

Pictures can be reviewed using the built in LCD screen.

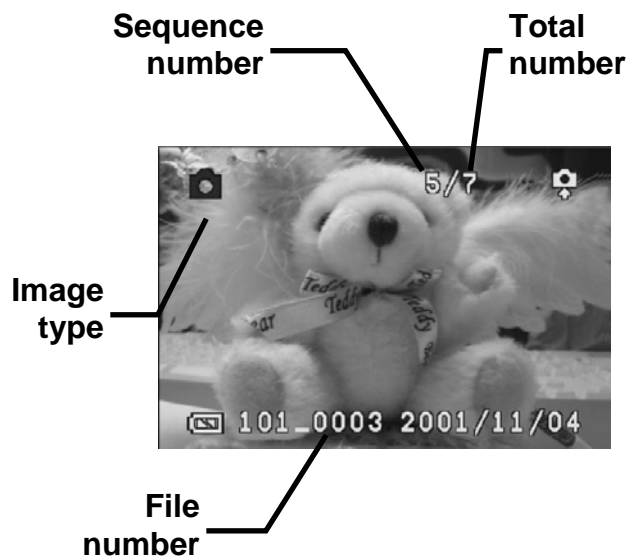
1. Turn on the camera and move the sliding switch next to the power button to Playback , to enable Playback mode.
2. Use the RIGHT and LEFT keys to step through the images stored in the internal memory or on an SD card.
3. Still images can be magnified using the T (zoom in) button.
4. Return the image to original size using the W (zoom out) button.
5. When an image is magnified, it can be moved around the screen using the UP, DOWN, LEFT and RIGHT buttons.



When cycling through images stored in the camera, some images may be marked with the Video symbol in the top left hand corner of the LCD display. These are stored video clips.

1. Press the SET (play) button  to start the video.
2. The video will play on the LCD screen.
3. Playback can be stopped using the MENU (stop) button , or paused using the SET (pause) button .

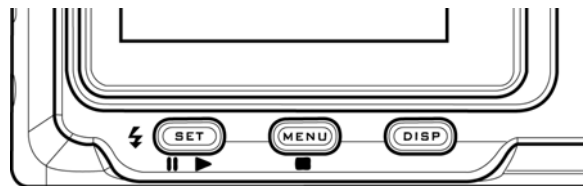

Viewing Pictures in Thumbnail Mode

When in Playback mode, you can view all your stored images in thumbnail format.

1. Turn on the camera and use the sliding switch next to the power button to enable Playback mode.
2. Press and hold the W (zoom out) button.
3. Images stored in the camera are displayed in thumbnail format.
4. Use the UP, DOWN, LEFT or RIGHT buttons to select an image to be displayed.
5. Press the SET button to display the image.
6. Return to thumbnail format by pressing the W (zoom out) button again.

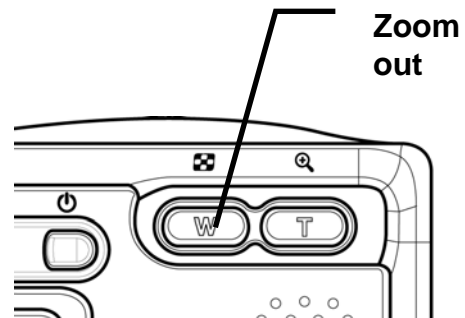

Protecting Stored Images

Images stored on your camera or on an SD card can be protected to prevent accidental deletion.

1. Turn the camera on.
2. Press the MENU button.
3. Press the RIGHT button to select SETUP menu.
4. Press the UP or DOWN buttons to select the Protect option.
5. Press the RIGHT button and select Single to protect the currently selected image, or select All to protect all files in memory.
6. Press the SET button.
7. Use the UP or DOWN buttons to select Yes to confirm the action or No to cancel.
8. Press the SET button to complete the operation.

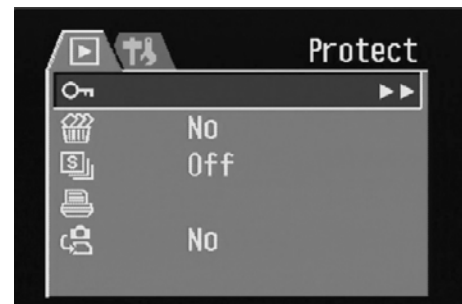

Erasing a Stored Image

Single images can be erased from the camera in Playback mode.

1. Turn on the camera and use the sliding switch next to the power button to enable Playback mode.
2. Use the LEFT or RIGHT buttons to cycle through the images to select the one you want to delete.
3. Press the UP (delete) button.
4. Use the UP or DOWN buttons to confirm that you want to delete the image or press the MENU button to cancel.

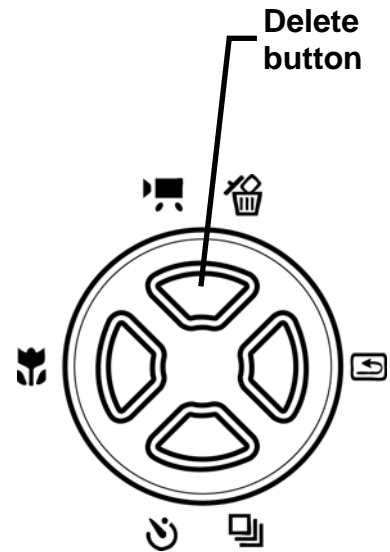

5. Press the SET button to complete the action.

Erasing all Images

You can delete all images from the SETUP menu.

1. Turn the camera on.
2. Press the MENU button.
3. Press the RIGHT button to select the SETUP menu.
4. Press the UP or DOWN buttons to select the Delete All option.
5. Press the RIGHT button to enter the Delete All submenu.
6. Use the Up or DOWN buttons to choose Yes to delete all images in memory, or select No to cancel.
7. Press the SET button to confirm the action or the MENU button to cancel.

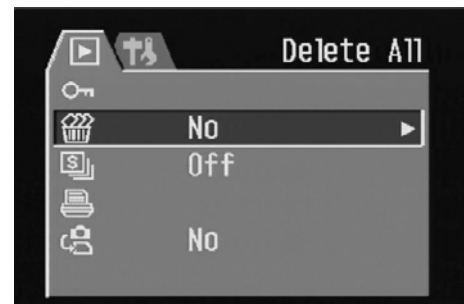

Slide Show

You can set the camera to display images in a slide show.

1. Turn the camera on.
2. Press the MENU button.
3. Press the RIGHT button to select the SETUP menu.
4. Press the UP or DOWN buttons to select the Slide Show option.
5. Press the RIGHT button and select 5 or 10 seconds to set the time between images or select Off to disable the slide show.

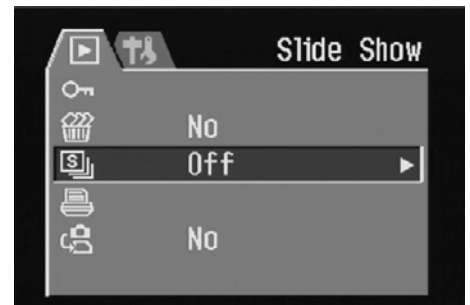

Copy to Card

You may want to copy the data from the camera's internal memory to the flash card for convenience.

1. Turn the camera on.
2. Press the MENU button.
3. Press the RIGHT button to select SETUP menu.
4. Press the UP or DOWN buttons to select the Copy To Card option.
5. Press the RIGHT button to enter the Copy To Card submenu.
6. Use the UP or DOWN buttons to select Yes to copy to card or No to cancel.
7. Press the SET button to confirm.

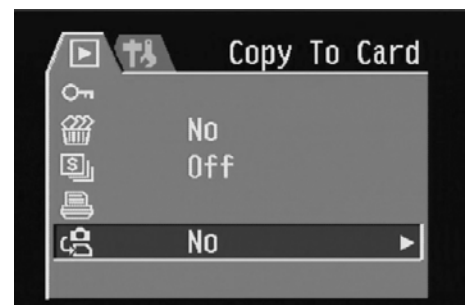

Formatting the Camera Memory or SD Card

Formatting the memory in your camera will permanently erase all images.

1. Turn on the camera on and press the MENU button.
2. Press the RIGHT button to enter Setup menu.
3. Use the UP or DOWN buttons to select the Format option from the Setup Menu.
4. Press the RIGHT button to enter the Format submenu.
5. Use the UP or DOWN buttons to select Yes to format memory or No to cancel.
6. Press the SET button to confirm your selection.

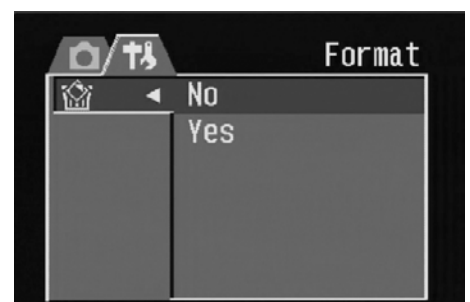
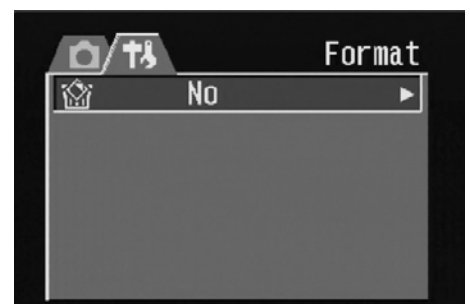

5 File Names & Printing

Folder Names

The digital camera automatically creates a directory of folders in the internal memory or SD card that it uses to organize photos, video clips, and other information.

10030101

Date: 2003, Jan 1st

Folder Number

Folder Example:

- i. Folder numbers start from 100.
- ii. Each folder holds up to 9999 files. If a photo is taken when the folder with the highest folder number contains a picture file number equal to or greater than 9999, the camera creates a new folder by adding one to the current folder number. For example, if the current folder is "10030101", the new folder is named "10130101").
- iii. The maximum folder number is 999.
- iv. If the highest folder number is 999 and highest file number exceeds 9999, the camera will display the warning message "Folder Cannot Be Created".
- v. If "Folder Cannot Be Created" appears, try formatting the memory or plug in a new memory card. Set the function "File No. Reset" to "On", otherwise the next time the camera is powered on, it will take only one picture because folder number = 999 and file number = 9999.

File Names

The camera automatically assigns a file name to each photo and video clip captured. File names start with "DSCI_" and are followed by a four-digit number that increases in sequence.

File Example:

- i. Each folder holds up to 9999 pictures. If a photo is taken when the current folder contains a file numbered 9999, the DSC creates a new folder and stores the new image in the new folder.
- ii. File numbering starts from 0001 when a new folder is created.

DPOF Print Settings

The Digital Print Order Format (DPOF) settings allow you to select photos stored on an SD card that you want to print. You can also set the number of copies to print. This function is convenient when used with a printer or commercial printing service that supports DPOF printing.

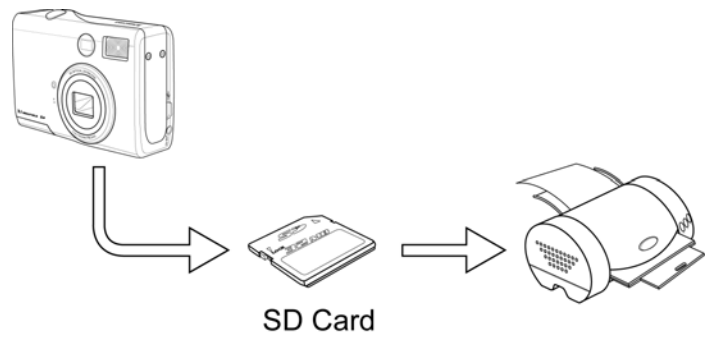

Print Order Setting

1. Set the camera to Playback mode.
2. Press the LEFT or RIGHT buttons to select the file you want to print.
3. Press the MENU button to display the toolbar.
4. Press the DOWN button to select DPOF printing.
5. Press the SET button to print the file. You are prompted to select the number of prints.
6. Press the up and down buttons to select the number of prints and then press SET to print the images.

6 Making Connections

Viewing Images on the TV

Images displayed on the camera's LCD screen can also be displayed on a television screen.

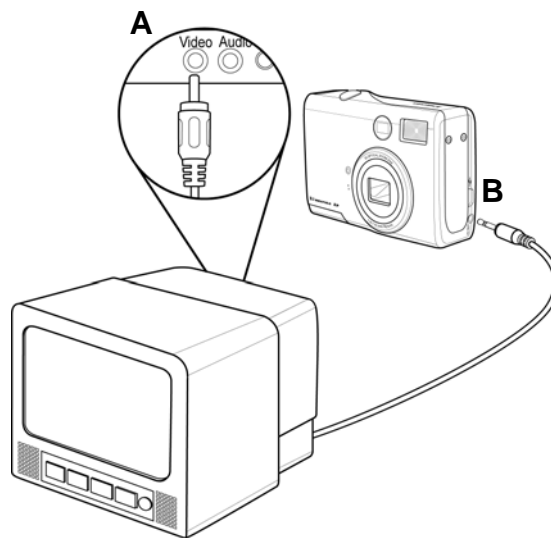

1. Plug the included audio/video cable into the camera TV Out port (**B**). Plug the other end into the TV set Video port (**A**).
2. Set the TV input signal to Video In. Refer to the documentation included with your TV for more information.
3. Everything that would normally appear on the camera's LCD screen, such as photo and video clip playback, slide shows, and image or video capture, appears on the TV.

Selecting the Video Out Signal Mode

The digital camera supports both NTSC and PAL video signal systems. See TV Out Settings section for information on setting the camera's video system to match your region.

Downloading Images to a Computer

There are two ways to download files from the camera's internal memory or SD card to a computer:

- by inserting the SD card into a flash memory card reader
- by connecting the camera to a computer using the included USB cable

Using a Flash Card Memory Reader

1. Eject the SD card from the camera and insert it into an SD card reader that is connected to a computer.

NOTE:

If you are using a PC card reader with a notebook computer, first insert the SD card into a PC card adapter (optional), and then insert the PC card adapter into the computer's PC card slot.

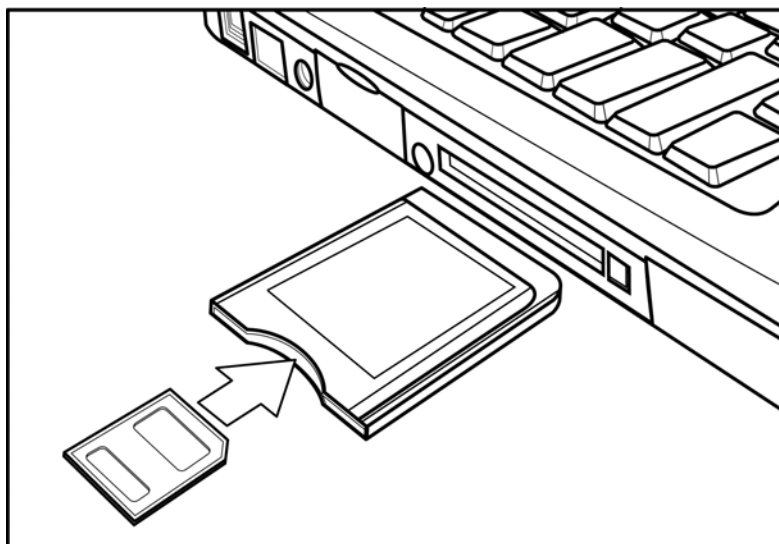

Using an SD card reader connected to a notebook computer.

2. Open My Computer or Windows Explorer and double-click the removable drive icon that represents the SD card.
3. Copy images from the card into a directory of your choice on the computer's hard disk.

Connecting to a Computer Using USB

1. Install the software driver included with the bundled CD-ROM.
2. Connect the supplied USB cable to the computer's USB port (A). Connect the other end of the cable to the USB port on the camera (B).

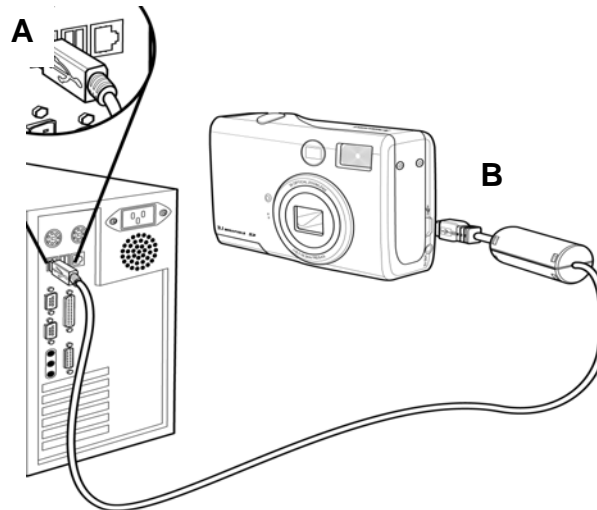

NOTES:

- You don't have to switch off the camera or the computer when the USB connection is made.
- Refer to your computer's manual for information regarding the USB port location.

3. Make sure the camera is turned on.
4. The LCD screen turns off when the connection to the computer has been successfully completed.

NOTES:

- The camera will remain on if the USB cable is disconnected.
- Windows 98SE: If this is the first time the camera has been connected to the computer, Windows detects the camera as an "Unknown device" and automatically completes the required software installation.

5. Open My Computer or Windows Explorer. A "Removable Disk" appears in the drive list.
6. Double-click the "Removable Disk" icon to view its contents.
7. Files stored on camera are located in the folder named "DCIM".

Understanding Camera Memory

Internal Memory

The digital camera is equipped with internal memory. If an SD card is not installed in the camera, all photos and video clips recorded by the camera will be stored in the internal memory. If an SD card is installed, photos and video clips are stored on the SD card.

Optional SD Memory Card

Photos, video clips, and other information recorded by the camera is stored on the SD card using the Design rule for Camera File system (DCF) protocol. The DCF protocol is designed to accommodate file and data exchange between digital cameras and other devices.

DCF Protocol

The DCF protocol defines the format for image file data as well as the directory structure for the memory card. Photos that are taken by a DCF camera can be viewed on DCF-compatible cameras from other manufacturers.

7 Software Installation

To install the software:

1. Insert the Installation CD into your CD-ROM/DVD-ROM drive.
The disc supports Windows Autoplay mode and starts running automatically.
2. Select the driver and the applications you want to install on your computer, and then click the **OK** button.
3. Follow the instructions on the screen.
You may choose to restart your computer only after installing the driver and the selected applications.

NOTES:

- If the installation program does not start automatically, click **Start > Run**, In the **Open** box, type **d:\startup\setup.exe** (replace **d:** with the drive letter of your CD-ROM/DVD-ROM drive) and then click the **OK** button.

Software Driver

The camera can be used as a mass storage device and can be connected to a TV to view pictures. If you are using Windows 98 SE, you must install the software driver so that your computer can recognize the camera as a mass storage device.

Roxio PhotoSuite 5

Roxio PhotoSuite 5 lets you edit, crop and print the photos you download to your computer from the digital camera. Refer to the application help documentation for information on using the software. To launch this application:

Click **Start > Programs** or **All Programs > Roxio PhotoSuite 5**

Roxio VideoWave Movie Creator

Roxio VideoWave Movie Creator lets you to edit the videos that you download to your computer from the digital camera. Refer to the application help documentation for information on using the software. To launch this application:

Click **Start > Programs** or **All Programs > Roxio VideoWave Movie Creator**

8 Appendix

Troubleshooting

Symptom	Cause	Solution
Camera does not turn on.	<ul style="list-style-type: none"> - The batteries are inserted incorrectly. - The batteries are dead. - The battery compartment door is open. 	<ul style="list-style-type: none"> - Reload the batteries. - Replace with new batteries. - Make sure the battery compartment door is properly closed.
The camera does not take pictures.	<ul style="list-style-type: none"> - The camera is set to Playback mode. - The flash is charging - The memory is full. - The SD card is not formatted correctly. 	<ul style="list-style-type: none"> - Set the camera to Photo mode. - Wait for the flash to charge. - Reformat the SD card. - The card may be defective, use a new card.
Image is not recorded when the shutter button is pressed.	<ul style="list-style-type: none"> - The camera is set to Playback mode. - The flash is charging - Memory is full. 	<ul style="list-style-type: none"> - Set camera to Photo mode. - Wait for flash to charge. - Make space in memory by deleting unwanted images or downloading files to a computer.
The flash doesn't fire.	The Flash mode is set to OFF.	Set the flash to any mode except OFF.
Images are blurry or out of focus	<ul style="list-style-type: none"> - The camera was moving when the image was captured. - The subject was beyond the focal range of the camera. 	<ul style="list-style-type: none"> - Hold the camera steady. - Turn the Macro mode on if the subject is very close. - Turn Macro mode off when shooting distant subjects.
Images are not displayed on the LCD screen.	A memory card with non-EXIF images (recorded with another camera) is loaded.	This camera cannot display non-EXIF images.
Images are not saved in memory.	The camera was turned off before the image was stored in memory.	If the battery low indicator appears on the LCD screen, replace the batteries immediately.
Cannot transfer images to a computer after connecting the USB cable.	The USB driver is not installed.	<ul style="list-style-type: none"> - Install the USB driver before you connect the camera to a computer. - Turn the camera on.
Images do not appear on the television.	<ul style="list-style-type: none"> - The cable is not connected securely. - The TV Out setting is incorrect. 	<ul style="list-style-type: none"> - Use the included video cable to connect the camera to a TV. - Set the video system to the correct setting, NTSC or PAL.

Specifications

Sensor	3.2 megapixels CCD
Lens	Focal length: 5.69 - 16.29mm, 3X zoom, F2.66 - 4.92
Viewfinder	Optical, Real Image
Focus Range	50cm - infinity (10 - 50 cm in Macro Mode)
Still image resolution	2048x1536, 1600x1200, 1024x768, 640x480
Video Resolution	320x240
Still Image Quality	Fine: 4x compression rate Normal: 8x compression rate
Exposure Meter	Center-weighted average, multi-pattern TTL AE
Exposure Control	Auto and Manual
Exposure Compensation	-2EV to +2EV in 1/3 step
Shutter Control	Mechanical shutter 1/2000 sec - 8 sec
Digital/Optical Zoom	3X optical zoom, 4X digital zoom
Image File format	EXIF 2.2 compatible format (JPEG compression)
White Balance	Auto and manual (5 selectable modes)
Picture Storage	Internal 16 MB NANDgate Flash Memory SD memory card expansion slot
Microphone	Integrated
Sound Feedback	Speaker
Communication Interface	USB 1.1
Self-Timer	10-second delay
TV Out	NTSC/PAL selectable
Power Supply	Battery (AA x 2) DC- in (3.3V, 2A DC adapter)
Weight (without battery)	147 g (5.19 oz)
Dimensions	92 x 62.2 x 31.5 mm (3.6 x 2.45 x 1.24 inches)

Free Manuals Download Website

<http://myh66.com>

<http://usermanuals.us>

<http://www.somanuals.com>

<http://www.4manuals.cc>

<http://www.manual-lib.com>

<http://www.404manual.com>

<http://www.luxmanual.com>

<http://aubethermostatmanual.com>

Golf course search by state

<http://golfingnear.com>

Email search by domain

<http://emailbydomain.com>

Auto manuals search

<http://auto.somanuals.com>

TV manuals search

<http://tv.somanuals.com>