

Contents



CD/MP3 STEREO RADIO

User's Guide



After Sales Support

Now you have purchased a Tevion® product you can rest assured in the knowledge that as well as your 3 year parts and labour warranty you have the added peace of mind of dedicated helplines and web support :

AFTER SALES SUPPORT

UK / N.IRELAND HELPLINE NO 0800 032 5264

REP. IRELAND HELPLINE NO 1800 315 697

WEB SUPPORT www.curtisint.com

MODEL NUMBER: RCD237UKT

- 03 Safety Precautions
- 05 Locations of Controls
- 07 Power Supply
- 08 General Operation
- 09 CD/MP3/USB Player Operation
- 10 Use with a USB Drive
- 11 Maintenance & Safety
- 12 Troubleshooting
- 13 Specifications & Recycling
- 14 Warranty



Helpline No. UK/Northern Ireland 0800 032 5264 Rep. Ireland 1800 315 697
Web Support www.curtisint.com
Model Number: RCD237UKT



SAFETY PRECAUTIONS

Read this instruction and safety manual carefully before use. Keep this manual in a safe place for further reference.

WARNINGS

To reduce the risk of fire or electric shock, do not expose this product to rain or moisture. EXPLANATION OF GRAPHIC SYMOBOLS.

	HARZARD WARNING	
RISK OF ELECTRIC SHOCK DO NOT OPEN		
<p>CAUTION: TO MINIMISE THE RISK OF ELECTRIC SHOCK, NEVER REMOVE THE COVER. THIS PRODUCT CONTAINS NO USER-SERVICEABLE PARTS. ONLY QUALIFIED REPAIR TECHNICIANS SHOULD WORK ON THIS EQUIPMENTS.</p>		

	<p>The lightning symbol inside an equilateral triangle warns the user of the presence inside the product of uninsulated hazardous electric voltages powerful enough to represent an electrocution risk.</p>
	<p>The exclamation mark symbol inside an equilateral triangle warns the user that important operating and servicing (troubleshooting) instructions are contained in the documentation accompanying the product.</p>

HAZARD WARNING: TO REDUCE THE RISK OF FIRE OR ELECTRIC SHOCK, DO NOT EXPOSE THIS PRODUCT TO RAIN OR MOISTURE.

CLASS 1 LASER PRODUCT

<p>CLASS 1 LASER PRODUCT APPAREIL À LASER DE CLASSE 1 PRODUIT LASER DE CLASSE 1</p>	<p>CAUTIONS INVISIBLE LASER RADIATION WHEN OPEN AND INTERLOCKS DEFEATED. AVOID EXPOSURE TO BEAM.</p>
--	---

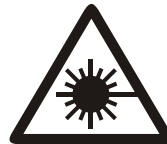

This product contains a low-power emitter.

PRECAUTIONS FOR USE

To ensure safe use of this product, please follow the advice below:

Positioning

- Do not use the product in extremely hot, cold, dusty or damp condition.
- Place the product on a smooth, flat surface.
- Do not obstruct the flow of air through the product. Place it on a well-ventilated position; do not cover with fabric or stand on a rug or carpet.

Power supply

- Before using this product, check that its rated voltage matches your mains power supply voltage.

Safety instructions

- Never pull on the power cord when plugging in or unplugging the product: always use the plug pulling the cord could damage it and create a risk of electric shock.
- Unplug the product from the mains socket if you do not intend to use it for an extended period.
- The On/Off button does not isolate the product from the power supply. To disconnect the product from the mains power supply, you must unplug the power cord.
- This product should only be used in a horizontal position.

Condensation

- Water droplets or condensation may form inside it if moved into a very warm, humid atmosphere.
- Condensation can cause the product to malfunction.
- Leave the set in a warm room for 1 to 2 hours to allow the condensation to evaporate.

In the event of a problem, unplug the power cord and contact a qualified repair technician.

Ventilation precautions

- Never obstruct the product's ventilation holes.

Warning concerning liquids

- Do not allow liquids to splash or spill onto the product, and never stand a liquid-filled container (vase, jar, etc.) on the top of it.

Warning concerning excessive sound levels

- Owing to this product's extremely low noise output and extended dynamic range, the user may be tempted to turn up the volume louder than necessary.
- The sound output may be excessively high, to the point of damaging the product's headphones or loudspeaker. Always keep the volume within

SAFETY PRECAUTIONS

IMPORTANT INFORMATION

- This product is designed for use in moderate climate. Do not use or install this unit where it would be exposed to direct sunlight or in extremely hot temperatures, or near a radiator, stove or appliance that produces heat.
- Do not take this unit into the bathroom, or near a swimming pool. Do not use it where it would be exposed to water, moisture, dripping or splashing.
- No objects filled with liquids, such as vases, placed on the product.
- No naked flame sources, such as lighted candles on the product.
- If water gets inside the unit, Unplug the power cord from the supply socket and consult your dealer.
- Do not handle the power cord with wet hands. To avoid electric shock, NEVER touch any internal parts. Repairs/servicing should be left to qualified service personnel.
- When connecting or disconnecting from the mains supply, hold the plug but not the cord. Pulling the cord may damage it and is dangerous.
- Do not drop the unit, spill liquid into it or allow objects to fall in it.
- When plugged in, a very small current will flow. To save electricity and for safe, it is recommended that the product is completely disconnected with the AC mains socket after the unit not used for a long time.
- Consult your nearest dealer when damage, disconnection or contact failure is found with the cord.
- Do not bend the cord sharply, pull or twist it.
- Do not modify the power cord in any manner.
- Do not insert any metallic object in the unit.
- Unplug the power cord when there is the possibility of lighting.
- Mains plug is used as the disconnecting device. It shall remain readily operable and should not be obstructed during intended use.
- To be completely disconnected the apparatus from supply mains, the mains plug of the apparatus shall be disconnected from the mains socket outlet completely.
- In case of malfunction due to electrostatic discharge, just reset the product reconnect of power source may be required to resume normal operation.

POSITIONING THE UNIT

- A minimum distance of 6 INCHES must be kept to provide sufficient ventilation.
- Do not place the product in closed bookcases or racks without proper ventilation.
- Allow adequate ventilation for the unit ventilation. It should not be impeded by covering the ventilation openings with items such as newspapers, table cloths, curtains etc.
- Do not stand it on a thick pile carpet, install it in a thick pile carpet, or install it in a place with inadequate air flow. Place the unit on a flat even surface.
- Do not use the unit in excessively hot, cold, dusty, damp or humid place.
- Condensation may form inside the CD player if the unit is left anywhere warm and damp, or if you move the unit from somewhere cold to a warm room. In this case, let the unit stand for 1-2 hours or gradually increase the room temperature that the unit will be dry before use.
- Do not place it where it could be subject to vibration.
- Do not place it where it could be magnetised by a magnet or speaker. Since there are magnets, do not place tapes as recorded data could be erased.
- When this unit is used near a TV, the TV picture could be distorted. If this happens, move the unit away from the TV. If the situation could not be solved, avoid using the unit when the TV is turned on.
- Keep the CD door closed so the lens is not contaminated by dust. Do not touch the lens.
- Batteries shall not be exposed to excessive heat such as sunshine, fire or the like.
- Warning: excessive sound pressure from earphones and headphones can cause hearing loss.
- Attention should be drawn to the environmental aspects of battery disposal.

SAFETY MECHANISM

- This unit incorporates a safety interlock mechanism that switches the laser beam on and off, when the disc holder is open, the laser beam automatically.

FUNCTIONS AND CONTROLS

Front panel

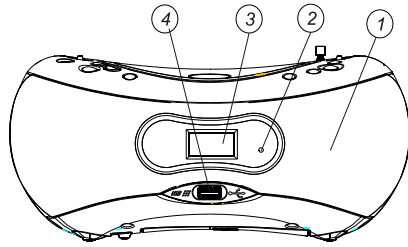

Top panel

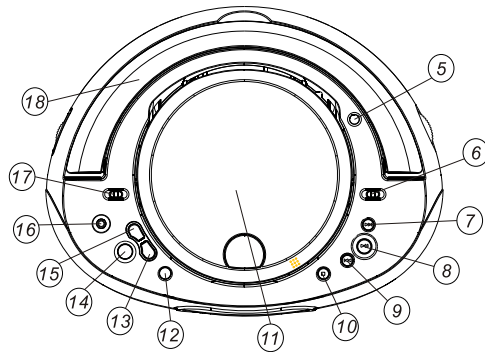

Rear panel

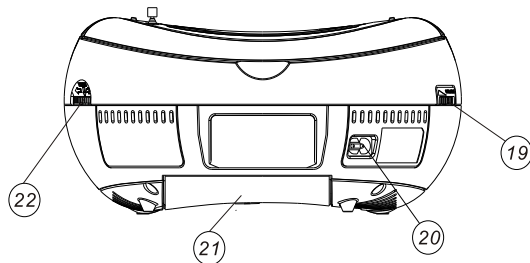

FUNCTIONS AND CONTROLS

FRONT AND TOP PANEL

1. **SPEAKER**
2. **FM STEREO INDICATOR**
- display of FM stereo indications.
3. **DISPLAY**
- display of CD functions.
4. **USB JACK**
5. **TELESCOPIC ANTENNA**
- improvement of FM reception.
6. **BAND SELECTOR (AM•FM•FM ST.)**
- frequency band selection: AM, FM or FM ST.
7. **NEXT**
CD: next tracks.
8. **PLAY/PAUSE**
CD: start or pauses CD playback.
9. **BACK**
CD: return to the previous track.
10. **STOP**
CD: stops CD playback or delete a program.
11. **CD DOOR**
- CD compartment door open/close mark (OPEN/CLOSE).
12. **MODE**
Repeat 1/Repeat Album/Repeat All/Random.
13. **FOLDER DOWN**
14. **PROGRAM**
CD: programming and control of programmed track number.
15. **FOLDER UP**
16. **STEREO HEADPHONE JACK**
- connect for the 3.5mm stereo headphone.
17. **FUNCTION SELECTOR**
- source selection CD/MP3/USB or RADIO and power off.
18. **HANDLE**

REAR PANEL

19. **VOLUME CONTROL**
- sound level control.
20. **AC POWER SUPPLY**
- power supply cord connection.
21. **BATTERY COMPARTMENT**
- opening of the battery compartment.
22. **TUNING KNOB**
- AM/FM/FM ST. stations selector.

POWER SUPPLY

If you would like, the electrical power supply can be used to save the batteries. Make sure that the unit is unplugged from the wall outlet before inserting the batteries.

USING THE DC POWER SUPPLY

Batteries (not included)

Open the battery compartment and insert 8 R14 batteries with respect to the "+" and "-" polarity indications in the compartment.

Important:

When replacing the batteries, make sure you dispose of the old batteries in accordance with applicable regulations. They should be disposed of in a location specifically designated for that purpose so they can be recycled safely and without posing any risk for the environment. Do not burn or bury them.

Incorrect use of the batteries may result in electrolyte leakage having a corrosive effect in the compartment.

- Do not mix different types of batteries: do not use alkaline batteries with saline batteries, for example. only use batteries of the type recommended by the manufacturer.
- Do not mix old and new batteries when inserting new ones.
- If the unit is not to be used for an extended period of time, remove the batteries from the unit.
- Batteries shall not be exposed to excessive heat such as sunshine, fire or the like.
- Warning: excessive sound pressure from earphones and headphones can cause hearing loss.
- NOTE: Batteries should not be disposed of in the normal household waste.

USING THE AC POWER SUPPLY

1. Make sure that the voltage indicated on the rating plate at the rear of the product corresponds to the voltage supplied by your electrical installation. If this is not the case, consult your dealer or service center.
2. Connect the electrical power cable the unit then plug it into the wall outlet. The wall outlet must be located near the product and be easily accessible.
3. To turn power to the apparatus off, unplug the power supply cable from the wall outlet.
4. To protect the unit during violent thunderstorms, unplug the power supply cable from the wall outlet.

GENERAL OPERATION

GENERAL OPERATION

1. Select the source by setting the **FUNCTION SELECTOR** to **CD/MP3/USB**, **OFF** or **RADIO**.
2. Set the desired volume level using the **VOLUME KNOB**.
3. To turn off the unit, set the **FUNCTION SELECTOR** to **OFF**.

RADIO RECEPTION

1. Set the **FUNCTION SELECTOR** to **RADIO**.
 2. Position the **BAND SELECTOR** on the desired band: AM, FM or FM ST.
 3. Turn the **TUNING CONTROL** to search for the desired station.
- NOTE: The FM stereo indicator comes on if the **BAND SELECTOR** is set on FM stereo and you have tuned the radio to an FM stereo station.
4. Adjust **VOLUME CONTROL** for the desired volume level.
 5. When you have finished listening to the radio, position the **FUNCTION SELECTOR** to **OFF** to turn the unit off.

Helpful hints:

To improve radio reception

- To listen to the FM radio, extend the telescopic antenna and orient it for optimum reception. Reduce the length of the antenna if the signal is too strong (if you are very near the transmitter, for example).
- As the unit is equipped with a built-in antenna, the telescopic antenna does not have to be used to listen to AM stations. Move the entire unit to orient the built-in antenna.

STEREO HEADPHONE JACK

Plug stereo headphones (not included), equipped with a 3.5mm mini-plug, into the **PHONES** jack for private listening, without disturbing those around you.

Reduce the **VOLUME** to a low level before putting on the headphones. You can then adjust the **VOLUME** progressively to a comfortable level.

CD/MP3/USB PLAYER OPERATION

CD/MP3 FILE PLAYBACK

The CD player supports audio discs, CD-R, CD-RW, MP3 and USB files. Do not attempt to read CD-ROM, CDi, VCDs, DVDs or data CDs.

Note: Even if this portable radio-CD player is able to read CD-R and CD-RW discs, in addition to conventional compact discs, it is not possible to offer a 100% guarantee that all CD-R/RW discs can be read; playback depends on the quality and condition of the blank discs that you use, among other things. A playback failure does not necessarily indicate that the unit is malfunctioning.

1. Position the **FUNCTION SELECTOR** on **CD/MP3/USB** (the display unit briefly displays --).
 2. To open the CD player door, raise it by the corner marked **OPEN/CLOSE**.
 3. Insert a CD, CD-R, CD-RW or MP3 disc, printed surface facing upwards and gently press the CD player door to close it.
 4. Start playback by pressing **PLAY/PAUSE**.
- Press **PLAY/PAUSE** for 2 seconds to switch from **CD/MP3** to **USB** mode. Press **PLAY/PAUSE** again for 2 seconds to return to **CD/MP3** mode.
5. Press **PLAY/PAUSE** to interrupt or resume playback.
 6. To stop CD playback, press **STOP**.

NOTE: CD playback stops automatically when:

- the CD compartment is opened;
- the radio function is selected;
- the CD/MP3/USB is finished.

SELECTING A DIFFERENT TRACK

During playback, press **NEXT** or **BACK** on the unit to select a track.

- If you have selected a track number in Stop or Pause mode, press **PLAY/PAUSE** to resume playback.
- Briefly press **NEXT** to pass to the next track or press **NEXT** several times until the desired track number appears in the display.
- Briefly press **BACK** to return to the start of the current track.
- Press **BACK** several times to find a previous track.

SELECTING A DIFFERENT FOLDER

- Press **FOLDER UP** for 2 seconds. When the display unit flashes, press **NEXT** or **BACK** to select the desired folder.
- To select the previous files, press **FOLDER DOWN**.

(Comment: the FOLDER UP/DOWN function can only be activated if the disc contains at least 2 files)

SEARCHING FOR A PASSAGE ON A TRACK

1. Press and hold **BACK** or **NEXT** to read the track in fast forward mode at reduced volume.
2. When you have found the desired passage, release the **BACK** or **NEXT** button (normal playback resumes automatically).

MODE

Repeat: playback of the current track continuously.

Repeat all: playback of the entire CD continuously.

Album: playback of selected folder continuously.

Random: playback in random order continuously.

PROGRAMMING OF TRACK NUMBERS

Up to 20 tracks can be programmed in any order. If desired, a given track can be programmed more than once.

1. Press **PROG.**, in the STOP mode. (The program icon and P01 appear on the display)
2. Press **BACK** or **NEXT** to select your desired track. When your selected track number appears on the display. Press **PROG.** once and it will be stored in the memory.
3. Then, the program icon and P02 appear on the display, press **BACK** or **NEXT** to select your desired second track. Press **PROG.** once and it will be stored in the memory.
4. Repeat steps 2 to 3 to select and store all desired tracks in this way.
5. To playback your program, press **PLAY/PAUSE** to start from P01 track.

PROGRAM CHECK

In **STOP** mode, press the **PROG.** button. (the display unit displays the track numbers in the order programmed).

DELETING A PROGRAM

Perform the following operations to delete the memory:

- Open the CD door;
- Select the **RADIO** source;
- Press **STOP** once.

USE WITH A USB DRIVE (NOT INCLUDED)

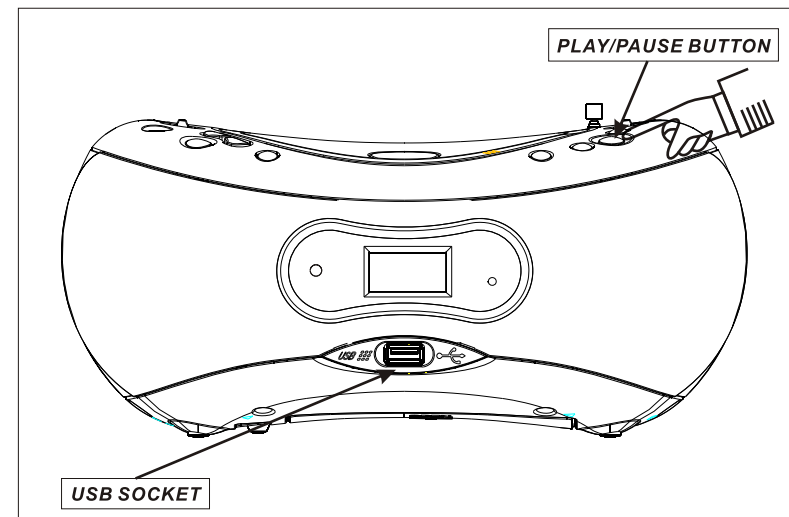

1. Slide the **FUNCTION SELECTOR** to **CD/MP3/USB**.
2. Insert your USB driver into the USB socket.
3. Press and hold **PLAY/PAUSE** for 2 seconds to switch from **CD/MP3** mode to **USB** mode.

The display unit shows:



4. Start playback by pressing **PLAY/PAUSE**.
5. To stop playback, press **STOP**.

Press **PLAY/PAUSE** again for 2 seconds to return to **CD/MP3** mode.

The display unit shows:

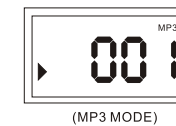
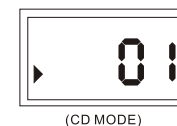

NOTE: Before removing your USB drive, press **STOP** then press and hold **PLAY/PAUSE** for 2 seconds to return to **CD/MP3** mode.

MAINTENANCE & SAFETY

CD PLAYER AND CD HANDLING

OPERATING PRECAUTIONS AND GENERAL MAINTENANCE

- Place the unit on a hard and plane surface to ensure that it does not tip over.
- Do not expose the unit, batteries or the CDs to humidity, rain, sand or an excessive source of heat from a heater or direct sunlight.
- Do not open the apparatus. A gap of at least 15 cm must be kept between the ventilation openings and the surrounding surfaces in order to ensure sufficient ventilation and avoid all accumulation of heat.
- The unit's mechanism features self-lubricating bearings and thus do not require grease or lubrication.
- Use a soft and dry cloth to clean the unit. Never use cleaning agents containing alcohol, ammonia, benzene or abrasives, which may damage the cabinet.



CLEANING CDs

- Use a soft and clean cloth to wipe away fingerprints or dust from the surface of the disc.
- Wipe in a straight motion from the center to the edge. Very small dust particles and slight smudges have absolutely no effect on the sound quality.
- Never use chemical products such as sprays for conventional (vinyl) records, anti-static aerosols, benzene or thinners to clean your CDs.
- To reduce the risk of scratches, always store CDs in their case when not used.
- Do not expose CDs to direct sunlight, high humidity or excessively high temperatures for long periods of time.
- Never write or affix labels to the CD's surfaces.

CLEANING THE LENS

If the lens is dirty, the sound may skip and the CD may not be read correctly. Open the CD door and clean the lens as follows:

- Unplug the power cord.
- Dust or dry particles:
Blow on the lens several times using a camera lens brush, then wipe it gently with the brush to remove the dust. Then blow again on the lens.
- Fingerprints:
If you are unable to clean the lens with the camera lens brush, use a dry cotton swab to clean the surface, from the center to the outside.

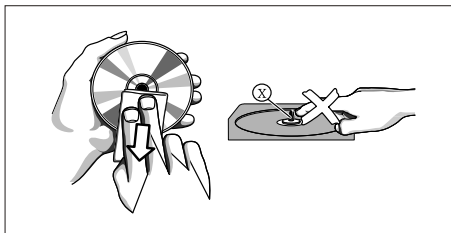

TROUBLESHOOTING

TROUBLESHOOTING

If a problem occurs, check the points below before taking the apparatus in for repair.

Do not open the apparatus to prevent all risk of electrocution.

If you are unable to solve a problem using the indications provided below, contact your dealer or after-sales service center.

WARNING: Under no circumstances should you attempt to repair the apparatus yourself; doing so will void the guarantee.

- Problem
- Solution

NO SOUND/ELECTRIC POWER

- The volume is not properly set.
- Adjust the volume.

- The electrical power cord is not plugged in correctly.
- Check the power cord connections.

- The batteries are dead/not inserted correctly.
- Check the installation and charge of the batteries.

THE DISPLAY UNIT DOES NOT FUNCTION CORRECTLY/THE BUTTONS DO NOT FUNCTION

- Electrostatic discharge.
- Turn the unit off and disconnect it. Plug it back in a few seconds later.

NO INFORMATION DISPLAYED ABOUT THE DISC

- No CD in the player.
- Insert a CD, CD-R or CD-RW in the player.

- The CD is scratched or very dirty.
- Replace/clean CD. See Maintenance.

- The laser lens is covered with condensation.
- Wait until condensation disappears from the lens.

- The CD-R is blank or the disc is not finalized.
- Use a finalized CD-R.

THE CD IS NOT READ

- The CD is scratched or very dirty.
- Replace/clean CD. See Maintenance.

- The laser lens is covered with condensation.
- Wait until condensation disappears from the lens.

THE CD SKIP TRACKS

- The CD is scratched or dirty.
- Replace/clean CD. See Maintenance.

- A program sequence is activated.
- Exit the programming mode(s).

SPECIFICATIONS

Power supply	: AC 230V ~ 50Hz : DC 12V = 8 x UM-2/R14 batteries (not included)
Power consumption	: 14 Watts
Dimensions of unit	: 257(L) x 200(W) x 118(H) mm
Weight	: 1.488 kgs
Frequency range	: AM 540 to 1600KHz : FM 88 to 108MHz
Output power (RMS)	: 2 x 1.2W RMS
Speaker	: 8 Ohms
Headphone	: ø 3.5mm

(The technical characteristics are liable to change without notice)

Recycling

This symbol bears the selective sorting symbol for waste electrical and electronic equipment (WEEE). This means that this product must be handled pursuant to European Directive 2002/96/EC in order to be recycled or dismantled to minimize its impact on the environment.

For further information, please contact your local or regional authorities.

Electronic products not included in the selective sorting process are potentially dangerous for the environment and human health due to the presence of hazardous substances.



Helpline No. UK/Northern Ireland 0800 032 5264 Rep. Ireland 1800 315 697
Web Support www.curtisint.com
Model Number: RCD237UKT

13

TEVION CD/MP3 STEREO RADIO
S O U N D

WARRANTY CARD

Congratulations! You have made an excellent choice with the purchase of this quality product. Our commitment to quality also includes our service. Should you, contrary to expectations, experience defects due to manufacturing faults during private use within 36 months of the date of purchase we shall be liable for warranty in accordance with statutory warranty regulations provided that:

- the device was not put to any use other than the intended
- was not overloaded
- was not used with the wrong accessories
- repairs were not carried out by any other than the authorized workshop

The warranty certificate is only valid in connection with the receipt. Please keep both in a safe place. This warranty does not affect your statutory rights.

This purchase is guaranteed for a period of three years beginning on the day of purchase. Keep your purchase receipt safe as proof of date of purchase. The guarantee can only be extended for the duration of any repair required.

During the warranty period defective devices can be sent freight prepaid to the service address stated on the back cover of this document. We will, at our discretion, either repair or exchange the device in accordance with warranty legislation.

Please enclose the following when sending your product in for repair:

1. Receipt (proof of purchase)
2. This warranty certificate with the fault report form overleaf complete with your name, contact details and fault description.

If the original receipt is not enclosed the repair will be charged in all cases. After the warranty has expired you can still send defective devices for repairs freight prepaid to the address stated below. Quotes as well as repairs after the warranty period are to be paid for in all cases.

Ensure that the product is sent well packed as no responsibility can be accepted for items lost or damaged in transit.

This warranty does not affect your statutory rights.





CD/MP3 STEREO RADIO

FAULT REPORT CARD

Name _____

Address _____

Email _____ Daytime Tel No _____

Model Number _____ RCD237UKT _____

Fault Description _____

In order to deal with your enquiry as quickly and efficiently as possible, we ask you to send your enquiry by e-mail. Do not forget to include your name, address and a daytime telephone number.

Alternatively, you can contact our freephone service hotline on the number below.

CURTIS INTERNATIONAL LTD

UK / N. IRELAND HELPLINE NO 0800 032 5264

REP. IRELAND HELPLINE NO 1800 315 697

WEB SUPPORT www.curtisint.com

Free Manuals Download Website

<http://myh66.com>

<http://usermanuals.us>

<http://www.somanuals.com>

<http://www.4manuals.cc>

<http://www.manual-lib.com>

<http://www.404manual.com>

<http://www.luxmanual.com>

<http://aubethermostatmanual.com>

Golf course search by state

<http://golfingnear.com>

Email search by domain

<http://emailbydomain.com>

Auto manuals search

<http://auto.somanuals.com>

TV manuals search

<http://tv.somanuals.com>