

CURTIS

OWNER'S MANUAL



5.8 GHz Cordless Telephone
Caller ID with Call Waiting
PLEASE READ BEFORE OPERATING THIS EQUIPMENT
Model : TC595

Contents

Safety Instructions	3
HANDSET CONTROLS	5
BASE UNIT Controls	8
Getting Started	9
Belt Clip Installation	10
Cordless Telephone Operation	11
Preparing for Use	11
Receiving Calls	11
Placing Calls	12
Redial Feature	12
Headset Volume Control	13
Using Headset Feature	13
Caller ID System Operation	14
Caller ID System	14
Viewing Caller Information during Incoming Calls	14
Caller ID with Call Waiting	15
Message Waiting	15
One-Touch Voice Mail Dialing	15
Caller List	16
Viewing the Caller List	16
Placing a Call from the Caller List	16
Storing Caller ID Records into the DIRECTORY (PHONE BOOK).....	17
Deleting Caller ID Records	17
Deleting a Single Record in the Caller List	17
Deleting all Records in the Caller List	17
Name and Telephone Number DIRECTORY (PHONE BOOK)	18
Viewing the DIRECTORY (PHONE BOOK)	18
Storing Phone Numbers	18
Telephone Keypad Characters	19
Placing Calls from the DIRECTORY (PHONE BOOK)	20
Editing a Stored Number in the DIRECTORY (PHONE BOOK)	20
Deleting a Stored Number in the DIRECTORY (PHONE BOOK)	21
Deleting all Stored Number in the DIRECTORY (PHONE BOOK)	21
Preferred Calls	22
Blocked Calls	22

Contents

Outgoing Calls	22
Function Settings	23
A. Setting the Ringer Level	24
B. Changing the Language	24
C. Turning the First Ring ON or OFF	25
D. Setting the Time and Date	25
E. Adjusting the Contrast	26
F. Setting the PBX Number	26
G. Changing the Flash Time	26
H. Changing the Pause Time	27
I. Programming One-Touch Voice Mail Dialing	27
J. Deleting Message Waiting Indication	28
K. Setting the Area Code	28
Multi-Handset System Operation	29
Prepare for Use	29
Transfer Call	29
Security System	30
Recharging the BATTERY PACK	31
Changing the BATTERY PACK	31
Problem Solving	32
Technical Information	34
FCC Requirements	35

Safety Instructions

IMPORTANT SAFETY INSTRUCTIONS

To reduce the risk of fire, electric shock and/or injury, always follow these basic safety precautions when using your cordless telephone equipment.

1. Read and understand all instructions.
2. Follow all warnings and instructions marked on the telephone.
3. Do not use this telephone near a bathtub, wash bowl, kitchen sink, or laundry tub, in a Wet basement, near a swimming pool, or anywhere else where there is water.
4. Avoid using a telephone (other than a cordless type) during an electrical storm. There may be a remote risk of electric shock from lightning.
5. Do not use the telephone to report a gas leak in the vicinity of the leak.
6. Use only the power cord and BATTERY PACK indicated in the Owner's Manual. Do not dispose of the BATTERY PACK in a fire. The BATTERY PACK may explode. Check with local codes for possible special disposal instructions.
7. Operate this telephone using the electrical voltage as stated on the **BASE UNIT** or in the Owner's Manual. If you are not sure of the voltage in your home, consult your dealer or local power company.
8. Unplug this telephone from the wall outlet before cleaning or replacing the BATTERY PACK. Do not use liquid cleaners or aerosol cleaners on the telephone. Use a damp cloth for cleaning.
9. Place this telephone on a stable surface. Serious damage and/or injury may result if the telephone falls.
10. Do not cover the slots and openings on this telephone. This telephone should never be placed near or over a radiator or heat register. This telephone should not be placed in a built-in installation unless proper ventilation is provided.
11. Do not place anything on the power cord. Install the telephone where no one will step or trip on the cord.
12. Do not overload wall outlets or extension cords as this can increase the risk of fire or electric shock.
13. Never push any objects through the slots in the telephone. They could touch dangerous voltage points or short out parts that could result in a risk of fire or electric shock. Never spill liquid of any kind on the telephone.
14. To reduce the risk of electric shock, do not take this telephone apart. If service or repair work is required on this telephone, take it to a qualified service representative. Opening or removing covers may expose you to dangerous voltage or other risks. Incorrect reassembly can cause electric shock when the appliance is subsequently used.
15. Unplug this telephone from the wall outlet and consult a qualified service representative in any of the following situations.
 - A. When the power supply cord is frayed or damaged.
 - B. If liquid has been spilled into the telephone.
 - C. If the telephone has been exposed to rain or water.

Safety Instructions

- D. If the telephone does not operate normally by following the operating instructions. Adjust only those controls that are covered by the operating instructions. Improper adjustment may require extensive work by a qualified technician to restore the telephone to normal operation.
- E. If the telephone has been dropped or the case has been damaged.
- F. If the telephone exhibits a distinct change in performance.
- 16. Never install telephone wiring during a lightning storm.
- 17. Never install telephone jacks in wet locations unless the jack is specifically designed for wet locations.
- 18. Never touch uninsulated telephone wires or terminals unless the telephone line has been disconnected at the network interface.
- 19. Use caution when installing or modifying telephone lines.

Battery Safety

CAUTION:

Danger of explosion if BATTERY PACK is incorrectly replaced. Replace only with the same or equivalent type. To reduce the risk of fire or personal injury, read and follow these instructions:

1. Use only the following type and size of BATTERY PACK:
3.6VDC, 600mAh Rechargeable Ni-MH BATTERY PACK
2. Do not dispose of the BATTERY PACK in a fire. It may explode. Check with local codes for possible special disposal instructions.
3. Do not open or mutilate the BATTERY PACK. Released electrolyte from a BATTERY PACK is corrosive and may cause damage to the eyes or skin. Electrolyte may be toxic if swallowed.
4. Exercise care in handling the BATTERY PACK to prevent shorting the BATTERY PACK with conductive materials such as rings, bracelets and keys. The BATTERY PACK or conductor may overheat and cause burns.
5. Charge the BATTERY PACK provided with (or identified for use with) this telephone only in accordance with the instructions and limitations specified in this manual.
6. Observe proper polarity orientation between the BATTERY PACK and BATTERY CHARGER.

SAVE THESE INSTRUCTIONS

ATTENTION:

The telephone that you have purchased contains a rechargeable BATTERY PACK. The BATTERY PACK is recyclable. At the end of its useful life, under various state and local laws, it may be illegal to dispose of this BATTERY PACK into the municipal waste stream. Check with your local solid waste officials for details in your area for recycling options or proper disposal.

HANDSET Controls

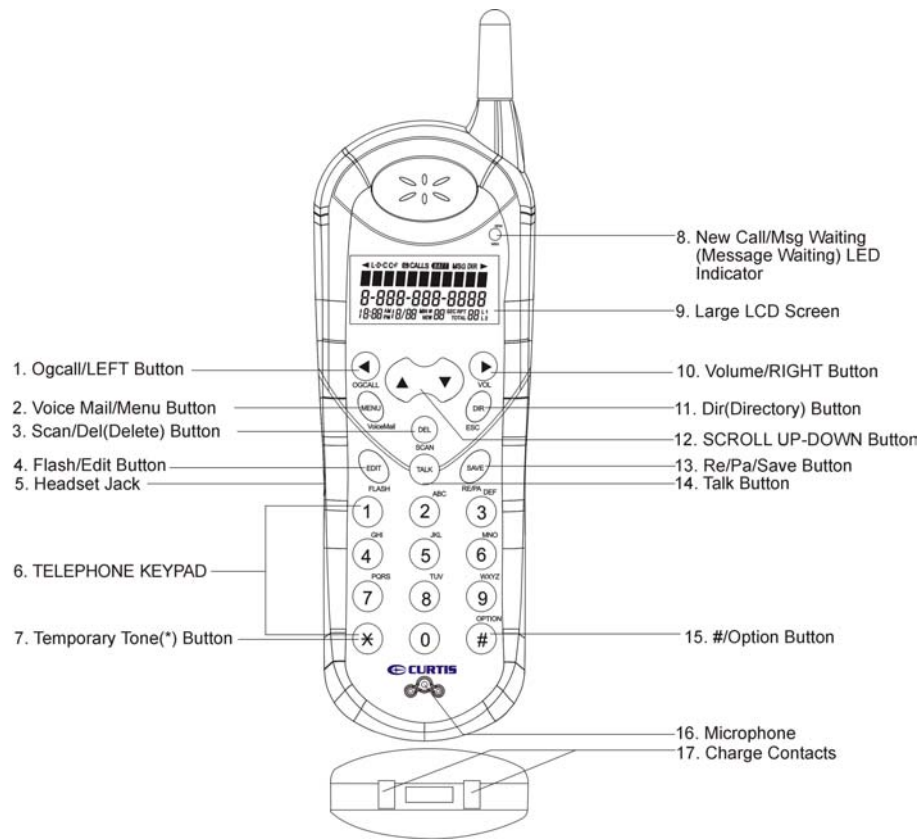

HANDSET Controls

1. **OGCall (Outgoing call) button (◀):** Press and to view the last outgoing call number(see page 22 for detail)
2. **Voice Mail/Menu (Manual) Button:** (Voice Mail) Press to automatically dial the Voice Mail Post Code in your area to access your Voice Mail message. (Menu)Press to access the special functions operation in STANDBY mode. (For special functions see pages 23~28.)
3. **Scan/Del (Delete) Button:** (Scan) Press to change the operating channel when you hear interference. (Del) Press to delete items or individual characters.
4. **Flash/Edit Button:** (Flash) Press to answer a call if you have Call Waiting. (Edit) Press to edit listed items.
5. **HEADSET JACK:** For connecting your headset plug to enjoy hands-free communication. (See page 13 for detail.)
6. **TELEPHONE KEYPAD Buttons:** Allows you to make a call depending on pressed button. (For TELEPHONE KEYPAD characters, see page 19.).
7. **Temporary Tone (*) Button:** Press to temporarily change the DIALING mode from PULSE to TONE for Rotary Service Users. (Press once before entering numbers to access the answering system or electronic banking services, etc.).
8. **New Call/Msg Waiting (Message Waiting) LED Indicator:** (New Call) Red LED blinks to indicate that you have a new Caller ID call stored in memory. (Message Waiting) Green LED blinks when receiving a Message Waiting signal, if you have subscribed to a Voice Mail message service from your local telephone company. (See page 15.).
9. **Large LCD Screen:** Shows call information, phone status, prompts and DIRECTORY (PHONE BOOK) items.
10. **Vol (Volume) button(▶):** During TALK mode, press to adjust the receiver volume to a comfortable listening level. (see page 13 for detail)
11. **Dir (Directory)/ESC (Escape) Button:** (Dir) Press to access names and numbers stored in the DIRECTORY (PHONE BOOK) (See pages 18 to 22 for details.).(Esc) Press to cancel the ongoing operation and return to STANDBY mode.
12. **SCROLL UP ▲ - DOWN ▼ Button:** Press to move around the large LCD Screen.
Trans (Transfer call) button(▲): Press to transfer a call from this Handset to another enrolled in the system (see page 29 for detail)
13. **Re (Redial)/Pa (Pause)/Save Button:** (Re) Press to redial the last number you dialed.
(Pa) Press to insert a pause while dialing. (You will need the **Re/Pa/Save** button to dial numbers which use an alternative Long Distance Access Code.) (Sa) Press and hold down to save the changes on the listed items.
14. **Talk Button:** Press to answer an incoming call or to place a call. Press to end a call.

15. **Option (#) Button:** (Option) Press to change the displayed telephone number into 7, 10, or 11 digit DIALING mode during Caller ID callback.
16. **Microphone:**
17. **CHARGE CONTACTS:** For charging the BATTERY PACK inside the **HANDSET**. We recommend cleaning the CHARGE CONTACTS periodically with a damp cloth.

BASE UNIT Controls

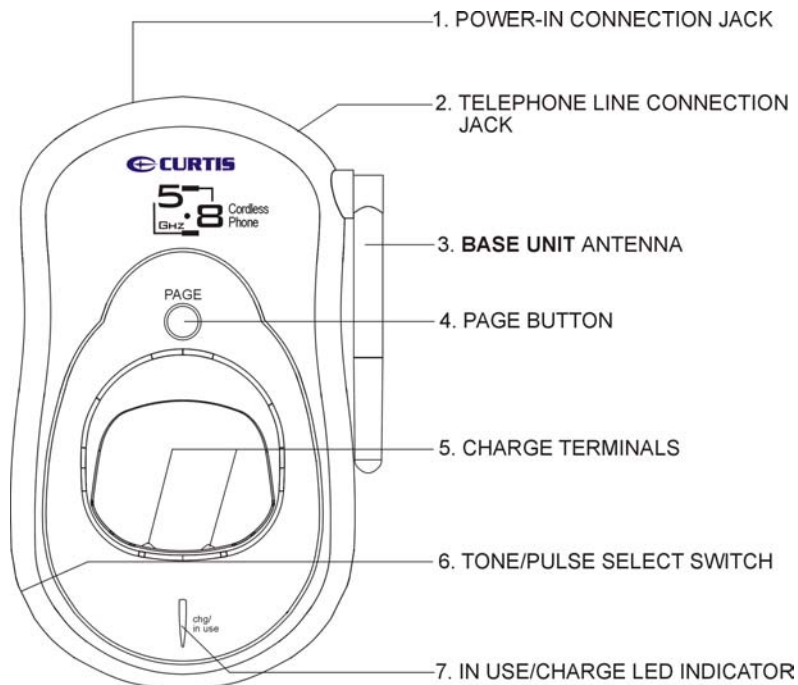

1. **POWER-IN CONNECTION JACK**
2. **TELEPHONE LINE CONNECTION JACK**
3. **BASE UNIT ANTENNA**
4. **PAGE Button:** Press to page the **HANDSETS**.
5. **CHARGE TERMINALS:** For charging the **HANDSET BATTERY PACK**. For best performance, clean the **CHARGE TERMINALS** periodically with a damp cloth.
6. **TONE/PULSE Select Switch**
7. **IN USE/CHARGE LED Indicator:** (IN USE) Lights up to indicate that the **HANDSET** is in TALK mode. (CHARGE) Lights up when the **HANDSET** is placed on the **BASE UNIT** for charging.

Getting Started

Connecting Your Phone

This section is a reference guide to the basic functions and operations of your cordless telephone. For more detailed descriptions of the operations and features of this telephone, refer to the Contents on page 1.

1. Carefully remove your cordless telephone from its shipping carton. If there is any visible damage, do not attempt to operate this equipment. Return it to the place of purchase.
2. Check to be sure you have all items that come with this cordless telephone system. You should have a **HANDSET**, **BASE UNIT**, **AC ADAPTOR**, **BATTERY PACK**, **TELEPHONE LINE CORD**, **BELT CLIP** and **Owner's Manual**.

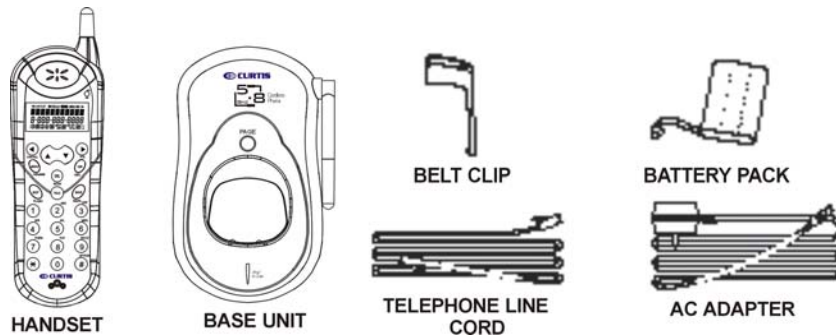

3. Insert the small plug on the end of the **AC ADAPTOR** into the **POWER-IN CONNECTION JACK** at the bottom of the **BASE UNIT**.
4. Plug the **AC ADAPTOR** into a 120V AC wall outlet.

USE ONLY WITH CLASS 2 POWER SOURCE
9V DC, 300mA for the BASE UNIT
9V DC, 100mA for the CHARGER UNIT

5. Insert one plug of the **TELEPHONE LINE CORD** into the house **TELEPHONE JACK** and the other end into the **TELEPHONE LINE CONNECTION JACK** at the bottom of the **BASE UNIT**. (If you have an older 4-prong **TELEPHONE JACK**, you will need an **RJ-11C TELEPHONE JACK ADAPTOR**. This adaptor is available at the same place you purchased your telephone.)
6. We recommend not placing this unit next to appliances. Doing so may cause interference.

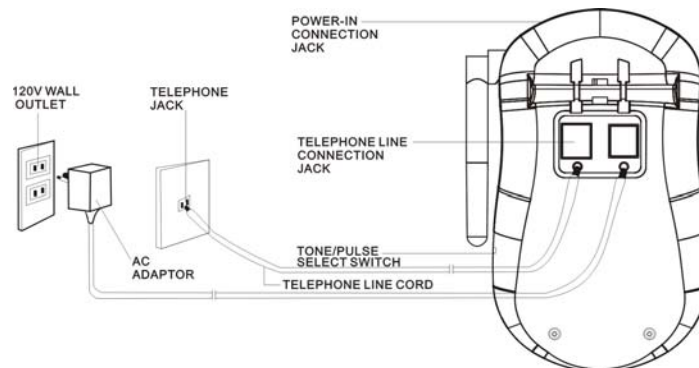

Getting Started

7. Install the **HANDSET BATTERY PACK** by plugging it into the **BATTERY CONNECTOR** inside the **BATTERY COMPARTMENT**.
8. Place the **BATTERY PACK** inside the **BATTERY COMPARTMENT**.
9. Slide the **HANDSET BATTERY COMPARTMENT COVER** firmly into place in its closed position.
10. **IMPORTANT: Before initial use, charges the HANDSET for 12 hours. Place the HANDSET on the BASE UNIT or CHARGER UNIT with TELEPHONE KEYPAD face up, and make sure that the CHARGER UNIT LED indicator lights up.**
11. **TONE/PULSE Select Switch:**
 - A. If your home is equipped with a tone dialing system, set the **TONE/PULSE Select Switch** to the **TONE** position.
 - B. If you have a rotary dialing system, set the **TONE/PULSE Select Switch** to the **PULSE** position.
 - C. If you are not sure which system you have, set the **TONE/PULSE Select Switch** to the **TONE** position. Press the **Talk** button on the **HANDSET** and make a call. If the call connects, leave the switch as is; otherwise set to the **PULSE** position.
12. Set the date and time on the **HANDSET**. (See page 25 for details.)

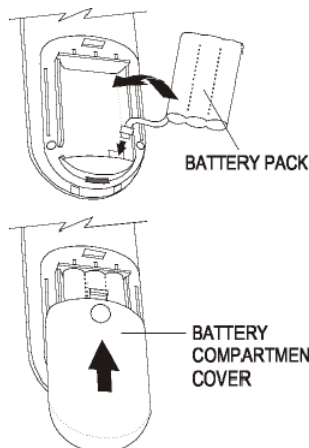

Belt Clip Installation

With the back of the **HANDSET** facing up, insert one side of the **BELT CLIP HOOK** into the matching slot at the top side of the **HANDSET**. Press down on the opposite side of the **BELT CLIP** until the other hook locks into the slot on the side of the **HANDSET**.

CAUTION: The cordless telephone operates at a frequency that causes interference to nearby TVs and VCRs or Microwave; the base phone should not be placed near, or on top of a TV, VCR or Microwave. If interference is experienced, moving the cordless telephone farther away from the TV/VCR/Microwave will often reduce or eliminate the interference.

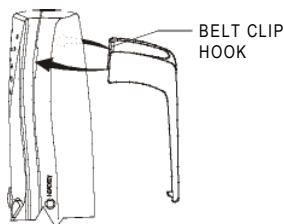

Cordless Telephone Operation

Preparing for Use

Before you can use your cordless telephone, you must charge the **HANDSET** for 12 hours. Failure to do so will require recharging of the **BATTERY PACK** more often.

1. Place the **HANDSET** on the **BASE UNIT/CHARGER UNIT** for 12 hours.
2. After 12 hours, remove the **HANDSET** from the **BASE UNIT/CHARGER UNIT**.

Before you can use your cordless telephone, you must charge the HANDSET for 12 hours. Failure to do so will require more frequent charging of the BATTERY PACK.

NOTE: Depending on the frequency of use, once the **HANDSET** is fully charged, it remains functional for approximately 4 hours of continuous use and approximately 4 days when the **HANDSET** is off the **BASE UNIT** or **CHARGER UNIT** in **STANDBY** mode.

If you have a more than one **HANDSET**, please see page 29 for multi-**HANDSET** system for preparing.

Receiving Calls

1. When the phone rings, the LCD Screen will show "RING..." If you have Caller ID, the LCD Screen will show the Caller ID information after the first ring.
2. With the **HANDSET** off the **BASE UNIT/CHARGER UNIT**, press the **Talk** button. Start your conversation. The Call Timer starts to count.
3. To end your conversation, either press the **Talk** button or place the **HANDSET** on the **BASE UNIT**. If you place the **HANDSET** on the **BASE UNIT CHARGE CRADLE**, you activate the **AUTOMATIC STANDBY** feature.

NOTE: The Call Timer will start to count once you press the **Talk** button.

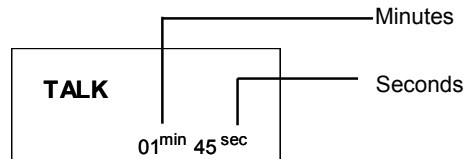

Call Timer Display

NOTE: While the 5.8GHz frequency is inherently clearer, we suggest that you do not use this phone within 20 feet of a working microwave. The microwave produces frequencies in this range which may cause interference. This interference is normal for all 5.8 GHz phones and should not be considered a product defect.

Cordless Telephone Operation

Placing Calls

1. Press the **Talk** button, the Call Timer starts to count.
2. Wait until you hear a dial tone and then dial the phone number.
3. When you have finished your call, press the **Talk** button again or place the **HANDSET** on the **BASE UNIT**.

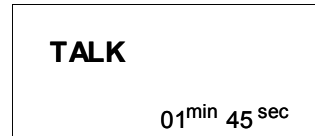

OR

1. Dial the phone number.
2. Press the **Talk** button. The number displayed will be dialed.
3. When you have finished with your call, press the **Talk** button again or place the **HANDSET** on the **BASE UNIT**.



Redial Feature

1. If you get a busy tone, press the **Talk** button or place the **HANDSET** on the **BASE UNIT** to hang up.
2. Later, press the **Talk** button again.
3. Listen for a dial tone.
4. Press the **Re/Pa/Save** button. This will automatically redial the last telephone number you called.
5. When you have finished with your call, press the **Talk** button again or place the **HANDSET** on the **BASE UNIT**.

NOTE:

*If you are too far away from the **BASE UNIT**, the **HANDSET** emits "beep" sounds to warn you that the background noise level is too high for proper communication between the **HANDSET** and the **BASE UNIT**. When you hear this sound, you should move closer to the **BASE UNIT** to reduce the noise level. Otherwise, the call will automatically cut off.*

Cordless Telephone Operation

HANDSET Volume Control

1. To adjust the **HANDSET** receiver volume level while having a conversation, press the **Vol(Volume)** button (▶) button. The LCD Screen will display "VOLUME"
2. Press the **SCROLL UP** ▲ or **DOWN** ▼ button to select the desired setting of Low, Medium, High or Maximum.
3. After volume setting, press vol (▶) button or **Esc** button to the **TALK** mode.

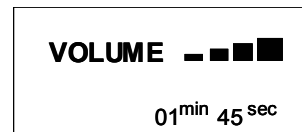
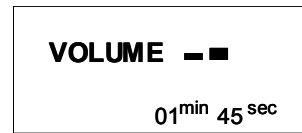

Using the Headset Feature

Your telephone can utilize a headset (not included) to be connected to your **HANDSET** for you to enjoy hands-free communication.

Insert the small plug on the end of the headset into the **HEADSET JACK** at the left side of the **HANDSET**. Follow the procedures discussed in "Receiving Calls" and "Placing Calls" to receive and place a call.

NOTE:

*When you plug the headset plug into the **HEADSET JACK** it automatically mutes the **MICROPHONE** and **SPEAKER** of the **HANDSET**. Unplug the headset to return the **HANDSET** to normal use.*

Headsets are available at most retail outlets that sell telephone equipment. The **HEADSET JACK** is compatible with 2.5 mm headset plugs only.

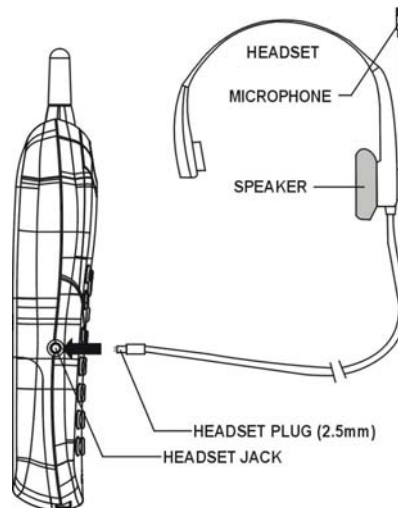

Caller ID System Operation

Caller ID System

This telephone automatically displays an incoming caller's name and telephone number together with the date and time of the call. It records up to 50 calls and stores the data in Memory.

IMPORTANT: You must subscribe to the Caller ID service from your local telephone company to utilize this feature.

Viewing Caller Information During Incoming Calls

1. When there is an incoming call, the name and the telephone number of the caller will automatically appear after the first ring. Press the SHIFT LEFT ◀ or RIGHT ▶ button to view a name or number with more than 11 characters (as indicated by the arrows in the top line of the display).

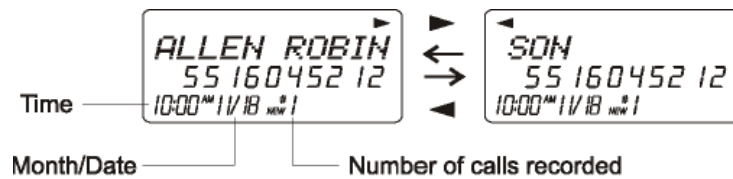

OR

Caller's telephone number and "UNKNOWN" will appear if the caller's name is not available.

UNKNOWN
551 1604 5212
10:11 AM 10/18 NEW1 Total 1

OR

Caller's telephone number and "UNKNOWN" will appear when Caller ID information is not available. The origin of the call does not support the Caller ID system (including international calls).

OR

"DATA ERROR" will appear when the Caller ID information was received incorrectly or only part of the data was received.

NOTE: When an error is received, none of the data from this call is saved in memory.

OR

"PRIVATE" or "OUT OF AREA" will appear if the caller's name and/or telephone number is blocked.

PRIVATE
-----P-----
10:11 AM 10/18 NEW1 Total 1

OR

LCD MSG Icon will appear when a Voice Mail Message has been received and is stored by the Message Waiting service provided by the telephone company.

OUT OF AREA
-----0-----
10:11 AM 10/18 NEW1 Total 1

Caller ID System Operation

Caller ID with Call Waiting

When you subscribe to Call Waiting service from your local telephone company, this telephone will display the name and number of the second caller while you are having a phone conversation with the first caller.

When a new call comes in while you are talking, you will hear a notification beep from the **HANDSET** and the volume is momentarily muted. The new caller's name and phone number, if available, appears on the display.

1. When you receive a "Call Waiting" call and you want to connect the call, press the **Flash/Edit** button and start talking with the second caller. The active call will be placed on hold.
2. Press the **Flash/Edit** button to alternate between calls.
3. Press the **Talk** button or place the **HANDSET** on the **BASE UNIT** to end the call.

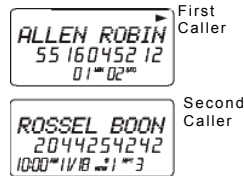

"MSG" (Message Waiting)

The Message Waiting LED indicator will blink when there is a message for you from your telephone company if you have subscribed to Voice Mail message service and if you have requested Visual Message Indication from your local telephone company. (To remove the MSG WAITING indicator, see page 28.)



Note: This function requires voice mail subscription from the local telephone company. Furthermore, the local phone company must provide a type of voice mail signaling called "FSK" (Frequency Shift Key). Not all telephone companies have the visual message waiting feature available. Please contact your local telephone company to check if this is available in your area.

One-Touch Voice Mail Dialing

When the setting is programmed in the Functions menu (see "Programming One-Touch Voice Mail Dialing" on page 27) you can dial out a programmed number at the touch of a button. This feature is specifically designed to easily check voice mail when you have that service through your local telephone company.

1. Press the **Talk** button to access the telephone line.
2. Press the **Voice Mail/ Menu** button.
3. The phone will automatically dial the number.

Caller ID System Operation

Caller List

This phone automatically stores the last 50 calls received. It records call information such as caller's name and telephone number together with the date and time of the call. The NEW CALL LED indicator will blink to indicate that you have a new Caller ID call stored in memory.

Viewing the Caller List

1. With the **HANDSET** in STANDBY mode, press the SCROLL UP ▲ or DOWN ▼ button. The LCD Will Display "INCOMING".
2. Press the SCROLL DOWN ▼, any unviewed (new) calls will be displayed first. The most recent call will be displayed. The information on the call will be displayed with the name, number, date, and time that the call was received.
3. To scroll to the next call, press the SCROLL UP ▲ or DOWN ▼ button. Pressing the SCROLL DOWN button ▼ will go through the calls from the last call received to the first Caller ID record. Pressing the SCROLL UP ▲ button will allow you to view the calls from the first call received to the last.
4. Press the SHIFT LEFT ◀ or RIGHT ▶ button to view a name or number with more than 11 characters (as indicated by the arrows in the top line of the display).
5. Press the **Dir/Esc** button to return to STANDBY mode.

INCOMING
NEW¹ Total¹

John Smith
1 - 604 - 555 - 1212
10:11 AM 10/18 2min 15sec

Placing a Call from the Caller List

You can place a call from the Caller List by using the Caller ID CALLBACK feature.

1. Press the SCROLL UP or DOWN button to find the Caller ID record you wish to call back.
2. Press the **#/Option** button to change the displayed number to 7, 10, or 11 digits. The first dialing option displayed is the 11 digits for a long distance call.

Press the **#/Option** button for the second time, the displayed number will change to 7 digits for a local call.

Press the **#/Option** button for the third time, the displayed number will change to 10 digits for a local call with area code.

3. Press the **Talk** button to dial the displayed number.
4. To end a call, either press the **Talk** button or place the **HANDSET** on the **BASE UNIT**.

John Smith
1 - 604 - 555 - 1212
10:11 AM 10/18 NEW¹ Total¹

First press

John Smith
555 - 1212
10:11 AM 10/18 NEW¹ Total¹

Second press

John Smith
604 - 555 - 1212
10:11 AM 10/18 NEW¹ Total¹

Third press

Caller ID System Operation

Storing Caller ID Records into the DIRECTORY (PHONE BOOK)

1. Press the SCROLL UP ▲ or DOWN ▼ button to find the record you wish to store into the DIRECTORY (PHONE BOOK).
2. Press and hold the **Re/Pa/Save** button.
3. The display will show "SAVED."



SAVED

4. If you wish to edit the newly stored number, you can edit it in the DIRECTORY (PHONE BOOK), or press **Flash/Edit** button to edit it (page 20, "Editing a Stored Number"), and press and hold the **Re/Pa/Save** button to save to the DIRECTORY (PHONE BOOK)
5. Press the **Dir/Esc** button to return to STANDBY mode.

Deleting Caller ID Records

When viewing the Caller ID information you can delete a single call record or all of the call records.

Deleting a Single Record

1. Press the SCROLL UP ▲ or DOWN ▼ button to find the record you wish to delete.
2. Press the **Scan/Del** button. The LCD Screen will display "ERASE ITEM?"

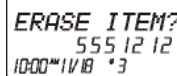

ERASE ITEM?
555 12 12
10:00 AM 1/18 '3

3. To delete the record, press the **Scan/Del** button again, a long beep will be heard. The LCD Screen will show next Call ID item.
4. Press the **Dir/Esc** button to exit the Caller ID list.

Deleting All Records

1. Press the SCROLL UP ▲ or DOWN ▼ button, the LCD displayed "INCOMING".
2. Press and hold the **Scan/Del** button. The LCD Screen will prompt "ERASE ALL?"



CALLS
ERASE ALL?
Total 10

3. To delete all of the Caller ID records, press the **Scan/Del** button. A long beep will be heard and return to STANDBY mode

Caller ID System Operation

Name and Telephone Number DIRECTORY (PHONE BOOK)

This DIRECTORY (PHONE BOOK) lets you scroll through the list to find the person you need for one touch dialing. You can store up to 40 names and telephone numbers in the Memory.

Viewing the DIRECTORY (PHONE BOOK)

1. Press the **Dir/Esc** button.
2. Press the TELEPHONE KEYPAD **2 /ABC** to **9 /WXYZ** button that corresponds to the first letter of a Caller's name (a triple "beep" will sound if no entries are stored under those letters). Press the SCROLL UP or DOWN button to find the record you wish to view.
3. Press the LEFT ◀ or RIGHT ▶ button to view a name or number with more than 11 characters (as indicated by the arrows in the top line of the display).
4. Press the **Dir/Esc** button to exit the DIRECTORY (PHONE BOOK).

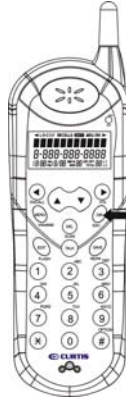

Storing Phone Numbers

1. With the **HANDSET** in STANDBY mode, press the **Dir** button.
2. Press the **Flash/Edit** button to create a new DIRECTORY (PHONE BOOK) entry.
3. Enter the name you wish to store using the TELEPHONE KEYPAD **2/ABC** to **9/WXYZ** buttons to enter the name, (see page 19 for detail) you can store up to 18 letters. To move the cursor to the right, create a space or to enter a new letter, press the RIGHT button ▶.
4. Press the SCROLL DOWN ▼ button, and dial the telephone number you wish to store using the TELEPHONE KEYPAD **0** to **9** buttons. You can store up to 22 digits. Briefly press the **Re/Pa/Save** button to insert a pause into the number.
5. Press and hold the **Re/Pa/Save** button to store the number into memory.

NOTES:

1. If there are no memory locations left in the speed dial DIRECTORY (PHONEBOOK) the LCD Screen will display "MEMORY FULL." To continue with memory programming, you must delete or edit existing speed dial numbers.
2. If you miss-type entering the phone number, you can move through the number and edit it by pressing the SHIFT RIGHT or LEFT button. To delete a character or number inside the cursor, press the **Scan/Del** button.

Caller ID System Operation

Telephone Keypad Characters

The TELEPHONE KEYPAD buttons are used to enter characters when entering names and numbers. Press the appropriate TELEPHONE KEYPAD button to get the following characters. You can store a maximum of 18 characters on the letter icon and a maximum of 22 digits on the number icon.

Keypad Buttons	1st Press	2nd Press	3rd Press	4th Press	5th Press	6th Press	7th Press	8th Press	9th Press
1	Space	1	&	'	()	.	Space	1
2	A	B	C	a	b	c	2	A	B
3	D	E	F	d	e	f	3	D	E
4	G	H	I	g	h	i	4	G	H
5	J	K	L	j	k	l	5	J	K
6	M	N	O	m	n	o	6	M	N
7	P	Q	R	S	p	q	r	s	7
8	T	U	V	t	u	v	8	T	U
9	W	X	Y	Z	w	x	y	z	9
0	0	0	0	0	0	0	0	0	0
*	*	*	*	*	*	*	*	*	*
#	#	#	#	#	#	#	#	#	#

EXAMPLE:

If you want to enter the name "CLEO" with telephone number "6466867," dial this sequence:

1. Press the **Dir** button.
2. Press the **Flash/Edit** button to create a new DIRECTORY (PHONE BOOK) entry.
3. Press the following TELEPHONE KEYPAD buttons to get the desired letters:

TELEPHONE KEYPAD BUTTON	222	555	33	666
LETTER	C	L	E	O

4. Press the **SCROLL DOWN** button to move the cursor to the number icon.
5. Press the TELEPHONE KEYPAD **0** to **9** buttons to get the desired numbers.
6. Press and hold the **Re/Pa/Save** button to store the data in the DIRECTORY (PHONE BOOK) memory.

Caller ID System Operation

Placing Calls from the DIRECTORY (PHONE BOOK)

1. Press the **Dir** button.
2. Press the SCROLL UP or DOWN button to find the record you want to call.

OR

Press a TELEPHONE KEYPAD (**2/ABC** to **9/WXYZ**) that corresponds to the first letter of a Caller's name. Press the SCROLL UP or DOWN button to find the record you wish to call.

3. Press the **Talk** button to dial the displayed number.
4. To end the call, either press the **Talk** button or place the **HANDSET** on the **BASE UNIT**.

Editing a Stored Number in the DIRECTORY (PHONE BOOK)

1. Press the **Dir** button.
2. Press the SCROLL UP or DOWN button to find the record you wish to edit.
3. Press the **Flash/Edit** button. The entry will display with a flashing prompt over the first character.



4. Move the cursor to the letter or number you wish to edit by pressing the SCROLL UP or DOWN , SHIFT RIGHT or LEFT button.

To erase a character or digit, press the **Scan/Del** button.

To add a letter or number, use the TELEPHONE KEYPAD **0** to **9** buttons. Characters or numbers will be inserted in front of the cursor (See page 19 for details.)

5. When the entry is edited as you desire, press and hold the **Re/Pa/Save** button to store the edited record.

Caller ID System Operation

Deleting a Stored Number in the DIRECTORY (PHONE BOOK)

1. Press the **Dir** button, the LCD display "PHONE BOOK".
2. Press the SCROLL UP ▲ or DOWN ▼ button to find the record you wish to delete.
3. Press the **Scan/Del** button. The LCD screen will display "ERASE ITEM?"

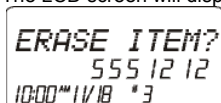

ERASE ITEM?
555 12 12
10:00 AM 11/18 '93

4. To delete the record, press the **Scan/Del** button again.
5. Press the **Dir/Esc** button to return to STANDBY mode.

Deleting All Stored Number in the DIRECTORY (PHONE BOOK)

1. Press the **Dir** button, the LCD display "PHONE BOOK".
2. Press and hold **Scan/Del** button. The LCD screen will display "ERASE ALL?"



ERASE ALL? ^{DIR}
Total 10

3. To delete all of the DIRECTORY records, press the **Scan/Del** button. A long beep will be heard and return to STANDBY mode.

Caller ID System Operation

PREFERRED CALLS

You can assign stored numbers a PREFERRED CALL status. When an incoming call is matched to a stored number designated as preferred, the phone will generate a special ringer sound after the Caller ID information is received.



#ALLEN ROBI
55 160452 12
10:00 AM 10/18 *1 TOTAL 3

When you are saving the name and number into the DIRECTORY (PHONE BOOK), add a “#” symbol at the beginning of the name by pressing the **#/Option** button.

BLOCKED CALLS

You can assign stored numbers a BLOCKED CALL status. When an incoming call is matched to a stored number designated as blocked, the phone will not ring after the Caller ID information is received.



*ALLEN ROBI
55 160452 12
10:00 AM 10/18 *1 TOTAL 3

When you are saving the name and number into the DIRECTORY (PHONE BOOK), add an “*” symbol at the beginning of the name by pressing the * button.

OUTGOING CALLS

This telephone remembers the last 20 OUTGOING CALLS. The time, date, and the duration of the call are recorded.

1. With the **HANDSET** in STANDBY mode, press the SHIFT LEFT ◀ button. The LCD Screen will display “OUTGOING”, and the total numbers of outgoing calls.
2. Pressing the SCROLL DOWN ▼ button will go through the calls from the last to the latest OUTGOING CALL record. Pressing the SCROLL UP ▲ button will allow you to view the calls from the latest call to the last.
3. The called name and the numbers will displayed when the name and the numbers are stored in the DIRECTORY (PHONEBOOK).
4. If the called name and telephone number are not stored in DIRECTORY(PHONEBOOK), the LDC will display “OUTGOING” and the called numbers.
5. To delete the records of OUTGOING, same as delete call ID records. (See page 17 for details.)
6. To make a follow-up call, press the **TALK** button to dial the displayed record



OUTGOING
Total 10



John Smith 10
1 - 604 - 555 - 1212
10:11 AM 10/18 2min 15sec

Caller ID System Operation

Function Settings

You can change the setting on the **HANDSET** in the functions menu. Access the functions menu by pressing the **Voice Mail/Menu** button.

There are 11 settings in the functions menu which can be changed. You can scroll through the function menu in the listed order by pressing the **SCROLL DOWN** button **▼**.

Settings can be accessed by pressing the corresponding **TELEPHONE KEYPAD** button. To edit a setting, press the **Flash/Edit** button, use the **SCROLL UP ▲** or **DOWN ▼** button or digital button 1-0 and # to toggle between the setting options, and then press and hold the **Re/Pa/Save** button to save the changes. Press the **Dir/Esc** button to exit the functions menu.

TELEPHONE KEYPAD	Function
---------------------	----------

①

Ring Hi/Low/Off: Changes the volume of the ringer on the **HANDSET** or turn the ringer OFF.

②

Language: Changes the language that appears on the LCD Screen. Choose between English, French, or Spanish.

③

First Ring On/Off: Turns the first ring of the phone OFF so that it does not ring until Caller ID information has been displayed. Particularly useful when using the **PREFERRED** and **BLOCKED CALL** features or the **PRIVATE** and **UNKNOWN** ring settings.

④

Time Set: Changes the time and date.

⑤

Contrast: Adjusts the brightness of the LCD Screen for optimum viewing.

⑥

PBX Number: Inserts if a "PBX Number" before an outgoing number is dialed. Select the number (0-9) which is required to access an outside line when using a switchboard system, and the phone will automatically dial the PBX number and a pause before any speed dial or Caller ID callback number. Factory setting is "OFF."

⑦

Flash Time: Changes the flash time to accommodate the phone service in your area.

⑧

Pause Time: Changes the number of seconds that a pause lasts when using programmed pauses in your speed dial numbers or after your PBX number.

Caller ID System Operation

TELEPHONE Function KEYPAD

- 9 **Voice Mail:** Programs the one-touch number that enables easy access to the voice mail service provided by your telephone company.
- 0 **MSG Waiting Delete:** Clears current message waiting indication.
- * **Area Code:** Allows the programming of a home Area Code where 7-digit dialing is used for ease of callback and other features (do not program if you use 10-digit dialing to call numbers in your area).

NOTE: At any time during options programming you can quit and the settings that you have changed will be saved. Press the **Dir/Esc** Button to quit the options menu or let the options programming time out by not pressing any TELEPHONE KEYPAD buttons for 20 seconds.

A. Setting the Ringer Level

1. Press the **Voice Mail/Menu** button to enter the menu.
2. Press the **1** button or press the SCROLL DOWN button 1 time go to the RING programming option.
3. Press the **Flash/Edit** button to change the setting. "HI" will begin flashing.

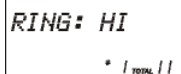

RING: HI
* 1 TOTAL 11

3. Press the SCROLL UP or DOWN button or number 1-3 to select between HI, LOW, and OFF.
4. When the desired setting is displayed, press and hold the **Re/Pa/Save** button to save the setting. A long "beep" will sound to confirm the setting has been saved.
5. Continue with programming or press the **Dir/Esc** button to return to STANDBY mode.

B. Changing the Language

1. Press the **Voice Mail/Menu** button to enter the menu.
2. Press the **2** button or press the SCROLL DOWN button 2 time to go to the LANGUAGE programming option.

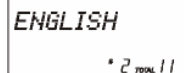

ENGLISH
* 2 TOTAL 11

3. Press the **Flash/Edit** button to change the setting. "ENGLISH" will begin flashing.
4. Press the SCROLL UP or DOWN button or number 1-3 to select between ENGLISH, FRANCAIS, and ESPANOL.
5. When the desired setting is displayed, press and hold the **Re/Pa/Save** button to save the setting. A long "beep" will sound to confirm the setting has been saved.

Caller ID System Operation

6. Continue with programming or press the **Dir/Esc** button to return to STANDBY mode.

C. Turning the FIRST RING ON or OFF

1. Press the **Voice Mail/Menu** button to enter the menu.
2. Press the **3** button or press the SCROLL DOWN button 3 time to go to the FIRST RING programming option.

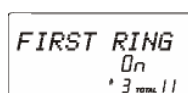

3. Press the **Flash/Edit** button to change the setting. "On" will begin flashing.
4. Press the SCROLL UP or DOWN button or number 1-3 to select between ON and OFF..
5. When the desired setting is displayed, press and hold the **Re/Pa/Save** button to save the setting. A long "beep" will sound to confirm the setting has been saved.
6. Continue with programming or press the **Dir/Esc** button to return to STANDBY mode.

D. Setting the Time and Date

1. Press the **Voice Mail/Menu** button to enter the menu.
2. Press the **4** button or press the SCROLL DOWN button 4 time to go to the TIME set programming option.

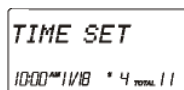

3. Press the **Flash/Edit** button to change the setting. The month will begin flashing.
4. Press the TELEPHONE KEYPAD **0** to **9** button to enter the month. The date will begin flashing.
5. Press the TELEPHONE KEYPAD **0** to **9** button to enter the day. The hour will begin flashing.
6. Press the TELEPHONE KEYPAD **0** to **9** button to enter the hour. The minutes will begin flashing.
7. Press the TELEPHONE KEYPAD **0** to **9** button to enter the minutes. "AM" and "PM" will begin flashing.
8. Press the TELEPHONE KEYPAD **1** button to choose AM or press the **2** button to choose PM.
9. When the desired setting is displayed, press and hold the **Re/Pa/Save** button to save the setting. A long "beep" will sound to confirm the setting has been saved.
10. Continue with programming or press the **Dir/Esc** button to return to STANDBY mode.

Caller ID System Operation

E. Adjusting the Contrast

1. Press the **Voice Mail/Menu** button to enter the menu.
2. Press the **5** button or press the SCROLL DOWN button 5 time to go to the CONTRAST programming option.



3. Press the **Flash/Edit** button to change the setting. "4" will begin flashing.
4. Press the SCROLL UP or DOWN button or number 1-8 to select from 1 to 8 levels of contrast.
5. When the desired setting is displayed, press and hold the **Re/Pa/Save** button to save the setting. A long "beep" will sound to confirm the setting has been saved.
6. Continue with programming or press the **Dir/Esc** button to return to STANDBY mode.

F. Setting the PBX Number

1. Press the **Voice Mail/Menu** button to enter the menu.
2. Press the **6** button or press the SCROLL DOWN button 6 time to go to the PBX NUMBER programming option.

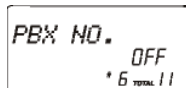

3. Press the **Flash/Edit** button to change the setting. "OFF" will begin flashing.
4. Press the SCROLL UP or DOWN button or number * and 0-9 to customize the digit to match your PBX system. When not connected to a PBX, the phone will only function normally when set to "OFF."
5. When the desired setting is displayed, press and hold the **Re/Pa/Save** button to save the setting. A long "beep" will sound to confirm the setting has been saved.
6. Continue with programming or press the **Dir/Esc** button to return to STANDBY mode.

G. Changing the Flash Time

1. Press the **Voice Mail/Menu** button to enter the menu.
2. Press the **7** button or press the SCROLL DOWN button 7 time to go to the FLASH TIME programming option.

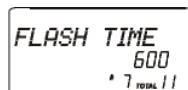

3. Press the **Flash/Edit** button to change the setting. "600" will begin flashing.
4. Press the SCROLL UP or DOWN button or number 1-9 to select the desired FLASH TIME.

Caller ID System Operation

5. When the desired setting is displayed, press and hold the **Re/Pa/Save** button to save the setting. A long “beep” will sound to confirm the setting has been saved.
6. Continue with programming or press the **Dir/Esc** button to return to STANDBY mode.

NOTE: The standard and default flash time setting is 600 msec. This is the setting you should use to access standard telephone services such as call waiting. This setting is adjustable to allow for PBX and other special uses.

H. Changing the Pause Time

1. Press the **Voice Mail/Menu** button to enter the menu.
2. Press the **8** button or press the SCROLL DOWN button 8 time to go to the PAUSE TIME programming option.

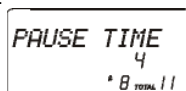

3. Press the **Flash/Edit** button to change the setting. “4” will begin flashing.
4. Press the SCROLL UP or DOWN button or number 0-9 to select the desired time delay.
5. When the desired setting is displayed, press and hold the **Re/Pa/Save** button to save the setting. A long “beep” will sound to confirm the setting has been saved.
6. Continue with programming or press the **Dir/Esc** button to return to STANDBY mode.

I. Programming One-Touch Voice Mail Dialing

1. Press the **Voice Mail/Menu** button to enter the menu.
2. Press the **9** button or press the SCROLL DOWN button 9 time to go to the VOICE MAIL programming option.



3. Press the **Flash/Edit** button to enter the voice mail speed dial number.
4. Press the TELEPHONE KEYPAD **0** to **9** buttons to enter the phone number used to access your voice mail messages (up to 32 digits).
5. When the desired setting is displayed, press and hold the **Re/Pa/Save** button to save the setting. A long “beep” will sound to confirm the setting has been saved.
6. Continue with programming or press the **Dir/Esc** button to return to STANDBY mode.

Caller ID System Operation

J. Deleting Message Waiting Indication

1. Press the **Voice Mail/Menu** button to enter the menu.
2. Press the **0** button or press the SCROLL DOWN button 10 time to go to the MESSAGE WAITING programming option. "MSG WAITING ON" will display in LCD

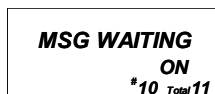

3. Press the **Flash/Edit** button to reset the Message Waiting Indication. "MSG WAITING OFF" will be displayed in LCD and the "OFF" will flashing.
4. Press and hold the **Re/Pa/Save** button to delete the indication. A long "beep" will sound to confirm the setting has been saved.
5. Continue with programming or press the **Dir/Esc** button to return to STANDBY mode.

NOTE: Only Message Waiting in "ON" mode can delete the indication to "OFF" mode, if the mode is "OFF", no need this operation..

K. Setting the Area Code

1. Press the **Voice Mail/Menu** button to enter the menu.
2. Press the * button or press the SCROLL DOWN button 11 time to go to the AREA CODE programming option.



3. Press the **Flash/Edit** button to change the setting. "000" will begin flashing.
4. Press the TELEPHONE KEYPAD **0** to **9** buttons to enter the three digit area code for your phone number.
5. When the desired setting is displayed, press and hold the **Re/Pa/Save** button to save the setting. A long "beep" will sound to confirm the setting has been saved.
6. Press the **Dir/Esc** button to return to STANDBY mode.

NOTE:

Do not use the AREA CODE programming if you are required to dial 10 digits (XXX-XXX-XXXX) to dial a local number.

Multi-HANDSET System Operation

Prepare for use

If you have more than one **HANDSET**, you have a multi-handset system. This system can support up to 5 **HANDSETS** for the **BASE UNIT**. The user can have the option to add more **HANDSET**.

An added **HANDSET** comes with **CHARGER**, **CHARGER AC ADAPTOR**, **BATTERY PACK** and **BELT CLIP**.

NOTE: USE ONLY WITH CLASS 2 POWER SOURCE
9V DC, 300mA for the **BASE UNIT**
9V DC, 100mA for the **CHARGER UNIT**

1. Install the **BATTERY**, **CHARGER AC ADAPTOR** and **BELT CLIP**, please see page 9 for detail.
2. **IMPORTANT: Before initial use, charges the **HANDSET** for 12 hours. Place the **HANDSET** on the **BASE UNIT** or **CHARGER UNIT** with **TELEPHONE KEYPAD face up**, and make sure that the **CHARGER UNIT LED** indicator lights up.**
3. **Register:** place one **HANDSET** on the **BASE UNIT(not the CHARGER UNIT)** for 2 to 5 seconds, a long beep will be heard, and LCD display the ID of this **HANDSET**.
4. place another **HANDSET** on the **BASE UNIT(not the CHARGER UNIT)** for 2 to 5 seconds, a long beep will be heard, and LCD display the ID of this **HANDSET**. Continue this step until all **HANDSET** finish register.
5. You can charge the battery of **HANDSET** by place the **HANDSET** to **BASE UNIT** or **CHARGER UNIT**.

RING : HI
HS - 1
10:11 AM 10/18 NEW0 Total0

RING : HI
HS - 2
10:11 AM 10/18 NEW0 Total0

Transfer Call

1. During a call , press the **UP/Transfer** button. The LCD Screen of the initiating **HANDSET** will display "TRANSFER HS- -".
2. Enter the ID # of the receiving **HANDSET** by pressing the **TELEPHONE KEYPAD "1" to "5"** buttons.
3. The initiating **HANDSET** will return to **STANDBY** mode.
4. The receiving **HANDSET** will receive a special alerting tone and the LCD Screen will display "TRANSFER"
5. The receiving **HANDSET** will answer the call by pressing the **TALK** button.
6. If the receiving **HANDSET** does not answer the call within 30 seconds, the initiating **HANDSET** will receive a Ring Back melody. The initiating **HANDSET** can answer the call by pressing the **TALK** button within 30 seconds, or after 30 seconds the **BASE UNIT** will off the line automatically.

TRANSFER
HS - -
1min 15sec

TRANSFER
HS - 2
10:11 AM 10/18 NEW1 Total1

Security System

Security System

Your cordless telephone uses a digital coding security system to prevent unauthorized use of your telephone line by another nearby cordless telephone. The system has its own identifying signal created by microcomputers in both the **BASE UNIT** and the **HANDSET**.

Security Code

This telephone has an internal security code with 65,536 possible combinations.

Resetting Security Code and Channel Information

Communication between the **HANDSET** and the **BASE UNIT** may not be possible in any of the following situations:

1. Out of range;
2. Battery low;
3. **HANDSET**'s ID is not match with the **BASE**, eg. **HANDSET** is a new one, and it is first time to use with this **BASE**.

To reset, place the **HANDSET** on the **BASE UNIT** for 2 to 5 seconds.

Multi-Channel Access

Your cordless telephone lets you select a channel from the 40 frequencies available to transmit signals between the **BASE UNIT** and the **HANDSET**. When you notice interference from other cordless telephones, change to another channel by pressing the **Scan/Del** button on the **HANDSET**.

Recharging the BATTERY PACK

Recharging the BATTERY PACK

The nickel metal hydride (Ni-MH) BATTERY PACK in the **HANDSET** can be recharged many times using the built-in charger in the **BASE UNIT** or **CHARGER UNIT**.

When the BATT LOW symbol appears on the LCD Screen, a “beep” sound will be heard every 10 seconds. This indicates that the BATTERY PACK needs to be recharged.

Charge the BATTERY PACK at least once every 90 days of non-use to avoid battery failure. When the BATTERY PACK can no longer be charged, replacement of the BATTERY PACK will be necessary.

NOTES:

- 1. During a power interruption, the BASE UNIT does not operate, and a phone conversation cannot be made on the HANDSET.**
- 2. To ensure your phone charges properly, place the HANDSET on the BASE UNIT with TELEPHONE KEYPAD face up, and make sure that the CHARGE LED indicator on the BASE UNIT lights up and a “beep” confirmation tone is heard.**

Changing the BATTERY PACK

The BATTERY PACK provides power for the **HANDSET** of your cordless telephone.

To Replace the BATTERY PACK:

1. Remove the **HANDSET BATTERY COMPARTMENT COVER** by sliding it down.
2. Pull out the BATTERY PACK PLUG and remove the BATTERY PACK.
3. Plug the new BATTERY PACK into the BATTERY CONNECTOR.
4. Slide the **HANDSET BATTERY COMPARTMENT COVER** firmly into place in its closed position.
5. Before use, charge the new BATTERY PACK for 12 hours.

ATTENTION:

The telephone that you have purchased contains a rechargeable BATTERY PACK. The BATTERY PACK is recyclable. At the end of its useful life, under various state and local laws, it may be illegal to dispose of this BATTERY PACK into the municipal waste stream. Check with your local solid waste officials for details in your area for recycling options or proper disposal.

Problem Solving

Problem Solving Section

For your assistance, we have listed below a few common problems.

Phone does not work, check the following:

1. **BASE UNIT** is plugged into a power source.
2. **HANDSET** is charged.
3. TONE/PULSE Select Switch is in the right position.
4. TELEPHONE LINE CORD is plugged into the TELEPHONE JACK.

Range of phone limited, check the following:

1. **BASE UNIT** is centrally located in your residence.
2. **BASE UNIT** is not located near appliances.

No dial tone, check the following:

1. TELEPHONE LINE CORD plugs are connected to the TELEPHONE JACK and TELEPHONE LINE CONNECTION JACK.
2. **BASE UNIT** is plugged into a power source.
3. If you had a power failure or had unplugged the **BASE UNIT**, replace the **HANDSET** on the **BASE UNIT** for 2 to 5 seconds to reset the system.



Received signal flutters or fades, check the following:

1. BATTERY PACK in the **HANDSET** is fully charged.
2. **HANDSET** is not too far from the **BASE UNIT**.



Interference on reception, check the following:

1. Noise may be picked up from electrical products in the home or electrical storms. Generally, this noise is a minor annoyance and should not be interpreted as a defect in your system. (See Technical Information on page 34).
2. Choose an alternate channel using the **Scan/Del** button on the **HANDSET**.
3. Do not use this telephone within 20 ft. of a microwave oven while it is working, as you may experience interference. This is a normal occurrence with 5.8 GHz phones and should not be interpreted as a defect in the product.

Excess static, check the following:

1. Check to see that the ANTENNA is not touching another metal object.

Problem Solving

If after pressing the Talk button, you receive three “beeps” and no dial tone, check the following:

1. **BASE UNIT** is plugged into a power source.
2. If you had a power failure or had unplugged the **BASE UNIT**, replace the **HANDSET** on the **BASE UNIT** for 2 to 5 seconds to reset the system.

NOTE:

If none of the telephones in the house are working, disconnect one set at a time to verify that none of the phones are causing the problem. If you still have a problem after doing this, and your telephone still does not work, please contact your local phone company.

Can not register the HANDSET, when place HANDSET to BASE UNIT not a long beep heard but the triple beep, check as following:.

1. **HANDSET** is more than 5.
2. Already has a **HANDSET** with ID=5, and wish register a new one. In this situation, you should reset the **BASE UNIT**.
3. reset the **BASE UNIT**: In standby mode, plug the T/P switch to the “P” position and push and hold the PAGE button on the **BASE UNIT** 8 -10 seconds, the CHAGRER LED will fast flash 1 second . After reset the **BASE UNIT**, place the each **HANDSET** to the **BASE UNIT** for 2 to 5 second for register(see page 29 for detail).

Technical Information

Technical Information

This cordless telephone uses radio frequencies to allow mobility. There are certain difficulties in using radio frequencies with a cordless telephone. While these are normal, the following could affect the operation of your system.

Noise

Electrical pulse noise is present in most homes at one time or another. This noise is most intense during electrical storms. Certain kinds of electrical equipment such as light dimmers, fluorescent bulbs, motors, and fans also generate noise pulses. Because radio frequencies are susceptible to these noise pulses, you may occasionally hear them in your **HANDSET**. Generally they are a minor annoyance and should not be interpreted as a defect in your system.

Range

Because radio frequency is used, the location of the **BASE UNIT** can affect the operating range. Try several locations in your home or office and pick the one that gives you the clearest signal to the **HANDSET**.

Interference

Electronic circuits activate a relay to connect the cordless telephone to your telephone line. These electronic circuits operate in the radio frequency spectrum. While several protection circuits are used to prevent unwanted signals, there may be periods when these unwanted signals enter the **BASE UNIT**. You may hear clicks or hear the relay activate while you are not using the **HANDSET**. If the interference occurs frequently, it can be minimized or eliminated by relocating the **BASE UNIT**. You can check for interference before selecting the final **BASE UNIT** location by plugging in the telephone.

NOTICE:

This cordless telephone uses radio communication between the **HANDSET** and the **BASE UNIT** and may not ensure privacy of communication. Other devices, including other cordless telephones, may interfere with the operation of this cordless telephone or cause noise during operation. Units not containing coded access may be accessed by other radio communication systems. Cordless telephones must not cause interference to any licensed radio service.

FCC Requirements

FCC NOTICE

The FCC requires that you be advised of certain requirements involving the use of this telephone.

1. This telephone is hearing aid compatible.
2. This equipment complies with Part 68 of the FCC Rules. A label on the **BASE UNIT** of this equipment contains, among other information, the ACTA Product Number and the Ringer Equivalence Number (REN) for this equipment. You must, upon request, provide this information to your telephone company.
3. The REN is also useful in determining the quantity of devices that you may connect to your telephone line and still allow these devices to ring when your telephone number is called. In most areas, but not all, the sum of the RENs for all devices connected to one line should not exceed five (5.0). To be certain of the number of devices that you may connect to your line, you should contact your local telephone company.
4. If your telephone causes harm to the telephone network, the telephone company may temporarily disconnect your service. If possible, they will notify you in advance that temporary discontinuance of service may be required. However, when advanced written notice is not possible, the telephone company may temporarily discontinue service without notice if such action is necessary under the circumstances.
5. The telephone company may make changes in its communication facilities, equipment, operations, or procedures that could affect the proper operation of your equipment. If they do, you will be provided with advance notice as to give you an opportunity to maintain uninterrupted service.
6. This equipment may not be used on coin service provided by the telephone company. Connection to party lines is subject to state tariffs. (Contact your state public Utility Commission or Corporation Commission for information.)
7. An FCC compliant telephone cord and modular plug is provided with this equipment. This equipment is designed to be connected to the telephone network or premises wiring using a compatible modular jack which is Part 68 compliant. See Installation Instructions for details.
8. Please follow instructions for repairing, if repairing any (e.g. battery replacement section), otherwise do not alter or repair any parts or device except specified.
9. The USOC number of the registration jack for this equipment is RJ11C.

FCC Requirements

RINGER EQUIVALENCE NUMBER

NOTICE: The Ringer Equivalence Number (REN) assigned to each terminal device provides an indication of the maximum number of terminals allowed to be connected to a telephone interface. The termination on an interface may consist of any combination of devices subject only to the requirement that the sum of the ringer equivalence numbers at all devices does not exceed 5.

CAUTION:

Users should not attempt to make such connections themselves, but should contact the appropriate electric inspection authority, or electrician, as appropriate.



FCC Requirements

NOTE: This equipment has been tested and found to comply with the limits for a class B digital device, pursuant to Part 15 of the FCC Rules. These limits are designed to provide reasonable protection against harmful interference in a residential installation. This equipment generates, uses, and can radiate radio frequency energy and, if not installed and used in accordance with the instructions, may cause harmful interference to radio communications.

However, there is no guarantee that interference will not occur in a particular installation. If this equipment does cause harmful interference to radio or television reception, which can be determined by turning the equipment off and on, the user is encouraged to try to correct the interference by one or more of the following measures:

1. Reorient or relocate the receiving ANTENNA.
2. Increase the distance between the equipment and the receiver.
3. Connect the equipment into an outlet on a circuit different from that to which the receiver is connected.
4. Consult the dealer or an experienced radio/TV technician for help.

Changes or modifications not expressly approved in writing by  **CURTIS** may void the user's authority to operate this equipment.

Some cordless telephones operate at frequencies that may cause interference to nearby TVs and VCRs. To minimize or prevent such interference, the base of the cordless phone should not be placed near or on top of a TV or VCR. If interference is experienced, moving the cordless telephone farther away from the TV or VCR will often reduce or eliminate the interference.

If trouble is experienced with this equipment, for repair or warranty information, please contact service center at the below. If the equipment is causing harm to the telephone network, the telephone company may request that you disconnect the equipment until the problem is resolved.

Service can be obtained at:

**U.S.A
C.I. Service Dept.
181 Cooper Avenue
Unit 104
Tonawanda, N.Y.**

14150



AC ADAPTOR: Use only with class 2 Power Source, 9V DC output, 300mA, center pin positive for BASE UNIT and 9V DC output, 100mA, center pin positive for CHARGER UNIT

IMPORTANT

In order to get maximum life from the **HANDSET BATTERY PACK**, be sure to charge the **HANDSET** for 12 hours before initial use.

IMPORTANT

Placing your **BASE UNIT** near appliances such as televisions, refrigerators, radios, or microwave ovens may cause interference.

IMPORTANT

The **AC ADAPTOR** must always be plugged into an electrical outlet.

IMPORTANT

In order to utilize the Caller ID feature, you must subscribe to Caller ID service from your local telephone company.

IMPORTANT

If you live in an area which receives frequent thunderstorms, we strongly recommend plugging your **AC ADAPTOR** into a surge protector.

Free Manuals Download Website

<http://myh66.com>

<http://usermanuals.us>

<http://www.somanuals.com>

<http://www.4manuals.cc>

<http://www.manual-lib.com>

<http://www.404manual.com>

<http://www.luxmanual.com>

<http://aubethermostatmanual.com>

Golf course search by state

<http://golfingnear.com>

Email search by domain

<http://emailbydomain.com>

Auto manuals search

<http://auto.somanuals.com>

TV manuals search

<http://tv.somanuals.com>