



HDMI DVD PLAYER

User`s Guide



After Sales Support

Now you have purchased a Tevion® product you can rest assured in the knowledge that as well as your 3 year parts and labour warranty you have the added peace of mind of dedicated helplines and web support:



Environmental Protection
Waste electrical products should not be disposed of with household waste. Please recycle where facilities exist. Check with your Local Authority or retailer for recycling advice.

AFTER SALES SUPPORT

UK / N.IRELAND HELPLINE NO 0800 032 5264
REP. IRELAND HELPLINE NO 1800 315 697
WEB SUPPORT www.curtisint.com

MODEL NUMBER: DVD3602UKT

IMPORTANT SAFETY INSTRUCTIONS



 The lightning flash with arrowhead symbol within an equilateral triangle intended to alert the user to the presence of uninsulated dangerous voltage within the product's enclosure that may of sufficient magnitude to constitute a risk of electric shock to persons.

 The exclamation point within an equilateral triangle is intended to alert the user to the presence of important operating and maintenance (servicing) instructions in the literature accompanying the appliance.

- 1. READ INSTRUCTIONS** - All the safety and operating instructions should be read before the product is operated.
- 2. RETAIN INSTRUCTIONS** - The safety and operating instructions should be retained for future reference.
- 3. HEED WARNINGS** - All warnings on the product and in the operating instructions should be adhered to.
- 4. FOLLOW INSTRUCTIONS** - All operating and use instructions should be followed.
- 5. CLEANING** - Unplug this product from the wall outlet before cleaning. Do not use liquid cleaners or aerosol cleaners. Use a soft dry cloth for cleaning.
- 6. ATTACHMENTS** - Do not use attachments not recommended by the product manufacturer as they may cause hazards.
- 7. WATER AND MOISTURE** - Do not use this product near water - for example, near a bath tub, wash bowl, kitchen sink, or laundry tub; in a wet basement; or near a swimming pool; and the like.
- 8. ACCESSORIES** - Do not place this product on an unstable trolley, stand, tripod, bracket, or table. The product may fall, causing serious injury to a child or adult, and serious damage to the product.

Use only with a cart, stand, tripod, bracket, or table recommended by the manufacturer, or sold with the product. Any mounting of the product should follow the manufacturer's instructions, and should use a mounting accessory recommended by the manufacturer.
A Product and Cart Combination Should Be Moved with Care - Quick stops, excessive force and uneven surfaces may cause the product and cart combination to overturn.



9. VENTILATION - Slots and openings in the cabinet are provided for ventilation and to ensure reliable operation of the product and to protect it from overheating, and these openings must not be blocked or covered. The openings should never be blocked by placing the product on a bed, sofa, rug or other similar surface. This product should not be placed in a built-in installation, such as a bookcase or rack, unless proper ventilation is provided or the manufacturer's instructions have been adhered to.

10. POWER SOURCES - This product should be operated only from the type of power source indicated on the marking label. If you are not sure of the type of power supply to your home, consult a professional electrician or local power company. For products intended to operate from battery power, or other sources, refer to the operating instructions.

11. POWER-CORD PROTECTION - Power supply cords should be routed so that they are not likely to be walked on or pinched by items placed upon or against them, paying particular attention to cords at plugs, convenience receptacles, and the point where exit from the product.

IMPORTANT SAFETY INSTRUCTIONS

12. NONUSE PERIODS - The power cord of the product should be unplugged from the outlet when left unused for long periods of time.

13. OUTDOOR ANTENNA GROUNDING - If an outside antenna or cable system is connected to the product, be sure the antenna or cable system is grounded so as to provide some protection against voltage surges and built-up static charges. Below diagram provides information with regard to proper grounding of the mast and supporting structure, grounding of the lead-in wire to an antenna discharge unit, size of grounding conductors, location of antenna-discharge unit, connection to grounding electrodes, and requirements for the grounding electrode. See Figure 1.

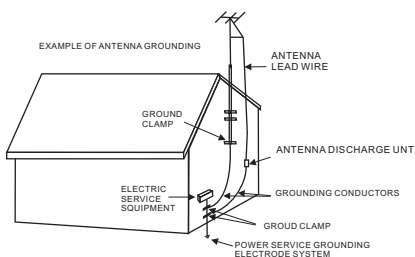

14. LIGHTNING - For added protection for this product during a lightning storm, or when it is left unattended and unused for long periods of time, unplug it from the wall outlet and disconnect the antenna or cable system. This will prevent damage to the product due to lightning and power-line surges.

15. POWER LINES - An outside antenna system should not be located in the vicinity of overhead power lines or other electric light or power circuits, or where it can fall into such power lines or other electric light or power circuits. When installing an outside antenna system, extreme care should be taken to keep from touching power lines or circuits as contact with them might be fatal.

16. OVERLOADING - Do not overload wall outlets, extension cords, or integral convenience receptacles as this can result in a risk of fire or electric shock.

17. OBJECT AND LIQUID ENTRY - Never push objects of any kind into this product through openings as they may touch dangerous voltage points or short-out parts that could result in a fire or electric shock. Never spill liquid of any kind on the product.

18. SERVICING - Do not attempt to service this product yourself as opening or removing covers may expose you to dangerous voltage or other hazards. Refer all servicing to qualified service personnel.

19. DAMAGES REQUIRING SERVICE - Unplug this product from the wall outlet and refer servicing to qualified service personnel under the following conditions.

- When the power-supply cord or plug is damaged.
- If liquid has been spilled, or objects have fallen into the product.
- If the product has been exposed to rain or water.
- If the product does not operate normally by following the operating instructions. Adjust only those controls that are covered by the operating instructions as an improving adjustment of other controls may result in damage and will often require extensive work by a qualified technician to restore the product to its normal operation.
- When the product exhibits a distinct change in performance - this indicates a need for service.

20. REPLACEMENT PARTS - When replacement parts are required, be sure the service technician has used replacement parts specified by the manufacturer or have the same characteristics as the original part. Unauthorized substitutions may result in fire, electric shock or other hazards.

21. SAFETY CHECK - Upon completion of any service or repair to this product, ask the service technician to perform safety checks to determine that the product is in proper operating condition.

22. HEAT - The product should be situated away from heat sources such as radiators, heat registers, stoves or other products (including amplifiers) that produce heat.

23. Keep minimum distances (5cm) around the apparatus for sufficient ventilation.

24. The ventilation should not be impeded by covering the rear panel for ventilation with items, such as newspapers, table-cloths, curtains, etc.

25. No naked flame sources, such as lighted candles, should be placed on the apparatus.

26. Don't use the apparatus in tropical climates.

27. Where the mains plug is used as the disconnect device, the disconnect device shall remain readily operable.

28. The apparatus shall not be exposed to dripping or splashing and that no objects filled with liquids, such as vases, shall be placed on the apparatus.

29. Attention should be drawn to the environmental aspects of battery disposal. Don't throw used batteries in dustbin. Please contact your retailer in order to protect the environment.

TROUBLESHOOTING

Check the chart below for a possible cause of the problem you are experiencing before requesting service for this unit. Some simple checks or minor adjustment on your part may eliminate the problem and restore proper operation. Let the technician maintain the unit. Keep away from static electricity properly before maintenance as loader, key IC are easy to be damaged by it.

Trouble	Suggested solution
No power	Plug the power cord into the power outlet tight to turn on/off once
Cannot read disc	Disc access time within 10-20 seconds is normal The disc is scratched or defiled (change disc) The code of disc is different from the code of unit (change the disc) PAL to NTSC error (Set video output as AUTO)
No picture	If your TV does not have P-Scan function, pressing VIDEO button on the remote may cause this. Press VIDEO button again to rectify.
No sound	Ensure that the equipment is connected properly. Ensure that the TV or audio equipments are not muted. Ensure that the audio output setting is correct.
Picture is distorted during fast forward or reverse	The picture will be somewhat distorted at times. This is normal advance or reverse.
No (4:3)(16:9) picture	Choose the correct setup at TV TYPE item that matches the TV set.
Remote control does not function	Check the batteries being installed with correct polarities. Replace the batteries depleted. Point at remote control sensor and operate it within 5 meters.
Unit's or remote control buttons are not functioning or other abnormal phenomena	Turn the unit off and then back to on. Alternatively, turn off the unit, disconnect the AC power cord for 5 to 10 minutes and then reconnect it.
Audio soundtrack and/or subtitle language not found in settings	If the audio soundtrack and/or subtitle language does not exist in the disc, the language selected at the initial settings will not be seen/heard. Alternative audio soundtrack (or An alternative language is not selected with discs which contain subtitle) language cannot be more than one language selected.
Can not change angle	This function depends on software availability. Even if a disc has a number of angles recorded, these angles may be recorded for specific scenes only.
No playback menu	This function is suitable for VCD with playback control disc.
Miscellaneous	In program playing mode, no repeat, A-B functions are available.

REFERENCE

◆Definition of terms

Angle
Recorded onto some DVD discs are scenes which have been simultaneously shot from a number of different angles (i.e. The same scene is shot from the front, left side and right side etc.). With such discs, the ANGLE button can be used to view the scene from different angles.

Chapter Number
These numbers are recorded on DVD discs, A title is subdivided into many sections. Each of them is number and specific parts of video presentations can be searched quickly using these numbers.

DVD disc
This refers to a high-density optical disc on which high quality pictures and sound have been recorded by means of digital signals. Incorporating a new video compression technology (MPEG2) and high-density recording technology, DVD enables full-motion video to be recorded over long periods of time (for instance, a whole movie can be recorded).

Subtitles
These are the printed lines appearing at the bottom of the screen which translate or transcribe the dialogue. They are recorded on DVD discs and up to 32 languages.

PBC
The language indicates on TV screen to imply operation or disc information.

Audio
Language recorded on discs and the maximum languages are up to 8.

Time
This indicates the play time elapsed from the start of a disc or a title. It can be used to find a specific scene quickly (it may not work with some discs).

Title Number
These numbers are recorded on DVD discs. When a disc contains two or more movies, these movies are numbered as title1, title2, etc.

Track Number
These numbers are assigned to the tracks which are recorded on audio CDS. They enable specific tracks to be located quickly. RAW The original DTS, AC-3 signals non-decoded. If users choose RAW as audio setting, they must connect a decoder to decode those original audio signals.

SPECIFICATIONS

Power requirement: AC 100-240V~50/60Hz
Power consumption: 10W
Signal system: NTSC/PAL/AUTO
Dimension: 360mm x 38mm x 250mm

Disc played:
1. DVD-video disc
● 12cm single-sided, single-layer
● 12cm single-sided, double-layer
● 12cm double-sided, double-layer
● 8cm single-sided, single-layer
● 8cm single-sided, double-layer
● 8cm double-sided, double-layer
2. CD disc
● 12cm disc
● 8cm disc

Video output
● Output level: 1±0.2Vp-p (75 ohm)
● Horizontal resolution: >500 lines
● S/N ratio: >60dB

Audio output (Impedance: 10k ohm):
● Output level: 1.8+0.2/-0.8Vrms (1KHz 0dB)
● Harmonic distortion: <0.01% (JIS-A 1KHz, typical)
● Dynamic range: >80 dB (JIS-A 1KHz, typical)
● S/N ratio: 90dB (JIS-A 1KHz, typical)

Weight and dimensions are approximate Specifications are subject to change with or without notice.

IMPORTANT SAFETY INSTRUCTIONS

To protect intellectual property, the involved organizations partition the world into six regions, each of which can only use the DVD player and DVD disc with the given regional code. The illustration on the right shows symbols of the six regions. One DVD player with a given regional code cannot play disc of another regional code. The partition of regional codes is shown as follows:

1. Canada, USA;
2. Japan, Europe, South Africa, Middle East
3. Southeast Asia, East Asia
4. Australia, New Zealand, Oceania, Central America, Mexico, Latin America, Caribbean Sea;
5. Russia, India, Africa, Korea, Mongolia.
6. China.



Note: THE REGION CODE FOR THE UNIT IS 2.

TV connections for DVD discs recorded in PAL and NTSC systems

Generally, DVD discs are recorded in PAL or NTSC systems, please refer to the following table:

■ Connecting to the multi-system TV

DISC	TV MONITOR
 PAL	 Play in PAL system
 NTSC	 Play in NTSC system

■ Connecting to NTSC TV

DISC	TV MONITOR
 PAL	 No clear images are shown on the screen.
 NTSC	 Play in NTSC system

■ Connecting to PAL TV

DISC	TV MONITOR
 PAL	 Play in PAL system
 NTSC	 No clear images are shown on the screen.

Please read the user manual carefully before connection or operation

TABLE OF CONTENT

Important Safety	1
Features	5
Precautions	5
Accessories	6
Front Panel	6
Rear Panel	6
Remote Control	7
Basic Connection	8
Remote Control Preparation	11
Operations	12
Preparation	12
Play	12
Stop	12
Prev/Next	12
Rev/Fwd	12
Slow	12
Step	12
Pause	12
Number(0-9,10+) button	12
Mute	13
VOL+/VOL-	13
Return	13
Osd	13
Zoom	13
A-B Repeat	13
Repeat	13
Angle	13
Audio	13
Program	13
PBC	13
Time	14
Menu	14
Subtitle	14
Video	14
N/PI	14
Shuffle	14
Reset	14
USB/CART	14
Setup	15
Reference(Menu/Submenu/Options)	16
HDMI setup	17
Handling Precautions	17
Player Maintenance	17
Definition of terms	18
Specifications	18
Troubleshooting	19

REFERENCE

MENU	SUBMENU	OPTIONS	DESCRIPTION
AUDIO	Subwoofer	None	When Audio output 2.0 CH select none
		Present	
	Test tones	Off	Test tones off
		Left	Test Left
		Right	Test Right
		Center	Test Center
		Left surr.	Test Left surr.
		Right surr.	Test Right surr.
		Subwoofer	Test Subwoofer
	Center delay	No Delay	Center delay time
		0.3m	
		0.6m	
		1m	
		1.4m	
		1.7m	
	Surr.delay	No Delay	Surround delay time
		1m	
		2m	
3m			
4m			
5.1m			
Digital output	OFF	Digital output OFF	
	PCM	Digital output PCM	
	ALL	Digital output RAW	
Rating	Password	-----	Input number by users to change password, default setting 8888
	Rating	1.Kid safe	Suitable for children.
		2.G	Suitable for all age groups.
		3.PG	The presence of parents is recommended. Some scenes may be unsuitable for children.
		4.PG-13	The presence of parents is strictly recommended. Some scenes may be unsuitable for children under the age of 13.
		5.PG-R	The presence of parents is strictly necessary.
		6.R	Young persons under the age of 17 may only view this film in the presence of an adult.
		7.NC-17	Children and juveniles under the age of 17 are not allowed to watch this film.
		8.ADUIT	The film must only be watched by adults.
MISC	Default	Read	Return to factory setup

◆ HDMI SETUP

In setup mode, Press $\uparrow\downarrow$ button on remote control to select video, then press $\rightarrow\downarrow$ button to select HD. Press \downarrow button to select HD resolution, Press $\rightarrow\downarrow$ button to select " Auto,480P,576P,720P,1080i,1080P", etc HDMI output mode. Press $\rightarrow\downarrow$ button to select audio digital output for PCM.

Remarks:It is only apply to TV with HDMI jack.

◆ Handling Precautions

Maintenance

Hold the disc by the edge so the surface will not be soiled with fingerprints. Fingerprints, dirt and scratches can cause skipping and distortion. Do not use record cleaning sprays, benzene, thinner. Static electricity prevention liquids or any other solvent. Be careful not to drop or bend the disc. Do not try to close the disc tray when disc is not installed properly. Be sure to store the disc in its exclusive case when not in use.

Handling

Wipe gently with a soft, damp (water only) cloth. Move the cloth from the centre hole towards the outer edge. Improper disc disc storage: Discs may be damaged if they are stored in the following places: Areas exposed to direct sunlight; Humid or dusty areas; Areas directly exposed to a heat outlet or heating appliance.

◆ Player Maintenance

Be sure to turn the unit off and disconnect the AC power cord before maintaining the unit. Keep the unit clean. If the surfaces are extremely dirty, wipe the unit with a dry soft cloth. Never use alcohol, benzene or other chemicals. Do not use compressed air to remove dust. Ask the technician to maintain the unit when trouble happens.

REFERENCE

◆ Menu, Submenu and Options

MENU	SUBMENU	OPTIONS	DESCRIPTION
LANGUAGE	Language	English	English On Screen Display
		Français	French On Screen Display
		Español	Spanish On Screen Display
		Deutsch	German On Screen Display
		Itoliano	Italian On Screen Display
	Subtitle	English	English On Screen Display
		French	French On Screen Display
		Spanish	Spanish On Screen Display
		German	German On Screen Display
		Italian	Italian On Screen Display
		Auto	Auto On Screen Display
		Off	Off On Screen Display
	Audio	English	English On Screen Display
		French	French On Screen Display
		Spanish	Spanish On Screen Display
		German	German On Screen Display
Italian		Italian On Screen Display	
DVD menu	English	English On Screen Display	
	French	French On Screen Display	
	Spanish	Spanish On Screen Display	
	German	German On Screen Display	
	Italian	Italian On Screen Display	
VIDEO	Aspect Ratio	4:3	Set TV screen at 4:3
		16:9	Set TV at screen 16:9
	View mode	Fill	Scale up/down the image in horizontal and vertical direction respectively to fill the screen height and width
		Original	Like letter box. Take the minimum value of horizontally fit scale ratio and vertically fit scale ratio
		Auto fit	Take the maximum value of horizontally fit scale ratio and vertically fit scale ratio.
		Pan scan	Fit the original screen size. (Only for Divx / MPEG)
	TV System	NTSC	Output signal as NTSC
		PAL	Output signal as PAL
		AUTO	Output signal as per default of disc
	Video out	S-VIDEO	S-VIDEO video output
Component		Component video output	
RGB		RGB video output	
P-SCAN		P-SCAN video output	
HD		HDMI switch	
HD Resolution	Auto	HDMI auto output	
	480p/576p	HDMI 480p/576p output	
	720p	HDMI 720p output	
	1080i	HDMI 1080i output	
	1080p	HDMI 1080p output	
AUDIO	Bass management	Off	Bass management off
		On	Bass management on
	Front speakers	Large	When Audio output 2.0 CH select small
		Small	
	Center Speaker	Large	When Audio output 2.0 CH select none
		Small	
		None	
	Surround Speakers	Large	When Audio output 2.0 CH select none
Small			
None			

FEATURES

DVD - A completely new dimension in video entertainment

- Subtitles may be displayed in one of a maximum of 32 languages available (multi-subtitles DVD only).
- Audio soundtrack can be heard in up to 8 languages (multi-languages DVD only).
- Multi-angle function allows you to choose the viewing angles of scene (for DVD with multiple camera angles only).

Other convenient features

- Parental lock settings to prevent playing unsuitable discs for some audiences (DVD only). A full function remote control provides quick access to DVD functions.

Compatible with PAL DVD and NTSC DVD

- This player can play discs recorded in either PAL or NTSC system.

Compatible with CD besides DVD, MP3, CD-R

- This player could play various discs such as DVD, CD (8cm/12cm discs).

PRECAUTIONS

- Please read these precautions before operating this unit.

Power cord protection

- To avoid any malfunctions of the unit, and to protect against electric shock, fire or personal injury, please observe the following.
 - Hold the plug firmly when connecting or disconnecting the AC power cord to this unit.
 - Do not connect or disconnect the AC power cord when your hands are wet.
 - Keep the AC power cord away from heating appliances.
 - Never put any heavy object on the AC power cord.
 - Do not attempt to repair or reconstruct the AC power cord.
 - Remove dust, dirt etc. on the plug regularly.
 - If the unit has been dropped or otherwise damaged, turn off the power and disconnect the AC power cord.
 - If you find smoke, unusual odour or noise from the unit, turn off the power and disconnect the AC power cord.

Placement

The internal parts may be seriously damaged if the unit is placed in areas of:

- Direct sunlight or heating radiators or closed automobiles;
- High temperature (over 35°C) or high humidity (over 90%)
- Excessive dust;
- Strong magnetic or static electricity;
- Vibration, impact or where the surface is tilted.

Non-use Periods

- Turn off the power when the unit is not used.
- It should be unplugged when the unit is idle for a long period of time.

No fingers or other objects inside

- Touching internal parts of this unit is dangerous, and may cause serious damage to the unit and even human injury.
- Do not try to disassemble this unit.
- Do not put any other object on the disc tray.

Keep away from water and magnets

- Keep the unit away from flower vases, tubs, sinks, etc. If liquids are spilled into the unit, serious damage could occur.
- Never place magnetic objects such as speakers near the unit.

Stacking

- Place the unit in a horizontal position and do not place anything heavy on it.
- Do not put the unit on amplifiers or other equipment.

Condensation

Moisture may form on the lens under the following conditions:

- In a steamy or very humid room.
- Immediately after a heater is turned on.
- If moisture forms inside this unit, it may not operate properly. In this case, turn on the power and wait for about 1 hour to evaporate it.

Interference for the TV broadcast

- Depending on the reception condition of the TV, interference may appear on the TV screen while you are watching a TV broadcast and the unit is turned on. This is not a malfunction of the unit of the TV. Just ensure that the unit is turned off when you watch a TV broadcast.

ACCESSORIES

(Please check whether all the following accessories are available after unpacking.)

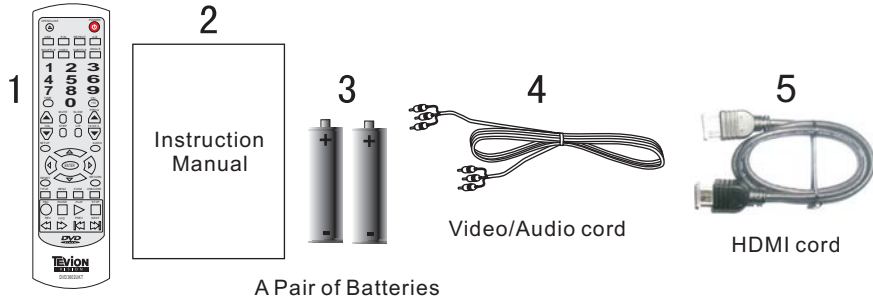

Remote control

FRONT PANEL

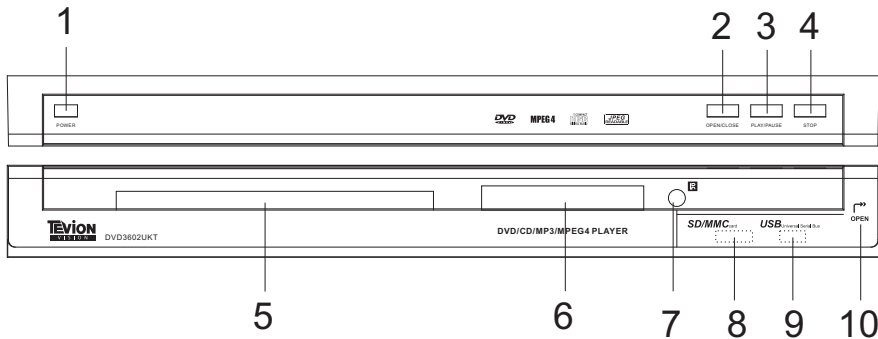

1. Power switch key
2. Open/Close key
3. Play/Pause key
4. Stop key
5. Disc tray
6. Display window
7. Remote control sensor
8. SD/MMC
9. USB
10. Cover open

REAR PANEL

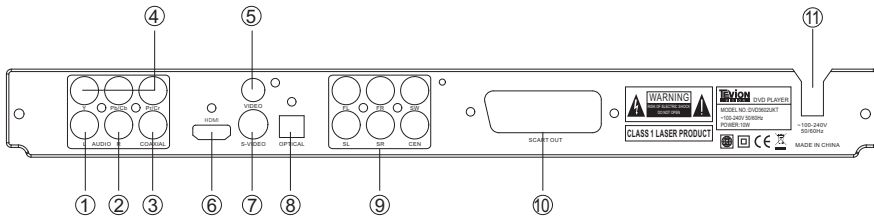

1. Left audio output jack
2. Right audio output jack
3. Digital signal coaxial output jack
4. Component output jacks (Y, Pb,Pr)
5. Video output jack
6. HDMI output jack
7. S-video output jack
8. Optical output jack
9. 5.1 channel output jack
10. Scart out output jack
11. AC power cord

SETUP

◆ SETUP

Once the initial settings have been completed, the player can always be operated under the same conditions (especially with DVD discs). The settings will be retained in the memory even after turning off the power until the settings are changed. We set the initial language to English when the player is out of factory. You may change the language into that you preferred.

Operation

1. Press SETUP button to enter setup interface as followed, you can setup Language, Video, Audio, Rating, Misc.

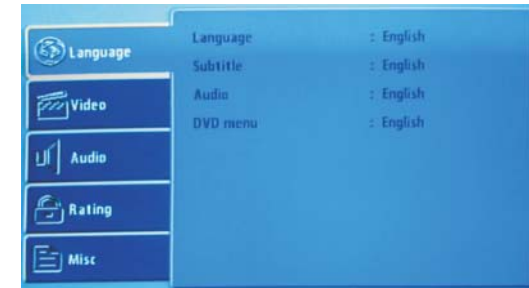

2. Press ◀ and ▶ to choose the desired section and ENTER button to enter submenu or press SETUP to leave the setup Video. Following is the language setup Video for your reference where you can set OSD menu, Subtitle, Audio Language and DVD menu Language.



OPERATION

◆ TIME

In the play, you press TIME and \uparrow/\downarrow button on the remote control. You can search the disc based on its title/chapter/track as shown in the figure. Press TIME button, a search menu will display. Use \leftarrow/\rightarrow button to select the search item/time/title/chapter. The selected will be shown in highlight. Use number button to select the search item/time/title/chapter, and press ENTER button to play.

Note:

- For some DVD discs which cannot be searched, invalid will be appear on TV screen.
- Input the time, title and chapter of the disc to search.
- For VCD in PBC mode is ON, it can only search for the time.

◆ MENU

Press MENU button on remote control when playing a disc, a list of titles on the disc (depends on discs) will be displayed on TV monitor. Use the direction or number button to select your preferred items then press ENTER button to play as selected.

◆ SUBTITLE

Press SUBTITLE button on remote control during playback. Subtitle: [1] will be displayed on TV monitor that means a kind of language. Press once more, Subtitle: [2] appeared on TV monitor means another kind of language and accordingly subtitles appear that represents how many kind of language being selected. Subtitle: [OFF] appears that toggle subtitle.

Note: This function is valid only for DVD discs with subtitle function. It is invalid for DVD disc with single subtitle function.

◆ VIDEO

Press VIDEO button during stop state to use direction to select the video output progressive scan (YPbPr) or other mode (S-VIDEO, Component, RGB, P-SCAN, HD).

◆ N/P

Press N/P button during stop state can switch output signal to NTSC, PAL or AUTO. The default setting is PAL.

◆ SHUFFLE

Press SHUFFLE button while playing DVD /MP3/CD/JPG or VCD disc(PBC OFF), the player will playing the disc randomly.

◆ RESET

Press RESET button to resume the original setting of this unit.

◆ USB/CARD READER PLAY

This DVD player can compatible with the playing function of USB flash disc and CART reader. You connect the USB or SD/MMC/MS card to the USB port or CARD port, press USB/CARD button on the remote control. Then press \downarrow button to USB, Press ENTER button to USB flash disc or SD/MMC/MS card, press $\uparrow/\downarrow/\leftarrow/\rightarrow$ button to select your preferred title or chapter, press ENTER button to play.

REMOTE CONTROL

1. Power button
2. A-B button
3. Repeat button
4. Angle button
5. Subtitle button
6. Program button
7. Slow button
8. 16:9/4:3 button
9. L/R button
10. Audio button
11. Return button
12. Zoom button
13. USB/CARD button
14. Stop button
15. Play button
16. Next button
17. Prev button
18. FWD button
19. REV button
20. Pause button
21. PBC button
22. TITLE button
23. Menu button
24. Reset button
25. $\leftarrow/\rightarrow/\uparrow/\downarrow$ Button
26. Enter button
27. Setup button
28. Step button
29. Vol +/Vol - button
30. Mute button
31. Time button
32. Number (0-9) button
33. Video button
34. Shuffle button
35. P/N button
36. OSD button
37. Open/Close button

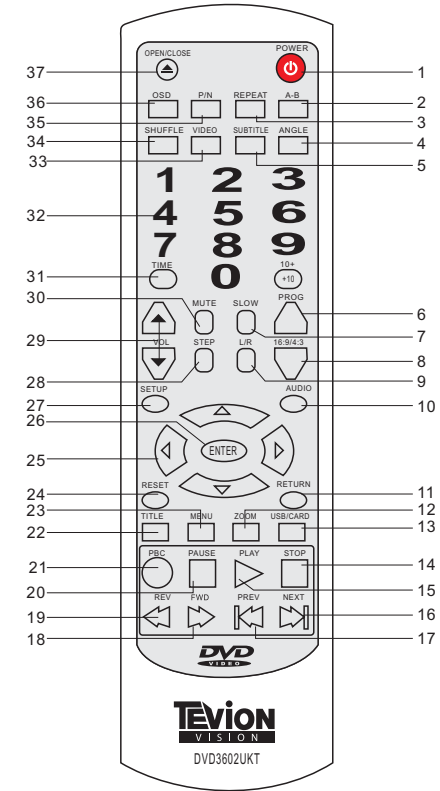

Note:

The same buttons on remote control and front panel have identical functions.

BASIC CONNECTION

- Ensure that the power switch of this unit and other equipment to be connected is turned off before commencing connection.
- Read through the instructions before connecting other equipment.
- Ensure that you observe the colour-coding when connecting audio and video cords.

A: Connecting to a stereo TV set

1. TV set (optional)
2. DVD/CD player
3. Connecting Video, R/L audio cords
4. To TV set audio input connector
5. Connecting cord to Scart jack (option)
6. To Scart jack

To get the best viewing quality you are advised to use S-video cord to connect the TV set with S-video input and to change the TV set to S-video input mode.

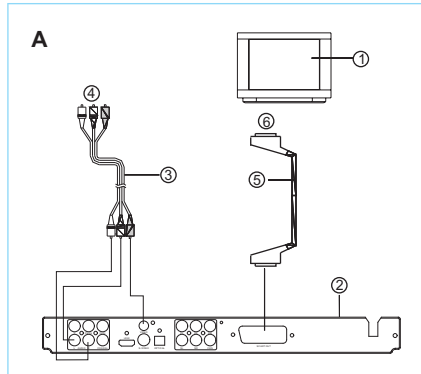

B: Connection to monophonic TV

1. TV set (optional)
2. DVD/CD player
3. Audio cords
4. To TV set audio input connector
5. To TV set video input connector
6. Component connector cord (optional)
7. To TV component (Y,Pb/Cb,Pr/Cr) input connector

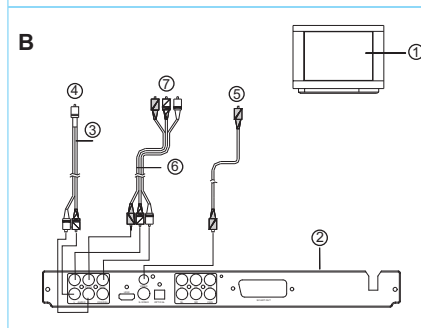

C: Connection to audio equipment

1. Audio player (optional)
2. TV set (optional)
3. DVD/CD players
4. Video/audio cords
5. To TV video input connector (yellow)
6. To audio input connectors (red, white)
7. To TV S-video input connector

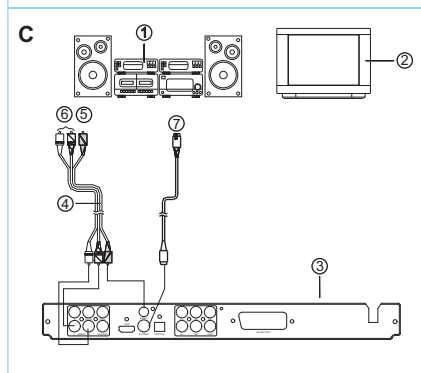

OPERATION

◆ MUTE

Press MUTE button during play, the player shows  and there is no audio output (silence). Press again to cancel MUTE.

◆ VOL+/VOL-

Press VOL+/VOL- button play may change volume for audio output.

◆ RETURN

For VCD when playing 2.0 PBC is operating. Press RETURN key, it will return to menu mode. When playing DVD/MP3/JPG discs. Press RETURN key, it will return to menu mode.

◆ OSD

Press OSD button during play to show the disc's relevant information on TV screen (such as playing time, chapter number, playback status).

◆ ZOOM

Zoom function can only be operated in JPEG disc and VCD/DVD format disc. By pressing zoom button when playing DVD/VCD discs, there are 3 levels of zoom available (Q1, Q2, Q3). When playing JPEG disc, there are 3 levels of zoom available (Q1, Q2, Q3).

Note: Zoom function is not working on PAL system DVDs.
MP3 does not have this function

◆ A-B REPEAT

Press A-B button during playback at the point where repeat play is to commence (a) then press again at the point where repeat play is to be concluded (B). Repeat playback between point (A) and point (b) starts. Press A-B button once more where TV screen appears REP OFF to return to normal play.

◆ REPEAT

Press the repeat key to choose repeat play chapter or title (DVD) and play single audio or full disc (VCD, CD, MP3).

Note: Some VCD do not have repeat function with PBC ON state.

◆ ANGLE







Press ANGLE continuously during playback DVD disc to toggle the disc between available angles recorded on the disc if the disc has multi-angle function.

◆ AUDIO



Press AUDIO button during playback to toggle between available audio language recorded on the disc if the disc has this multi-language.

Note: Press AUDIO button could toggle available audio language soundtracks.

◆ PROGRAM

Press PROG button, the program playback screen appears on the TV monitor, 12 tracks or chapters can be programmed. Use number (0-9, 10+) and   button on the remote control to select your preferred track (CD/VCD) or title and chapter (DVD), press   button to "▶ play", then press ENTER button to confirm. press   button to "clear program", then press ENTER button to clear program. You can only press the PLAY button on the remote control to start playing after you finish the program setting. Press the PROG button directly to return to normal play mode. In this case, the program is not confirmed.

CD/MP3 PROGRAM

Press PROG button, the program playback screen appears on the TV monitor, Select the "Edit mode" on the TV screen and press direct key  to program and select track. press  button select "and to program" then press the "ENTER" and select "program view". Press the "Play" button to program playing.

◆ PBC function (only VCD)

When playing VCD 2.0 press PBC button to display title menu use number key choice and ENTER button to play music.

OPERATION

PREPARATION BEFORE PLAYING DISC

- The option of display language catalogue is preset to English. Please refer to Setup operation
- Most functions are operated by remote control. Either operation of remote control of front panel is effective when their buttons indicate the same function.

Preparation

- Turn the TV on and select AV as the TV input.
- Switch on the related system power if the player has been connected to amplifier equipment etc.

◆ PLAY

1. Connect AC power cord to AC outlet.
2. Switch on the power, the displayed LOADING indicates the normal power supply. (Note: the disc information appears after several seconds if there has disc after LOADING displayed otherwise appears NO DISC).
3. Press OPEN/CLOSE.
4. Place a disc (8cm or 12cm) onto the tray. (For one-sided disc, position it with printed title side facing up. For two-sided disc, position side to be playback facing down).
5. Press OPEN/CLOSE again to close disc tray.
6. Press PLAY to playback disc. You may operate according to MENU indication after MENU shows on screen then press ENTER button to play back. Some discs may play automatically after loaded.

◆ STOP

Press STOP button to stop playing (TV show "■ STOP"). When play back is stopped the unit records the point where STOP was pressed (resume function). Press PLAY again, and play will resume from this point. Press STOP button twice, resume function will be cancelled.

◆ PREV/NEXT

Press PREV button or NEXT button on remote control when playing a disc, a chapter (DVD) or a track (CD) is skipped backward or forward correspondingly each time the button is pressed.

◆ REV/FWD

Press REV/FWD button on the remote control during playback, the disc will be played in a status of forward or reverse correspondingly. Forward or Reverse speed is relatively slow at first. When press again, the speed becomes faster. The more times that you press the buttons, the faster the fast forward or reverse speed will be. There are 5 levels of speed available: X2, X4, X8 and X16. To return to normal Play, press PLAY button on the player or the remote control.

Note: Some discs including MP3 disc have no such function.

◆ SLOW

Press SLOW button on the remote control during playback and the unit will enter slow forward status. There are 5 speeds available: 1/2, 1/4, 1/6 and 1/8. To return to normal play. Press PLAY button on player or remote control again.

Note: Some discs including MP3 disc have no such function.

◆ STEP

Press STEP button during play, the player will enter the still picture mode. If the button is pressed again, the disc is advanced by one frame (step). When the button is kept pressed, consecutive frame advance works. To return to normal play, press PLAY button.

Note: Some discs do not have such function.

◆ PAUSE

Press PAUSE key to stop playing and restore play by pressing PLAY key again.

◆ Number (0-9,10+) button

By pressing the Number (0-9) button, you can access directly to the desired track or chapters while a disc is played. For track or chapter over 10, press 10+ and then 0-9 button.

BASIC CONNECTION

D: Connecting to AV amplifier with 2-channel input connector

1. TV set (optional)
2. DVD / CD player
3. Video / Audio cords / S-video cord (optional)
4. Amplifier with 2 channel input connectors
5. To audio input connector (L,R)
6. Left speaker
7. Right speaker

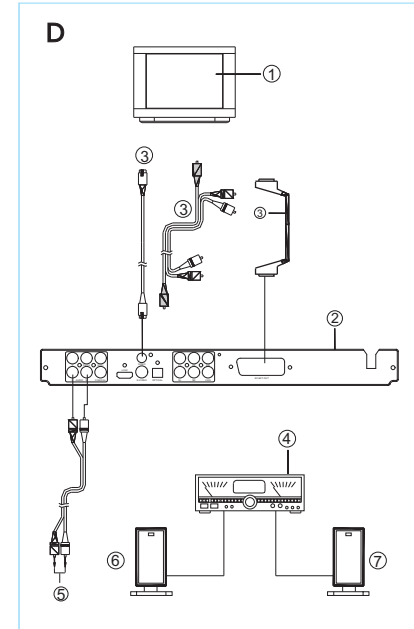

E: Connecting to TV HDMI connector

1. TV set (optional)
2. DVD / CD player
3. HDMI cord (optional),
4. to TV HDMI input connector

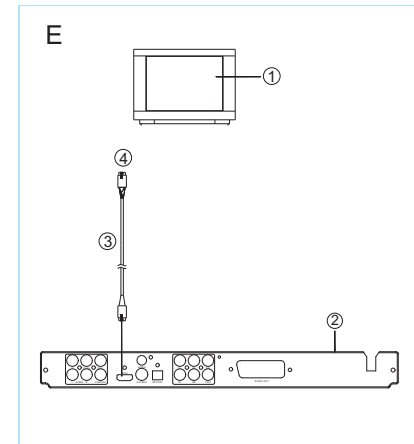

BASIC CONNECTION

F: Connecting to an external decoder or a power amplifier

When DVD discs recorded in Dolby digital, MPEG audio or other formats are played, corresponding bit stream is output from the player's COAXIAL digital audio output connector. When the player is connected to an external decoder or a power amplifier, you can enjoy quality of theatre level at your home!

CD	Sound recording format	Digital output setting	
DVD	Dolby digital	PCM(44.1KHZ sampling)*1	
		Raw	
	DTS	Raw	
MP3	MP3	OFF	
		Linear PCM	PCM(44.1KHZ sampling)
		Other	PCM(44.1KHZ sampling)
	Linear PCM	PCM(44.1KHZ sampling)	

*1 sound having 192KHz sampling is converted to 48KHz sampling when it is output from the Coaxial digital audio output connector.

Note: Please refer to the setup operations for setup method.

For your reference:

Dolby Digital (AC-3), a digital sound compression technique developed by the Dolby Laboratories Licensing Corporation supports 5.1-channel surround output and stereo sound system enables the capacity of mass storage recorded in discs Linear PCM is a signal-recording format used in CD s While CD s are recorded in 44.1KHz/16bit, DVDs are 48KHz/16bit up to 192KHz/24bit.

Caution for the coaxial audio output connector.

Do not connect an amplifier (with an Coaxial digital input connector) which does not contain the Dolby Digital (AC-3) or MPEG audio decoder, otherwise it maybe harmful to your ears and damage your speakers, Choose RAW in the digital audio setup to activate coaxial or optical output when playing disc with DTS output.

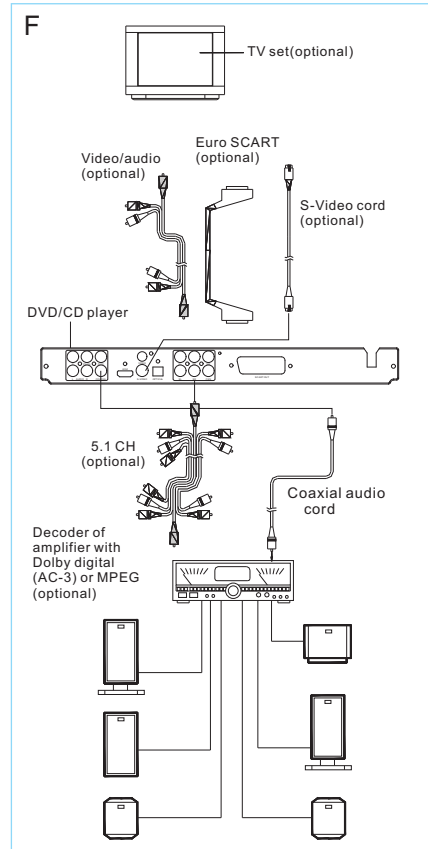

REMOTE CONTROL PREPARATION

Battery Installation

Insert the batteries while observing the positive (+) and Negative (-) polarities as Figure A.

Service life of batteries

The batteries normally last for a year although this depends on the operation and on how often the remote control is used.

If the remote control unit fails to work even when it is operated near the player, replace the batteries with new ones. Use size AAA UM-4 batteries (2 pieces).

Notes:

- Do not use rechargeable (Ni-Cd) batteries.
- Install batteries correctly observing the (+/-) polarity signs.
- Do not drop, step on the remote control, otherwise it may damage the parts or lead to malfunctioning.
- Use only the recommended battery type or equivalent (voltage and size).
- Always replace a complete set of batteries at the same time.
- Do not mix batteries of different types.
- Never mix new and used batteries in the same compartment.
- Remove exhausted batteries immediately.
- Remove batteries when product is not in use.
- Do not dispose of batteries in fire as they may explode.
- Do not recharge non-rechargeable batteries.
- Do not short circuit the supply terminals.
- Ensure batteries are stored away from metal objects as contact may cause a short circuit.
- Remote control operation range is no more than 5 m from and within about 60 degree wide in front of the unit (Figure B).

Notes:

- Do not point bright lights to the remote control sensor. Do not place objects between the remote control and the remote control sensor.
- Do not use this remote control together with the remote control of any other equipment.

Remark:

Batteries (battery pack or batteries installed) shall not be exposed to excessive heat such as sunshine, fire or the like.

A

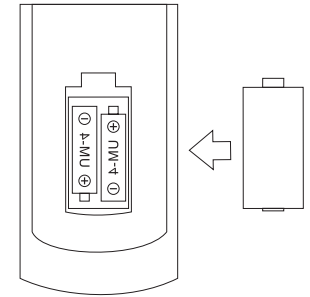

B

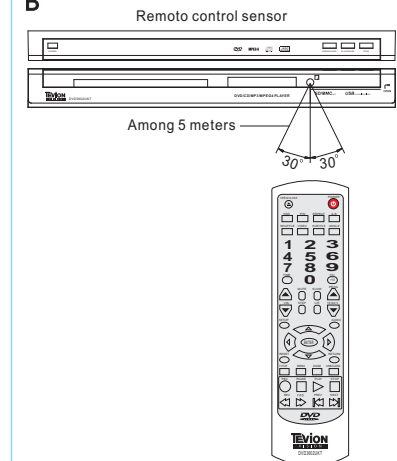

Free Manuals Download Website

<http://myh66.com>

<http://usermanuals.us>

<http://www.somanuals.com>

<http://www.4manuals.cc>

<http://www.manual-lib.com>

<http://www.404manual.com>

<http://www.luxmanual.com>

<http://aubethermostatmanual.com>

Golf course search by state

<http://golfingnear.com>

Email search by domain

<http://emailbydomain.com>

Auto manuals search

<http://auto.somanuals.com>

TV manuals search

<http://tv.somanuals.com>