

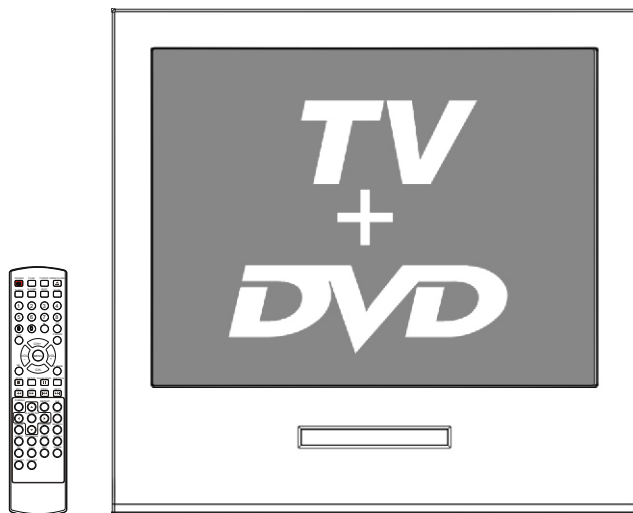

OWNER'S MANUAL

TVD2000A ATSC TV/DVD COMBO



Before operating the unit, please read this manual thoroughly.

PRECAUTIONS

FCC WARNING-This equipment may generate or use radio frequency energy. Changes or modifications to this equipment may cause harmful interference unless the modifications are expressly approved in the instruction manual. The user could lose the authority to operate this equipment if an unauthorized change or modification is made.

LASER SAFETY

This unit employs a laser. Only a qualified service person should remove the cover or attempt to service this device, due to possible eye injury.

CAUTION: USE OF CONTROLS OR ADJUSTMENTS OR PERFORMANCE OF PROCEDURES OTHER THAN THOSE SPECIFIED HEREIN MAY RESULT IN HAZARDOUS RADIATION EXPOSURE.

CAUTION: VISIBLE AND INVISIBLE LASER RADIATION WHEN OPEN AND INTERLOCK DEFEATED. DO NOT STARE INTO BEAM.

LOCATION:INSIDE,NEAR THE DECK MECHANISM.

CONTENTS

Before Operation

Important Safety Instructions	1
Installation	5
Antenna Connection.....	5
Preparation of the remote control.....	5
Function buttons and External Connections	6
Front panel of the TV set.....	6
Rear panel of the TV set.....	7
Using the remote control	8
The other video and audio equipment	9
Antenna connections	10
Cable TV connections	11
Connections the other equipment	12

Basic operation

Setting the language and blue screen	13
Channel menu	14
Channel selection	16
Volume adjustment	17
Screen information	18
Video menu	19
Manual time setting	21
Setting the ON/OFF timer	22
Function menu	23
Closed caption	28
DTV setup menu	29
Other functions	34

DVD Operation

DVD Features.....	36
Special Playback Functions.....	38
DVD System Setup.....	39
Playable Discs.....	43
Disc Protection and DVD Characteristics.....	44



Others

Troubleshooting guide.....	45
Specifications	46
Warranty	47

IMPORTANT SAFEGUARDS

WARNING: TO REDUCE THE RISK OF FIRE OR ELECTRIC SHOCK, DO NOT EXPOSE THIS APPLIANCE TO RAIN OR MOISTURE.

	CAUTION RISK OF ELECTRIC SHOCK DO NOT OPEN	
CAUTION: TO REDUCE THE RISK OF ELECTRIC SHOCK, DO NOT REMOVE COVER (OR BACK). NO USER SERVICEABLE PARTS INSIDE. REFER SERVICING TO QUALIFIED SERVICE PERSONNEL		

	This symbol indicates that dangerous voltage constituting a risk of electrical shock is present in this unit.
	This symbol indicates there are important operating and maintenance instructions in packaged with this product.

Caution - Use of controls or adjustments or performance of procedures other than those specified herein may result in hazardous radiation exposure

Product complies with radiation performance standards under the Federal Food, Drug and Cosmetic Act

1. READ THESE INSTRUCTIONS

All the safety and operating instructions should be read before the unit is operated.

2. KEEP THESE INSTRUCTIONS

The safety and operating instructions should be retained for future reference.

3. HEED ALL WARNINGS

All warnings on the unit and in the operating instructions should be adhered to.

4. FOLLOW ALL INSTRUCTIONS

All operating and use instructions should be followed.

5. CLEAN ONLY WITH DRY CLOTH.

Unplug this unit from the wall outlet before cleaning. Do not use liquid cleaners or aerosol cleaners.

Use a damp cloth for cleaning the exterior cabinet only.

6. DO NOT BLOCK ANY VENTILATION OPENINGS. INSTALL IN ACCORDANCE WITH THE MANUFACTURER'S INSTRUCTIONS.

7. DO NOT USE THIS APPARATUS NEAR WATER

Do not use this unit near water. For example, near a bathtub, washbowl, kitchen sink, laundry tub, in a wet basement, or near a swimming pool.

8. Do not install near any heat sources such as radiators, heat registers, stoves, or other apparatus (including amplifiers) that produce heat.

9. Only use attachments/accessories specified by the manufacturer.

10. Use only with the cart, stand, tripod, bracket, or table specified by the manufacturer, or sold with the apparatus. When a cart is used, use caution when moving the cart/apparatus combination to avoid injury from tip-over.

11. VENTILATION

Slots and openings in the cabinet back or bottom are provided for ventilation, to ensure reliable operation of the unit, and to protect it from overheating.

These openings must not be blocked or covered. The openings should never be blocked by placing the unit on a bed, sofa, rug, or other similar surface. This unit should never be placed near or over a radiator or heat source. This unit should not be placed in a built-in installation such as a bookcase or rack unless proper ventilation is provided and/or the manufacturer's instructions have been adhered to.

12. POWER SOURCES

This unit should be operated only from the type of power source indicated on the rating plate. If you are not sure of the type of power supply to your home, consult your appliance dealer or local power company. For units intended to operate from battery power, or other sources, refer to the operating instructions.

PORTABLE CART WARNING
(symbol provided by RETAC)



S3126A

Important safety Instructions

13. GROUNDING OR POLARIZATION

Do not defeat the safety purpose of the polarized or grounding-type plug. A polarized plug has two blades with one wider than the other. A grounding type plug has two blades and a third grounding prong. The wide blade or the third prong are provided for your safety. If the provided plug does not fit into your outlet, consult an electrician for replacement of the obsolete outlet.

14. Protect the power cord from being walked on or pinched particularly at plugs, convenience receptacles, and the point where they exit from the apparatus.

15. Unplug this apparatus during lightning storms or when unused for long periods of time.

16. Refer all servicing to qualified service personnel. Servicing is required when the apparatus has been damaged in any way, such as power-supply cord or plug is damaged, liquid has been spilled or objects have fallen into the apparatus, the apparatus has been exposed to rain or moisture, does not operate normally, or has been dropped.

17. POWER LINES

An outside antenna system should not be located in the vicinity of overhead power lines or other electric light or power circuits, or where it can fall onto or against such power lines or circuits. When installing an outside antenna system, extreme care should be taken to keep from touching such power lines or circuits, as contact with them might be fatal.

18. OVERLOADING

Do not overload wall outlets and extension cords, as this can result in a risk of fire or electric shock.

19. OBJECT AND LIQUID ENTRY

Do not push objects through any openings in this unit, as they may touch dangerous voltage points or short out parts that could result in fire or electric shock. Never spill or spray any type of liquid into the unit.

20. OUTDOOR ANTENNA GROUNDING

If an outside antenna or cable system is connected to the unit, be sure the antenna or cable system is grounded to provide some protection against voltage surges and built-up static charges, Section 810 of the National Electrical Code (NEC), ANSI/NFPA 70, provides information with respect to proper grounding of the mast and supporting structure, grounding of the lead-in wire to an antenna discharge unit, size of grounding conductors, location of antenna discharge unit, connection to grounding electrodes, and requirements for the grounding electrode.

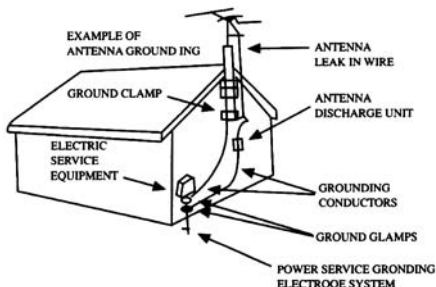

21. SERVICING

Do not attempt to service this unit yourself as opening or removing covers may expose you to dangerous voltage or other hazards. Refer all servicing to qualified service personnel.

Important safety Instructions

22. DAMAGE REQUIRING SERVICE

Unplug this unit from the wall outlet and refer servicing to qualified service personnel under the following conditions:

- a. When the power-supply cord or plug is damaged.
- b. If liquid has been spilled, or objects have fallen into the unit.
- c. If the unit has been exposed to rain or water.
- d. If the unit does not operate normally by following the operating instructions. Adjust only those controls that are covered by the operating instructions, as an improper adjustment of other controls may result in damage and will often require extensive work by a qualified technician to restore the unit to its normal operation.
- e. If the unit has been dropped or the cabinet has been damaged.
- f. When the unit exhibits a distinct change in performance, this indicates a need for service.

23. REPLACEMENT PARTS

When replacement parts are required, be sure the service technician uses replacement parts specified by the manufacturer or those that have the same characteristics as the original part. Unauthorized substitutions may result in fire, electric shock or other hazards.

24. SAFETY CHECK

Upon completion of any service or repairs to this unit, ask the service technician to perform safety checks to determine that the unit is in proper operating condition.

25. HEAT

The product should be situated away from heat sources such as radiators, heat registers, stoves, or other products (including amplifiers) that produce heat.

26. DISC SLOT

Keep your fingers well clear of the disc slot as it is closing. It may cause serious personal injury.

27. CONNECTING

When you connect the product to other equipment, turn off the power and unplug all of the equipment from the wall outlet. Failure to do so may cause an electric shock and serious personal injury. Read the owner's manual of the other equipment carefully and follow the instructions when making any connections.

28. SOUND VOLUME

Reduce the volume to the minimum level before you turn on the product. Otherwise, sudden high volume sound may cause hearing or speaker damage.

29. SOUND DISTORTION

Do not allow the product output distorted sound for a longtime. It may cause speaker overheating and fire.

30. LASER BEAM

Do not look into the opening of the disc slot or ventilation opening of the product to see the source of the laser beam. It may cause sight damage.

31. DISC

Do not use a cracked, deformed, or repaired disc. These discs are easily broken and may cause serious personal injury and product malfunction.

32. NOTE TO CABLE TV SYSTEM INSTALLER

This reminder is provided to call the Cable TV system installer's attention to Article 820-40 of the NEC that provides guidelines for proper grounding and, in particular, specifies that the cable ground shall be connected to the grounding system of the building, as close to the point of cable entry as practical.

Installation

Antenna connection

If the picture is not clear or is snowy, it is recommended that an External Aerial is used, this is usually mounted outside.

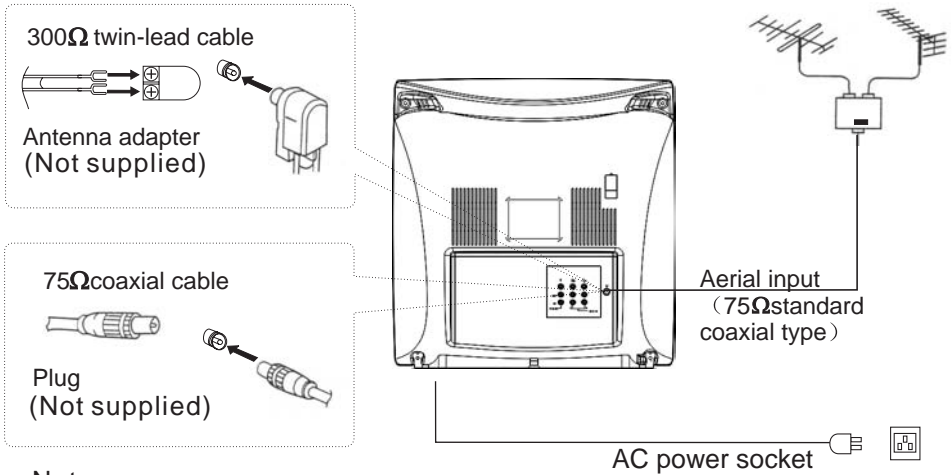

Note:

* It is recommended that a 75 ohm coaxial antenna is used to avoid interference.

* To avoid interference from electrical signals, do not bind the antenna cable together with any mains lead.

Preparation for the remote control

Battery installation

- Remove the battery cover.
- Insert two size AA batteries matching the +/- polarities of the battery to the +/- marks inside the battery compartment.

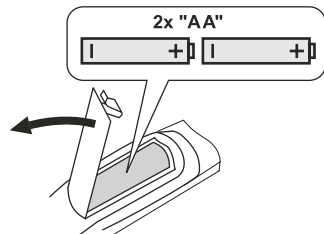

Tips for remote operation

- When the remote control will not be used for a long period of time or when the batteries are worn out, remove the batteries to prevent leakage.
- Do not throw the batteries into fire. Dispose of used batteries in the specified manner.
- Do not drop, dampen or disassemble the remote control.

Front panel the TV set

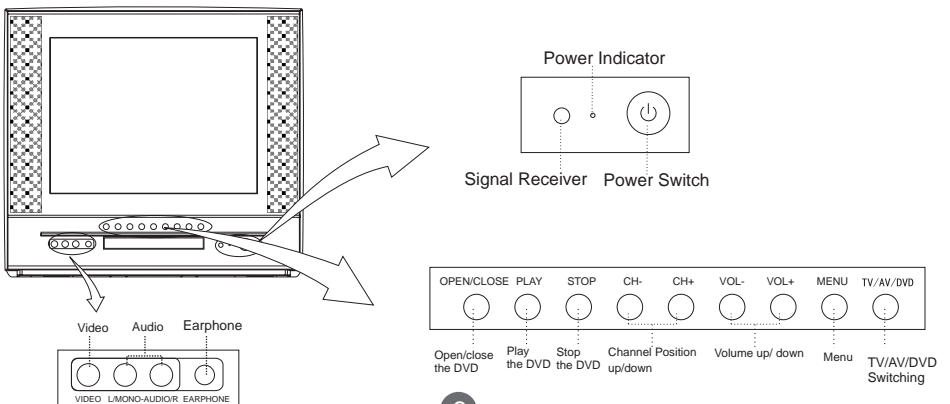
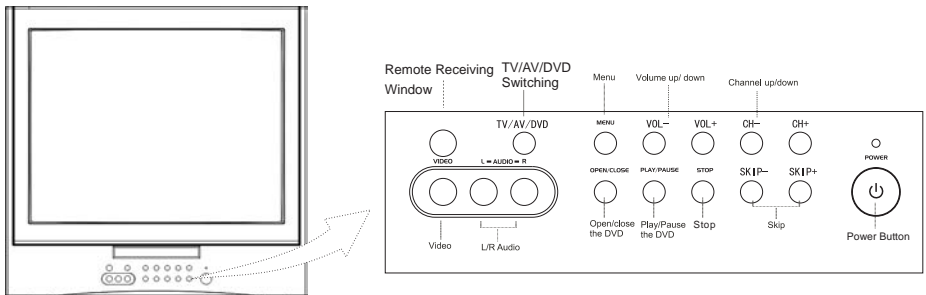
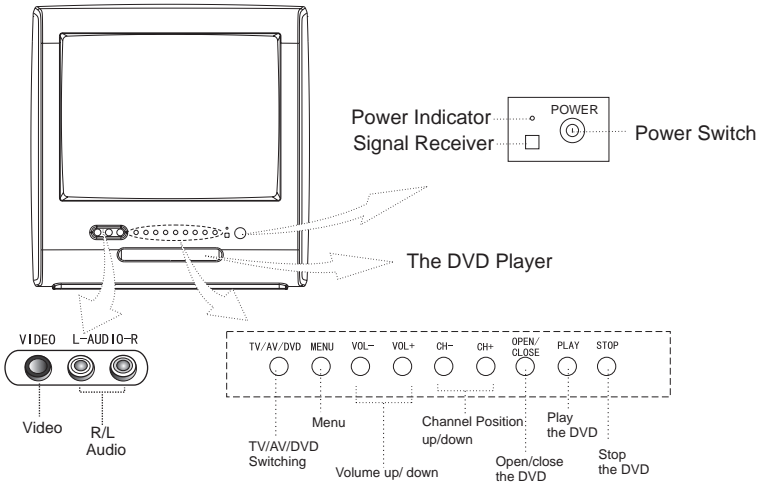

Parts and functions

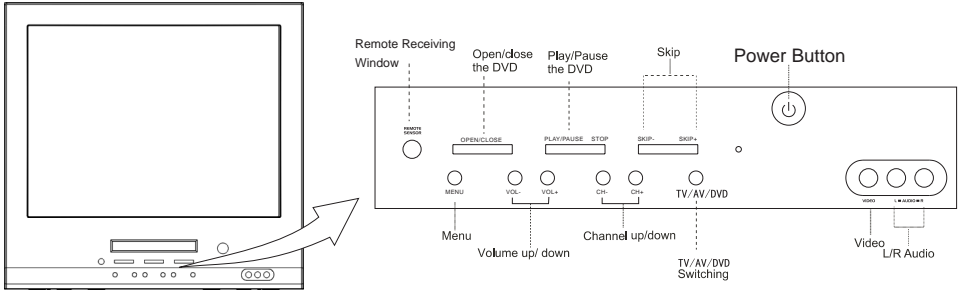

Rear panel of the TV set

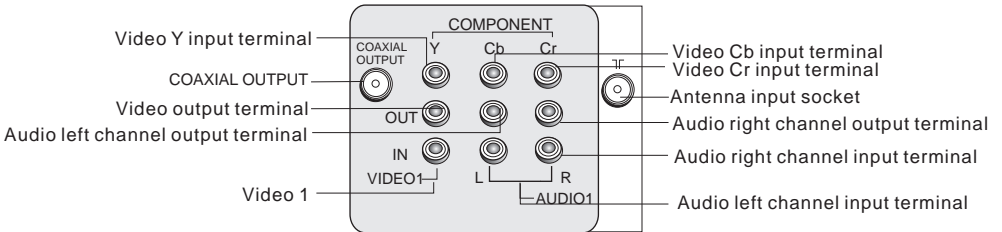

Using the Remote Control

Buttons on the remote control

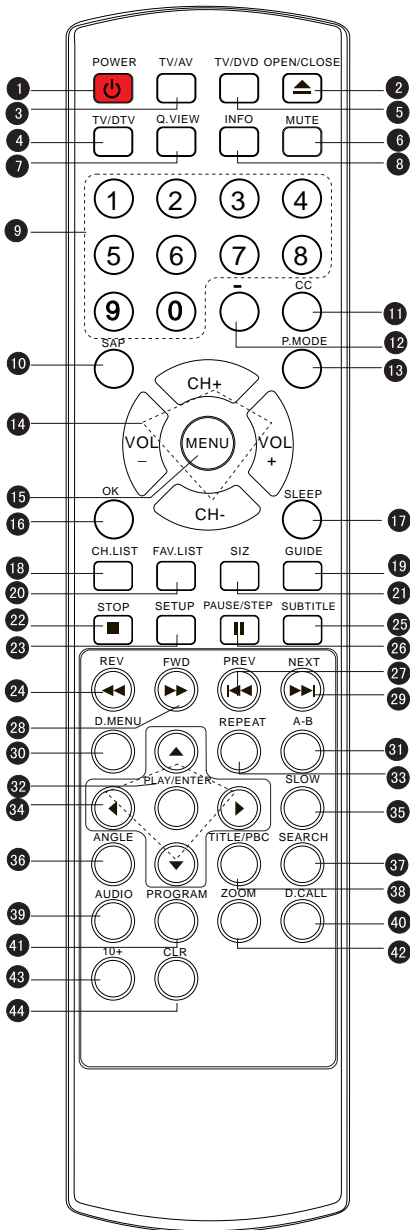

- 1 Power Switch
- 2 Open/close DVD Tray
- 3 TV / AV Mode Selection
- 4 TV / DTV Mode Selection
- 5 TV / DVD Mode Selection
- 6 Mute Sound
- 7 Q.VIEW button: Return to Previous Channel
- 8 On Screen Display
- 9 Channel / Track Selection
- 10 SAP button: Second Audio Program
- 11 CC Mode Selection: Closed captioning (selects mode).
- 12 - button: select additional channels being broadcasted. For example, to select channel "54-3", press "54", "-", "3", and then press "OK".
- 13 P.MODE (picture mode): Adjust Picture Mode
- 14 Volume/Channel Adjusting
- 15 Go to TV Menu
- 16 Exit On Screen Display
- 17 TV Sleep button
- 18 CH.LIST (channel list)
- 19 GUIDE reference (may not operate using some systems)
- 20 FAV.LIST (favorite list) Enter
- 21 SIZ: Aspect Ratio Control under 16:9 digital signal input
- 22 DVD STOP Playback
- 23 DVD SETUP
- 24 DVD FAST REVERSE
- 25 DVD CAPTION (SUBTITLE) Selection
- 26 DVD PAUSE/STEP
- 27 DVD PREVIOUS Chapter / Track
- 28 DVD FAST FORWARD
- 29 DVD NEXT Chapter / Track
- 30 DVD MENU
- 31 DVD A-B REPEAT
- 32 DVD Playback / Confirm Menu Selection
- 33 DVD REPEAT Mode
- 34 DVD Cursor Move button
- 35 DVD SLOW
- 36 DVD ANGLE Change
- 37 DVD SEARCH
- 38 DVD TITLE
- 39 DVD AUDIO Mode
- 40 DVD INFORMATION
- 41 DVD PROGRAM
- 42 Zoom Function
- 43 10+
- 44 CLR: clear

The other video and audio equipment Connections

- You can connect the DVD, VCR and stereo system to the output to enjoy a higher quality of picture and sound effect.

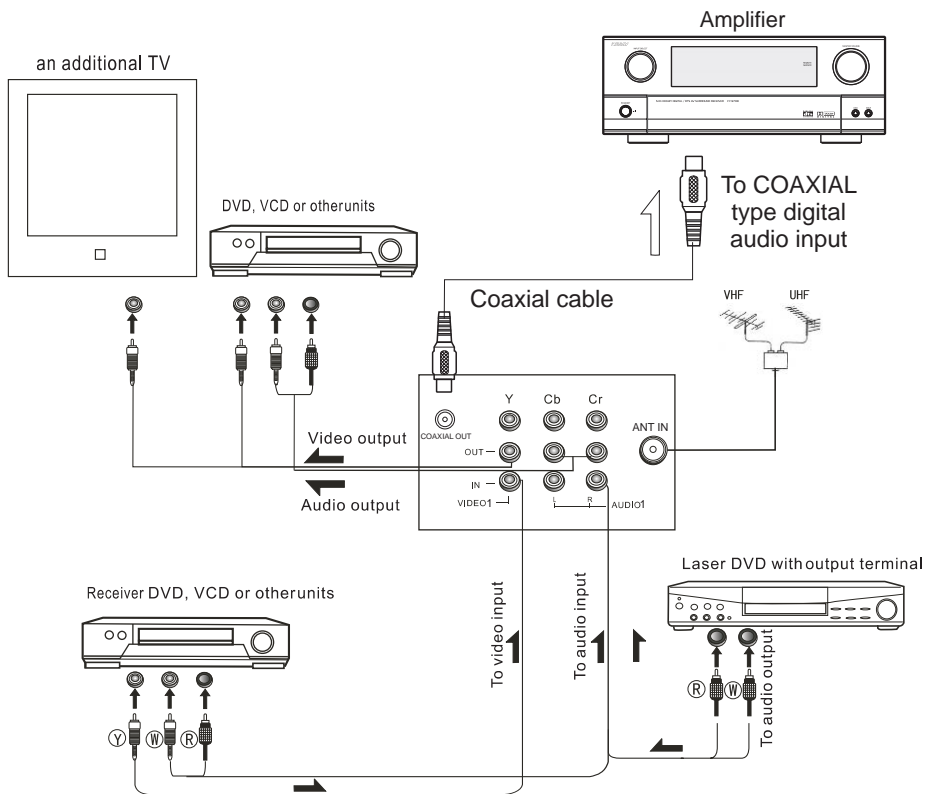

Antenna connections

If you are using an indoor or outdoor antenna, follow the instructions below that correspond to your antenna system. If you are using a cable TV service (CABLE), see the Cable TV connections.

Combination VHF/UHF antenna (Single 75 ohm cable or 300 ohm twin-lead wire)

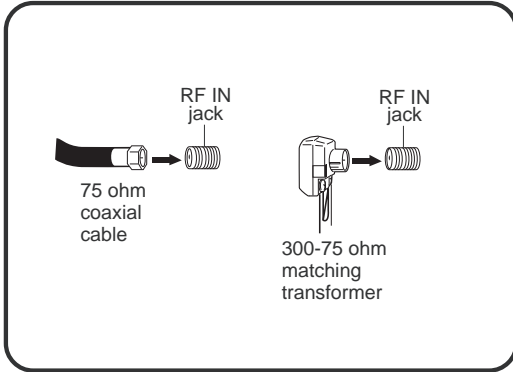

Connect the 75 ohm cable from the combination VHF/UHF antenna to the RF IN jack.

If using a flat UHF 300 ohm twin-lead wire, connect these flat wires to an optional 75/300 ohm matching transformer/adapter (available at many retailers), and then connect the adapter to the 'RF' IN connector on the back of the television.

Combination VHF/UHF antenna (Separate VHF and UHF 300 ohm twin-lead wires)

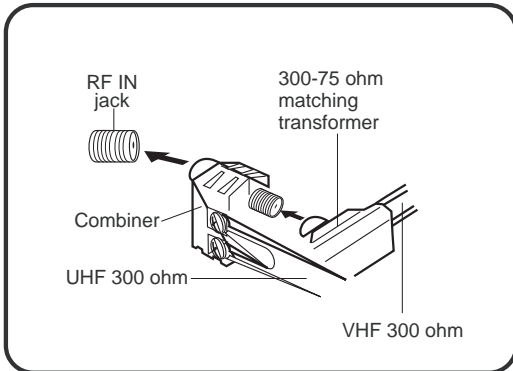

Connect the UHF 300 ohm twin-lead wire to the combiner (not supplied). Connect the VHF 300 ohm twin-lead wire to the 300-75 ohm matching transformer. Attach the transformer to the combiner, then attach the combiner to the RF IN jack.

Separate VHF/UHF antennas (75 ohm VHF cable and 300 ohm UHF twin-lead wires)

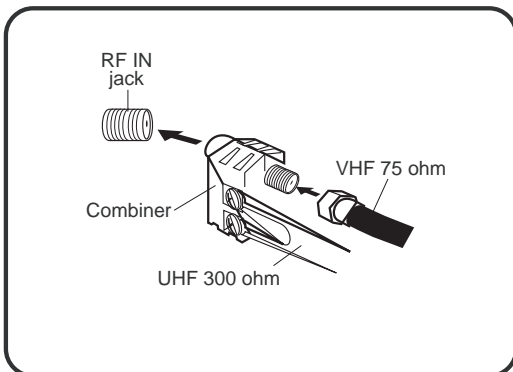

Connect the VHF 75 ohm cable and UHF 300 ohm twin-lead wire to the combiner. Attach the combiner to the RF IN jack.

Cable TV connections

This unit has an extended tuning range and can tune most cable channels without using a Cable TV Converter box. Some cable companies offer "premium pay channels" in which the signal is scrambled. Descrambling these signals for normal viewing requires the use of a descrambler device which is generally provided by the cable company.

FOR SUBSCRIBERS TO BASIC CABLE TV SERVICE

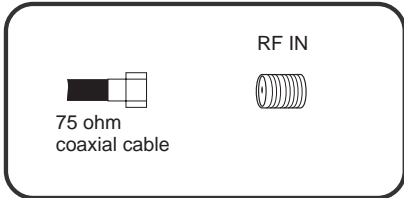

For basic cable service not requiring a Converter/Descrambler box, connect the 75 ohm Coaxial Cable directly to the RF IN Jack on the back of the unit.

FOR SUBSCRIBERS TO SCRAMBLED CABLE TV SERVICE

If you subscribe to a cable TV service which requires the use of a converter/descrambler box, connect the incoming 75 ohm coaxial cable to the converter/descrambler box. Using another 75 ohm coaxial cable, connect the output jack of the converter/descrambler box to the RF IN jack on the unit. Follow the connections shown below. Set the unit to the output channel of the converter/descrambler box (usually channel 3 or 4) and use the converter/descrambler box to select channels.

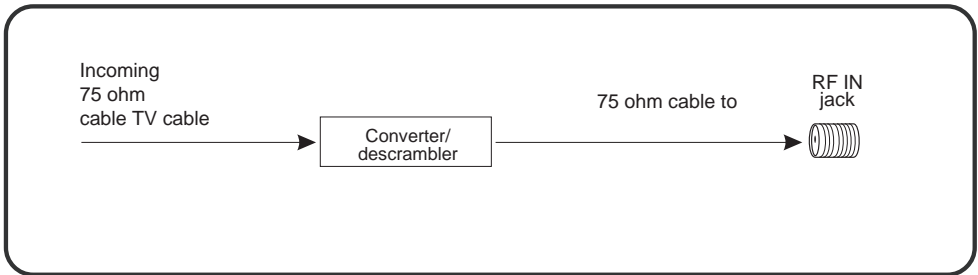

FOR SUBSCRIBERS TO UNSCRAMBLED BASIC CABLE TV SERVICE WITH SCRAMBLED PREMIUM CHANNELS

If you subscribe to a cable TV service in which basic channels are unscrambled and premium channels require the use of a converter/descrambler box, you may wish to use a signal splitter and an A/B switch box (available from the cable company or an electronics supply store). Follow the connections shown below. With the switch in the "B" position, you can directly tune any nonscrambled channels on your unit. With the switch in the "A" position, tune your unit to the output of the converter/descrambler box (usually channel 3 or 4) and use the converter/descrambler box to tune scrambled channels.

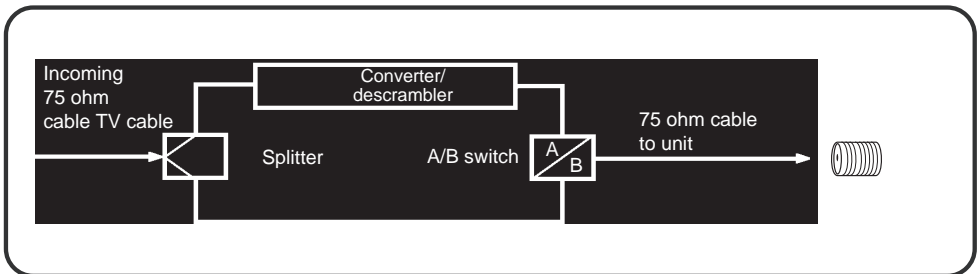

Connections to other equipment

Using the audio/video inputs

If you connect the TV to a camcorder or Video Game, you can select different modes by pressing **TV/AV**.

Press **TV/AV** repeatedly to select the desired mode.

"AV1", "AV2", "COMPONENT", "DVD" or TV channel will display on the screen for 4 seconds, "no signal" will be displayed on the screen when no signal input.

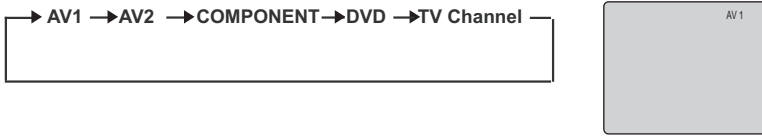

To connect the TV to a camcorder

To playback from the camcorder, connect the camcorder to the unit as shown.

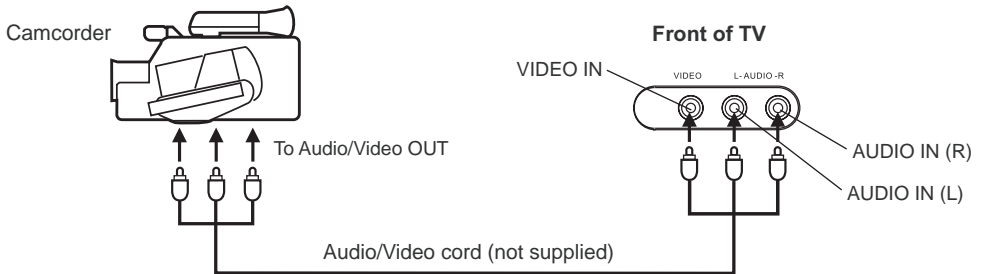

To connect the TV to a Video Game

The TV can also be used as a display device for many video games. However, due to the wide variety of formats, they have not all been included in the suggested connection diagram. You need to consult each component's Owner's Manual for additional information.

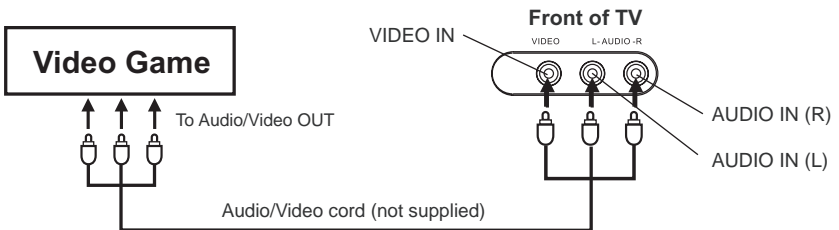

Setting the language and blue screen

You can choose from three different languages (English, French and Spanish) for the on-screen displays.

SETTING THE LANGUAGE

1 Press **POWER** (⏻) to turn on the TV.

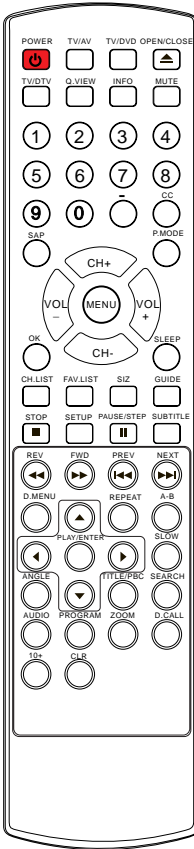

2 Press **MENU**, and then press **VOL+/-** button to select **FUNCTION** menu, then press **CH-** button to enter.

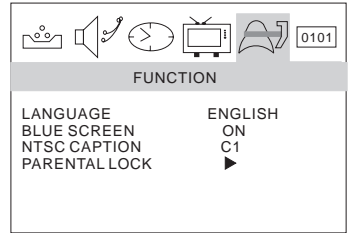

3 Press **CH+/-** button to select the **LANGUAGE** option, then press **VOL+/-** to select the desired language: **English, Spanish or French**.

4 Press **MENU** until the MENU screen disappears.

SETTING THE BLUE SCREEN

1 Press **MENU**, and then press **VOL+/-** button to select **FUNCTION** menu, then press **CH-** button to enter.

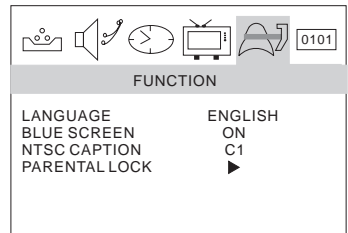

2 Press **CH+/-** button to select the **BLUE SCREEN** option, then press **VOL+/-** to select **OFF** or **ON**.

3 Press **MENU** until the MENU screen disappears.

Here describes the case for searching and memorizing channels for DTV/ATV.

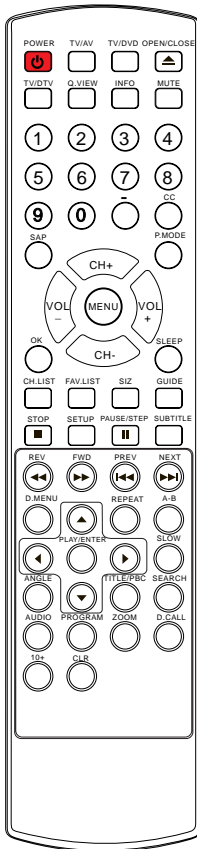

■ AUTO SCAN (DTV/ATV)

(When using antenna)

The channels broadcasted in DTV and ATV are automatically scanned and memorized. Only the receivable channels in the area where this TV is used will be memorized.

■ AUTO SCAN (CATV)

(When using basic cable)

The channels broadcasted in CATV are automatically scanned and memorized.

NOTE:

Be sure that antenna or cable is connected properly before plugging the power cord.

1 Press **MENU**, and then press **VOL +/-** button to select **CHANNEL** menu, then press **CH-** button to enter.

2 Press **CH +/-** button to select the **RECEPTION** option.

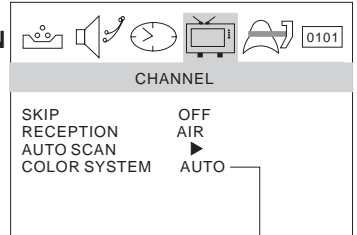

3 Press **VOL +/-** button to select **AIR/ CABLE**.

4 Press **CH +/-** button to select **AUTO SCAN** option.

Only in analog signal

5 Press **VOL+** button to start scanning.

When you press **VOL+** on the remote control, scanning the channels in both analog and digital modes will automatically start.

When scanning is completed, the memorized smallest channel will be displayed.

When you press **MENU** button while scanning, the scanning is interrupted and the memorized smallest channel is displayed.

Channel menu

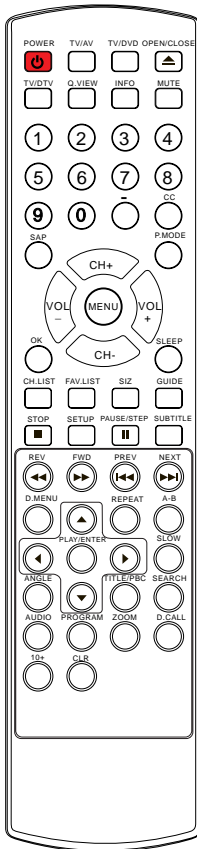

SETTING SKIP

After the programs are presetting, you can skip some programs so that to select your favorite channels only.

- 1 Press **MENU**, and then press **VOL+/-** button to select **CHANNEL** menu, then press **CH-** button to enter.

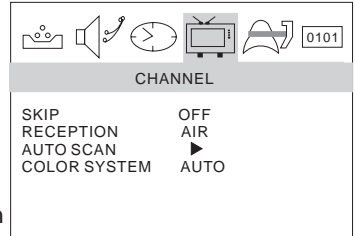

- 2 Press **CH+/-** button to select the **SKIP** option, then press **VOL+/-** button to select **ON** or **OFF**.

NOTE: When tuning DTV channels and no signal is present, the SKIP-over option will be available.

If you want to recover the skipped channel

1. Use Direct-digit Choosing button to select the number of the channel to be recovered.
2. Do the above steps again.
3. Press **VOL+/-** button to set **SKIP** as **Off**.

SETTING COLOR SYSTEM(only in ATV mode)

- 1 Press **MENU**, and then press **VOL+/-** button to select **CHANNEL** menu, then press **CH-** button to enter.

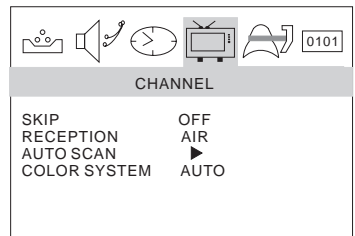

- 2 Press **CH+/-** button to select the **COLOR SYSTEM** option, then press **VOL+/-** button to select **AUTO** or **NTSC**.

Channel selection

You can select the channel by using either **CH +/-** button or **Channel number** buttons. How to select the channel in each way is shown below.

1 Using CH +/- button

- Using **CH +/-** button on the remote control, change the channel.
- Same operation is available with **CH +/-** button on the front panel of the main unit.

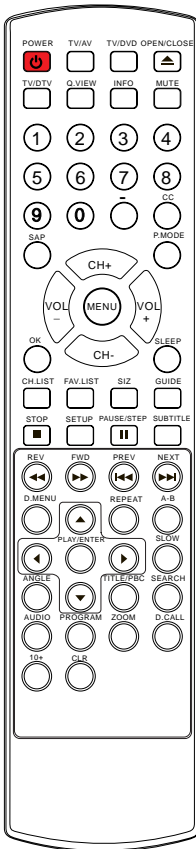

2 Press the Direct Channel selection buttons to select the channel.

Antenna Mode Direct Channel Selection

When the Antenna/Cable menu option is in the Antenna position, all channels can be instantly selected by using digits button. For example:

2-9: Press 2-9 as needed.

Example, to select channel 2, press "2".

10-69: Press the 2 digits in order. If you select the channel more than 69, the channel will not be change, it is no available.

CABLE Mode Direct Channel Selection

When the Antenna/Cable menu option is in the Cable position, channels can be selected as follows:

1-9: Press 1-9 as needed. Example, to select channel 2, press "2".

10-99: Press the 2 digits in order. Example, to select channel 32, press "3" then "2".

100-125: Press the digital 1 button, the "1--" will appear on the screen, then press the 2 digits of remain in order.

TV	CABLE
VHF 2-13	VHF 2-13
UHF 14-69	STD/HRC/IRC 14-36 (A) (W) 37-59 (AA) (WW) 60-85 (AAA) (ZZZ) 86-94 (86) (94) 95-99 (A-5) (A-1) 100-125 (100) (125) 01 (5A)

NOTE:

In the DTV broadcasting, one channel sometimes broadcasts multiple programs depending on the air time. In this case, the main channel is called major channel and the sub channel is called minor channel.

Volume adjustment

This section describes how to adjust the volume when viewing TV. The **MUTE** function, which is useful when you have a visitor or a phone call, will be also described.

1 Using **VOL +/-** button

- You can adjust the audio volume with **VOL +/-** button on the remote control.

- The volume bar is displayed at the bottom of the screen when adjusting the volume.

- Same operation is available with **VOL +/-** on the front panel of the main unit.

2 Using **MUTE** button

- Press **MUTE** button on the remote control to mute the sound.

The colored volume bar is displayed on the screen while muting.

- To release the MUTE status, press **MUTE** button again or press **VOL+** button.

MUTE will displayed continuously When CC is OFF, MUTE will disappeared 5 seconds later When CC is ON.

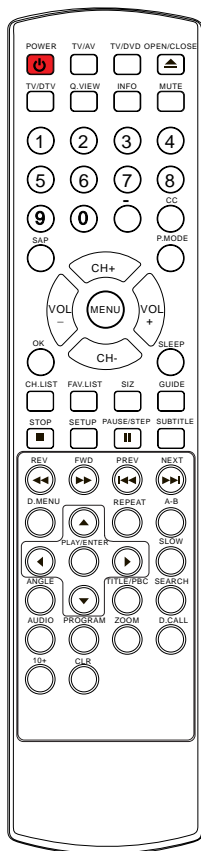

SWITCHING AUDIO

This section describes how to switch the audio language in the digital mode.

2 Switch the audio language.

- When you press **SAP** button on the remote control, the currently selected language and the number of received languages will be displayed on the screen.

- Every time you press **SAP** button on the remote control, the language will be switched.

- Languages you can switch differ depending on the receiving broadcast.

NOTE:

Pressing the SAP button works only with the some TV channels, and does not work with external equipment such as DVD players.

Screen information

You can display the currently selected channel number or other information such as the audio mode on the screen for checking.

In the analog mode, the currently selected channel number and the audio mode are displayed.

1 Display the channel number and the audio mode.

- Press **INFO** button on the remote control. The currently selected channel number and the audio mode are displayed at the top right of the screen.

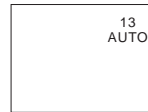
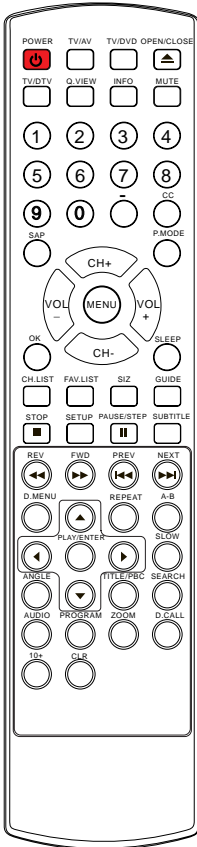

- To clear the display, press **INFO** button again.

In the digital mode, the detailed information for the currently selected channel such as the program **GUIDEe** is displayed.

Display the detailed information for the channel.

- Every time you press **INFO** button, the display mode will be switched as below.

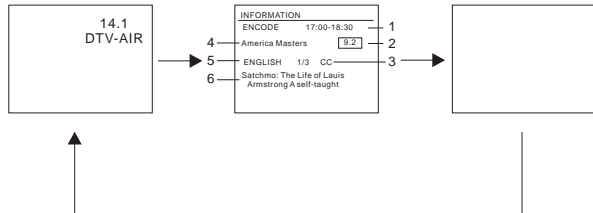

- The following information is displayed in the **INFO** mode.

- (1) Program air time
- (2) Channel number
- (3) Closed caption
- (4) Channel title
- (5) Audio language
- (6) Program content

NOTES:

- When the program guide is displayed in more than 6 lines, use **VOL+/-** button and scroll for reading.

- "No description provided" is displayed when the program guide is not provided.

Video menu

SETTING VIDEO

1 Press **MENU** button. The main menu screen will appear.

2 Press **VOL+/-** button to select **VIDEO** Option, then press **CH-** button to enter.

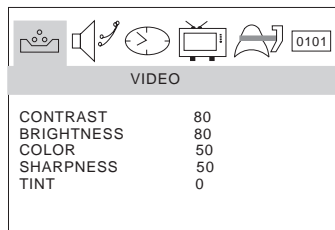

VIDEO	
CONTRAST	80
BRIGHTNESS	80
COLOR	50
SHARPNESS	50
TINT	0

3 Press **CH+/-** to select the desired option, then press **VOL+/-** to adjust.

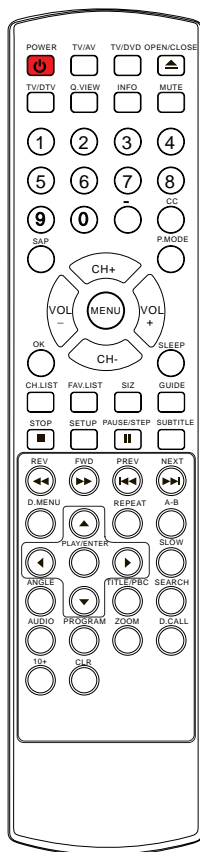

■ Contrast

This will adjust the intensity of bright parts in the picture but keep the dark parts unchanged.

■ Brightness

This will adjust the light output of the complete picture, which will mainly affect the darker areas of the picture.

■ Color

This will adjust the saturation level of the colors to suit your personal preference.

■ Sharpness

This will adjust the sharpness of fine details in the picture.

■ Tint

Allows you to select the color mix (Tint) of the picture.

SETTING AUDIO

1 Press **MENU** button. The main menu screen will appear.

2 Press **VOL+/-** button to select **AUDIO** Option, then press **CH-** button to enter.

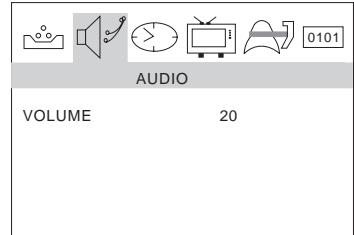

3 Press **CH+/-** to select the desired option, then press **VOL+/-** to adjust.

■ Volume

This will adjust the sound output level.

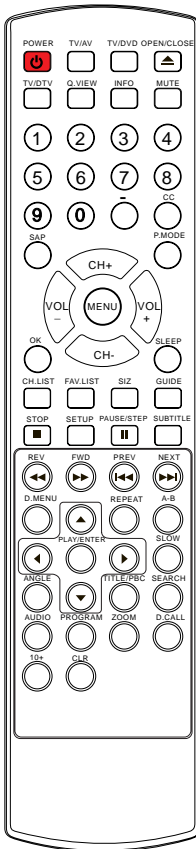

Manual time setting

You must set the time manually for ON/OFF Timer.

EXAMPLE: Setting the time to "8:30 AM"

TO SET TIME

1 Press **MENU**. The main menu screen will appear.

2 Press **VOL+/-** button to select **TIME** option, then press **CH-** button to enter the submenu.

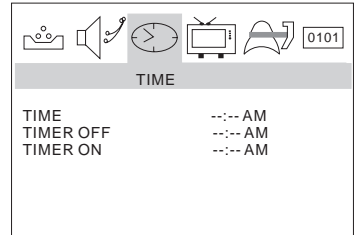

3 Press **CH+/-** button to select **TIME**, then press **CH+/-** button to select "--:--", "**AM**"; press **VOL+/-** button to set the value & AM & PM.

4 Press **MENU** until the MENU screen disappears.

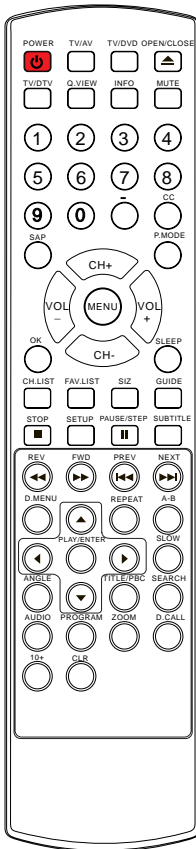

NOTE:

- After a power failure or disconnection of the power, the time will get lost. In this case, reset the preset time.

Setting the ON/OFF timer

This feature allows you to have the TV automatically turn on/off at a predetermined time. If you program the ON/OFF TIMER, the TV will turn on/off at the time your predetermined.

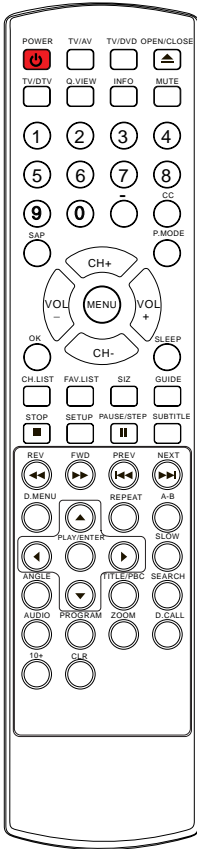

SETTING THE TIMER ON

1 Press **MENU**. The main menu screen will appear.

2 Press **VOL+/-** button to select **TIME** option, then press **CH-** button to enter the submenu.

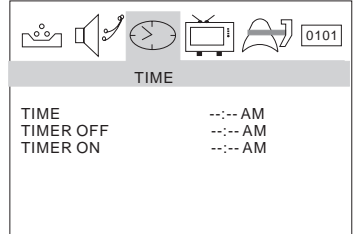

3 Press **CH+/-** button to select **TIME ON**, then press **CH+/-** button to select "---:--", "**AM**"; press **VOL+/-** button to set the value.

4 Press **MENU** until the MENU screen disappears.

SETTING THE TIMER OFF

1 Press **MENU**. The main menu screen will appear.

2 Press **VOL+/-** button to select **TIME** option, then press **CH-** button to enter the submenu.

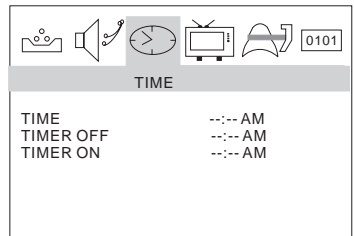

3 Press **CH+/-** button to select **TIME OFF**, then press **CH+/-** button to select "---:--", "**AM**"; press **VOL+/-** button to set the value.

4 Press **MENU** until the MENU screen disappears.

Function menu

SETTING THE NTSC CAPTION

This allows you to configure the way you choose to view the captioning.

1. Press the **MENU** button and then use **VOL+/-** button to select the **FUNCTION** menu.

2. Press **CH-** button to enter, then press **CH+/-** button to select **NTSC CAPTION**.

3. Then use **VOL+/-** button to select caption: **OFF, C1, C2, C MUTE, TEXT1, TEXT2**.

You can also press **CC** button on the remote control to select the desired caption.

4. When you are satisfied with your choice, press **MENU** button to return to the previous menu.

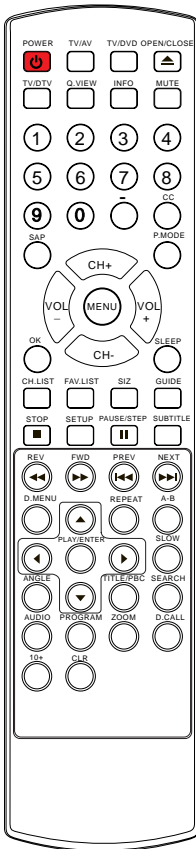
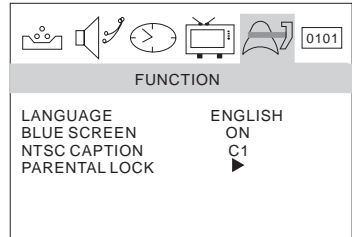

■ CAPTION

The term for the words that scroll across the bottom of the TV screen; usually the audio portion of the program provided for the hearing impaired.

■ TEXT

The term for the words that appear in a large black frame and almost cover the entire screen; usually messages provided by the broadcaster.

An age limitation can be set to forbid children to see and hear violent scenes or pictures for adults, etc. The TV Corresponds to "TV RATING" and "MOVIE RATING". to use the parental control function, you must register a password.

TO REGISTER PASSWORD

1 Press **MENU**. The main menu screen will appear.

2 Press **VOL+/-** to select **FUNCTION**, then press **CH-** to enter the submenu.

3 Press **CH+** to select **PARENTAL LOCK**, then press **VOL+** to enter the submenu.

4 Enter the password (4 digits) using the number buttons(0-9). The TV is set up with the initial password 0000.

5 After inputting password accurately, Press **CH+/-** to select the desired item.

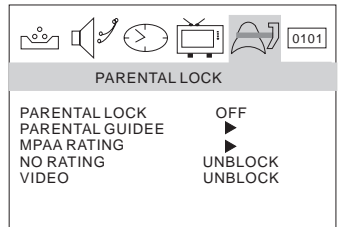
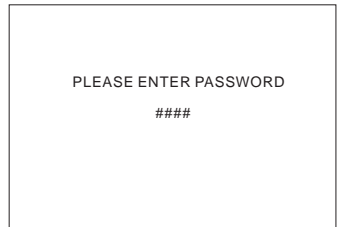
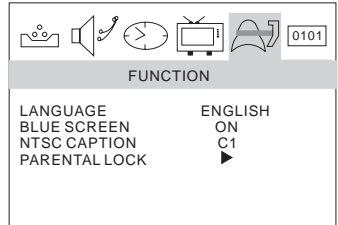
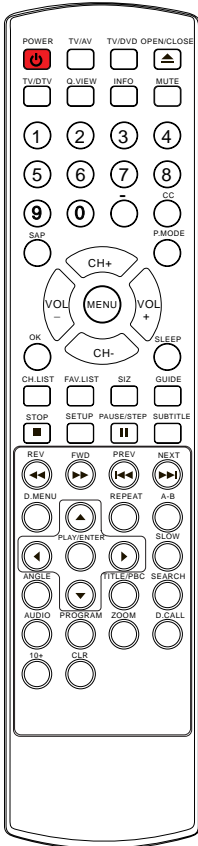

NOTES:

If you forget the password, you cannot set the Parent Control.

To avoid forgetting the password, write it down and keep it in a safe place.

Function menu

TO CHANGE PASSWORD

1 Press **MENU**. The main menu screen will appear.

2 Press **VOL+/-** to select **FUNCTION**, then press **CH-** to enter the submenu.

3 Press **CH+** to select **PARENTAL LOCK**, then press **VOL+** to enter the submenu.

4 Enter the password (4 digits) using the number buttons(0-9).

5 Press **CH+** to select **CHANGE PASSWORD**, then press **VOL+** to enter the submenu.

6 Enter the new password using the **number buttons(0-9)**.

7 Enter again the new password.

8 Press **MENU** until the MENU screen disappears.

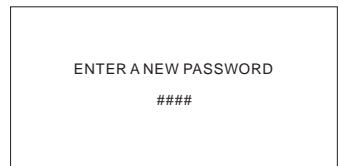
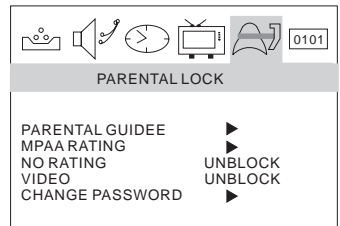
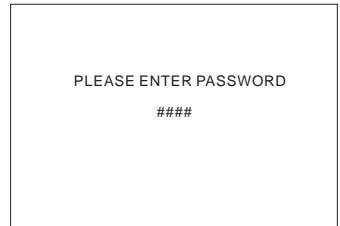
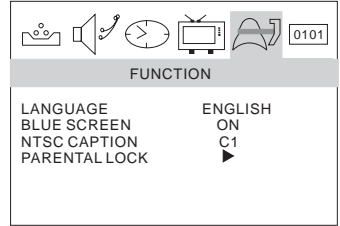
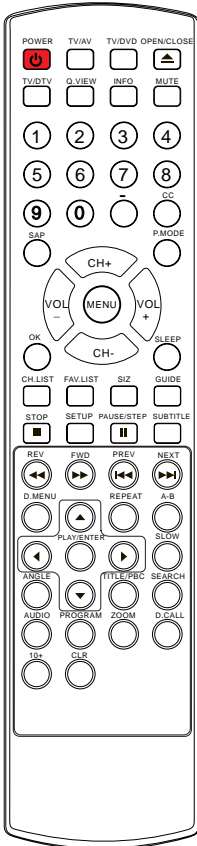

NOTES:

- If you forget the password, you cannot set the Parent Control.
- To avoid forgetting the password, write it down and keep it in a safe place.

TO SET PARENTAL CONTROL ON/OFF

1 Enter the **PARENT CONTROL** menu.

2 press **CH+/-** button to select **PARENTAL LOCK**, press **VOL+/-** button to set **ON** or **OFF**.

3 When you are satisfied with your choice, press **MENU** button to return to the previous menu.

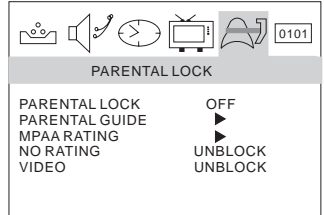

TO SET PARENTAL GUIDE

1 Enter the **PARENT CONTROL** menu.

2 press **CH+/-** button to select **PARENTAL GUIDE**, press **VOL+/-** button to enter the submenu.

3 press **CH+/-/VOL+/-** button to set the desired ratings.

4 When you are satisfied with your choice, press **MENU** button to return to the previous menu.

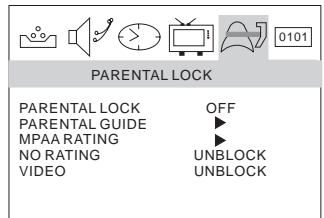

RATING						
	ALL	FV	D	L	S	V
TV-MA	✓			✓	✓	✓
TV-14	✓		✓	✓	✓	✓
TV-PG	✓		✓	✓	✓	✓
TV-G	✓					
TV-Y7	✓	✓				
TV-Y	✓					

(✓: BLOCK)

Ratings for Television programs including made-for-TV movies :

- TV-Y (All children)
- TV-Y7 (Children 7 years older)
- TV-G (General audience)
- TV-PG (Parental GUIDeance suggested)
- TV-14 (Parents strongly cautioned)
- TV-MA (Mature audience only)

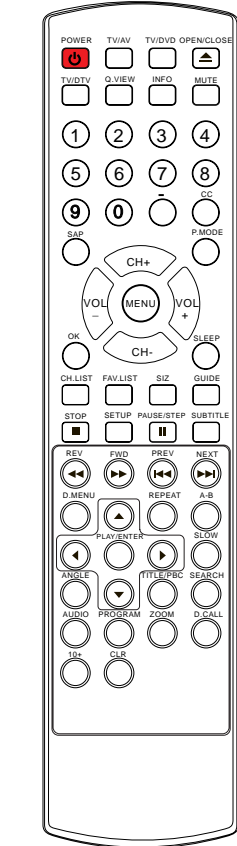

To use the TV after Parent Control is activated.

When the program applied to the Parental Control, setting is received, enter the password. When the password is entered correctly the protection will be temporarily overridden.

NOTE:

The Parental Control function is activated only on programs and tapes that support the rating.

TV Rating Children:

- ALL (Age) (applies to TV-Y, TV-Y7)
- FV (Fantasy Violence) (applies to TV-Y7)

TV Rating General:

- ALL (Age) (applies to TV-G, TV-PG, TV-14, TV-MA)
- D (Dialogue - sexual dialogue) (applies to TV-PG, TV-14)
- L (Language - adult language) (applies to TV-PG, TV-14, TV-MA)
- S (Sex - sexual situations) (applies to TV-PG, TV-14, TV-MA)
- V (Violence) (applies to TV-PG, TV-14, TV-MA)

Function menu

TO SET THE MPAA RATING

1 Enter the **PARENT CONTROL** menu.

2 Press **CH+/-** button to select **MPAA RATING**, then press **VOL+** button to enter the submenu.

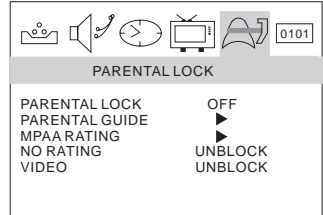

3 Press **CH+/-** button to select the desired rating.

Rating for Movies previously shown in theaters:

Movie Rating

- NR (Permits all programs)
- G (General audience)
- PG (Parental GUIDEance suggested)
- PG-13 (Parents strongly cautioned)
- R (Restricted)
- NC-17 (No one 17 and under admitted)
- X (Adult only)

MPAA RATING

- MPAA-X ✓
- MPAA-NC-17 ✓
- MPAA-R ✓
- MPAA-PG-13 ✓
- MPAA-PG ✓
- MPAA-G ✓
- MPAA-NR ✓

(✓: BLOCK)

If you set PG-13 : G and PG movies will be available , PG-13, R, NC-17 and X will be blocked.

4 Press **VOL+/-** button to select delete or ✓.

5 Press **MENU** until the MENU screen disappears.

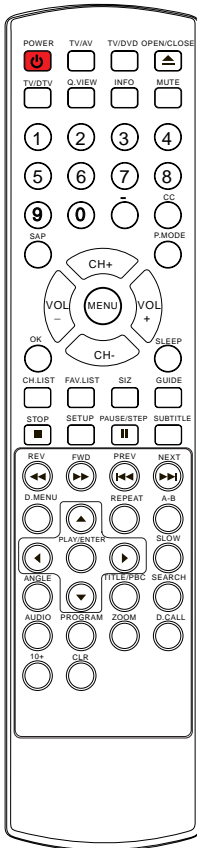

Closed caption

WHAT IS CLOSED CAPTIONING?

This television has the capability to decode and display closed captioned television programs. Closed captioning will display text on the screen for hearing impaired viewers or it will translate and display text in another language.

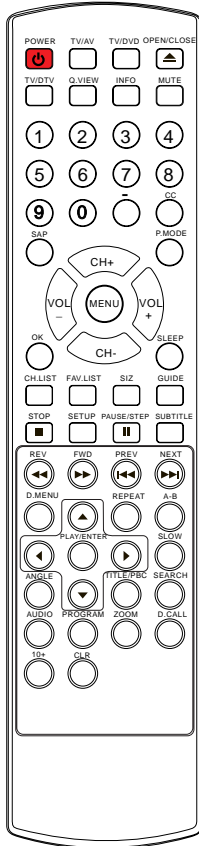

Captions: This closed caption mode will display text on the screen in English or another language (depending on the setting of the closed captions).

Generally, closed captions in English are transmitted on captions CC 1 and closed captions in other languages are transmitted on Captions CC 2.

Text: The text closed caption mode will usually fill the screen with a programming schedule or other information.

After selecting a closed caption mode, it will stay in effect until it is changed, even if the channel is changed.

If the captions signal is lost due to a commercial or a break in the signal, the captions will reappear when the signal is received again. If the channels are changed, the captions will be delayed approximately 10 seconds. The captions will appear in places on the screen where they will least interfere with the picture, usually on the bottom of the screen. News programs will usually show three-line closed captions which scroll onto the screen.

Most other shows provide two or three lined captions placed near the character who is speaking so the viewer can follow the dialogue. Words in italics or underlined describe titles, words in foreign languages or words requiring emphasis. Words that are sung usually appear enclosed by musical notes.

For television programs broadcasting with closed captions, look in your TV GUIDE for the closed captions symbol (CC).

NOTES:

- When selecting closed captions, the captioning will be delayed approximately 10 seconds.
- If no caption signal is received, no captions will appear, but the television will remain in the caption mode.
- Misspellings or unusual characters may occasionally appear during closed captioning. This is normal with closed captioning, especially with live programs. This is because during live programs, captions are also entered live. These transmissions do not allow time for editing.
- When captions are being displayed, on-screen displays, such as volume and mute may be hidden. If the OSD display appears, the closed caption will disappear, when the OSD disappears, the Closed Caption will appear again.
- Some cable systems and copy protection systems may interfere with the closed captioned signal.
- If using an indoor antenna or if TV reception is very poor, the closed caption decoder may not appear or may appear with strange characters or misspelled words. In this case, adjust the antenna for better reception or use an outdoor antenna.

DTV setup menu

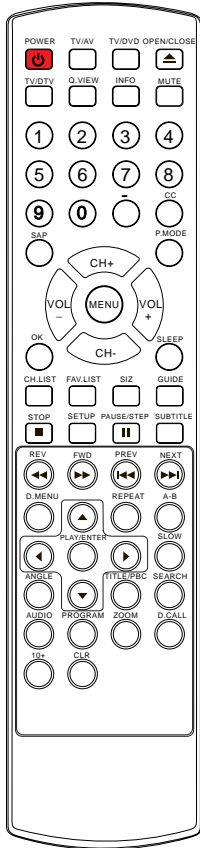

SETTING CLOSED CAPTION MODE

In DTV mode

1 Press **MENU**. The main menu screen will appear.

2 Press **VOL+/-** button to select **DTV SETUP**, then press **CH-** button to enter the submenu.

3 Press **CH+/-** button to select **DTV CC**.

4 Press **VOL+** button and then press **CH+/-** button to select **CAPTION MODE**.

5 Press **VOL+** button and then press **VOL+/-** button to set the **CLOSED CAPTION "OFF" or "ON"**.

When setting on, the DTV CC option will be available.

6 Press **CH+/-** button to select **DTV CC** and press **VOL+/-** button to set the desired service.

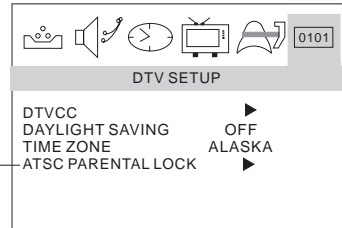

It only appears when the broadcasting signal bears.

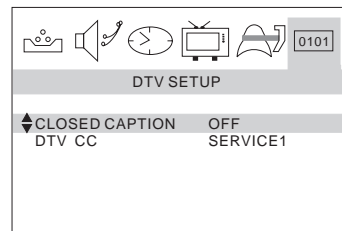
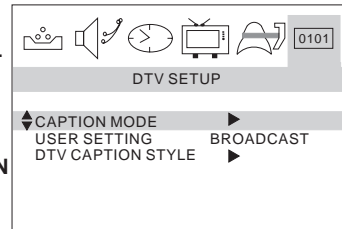

SETTING DTV CC

This allows you to configure the way you choose to view the digital captioning.

Select one of the digital service channels made available by the caption provider.

There are 6 standard services. Service 1 is designated as the Primary Caption Service. This service contains the verbatim, or near-verbatim captions for the primary language being spoken in the accompanying program audio.

Service 2 is designated as the Secondary Language Service. This service contains captions in a secondary language which are translations of the captions in the primary Caption Service. The other service subchannels are not pre-assigned. It is up to the discretion of the individual caption provider to utilize the remaining service channels.

SETTING THE CC USER SETTING

1 Press **MENU**. The main menu screen will appear.

2 Press **VOL+/-** button to select **DTV SETUP**, then press **CH-** button to enter the submenu.

3 Press **CH+/-** button to select **DTV CC**.

4 Press **VOL+** button and then press **CH+/-** button to select **USER SETTING**.

5 Press **VOL+/-** button to set "**BROADCAST**" or "**CUSTOM**".

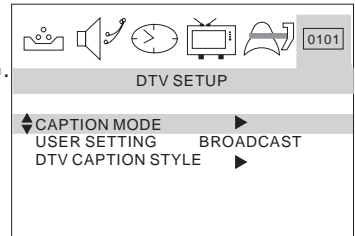
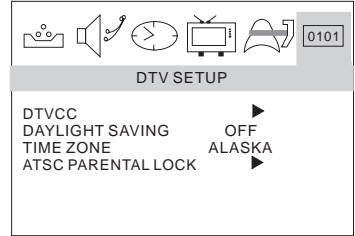
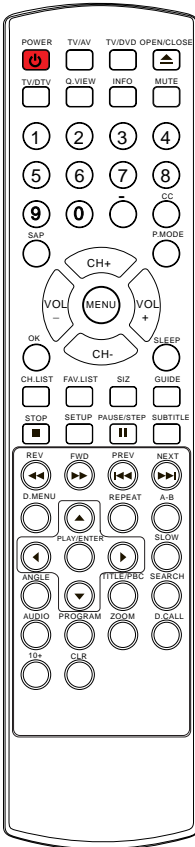

SETTING THE DTV CAPTION STYLE

- The DTV caption style function lets you change the caption size and font style.
- When "**USER SETTING**" is set to **CUSTOM**, you can set the following items.

1 Press **CH+/-** button to select **DTV CAPTION STYLE**.

2 Press **VOL+** button to enter the submenu.

3 Press **CH+/-** button to select the desired option.

4 Press **VOL+/-** button to adjust the option.

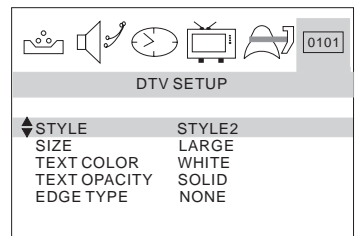
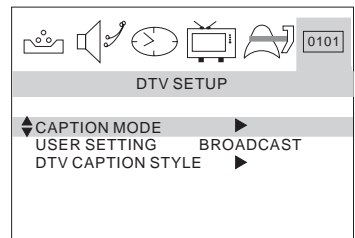

DTV setup menu

SETTING THE DTV CAPTION STYLE(continue)

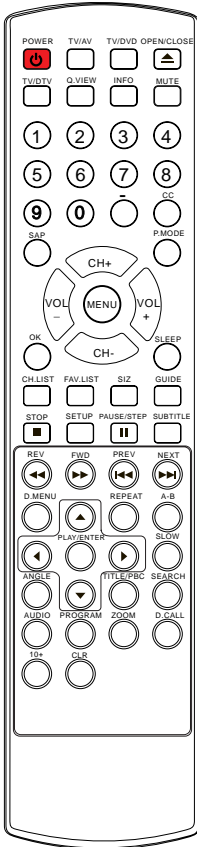

■ Style

Select this option to select the font style of caption display according to your own preference.

Press the **VOL +/-** button to select **Style1, Style2, Style3, Style4, Style5, Style6, Style7, Style8.**

■ Size

Select this option to select the size of caption display according to your own preference.

Press the **VOL +/-** button to select **Small, Standard or Large ,**

■ Text color

Select this option to select the text color or the opacity of the text box of caption display according to your own preference.

Select a color and one of the opacity options.

■ **Text Opacity:** Specify the opacity for the text color.

■ **BG (Background) Color:** Select a background color.

■ **BG (Background) Opacity:** Select the opacity for the background color.

SETTING THE DAYLIGHT SAVING

Daylight saving time is automatically set by specially broadcasted signals.

This menu item allows you to disable the automatic setting of daylight saving time. This is useful if you live in an area or state where daylight saving is not applied, but you receive channels from other areas where daylight saving signals are broadcasted.

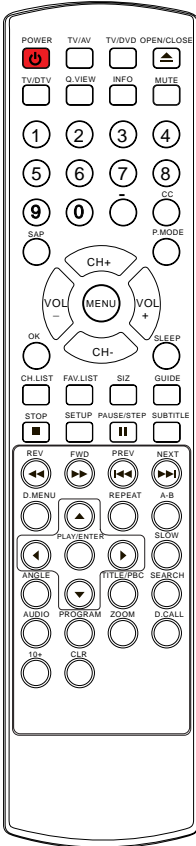

1 Press **MENU**. The main menu screen will appear.

2 Press **VOL+/-** button to select **DTV SETUP** option, then press **CH-** button to enter.

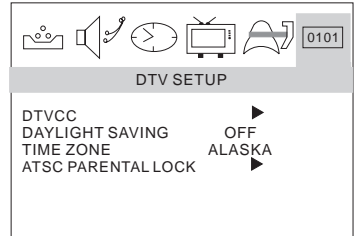

3 Press **CH+/-** button to select **DAYLIGHT SAVING**, then press **VOL+/-** button to select **ON** for automatic clock correction for daylight saving time, based on specially broadcasted signals. Select **OFF** to disable automatic clock correction based on the specially broadcasted signals.

SETTING THE TIME ZONE

This function allows you to select your local time zone. Broadcasted time information will correct the clock display for your local time.

1 Press **MENU**. The main menu screen will appear.

2 Press **VOL+/-** button to select **DTV SETUP** option, then press **CH-** button to enter.

3 Press **CH+/-** button to select **TIME ZONE** option.

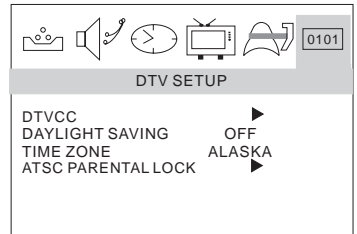

4 Press **VOL+/-** button to select your viewing area time zone: **NEWFOUNDLAND, ATLANTIC, EASTERN, CENTRAL, MOUNTAIN, PACIFIC, ALASKA, HAWAII, or SAMOA**

DTV setup menu

SETTING ATSC PARENTAL LOCK

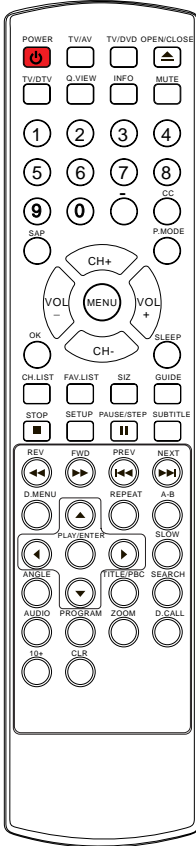

1 Press **MENU**. The main menu screen will appear.

2 Press **CH+/-** button to select **DTV SETUP**, then press **VOL-** button to enter the submenu.

3 Press **CH+/-** button to select **ATSC PARENTAL LOCK**.

4 Enter the password (4 digits) using the number buttons (0-9). The TV is set up with the initial password 0000 and enter next submenu.

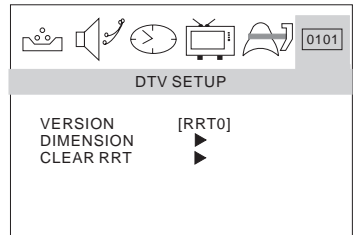
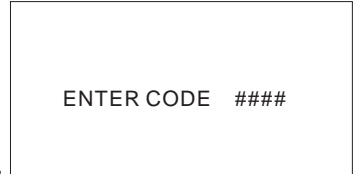
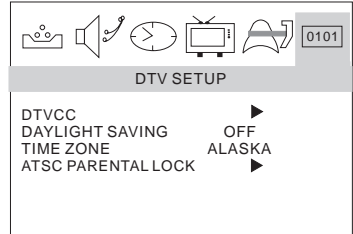

■ Version

V-chip broadcast source version.

■ Dimension

Use when viewing non-TV broadcast programming.

■ Clear RRT

CLEAR Rating Table (RRT) information:
This will clear V-Chip ratings table version.

GUIDE

- This activates some, but not all, electronic program guides (EPG data) when it is used and transmitted by some DTV station providers. It is only supported when receiving DTV channels.

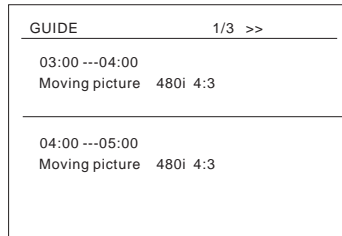
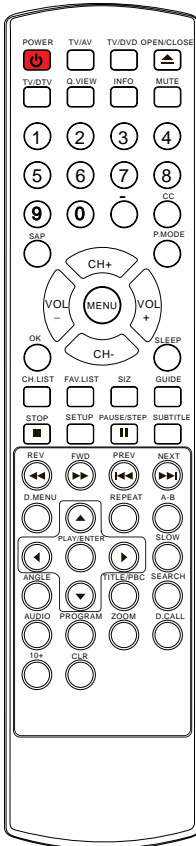

1. Press the **GUIDE** button to switch on GUIDE.
2. Press the CH+/- or VOL+/- button to select desired program, then press the **OK** button to display the selected program.
3. Press the **GUIDE** or **EXIT** button again to switch off GUIDE and return to TV viewing.

FAVORITE CHANNELS LIST

You can create your own Favorite List. Use the “FAV.LiST” button on the remote control when a channel is highlighted and then you can add or delete the channel to/from the Favorite List.

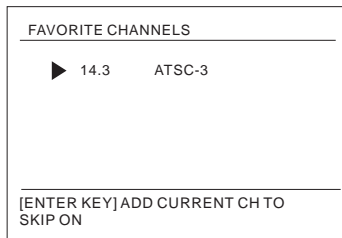

Press the “FAV.LIST” button open the favorite channel list, press CH+/- button to select the channel and press OK button to confirm.

Other Functions

QUICKLY VIEW

This function enables quick swap to the last watched program.

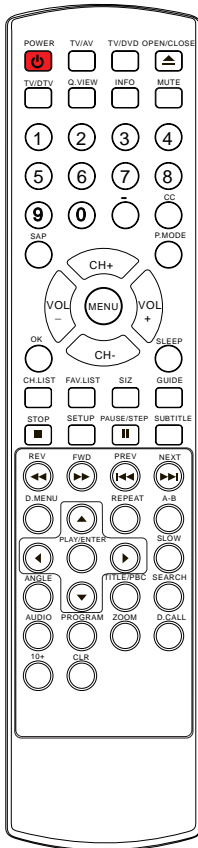

1 Suppose the channel number you used just now is 8 and the channel number you are using is 18 (as shown in the figure).

18

2 If you want to return to the last watched program channel 8, you can simply press the Q.View button.

8

3 If you want to return to channel 18, press the button again. Use this function, you can easily change between the channel you are using and the channel you used last time.

18

SLEEP TIMER

To set the TV to turn off after a preset amount of time, press **SLEEP** button repeatedly to select the number of minutes. First the **OFF** option appears on the screen, followed by the following sleep timer options:

(5 MINUTE, 10 MINUTE, 15 MINUTE, 30 MINUTE, 45 MINUTE, 60 MINUTE, 90 MINUTE, 120 MINUTE, 180 MINUTE, 240MINUTE, OFF)

SLEEP OFF

To confirm the sleep timer setting, press **SLEEP** and the remaining time will be displayed for a few seconds. To cancel the sleep timer, Press **SLEEP** repeatedly until the display turns to **OFF**.

PICTURE MODE

Every time press the P.MODE button to switch desired picture quality mode. Four kinds of picture modes (i.e., "**MILD**", "**STANDARD**", "**VIVID**", "**CUSTOM**",) can be selected in turn.

MILD

Basic Playback

Preparations

- Press the DVD/TV button on the remote control or the TV to enter the DVD status.

Basic playback

1. Press OPEN/CLOSE to open the disc tray, place a disc in the disc tray.
 - There are two different disc sizes. Place the disc in the correct GUIDE on the disc tray. If the disc is out of the GUIDE, it may damage the disc and cause the DVD player to malfunction.
 - Do not place a disc which is unplayable in this DVD player.
2. Press OPEN/CLOSE to close the disc tray, the playback will automatically start.
 - Some discs do not start automatically. Press PLAY/ENTER to start playback.
3. Some discs may start playback with a menu. Use the cursor buttons on the remote control to select menu options and press PLAY/ENTER to start. You may also press the digit buttons to select a menu option directly. Many DVDs will not allow this during start-up.

Pause playback

1. Press PAUSE/STEP to pause playback (still mode). The sound will be muted during still mode.
2. Press PLAY/ENTER to resume normal playback.

Stop playback

1. Press STOP ■ button to go to stop mode, the TV screen will show the start logo. For some discs the player can recall the location where stopped, such as DVDs and audio CDs.
2. Press PLAY/ENTER to playback to resume playback from the location where playback is stopped or from the beginning of the disc.
3. Press STOP twice to stop completely.

Previous and Next

During Playing, pressing the PREV ◀ key will restart the current chapter and skip chapters backwards with each subsequent press until the start of the disc is reached. Each press of NEXT ▶ key during playing will skip the current chapter and play the next one.

Fast forward and Fast reverse

1. Press FWD ►► to fast forward through the disc. Each time the FWD ►► button is pressed, the fast forward motion speed changes.
2. Press PLAY/ENTER to resume normal playback.
3. Press REV ◀◀ to fast reverse through the disc. Each time the REV ◀◀ button is pressed, the fast reverse motion speed changes.
4. Press PLAY/ENTER to resume normal playback.

Single step playback

1. When paused, press PAUSE/STEP continuous to single step forward to the next frame in the video.
2. Press PLAY/ENTER to resume normal playback.

DVD Features(Continued)

Advanced Playback

IMPORTANT NOTE:

All described functions are for DVD discs. If you play other format discs, the operation and on screen display will be different.

SUBTITLE

Press "SUBTITLE", the screen will display "SUBTITLE 01/XX XXXXX", "01" indicates the original number of this language; "XX" indicates total number of language; "XXXXXX" indicates the language of country. (the number of language depends on disc). This function can select up to 32 languages displayed on screen.

REPEAT

Press "REPEAT" and Chapter repeat will be displayed on screen, the second press will display Title repeat, the third press will display All repeat, the fourth press will cancel this function.

A-B

Press "A-B" to begin start-point, press again to set an end point and complete setting. The selected section A-B will be repeated. The third press will cancel this function.

ANGLE

When enjoying sports, concert or theatre, press this key to watch same actions in different angles. (Valid for discs possessing this function. Using a disc recorded in multi-angle you can view the scene from different angles, for example, front, side, whole view and exterior scene).

D.MENU

Press this key to display root menu, select item according to your preference. (This function will work with a DVD having a multi-layer menu.)

D.CALL

Pressing this key will cycle through "Title Elapsed", "Title Remain", "Chapter Elapsed", "Chapter Remain" and "Display off".

PROGRAM

When playing discs, press "PROGRAM" to enter program mode. Press the digit buttons to select the program number that you want. When finished move the cursor to select "START". This will start the program playback.

SEARCH

Press "SEARCH" once to display the search menu. Press the button again to select. Press the program number buttons to input the item you require. Press PLAY/ENTER to confirm.

SLOW

Press SLOW to play a disc in slow forward. Each time the SLOW button is pressed, the slow motion speed changes. Press PLAY/ENTER to resume normal playback;

Note: This function does not work for CD and MP3.

TITLE/PBC

With some DVD discs pressing this key will display the title menu. You can then use the digit buttons to select the item you prefer.

AUDIO

Press this key can change the mode of audio. such as: Audio 1/2: AC 3 2 CH English
Audio 2/2: AC 3 5.1 CH English

Press this button to cycle between Mono Left, Mono Right, Mix-Mono and Stereo.

Note: When press this button continuously, you must above 3 seconds interval.

Special Playback Functions

JPEG DISC PLAYBACK

When a disc containing standard JPEG picture files is inserted into the player, a navigation menu will be displayed automatically. Use the UP and DOWN cursor buttons to select a file then press PLAY/ENTER. The slide show will commence. Press PREVIOUS or NEXT to move between pictures. Press pause to stop on the current picture. Press PLAY/ENTER to resume normal playing.

A JPEG disc contains JPEG (.jpg) format picture information that can be decoded by a micro-computer software and displayed through the video output interface or on the television screen.

This function has many applications. For example one can save files from a scanner or digital camera in the JPEG format, record these on a CD-R disc and present them to an audience through this player.

The JPEG format is a convenient method to store images in a small amount of memory space, and is ideal for archiving information.

MP3 PLAYBACK

When playing an MP3 disc, a navigation menu will be displayed automatically. In the menu, use UP or DOWN cursor buttons to choose the folder, then press PLAY/ENTER to enter the folder. Use the UP and DOWN cursor buttons to select the file and press PLAY/ENTER. Pressing the LEFT cursor button will take you to the previous screen/menu.

SCREEN SAVER FUNCTION

This unit employs a screen saver mode to help protect the tube during static video pictures. This can be turned off on the GENERAL SETUP PAGE.

DVD System Setup

DVD System Setup

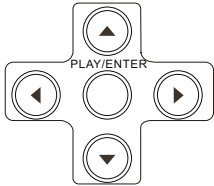

General Setup Process

1. Press the SETUP button, the General Setup Page, Preference Page will be displayed in turn.
2. Press ▲ or ▼ to select, the item, then press ► to enter the submenu.
3. Press ▲ or ▼ to select then press PLAY/ENTER to confirm.
4. Press EXIT key or press SETUP repeatedly to exit the set-up menus.

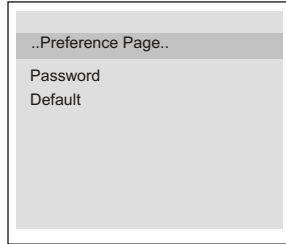
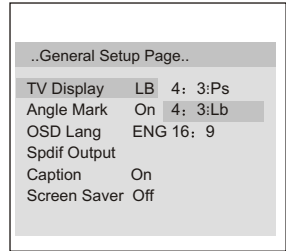

General Setup Page

ASPECT RATIO DESCRIPTION

When using the DVD with the internal TV, select 4: 3/LB.

The following information applies only when the DVD output is connected to an external TV.

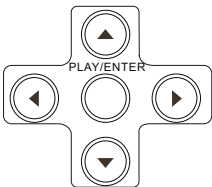
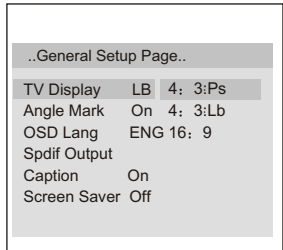

- 4:3/PS (PS = Pan and Scan)

You may select if you have a normal aspect ratio (4:3) TV, although the NORMAL/LB (letter box) is a more common choice. In PS

mode, widescreen material will fill the screen, but at the expense of chopping off extreme left and right edges of the original film picture. For this feature to work, the disc must be specially coded. Such discs are uncommon.

- 4:3/LB (LB = Letter Box)

You may select this if you have a normal aspect ratio (4:3) TV. Widescreen material will be shown in pure unaltered form, allowing the entire picture area of the original film to be viewed without any side cropping. Black bars will appear above and below the picture.

- 16:9

You may select this if you have a widescreen (16:9) TV. Black bars may still appear above and below the picture even if using a widescreen TV. This is because some film directors prefer to use ultra widescreen aspect ratios e.g. 2.35:1. This will normally be indicated on the DVD packaging.

DVD System Setup(Continued)

DVD System Setup

General Setup Page

ANGLE MARK: Users can select a particular camera angle when playing a DVD which offers multiple angles.

This item allows you to set Angle Mark ON or OFF.

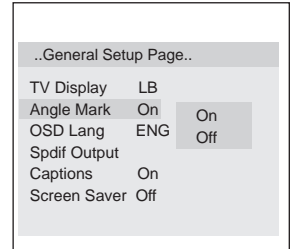

On Screen Display (OSD) Language: Users can select on-screen display language.

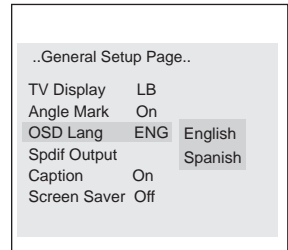

SPDIF OUTPUT MODE: Coaxial audio output modes when connecting to external audio equipment.

This DVD player includes three kinds of audio output:

1. **SPDIF OFF:** An analog surround sound format is output through the back-panel connections for 2-CH audio out or 5.1 CH audio out.
2. **SPDIF/RAW or SPDIF/PCM:** This mode allows a coaxial output cable to be connected to external equipment containing various audio processors that decode various synthesized and discrete audio information for greater effects.

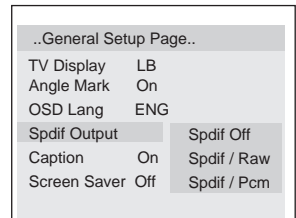

CAPTIONS: This function allows you to display or hide the caption.

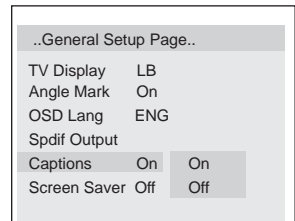

SCREEN SAVER: If the screen saver is on, then there will be an animated picture of DVD on the screen whenever the DVD player is idle for more than 3 minutes .

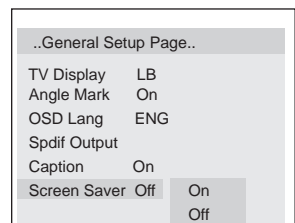

DVD System Setup(Continued)

DVD System Setup

Preference Page

The Preference Page is only available when there is no disc in the player. These settings are applied consistently to all discs which are inserted and played.

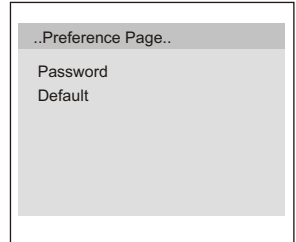
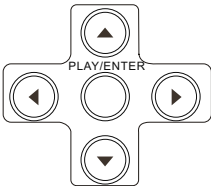

PASSWORD CHANGE:

You can change your password by entering 4 digits. You must confirm the 4 digits before the new password can be accepted.

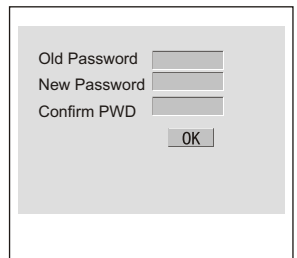
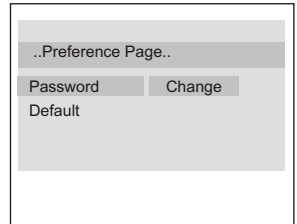
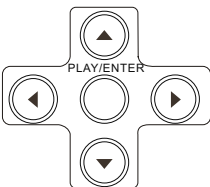

NOTE: If you forget your password or a password is accidentally set enter 2881 as the password. This will enable you to regain control.

DVD System Setup(Continued)

DVD System Setup

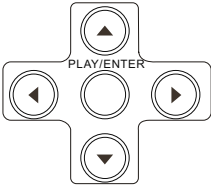

DEFAULT: Resets all settings (except password and parental lock status) for this DVD player back to the manufacturers original settings. Press ENTER to perform the reset.

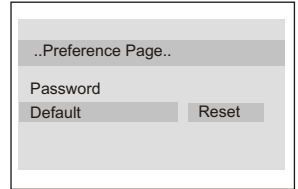









Note:

Some functions may not be available depending on the type of disc.

Playable Discs

The following discs can be played:

DISCS	LABEL	CONTENTS	DIMENSION
DVD VIDEO		Audio +Video (moving picture)	12cm
			8cm
AUDIO CD		Audio	12cm
			8cm
HDCD		Audio	12cm
			8cm
MP3		Audio	12cm
			8cm
JPEG		Video(picture)	12cm
			8cm
KODAK CD		Video(picture)	12cm
			8cm
CD-R		Audio or Video (moving picture)	12cm
			8cm
CD-RW		Audio or Video (moving picture)	12cm
			8cm
CD+G		Audio(picture)	12cm
			8cm

- You cannot play discs other than those listed above.
- You cannot play non-standardized discs, even if they may be labelled as above.
- The performance of CD-R or CD-RW disc depends on the way the disc was burned. In a few cases, their performance may not be consistent or may not even operate at all.

This DVD Player is designed and manufactured according to the Region Management Information that is recorded on a DVD disc. If the Region number described on the DVD disc does not correspond to the Region number of this DVD Player, this DVD player will not play that disc.

This Region number of this DVD Player is .



Disc Protection and DVD Characteristics

ON HANDLING DISCS

- Do not touch the playback side of the disc.
- Do not attach paper or tape to disc.

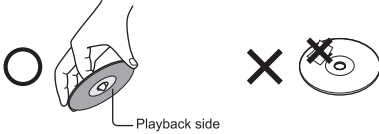

ON CLEANING DISCS

- Fingerprints and dust on the disc cause picture and sound deterioration. Wipe the disc from the centre outwards with a soft cloth. Always keep the disc clean.



- If you can not wipe off the dust with a soft cloth, wipe the disc lightly with a slightly moistened soft cloth and finish with a dry cloth.
- Do not use any type of solvent such as thinner, benzene, commercially available cleaners or anti-static spray for vinyl Lps. It may damage the disc.

ON STORING DISCS

- Do not store discs in a place subject to direct sunlight or near heat source.
- Do not store discs in place subject to moisture and dust such as a bathroom or near a humidifier.
- Store discs vertically in a case. Stacking or placing object on discs outside of their case may cause warping.

STRUCTURE OF DISC CONTENTS

Normally, DVD discs are divided into titles, and the titles are sub-divided into chapters. Audio CD are divided into tracks.

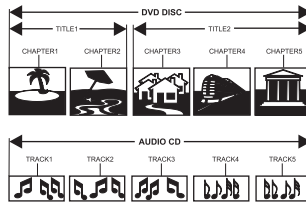

Each title, chapter, or track is assigned a number, which is called title number, chapter number or track number respectively.

















There may be discs that do not have these number.

Compare DVD disc with other discs:

	DVD				LD	SVCD	VCD	CD
Encode method	Digital/MPEG II				Analog	Digital	Digital/MPEG I	Digital
Capacity	Single-side single-layer 4.7G	Double-side single-layer 8.5G	Single-side double-layer 9.4G	Double-side double-layer 17G	/	650MB	650MB	650MB
Playing Time	133 minutes	242 minutes	266 minutes	484 minutes		Single-side 60 minutes double-side 120 minutes	45 minutes	74 minutes
Disc diameter	12cm/8cm				30cm/20cm	12cm	12cm	12cm/8cm
Horizontal resolution	More than 500 line				No more than 430 line	No more than 350 line	No more than 250 line	/
Picture proportion	Multiple kinds				One kind	One kind	One kind	/
Subtitle	32 kinds				16 kinds at most	4 kinds	/	/
Language	8 kinds				4 kinds at most	4 kinds at most	2 kinds	2 kinds
Sound quality	48KHz, 96KHz/ 6, 20, 24bit				44.1KHz/ 16bit	44.1KHz/ 16bit	44.1KHz/ 16bit	44.1KHz/ 16bit

Troubleshooting guide

- To assist in location possible faults use help guide below.

BREAKDOWN PHENOMENON		CHECKING
PICTURE	SOUND	
 Picture with snow	 Noise	The aerial direction and connection
 Double or Triple Image	 Normal	This is called "ghosting" and can be minimized with an outside aerial, and good quality cable and terminations. Altering the aerial direction can also minimize this effect.
 Disturb	 Noise	Electrical interference which can be caused by cars, motorbikes etc, Fluorescent lamps and dirty insulators on overhead power cables.
 Normal	 No sound	Volume Sound mute
 No Picture	 No sound	Ensure that the power supply is connected to the TV set and turned on. Also ensure that the TV set is not in "Listen Mode" or that the brightness and contrast are not turned down.
 No color	 Normal volume	Adjust color control
 Scramble	 Normal or Weak Volume	Adjust channel again
 Color Spot	 Normal volume	Color Purity is a fault that can be caused by moving the TV set, placing magnets near the TV screen or turning on/off house hold appliances such as vacuum cleaners near the TV set. Turn the TV off with the main power switch for 15 minutes. When the power is turned on again the TV set will automatically degauss the picture. In severe cases leave the TV set turned off over night.

Note:

- 1.If the fault can not be corrected using the above guide consult with your local authorized service center.
- 2.The TV set must only be repaired by a qualified registered service person. Never attempt to remove the back cover as TV set has dangerous voltages inside that may cause a fatality or fire.
3. The cabinet may produce the occasional "snapping sound" This is normal and caused by the materials in the cabinet expanding with room temperature changes.

Specifications

- The specifications offered you here are for reference only. With product improvement there may be some differences between the description and the final product.

Model	13 "	14 "	20 "
Colour system	ATSC		
Sound system	M		
Picture tube	13"color picture tube	14"color picture tube	20 "color picture tube
Sound output power	2X2W (10% THD)		
Power requirements	AC 120V~ 60Hz		
Power consumption	85W	85W	90W
Accessories	Remote control		X1
	Owner's manual		X1
	Battery(AA)		X2

Model	Dimension (WDH)
13 "	368.8 mm x 378.6 mm x 378.8mm
14 "	420 mm x 382 mm x 385mm
20 " Round	499.4 mm x 483.5 mm x 481.7mm
20 " pure Flat	499.9 mm x 483.5 mm x 481.7mm

NOTE

Design and specifications are subject to change without notice. Dimensions quoted in this manual are approximate.

The registered logos shown in this manual, such as those on the page showing playable discs contents, are those of the license holders and the associated trademarks holders. They are shown for informational purposes only and do not indicate content or capability in all software, nor with all hardware.

Free Manuals Download Website

<http://myh66.com>

<http://usermanuals.us>

<http://www.somanuals.com>

<http://www.4manuals.cc>

<http://www.manual-lib.com>

<http://www.404manual.com>

<http://www.luxmanual.com>

<http://aubethermostatmanual.com>

Golf course search by state

<http://golfingnear.com>

Email search by domain

<http://emailbydomain.com>

Auto manuals search

<http://auto.somanuals.com>

TV manuals search

<http://tv.somanuals.com>