

XCD35

User Manual

Notes and Warnings



NOTE: A NOTE indicates important information that helps you make better use of your computer.



WARNING: A WARNING indicates a potential for property damage, personal injury, or death.

Information in this document is subject to change without notice.

© 2010 Dell Inc. All rights reserved.

Reproduction of these materials in any manner whatsoever without the written permission of Dell Inc. is strictly forbidden.

Trademarks used in this text: *Dell* and the *DELL* logo are trademarks of Dell Inc.













Other trademarks and trade names may be used in this document to refer to either the entities claiming the marks and names or their products.

Dell Inc. disclaims any proprietary interest in trademarks and trade names other than its own.







August 2010 P/N GJ8JW Rev. A00

For Your Safety

Product Safety Information

| | | | |
|---|---|---|--|
|  | Read the Safety Information section of this user guide on this page |  | Do not use while re-fuelling |
|  | Do not use hand-held while driving |  | This device may produce a bright or flashing light |
|  | For body-worn operation maintain a separation of 15 mm |  | Do not dispose of it in a fire |
|  | Small parts may cause a choking hazard |  | Avoid contact with magnetic media |
|  | This device may produce a loud sound |  | Avoid Extreme Temperatures |
|  | Keep away from pacemakers and other personal medical devices |  | Avoid any contact with liquid, keep it dry |



| | | | |
|---|--|---|---|
|  | Switch off when instructed in hospitals and medical facilities |  | Do not attempt to disassemble |
|  | Switch off when instructed in aircrafts and airports |  | Do not rely on this device for emergency communications |
|  | Switch off in explosive environments |  | Only use approved accessories |

RF Exposure

General Statement on RF Energy

Your phone contains a transmitter and a receiver. When it is ON, it receives and transmits RF energy. When you communicate with your phone, the system handling your call controls the power level at which your phone transmits.

Specific Absorption Rate (SAR)

Your mobile device is a radio transmitter and receiver. It is designed not to exceed the limits for exposure to radio waves recommended by international guidelines. These guidelines were developed by the independent scientific organization ICNIRP and include safety margins designed

to assure the protection of all persons, regardless of age and health.

The guidelines use a unit of measurement known as Specific Absorption Rate, or SAR. The SAR limit for mobile devices is 2 W/kg and the highest SAR value for this device when tested at the ear was 1.58 W/kg*. As mobile devices offer a range of functions, they can be used in other positions, such as on the body as described in this user guide**.

As SAR is measured utilizing the device's highest transmitting power, the actual SAR of this device while operating is typically below that indicated above. This is due to automatic changes to the power level of the device to ensure it only uses the minimum power required to communicate with the network.

* The tests are carried out in accordance with IEC standard PT62209-1.

** Please see body worn operation.

Body-worn Operation

Important safety information regarding radio frequency radiation (RF) exposure:

To ensure compliance with RF exposure guidelines the phone must be used with a minimum of 15 mm separation from the body.

Failure to observe these instructions could result in your RF exposure exceeding the relevant guideline limits.



Limiting Exposure to Radio Frequency (RF) Fields

For individuals concerned about limiting their exposure to RF fields, the World Health Organization (WHO) provides the following advice:

Precautionary measures: Present scientific information does not indicate the need for any special precautions for the use of mobile phones. If individuals are concerned, they might choose to limit their own or their children's RF exposure by limiting the length of calls, or using 'hands-free' devices to keep mobile phones away from the head and body.

Further information on this subject can be obtained online from the WHO fact sheet N°193 at <http://www.who.int/mediacentre/factsheets/fs193/en/>

Regulatory Information

The following approvals and notices apply in specific regions as noted.

Distraction

Driving

Full attention must be given to driving at all times in order to reduce the risk of an accident. Using a phone while driving (even with a hands free kit) can cause distraction and lead

to an accident. You must comply with local laws and regulations restricting the use of wireless devices while driving.

Operating Machinery

Full attention must be given to operating the machinery in order to reduce the risk of an accident.

Product Handling

General Statement on Handling and Use

You alone are responsible for how you use your phone and any consequences of its use.

You must always switch off your phone wherever the use of a phone is prohibited. Use of your phone is subject to safety measures designed to protect users and their environment.

- Always treat your phone and its accessories with care and keep it in a clean and dust-free place.
- Do not expose your phone or its accessories to open flames or lit tobacco products.
- Do not expose your phone or its accessories to liquid, moisture or high humidity.
- Do not drop, throw or try to bend your phone or its accessories.



- Do not use harsh chemicals, cleaning solvents, or aerosols to clean the device or its accessories.
- Do not paint your phone or its accessories.
- Do not attempt to disassemble your phone or its accessories, only authorized personnel should do so.
- Do not expose your phone or its accessories to extreme temperatures, minimum - [5] and maximum + [50] degrees Celsius.
- Please check local regulations for disposal of electronic products.
- Do not carry your phone in your back pocket as it could break when you sit down.

Small Children

Do not leave your phone and its accessories within the reach of small children or allow them to play with it.

They could hurt themselves or others, or could accidentally damage the phone.

Your phone contains small parts with sharp edges that may cause an injury or may become detached and create a choking hazard.

Demagnetization

To avoid the risk of demagnetization, do not allow electronic devices or magnetic media close to your phone for a long time.

Electrostatic Discharge (ESD)

Do not touch the SIM card's metal connectors.

Antenna

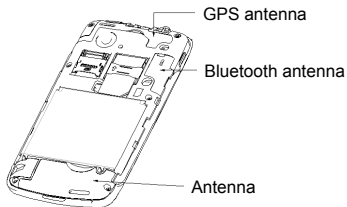

Do not touch the antenna unnecessarily.

Normal Use Position

When placing or receiving a phone call, hold your phone to your ear, with the bottom towards your mouth.

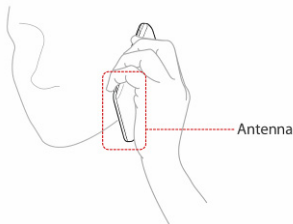

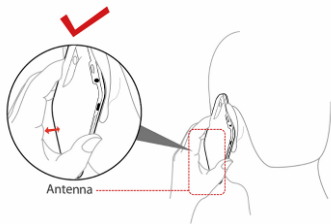

Air Bags

Do not place a phone in the area over an air bag or in the air bag deployment area.

Store the phone safely before driving your vehicle.

Seizures/Blackouts

The phone can produce a bright or flashing light.

Repetitive Motion Injuries

To minimize the risk of RSI when texting or playing games with your phone:

- Do not grip the phone too tightly.
- Press the buttons lightly.
- Use the special features which are designed to minimize the times of pressing buttons, such as Message Templates and Predictive Text.

- Take lots of breaks to stretch and relax.

Emergency Calls

This phone, like any wireless phone, operates using radio signals, which cannot guarantee connection in all conditions. Therefore, you must never rely solely on any wireless phone for emergency communications.

Loud Noise

This phone is capable of producing loud noises, which may damage your hearing. Turn down the volume before using headphones, Bluetooth stereo headsets or other audio devices.

Phone Heating

Your phone may become warm during charging and during normal use.

Electrical Safety

Accessories

Use only approved accessories.

Do not connect with incompatible products or accessories. Take care not to touch or allow metal objects, such as coins or key rings, to contact or short-circuit the battery terminals.

Connection to a Car

Seek professional advice when connecting a phone interface to the vehicle electrical system.

Faulty and Damaged Products

Do not attempt to disassemble the phone or its accessory. Only qualified personnel should service or repair the phone or its accessory.

If your phone or its accessory has been submerged in water, punctured, or subjected to a severe fall, do not use it until you have taken it to be checked at an authorized service center.

Interference

General Statement on Interference

Care must be taken when using the phone in close proximity to personal medical devices, such as pacemakers and hearing aids.

Pacemakers

Pacemaker manufacturers recommend that a minimum separation of 15 cm be maintained between a mobile phone and a pacemaker to avoid potential interference with the pacemaker. To achieve this, use the phone on the opposite ear to your pacemaker and do not carry it in a breast pocket.

Hearing Aids

People with hearing aids or other cochlear implants may experience interfering noises when using wireless devices or when one is nearby.

The level of interference will depend on the type of hearing device and the distance from the interference source, increasing the separation between them may reduce the interference. You may also consult your hearing aid manufacturer to discuss alternatives.

Medical Devices

Please consult your doctor and the device manufacturer to determine if operation of your phone may interfere with the operation of your medical device.

Hospitals

Switch off your wireless device when requested to do so in hospitals, clinics or health care facilities. These requests are designed to prevent possible interference with sensitive medical equipment.

Aircraft

Switch off your wireless device whenever you are instructed to do so by airport or airline staff.

Consult the airline staff about the use of wireless devices on board the aircraft, if your device offers a 'flight mode'

this must be enabled prior to boarding an aircraft.

Interference in Cars

Please note that because of possible interference to electronic equipment, some vehicle manufacturers forbid the use of mobile phones in their vehicles unless a hands-free kit with an external antenna is included in the installation.

Explosive Environments

Petrol Stations and Explosive Atmospheres

In locations with potentially explosive atmospheres, obey all posted signs to turn off wireless devices such as your phone or other radio equipment.

Areas with potentially explosive atmospheres include fuelling areas, below decks on boats, fuel or chemical transfer or storage facilities, areas where the air contains chemicals or particles, such as grain, dust, or metal powders.

Blasting Caps and Areas

Power off your mobile phone or wireless device when in a blasting area or in areas posted power off "two-way radios" or "electronic devices" to avoid interfering with blasting operations.

Contents

| | | |
|----------|---|-----------|
| 1 | Quick Start | 21 |
| 1.1 | Phone Overview..... | 21 |
| 1.2 | Before Getting Started..... | 22 |
| 1.3 | Powering On/Off Your Phone | 25 |
| 1.4 | Your Home Screen..... | 26 |
| 1.5 | Widgets and Google Services | 26 |
| 1.6 | Using Figure Gestures..... | 28 |
| 1.7 | Apps..... | 28 |
| 1.8 | Calls..... | 28 |
| 1.9 | Contacts | 29 |
| 1.10 | Messages | 30 |
| 1.11 | Media..... | 31 |
| 2 | Phone Calls | 32 |
| 2.1 | Making a Call | 32 |
| 2.1.1 | Making a Call from Dialer..... | 32 |
| 2.1.2 | Making a Call from Contacts..... | 32 |
| 2.1.3 | Making a Call from Call History | 32 |
| 2.1.4 | Making a Call from a Text Message | 33 |
| 2.1.5 | Making a Conference Call..... | 33 |
| 2.1.6 | Making an Emergency Call | 34 |
| 2.2 | Receiving a Call..... | 34 |
| 2.2.1 | Answering an Incoming Call..... | 34 |
| 2.2.2 | Rejecting an Incoming Call..... | 35 |
| 2.2.3 | Muting a Call..... | 35 |

| | | |
|----------|--|-----------|
| 2.2.4 | Putting a Call on Hold..... | 35 |
| 2.2.5 | Turning the Speaker On/Off..... | 35 |
| 2.3 | Call Settings | 36 |
| 3 | Entering Text | 38 |
| 3.1 | Using the On-screen Keyboards..... | 38 |
| 3.2 | Touch Input Settings..... | 39 |
| 4 | Contacts | 40 |
| 4.1 | Managing Contacts..... | 40 |
| 4.1.1 | Creating a Contact | 40 |
| 4.1.2 | Searching for a Contact..... | 40 |
| 4.1.3 | Importing/Exporting Contacts..... | 40 |
| 5 | Messaging | 42 |
| 5.1 | Messages | 42 |
| 5.1.1 | Sending an SMS..... | 42 |
| 5.1.2 | Sending an MMS..... | 43 |
| 5.1.3 | Managing Messages and Their 'Threads'..... | 44 |
| 5.2 | Using Email | 46 |
| 5.2.1 | Creating an Email Account | 46 |
| 5.2.2 | Composing an Email..... | 50 |
| 5.2.3 | Replying to or forwarding an Email..... | 51 |
| 5.2.4 | Email Settings..... | 51 |
| 6 | Getting Connected..... | 53 |
| 6.1 | Connecting to the Internet..... | 53 |
| 6.1.1 | Ways of Connecting to the Internet | 53 |
| 6.1.2 | GPRS/EDGE/3G..... | 53 |

| | | |
|----------|---|-----------|
| 6.1.3 | Wi-Fi..... | 54 |
| 6.2 | Browsing the Internet | 56 |
| 6.2.1 | Browsing Options | 56 |
| 6.2.2 | Opening Links in Web Pages | 57 |
| 6.2.3 | Using Bookmarks | 58 |
| 6.2.4 | Browser Settings | 59 |
| 6.3 | Bluetooth..... | 61 |
| 6.3.1 | Turning on/off Bluetooth | 61 |
| 6.3.2 | Making Your Phone Visible | 61 |
| 6.3.3 | Changing Your Phone's Name..... | 62 |
| 6.3.4 | Pairing with Another Bluetooth Device.. | 62 |
| 7 | Experiencing Multimedia..... | 64 |
| 7.1 | Camera and Camcorder | 64 |
| 7.1.1 | Opening Camera or Camcorder..... | 64 |
| 7.1.2 | Taking Pictures | 64 |
| 7.1.3 | Shooting Videos | 64 |
| 7.1.4 | Camera Settings | 65 |
| 7.1.5 | Camcorder Settings..... | 66 |
| 7.2 | FM Radio..... | 66 |
| 7.2.1 | Opening FM Radio | 67 |
| 7.2.2 | Listening to FM Radio..... | 67 |
| 7.3 | Playing Your Music | 68 |
| 7.3.1 | Creating Playlists | 69 |
| 7.3.2 | Managing Your Playlists..... | 69 |
| 7.3.3 | Adding a Song to a Playlist..... | 69 |
| 7.3.4 | Setting a Song as Ringtone | 69 |



| | | |
|----------|---|-----------|
| 7.4 | Playing Your Videos | 70 |
| 7.5 | Gallery | 71 |
| 7.6 | Sound Recorder | 71 |
| 7.6.1 | Opening Sound Recorder | 72 |
| 7.6.2 | Recording a Voice Memo..... | 72 |
| 8 | Google Applications..... | 73 |
| 8.1 | Signing in to Your Google™ Account | 73 |
| 8.2 | Using Gmail™ | 73 |
| 8.2.1 | Opening Gmail | 73 |
| 8.2.2 | Creating and Sending a Gmail Message..... | 74 |
| 8.3 | Using Calendar..... | 74 |
| 8.3.1 | Opening Calendar..... | 74 |
| 8.3.2 | Adding an Event | 74 |
| 8.3.3 | Viewing Calendar Events | 75 |
| 8.4 | Using Google Talk™ | 75 |
| 8.4.1 | Opening Google Talk..... | 75 |
| 8.4.2 | Adding a New Friend | 75 |
| 8.4.3 | Viewing and Accepting an Invitation | 76 |
| 8.4.4 | Changing Your Online Status | 76 |
| 8.4.5 | Starting a Chat | 76 |
| 8.5 | Places | 77 |
| 8.6 | Latitude | 77 |
| 9 | Phone Settings | 79 |
| 9.1 | Basic Settings..... | 79 |
| 9.1.1 | Setting Time and Date | 79 |

| | | |
|-------|---|----|
| 9.1.2 | Display Settings | 80 |
| 9.1.3 | Sound Settings..... | 81 |
| 9.1.4 | Language Settings..... | 84 |
| 9.1.5 | Mobile Network Services..... | 84 |
| 9.2 | Security Settings | 85 |
| 9.2.1 | Protecting Your Phone with a Screen Lock | 85 |
| 9.2.2 | Protecting Your SIM Card with a PIN..... | 86 |
| 9.2.3 | Setting up Credential Storage | 87 |
| 9.3 | Managing Memory | 88 |
| 9.3.1 | Checking Space Information..... | 88 |
| 9.3.2 | Unmounting Your Memory Card..... | 88 |
| 9.3.3 | Formatting Your Memory Card..... | 88 |
| 9.4 | Application Settings | 89 |
| 9.4.1 | Viewing Applications Installed on Your Phone..... | 89 |
| 9.4.2 | Allowing the Installation of Non-Market Applications | 89 |
| 9.4.3 | Installing an Application..... | 89 |
| 9.4.4 | Removing an Application | 90 |
| 9.5 | Other Settings | 90 |
| 9.5.1 | Search Settings | 90 |
| 9.5.2 | Resetting the Phone | 91 |

10 Other Applications..... 92

| | | |
|------|-----------------|----|
| 10.1 | Calculator..... | 92 |
| 10.2 | Docs To Go..... | 92 |



| | | |
|-----------|-------------------------------------|-----------|
| 10.3 | Note pad..... | 92 |
| 10.4 | Stopwatch..... | 92 |
| 10.5 | Task Manager..... | 93 |
| 10.6 | SIM Toolkit..... | 93 |
| 11 | Appendix..... | 94 |
| 11.1 | Specifications..... | 94 |
| 11.2 | Declaration of RoHS Compliance..... | 95 |
| 11.3 | Disposal of Your Old Appliance..... | 96 |

1 Quick Start

1.1 Phone Overview

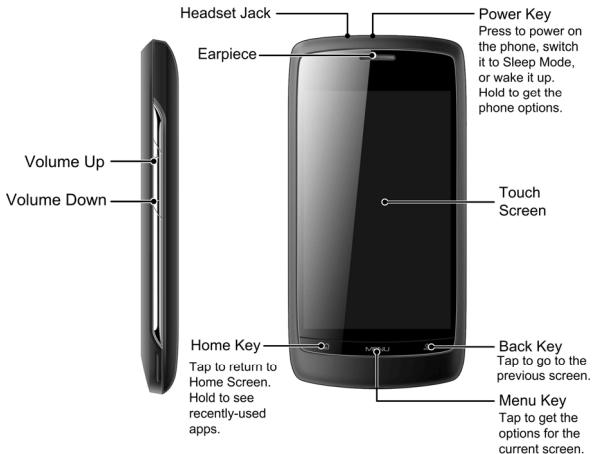

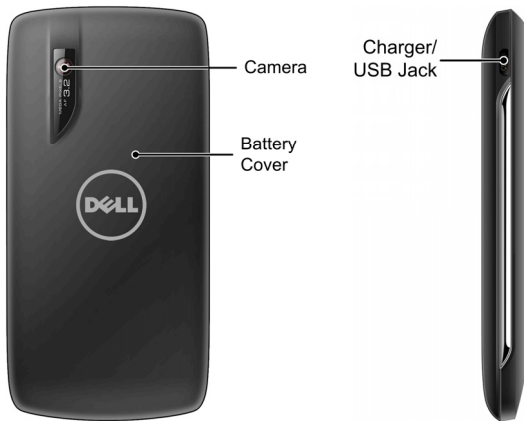

1.2 Before Getting Started

1. Remove the battery cover.

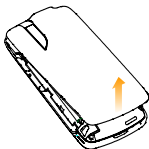

2. Install the SIM card.

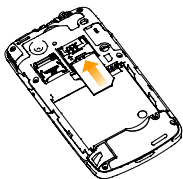

3. Install the microSD card.

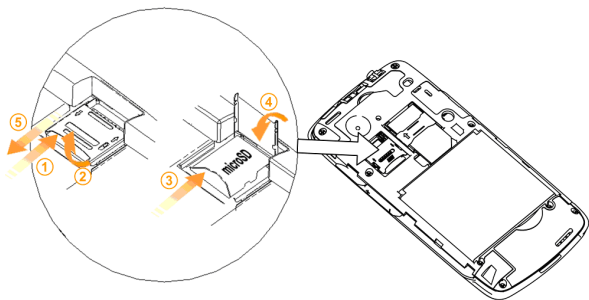

4. Install the battery.

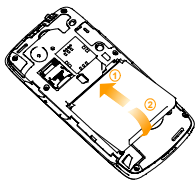

5. Replace the battery cover.

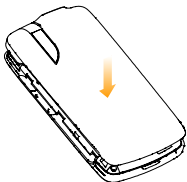

6. Charge the battery.

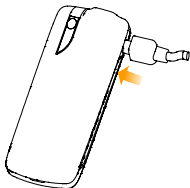

1.3 Powering On/Off Your Phone

Make sure that your SIM card is installed and the battery is charged.

1. Hold **Power Key** to power on your phone.
2. To power off your phone, hold **Power Key** to get the phone options. Select **Power off**, and then tap **OK**.
3. To switch your phone to sleep mode, press **Power Key**.

1.3.1 Waking Up Your Phone from Sleep Mode

Sleep Mode suspends your phone to a low power consumption state by turning off the display to save battery power. Your phone also goes into Sleep Mode automatically when you leave it idle after a certain period of time.

Tips:

While the device is in sleep mode, it is able to receive incoming calls, emails and messages.

1. Press **Power Key** to activate your screen display.
2. Drag  icon to the right.

1.4 Your Home Screen



1.5 Widgets and Google Services

Widgets

A widget works as a shortcut to let you preview or use an application. You can stick widgets on your desktop as icons or preview windows. Besides the default widgets installed on your phone, you can also download more from Android Market.

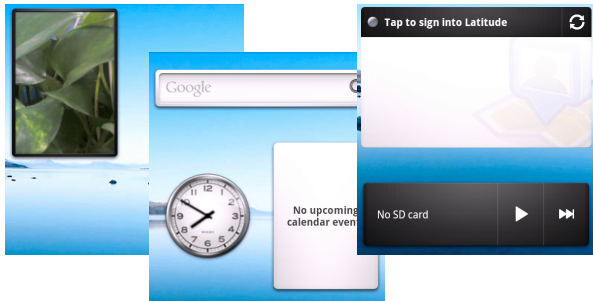

Google Services

Google provides you various excellent services, such as Talk, Google Mail, Market, Maps, etc.

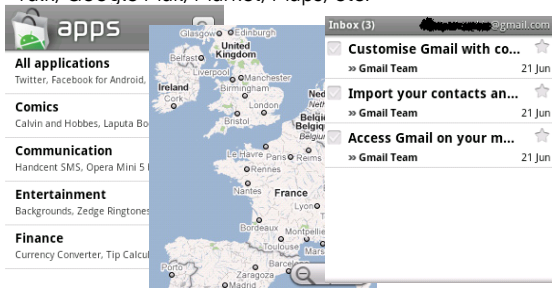

1.6 Using Figure Gestures

You can use finger gestures to control your phone. The controls on your touch screen change dynamically depending on the tasks you are performing.

1. Tap the buttons, icons, or applications to select items or to open applications.
2. Hold a certain item to get available options.
3. Flick the screen to scroll up, down, left or right.
4. Drag a certain item to move it or to do some other corresponding operations.

1.7 Apps

You can find all of your apps in one place. Just tap  from Home Screen to open the application screen.

Tips:

You can download more apps from the market.

1.8 Calls

Select **Dialer** from Home screen, you can open the dial pad.

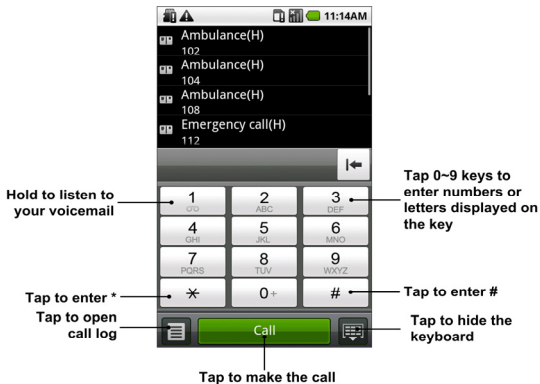

Tips:

- During a call, you can tap **Home Key** or **Back Key** to hide the active call display and use other apps. To reopen it, tap **Dialer** from Home Screen and select **Return to call in progress**.
- Please see the *Phone Calls* chapter for detailed information.

1.9 Contacts

Select  > **Contacts** from Home Screen, you can view, search, or use contacts as you like.

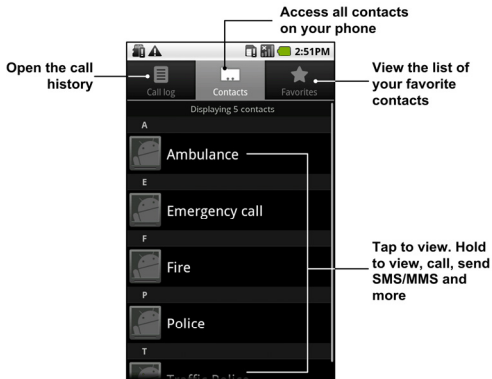





Tips:

For detailed information, please see the *Contacts* chapter.









1.10 Messages

You can use messages at your fingertips-text, multimedia, IM, email, and Gmail.

- SMS/MMS: Tap **Home Key** >  > **Messages**.
- IM: Tap **Home Key** >  > **Talk**.
- Email: Tap **Home Key** >  > **Email**.
- Gmail: Tap **Home Key** >  > **Gmail**.

1.11 Media

See it, listen to it, share it! You can even have time to relax to some music.



- **Camera:** Tap **Home Key** >  > **Camera**, and then tap  to take your photo.
- **Camcorder:** Tap **Home Key** >  > **Camcorder**, and then tap / to start/stop recording.
- **Videos:** Tap **Home Key** >  > **Videos**, you can see the all of your video files and select to browse them.
- **Music:** Tap **Home Key** >  > **Music**, you can get all of your audio files.
- **Gallery:** Tap **Home Key** >  > **Gallery**, you can see what you have taken.
- **FM:** Tap **Home Key** >  > **FMRadio**, you can listen to the FM radio.

2 Phone Calls

2.1 Making a Call

2.1.1 Making a Call from Dialer

1. Tap **Home Key** >  > **Dialer**.
2. Enter the phone number or the contact name you want to call.

Tap  to erase wrong entry; hold this key to clear all digits. Your phone automatically lists the matching contacts. You can tap  to hide the keypad and to see if there are more matching numbers or contacts.

3. Tap .

2.1.2 Making a Call from Contacts

1. Tap **Home Key** >  > **Contacts**.
2. Slide your finger to scroll the contacts list and select the contact you want to call.

Tips: You can search for a contact by tapping **Menu Key** > **Search**.

3. Tap .

2.1.3 Making a Call from Call History



1. Tap **Home Key** >  > **Call log**.

You can also open Call log by tapping the **Call log** tab from the Contacts Screen, or by tapping  from **Dialer**.

2. Tap  next to the number you want to call.

2.1.4 Making a Call from a Text Message

If a message text contains a phone number that you want to call, you can make the call while viewing the message.

1. Tap **Home Key** >  > **Messages** and tap the message that contains the phone number you want to call.
2. Tap the number.
3. Select the number and tap .

2.1.5 Making a Conference Call

Whether you can make a conference call depends on your network and/or your tariff. Usually a quick call will make it possible. Please call your service provider to find out more.

You can make a phone call between yourself and two or more other people.

1. Call the number of one of the people you want to join the conference call.
2. While you are connected to that first number, tap **Add call**.
3. Call the number of someone else you want to join in.

4. While you are connected to the second number, tap **Menu Key > Merge calls**.
5. To add another party, tap **Add call**.
6. Dial the number, and when connected, tap **Menu Key > Merge calls**.
7. Continue as above until you have everybody you want on the call.

2.1.6 Making an Emergency Call

1. Enter the emergency number for your region from **Dialer**.
2. Tap .

TIPS:

It's possible to dial emergency numbers when your SIM is not inserted. Please call your service provider to find out more information. For instance, what emergency numbers are supported.

2.2 Receiving a Call

2.2.1 Answering an Incoming Call

Drag  to the right to answer the call.



2.2.2 Rejecting an Incoming Call

Drag  to the left to reject the call.

2.2.3 Muting a Call

During a call, you can mute your microphone so that the person with whom you are speaking cannot hear you, but you can still hear him or her.

Tap **Mute** to turn your microphone off. The mute icon  will appear on the status bar. To turn your microphone back on, tap **Mute** again.

2.2.4 Putting a Call on Hold

During a call, you can put it on hold by tapping **Menu Key > Hold**. The  icon will appear on the screen.

TIPS: If you accept an incoming call while you're on another call, the first call automatically goes on hold. Just tap **Menu Key > Swap calls** to switch between the two callers.

2.2.5 Turning the Speaker On/Off

Tap **Speaker** during a call to turn the speakerphone on. This icon  will appear in the status bar. Tap **Speaker** again to turn off the speakerphone.

2.3 Call Settings

You can adjust the call settings of your phone. To open the call settings menu, press **Menu Key > Settings > Call settings** from Home Screen.

| | | |
|-------------------------|--|--|
| Fixed Dialing Numbers | Restrict outgoing calls to a fixed set of numbers. To enable this feature you must know your SIM card's PIN2 code. | |
| Voicemail service | Select a voicemail service provider. | |
| Voicemail settings | Specify a voicemail number. | |
| DTMF Tones | Set the length of DTMF tones. | |
| GSM/WCDMA call settings | Call forwarding | Forward your incoming calls to a different number. And choose when to forward: Always forward, Forward when busy, Forward when unanswered, or Forward when unreachable. |
| | Caller ID | Choose whether to display your number in outgoing calls. |

| | | |
|-----------------------|--------------------------------|--|
| | Call waiting | Choose whether to be notified of new incoming calls while you are already on a call. |
| Call barring settings | Forbid certain types of calls. | |

3 Entering Text

3.1 Using the On-screen Keyboards

When you enter a field that needs text or numbers, an on-screen keyboard appears automatically. Tap and hold the input box and select **Input method** from the pop-up menu to change input method.

Android Keyboard

The Android Keyboard provides a layout similar to a desktop computer keyboard. Turn the phone sideways and the keyboard will change from portrait to landscape.

To use the landscape keyboard, just tick the **Orientation** check box in **Settings > Sound & display**. (The landscape QWERTY keyboard is not supported in all applications.)

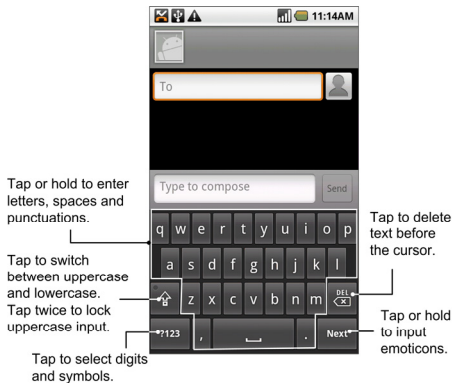

3.2 Touch Input Settings

You can configure the touch input settings by tapping **Menu Key > Settings > Language & keyboard** from Home Screen.

Android keyboard

- **Vibrate on keypress/Sound on keypress:** Enables vibration/sound feedback as you touch on the keyboard.
- **Auto-capitalization:** Select the check box to capitalize the first letter of each sentence automatically.

4 Contacts

You can save contacts to your phone memory or your SIM. More information can be saved on the phone memory for a contact than on the SIM. For instance, IM, postal addresses, organization, etc.

Tap **Home Key** >  > **Contacts** to enter Contacts Screen.

4.1 Managing Contacts

4.1.1 Creating a Contact

1. Tap **Menu Key** > **New contact** from **Contacts**.
2. Select where you want to save your contact.
3. Enter the name and numbers. If the contact is not saved on the SIM card, you can also enter other information of the contact, if needed.
4. Tap **Done** to save the contact.

4.1.2 Searching for a Contact

1. Tap **Menu Key** > **Search** from **Contacts**.
2. Input the contact name you want to search for.

The contacts matched will be listed as you type.

4.1.3 Importing/Exporting Contacts

You can import/export contacts from/to you SIM card or

microSD card.

Import contacts from the SIM card or export to the card

1. Tap **Menu Key > Import/Export** from **Contacts**.
2. Select to import or export contacts.
Your XCD35 will automatically read the contacts.
3. Tap the contacts you want to import/export. Or, just tap **Menu Key > Select all**.
4. Tap **Done**.

Import contact list from the memory card or export to the card

1. Tap **Menu Key > Import/Export** from **Contacts**.
2. Select to import or export.
If you want to import contact list from microSD card, you should have vCard files saved in the microSD card. If there is more than one vCard file, you need to select the vCard file.
3. Tap **OK**.

5 Messaging

5.1 Messages

Your SMS (text message) and MMS (multimedia messaging service) files are located in **Messages** (**Home Key** >  > **Messages**).

When you receive a new message, you can open it from the Notification Panel, or from the Messages Screen. Simply tap on the new message to read it.

Your phone will tell you when message(s) arrive by showing this icon  icon in the status bar.

5.1.1 Sending an SMS

- Tap **Home Key** >  > **Messages**.
- 1. Tap **New message**.
- 2. Tap the **To** field and enter the recipient's number, or tap **Menu Key** > **People** to select recipients from **Contacts**.

TIPS:

You can also enter the first letters of the recipient's name to display a list of matching names stored in **Contacts**, and then select their name from the list.

3. Tap **Type to compose** and type your message.
4. Tap **Send** to send your text.

5.1.2 Sending an MMS

- Tap **Home Key** >  > **Messages**.
 - Tap **New message**.
5. Enter the recipient's number and, if necessary, message text, just like you do with a text message.
 6. Tap **Menu Key** > **Add subject** to enter the subject of your MMS.
 7. Tap **Menu Key** > **Attach** if you want to add an attachment to your MMS...
 - **Pictures**: Select a picture to add to your MMS.
 - **Capture picture**: Take a photo to attach to your MMS.
 - **Videos**: Select a video clip to attach to your MMS.
 - **Capture video**: Shoot a video clip and attach to your MMS.
 - **Audio**: Select an audio file to attach to your MMS.
 - **Record audio**: Record an audio file to attach to your MMS.
 - **Slideshow**: Edit a slideshow to attach to your MMS.
 8. When you've finished, tap **Send**.

NOTE: Add an attachment to text message and it will be converted into an MMS automatically. Likewise if you remove all attachments from an MMS, it'll automatically become a text message.

5.1.3 Managing Messages and Their 'Threads'

Reply to a Message

1. Tap the message thread you want to reply to from the Messages Screen.
2. Tap **Type to compose** and type your message.
3. Tap **Send**.

Delete a Message (Thread)

1. Tap **Menu Key > Delete threads** from the Messages Screen.
2. Select the threads you want to delete and tap **OK**. If you want to delete all threads, tap **Menu Key > Delete all threads**.
3. Tap **Delete**.

Message Settings

Tap **Menu Key > Settings** in **Messages**. You can configure your message settings.

Storage settings

- **Delete old messages:** Delete old messages automatically when the memory limits are reached.

- **Multimedia/Text message limit:** Set the maximum number of multimedia/text messages saved in a single conversation thread.

Text message (SMS) settings

- **Delivery reports:** Request a delivery report for each SMS message you send.
- **Manage SIM card messages:** Manage the messages saved in your SIM card.
- **Service Center:** Edit the SMS center number. You need the correct number in order to send and receive SMS normally.

Multimedia message (MMS) settings

- **Delivery reports:** Request a delivery report for each MMS message you send.
- **Read reports:** Request a read report for each MMS message you send.
- **Auto-retrieve:** Select to retrieve messages automatically.
- **Roaming auto-retrieve:** Select to retrieve messages automatically when you are roaming.
- **MMS creation mode:** Select MMS creation restrictions. An MMS created under restricted mode is more likely to be displayed properly on other devices than those created under free mode.

Notification settings

- **Notifications:** Select to display message notifications in status bar.
- **Select ringtone:** Select a ringtone for your incoming messages.
- **Vibrate:** Select to make your phone vibrate when receiving a new message.

5.2 Using Email

Tap **Home Key** >  > **Email**, you can setup your Email accounts and exchange Emails.

5.2.1 Creating an Email Account

1. Enter your Email address and password, and then tap **Next**.

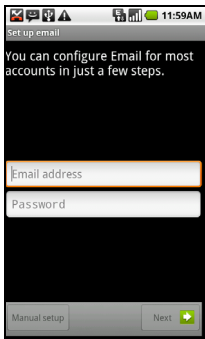

2. Select the type of your account (**POP3/IMAP/Exchange**). Edit the incoming server settings, and then tap **Next**.

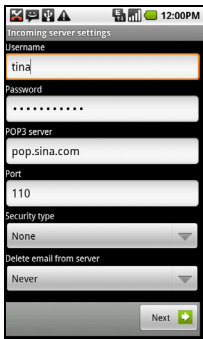

Your phone will check the incoming server settings and finish the setup automatically. If you are notified that setup could not be finished, you might need to correct some settings to finish it.

3. Edit the outgoing server settings and tap **Next**.

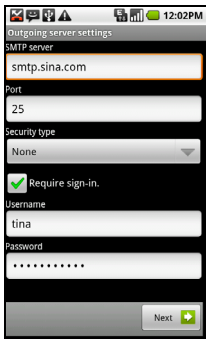

Your phone will check the outgoing server settings and finish the setup automatically.

4. Set the Email checking frequency; select whether to use this account by default or be notified when Email arrives, and then tap **Next**.
5. Give your account a name and set a name displayed on outgoing message, and then tap **Done**.



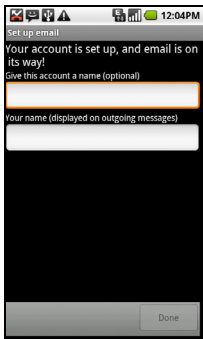

5.2.2 Composing an Email

After creating an Email account, you can compose and send Email messages.

1. Tap **Menu Key** > **Compose** from Email Screen.
2. Tap the **To** field and enter the recipient's address.
The phone will search for and display matching addresses in your Contacts as you type. You can tap the recipient from the list.
3. Enter the subject and the content of your Email.
4. Tap **Send**.

5.2.3 Replying to or forwarding an Email

1. Tap the Email account from Email Screen to open the Email inbox.
2. Tap the Email you want.
3. Tap **Reply /Reply all** to reply to the Email, or tap **Menu Key > Forward** to forward the Email.

5.2.4 Email Settings

Tap the account you want to set in **Email** and tap **Menu Key > Account settings**. You can get the following Email settings.

General settings

- **Account name:** Set your account name.
- **Your name:** Set the name displayed on outgoing message.
- **Email address:** Set the email address of the account.
- **Use signature:** Choose to use your signature.
- **Signature:** Set your signature.
- **Email check frequency:** Set the Email checking frequency.
- **Power-saving mode:** Select the check box to enable automatic adjustment of E-mail synchronization time in order to save power.
- **Default account:** Select the check box to send Email from this account by default.

Notification settings

- **Email notifications:** Select to be notified in status bar when Email arrives.
- **Select ringtone:** Select the ringtone for incoming Email notification.
- **Vibrate:** Select to be notified by vibration with ringtones when Email arrives.

Server settings

- **Incoming settings:** Set the incoming server settings.
- **Outgoing settings:** Set the outgoing server settings.

6 Getting Connected

6.1 Connecting to the Internet

6.1.1 Ways of Connecting to the Internet

Your phone's networking capabilities allow you to access the Internet or your corporate network via the mobile network's GPRS/EDGE/3G connection or Wi-Fi.

6.1.2 GPRS/EDGE/3G

You will need a data plan to use your wireless service operator's GPR/EDGES/3G network. Check with your operator for the service rates. If the GPRS/EDGE/3G settings are not pre-configured on your phone, contact your operator for the parameters. Do not change the settings as this may cause connection failure.

Adding a New GPRS/EDGE/3G Connection

Before you begin, get the following information from your network service operator:

- Access Point Name (APN)
 - Your user name and password if needed.
 - Server IP and the port number if the network uses a proxy server.
1. In the main menu, Tap **Settings > Wireless & networks > Mobile networks > Access Point Names.**

2. Tap **Menu Key > New APN**.
3. Tap **Name** to enter you APN name displayed in the APN list (You can name it as you like).
4. Tap **APN** to enter the APN obtained from your operator.
5. Tap other items to enter all the necessary parameters.
6. Tap **Menu Key > Save**.

Notes: If you want to set the APNs to default settings, tap **Menu Key > Reset to default**.

6.1.3 Wi-Fi

Wi-Fi provides wireless Internet access over distances of up to 300 feet (100 meters).

Turning on Wi-Fi

1. Tap **Home Key >  > Settings > Wireless & networks**.
2. Select the **Wi-Fi** check box to turn Wi-Fi on.

Connecting to a Wi-Fi Network

1. Tap **Home Key >  > Settings > Wireless & networks > Wi-Fi settings**.



The Wi-Fi network names and security settings (open or secured) that your phone has detected are shown in the **Wi-Fi networks** section.

2. Tap a network to connect.
 - If you selected an open network, you will be automatically connected to the network.

- If you selected a secured network, you will need to input the correct password.

Checking the Connection Status

You can check the Wi-Fi network status from the status bar and wireless controls.

1. Open the notifications panel (see *Getting Started - Getting around Your Phone - Status and Notification Icons - Opening the Notification Panel*) and check the  icon to view the Wi-Fi network status.
2. Tap **Home Key** >  > **Settings** > **Wireless & networks** > **Wi-Fi settings**, then tap the wireless network that the phone is currently connected to.

The connection status is shown in a pop-up window.

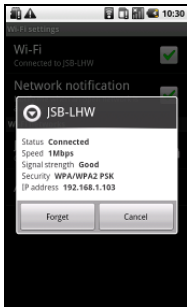



6.2 Browsing the Internet

You can use your phone to get on the Internet. Your phone automatically creates an EDGE or GPRS/3G connection while you browse web pages. Some of them might not be displayed properly as certain internet programs, such as Flash, are not supported by the default browser.



Tap **Home Key** >  > **Browser**.

There are different ways to open web pages:

- Tap the address bar to enter the website you want to browse. Then tap **Go**.
- Tap  beside the address bar or tap **Menu Key** > **Bookmarks**. Select a bookmark to open.
- Tap  beside the address bar or tap **Menu Key** > **Bookmarks**. Choose an item from the **Most visited** tab or **History** tab.

6.2.1 Browsing Options

- **Refresh:** **Menu Key** > **Refresh**.
- **Go to the next page:** **Menu Key** > **More** > **Forward**.
- **Add the page to Bookmarks:** **Menu Key** > **More** > **Add bookmark**.
- **Search:** **Menu Key** > **More** > **Find on page** and enter the search item.

- **Copy: Menu Key > More > Select text** and slide your finger on the page to select the text you want to copy. Your phone automatically copies the selected text to the clipboard.
- **Share pages: Menu Key > More > Share page** to send a page by Google Mail or Messages.
- **Downloads/page info: Menu Key > More > Page info/Downloads.**
- **Landscape browser: Home Key >  > Settings > Sound & display.** Tick the **Orientation** box and rotate your phone sideways to view the landscape browser screen.
- **Open new browser window: Menu Key > New window.** Then tap the address bar to enter the website you want to browse.
- **Switch browser windows:** If you have more than one browser windows opened, you can switch between these windows by tapping **Menu Key > Windows**. Then tap the page you want to browse. You can also tap  to close a window.

6.2.2 Opening Links in Web Pages

Tap the link to open the page, or hold on the link to open the shortcut menu, giving you these options:

- **Open**
- **Open in new window**

- **Bookmark link**
- **Save link**
- **Share link** (by Email, Gmail or Messages)
- **Copy link URL**

6.2.3 Using Bookmarks

To bookmark a web page, open it and tap  or **Menu Key > Bookmarks**. Then tap **Add** or **Add bookmark**. Give the bookmark a name and tap **OK**.

TIPS: You can press **Menu Key > List view/Thumbnail view** to change how you view bookmarks on your phone screen.

Edit a Bookmark

1. Open a Browser window.
2. Tap  or **Menu Key > Bookmarks**.
3. Select an item you want to edit and hold on it until the shortcut menu pops up.
4. Select **Edit bookmark**.
5. Edit the name or location, and then tap **OK** to save it.

Delete a Bookmark

1. Open a Browser window.
2. Tap  or **Menu Key > Bookmarks**.

3. Select an item you want to delete and hold on it until the shortcut menu pops up.
4. Select **Delete bookmark** and tap **OK** to confirm.

6.2.4 Browser Settings

You can set the browser text size, home page etc. by tapping **Menu Key > More > Settings** from a browser window.

Page content settings

- **Text size:** Adjust the browser text size.
- **Default zoom:** Set the browser default zoom.
- **Open pages in overview:** Select to show overview of newly opened pages.
- **Text encoding:** Select a text encoding type.
- **Block pop-up windows:** Select the check box to block pop-up windows.
- **Load images:** Select the check box to show the images on web pages.
- **Auto-fit pages:** Select the check box to format the web pages to fit the screen.
- **Landscape-only display:** Display the web pages only in landscape screen orientation.
- **Enable JavaScript:** Select the check box to enable JavaScript.

- **Enable plug-ins:** Select to enable plug-ins.
- **Open in background:** Select the check box to open new windows behind the current one.
- **Set home page:** Select to edit the home page web site.

Privacy settings

- **Clear cache:** Delete all the cached page contents.
- **Clear history:** Clear the browser navigation history.
- **Accept cookies:** Select the check box to allow sites to save and read cookies.
- **Clear all cookie data:** Clear the browser cookies.
- **Remember form data:** Select the check box to remember the data you type in forms for later use.
- **Clear form data:** Clear the saved form data.
- **Enable location:** Select to allow sites to request access to your location.
- **Clear location access:** Select to clear access for all web sites.

Security settings

- **Remember passwords:** Select the check box to save usernames and passwords for web sites.
- **Clear passwords:** Clear saved passwords.
- **Show security warnings:** Select the check box to show warnings if there is a problem with a site's security.

Advanced settings

- **Website settings:** View advanced settings for individual web sites. Only available for some web sites.
- **Reset to default:** Clear all browser data and reset all settings to default.

6.3 Bluetooth

Bluetooth is a short-range wireless communication technology. Phones with Bluetooth capabilities can exchange information within a distance of about 10 meters without any physical connection. The Bluetooth devices must be paired before the communication is performed.

6.3.1 Turning on/off Bluetooth

1. Tap **Home Key** >  > **Settings** > **Wireless & networks**.
2. Select the **Bluetooth** check box to turn Bluetooth on.

The  icon will be displayed in the status bar. If you want to turn Bluetooth off, clear the **Bluetooth** check box.

Notes: By default, Bluetooth is turned off. If you turn it on, and then power off your device, Bluetooth is also turned off. When you power on your device again, Bluetooth will turn on automatically.

6.3.2 Making Your Phone Visible

In order to work with other phones or devices that have

Bluetooth, you need to make your phone 'visible' to them.

1. Tap **Home Key** >  > **Settings** > **Wireless & networks** > **Bluetooth settings**.
2. Select the **Bluetooth** check box if needed.
3. Select the **Discoverable** check box to make your phone visible.

6.3.3 Changing Your Phone's Name

When your phone is visible to other Bluetooth devices it will be seen by its name, and you can make that anything you want – like 'Dave's XCD35'.

1. Tap **Home Key** >  > **Settings** > **Wireless & networks** > **Bluetooth settings**.
2. Select the **Bluetooth** check box if needed.
3. Tap **Device name**.
4. Enter the name and tap **OK**.

6.3.4 Pairing with Another Bluetooth Device

You can pair your phone with another device that has Bluetooth capabilities. Once you do this, the two devices must have Bluetooth turned on but do not need to be visible to exchange data between them.

1. Tap **Home Key** >  > **Settings** > **Wireless & networks** > **Bluetooth settings**.
2. Tap **Scan for devices**.

Your phone will display all reachable Bluetooth devices in the **Bluetooth devices** section.

3. Tap the device you want to pair with.
4. If necessary, type your PIN to pair and tap **OK**.

Tips: If a PIN is required, the same PIN should be entered on the other device.



7 Experiencing Multimedia

7.1 Camera and Camcorder

Your phone comes with a 3.2-megapixel camera that lets you capture sharp pictures and videos. Use **Camera** or **Camcorder** to take pictures and videos.

7.1.1 Opening Camera or Camcorder

Tap **Home Key** >  > **Camera/Camcorder**.



Notes: You can switch between camera and camcorder quickly by dragging the  or  switch.

7.1.2 Taking Pictures

Aim the camera at the subject and then tap  to take the shot.

- Tap the picture in the upper-right corner of the screen to view the picture just captured.
- Tap **Menu Key** > **Gallery** to view all of your pictures.

7.1.3 Shooting Videos

1. Tap  to start shooting.
2. Tap  to stop shooting.

Notes:

- Tap the picture in the upper-right corner to view the video clip just shot.

➤ Tap **Menu Key > Gallery** to view all of your video clips.

7.1.4 Camera Settings

By tapping **Menu Key > Settings** in Camera Screen, you can adjust the camera settings.

Camera settings

- **White balance:** Tap to adjust the white balance. White balance enables the camera to capture colors more accurately by adjusting to the current lighting environment.
- **Anti Banding:** Select to adjust preview images automatically or for specified AC frequencies, in order to avoid striate previews caused by interference.
- **Color effect:** Tap to select the picture effect.
- **Store location:** Select to record location in picture data.
- **Select ISO:** Tap to set the ISO level to 100, 200, 400, or 800, or set it back to Auto. Higher ISO numbers are better for taking pictures in low light conditions.
- **Picture size:** Tap to select the size of your captured pictures.
- **Picture quality:** Tap to adjust the picture quality.
- **Focus mode:** Select to turn on/off autofocus.
- **Sharpness:** Tap to adjust picture sharpness.
- **Contrast:** Tap to adjust the contrast. Higher contrast ratio enables you to easily see the sharp colors of blue, red or green against any black color.

- **Saturation:** Tap to adjust the saturation.

Restore to default settings

Tap **Restore to default settings** to reset the camera or camcorder settings.

7.1.5 Camcorder Settings

By tapping **Menu Key > Settings** in Camcorder Screen, you can adjust the camcorder settings.

Camcorder settings

- **Video quality:** Select video quality.
- **Video Encoder:** Select the video encoder type.
- **Audio Encoder:** Select the audio encoder type.
- **Video duration:** Tap to set the video duration.

Restore to default settings

Tap **Restore to default settings** to reset the camera or camcorder settings.

7.2 FM Radio





With the FM Radio, you can search for radio channels, listen to them, and save them on your phone. Note that the quality of the radio broadcast depends on the coverage of the radio station in that particular area. The wired headset works as an antenna, so always connect the headset when using the radio. When you receive an incoming call while listening to the radio, the radio will be turned off temporarily.

7.2.1 Opening FM Radio

Tap **Home Key** >  > **FMRadio** to open the application.

The radio is turned on automatically, and you will see the  icon in the status bar.

7.2.2 Listening to FM Radio

- Tap  or  to scan for the previous or next channel.
- Tap **Menu Key** > **Adjust**, and then tap / to fine tune the frequency by ± 0.1 MHz manually.
- Tap and hold a channel frequency until a red box appears on the screen, and then drag the frequency to the box to save the channel.



- Press **Volume Keys** to adjust the volume.

- Tap **Menu Key > Sleep** to set the FM radio sleep timer.
- Tap  to turn off the FM radio.

7.3 Playing Your Music

You can play digital audio files from your phone's memory card in **Music**.

1. Tap **Home Key >  > Music** to open the Music Screen.
2. Select **Artists/Albums/Songs/Playlists** to see the songs you want to play.
3. Tap a song from the list to start playing.
4. Adjust the volume with **Volume Keys**.



7.3.1 Creating Playlists

Playlists help you organize your music files:

1. Select a music file you want to add to a new playlist.
2. Tap and hold on the file until a shortcut menu pops up.
3. Tap **Add to playlist**.
4. Tap **New**.
5. Type the playlist name and tap **Save**.

7.3.2 Managing Your Playlists

1. From the Music Screen, tap **Playlists** tab to see them all.
2. Hold on the playlist you want to play or edit until a shortcut menu pops up.
3. Tap **Play, Delete** or **Rename**.

7.3.3 Adding a Song to a Playlist

1. Open the folder where the song is.
2. Hold on the song until a shortcut menu pops up.
3. Select **Add to playlist**.
4. Select a playlist.

7.3.4 Setting a Song as Ringtone

1. Open the folder where the song is.
2. Hold on the song until a shortcut menu pops up.
3. Select **Use as phone ringtone**.



Tips: You can also set a song as ringtone when it is being played back. Tap **Menu Key > Use as ringtone**.

7.4 Playing Your Videos

To play a video file, tap **Home Key > [App Icon] > Videos**. This will open the Videos Screen and show the video files saved to your memory card.

Tap a video file and the video player will open. Tap on the screen and the control bar will appear as below. So now you can play, pause, fast forward, etc.

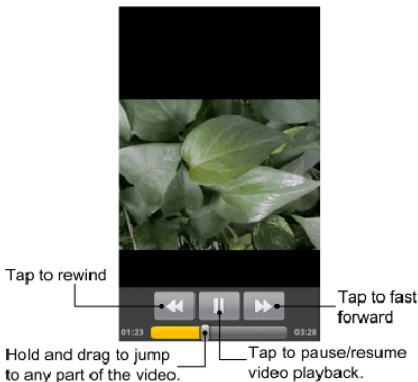

7.5 Gallery

Galley helps you view pictures and play back videos. For pictures, you can do some basic editing, such as cropping and rotation. You can also set them as your wallpaper or contact icon, and share with your friends.

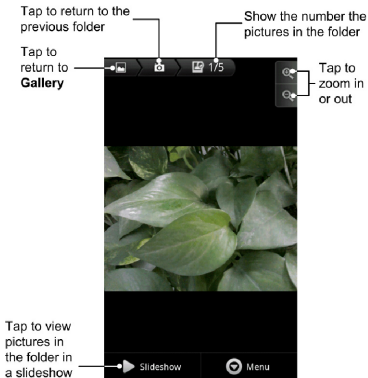

7.6 Sound Recorder

Sound Recorder enables you to record your voice memos that you can set as ringtone.





7.6.1 Opening Sound Recorder

Tap **Home Key** >  > **Sound Recorder**.

Notes: You need to install a memory card to use **Sound Recorder**.

7.6.2 Recording a Voice Memo

1. Get the microphone near the speaker.
2. Tap  to start recording.
3. Tap  to stop recording.
4. Tap  to play back the voice recording.
5. Tap **OK** to save the voice memo, or tap **Discard** to discard the recording.

Notes: You can find your recordings in the music library of the **Music** application. There is a **My recordings** playlist dedicated for your voice memos. If you want to set a recording as ringtone, tap and hold the recording and select **Use as phone ringtone** from the subsequent pop-up menu.

8 Google Applications

8.1 Signing in to Your Google™ Account

Signing in to your Google account enables you use various Google services on the phone, such as Gmail, Calendar, and Google Talk.

1. Tap **Home Key** >  > **Settings** > **Accounts & sync**.
2. Tap **Add account** > **Google**.
3. Follow the on-screen prompt to sign in or create an account.

8.2 Using Gmail™

Gmail is Google's web-based Email service. When you sign in to your Google account on your XCD35, the **Gmail** is automatically configured and ready for use. Depending on your synchronization settings, Gmail on your phone can automatically synchronize with your Gmail account on the web.

8.2.1 Opening Gmail

Tap **Home Key** >  > **Gmail**.

Tap **Menu Key** > **Refresh** to start syncing your Emails with your Gmail account on the web.

8.2.2 Creating and Sending a Gmail Message

1. In the **Inbox**, press **Menu Key > Compose**.
2. Enter the message recipient's Email address in the **To** field. If you are sending the Email to several recipients, separate each Email address with a comma.
3. Enter the Email subject, and then compose your Email.
4. After composing your Email, tap **Send**.

8.3 Using Calendar

Google Calendar is Google's time management application. You can use the calendar to schedule appointments, including meetings and other events. Depending on your synchronization settings, your schedules can stay in sync with your Google Calendar on the web.

8.3.1 Opening Calendar

Tap **Home Key >  > Calendar** from any screen.

8.3.2 Adding an Event

1. Tap **Menu Key > New event** to open the **Event details screen**.
2. Enter the details of the new event.
3. Tap **Done** when you finish.

Tips: Tap and hold an empty time slot in Calendar's Day, Week, or Month view to quickly add a new event scheduled in that time slot.

8.3.3 Viewing Calendar Events

You can check your schedules in Day, Week, Month, or Agenda view. Tap **Menu Key** and choose **Day, Week, Month,** or **Agenda** to change the calendar view.

Tap a date in **Month** view to see the schedule in that day. Tap an event in **Day, Week,** or **Agenda** view to see the details of the event. You can tap **Menu Key** to edit or delete the event while checking out its detail.

8.4 Using Google Talk™

Google Talk is Google's instant messaging program, which enables you to communicate with other people that also use Google Talk.

8.4.1 Opening Google Talk

Tap **Home Key** >  > **Talk** from Home Screen.

8.4.2 Adding a New Friend

You can only add people who have a Google Account.

1. Open **Talk** application and you are in the **Friends list** screen.
2. Press **Menu Key** > **Add friend**.

3. Enter the Google Talk ID or Email address of the friend you want to add.
4. Tap **Send invitation**.

8.4.3 Viewing and Accepting an Invitation

1. In **Friends list**, press **Menu Key > Invites**. All pending invitations, both sent and received, are displayed.
2. Tap a pending invitation that you received, and then tap **Accept** or **Decline**.

8.4.4 Changing Your Online Status



1. Tap the online status icon  beside your name and select the status you want from the pop-up menu.
2. Tap the status message box and then enter your personalized status message using the on-screen keyboard.

8.4.5 Starting a Chat

1. Tap a friend in **Friends list**.
2. Chat with your friend by entering text using the on-screen keyboard.
3. After entering your message, tap **Send**.

8.5 Places

Google Places helps you find all kinds of businesses near you.

1. Tap Home Key >  > **Settings** > **Location & security** and select the **Use GPS satellites** or **Use assisted GPS** check box.
2. Tap **Home Key** >  > **Places**. Wait while you are being located. Your location, when found, is shown at the bottom of the screen.
3. Select a business category and the information of that type of business near you will be displayed. You can also use the **Find places** search box on the top to find the business you need.
Note: Tap **Add** to add new business categories.
4. Tap a result you are interested in and check out the details and reviews about that place. You can also see the place on Google Maps, find out how to get there, or give that business a call.

8.6 Latitude

Google's Latitude service is a social tool for sharing your location information with selected friends.

Tap **Home Key** >  > **Maps** and, after signing in to your Google account, tap **Menu Key** > **Join Latitude** to enable Latitude service.

Each time you launch Maps application, your location will be determined using GPS and your Latitude status will be updated. You can tap **Menu Key > Latitude** in Maps or **Home Key >  > Latitude** to see your status as well as that of your selected friends.

In Latitude, tap **Menu Key** to refresh friends status, see them on Maps, add new friends, or change privacy settings. You can also turn off Latitude service by tapping **Turn off Latitude** in Privacy settings.

9 Phone Settings

9.1 Basic Settings

9.1.1 Setting Time and Date

1. Tap **Home Key > Menu Key > Settings > Date & time**.
2. Clear the **Automatic** tick box if you want to set the time and date by yourself.
3. Tap **Set date**. Adjust the date, and tap **Set** to save it.
4. Tap **Select time zone** and tap where you are in the world.
5. Tap **Set time**. Adjust the time, and tap **Set** to save it.
6. Tap the tick box behind **Use 24-hour format** if you want to change the time format.
7. Tap **Select date format** to select the one you prefer.

Set Alarms

1. Tap **Home Key >  > Alarm**.
2. Tap the default alarm to configure it or tap **Menu Key > Add alarm** to create a new alarm.
3. Select the **Turn on alarm** check box and edit the items needed, such as Name, Time, Repeat, Snooze, Duration, Vibrate, Ringtone, Volume, Volume crescendo, and Delay.

9.1.2 Display Settings

By tapping **Menu Key > Settings > Sound & display** from Home Screen, you can configure the display settings, such as orientation, animation, brightness, screen timeout, and calibration.

Adjusting Screen Brightness

1. Select **Brightness** from the **Display settings** section.
2. Adjust the brightness and tap **OK**.

Adjusting Delay before the Screen Turns off

1. Tap **Screen timeout** from the **Display settings** section.
2. Select the time from the list.

Changing Screen Orientation Automatically

You can select to switch your screen orientation to landscape or portrait automatically when rotating your phone.

Select the **Orientation** check box in the **Display settings** section.

If you want to disable this function, clear the **Orientation** check box.

Showing Animation when Opening/Closing Windows

You can select to show an animation when opening or closing windows.

1. Tap **Animation** in the **Display settings** section.
2. Select the animation type you'd like to use, or select **No animations** to disable this function.

9.1.3 Sound Settings

By tapping **Menu Key > Settings > Sound & display** from Home Screen, you can configure the sound settings, such as ringtones and notifications.

Setting the Ringtone

1. Tap **Phone ringtone** from the **Sound settings** section.
2. Select the ringtone you want to use from the pop-up list.

Tips: You can also set an audio file as the ringtone while browsing the music library. See *Experiencing Multimedia – Music – Setting a Song as Ringtone*.

Setting the Default Notification Ringtone

1. Select **Notification ringtone** from **Sound & display settings**.
2. Scroll the ringtone list and select one to set as the default notification ringtone.
3. Tap **OK** to save.

Switching to Silent Mode

Select the **Silent mode** check box from **Sound & display settings**.

You can also switch to silent mode by holding **Volume Key (Down)** or, when the screen is locked, by dragging the **Sound off** bar to the left, as shown below.

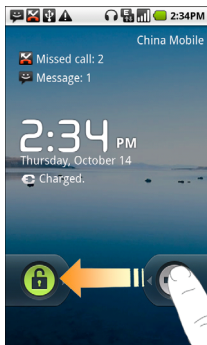

The silent icon  will appear in the status bar.

Switching to Vibration Mode

Select the **Phone vibrate** check box from **Sound & display settings**.

If the phone is already in silent mode, the vibration icon  will appear in the status bar.

Adjusting Ringer Volume

If you want to set the ringer volume, make sure your phone is not in silent mode.

1. Select **Ringer volume** from **Sound & display settings**.
2. Adjust the ringer volume and tap **OK** to save.

Tips: You can adjust the ringer volume quickly by pressing **Volume Keys** from any screen.

Notes: If you want to adjust the notification volume together with ringer volume, select the **Use incoming call volume for notifications** check box.

Adjusting Media Volume

You can adjust the media volume for FM radio as well as the music and video players.

1. Select **Media volume** from **Sound & display settings**.
2. Adjust the media volume and tap **OK** to save.

Tips: Press **Volume Keys** to quickly adjust the media volume when you are watching videos, or listening to music and FM radio.

Touch Tones

You can set your phone to play tones when touching the keys in **Dialer**.

Select the **Audible touch tones** check box from **Sound & display settings**.

Screen Selection Tones

You can set your phone to play tones when making a touching selection on the screen.

Select the **Audible selection** check box from **Sound & display settings**.

SD Card Notifications

You can set your phone to play sound for microSD card notifications, such as when the card is mounted or unmounted.

Select the **SD card notifications** check box from **Sound & display settings**.

9.1.4 Language Settings

You can change the system language of your phone.

1. Tap **Home Key** >  > **Settings** > **Language & keyboard** > **Select locale**.
2. Select a language to set it as the system language.

9.1.5 Mobile Network Services

Your phone supports both GSM and WCDMA services. You can configure the network settings according to your phone service.

Data Roaming

Data roaming allows you to use data services when you are on a roaming network.

1. Tap **Home Key** >  > **Settings** > **Wireless & networks** > **Mobile networks**.
2. Check the **Data roaming** check box to allow data services when roaming.



Caution: Accessing data services on a roaming network may cause significant charges.

Switching Network Mode

1. Tap **Home Key** >  > **Settings** > **Wireless & networks** > **Mobile networks** > **Network Mode**.
2. Select the network mode you prefer.

You can also tap the **Use only 2G networks** check box to save battery power.

Switching Network Operators

1. Tap **Home Key** >  > **Settings** > **Wireless & networks** > **Mobile networks** > **Network operators**.
2. Tap **Search networks** to set the network operator manually, or tap **Select automatically** to set the network operator automatically.

9.2 Security Settings

You can protect your phone and the SIM card from unauthorized use.

9.2.1 Protecting Your Phone with a Screen Lock

Setting a Screen Unlock Pattern

You can protect your phone from unauthorized use by creating a personal screen unlock pattern.

1. Tap **Home Key** >  > **Settings** > **Location & security** > **Set unlock pattern**.

2. Read the instructions and tap **Next**.
3. Watch the sample pattern and tap **Next**.
4. Draw your own pattern and tap **Continue**.

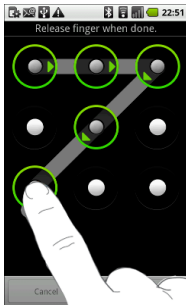

5. Draw your pattern again and tap **Confirm**.

Locking the Screen

Press **Power Key** to lock the screen.

To unlock the screen, press **Power Key** and draw the pattern.

9.2.2 Protecting Your SIM Card with a PIN

You can set the PIN password to prevent others from using the SIM functions. The initial PIN code is provided by your service operator.

1. Tap **Home Key** >  > **Settings** > **Location & security** > **Set up SIM/RUIM card lock**.

2. Select the **Enable/disable SIM PIN** check box.
3. Enter the PIN and tap **OK**.

Changing the SIM PIN

Before changing the PIN, you need to enable it.

1. Tap **Home Key** >  > **Settings** > **Location & security** > **Set up SIM/RUIM card lock**.
2. Tap **Change SIM/RUIM PIN**.
3. Enter the old PIN and tap **OK**.
4. Enter the new PIN and tap **OK**.
5. Reenter the new PIN and tap **OK**.

Restoring a Locked SIM Card

Put all your confidential passwords in a safe place for future use. If you enter the wrong SIM PIN more times than allowed, your SIM card will be locked and you cannot access the mobile phone network. Contact your operator for a PIN Unlock Key (PUK) to restore the SIM card.

9.2.3 Setting up Credential Storage

You can select to allow applications to access secure certificates and other credentials.

Enabling Secure Credentials

1. Tap **Home Key** >  > **Settings** > **Location & security**.
2. Tap **Set password** and create a password for the credential storage.

3. Select the **Use secure credentials** check box.

Deleting Credentials

1. Tap **Home Key** >  > **Settings** > **Location & security**.
2. Tap **Clear storage** to clear credentials.

9.3 Managing Memory

9.3.1 Checking Space Information

Tap **Home Key** >  > **Settings** > **SD card, USB Mass Storage & phone storage**.

You can view the **Total space** and **Available space** of the memory card and the **Available space** of the internal phone storage.

9.3.2 Unmounting Your Memory Card

1. Tap **Home Key** >  > **Settings** > **SD card, USB Mass Storage & phone storage**.
2. Tap **Unmount SD card**.

The  icon will appear in the notification bar.

9.3.3 Formatting Your Memory Card

1. Unmount your memory card.
2. Tap **Format SD card**.
3. Tap **Format SD card** to confirm.

9.4 Application Settings

9.4.1 Viewing Applications Installed on Your Phone

Tap **Home Key** >  > **Settings** > **Applications** > **Manage applications**.

Your phone will show you the applications in a list.

9.4.2 Allowing the Installation of Non-Market Applications

Besides downloading and installing applications from the Android Market, you can also install applications from other sources.



Caution: Install applications from trusted sources to protect your phone and personal information.

1. Tap **Home Key** >  > **Settings** > **Applications**.
2. Select the **Unknown sources** check box.

9.4.3 Installing an Application

You can install an application from the Android Market by selecting the item you want to download and tap **Install**.

You can also install a non-Marketing application if you have allowed the installation of it. Make sure that you select an application developed for your phone and processor type

before installing it.

1. Tap **Home Key** >  > **Filer**, and open the folder where the application is.
2. Tap the application to start installation.
3. Read the installation instructions that come with the application and follow it to complete the setup.

9.4.4 Removing an Application

1. Tap **Home Key** >  > **Settings** > **Applications** > **Manage applications**.
2. Tap on the application you want to remove.
3. Tap **Uninstall**, and tap **OK** to confirm.

If the application is downloaded from the Market, you can also go to the **Downloads** page, tap the application and then tap **Uninstall** to remove it from your phone.

9.5 Other Settings

9.5.1 Search Settings

You can manage search settings and history by tapping **Home Key** >  > **Settings** > **Search**.

Google Search Settings

Show web suggestions: Select to show suggestions from Google as you type.

Setting Searchable Items

Tap **Home Key** >  > **Settings** > **Search** > **Searchable items**.

When you search for an item on your phone, only the selected items will be searched.

9.5.2 Resetting the Phone

1. Tap **Home Key** >  > **Settings** > **Privacy**.
2. Tap **Factory data reset**.
3. Tap **Reset phone**.
4. Tap **Erase everything**.

10 Other Applications

10.1 Calculator

Tap **Home Key** >  > **Calculator**.

Tips: Tap **Menu Key** > **Advanced panel** to use scientific calculation.

10.2 Docs To Go

You can use this application suite to open word, excel, powerpoint, or PDF files.

Read the on-screen instructions for detailed information.

10.3 Note pad

Note pad is used to write text memos. Press **Menu Key** to add or delete notes. Hold an existing note to edit it, delete it or change its title.

10.4 Stopwatch

1. Tap **Home Key** >  > **Stopwatch**.
2. Tap **Start** to start timing. You can pause or resume.
3. Tap **Reset** to reset the timer.

10.5 Task Manager

You can use **Task Manager** to view and stop running tasks and applications.

Tap a task in the **Task** tab to switch to its screen, abort it, or see its detail. Tap **Resource** to view real-time allocation of system resources.

10.6 SIM Toolkit

SIM Toolkit appears in the main menu only if your SIM card provides this function. To use the SIM card services, insert your SIM card into the phone first.

Tap **Home Key** >  > **SIM Toolkit**.

11 Appendix

11.1 Specifications

| | | |
|------------------------------------|--------------------------------|---|
| Dimensions | | Approx. 114 mm × 56.5 mm × 11.8 mm |
| Weight | | Approx. 130g (with battery) |
| Bearer | | GSM/WCDMA support |
| Main display dimension, resolution | | 3.5 inches 800*480 |
| Back Camera | Sensor type | CMOS |
| | Still image capture resolution | 3.2M Pixels with auto focus |
| Internal memory | | ROM: 512MB, RAM: 512MB |
| Removable memory card | | Support microSD card, max. capacity 16GB |
| Battery | Capacity | 1250mAh |
| | Standby time | Approx. 165 hours (subject to network status) |
| | Voice talk time | Approx. 240 min (subject to network status) |
| WAP browser version | | WAP2.0 |

11.2 Declaration of RoHS Compliance

To minimize the environmental impacts and take more responsibilities to the earth we live on, this document shall serve as a formal declaration that the XCD35 manufactured by DELL CORPORATION is in compliance with the Directive 2002/95/EC of the European Parliament - RoHS (Restriction of Hazardous Substances) with respect to the following substances:

1. Lead (Pb)
2. Mercury (Hg)
3. Cadmium (Cd)
4. Hexavalent Chromium (Cr (VI))
5. Polybrominated biphenyls (PBBs)
6. Polybrominated diphenyl ethers (PBDEs)

The XCD35 manufactured by DELL CORPORATION, meets the requirements of EU 2002/95/EC.



11.3 Disposal of Your Old Appliance



- When this crossed-out wheeled bin symbol is attached to a product, it means the product is covered by the European Directive 2002/96/EC.
- All electrical and electronic products should be disposed of separately from the municipal waste stream via designated collection facilities appointed by the government or the local authorities.
- The correct disposal of your old appliance will help prevent potential negative consequences for the environment and human health.

For this product's Recycling Manual based on WEEE directive, please send an e-mail to weee@zte.com.cn, or visit the website below to download the document:

<http://ensupport.zte.com.cn>

Free Manuals Download Website

<http://myh66.com>

<http://usermanuals.us>

<http://www.somanuals.com>

<http://www.4manuals.cc>

<http://www.manual-lib.com>

<http://www.404manual.com>

<http://www.luxmanual.com>

<http://aubethermostatmanual.com>

Golf course search by state

<http://golfingnear.com>

Email search by domain

<http://emailbydomain.com>

Auto manuals search

<http://auto.somanuals.com>

TV manuals search

<http://tv.somanuals.com>