

Dell™ Axim™ X5

# User's Guide

Model HC01U



[www.dell.com](http://www.dell.com) | [support.dell.com](http://support.dell.com)

Download from [Www.Somanuals.com](http://Www.Somanuals.com). All Manuals Search And Download.

# Notes, Notices, and Cautions



**NOTE:** A NOTE indicates important information that helps you make better use of your computer.



**NOTICE:** A NOTICE indicates either potential damage to hardware or loss of data and tells you how to avoid the problem.



**CAUTION:** A CAUTION indicates a potential for property damage, personal injury, or death.

## Abbreviations and Acronyms

For a complete list of abbreviations and acronyms, see "Glossary" on page 163.

---

**Information in this document is subject to change without notice.**

**© 2003 Dell Computer Corporation. All rights reserved.**

Reproduction in any manner whatsoever without the written permission of Dell Computer Corporation is strictly forbidden.

Trademarks used in this text: *Dell*, the *DELL* logo, *Axim*, and *DellNet* are trademarks of Dell Computer Corporation; *Intel* is a registered trademark and *XScale* and *StrataFlash* are trademarks of Intel Corporation; *Microsoft*, *Windows*, and *ActiveSync* are registered trademarks of Microsoft Corporation; *EMC* is a trademark of EMC Corporation; *Bluetooth* is a trademark owned by Bluetooth SIG, Inc. and is used by Dell Computer Corporation under license.

Other trademarks and trade names may be used in this document to refer to either the entities claiming the marks and names or their products. Dell Computer Corporation disclaims any proprietary interest in trademarks and trade names other than its own.

**Model HC01U**

**May 2003**

**P/N K1971**

**Rev. A00**

# Contents

<b>Finding Information</b> . . . . .	<b>9</b>
<b>1 About Your Device</b>	
<b>Front, Side, and Back Views</b> . . . . .	<b>12</b>
Front and Side Views . . . . .	12
Back View . . . . .	14
<b>Using the Batteries</b> . . . . .	<b>15</b>
Installing and Removing the Main Battery . . . . .	16
Installing and Removing the Backup Battery . . . . .	17
Charging the Main Battery . . . . .	18
<b>Connecting to a Computer</b> . . . . .	<b>19</b>
Using the Cradle . . . . .	19
Using the Sync Cable . . . . .	22
<b>Using Cards</b> . . . . .	<b>23</b>
CompactFlash Cards . . . . .	23
Secure Digital Memory Cards . . . . .	24
<b>Performing a Reset</b> . . . . .	<b>24</b>
Soft Reset . . . . .	24
Hard Reset . . . . .	25

## 2 Using Microsoft® Pocket PC

<b>Device Buttons and the Stylus</b> . . . . .	<b>28</b>
<b>Today Screen</b> . . . . .	<b>28</b>
<b>Status Icons</b> . . . . .	<b>30</b>
<b>Programs</b> . . . . .	<b>31</b>
Program Buttons . . . . .	31
Switcher Bar . . . . .	32
<b>Navigation Bar and Command Bar</b> . . . . .	<b>33</b>
<b>Pop-Up Menus</b> . . . . .	<b>35</b>
<b>Finding and Organizing Information</b> . . . . .	<b>36</b>
<b>Backing Up Data</b> . . . . .	<b>37</b>

## 3 Entering Information

<b>Entering Text Using the Input Panel</b> . . . . .	<b>40</b>
Typing With the Soft Keyboard . . . . .	42
Letter Recognizer . . . . .	42
Block Recognizer . . . . .	43
Transcriber . . . . .	43
Editing Typed Text . . . . .	44
<b>Writing on the Screen</b> . . . . .	<b>44</b>
Editing Written Text . . . . .	45
<b>Drawing on the Screen</b> . . . . .	<b>48</b>
Creating a Drawing . . . . .	48
Editing a Drawing . . . . .	49

	<b>Recording a Message</b> . . . . .	<b>50</b>
	<b>Using My Text</b> . . . . .	<b>51</b>
<b>4</b>	<b>Adjusting Settings</b>	
	<b>Personal Tab</b> . . . . .	<b>54</b>
	<b>System Tab</b> . . . . .	<b>54</b>
	<b>Connections Tab</b> . . . . .	<b>55</b>
<b>5</b>	<b>Using Microsoft® ActiveSync®</b>	
	<b>About ActiveSync</b> . . . . .	<b>58</b>
	<b>Installing and Using ActiveSync</b> . . . . .	<b>59</b>
<b>6</b>	<b>Scheduling and Communicating</b>	
	<b>About Microsoft® Pocket Outlook</b> . . . . .	<b>62</b>
	<b>Calendar</b> . . . . .	<b>62</b>
	Using the Summary Screen . . . . .	64
	Creating Meeting Requests . . . . .	64
	<b>Contacts</b> . . . . .	<b>65</b>
	Finding a Contact . . . . .	66
	Using the Summary Screen . . . . .	67
	<b>Tasks</b> . . . . .	<b>67</b>
	<b>Notes</b> . . . . .	<b>68</b>

<b>Inbox</b> . . . . .	<b>70</b>
Synchronizing E-Mail Messages . . . . .	70
Connecting Directly to an E-Mail Server . . . . .	71
Using the Message List . . . . .	71
Composing Messages . . . . .	73
Managing E-Mail Messages and Folders . . . . .	75
<b>Notifications</b> . . . . .	<b>76</b>

## 7 Adding and Removing Programs

<b>Adding Programs Using Microsoft® ActiveSync®</b> . . . . .	<b>78</b>
<b>Downloading Programs From the Internet</b> . . . . .	<b>79</b>
<b>Adding a Program to the Start Menu</b> . . . . .	<b>80</b>
Using File Explorer on the Device . . . . .	80
Using ActiveSync on the Computer . . . . .	80
<b>Removing Programs</b> . . . . .	<b>81</b>

## 8 Using Companion Programs

<b>Microsoft Pocket Word</b> . . . . .	<b>84</b>
<b>Pocket Excel</b> . . . . .	<b>86</b>
Tips for Working in Pocket Excel . . . . .	88
<b>MSN Messenger</b> . . . . .	<b>89</b>
Setting Up . . . . .	89
Working With Contacts . . . . .	90
Chatting With Contacts . . . . .	90

<b>Windows® Media Player for Pocket PC</b> . . . . .	<b>91</b>
<b>Microsoft Reader</b> . . . . .	<b>91</b>
Using the Library . . . . .	92
Reading a Book . . . . .	92
Using Reader Features . . . . .	93
Removing a Book . . . . .	95

## 9 Using Microsoft® Pocket Internet Explorer

<b>Mobile Favorites</b> . . . . .	<b>98</b>
Conserving Memory . . . . .	99
Mobile Favorites Folder . . . . .	100
Favorite Links . . . . .	100
<b>Using AvantGo Channels</b> . . . . .	<b>100</b>
<b>Browsing Mobile Favorites and the Web</b> . . . . .	<b>101</b>

## 10 Getting Connected

<b>Using Infrared</b> . . . . .	<b>106</b>
<b>Creating a Modem Connection</b> . . . . .	<b>107</b>
<b>Creating an Ethernet Connection</b> . . . . .	<b>108</b>
<b>Creating a VPN Connection</b> . . . . .	<b>109</b>
<b>Ending a Connection</b> . . . . .	<b>110</b>
<b>Connecting Directly to an E-Mail Server</b> . . . . .	<b>111</b>
<b>Getting Help on Connecting</b> . . . . .	<b>111</b>

## 11 Appendix

<b>Specifications</b> . . . . .	<b>114</b>
<b>Regulatory Notices</b> . . . . .	<b>117</b>
FCC Notices (U.S. Only) . . . . .	119
IC Notice (Canada Only) . . . . .	121
CE Notice (European Union) . . . . .	122
CE Mark Notice . . . . .	122
EN 55022 Compliance (Czech Republic Only) . . . . .	124
MIC Notice (Republic of Korea Only) . . . . .	124
NOM Information (Mexico Only) . . . . .	127
<b>Contacting Dell</b> . . . . .	<b>128</b>
<b>Limited Warranties and Return Policy</b> . . . . .	<b>149</b>
Limited Warranty for Dell-Branded Hardware Products (U.S. Only) . . . . .	149
"Total Satisfaction" Return Policy (U.S. Only) . . . . .	153
Limited Warranty Terms for Dell-Branded Hardware Products (Canada Only) . . . . .	154
"Total Satisfaction" Return Policy (Canada Only) . . . . .	158
Dell Software and Peripherals (Canada Only) . . . . .	159
1-Year End-User Manufacturer Guarantee (Latin America and the Caribbean Only) . . . . .	160
<b>Glossary</b> . . . . .	<b>163</b>
 Index . . . . .	 165



# Finding Information

What Are You Looking For?	Find It Here:
How to set up my device and information on the connectors and buttons on my device	<i>Getting Started</i> placemat and the Dell™ <i>User's Guide</i>
Information on using my device.	Dell <i>User's Guide</i> and Pocket PC Help. To view Help, tap the <b>Start</b> button and tap <b>Help</b> .
Additional programs that can be installed on my device	Dell Companion CD
Information on using programs on my device	Pocket PC Help and, if available, tap <b>Help</b> within a specific program
Connecting to and synchronizing with a computer	Dell <i>User's Guide</i> and Microsoft® ActiveSync® Help on your computer. To view Help, click <b>Help</b> and click <b>Microsoft ActiveSync Help</b> .
Last-minute updates and detailed technical information	The readme files, located in the <b>ActiveSync</b> folder on the computer and on the Dell Companion CD.
Up-to-date information on your Pocket PC	<a href="http://www.microsoft.com/mobile/pocketpc">www.microsoft.com/mobile/pocketpc</a>
My service tag	Label located in the main battery slot (remove the main battery)



# 1

## SECTION 1

# About Your Device

---

Front, Side, and Back Views

Using the Batteries

Connecting to a Computer

Using Cards

Performing a Reset

# Front, Side, and Back Views

**⚠ CAUTION:** Before performing any of the procedures in this section, read and follow the safety instruction in the *System Information Guide*.

## Front and Side Views

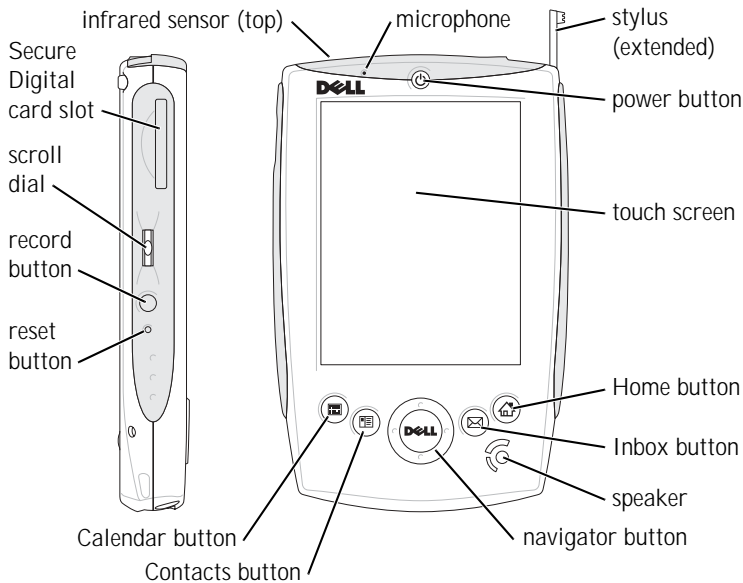

**INFRARED SENSOR** — The infrared sensor lets you transfer files from your device to another infrared-compatible device without using cable connections.

**MICROPHONE** — Allows you to record audio.

**STYLUS** — Use the stylus to write or draw on the screen. To remove the stylus, pull it straight up and out of the holder. To avoid losing the stylus, store the stylus in the holder when you are not using it. Ensure that the stylus is oriented correctly when you replace it in the slot.

**POWER BUTTON** — Press the power button to turn the device on or off. Press and hold the power button to dim the display. Repeat to light the display.

- When the device is connected to external power and the main battery is fully charged, the power button light is solid green.
- When the main battery charge is low, the power button light flashes amber.
- When the main battery is charging, the power button light is solid amber.
- When the device relays a notification, the power button light flashes green.

**TOUCH SCREEN** — Use the touch screen and the stylus to enter information into your device. See "Entering Information" on page 39.

**HOME BUTTON** — Press this button to launch Home or to turn on the device.

**INBOX BUTTON** — Press this button to launch your Inbox or to turn on the device.

**SPEAKER** — Tap the speaker icon to adjust the volume.

**NAVIGATOR BUTTON** — Press the right, left, top, or bottom of the navigator button to move the cursor on the screen.

**CONTACTS BUTTON** — Press this button to launch Contacts or to turn on the device.

**CALENDAR BUTTON** — Press this button to launch Calendar or to turn on the device.

**RESET BUTTON** — See "Performing a Reset" on page 24 for information on using the reset button.

**RECORD BUTTON** — See "Recording a Message" on page 50 for information on using the record button.

#### **SCROLL DIAL**

- Press the scroll dial to perform actions similar to pressing <Enter> on a keyboard.
- Rotate the scroll dial up or down to perform actions similar to using the up- and down-arrow keys on a keyboard.

For information on the functionality of the scroll dial within programs, see Pocket PC Help on your device.

**SECURE DIGITAL CARD SLOT** — See "Secure Digital Memory Cards" on page 24 for information on using Secure Digital memory cards.

## Back View

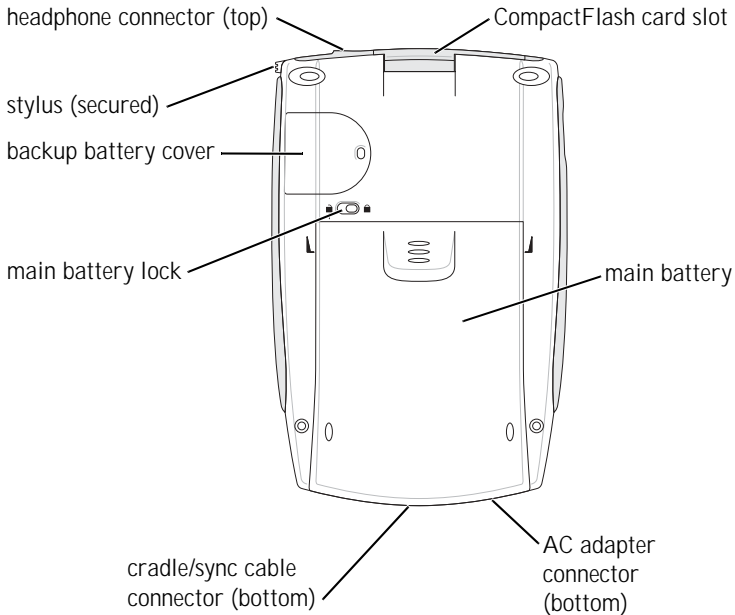

**COMPACTFLASH CARD SLOT** — See "CompactFlash Cards" on page 23 for information on using CompactFlash cards.

**MAIN BATTERY** — See "Using the Batteries" on page 15 for information on the main battery.

**AC ADAPTER CONNECTOR** — Connect the AC adapter.

**CRADLE/SYNC CABLE CONNECTOR** — Connect a cradle or sync cable. See "Connecting to a Computer" on page 19.

**MAIN BATTERY LOCK** — Use this switch to release and remove the main battery. See "Installing and Removing the Main Battery" on page 16.

**BACKUP BATTERY COVER** — Secures the backup battery. See "Installing and Removing the Backup Battery" on page 17.

**HEADPHONE CONNECTOR** — Attach headphones.

# Using the Batteries

Your device uses two batteries:

- rechargeable main battery
- lithium coin-cell backup battery

 **NOTICE:** Do not use your device until you have charged the main battery for at least 4 hours.

**Before you use your device for the first time, you must install both batteries and completely charge the main battery. Once the main battery is charged, use the power properties to monitor the battery charge. See Pocket PC Help on the device for more information.**

 **NOTICE:** After you install the batteries for the first time, do not remove the main battery and the backup battery from the device at the same time. Doing so results in the loss of all data stored in SDRAM.

 **NOTICE:** If you need to replace both batteries at the same time, ensure that you replace the main battery first.

## Installing and Removing the Main Battery

To install the main battery:

- 1 Ensure that the device is turned off.
- 2 Ensure that the main battery is oriented correctly and slide the battery into the slot until you feel a click.

To remove the main battery:

- 1 Insert the tip of the stylus into the main battery lock.
- 2 Slide and hold the lock in the unlock position.
- 3 Slide the battery out of the slot.

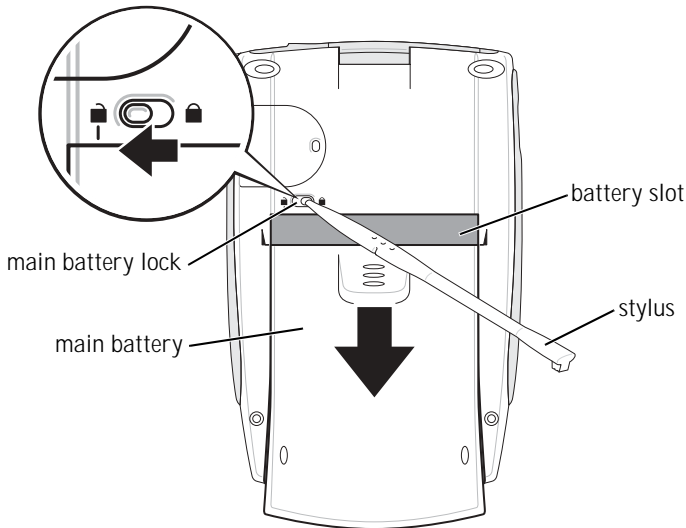

**NOTE:** Your service tag is located underneath the main battery. You need your service tag if you access Dell Support at [support.dell.com](http://support.dell.com) or if you call Dell for customer service or technical support.



## Installing and Removing the Backup Battery

**NOTICE:** Do not remove the backup battery unless the AC adapter is connected or the main battery is installed. Otherwise, you might lose data.

To install the backup battery:

- 1 Ensure that the device is turned off.
- 2 Insert the stylus into the backup battery release and slide the release to the left to remove the cover.

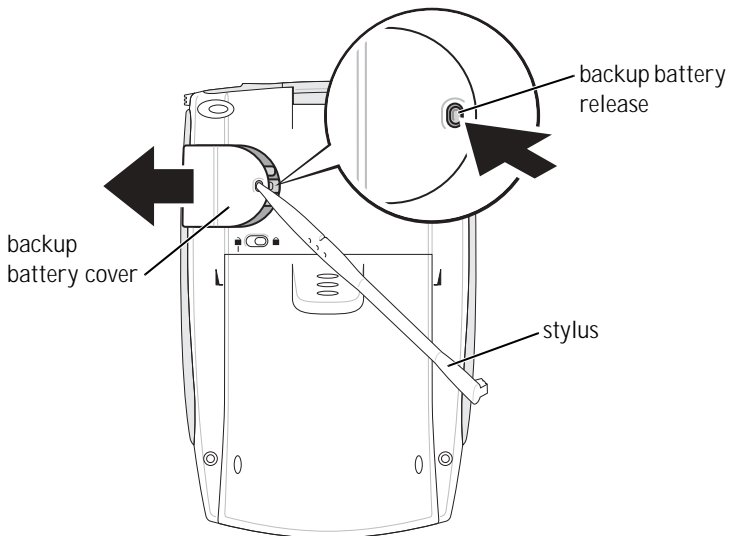

- 3 Wipe off the backup battery with a dry cloth.
- 4 Insert the backup battery with the positive side (+) facing up.
- 5 Slide the cover on and ensure that it is flush with the back of the device.

To remove the backup battery:

- 1 Insert the tip of the stylus into the backup battery release.
- 2 Slide the release to the left and remove the cover.
- 3 With your finger tip, gently press the right side of the battery to tilt up the left side of the battery.

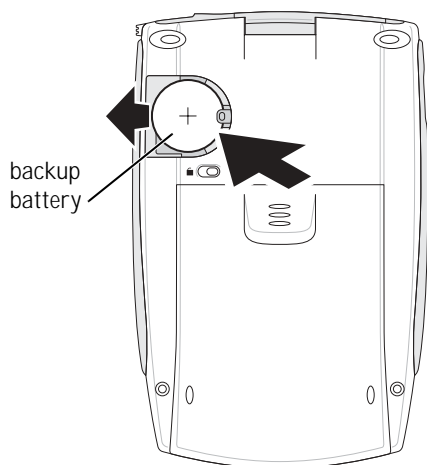

- 4 Remove the battery.

## Charging the Main Battery

Use one of the following options to charge the main battery:

- Connect the AC adapter directly to the device and to an electrical outlet.
- Connect the AC adapter to the cradle, and insert the device into the cradle. See "Using the Cradle" on page 19 for more information.

# Connecting to a Computer

You either connect your device to a computer using a cradle or directly to a computer using a sync cable. Connect your device to a computer to:

- Add programs to your device. See "Adding Programs Using Microsoft® ActiveSync®" on page 78 for more information.
- Synchronize data on your device with data on your computer.

For information on synchronizing your data, see the following resources:

- "Using Microsoft® ActiveSync®" on page 57
- ActiveSync Help on your computer
- ActiveSync Help on your device

## Using the Cradle



**NOTE:** Depending on the configuration of your device, the cradle is optional.

You can use the cradle to:

- Synchronize the data on your device with the data on your computer.
- Power the device with AC power to conserve battery power.
- Charge the main battery. See "Using the Batteries" on page 15 for more information.
- Charge a spare battery.

Before connecting your device to a computer for the first time, ensure that you install ActiveSync on the computer from the Dell™ Companion CD.

**To connect your device to the cradle:**

- 1 Place the cradle on a flat, level surface near your computer.**
- 2 Depending on the type of cradle that you have, connect the cradle cable to either the USB or serial connector on your computer.**

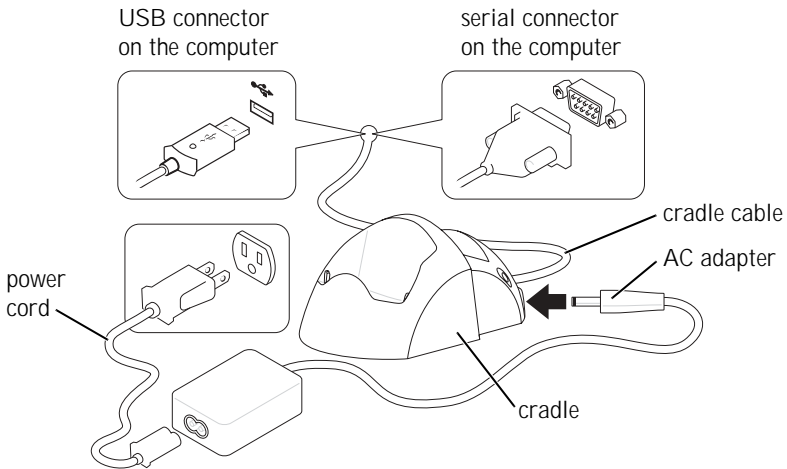

- 3 Connect the AC adapter to the cradle and to an electrical outlet.

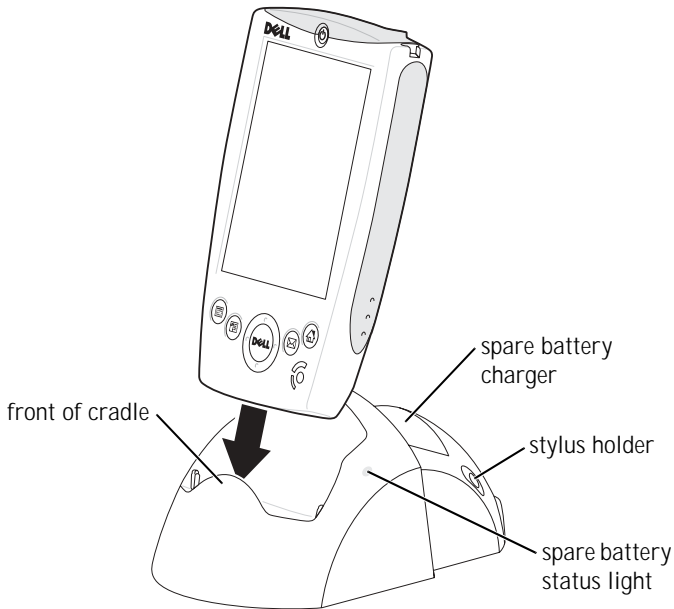

- 4 Align the connector on the bottom of the device with the connector on the cradle, and, keeping the front of the device flush with the front of the cradle, lower the device onto the cradle.

When the device is docked in the cradle, the DELL™ logo on the cradle lights up and the connection status icon appears on the command bar (see page 29).

The spare battery status light on the cradle operates as follows:

- Green — The spare battery is fully charged.
- Amber — The spare battery is charging.



**NOTE:** The power button on the device indicates the charge status of the main battery. See the description of the device status lights on page 13 for more information.

To remove the device from the cradle, pull the device straight up and out of the cradle.

## Using the Sync Cable

Use the sync cable to connect your device directly to the computer without using the cradle.

**NOTE:** Depending on the configuration of your device, the sync cable is optional.

To connect the sync cable:

- 1 Depending on the type of sync cable that you have, connect one end of the cable to either the USB connector or the serial connector on your computer.
- 2 Connect the other end of the cable to your device.

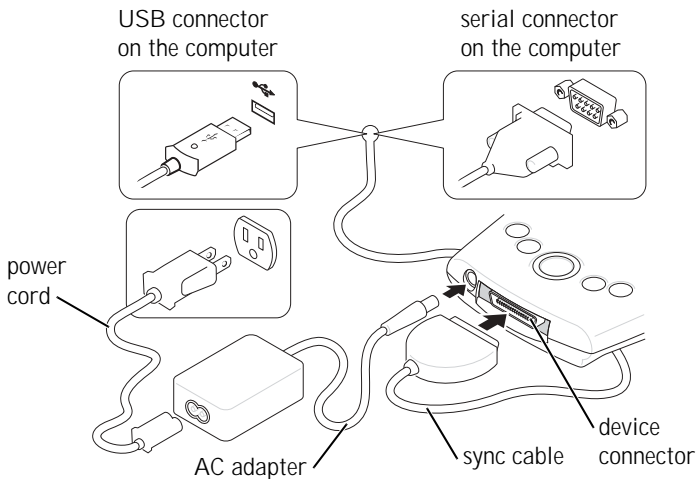

# Using Cards

## CompactFlash Cards

Your device supports CompactFlash Type I and Type II cards. Some common types of cards include:

- **Modem** — Connect a telephone line for modem data communications.
- **Wireless communication** — Perform data communications without the use of cable connections. You can use cards, such as Bluetooth™ and 802.11b wireless LAN.
- **Storage** — Save data or install programs on a storage card.

When you do not have a CompactFlash card installed, insert the plastic blank to protect the CompactFlash card slot.

To install a CompactFlash card:

- 1 If a blank is installed, remove it.

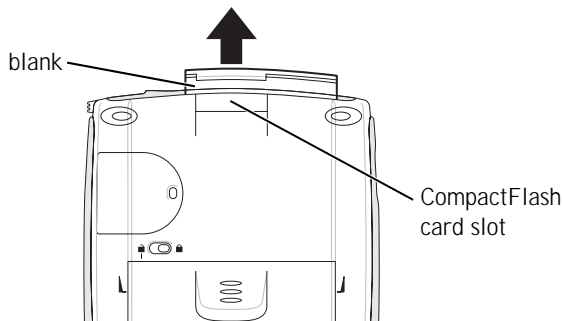

- 2 Ensure that the CompactFlash card is oriented correctly, and slide the card into the slot.

**NOTICE:** Do not force the card. If you feel resistance, remove the card, check the orientation, and reinsert it.

See the documentation that came with the card for information on using the card.

## Secure Digital Memory Cards

Use Secure Digital memory cards to save or back up data.

To install a Secure Digital memory card:

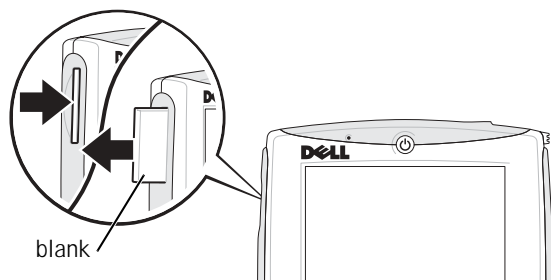

- 1 If a card is already installed, press in the card to release it, and then remove it.
- 2 Ensure that the card is oriented correctly, and slide it into the slot until you feel a click.

**NOTICE:** Do not force the card. If you feel resistance, remove the card, check the orientation, and reinsert it.

See the documentation that came with the card for information on using the card.

## Performing a Reset

### Soft Reset

When you perform a soft reset, the device deletes any data that has not been saved but saves any data that has been stored in memory. Try performing a soft reset if the device does not respond when you tap the display or press a button.

To perform a soft reset, use the stylus to press the reset button.



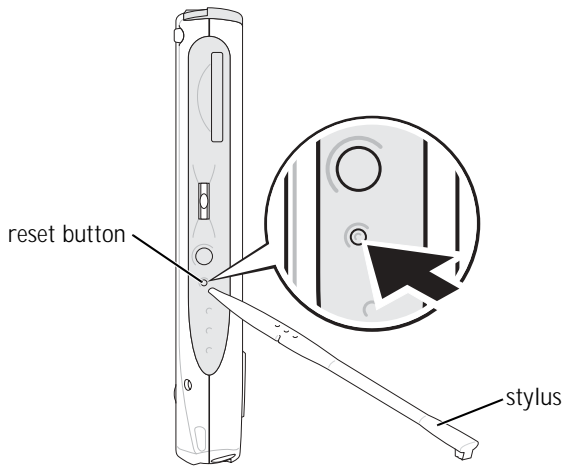

## Hard Reset



**NOTICE:** When you perform a hard reset, you lose all the data stored on your device.

### Perform a hard reset if:

- You want to delete all the data stored on your device.
- You forget your password and need to clear it.
- Your device is experiencing severe operational problems and you have already attempted a soft reset.



**NOTICE:** It is strongly recommended that you back up your data before you perform a hard reset. See ActiveSync Help on your computer for more information.

### To perform a hard reset:

- 1 Press and hold the power button.
- 2 With the stylus, hold the reset button for about 2 seconds.
- 3 Follow the instructions on the screen.



# 2

## SECTION 2

# Using Microsoft<sup>®</sup> Pocket PC

---

Device Buttons and the Stylus

Today Screen

Status Icons

Programs

Navigation Bar and Command Bar

Pop-Up Menus

Finding and Organizing Information

Backing Up Data

## Device Buttons and the Stylus

Your device has hardware buttons that control actions and scroll functions, and a stylus for selecting items and entering information.

On the device, the stylus replaces the mouse:

- **Tap** — Touch the screen once with the stylus to open items and select options.
- **Drag** — Hold the stylus and drag across the screen to select text and images. Drag in a list to select multiple items.
- **Tap and hold** — Tap and hold the stylus on an item to see a list of actions available for that item. On the pop-up menu that appears, tap the action you want to perform.

See "Entering Information" on page 39 for more information.

## Today Screen

When you turn on your device for the first time each day (or after 4 hours of inactivity), the **Today** screen appears. You can also view the **Today** screen by tapping the **Start** button and then tapping **Today**. The **Today** screen displays the date and information about the device owner, today's calendar, and important tasks. To customize the **Today** screen:



- 1 Tap the **Start** button and tap **Settings**.
- 2 Tap the **Personal** tab and tap **Today**.



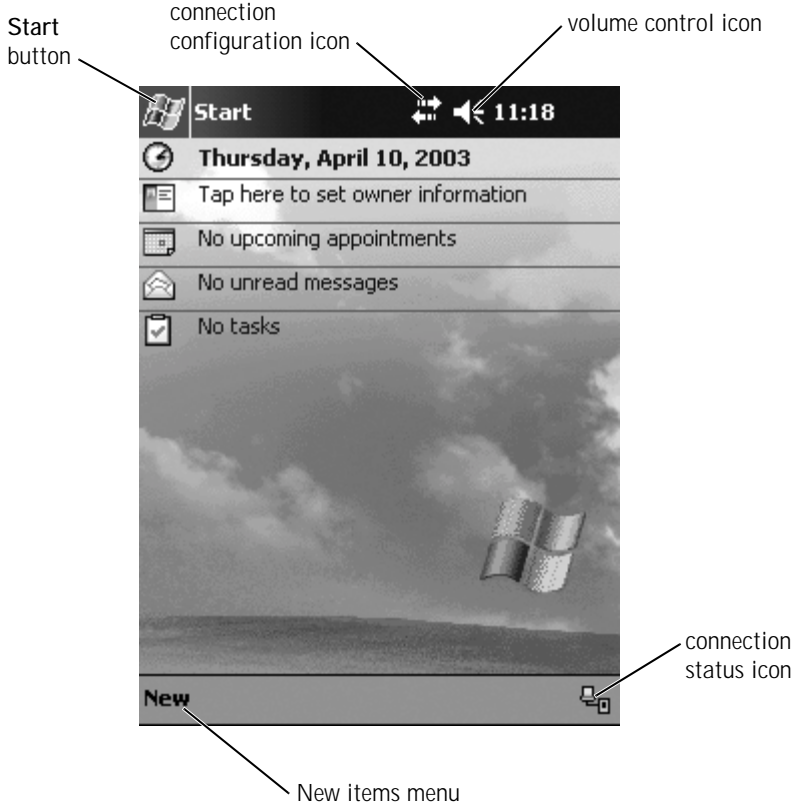







Use the **Appearance** tab to change the background that displays on the **Today** screen.



Use the **Items** tab to change the items that appear on the **Today** screen.



# Status Icons

 **NOTE:** If there is not enough room to display all notification icons, the notification icon, , displays. Tap the notification icon to view all notifications.

Icon	Description
	Turns sound on and off.
	Backup battery is low.
	Main battery is charging.
	Main battery is low.
	Main battery is very low.
	Main battery is full.
	Connection is active. Tap the icon to configure connections.
	Connection is not detected.
	Wireless network is detected.
	Synchronization is beginning or ending.

Icon	Description
	Synchronization is occurring.
	New instant message(s).
	New e-mail message(s).

## Programs

You can switch from one program to another by selecting a program from the **Start** menu. To access programs that are not listed in the **Start** menu, tap the **Start** button, tap **Programs**, and then tap the program name.

 **NOTE:** Some programs have abbreviated labels for check boxes and drop-down menus. To see the full spelling of an abbreviated label, tap and hold the stylus on the label. Drag the stylus off the label so that the command is not carried out.

### Program Buttons

You can also switch to some programs by pressing a program button. Your device has four program buttons located on the front of the device. The icons on the buttons identify the programs to which they switch. By default, the buttons launch Home, Inbox, Contacts, and Calendar.

## Switcher Bar

You can also use Switcher Bar to switch to or close open programs. To launch Switcher Bar:





- 1 Tap the **Start** button and tap **Settings**.
- 2 Tap the **System** tab and tap **Switcher Bar**.

The Switcher Bar icon, , appears in the navigation bar.







Tap  to view a list of all open programs. In the **Switcher Bar** menu:

- Tap **Brightness settings** or **Power settings** to configure those settings.
- Tap a program name to switch to that program.
- Tap **Exit current program** to close the current program.
- Tap **Exit all programs** to close all open programs.
- Tap **Exit Switcher Bar** to close the menu.

The following table contains a partial list of programs that are on your device. See the Dell™ Companion CD for additional programs that you can install on your device.

Icon	Program	Description
	ActiveSync	Synchronize information between your device and your computer.
	Calendar	Keep track of your appointments and create meeting requests.
	Contacts	Keep track of your friends and colleagues.
	Inbox	Send and receive e-mail messages.



Icon	Program	Description
	Pocket Internet Explorer	Browse websites and WAP sites, and download new programs and files from the Internet.
	Notes	Create handwritten or typed notes, drawings, or recordings.
	Tasks	Keep track of your tasks.
	Pocket Excel	Create new workbooks or view and edit Excel workbooks that you created on your computer.
	MSN Messenger	Send and receive instant messages with your MSN Messenger contacts.
	Pocket Word	Create new documents or view and edit Word documents that you created on your computer.

## Navigation Bar and Command Bar

The navigation bar is located at the top of the screen. It displays the active program and current time and allows you to switch to other programs and close screens.

Use the command bar at the bottom of the screen to perform tasks in programs. The command bar includes menu names, icons, and the input panel icon. To create a new item in the current program, tap **New**. To see the name of an icon, tap and hold the stylus on the icon. Drag the stylus off the icon so that the command is not carried out.

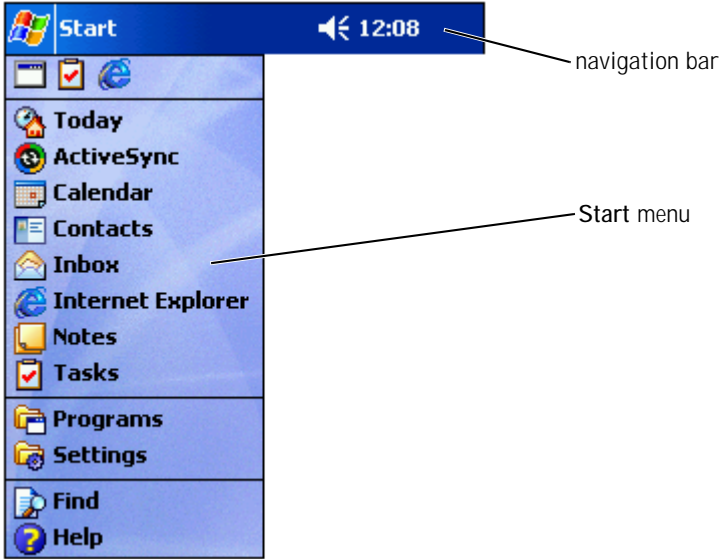

# Pop-Up Menus

With pop-up menus, you can quickly select an action for an item. For example, you can use the pop-up menu in the contact list to delete a contact, make a copy of a contact, or send an e-mail message to a contact. The actions in the pop-up menus vary from program to program. To access a pop-up menu, tap and hold the stylus on an item name. When the menu appears, lift the stylus and tap the action you want to perform. To close the menu without performing an action, tap anywhere outside the menu.

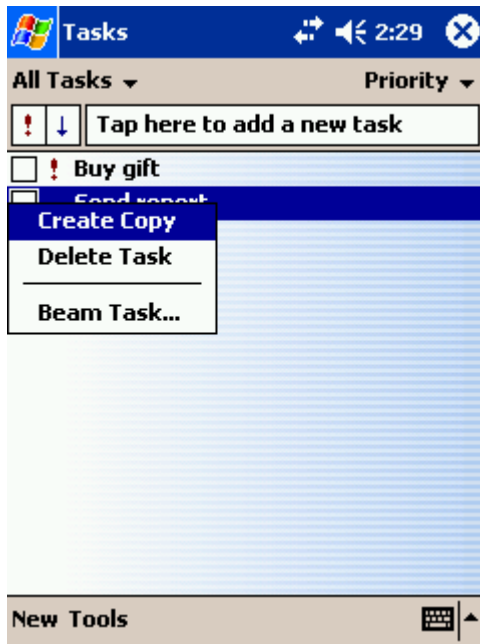

# Finding and Organizing Information

The Find feature on your device helps you to quickly locate information.

On the **Start** menu, tap **Find**. Enter the item that you want to find, select a data type from the drop-down menu, and then tap **Go** to start the search.

You can also use the File Explorer to find files on your device and to organize your files into folders. On the **Start** menu, tap **Programs** and tap **File Explorer**:

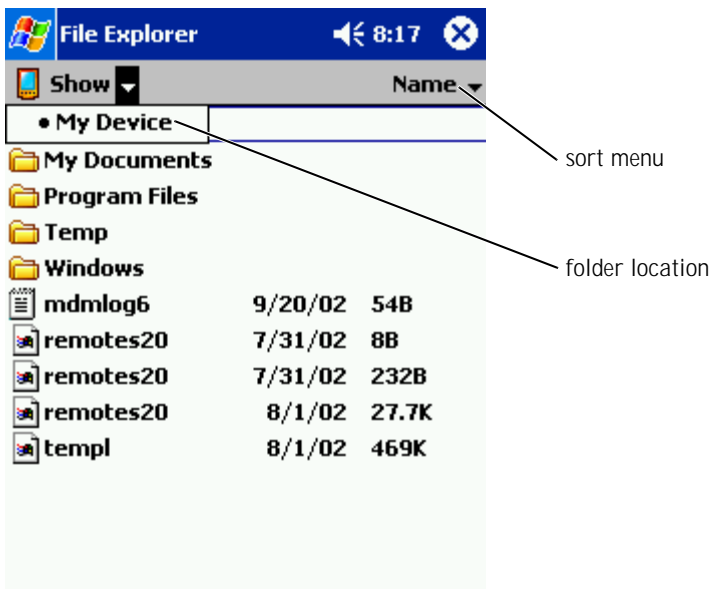

## Backing Up Data

-  **NOTICE:** If you are upgrading to Pocket PC 2003 from Pocket PC 2002, do not use the Data Backup utility on your device or the **Backup/Restore** option in ActiveSync to back up your files. You cannot recover your data after you install the upgrade if you do so. Follow the instructions included with the Pocket PC 2003 System Update to back up your data.

**To prevent or minimize data loss, you should periodically back up the data stored on your device. Use ActiveSync to synchronize the files on your device with the files on your computer. You can also drag and drop files from your device to your computer using Windows Explorer. See the ActiveSync Help on your computer for additional information.**



# 3

## SECTION 3

# Entering Information

---

Entering Text Using the Input Panel

Writing on the Screen

Drawing on the Screen

Recording a Message

Using My Text

You have several options for entering information:

- Use the input panel to enter typed text using the soft keyboard or another input method.
- Write directly on the screen with the stylus.
- Draw pictures on the screen with the stylus.
- Speak into your device microphone to record a message.

Use Microsoft® ActiveSync® to synchronize or copy information from your computer to your device. For more information on ActiveSync, see ActiveSync Help on your computer.

## Entering Text Using the Input Panel

Use the input panel to enter information in any program on your device. You can type using the soft keyboard or write using Letter Recognizer, Block Recognizer, or Transcriber. The characters appear as typed text on the screen.

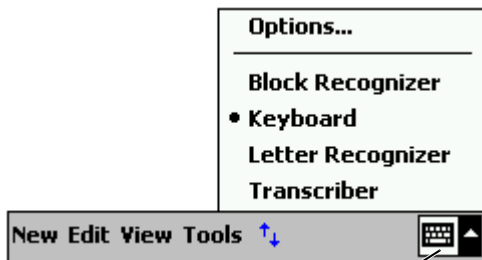

input panel icon

To show or hide the input panel, tap the input panel icon. Tap the arrow next to the input panel icon to change input methods.



When you use the input panel, your device anticipates the word you are typing or writing and displays it above the input panel. When you tap the displayed word, the word is inserted at the insertion point. The more you use your device, the more words it learns to anticipate.

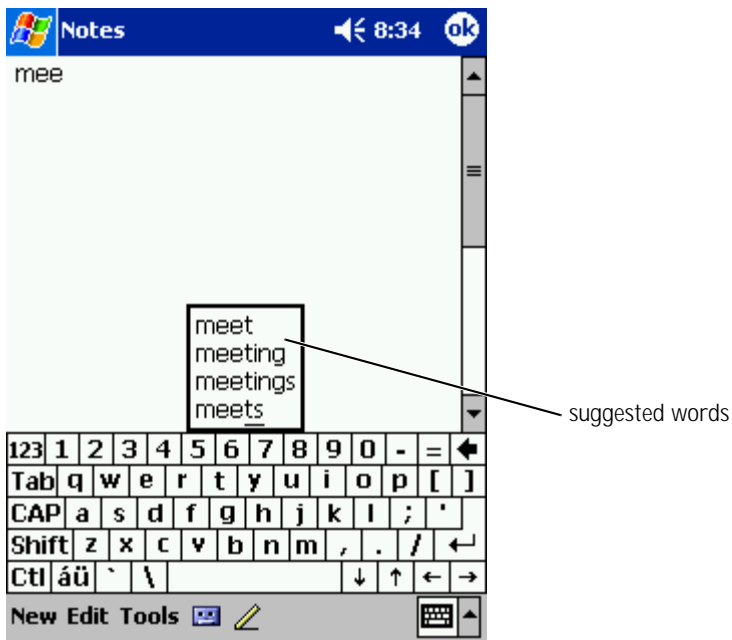

To change word suggestion options, such as the number of words suggested:

- 1 Tap the **Start** button and tap **Settings**.
- 2 Tap the **Personal** tab, tap **Input**, and then tap the **Word Completion** tab.
- 3 Select the desired settings and tap **OK**.

## Typing With the Soft Keyboard

- 1 Tap the arrow next to the input panel icon and tap **Keyboard**.
- 2 Tap the keys on the soft keyboard with your stylus.

## Letter Recognizer

Letter Recognizer allows you to use your stylus to write letters on the screen as you would write them on paper.



**NOTE:** Letter Recognizer is included with the English, French, German, Italian, and Spanish operating systems. Other versions do not support Letter Recognizer.

- 1 Tap the arrow next to the input panel icon and tap **Letter Recognizer**.
- 2 With your stylus, write a letter between the lines that appear on the bottom of the screen.

The letters are converted to typed text on the screen. For specific instructions on using Letter Recognizer, tap the question mark next to the writing area.



**NOTE:** Tap Demo to learn the character strokes that the device can recognize.

## Block Recognizer

Block Recognizer allows you to use character strokes that are similar to those used on other handheld devices.

 **NOTE:** Block Recognizer is included with the English, French, German, Italian, and Spanish operating systems. Other versions do not support Block Recognizer.

- 1 Tap the arrow next to the input panel icon and tap **Block Recognizer**
- 2 Using your stylus, write the appropriate character stroke in the box that appears at the bottom of the screen.

The character strokes are converted to typed text on the screen. For specific instructions on using Block Recognizer, tap the question mark next to the writing area.

 **NOTE:** Tap Demo to learn the character strokes that the device can recognize.

## Transcriber

Transcriber allows you to write anywhere on the screen using the stylus similar to the way that you would write on paper. Unlike Letter Recognizer and Block Recognizer, you can write a sentence or more, and then pause to let Transcriber change the written characters to typed characters.

 **NOTE:** Transcriber is included with the English, French, and German operating systems. Other versions do not support Transcriber.

- 1 Tap the arrow next to the input panel icon and tap **Transcriber**
- 2 With your stylus, write anywhere on the screen.

When you pause, Transcriber converts your written characters to typed characters. For specific instructions on using Transcriber, tap the question mark in the lower right hand corner of the screen.

## Editing Typed Text

To edit or format typed text, you must select it first:

- 1 Drag the stylus across the text that you want to select.
- 2 Tap and hold the selected text.
- 3 Tap the appropriate editing command in the pop-up menu.

You can also tap **Edit** at the bottom of the screen to select editing commands.

## Writing on the Screen

In any program that accepts written text, such as the Notes program and the **Notes** tab in some programs, you can use your stylus to write directly on the screen. You can edit and format what you have written and convert the information to text at a later time.



**NOTE:** Some programs that accept written text may not have the pen icon. See the documentation for that program to find out how to switch to writing mode.

To write on the screen, tap the pen icon to switch to writing mode. This action displays lines on the screen to help you write.



## Editing Written Text

To edit or format written text, you must select it first:

- 1 Tap the pen icon to deselect it.
- 2 Drag the stylus across the text that you want to select.
- 3 Tap and hold the selected text.
- 4 Tap the appropriate editing command in the pop-up menu.

You can also tap **Edit** at the bottom of the screen to select editing commands.

- 5 Tap the pen icon to switch back to writing mode.

To convert written text to print-style text, tap **Tools** and tap **Recognize**.

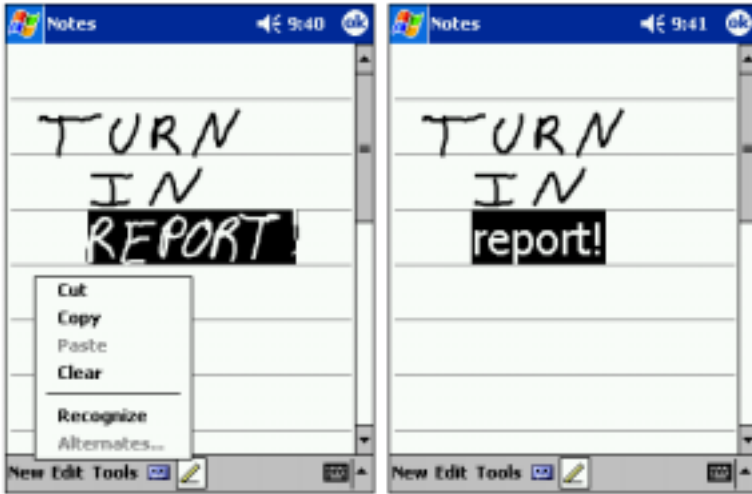

If you want to convert only certain words, select them before tapping **Recognize** (or tap and hold the selected words and then tap **Recognize** on the pop-up menu). If a word is not recognized, it is not converted to print-style text.

If the conversion is incorrect, you can select different words from a list of alternatives or return to the original written text:

- 1 Tap and hold the incorrect word.
- 2 On the pop-up menu, tap **Alternates**.  
A menu with a list of alternative words appears.
- 3 Tap the correct word, or tap the written text at the top of the menu to return to the original written text.

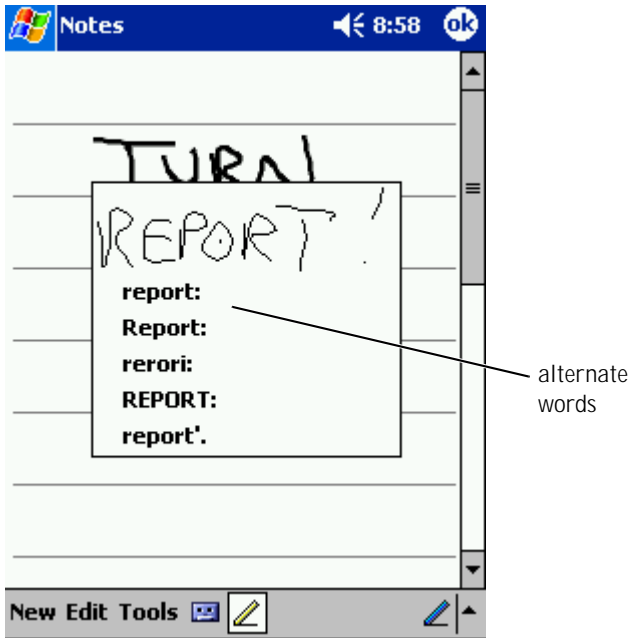

### Tips for getting good recognition:

- Write neatly.
- Write on the lines and draw descenders below the line. Write the cross of the "t" and apostrophes below the top line so that they are not confused with the word above. Write periods and commas above the line.
- For better recognition, try changing the zoom level to 300 percent using the **Tools** menu.
- Write the letters of a word closely and leave big gaps between words so that the device can easily determine where words begin and end.
- Hyphenated words, foreign words that use special characters such as accents, and some punctuation cannot be converted.

- You cannot add written text to a word to change it after the word has been recognized. You must delete the written word and write the new word.

## Drawing on the Screen

You can draw on the screen the same way that you write on the screen; however, selecting and editing drawings is different than selecting and editing written text. For example, selected drawings can be resized, while written text cannot.

### Creating a Drawing



**NOTE:** To zoom in or out on your drawing, tap Tools and tap a zoom level.

Cross three ruled lines on your first stroke. A drawing box appears. Subsequent strokes that touch or are inside of the drawing box become part of the drawing. Drawings that do not cross three ruled lines are treated as written text.



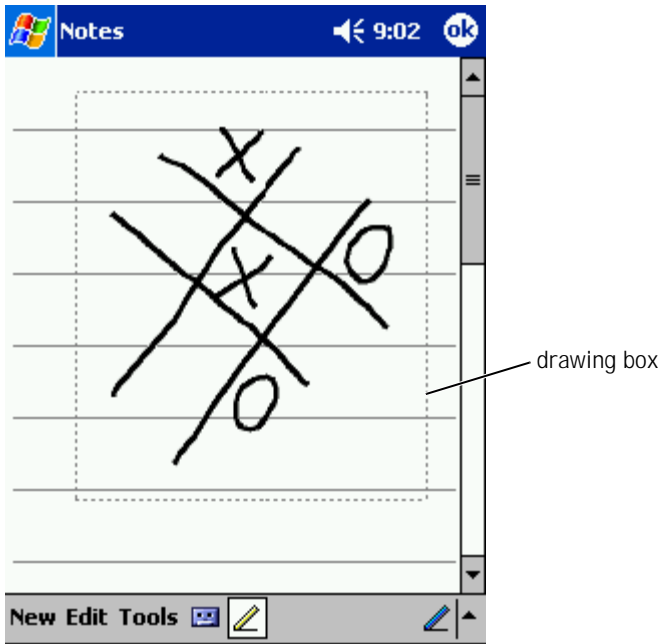

## Editing a Drawing

To edit or format a drawing, you must select it first:

- 1 Tap and hold the stylus on the drawing until the selection handle appears.  
To select multiple drawings, deselect the pen icon and drag to select the drawings.
- 2 Tap and hold the selected drawing and tap an editing command on the pop-up menu.

- 3 You can cut, copy, and paste selected drawings by tapping and holding the selected drawing and then tapping an editing command on the pop-up menu.

You can also tap **Edit** at the bottom of the screen to select editing commands.

To resize a drawing, ensure that the Pen icon is not selected, and drag a selection handle.

## Recording a Message

In any program where you can write or draw on the screen, you can also quickly capture thoughts, reminders, and phone numbers by recording a message. In Calendar, Tasks, and Contacts, you can include a recording in the **Notes** tab. In the Notes program, you can either create a stand-alone recording or include a recording in a written note. If you want to include the recording in a note, open the note first. In the Inbox program, you can add a recording to an e-mail message.

To record a message:

- 1 Hold the microphone near your mouth or other source of sound.
- 2 Press and hold the Record button on the side of your device until it beeps.
- 3 While holding down the Record button, make your recording.
- 4 To stop recording, release the Record button.

The device beeps twice. The new recording appears in the note list or as an embedded icon.



**NOTE:** You can also make a recording by tapping the Record icon on the Recording toolbar.

To play a recording, tap the name of the recording in the list or tap the speaker icon in the note.

# Using My Text

When using Inbox or MSN Messenger, use My Text to quickly insert preset or frequently used messages. To insert a message, tap **My Text** and tap a message.



 **NOTE:** You can add text to a My Text message after you insert the message.

To edit a My Text message:

- 1 In Inbox or MSN Messenger, tap **Tools**.
- 2 Tap **Edit My Text Messages**.
- 3 Make the changes and tap **OK**.



# 4

## SECTION 4

# Adjusting Settings

---

Personal Tab

System Tab

Connections Tab

You can adjust the device settings to suit the way you work. To see available options, tap the **Start** button and tap **Settings**.



**NOTE:** Depending on the features of your device, you might have additional tabs and additional items on the tabs.

See Pocket PC Help on your device for additional information on adjusting settings (tap the **Start** button and tap **Help**).

## Personal Tab

- **Buttons** — Assign the programs that launch when you press the hardware buttons.
- **Input** — Adjust the settings for input method, word completion, and other options.
- **Menus** — Add or remove items from the **Start** menu.
- **Navigator Button** — Configure your device to allow you to press the center of the navigator button to perform functions similar to pressing <Enter> on a keyboard.
- **Owner Information** — Enter your contact information.
- **Password** — Set a password to protect the data stored on your device.
- **Sounds & Notification** — Adjust the volume and set notifications. See "Notifications" on page 76 for more information.
- **Today** — Customize the look and the information that is displayed on the Today screen.

## System Tab

- **About** — Find information about Microsoft® Pocket PC and your device.
- **Brightness** — Adjust the brightness settings to conserve power.

- **Certificates** — View or delete certificates stored on your device. Certificates help establish your identity and the identity of other computers to prevent unauthorized users from accessing your data.
- **Clock** — Change the time or set the alarm.
- **Microphone** — Adjust the microphone gain.
- **Power** — Check the battery or charge status. Set the amount of time that the device can remain idle before it turns off.
- **Regional Settings** — View and change the formatting for regional settings, such as currency, time, and date.
- **Remove Programs** — Remove programs from your device. For more information, see "Adding and Removing Programs" on page 77.
- **Screen** — Adjust the screen if your device is not responding accurately to taps.
- **Switcher Bar** — Adjust the settings of the Switcher Bar program launcher utility.
- **System Information** — View technical information about your device.

## Connections Tab

- **Beam** — Receive infrared beams from other devices.
- **Bluetooth** — Turn the Bluetooth™ radio on and off, and create and edit bonded devices. By default, the Bluetooth radio is off.
- **Connections** — Add and configure modem or server connections.
- **Wireless Ethernet** — Configure your network adapter settings.





# 5

SECTION 5

## Using Microsoft<sup>®</sup> ActiveSync<sup>®</sup>

---

About ActiveSync

Installing and Using ActiveSync

# About ActiveSync

You can synchronize the information on your computer with the information on your device with ActiveSync. Synchronization compares the data on your device with the data on your computer and updates both with the most recent information. For example:

- **Keep Microsoft Pocket Outlook data up-to-date by synchronizing your device with Microsoft Outlook data on your computer.**
- **Synchronize Microsoft Word and Microsoft Excel files between your device and your computer. Your files are automatically converted to the correct format.**



**NOTE:** By default, ActiveSync does not automatically synchronize all types of information. You can change ActiveSync options to synchronize specific types of information.

With ActiveSync, you can also:

- **Back up and restore your device data.**



**NOTICE:** If you are upgrading to Pocket PC 2003 from Pocket PC 2002, do not use the Data Backup utility on your device or the **Backup/Restore** option in ActiveSync to back up your files. You cannot recover your data after you install the upgrade if you do so. Follow the instructions included with the Pocket PC 2003 System Update to back up your data.

- **Copy (rather than synchronize) files between your device and your computer.**
- **Select a synchronization mode to control when synchronization occurs. For example, you can synchronize continuously or only when you select the synchronize command.**
- **Select which information types are synchronized and control how much data is synchronized. For example, you can choose how many weeks of past appointments you want synchronized.**

To synchronize your data, you need both the Microsoft Windows<sup>®</sup> and Pocket PC versions of ActiveSync. You must install the Windows version of ActiveSync on your computer using the Dell™ Companion CD. The Pocket PC version is already installed on your device.

## Installing and Using ActiveSync

To install ActiveSync:

- 1 Insert the Dell Companion CD.
- 2 Click the yellow triangle to access the main menu.
- 3 Click **Start Here**.
- 4 Click **Install ActiveSync** and follow the instructions on the screen.

After the installation is complete, the ActiveSync Setup Wizard helps you to connect your device to your computer, set up a partnership so that you can synchronize information between your device and your computer, and customize your synchronization settings. Your first synchronization process automatically begins when you complete the wizard.

During your first synchronization, information that was stored in Outlook on your computer is copied to Calendar, Contacts, and Tasks on your device.

After you set up ActiveSync and complete the first synchronization process, you can initiate synchronization from your device. To switch to ActiveSync on your device, tap the **Start** button and tap **ActiveSync**. If you have a wireless LAN card, you can synchronize remotely from your device.

To find information on using ActiveSync on your device, open ActiveSync on your device, tap the **Start** button, and then tap **Help**.

To find information on using ActiveSync on your computer, open ActiveSync on your computer, and click **Help**→ **Microsoft ActiveSync Help**.



# 6

## SECTION 6

# Scheduling and Communicating

---

About Microsoft® Pocket Outlook

Calendar

Contacts

Tasks

Notes

Inbox

Notifications

## About Microsoft® Pocket Outlook

Pocket Outlook includes Calendar, Contacts, Tasks, Inbox, and Notes. You can use these programs individually or together. For example, e-mail addresses stored in Contacts can be used to address e-mail messages in Inbox.

Using Microsoft ActiveSync®, you can synchronize information in Microsoft Outlook or Microsoft Exchange on your computer with your device. You can also synchronize this information directly with an Exchange server. Each time you synchronize, ActiveSync compares the changes you made on your device and computer or server and updates both computers with the latest information. For information on using ActiveSync, see ActiveSync Help on your computer.

You can switch to any of the following programs through the **Start** menu.

### Calendar

Use Calendar to schedule appointments, including meetings and other events. You can check your appointments in one of several views (Agenda, Day, Week, Month, and Year) and easily switch views by using the view menu. Tap the today icon to view the current date.

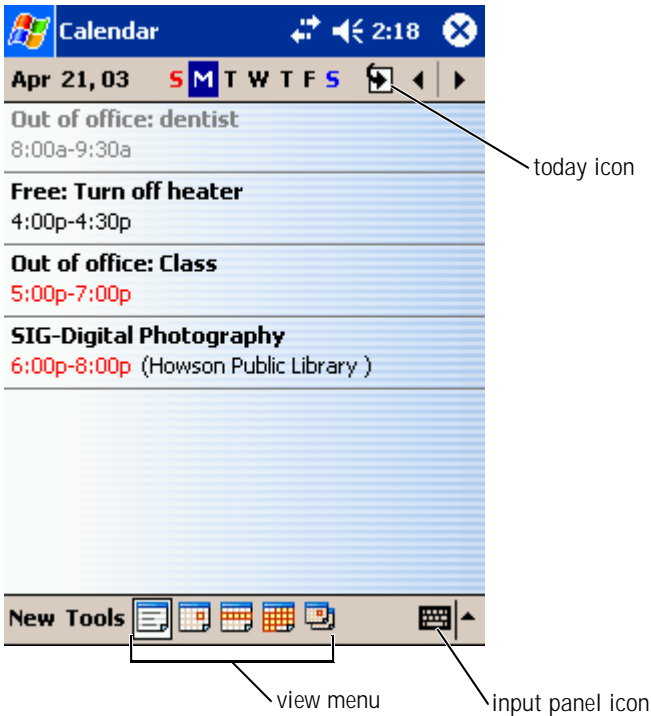

**NOTE:** To customize Calendar, such as changing the first day of the week, tap Tools and tap Options.

To create an appointment:

- 1 In the Day or Week view, tap the desired date and time for the appointment.
- 2 Tap **New**.
- 3 Tap a field to select it, and enter a description and a location using the input panel.
- 4 If necessary, tap the date and time to change them.

- 5 To see all available fields, tap the input panel icon to hide it. Enter the remaining information, if necessary.
- 6 To add notes, tap the **Notes** tab.  
You can enter text, draw, or create a recording. For more information on creating notes, see "Notes" on page 68.
- 7 When you have finished entering information, tap **OK** to return to the calendar.

To receive a notification for an appointment, select **Remind me** in the appointment settings. You can configure notifications through the Sounds & Notifications icon. For more information, see "Notifications" on page 76.

## Using the Summary Screen

When you tap an appointment in Calendar, a summary screen displays. To change the appointment, tap **Edit**.

## Creating Meeting Requests

You can use Calendar to set up meetings with users of Outlook or Pocket Outlook. The meeting request is automatically created when you synchronize Inbox or when you connect to your e-mail server. To set how you want meeting requests sent, tap **Tools** and tap **Options**. If you send and receive e-mail messages through ActiveSync, select **ActiveSync**.

To schedule a meeting:

- 1 Create an appointment.
- 2 On the **Appointment** tab, tap the input panel to hide it, and then tap **Attendees**.  
The **Attendees** field lists the e-mail addresses that you have entered in Contacts.
- 3 Select the meeting attendees.

The meeting notice is created automatically and placed in the **Outbox** folder.



For more information on sending and receiving meeting requests, tap the **Start** button, tap **Help**, and then tap **Calendar** or **Inbox**.

## Contacts

Use Contacts to maintain a list of your friends and colleagues. You can quickly share Contacts information with other device users using the infrared port.

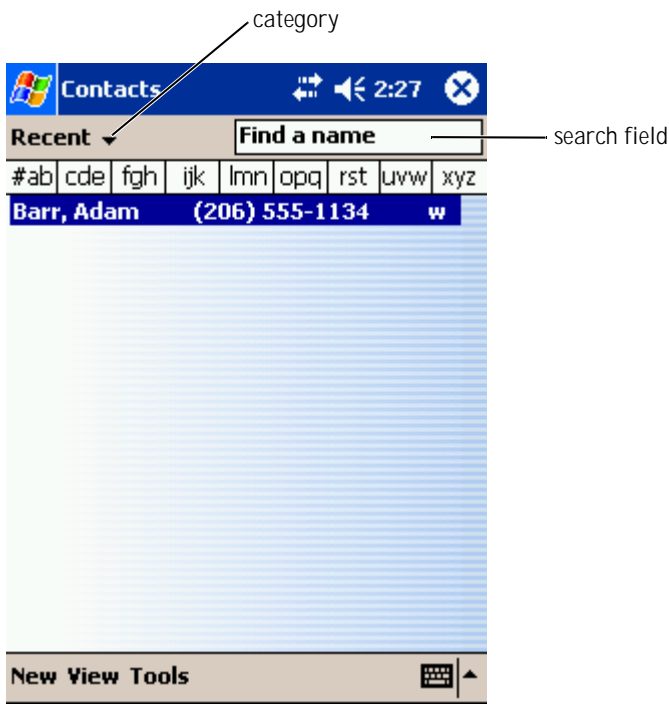

 **NOTE:** To change the way information is displayed in the list, tap Tools and tap Options.

To create a contact:

- 1 Tap the **Start** button and tap **Contacts**.
- 2 Tap **New**.
- 3 Using the input panel, enter a name and other contact information. Scroll down to see all available fields.
- 4 To assign the contact to a category, tap **Categories** and select a category from the list.

In the contact list, you can display contacts by category.

- 5 To add notes, tap the **Notes** tab. You can enter text, draw, or create a recording. For more information on creating notes, see "Notes" on page 68.
- 6 When you have finished entering information, tap **OK** to return to the calendar.

## Finding a Contact

You can find a contact using one of the following methods:

- In Contacts, enter a contact name in the field under the navigation bar. To show all contacts, clear text from the box or tap the arrow to the right of the box.
- In Contacts, tap the category list (labeled **All Contacts** by default) and select a category. To show all contacts again, tap **All Contacts**. To view a contact not assigned to a category, select **None**.
- To view the names of companies your contacts work for, tap **View** in the contact list and tap **By Company**. The number of contacts that work for that company is displayed to the right of the company name.
- Tap the **Start** button, tap **Find**, and then enter the contact name. In the **Type** drop-down menu, tap **Contacts**, and then tap **Go**.

## Using the Summary Screen

When you tap a contact in the contact list, a summary screen is displayed. To change the contact information, tap **Edit**.

## Tasks

 **NOTE:** To change the way information is displayed in the list, tap Tools and tap Options.

Use Tasks to keep a list of things that you need to do.

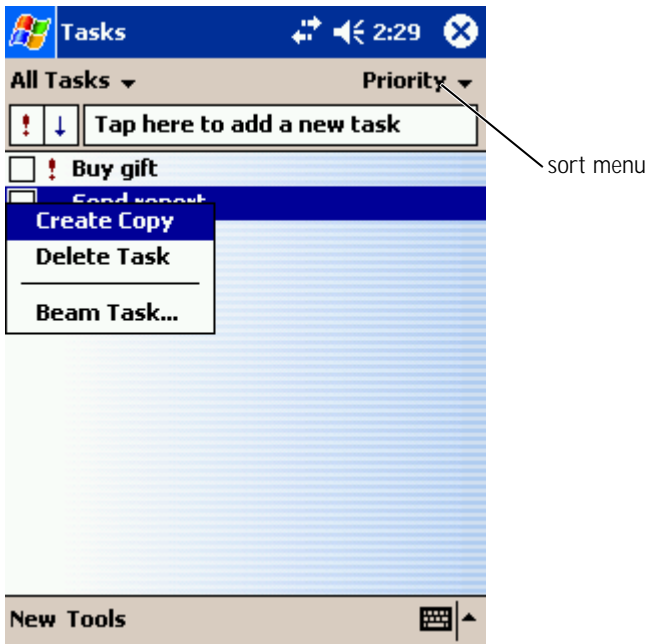

To create a task:

- 1 Tap the **Start** button and tap **Tasks**.
- 2 Tap **New**.
- 3 Enter a description using the input panel.
- 4 If necessary, enter a start date and due date or other information by first tapping the field. Tap the input panel icon to hide it to see all available fields.
- 5 To assign the task to a category, tap **Categories** and select a category from the list. In the task list, you can display tasks by category.
- 6 To add notes, tap the **Notes** tab. You can enter text, draw, or create a recording. For more information on creating notes, see "Notes" on page 68.
- 7 When you have finished entering information, tap **OK** to return to the calendar.



**NOTE:** To quickly create a task with only a subject, tap **Tools** and tap **Entry Bar**. Tap **Tap here to add a new task**, and enter your task information.

## Notes

Quickly capture thoughts, reminders, ideas, drawings, and phone numbers with Notes. You can create a written note or a recording. You can also include a recording in a note. If a note is open when you create the recording, it is included in the note as an icon. If a note is not open, the recording is saved as a stand-alone recording.

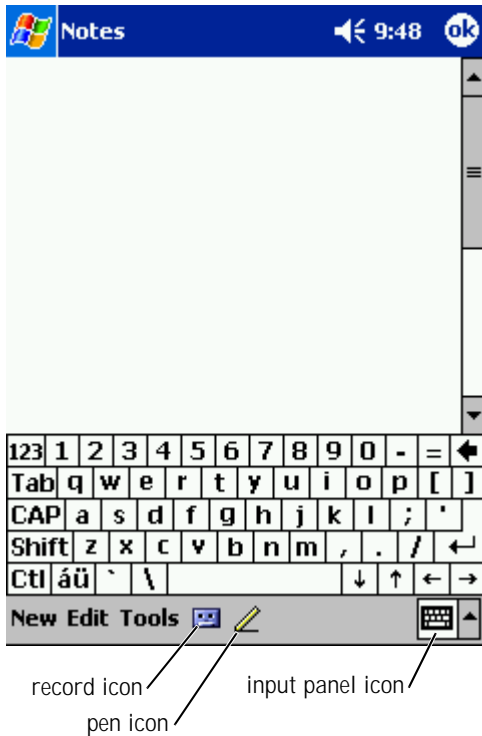

To create a note:

- 1 Tap the **Start** menu and tap **Notes**.
- 2 Tap **New**.
- 3 Create your note by writing, drawing, typing, or recording. For more information on using the input panel, writing and drawing on the screen, and creating recordings, see "Entering Information" on page 39.

# Inbox

Use Inbox to send and receive e-mail messages:

- Synchronize e-mail messages using Exchange or Outlook on your computer.
- Send and receive e-mail messages by connecting directly to an e-mail server through an ISP or a network.

## Synchronizing E-Mail Messages

You can synchronize e-mail messages along with the rest of your data if you enable Inbox synchronization in ActiveSync. For information on enabling Inbox synchronization, see ActiveSync Help on your computer.



**NOTE:** You can also synchronize e-mail messages with your computer from a remote location. For more information, see "Getting Connected" on page 105.

During synchronization:

- Messages are copied from the e-mail folders of Exchange or Outlook on your computer to the **ActiveSync** folder in Inbox on your device. By default, you receive:
  - Messages from the past 3 days
  - The first 100 lines of each message
  - File attachments of less than 100 KB in size
- E-mail messages in the **Outbox** folder on your device are transferred to Exchange or Outlook on your computer, and then sent from those programs.
- E-mail messages in subfolders on your computer must be selected in ActiveSync to be transferred.

## Connecting Directly to an E-Mail Server

In addition to synchronizing e-mail messages with your computer, you can send and receive e-mail messages by connecting to an e-mail server using a modem or network card connected to your device. You need to set up a remote connection to a network or an ISP, and a connection to your e-mail server. For more information, see "Getting Connected" on page 105.

When you connect to the e-mail server:

- New messages are downloaded to the device **Inbox** folder.
- Messages in the device **Outbox** folder are sent.
- Messages that have been deleted on the e-mail server are removed from the device **Inbox** folder.

Messages that you receive directly from an e-mail server are linked to your e-mail server rather than to your computer. When you delete a message on your device, it is also deleted from the e-mail server the next time you connect depending on the settings you selected in ActiveSync.

When you are working online, you read and respond to messages while connected to the e-mail server. Messages are sent as soon as you tap **Send**, which saves space on your device.

After you have downloaded new message headers or partial messages, you can disconnect from the e-mail server and then decide which messages to download completely. The next time you connect, Inbox downloads the messages you have marked for retrieval and sends the messages you have composed.

## Using the Message List

Messages you receive are displayed in the message list. By default, the most recently received messages are displayed first in the list.

When you receive a message, tap to open it. Unread messages are displayed in bold.

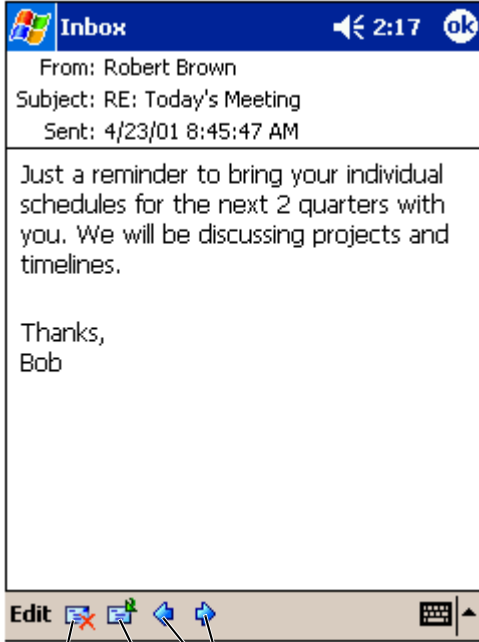

delete icon  
forward icon  
previous/next message

**When you connect to your e-mail server or synchronize with your computer, you receive by default:**

- Messages from the last 5 days
- The first 100 lines of each new message
- File attachments of less than 100 KB in size



The original messages remain on the e-mail server or your computer. You can mark the messages that you want to retrieve in full during your next synchronization or e-mail server connection. In the message list, tap and hold the message that you want to retrieve. On the pop-up menu, tap **Mark for Download**. The icons in the Inbox message list indicate message status.

You specify your downloading preferences when you set up the service or select your synchronization options. You can change the settings at any time:

- Change options for Inbox synchronization using ActiveSync options. For more information, see ActiveSync Help on your computer.
- Change options for direct e-mail server connections in Inbox on your device. Tap **Tools** and tap **Options**. On the **Service** tab, tap the service that you want to change. Tap and hold the service and select **Delete** to remove a service.

## Composing Messages

To compose a message:

- 1 Tap the **Start** button and tap **Inbox**.
- 2 Tap **New**.

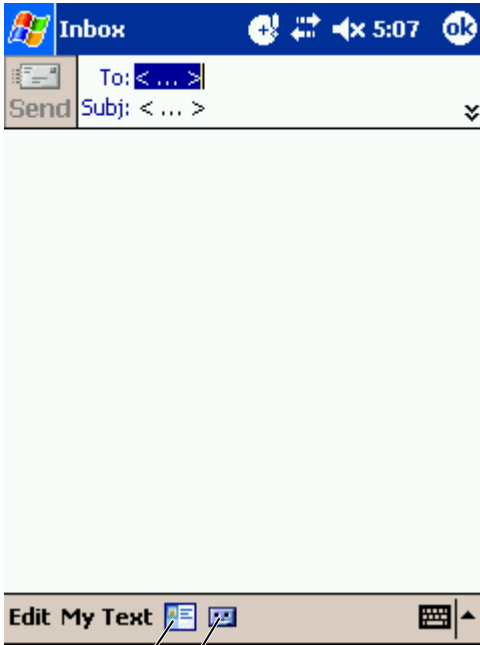

Contacts icon

record icon

- 3 In the **To** field, enter an e-mail of one or more recipients, separating them with a semicolon. Or tap the **Contacts** icon to select names from the contact list.**



**NOTE:** All e-mail addresses entered in the e-mail fields in **Contacts** appear in the **Address Book**.

- 4 Compose your message. To enter preset or frequently used messages, tap **My Text** and select a message.**

- 5 Tap **Send** when you have finished the message.

If you are working offline, the message is moved to the **Outbox** folder and sent the next time you connect.

## Managing E-Mail Messages and Folders

By default, messages are displayed in one of five folders for each service you have created: **Inbox**, **Deleted Items**, **Drafts**, **Outbox**, or **Sent Items**. The **Deleted Items** folder contains messages that have been deleted on the device. The behavior of the **Deleted Items** and **Sent Items** folders depends on the options you have selected. To change the options, tap **Tools** in the message list and tap **Options**. On the **Message** tab, select your options.

To create a new folder, tap **Tools**, and tap **Manage Folders**. To move a message to another folder, tap and hold the message in the message list and tap **Move to** on the pop-up menu.

### Folder Behavior With a Direct Connection to an E-Mail Server

The behavior of the folders you create depends on whether you use ActiveSync, POP3, or IMAP4.

- *If you use ActiveSync*, e-mail messages in the **Inbox** folder in Outlook are automatically synchronized with your device. You can select to synchronize additional folders by designating them for ActiveSync. The folders you create and the messages you move are then mirrored on the server. For example, if you move messages from the **Inbox** folder to a folder named **Family**, and you have designated **Family** for synchronization, the server creates a copy of the **Family** folder and copies the messages into that folder. You can then read the messages while away from your computer.

- *If you use POP3 and you move e-mail messages to a folder you created, the link is broken between the messages on the device and their copies on the e-mail server. The next time you connect, the e-mail server detects that the messages are missing from the device Inbox and deletes them from the server. This prevents you from having duplicate copies of a message. However, you no longer have access to messages that you move to folders created from anywhere except the device.*
- *If you use IMAP4, the folders you create and the e-mail messages you move are mirrored on the server. Therefore, messages are available to you any time you connect to your e-mail server, whether it is from your device or computer. This synchronization of folders occurs whenever you connect to the server, create new folders, or rename/delete folders when connected.*

## Notifications

You can set your device to remind you when you have something to do. For example, if you have set up an appointment in Calendar, a task with a due date in Tasks, or an alarm in Clock, you are notified in one of the following ways:

- A message box appears on the screen.
- A sound, which you can specify, is played.
- A light flashes on your device.

To configure the reminders and sounds for your device:

- 1 Tap the **Start** button and tap **Settings**.
- 2 On the **Personal** tab, tap **Sounds & Notifications**.
  - **Volume** tab — Adjust the volume and enable sounds.
  - **Notifications** tab — Set notifications for specific events.

# 7

## SECTION 7

# Adding and Removing Programs

---

Adding Programs Using Microsoft® ActiveSync®

Downloading Programs From the Internet

Adding a Program to the Start Menu

Removing Programs

Programs that were already installed when you received your device are stored in ROM. You cannot remove these programs, and you never accidentally lose ROM contents. ROM programs can be updated using installation programs with the \*.xip extension. You can save data to either ROM or RAM.

You can install any program created for your device as long as your device has sufficient memory. The most popular place to find software for your device is on the Microsoft Pocket PC website:

[www.microsoft.com/mobile/pocketpc](http://www.microsoft.com/mobile/pocketpc).

## Adding Programs Using Microsoft® ActiveSync®

You need to install the appropriate software for your device on your computer before installing software on your device. See "Using Microsoft® ActiveSync®" on page 57 for more information.

- 1 Determine your device and processor type so that you know which version of the software to install:
  - a Tap the **Start** button and tap **Settings**.
  - b On the **System** tab, tap **About**.
  - c From the **Version** tab, record the processor information.
- 2 Download the software to your computer (or insert the CD or floppy disk that contains the software into your computer). You may see a single \*.xip, \*.exe, or \*.zip file, a **Setup.exe** file, or several versions of files for different device types and processors. Ensure that you select the program designed for the Pocket PC and your device processor type.
- 3 Read any installation instructions, readme files, or documentation that comes with the program. Many programs provide special installation instructions.
- 4 Connect your device to your computer.

## 5 Double-click the \*.exe file.

If the file is an installer file, the installation wizard begins. Follow the directions on the screen. Once the software has been installed on your computer, the installer automatically transfers the software to your device.

If the file is not an installer file, you receive an error message stating that the program is valid but that it is designed for a different type of computer. You need to move this file to your device. If you cannot find any installation instructions for the program in the readme file or documentation, use ActiveSync Explore to copy the program file to the **Program Files** folder on your device. For more information on copying files using ActiveSync, see ActiveSync Help on your computer.

To open a program after the installation is complete, tap the **Start** button, tap **Programs**, and then tap the program icon.

# Downloading Programs From the Internet

- 1 Determine your device and processor type so that you know which version of the software to install:
  - a Tap the **Start** button and tap **Settings**.
  - b On the **System** tab, tap **About**.
  - c From the **Version** tab, record the processor information.
- 2 Using Pocket Internet Explorer, download the program to your device. You may see a single \*.xip, \*.exe or \*.zip file, a **Setup.exe** file, or several versions of files for different device types and processors. Ensure that you select the program designed for the Pocket PC and your device processor type.
- 3 Read any installation instructions, readme files, or documentation that comes with the program. Many programs provide special installation instructions.

- 4 Tap the file, such as a **\*.xip** or **\*.exe** file.

The installation wizard begins. Follow the directions on the screen.

## Adding a Program to the Start Menu

- 1 Tap the **Start** button and tap **Settings**.
- 2 Tap **Menus**, tap the **Start Menu** tab, and then tap the check box for the program.

If the program is not listed, you can either use File Explorer on the device to move the program to the **Start Menu** folder, or use ActiveSync on the computer to create a shortcut to the program and place the shortcut in the **Start Menu** folder.

### Using File Explorer on the Device

- 1 Tap the **Start** button, tap **Programs**, and tap **File Explorer**.
- 2 Locate the program. Tap the folder list (labeled **My Documents** by default) and then tap **My Device** to see a list of all folders on the device.
- 3 Tap and hold the program name and tap **Cut** on the pop-up menu.
- 4 Open the **Start Menu** folder located in the Windows<sup>®</sup> folder.
- 5 Tap and hold a blank area of the window, and tap **Paste** on the pop-up menu.

The program now appears on the **Start** menu. For more information on using File Explorer, see "Finding and Organizing Information" on page 36.

### Using ActiveSync on the Computer

Use Explorer in ActiveSync to explore your device files and locate the program. Right-click the program and click **Create Shortcut**. Move the shortcut to the **Start Menu** folder in the Windows folder. The shortcut now appears on the **Start** menu. For more information, see ActiveSync Help on your computer.



# Removing Programs

- 1 Tap the **Start** button and tap **Settings**.
- 2 Tap the **System** tab and tap **Remove Programs**.  
If the program does not appear in the list of installed programs, use File Explorer on your device to locate the program.
- 3 Tap and hold the name of the program, and tap **Delete** on the pop-up menu.



# 8

## SECTION 8

# Using Companion Programs

---

Microsoft Pocket Word

Pocket Excel

MSN Messenger

Windows<sup>®</sup> Media Player for Pocket PC

Microsoft Reader

The companion programs include Microsoft® Pocket Word, Microsoft Pocket Excel, Microsoft Money, Windows Media Player for Pocket PC, and Microsoft Reader.

To switch to a companion program on your device, tap the **Start** button, tap **Programs**, and then tap the program name.

## Microsoft Pocket Word

Pocket Word works with Microsoft Word on your computer to give you easy access to copies of your documents. You can create new documents on your device, or you can copy documents from your computer to your device. Synchronize documents between your computer and your device so that you have the most up-to-date content in both locations.

Use Pocket Word to create documents, such as letters, meeting minutes, and travel reports. To create a new file:

- 1 Tap the **Start** button→ **Programs**→ **Pocket Word**.
- 2 Tap **New**.

A blank document appears. Or, if you selected a template for new documents in the **Options** dialog box, the template appears with appropriate text and formatting already provided.

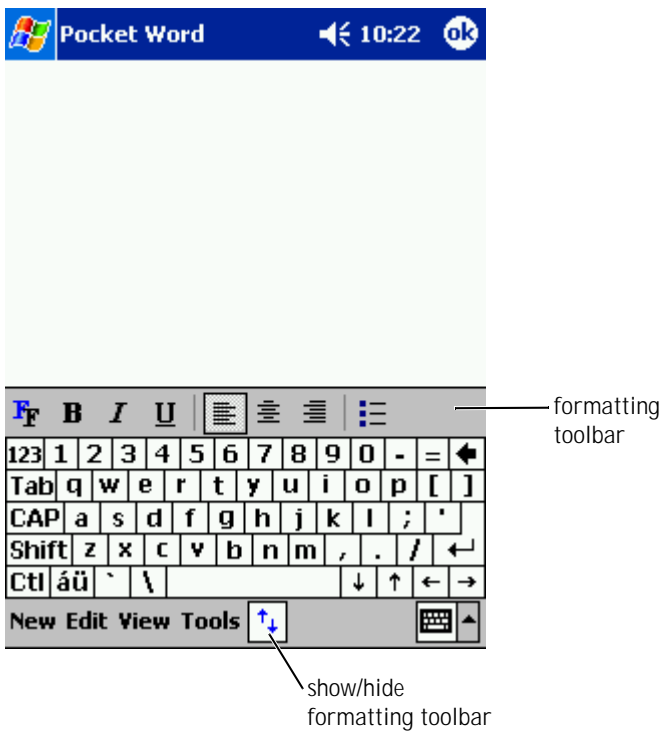

You can open only one document at a time. If you open a second document, you are asked to save the first one. You can create, save, or edit a document in a variety of formats, including Word (.doc), Pocket Word (.psw), Rich Text Format (.rtf), and Plain Text (.txt).

Pocket Word contains a list of the files stored on your device. Tap a file in the list to open it. To delete, make copies of, or send files, tap and hold a file in the list. Then select the appropriate action in the pop-up menu.

You can enter information in Pocket Word in one of four modes: typing, writing, drawing, or recording. These modes are displayed on the **View** menu. Each mode has its own toolbar, which you can show and hide by tapping the **Show/Hide Toolbar** icon on the command bar.

To change the zoom magnification, tap **View**, tap **Zoom**, and then select the percentage that you want. Select a higher percentage to enter text and a lower percentage to see more of your document.

If you are opening a Word document created on a computer, select **Wrap to Window** on the **View** menu so that you can see the entire document.

## Pocket Excel

Pocket Excel works with Microsoft Excel on your computer to give you easy access to copies of your workbooks. You can create new workbooks on your device, or you can copy workbooks from your computer to your device. Synchronize workbooks between your computer and your device so that you have the most up-to-date content in both locations.

Use Pocket Excel to create workbooks, such as expense reports and mileage logs. To create a new file:

- 1 Tap the **Start** button→ **Programs**→ **Pocket Excel**.
- 2 Tap **New**.

A blank workbook appears. Or, if you selected a template for new workbooks in the **Options** dialog box, the template appears with appropriate text and formatting already provided.

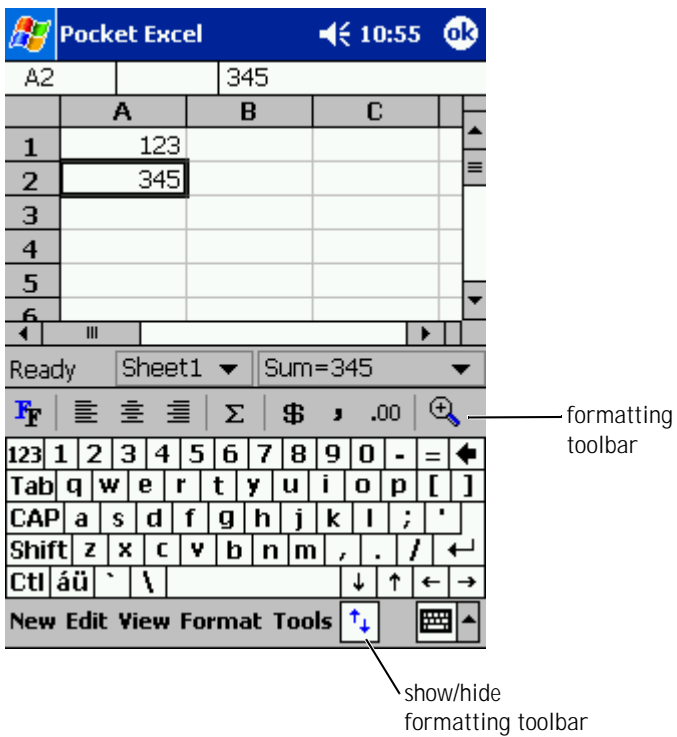

You can open only one workbook at a time. If you open a second workbook, you are asked to save the first one. You can create, save, or edit a workbook in a variety of formats, including Pocket Excel (.pxl) and Excel (.xls).

Pocket Excel contains a list of the files stored on your device. Tap a file in the list to open it. To delete, make copies of, or send files, tap and hold a file in the list. Then select the appropriate action from the pop-up menu.

Pocket Excel provides fundamental spreadsheet tools, such as formulas, functions, sorting, and filtering. To display the toolbar, tap **View** and tap **Toolbar**.

If your workbook contains sensitive information, you can protect it with a password. To set a password, open the workbook, tap **Edit**, and then tap **Password**. Every time you open the workbook, you need to enter the password, so choose one that is easy for you to remember but difficult for others to guess.

## Tips for Working in Pocket Excel

Use the following tips when working in large worksheets in Pocket Excel:

- Tap **View** and tap **Full Screen** to see as much of your worksheet as possible. To exit full-screen mode, tap **Restore**.
- Show and hide window elements. Tap **View** and then tap the elements that you want to show or hide.
- Freeze panes on a worksheet. First select the cell where you want to freeze panes. Tap **View** and tap **Freeze Panes**. You might want to freeze the top and leftmost panes in a worksheet to keep row and column labels visible as you scroll through a sheet.
- Split panes to view different areas of a large worksheet. Tap **View** and tap **Split**. Drag the split bar to where you want it. To remove the split, tap **View** and tap **Remove Split**.
- Show and hide rows and columns. To hide a row or column, select a cell in the row or column you want to hide. Tap **Format**, tap **Row or Column**, and then tap **Hide**. To show a hidden row or column, tap **Tools**, tap **Go To**, and then type a reference that is in the hidden row or column. Then tap **Format**, tap **Row or Column**, and then tap **Unhide**.

For more information on using Pocket Excel, tap the **Start** button and tap **Help**.



# MSN Messenger

With the MSN Messenger instant message program, you can:

- See who is online.
- Send and receive instant messages.
- Have instant message conversations with groups of contacts.

To use MSN Messenger, you must have a Microsoft Passport account or a Microsoft Exchange e-mail account. You must have a Passport to use MSN Messenger Service. If you have a Hotmail or MSN account, you already have a Passport. Once you have obtained either a Microsoft Passport or a Microsoft Exchange account, you are ready to set up your account.



**NOTE:** Sign up for a Microsoft Passport account at [www.passport.com](http://www.passport.com). Get a free Microsoft Hotmail e-mail address at [www.hotmail.com](http://www.hotmail.com).

To switch to MSN Messenger, tap the **Start** button→ **Programs**→ **MSN Messenger**.

## Setting Up

Before you can connect, you must enter Passport or Exchange account information.

To set up an account and sign in:

- 1 Tap the **Start** button→ **Programs**→ **MSN Messenger**
- 2 Tap **Tools** and tap **Options**.
- 3 On the **Accounts** tab, enter your Passport or Exchange account information.
- 4 To sign in, tap the sign-in screen and enter your e-mail address and password.

## Working With Contacts

The MSN Messenger window shows all of your messenger contacts at a glance, divided into **Online** and **Not Online** categories. From this view, while connected, you can chat, send an e-mail, block the contact from chatting with you, or delete contacts from your list using the pop-up menu.



**NOTE:** If you already use MSN Messenger on your computer, your contacts show up on your device without having to be added.

To see others online without them seeing you, tap **Tools**→ **My Status**→ **Appear Offline**.

If you block a contact, you appear offline but remain on the blocked contact's list. To unblock a contact, tap and hold the contact, and then tap **Unblock** on the pop-up menu.

## Chatting With Contacts

- Tap a contact name to open a chat window. Enter your message in the text entry area at the bottom of the screen or tap **My Text** to enter a preset message, and then tap **Send**.
- To invite another contact to a multiuser chat, tap **Tools**, tap **Invite**, and then tap the contact you want to invite.
- To switch back to the main window without closing a chat, tap the **Contacts** icon. To revert back to your chat window, tap **Chats**, and select the person with whom you were chatting.
- To know if the contact you are chatting with is responding, look for the message under the text entry area.

For more information on using MSN Messenger, tap the **Start** button and tap **Help**.

# Windows<sup>®</sup> Media Player for Pocket PC

Use Windows Media Player for Pocket PC to play digital audio and video files that are stored on your device or on a network. To switch to Media Player for Pocket PC, tap the **Start** button → **Programs** → **Windows Media**.

Use Windows Media Player on your computer to copy digital audio and video files to your Pocket PC. You can play Windows Media and MP3 files on your Pocket PC.

For more information about using Windows Media Player for Pocket PC, tap the **Start** button and tap **Help**.

## Microsoft Reader

Use Reader to read eBooks on your device. Download books to your computer from your favorite eBook website. Then use ActiveSync to copy the book files to your activated device. The books appear in the Reader Library. Tap the name of a book in the list to open it.

With Reader, you can:

- Page through the book by using the up/down control on your device or by tapping the page number on each page.
- Annotate the book with highlighting, bookmarks, notes, and drawings.
- Search for text and look up definitions for words.

The Guidebook contains all the information you need to use the software. To open the Guidebook, tap **Help** on the Reader command bar. Or, on a book page, tap and hold the book title, and then tap **Help** on the pop-up menu.

To switch to Microsoft Reader, tap the **Start** button → **Programs** → **Microsoft Reader**.

## Using the Library

The Library displays a list of all books stored on your device or storage card. To open the Library:

- On the Reader command bar, tap **Library**.
- On a book page, tap the book title, and then tap **Library** on the pop-up menu.



## Reading a Book

Each book consists of a cover page, an optional table of contents, and the pages of the book. Navigation options are listed at the bottom of the cover page.

The first time you open a book, you might want to go to the first page or to the table of contents, if available. Subsequently, whenever you open the book, you are automatically taken to the last page read.

In addition to text, each book page includes a page number and book title. You can also page through a book by using the up/down control on your device.

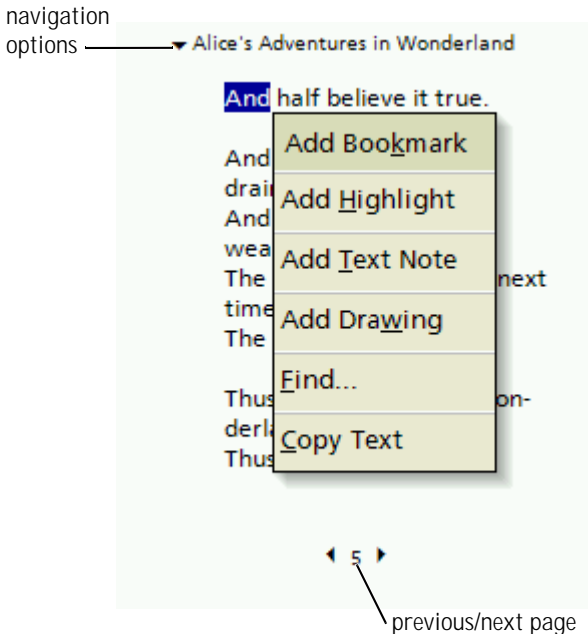

## Using Reader Features

Reading a book electronically gives you several options not available with paper books. The options are available from any book page.

Select text by dragging across the text on the page. Then tap an option on the pop-up menu:

- **Add Bookmark** — When you add a bookmark to a book, a color-coded bookmark icon appears in the right margin. You can add multiple bookmarks to a book. From anywhere in the book, tap the bookmark icon to go to the bookmarked page.
- **Add Highlight** — When you highlight text, it appears with a colored background.
- **Add Text Note** — When you attach a note to text, you enter the text in a note pad that appears on top of the book page. A note icon displays in the left margin. To show or hide the note, tap the icon.
- **Add Drawing** — When you add a drawing, a drawing icon appears on the page. Draw by dragging your stylus.
- **Find** — Tap **Find** on the pop-up menu to find text in a book. Enter the word that you want to search for and tap a **Find** option. Reader highlights text found on the page. To close Find, tap outside the box. To return to your original page, tap the title and tap **Return** on the pop-up menu.
- **Copy Text** — You can copy text from books that support this feature into any program that accepts text. On a book page, select the text you want to copy. Then tap **Copy Text** on the pop-up menu. The text can be pasted into the program of your choice.
- To see a list of a book's annotations, including bookmarks, highlights, text notes, and drawings, tap **Annotations** in the navigation menu. You can tap an entry in the list to go to the annotated page.

## Removing a Book

When you finish reading a book, you can delete it to conserve space on your device. If a copy of the book is stored on your computer, you can download it again at any time.

To remove a book from your device, tap and hold the title in the **Library** list, and tap **Delete** on the pop-up menu.





# 9

## SECTION 9

# Using Microsoft<sup>®</sup> Pocket Internet Explorer

---

Mobile Favorites

Using AvantGo Channels

Browsing Mobile Favorites and the Web

Use Pocket Internet Explorer to view Web or WAP pages:

- During synchronization with your computer, download your favorite links and mobile favorites that are stored in the **Mobile Favorites** subfolder in Internet Explorer on your computer.
- Connect to an Internet service provider (ISP) or network and browse the Web. For more information on connecting to the Internet, see "Getting Connected" on page 105.

When the device is connected to an ISP or network, you can also download files and programs from the Internet or intranet.

To switch to Pocket Internet Explorer, tap the **Start** button and tap **Internet Explorer**.

## Mobile Favorites

If you are using Microsoft Internet Explorer 5.0 or later on your computer, you can download mobile favorites to your device. Synchronizing mobile favorites downloads Web content to your device so that you can view pages while you are disconnected from your ISP and computer. Use the Internet Explorer plug-in installed with Microsoft ActiveSync® to create mobile favorites quickly.

To create a mobile favorite on your computer and download it to your device:

- 1 On your computer, open Internet Explorer and click **Tools**→ **Create Mobile Favorite**.
- 2 To change the link name, enter a new name in the **Name** box.
- 3 Specify an update schedule next to **Update** (optional).
- 4 Click **OK**.

Internet Explorer downloads the latest version of the page to your computer.

- 5 In Internet Explorer on the computer, right-click the mobile favorite and click **Properties**.
- 6 On the **Download** tab, specify the number of levels deep you want to download. To conserve device memory, go only one level deep.
- 7 Synchronize your device and computer.

Mobile favorites that are stored in the **Mobile Favorites** folder in Internet Explorer are downloaded to your device.

If you did not specify an update schedule in step 3, you need to manually download content to keep the information updated on your computer and device. Before synchronizing with your device, click **Tools** in Internet Explorer on your computer and click **Synchronize**. The date in the **Last Updated** column was the last time content was downloaded to the computer. You can manually download content, if necessary.



**NOTE:** You can add an icon to the Internet Explorer toolbar for creating mobile favorites. In Internet Explorer on your computer, click **View**→**Toolbars**, and then click **Customize**.

## Conserving Memory

Mobile favorites take up storage memory on your device. To minimize the amount of memory used:

- Turn off pictures and sounds or stop some mobile favorites from being downloaded to the device in the **Favorites** settings in the ActiveSync options. For more information, see ActiveSync Help on your computer.
- Limit the number of downloaded linked pages. In Internet Explorer on the computer, right-click the mobile favorite you want to change and click **Properties**. On the **Download** tab, specify **0** or **1** for the number of linked pages you want to download.

## Mobile Favorites Folder

Only items stored in the **Mobile Favorites** subfolder (in the **Favorites** folder) in Internet Explorer on your computer are synchronized with your device. The folder was created automatically when you installed ActiveSync.

## Favorite Links

During synchronization, the list of favorites in the **Mobile Favorites** folder on your computer is synchronized with Pocket Internet Explorer on your device. The computer and the device are updated with changes made to either list each time you synchronize. Unless you mark the favorite link as a mobile favorite, only the link is downloaded to your device—you need to connect to your ISP or network to view the content. For more information on synchronization, see ActiveSync Help on your computer.

# Using AvantGo Channels

AvantGo is a free interactive service that gives you access to personalized content and thousands of popular websites. You subscribe to AvantGo channels directly from your device. Then synchronize your device and computer, or connect to the Internet to download the content. For more information, see the AvantGo website.

To sign up for AvantGo:

- 1 In ActiveSync options on your computer, turn on synchronization for the **AvantGo** information type.
- 2 In Pocket Internet Explorer on your device, tap **Favorites** to display your list of favorites.
- 3 Tap the **AvantGo Channels** link.
- 4 Tap **Activate**.

- 5 Follow the directions on the screen.

You need to synchronize your device with your computer and then tap the **My Channels** to complete the AvantGo setup.

When synchronization is complete, tap the **AvantGo Channels** link in your list of favorites to see a few of the most popular channels. To add or remove channels, tap the **Add or Remove** link.

## Browsing Mobile Favorites and the Web

You can use Pocket Internet Explorer to browse mobile favorites and channels that you have downloaded to your device without connecting to the Internet. You can also connect to the Internet through an ISP or a network connection and browse the Web.

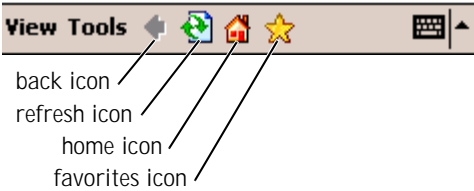
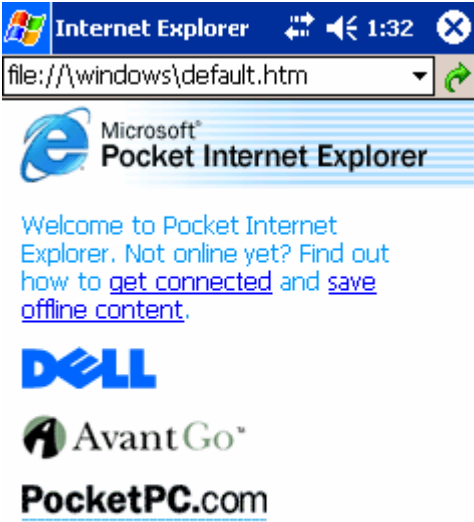

To view mobile favorites and channels:

- 1 Tap the favorites icon to display your list of favorites.
- 2 Tap the page you want to view.

The page that was downloaded the last time you synchronized with your computer appears. If the page is not on your device, the favorite is dimmed. You need to synchronize with your computer again to download the page to your device, or connect to the Internet to view the page.

To browse the Internet, set up a connection to your ISP or corporate network using **Connections**, as described in "Getting Connected" on page 105.



**NOTE:** To add a favorite link, go to the page that you want to add, tap and hold the page, and then tap **Add to Favorites**.

To connect and browse the Internet:

- Tap the favorites icon and tap the favorite you want to view.
- Tap **View** and tap **Address Bar**. In the address bar that appears at the top of the screen, enter the Web address that you want to see and tap **Go**. Tap the arrow to select previously entered addresses.





# 10

## SECTION 10

# Getting Connected

---

Using Infrared

Creating a Modem Connection

Creating an Ethernet Connection

Creating a VPN Connection

Ending a Connection

Connecting Directly to an E-Mail Server

Getting Help on Connecting

You can use your device to exchange information with other mobile devices or with a computer, a network, or the Internet. You can use any of the following connection options:

- Use the infrared (IR) port on your device to send and receive files between two devices. See the following section, "Using Infrared," for more information.
- Connect to your Internet service provider (ISP). Once you are connected, you can send and receive e-mail messages by using Inbox, and view Web or WAP pages by using Microsoft® Pocket Internet Explorer. The communication software for creating an ISP connection is already installed on your device. Your service provider provides software needed to install other services, such as paging and fax services.
- Connect to the network at your company or organization where you work. Once you are connected, you can send and receive e-mail messages by using Inbox, view Web or WAP pages by using Pocket Internet Explorer, and synchronize with your computer.
- Connect to your computer to synchronize remotely. Once you are connected, you can synchronize information such as your Pocket Outlook information. See Microsoft ActiveSync® Help on your computer or Connections Help on the device for more information.

## Using Infrared

Using infrared, you can send and receive information, such as contacts and appointments, between two devices.

To send information:

- 1 Switch to the program where you created the item you want to send and locate the item in the list.
- 2 Align the infrared sensors so that they are unobstructed and within a close range.
- 3 Tap and hold the item, and tap **Beam Item** on the pop-up menu.

You can also send items (excluding folders) from File Explorer. Tap and hold the item you want to send, and tap **Beam File** on the pop-up menu.

## Creating a Modem Connection

1 Obtain the following information from your ISP:

- ISP dial-up access telephone number
- Username and password
- TCP/IP settings

Some ISPs require information in front of the username, such as *MSN/username*.

- 2 Install a modem card, or use a null modem cable and appropriate adapters to connect an external modem to your device through the serial port.
- 3 Tap the **Start** button → **Settings** → **Connections** tab → **Connections**.
- 4 Under **My ISP** or **My Work Network**, tap **Add a new modem connection**.
- 5 Enter a name for the connection, such as *ISP Connection*.
- 6 From the **Select a modem** list, select your modem type, and tap **Next**.

If your modem type does not appear, try reinserting the modem card. If you are using an external modem that is connected to your device with a cable, select **Hayes Compatible on COM1**.

- 7 Enter the access phone number and tap **Next**.
- 8 Enter your user name, password, and, if applicable, your domain.



**NOTE:** You should not need to change any settings in **Advanced**. Most ISPs now use a dynamically assigned address.

- 9 If the ISP you are connecting to does not use a dynamically assigned address, tap **Advanced**, tap the **TCP/IP** tab, and then enter the address.

- 10 Tap **Next**.
- 11 Select other appropriate options and tap **Finish**.

When you open Inbox, Pocket Internet Explorer, or MSN Messenger, your device automatically connects. Once you are connected, you can:

- Send and receive e-mail messages using Inbox. Before you can use Inbox, you need to provide the information Inbox needs to communicate with the e-mail server. See "Connecting Directly to an E-Mail Server" on page 111 for more information.
- See Web and WAP pages using Pocket Internet Explorer. For more information, see "Using Microsoft<sup>®</sup> Pocket Internet Explorer" on page 97.
- Send and receive instant messages with MSN Messenger. For more information, see "MSN Messenger" on page 89.

## Creating an Ethernet Connection

- 1 Install the network card driver, if required.  
See the documentation that came with your network card.
- 2 Insert the network card into your device.
  - If a network with a broadcast SSID is detected, the wireless network icon, , and the **New Network Detected** bubble appear in the navigation bar. Go to step 3.
  - If a network with a broadcast SSID is not detected, skip to step 4.
- 3 Tap **The Internet** or **Work**, depending to which type of network you are connecting. Your device automatically connects to the network.



**NOTE:** If multiple networks are detected, tap the network to which you want to connect, tap **The Internet** or **Work**, and tap **Connect**.

- 4 Tap the **Start** button → **Settings** → **Connections** tab → **Connections**.

- 5 Tap the **Wireless Ethernet** icon.
- 6 On the **Wireless** tab, tap **New Settings**.
- 7 Enter the SSID next to **Network Name**, and select whether the network connects to the Internet or work.
- 8 Tap the **Authentication** tab to enable or disable WEP settings, depending on your network type.
- 9 Tap **OK**.

When your device successfully connects to the network, your connection status appears under **Wireless Networks**.

## Creating a VPN Connection

- 1 Tap the **Start** button→ **Settings**→ **Connections** tab→ **Connections**.
- 2 Tap **Add a new VPN server connection**.
- 3 Enter a name for the connection, such as your company's name.
- 4 In the **Host name/IP** field, enter the VPN server name or IP address.
- 5 Next to **VPN type**, tap **IPSec** or **PPTP**, depending on the type of authentication that you want to use with your device.

If you are unsure about which option to select, ask your network administrator.

- 6 Tap **Next**.
- 7 Enter your username, password, and, if required, domain.
- 8 Install the network card driver, if required.  
See the documentation that came with your network card.
- 9 Insert the network card into your device.
  - If a network with a broadcast SSID is detected, the wireless network icon, , and the **New Network Detected** bubble appear in the navigation bar. Go to step 10.

- If a network with a broadcast SSID is not detected, skip to step 11.

## 10 Tap **The Internet**.

 **NOTE:** If multiple networks are detected, tap the network to which you want to connect, tap **The Internet**, and tap **Connect**.

## 11 Tap the **Start** button → **Settings** → **Connections** tab → **Connections**.

## 12 Tap the **Wireless Ethernet** icon.

## 13 On the **Wireless** tab, tap **New Settings**.

## 14 Enter the SSID next to **Network Name**, and tap **The Internet**.

## 15 Tap the **Authentication** tab to enable or disable WEP settings, depending on your network type.

## 16 Tap **OK**.

## 17 Tap the connection icon, , that appears in the navigation bar.

## 18 Tap the name of your VPN connection to enable it.

# Ending a Connection

To disconnect:

- When connected through dial-up or VPN, tap the **Connection** icon on your navigation bar and tap **End**.
- When connected through a cable or cradle, detach your device from the cable or cradle.
- When connected through the infrared sensor, move the device away from the computer.
- When connected through a network (Ethernet) card, remove the card from your device.

# Connecting Directly to an E-Mail Server

You can set up a connection to an e-mail server so that you can send and receive e-mail messages by using a modem or network connection and **Inbox** on your device.



**NOTE:** The ISP or network must use a POP3 or IMAP4 e-mail server and an SMTP gateway.

You can use multiple e-mail services to receive your messages. For each e-mail service you intend to use, you must first set up and name the e-mail service. If you use the same service to connect to different mailboxes, set up and name each mailbox connection.

To set up an e-mail service:

- 1 In **Inbox** on your device, tap **Accounts** and tap **New Account**.
- 2 Follow the directions in the E-mail Setup wizard.

For more information, tap the **Start** button and tap **Help**.

To connect to your e-mail server, tap **Services** and tap **Connect**. For more information on using the **Inbox** program, see "Inbox" on page 70.

## Getting Help on Connecting

For more information on getting connected, see the following resources:

- "Inbox" on page 70.
- Online Help on the device. Tap the **Start** button and tap **Help**. Tap **View**, tap **All Installed Help**, and then tap **Inbox** or **Connections**.
- ActiveSync Help on your computer. In ActiveSync, click **Help** and click **Microsoft ActiveSync Help**.
- See [www.microsoft.com/mobile/pocketpc](http://www.microsoft.com/mobile/pocketpc) for troubleshooting information.





SECTION 11

## Appendix

Specifications  
Regulatory Notices  
Contacting Dell

# Specifications

---

## System Information

---

Processor	Intel® XScale™ processor at 400 or 300 MHz
Memory	
RAM	64- or 32-MB SDRAM
ROM	48- or 32-MB Intel® StrataFlash™ ROM
Operating System	Microsoft® Pocket PC 2003 Premium

---

## Display

---

Type	TFT Color 16-bit, touch-sensitive transreflective display
Size	3.5 inches
Resolution	240 x 320 at 65,536 colors

---

## Controls and Lights

---

Navigation	5-way navigation button
Scroll Dial	up, down, action
Buttons:	four program buttons: Calendar, Contacts, Inbox, Home power on/off voice record button reset button
Lights:	synchronization/communication event notification charge status

---

**Expansion Slots**

---

CompactFlash	one Type II CompactFlash card slot (3.3v)
Secure Digital	one Secure Digital card slot (3.3v)

---

**Ports and Connectors**

---

Infrared	standard v1.2 (115 kbps)
Power	DC power in
Cradle/synchronization connector	40-pin connector
Audio	stereo headphone connector

---

**Physical**

---

**Dimensions:**

Length	128 mm (5.04 inches)
Width	81.5 mm (3.21 inches)
Height	18 mm (0.71 inch)
Weight	196 g (0.43 lb)

---

**Audio**

---

Audio controller	AC-97 Codec chip; WM9705 sound chip
Stereo conversion	16-bit stereo; 8.0, 11.025, 22.05 and 44.1KHz sample rate
Record	full duplex record and playback
Microphone/speaker	integrated
Headphone	stereo connector

---

## Power Supply

---

### Battery type:

Main	1440-mAh Lithium-ion removable, rechargeable battery (standard) 3400-mAh Lithium-ion removable, rechargeable battery (optional)
Backup	CR2032 lithium battery

### AC adapter:

Supply voltage	100–240 VAC
Frequency	50–60 Hz
Current consumption	0.4 A
Output voltage	5.4 VDC
Output current	2.41 A

---

## Environmental

---

### Temperature range:

operating	0° to 40°C (32° to 104°F)
storage	–20° to 60°C (–4° to 140°F)

### Thermal gradient:

operating	15°C (59°F) per hour maximum
storage	20°C (68°F) per hour maximum

### Relative humidity (maximum):

operating	10% to 90% non-condensing
storage	5% to 95% non-condensing

### Altitude (maximum):

operating	0 to 3048 m (0 to 10,000 ft)
storage	0 to 12,190 m (0 to 40,000 ft)

---

**Environmental (continued)**

---

## Maximum shock:

operating	200 G
storage	400 G

## Maximum vibration:

operating	2.6 GRMS
storage	3.41 GRMS

## Regulatory Notices

Electromagnetic Interference (EMI) is any signal or emission, radiated in free space or conducted along power or signal leads, that endangers the functioning of a radio navigation or other safety service or seriously degrades, obstructs, or repeatedly interrupts a licensed radio communications service. Radio communications services include but are not limited to AM/FM commercial broadcast, television, cellular services, radar, air-traffic control, pager, and Personal Communication Services (PCS). These licensed services, along with unintentional radiators such as digital devices, including computers, contribute to the electromagnetic environment.

Electromagnetic Compatibility (EMC) is the ability of items of electronic equipment to function properly together in the electronic environment. While this computer has been designed and determined to be compliant with regulatory agency limits for EMI, there is no guarantee that interference will not occur in a particular installation. If this equipment does cause interference with radio communications services, which can be determined by turning the equipment off and on, you are encouraged to try to correct the interference by one or more of the following measures:

- Reorient the receiving antenna.
- Relocate the computer with respect to the receiver.
- Move the computer away from the receiver.

- Plug the computer into a different outlet so that the computer and the receiver are on different branch circuits.

If necessary, consult a Dell Technical Support representative or an experienced radio/television technician for additional suggestions.

Dell™ computers are designed, tested, and classified for their intended electromagnetic environment. These electromagnetic environment classifications generally refer to the following harmonized definitions:

- Class A is typically for business or industrial environments.
- Class B is typically for residential environments.

Information Technology Equipment (ITE), including devices, expansion cards, printers, input/output (I/O) devices, monitors, and so on, that are integrated into or connected to the computer should match the electromagnetic environment classification of the computer.

**A Notice About Shielded Signal Cables: Use only shielded cables for connecting devices to any Dell device to reduce the possibility of interference with radio communications services. Using shielded cables ensures that you maintain the appropriate EMC classification for the intended environment. For parallel printers, a cable is available from Dell. If you prefer, you can order a cable from Dell on the World Wide Web at [accessories.us.dell.com/sna/category.asp?category\\_id=4117](http://accessories.us.dell.com/sna/category.asp?category_id=4117).**

Most Dell computers are classified for Class B environments. However, the inclusion of certain options can change the rating of some configurations to Class A. To determine the electromagnetic classification for your computer or device, see the following sections specific for each regulatory agency. Each section provides country-specific EMC/EMI or product safety information.

## FCC Notices (U.S. Only)

Most Dell computers are classified by the Federal Communications Commission (FCC) as Class B digital devices. To determine which classification applies to your computer, examine all FCC registration labels located on the bottom, side, or back panel of your computer, on card-mounting brackets, and on the cards themselves. If any one of the labels carries a Class A rating, your entire computer is considered to be a Class A digital device. If *all* labels carry an FCC Class B rating as distinguished by either an FCC ID number or the FCC logo, (FCC), your computer is considered to be a Class B digital device.

Once you have determined your computer's FCC classification, read the appropriate FCC notice. Note that FCC regulations provide that changes or modifications not expressly approved by Dell could void your authority to operate this equipment.

This device complies with Part 15 of the FCC Rules. Operation is subject to the following two conditions:

- This device may not cause harmful interference.
- This device must accept any interference received, including interference that may cause undesired operation.

### Class A

This equipment has been tested and found to comply with the limits for a Class A digital device pursuant to Part 15 of the FCC Rules. These limits are designed to provide reasonable protection against harmful interference when the equipment is operated in a commercial environment. This equipment generates, uses, and can radiate radio frequency energy and, if not installed and used in accordance with the manufacturer's instruction manual, may cause harmful interference with radio communications.

Operation of this equipment in a residential area is likely to cause harmful interference, in which case you will be required to correct the interference at your own expense.

## Class B

This equipment has been tested and found to comply with the limits for a Class B digital device pursuant to Part 15 of the FCC Rules. These limits are designed to provide reasonable protection against harmful interference in a residential installation. This equipment generates, uses, and can radiate radio frequency energy and, if not installed and used in accordance with the manufacturer's instruction manual, may cause interference with radio communications. However, there is no guarantee that interference will not occur in a particular installation. If this equipment does cause harmful interference to radio or television reception, which can be determined by turning the equipment off and on, you are encouraged to try to correct the interference by one or more of the following measures:

- Reorient or relocate the receiving antenna.
- Increase the separation between the equipment and the receiver.
- Connect the equipment into an outlet on a circuit different from that to which the receiver is connected.
- Consult the dealer or an experienced radio/television technician for help.

## FCC Identification Information

The following information is provided on the device or devices covered in this document in compliance with FCC regulations:

- Model number: HC01U
- Company name:

Dell Computer Corporation  
One Dell Way  
Round Rock, Texas 78682 USA  
512-338-4400



## Fax Branding

The Telephone Consumer Protection Act of 1991 makes it unlawful for any person to use a computer or other electronic device, including fax machines, to send any message unless such message clearly contains in a margin at the top or bottom of each transmitted page or on the first page of the transmission, the date and time it is sent, identification of the business, other entity, or individual sending the message, and the telephone number of the sending machine or such business, other entity, or individual. The telephone number provided may not be a 900 number or any other number for which charges exceed local or long-distance transmission charges.

## IC Notice (Canada Only)

Most Dell computers (and other Dell digital apparatus) are classified by the Industry Canada (IC) Interference-Causing Equipment Standard #3 (ICES-003) as Class B digital devices. To determine which classification (Class A or B) applies to your computer (or other Dell digital apparatus), examine all registration labels located on the bottom, side, or the back panel of your computer (or other digital apparatus). A statement in the form of "IC Class A ICES-003" or "IC Class B ICES-003" will be located on one of these labels. Note that Industry Canada regulations provide that changes or modifications not expressly approved by Dell could void your authority to operate this equipment.

This Class B (or Class A, if so indicated on the registration label) digital apparatus meets the requirements of the Canadian Interference-Causing Equipment Regulations.

Cet appareil numérique de la Classe B (ou Classe A, si ainsi indiqué sur l'étiquette d'enregistrement) respecte toutes les exigences du Règlement sur le Matériel Brouilleur du Canada.

## CE Notice (European Union)

Marking by the symbol **CE** indicates compliance of this Dell computer to the EMC Directive and the Low Voltage Directive of the European Union. Such marking is indicative that this Dell system meets the following technical standards:

- EN 55022 — "Information Technology Equipment — Radio Disturbance Characteristics — Limits and Methods of Measurement."
- EN 55024 — "Information Technology Equipment - Immunity Characteristics - Limits and Methods of Measurement."
- EN 61000-3-2 — "Electromagnetic Compatibility (EMC) - Part 3: Limits - Section 2: Limits for Harmonic Current Emissions (Equipment Input Current Up to and Including 16 A Per Phase)."
- EN 61000-3-3 — "Electromagnetic Compatibility (EMC) - Part 3: Limits - Section 3: Limitation of Voltage Fluctuations and Flicker in Low-Voltage Supply Systems for Equipment With Rated Current Up to and Including 16 A."
- EN 60950 — "Safety of Information Technology Equipment."

**NOTE:** EN 55022 emissions requirements provide for two classifications:

- Class A is for typical commercial areas.
- Class B is for typical domestic areas.

This Dell device is classified for use in a typical Class B domestic environment.

A "Declaration of Conformity" in accordance with the preceding directives and standards has been made and is on file at Dell Computer Corporation Products Europe BV, Limerick, Ireland.

## CE Mark Notice

This equipment complies with the essential requirements of the European Union Directive 1999/5/EC.

Cet équipement est conforme aux principales caractéristiques définies dans la Directive européenne RTTE 1999/5/CE.

Die Geräte erfüllen die grundlegenden Anforderungen der RTTE-Richtlinie (1999/5/EG).

Questa apparecchiatura è conforme ai requisiti essenziali della Direttiva Europea R&TTE 1999/5/CE.

Este equipo cumple los requisitos principales de la Directiva 1999/5/CE de la UE, "Equipos de Terminales de Radio y Telecomunicaciones".

Este equipamento cumpre os requisitos essenciais da Directiva 1999/5/CE do Parlamento Europeu e do Conselho (Directiva RTT).

Ο εξοπλισμός αυτός πληροί τις βασικές απαιτήσεις της κοινοτικής οδηγίας EU R&TTE 1999/5/EK.

Deze apparatuur voldoet aan de noodzakelijke vereisten van EU-richtlijn betreffende radioapparatuur en telecommunicatie-eindapparatuur 1999/5/EG.

Dette udstyr opfylder de Væsentlige krav i EU's direktiv 1999/5/EC om Radio- og teleterminaludstyr.

Dette utstyr er i overensstemmelse med hovedkravene i R&TTE-direktivet (1999/5/EC) fra EU.

Utrustningen uppfyller kraven för EU-direktivet 1999/5/EC om ansluten teleutrustning och ömsesidigt erkännande av utrustningens överensstämmelse (R&TTE).

Tämä laite vastaa EU:n radio- ja telepäätealadirektiivin (EU R&TTE Directive 1999/5/EC) vaatimuksia.

## EN 55022 Compliance (Czech Republic Only)

This device belongs to Class B devices as described in EN 55022, unless it is specifically stated that it is a Class A device on the specification label. The following applies to devices in Class A of EN 55022 (radius of protection up to 30 meters). The user of the device is obliged to take all steps necessary to remove sources of interference to telecommunication or other devices.

Pokud není na typovém štítku počítače uvedeno, že spadá do třídy A podle EN 55022, spadá automaticky do třídy B podle EN 55022. Pro zařízení zařazená do třídy A (ochranné pásmo 30m) podle EN 55022 platí následující. Dojde-li k rušení telekomunikačních nebo jiných zařízení, je uživatel povinen provést taková opatření, aby rušení odstranil.

## MIC Notice (Republic of Korea Only)

To determine which classification (Class A or B) applies to your computer (or other Dell digital device), examine the Republic of Korean Ministry of Information and Communications (MIC) registration labels located on your computer (or other Dell digital device). The MIC label may be located separately from the other regulatory marking applied to your product. Line two of the label identifies the emissions class for the product—"(A)" for Class A products or "(B)" for Class B products.

**NOTE:** MIC emissions requirements provide for two classifications:

- Class A devices are for business purposes.
- Class B devices are for nonbusiness purposes.

## Class A Device

기종별	사용자 안내문
A급 기기 (업무용 정보통신기기)	이 기기는 업무용으로 전자파적합등록을 한 기기이오니 판매자 또는 사용자는 이 점을 주의하시기 바라며 만약 잘못 판매 또는 구입하였을 때에는 가정용으로 교환하시기 바랍니다.

Please note that this device has been approved for business purposes with regard to electromagnetic interference. If you find that this device is not suitable for your use, you may exchange it for a nonbusiness-purpose device.

### *MIC Class A Regulatory Label*

If the regulatory label includes the following marking, your computer is a Class A product:



1. 기기의 명칭(모델명):
2. 인증번호:(A)
3. 인증받은 자의 상호:
4. 제조년월일:
5. 제조자/제조국가:

## Class B Device

기종별	사용자 안내문
B급 기기 (가정용 정보통신기기)	이 기기는 가정용으로 전자파적합등록을 한 기기로서 주거지역에서는 물론 모든 지역에서 사용할 수 있습니다.

Please note that this device has been approved for nonbusiness purposes and may be used in any environment, including residential areas.

***MIC Class B Regulatory Label***

If the regulatory label includes the following marking, your computer is a Class B product.

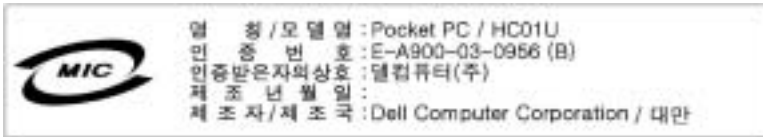

## NOM Information (Mexico Only)

The following information is provided on the device(s) described in this document in compliance with the requirements of the official Mexican standards (NOM):

<b>Exporter:</b>	Dell Computer Corporation One Dell Way Round Rock, TX 78682
<b>Importer:</b>	Dell Computer de México, S.A. de C.V. Paseo de la Reforma 2620 - 11° Piso Col. Lomas Altas 11950 México, D.F.
<b>Ship to:</b>	Dell Computer de México, S.A. de C.V. al Cuidado de Kuehne & Nagel de México S. de R.I. Avenida Soles No. 55 Col. Peñon de los Baños 15520 México, D.F.
<b>Model number:</b>	HC01U
<b>Supply voltage:</b>	100–240 VAC
<b>Frequency:</b>	50–60 Hz
<b>Current Consumption:</b>	0.4 A
<b>Output voltage:</b>	5.4 VDC
<b>Output current:</b>	2.41 A

# Contacting Dell

To contact Dell electronically, you can access the following websites:

- **www.dell.com**
- **support.dell.com** (technical support)
- **premiersupport.dell.com** (technical support for educational, government, healthcare, and medium/large business customers, including Premier, Platinum, and Gold customers)

For specific web addresses for your country, find the appropriate country section in the table below.

**NOTE:** Toll-free numbers are for use within the country for which they are listed.

When you need to contact Dell, use the electronic addresses, telephone numbers, and codes provided in the following table. If you need assistance in determining which codes to use, contact a local or an international operator.



<b>Country (City) International Access Code Country Code City Code</b>	<b>Department Name or Service Area, Website and E-Mail Address</b>	<b>Area Codes, Local Numbers, and Toll-Free Numbers</b>
<b>Australia (Sydney)</b>	E-mail (Australia): au_tech_support@dell.com	
International Access Code: <b>0011</b>	E-mail (New Zealand): nz_tech_support@dell.com	
Country Code: <b>61</b>	Home and Small Business	1-300-65-55-33
City Code: <b>2</b>	Government and Business	toll-free: 1-800-633- 559
	Preferred Accounts Division (PAD)	toll-free: 1-800-060- 889
	Customer Care	toll-free: 1-800-819- 339
	Corporate Sales	toll-free: 1-800-808- 385
	Transaction Sales	toll-free: 1-800-808- 312
	Fax	toll-free: 1-800-818- 341

<b>Country (City) International Access Code Country Code City Code</b>	<b>Department Name or Service Area, Website and E-Mail Address</b>	<b>Area Codes, Local Numbers, and Toll-Free Numbers</b>
<b>Austria (Vienna)</b>	Website: <b>support.euro.dell.com</b>	
International Access Code: <b>900</b>	E-mail: tech_support_central_europe@dell.com	
Country Code: <b>43</b>		
City Code: <b>1</b>	Home/Small Business Sales	0820 240 530 00
	Home/Small Business Fax	0820 240 530 49
	Home/Small Business Customer Care	0820 240 530 14
	Preferred Accounts/Corporate Customer Care	0820 240 530 16
	Home/Small Business Technical Support	0820 240 530 14
	Preferred Accounts/Corporate Technical Support	0660 8779
	Switchboard	0820 240 530 00
<b>Belgium (Brussels)</b>	Website: <b>support.euro.dell.com</b>	
International Access Code: <b>00</b>	E-mail: tech_be@dell.com	
Country Code: <b>32</b>	E-mail for French Speaking Customers:	
City Code: <b>2</b>	<b>support.euro.dell.com/be/fr/email dell/</b>	
	Technical Support	02 481 92 88
	Customer Care	02 481 91 19
	Corporate Sales	02 481 91 00
	Fax	02 481 92 99
	Switchboard	02 481 91 00

<b>Country (City) International Access Code Country Code City Code</b>	<b>Department Name or Service Area, Website and E-Mail Address</b>	<b>Area Codes, Local Numbers, and Toll-Free Numbers</b>
<b>Canada (North York, Ontario)</b>	Online Order Status: <b>www.dell.ca/ostatus</b>	
International Access Code: <b>011</b>	AutoTech (automated technical support)	toll-free: 1-800-247- 9362
	TechFax	toll-free: 1-800-950- 1329
	Customer Care (Home Sales/Small Business)	toll-free: 1-800-847- 4096
	Customer Care (med./large business, government)	toll-free: 1-800-326- 9463
	Technical Support (Home Sales/Small Business)	toll-free: 1-800-847- 4096
	Technical Support (med./large bus., government)	toll-free: 1-800-387- 5757
	Sales (Home Sales/Small Business)	toll-free: 1-800-387- 5752
	Sales (med./large bus., government)	toll-free: 1-800-387- 5755
	Spare Parts Sales & Extended Service Sales	1 866 440 3355
<b>Czech Republic (Prague)</b>	Website: <b>support.euro.dell.com</b> E-mail: <b>czech_dell@dell.com</b>	
International Access Code: <b>00</b>	Technical Support	02 2186 27 27
Country Code: <b>420</b>	Customer Care	02 2186 27 11
City Code: <b>2</b>	Fax	02 2186 27 14
	TechFax	02 2186 27 28
	Switchboard	02 2186 27 11

<b>Country (City) International Access Code Country Code City Code</b>	<b>Department Name or Service Area, Website and E-Mail Address</b>	<b>Area Codes, Local Numbers, and Toll-Free Numbers</b>
<b>Denmark (Copenhagen)</b>	Website: <b>support.euro.dell.com</b>	
International Access Code: <b>00</b>	E-mail Support (portable computers): den_nbk_support@dell.com	
Country Code: <b>45</b>	E-mail Support (desktop computers): den_support@dell.com	
	E-mail Support (servers): Nordic_server_support@dell.com	
	Technical Support	7023 0182
	Customer Care (Relational)	7023 0184
	Home/Small Business Customer Care	3287 5505
	Switchboard (Relational)	3287 1200
	Fax Switchboard (Relational)	3287 1201
	Switchboard (Home/Small Business)	3287 5000
	Fax Switchboard (Home/Small Business)	3287 5001

Country (City) International Access Code Country Code City Code	Department Name or Service Area, Website and E-Mail Address	Area Codes, Local Numbers, and Toll-Free Numbers
<b>Finland (Helsinki)</b>	Website: <b>support.euro.dell.com</b>	
International Access Code: <b>990</b>	E-mail: <b>fin_support@dell.com</b>	
Country Code: <b>358</b>	E-mail Support (servers): <b>Nordic_support@dell.com</b>	
City Code: <b>9</b>	Technical Support	<b>09 253 313 60</b>
	Technical Support Fax	<b>09 253 313 81</b>
	Relational Customer Care	<b>09 253 313 38</b>
	Home/Small Business Customer Care	<b>09 693 791 94</b>
	Fax	<b>09 253 313 99</b>
	Switchboard	<b>09 253 313 00</b>

<b>Country (City) International Access Code Country Code City Code</b>	<b>Department Name or Service Area, Website and E-Mail Address</b>	<b>Area Codes, Local Numbers, and Toll-Free Numbers</b>
<b>France (Paris) (Montpellier)</b>	Website: <b>support.euro.dell.com</b>	
International Access Code: <b>00</b>	E-mail: <b>support.euro.dell.com/fr/fr/email dell/</b>	
Country Code: <b>33</b>	<b>Home and Small Business</b>	
City Codes: <b>(1) (4)</b>	Technical Support	0825 387 270
	Customer Care	0825 823 833
	Switchboard	0825 004 700
	Switchboard (calls from outside of France)	04 99 75 40 00
	Sales	0825 004 700
	Fax	0825 004 701
	Fax (calls from outside of France)	04 99 75 40 01
	<b>Corporate</b>	
	Technical Support	0825 004 719
	Customer Care	0825 338 339
	Switchboard	01 55 94 71 00
	Sales	01 55 94 71 00
	Fax	01 55 94 71 01

<b>Country (City) International Access Code Country Code City Code</b>	<b>Department Name or Service Area, Website and E-Mail Address</b>	<b>Area Codes, Local Numbers, and Toll-Free Numbers</b>
<b>Germany (Langen)</b>	Website: <b>support.euro.dell.com</b>	
International Access Code: <b>00</b>	E-mail: tech_support_central_europe@dell.com	
Country Code: <b>49</b>	Technical Support	06103 766-7200
City Code: <b>6103</b>	Home/Small Business Customer Care	0180-5-224400
	Global Segment Customer Care	06103 766-9570
	Preferred Accounts Customer Care	06103 766-9420
	Large Accounts Customer Care	06103 766-9560
	Public Accounts Customer Care	06103 766-9555
	Switchboard	06103 766-7000
<b>Greece</b>	Website: <b>support.euro.dell.com</b>	
<b>International Access Code: 00</b>	E-mail: support.euro.dell.com/gr/en/email dell/	
<b>Country Code: 30</b>	Technical Support	080044149518
	Gold Technical Support	08844140083
	Switchboard	2108129800
	Sales	2108129800
	Fax	2108129812

<b>Country (City) International Access Code Country Code City Code</b>	<b>Department Name or Service Area, Website and E-Mail Address</b>	<b>Area Codes, Local Numbers, and Toll-Free Numbers</b>
<b>Ireland (Cherrywood)</b>	Website: <b>support.euro.dell.com</b>	
International Access Code: <b>16</b>	E-mail: dell_direct_support@dell.com	
Country Code: <b>353</b>	Ireland Technical Support	1850 543 543
City Code: <b>1</b>	U.K. Technical Support (dial within U.K. only)	0870 908 0800
	Home User Customer Care	01 204 4014
	Small Business Customer Care	01 204 4014
	U.K. Customer Care (dial within U.K. only)	0870 906 0010
	Corporate Customer Care	1850 200 982
	Corporate Customer Care (dial within U.K. only)	0870 907 4499
	Ireland Sales	01 204 4444
	U.K. Sales (dial within U.K. only)	0870 907 4000
	Fax/SalesFax	01 204 0103
	Switchboard	01 204 4444



<b>Country (City) International Access Code Country Code City Code</b>	<b>Department Name or Service Area, Website and E-Mail Address</b>	<b>Area Codes, Local Numbers, and Toll-Free Numbers</b>
<b>Italy (Milan)</b>	Website: <b>support.euro.dell.com</b>	
International Access Code: <b>00</b>	E-mail: <b>support.euro.dell.com/it/it/email dell/</b>	
Country Code: <b>39</b>	<b>Home and Small Business</b>	
City Code: <b>02</b>	Technical Support	<b>02 577 826 90</b>
	Customer Care	<b>02 696 821 14</b>
	Fax	<b>02 696 821 13</b>
	Switchboard	<b>02 696 821 12</b>
	<b>Corporate</b>	
	Technical Support	<b>02 577 826 90</b>
	Customer Care	<b>02 577 825 55</b>
	Fax	<b>02 575 035 30</b>
	Switchboard	<b>02 577 821</b>

<b>Country (City) International Access Code Country Code City Code</b>	<b>Department Name or Service Area, Website and E-Mail Address</b>	<b>Area Codes, Local Numbers, and Toll-Free Numbers</b>
<b>Japan (Kawasaki)</b>	Website: <b>support.jp.dell.com</b>	
International Access Code: <b>001</b>	Technical Support (servers)	toll-free: 0120-198- 498
Country Code: <b>81</b>	Technical Support outside of Japan (servers)	81-44-556-4162
City Code: <b>44</b>	Technical Support (Dimension™ and Inspiron™)	toll-free: 0120-198- 226
	Technical Support outside of Japan (Dimension and Inspiron)	81-44-520-1435
	Technical Support (Dell Precision™, OptiPlex™, and Latitude™)	toll-free:0120-198- 433
	Technical Support outside of Japan (Dell Precision, OptiPlex, and Latitude)	81-44-556-3894
	Faxbox Service	044-556-3490
	24-Hour Automated Order Service	044-556-3801
	Customer Care	044-556-4240
	Business Sales Division (up to 400 employees)	044-556-1465
	Preferred Accounts Division Sales (over 400 employees)	044-556-3433
	Large Corporate Accounts Sales (over 3500 employees)	044-556-3430
	Public Sales (government agencies, educational institutions, and medical institutions)	044-556-1469
	Global Segment Japan	044-556-3469
	Individual User	044-556-1760
	Switchboard	044-556-4300

<b>Country (City) International Access Code Country Code City Code</b>	<b>Department Name or Service Area, Website and E-Mail Address</b>	<b>Area Codes, Local Numbers, and Toll-Free Numbers</b>
<b>Korea (Seoul)</b> International Access Code: <b>001</b> Country Code: <b>82</b> City Code: <b>2</b>	Technical Support	toll-free: 080-200-3800
	Sales	toll-free: 080-200-3600
	Customer Service (Seoul, Korea)	toll-free: 080-200-3800
	Customer Service (Penang, Malaysia)	604 633 4949
	Fax	2194-6202
	Switchboard	2194-6000
<b>Luxembourg</b> International Access Code: <b>00</b> Country Code: <b>352</b>	Website: <b>support.euro.dell.com</b>	
	E-mail: tech_be@dell.com	
	Technical Support (Brussels, Belgium)	3420808075
	Home/Small Business Sales (Brussels, Belgium)	toll-free: 080016884
	Corporate Sales (Brussels, Belgium)	02 481 91 00
	Customer Care (Brussels, Belgium)	02 481 91 19
	Fax (Brussels, Belgium)	02 481 92 99
Switchboard (Brussels, Belgium)	02 481 91 00	
<b>Malaysia (Penang)</b> International Access Code: <b>00</b> Country Code: <b>60</b> City Code: <b>4</b>	Technical Support	toll-free: 1 800 888 298
	Customer Service	04 633 4949
	Transaction Sales	toll-free: 1 800 888 202
	Corporate Sales	toll-free: 1 800 888 213

<b>Country (City) International Access Code Country Code City Code</b>	<b>Department Name or Service Area, Website and E-Mail Address</b>	<b>Area Codes, Local Numbers, and Toll-Free Numbers</b>
<b>Mexico</b>	Customer Technical Support	001-877-384-8979
International Access Code: <b>00</b>	Sales	or 001-877-269-3383 50-81-8800
Country Code: <b>52</b>	Customer Service	or 01-800-888-3355 001-877-384-8979
	Main	or 001-877-269-3383 50-81-8800
		or 01-800-888-3355
<b>Netherlands Antilles</b>	General Support	001-800-882-1519

<b>Country (City) International Access Code Country Code City Code</b>	<b>Department Name or Service Area, Website and E-Mail Address</b>	<b>Area Codes, Local Numbers, and Toll-Free Numbers</b>
<b>Netherlands (Amsterdam)</b>	Website: <b>support.euro.dell.com</b>	
International Access Code: <b>00</b>	E-mail (Technical Support): (Enterprise): nl_server_support@dell.com	
Country Code: <b>31</b>	(Latitude): nl_latitude_support@dell.com	
City Code: <b>20</b>	(Inspiron): nl_inspiron_support@dell.com	
	(Dimension): nl_dimension_support@dell.com	
	(OptiPlex): nl_optiplex_support@dell.com	
	(Dell Precision): nl_workstation_support@dell.com	
	Technical Support	020 674 45 00
	Technical Support Fax	020 674 47 66
	Home/Small Business Customer Care	020 674 42 00
	Relational Customer Care	020 674 4325
	Home/Small Business Sales	020 674 55 00
	Relational Sales	020 674 50 00
	Home/Small Business Sales Fax	020 674 47 75
	Relational Sales Fax	020 674 47 50
	Switchboard	020 674 50 00
	Switchboard Fax	020 674 47 50

Country (City) International Access Code Country Code City Code	Department Name or Service Area, Website and E-Mail Address	Area Codes, Local Numbers, and Toll-Free Numbers
<b>New Zealand</b>	E-mail (New Zealand): nz_tech_support@dell.com	
International Access Code: <b>00</b>	E-mail (Australia): au_tech_support@dell.com	
Country Code: <b>64</b>	Home and Small Business	0800 446 255
	Government and Business	0800 444 617
	Sales	0800 441 567
	Fax	0800 441 566
<b>Norway (Lysaker)</b>	Website: <b>support.euro.dell.com</b>	
International Access Code: <b>00</b>	E-mail Support (portable computers): nor_nbk_support@dell.com	
Country Code: <b>47</b>	E-mail Support (desktop computers): nor_support@dell.com	
	E-mail Support (servers): nordic_server_support@dell.com	
	Technical Support	671 16882
	Relational Customer Care	671 17514
	Home/Small Business Customer Care	23162298
	Switchboard	671 16800
	Fax Switchboard	671 16865

Country (City) International Access Code Country Code City Code	Department Name or Service Area, Website and E-Mail Address	Area Codes, Local Numbers, and Toll-Free Numbers
<b>Singapore (Singapore)</b> International Access Code: <b>005</b> Country Code: <b>65</b>	Technical Support	toll-free: 800 6011 051
	Customer Service (Penang, Malaysia)	604 633 4949
	Transaction Sales	toll-free: 800 6011 054
	Corporate Sales	toll-free: 800 6011 053
<b>Spain (Madrid)</b> International Access Code: <b>00</b> Country Code: <b>34</b> City Code: <b>91</b>	Website: <b>support.euro.dell.com</b>	
	E-mail: <b>support.euro.dell.com/es/es/emaildell/</b>	
	<b>Home and Small Business</b>	
	Technical Support	902 100 130
	Customer Care	902 118 540
	Sales	902 118 541
	Switchboard	902 118 541
	Fax	902 118 539
	<b>Corporate</b>	
	Technical Support	902 100 130
	Customer Care	902 118 546
	Switchboard	91 722 92 00
	Fax	91 722 95 83

<b>Country (City) International Access Code Country Code City Code</b>	<b>Department Name or Service Area, Website and E-Mail Address</b>	<b>Area Codes, Local Numbers, and Toll-Free Numbers</b>
<b>Sweden (Upplands Vasby)</b>	Website: <a href="http://support.euro.dell.com">support.euro.dell.com</a> E-mail: <a href="mailto:swe_support@dell.com">swe_support@dell.com</a>	
International Access Code: <b>00</b>	E-mail Support for Latitude and Inspiron:	
Country Code: <b>46</b>	<a href="mailto:Swe-nbk_kats@dell.com">Swe-nbk_kats@dell.com</a>	
City Code: <b>8</b>	E-mail Support for OptiPlex: <a href="mailto:Swe_kats@dell.com">Swe_kats@dell.com</a>	
	E-mail Support for Servers: <a href="mailto:Nordic_server_support@dell.com">Nordic_server_support@dell.com</a>	
	Technical Support	08 590 05 199
	Relational Customer Care	08 590 05 642
	Home/Small Business Customer Care	08 587 70 527
	Employee Purchase Program (EPP) Support	20 140 14 44
	Fax Technical Support	08 590 05 594
	Sales	08 590 05 185



<b>Country (City) International Access Code Country Code City Code</b>	<b>Department Name or Service Area, Website and E-Mail Address</b>	<b>Area Codes, Local Numbers, and Toll-Free Numbers</b>
<b>Switzerland (Geneva)</b>	Website: <b>support.euro.dell.com</b>	
International Access Code: <b>00</b>	E-mail: <b>swisstech@dell.com</b>	
Country Code: <b>41</b>	E-mail for French-speaking HSB and Corporate Customers:	
City Code: <b>22</b>	<b>support.euro.dell.com/ch/fr/email dell/</b>	
	Technical Support (Home and Small Business)	<b>0844 811 411</b>
	Technical Support (Corporate)	<b>0844 822 844</b>
	Customer Care (Home and Small Business)	<b>0848 802 202</b>
	Customer Care (Corporate)	<b>0848 821 721</b>
	Fax	<b>022 799 01 90</b>
	Switchboard	<b>022 799 01 01</b>
<b>Turks and Caicos Islands</b>	General Support	toll-free: <b>1-866-540- 3355</b>

<b>Country (City) International Access Code Country Code City Code</b>	<b>Department Name or Service Area, Website and E-Mail Address</b>	<b>Area Codes, Local Numbers, and Toll-Free Numbers</b>
<b>U.K. (Bracknell)</b>	Website: <b>support.euro.dell.com</b>	
International Access Code: <b>00</b>	Customer Care website: <b>support.euro.dell.com/uk/en/ECare/Form/Home.asp</b>	
Country Code: <b>44</b>		
City Code: <b>1344</b>	E-mail: dell_direct_support@dell.com	
	Technical Support (Corporate/Preferred Accounts/PAD [1000+ employees])	0870 908 0500
	Technical Support (direct/PAD and general)	0870 908 0800
	Global Accounts Customer Care	01344 373 186
	Home and Small Business Customer Care	0870 906 0010
	Corporate Customer Care	01344 373 185
	Preferred Accounts (500–5000 employees) Customer Care	0870 906 0010
	Central Government Customer Care	01344 373 193
	Local Government & Education Customer Care	01344 373 199
	Health Customer Care	01344 373 194
	Home and Small Business Sales	0870 907 4000
	Corporate/Public Sector Sales	01344 860 456

<b>Country (City) International Access Code Country Code City Code</b>	<b>Department Name or Service Area, Website and E-Mail Address</b>	<b>Area Codes, Local Numbers, and Toll-Free Numbers</b>
<b>U.S.A. (Austin, Texas)</b>  International Access Code: <b>011</b> Country Code: <b>1</b>	Automated Order-Status Service	toll-free: 1-800-433-9014
	AutoTech (portable and desktop computers)	toll-free: 1-800-247-9362
	<b>Consumer (Home and Home Office)</b>	
	Technical Support	toll-free: 1-800-624-9896
	Customer Service	toll-free: 1-800-624-9897
	DellNet™ Service and Support	toll-free: 1-877-Dell-net (1-877-335-5638)
	Employee Purchase Program (EPP) Customers	toll-free: 1-800-695-8133
	Financial Services website: <b>www.dellfinancialservices.com</b>	
	Financial Services (lease/loans)	toll-free: 1-877-577-3355
	Financial Services (Dell Preferred Accounts [DPA])	toll-free: 1-800-283-2210
	<b>Business</b>	
	Customer Service and Technical Support	toll-free: 1-800-822-8965
	Employee Purchase Program (EPP) Customers	toll-free: 1-800-695-8133
Projectors Technical Support	toll-free: 1-877-459-7298	
<b>Public (government, education, and healthcare)</b>		

<b>Country (City) International Access Code Country Code City Code</b>	<b>Department Name or Service Area, Website and E-Mail Address</b>	<b>Area Codes, Local Numbers, and Toll-Free Numbers</b>
	Customer Service and Technical Support	toll-free: 1-800-456-3355
	Employee Purchase Program (EPP) Customers	toll-free: 1-800-234-1490
	Dell Sales	toll-free: 1-800-289-3355 or toll-free: 1-800-879-3355
	Dell Outlet Store (Dell refurbished computers)	toll-free: 1-888-798-7561
	Software and Peripherals Sales	toll-free: 1-800-671-3355
	Spare Parts Sales	toll-free: 1-800-357-3355
	Extended Service and Warranty Sales	toll-free: 1-800-247-4618
	Fax	toll-free: 1-800-727-8320
	Dell Services for the Deaf, Hard-of-Hearing, or Speech-Impaired	toll-free: 1-877-DELLTTY (1-877-335-5889)

# Limited Warranties and Return Policy

Dell-branded hardware products purchased in the U.S. or Canada come with either a 90-day, 1-year, 2-year, 3-year, or 4-year limited warranty. To determine which warranty came with your hardware product(s), see your packing slip or invoice. The following sections describe the limited warranties and return policy for the U.S., the limited warranties and return policy for Canada, the manufacturer guarantee for Latin America and the Caribbean, and the Intel® Pentium® and Celeron® warranty for the U.S. and Canada.

## Limited Warranty for Dell-Branded Hardware Products (U.S. Only)

### What is covered by this limited warranty?

This limited warranty covers defects in materials and workmanship in your—our end-user customer's—Dell-branded hardware products, including Dell-branded peripheral products.

### What is not covered by this limited warranty?

This limited warranty does not cover:

- Software, including the operating system and software added to the Dell-branded hardware products through our factory-integration system, third-party software, or the reloading of software
- Non-Dell-branded and Solution Provider Direct products and accessories
- Problems that result from:
  - External causes such as accident, abuse, misuse, or problems with electrical power
  - Servicing not authorized by Dell
  - Usage that is not in accordance with product instructions
  - Failure to follow the product instructions or failure to perform preventive maintenance
  - Problems caused by using accessories, parts, or components not supplied by Dell
- Products with missing or altered Service Tags or serial numbers
- Products for which Dell has not received payment

**THIS WARRANTY GIVES YOU SPECIFIC LEGAL RIGHTS, AND YOU MAY ALSO HAVE OTHER RIGHTS WHICH VARY FROM STATE TO STATE (OR JURISDICTION TO JURISDICTION). DELL'S RESPONSIBILITY FOR MALFUNCTIONS AND DEFECTS IN HARDWARE IS LIMITED TO REPAIR AND REPLACEMENT AS SET FORTH IN THIS WARRANTY STATEMENT. ALL EXPRESS AND IMPLIED WARRANTIES FOR THE PRODUCT, INCLUDING BUT NOT LIMITED TO ANY IMPLIED WARRANTIES AND CONDITIONS OF MERCHANTABILITY AND FITNESS FOR A PARTICULAR PURPOSE, ARE LIMITED IN TIME TO THE TERM OF THE LIMITED WARRANTY PERIOD REFLECTED ON YOUR PACKING SLIP OR INVOICE. NO WARRANTIES, WHETHER EXPRESS OR IMPLIED, WILL APPLY AFTER THE LIMITED WARRANTY PERIOD HAS EXPIRED. SOME STATES DO NOT ALLOW LIMITATIONS ON HOW LONG AN IMPLIED WARRANTY LASTS, SO THIS LIMITATION MAY NOT APPLY TO YOU.**

**WE DO NOT ACCEPT LIABILITY BEYOND THE REMEDIES PROVIDED FOR IN THIS LIMITED WARRANTY OR FOR CONSEQUENTIAL OR INCIDENTAL DAMAGES, INCLUDING, WITHOUT LIMITATION, ANY LIABILITY FOR THIRD-PARTY CLAIMS AGAINST YOU FOR DAMAGES, FOR PRODUCTS NOT BEING AVAILABLE FOR USE, OR FOR LOST DATA OR LOST SOFTWARE. OUR LIABILITY WILL BE NO MORE THAN THE AMOUNT YOU PAID FOR THE PRODUCT THAT IS THE SUBJECT OF A CLAIM. THIS IS THE MAXIMUM AMOUNT FOR WHICH WE ARE RESPONSIBLE.**

**SOME STATES DO NOT ALLOW THE EXCLUSION OR LIMITATION OF INCIDENTAL OR CONSEQUENTIAL DAMAGES, SO THE ABOVE LIMITATION OR EXCLUSION MAY NOT APPLY TO YOU.**

### **How long does this limited warranty last?**

This limited warranty lasts for the time period indicated on your packing slip or invoice, except that the limited warranty on Dell-branded batteries lasts only 1 year and the limited warranty on the lamps for Dell-branded projectors lasts only 90 days. The limited warranty begins on the date of the packing slip or invoice. The warranty period is not extended if we repair or replace a warranted product or any parts. Dell may change the availability of limited warranties, at its discretion, but any changes will not be retroactive.

## What do I do if I need warranty service?

Before the warranty expires, please call us at the relevant number listed in the following table. Please also have your Dell Service Tag or order number available.

<b>Individual Home Consumers:</b>	<b>U.S. Only</b>
Technical Support	1-800-624-9896
Customer Service	1-800-624-9897
<b>Individual Home Consumers who purchased through an Employee Purchase Program:</b>	
Technical Support and Customer Service	1-800-822-8965
<b>Home and Small Business Commercial Customers:</b>	
Technical Support and Customer Service	1-800-456-3355
<b>Medium, Large, or Global Commercial Customers, Healthcare Customers, and Value-Added Resellers (VARs):</b>	
Technical Support and Customer Service	1-800-822-8965
<b>Government and Education Customers:</b>	
Technical Support and Customer Service	1-800-234-1490
<b>Dell-Branded Memory</b>	<b>1-888-363-5150</b>

## What will Dell do?

**During the 90 days of the 90-day limited warranty and the first year of all other limited warranties:** During the 90 days of the 90-day limited warranty and the first year of all other limited warranties, we will repair any Dell-branded hardware products returned to us that prove to be defective in materials or workmanship. If we are not able to repair the product, we will replace it with a comparable product that is new or refurbished.

When you contact us, we will issue a Return Material Authorization Number for you to include with your return. You must return the products to us in their original or equivalent packaging, prepay shipping charges, and insure the shipment or accept the risk if the product is lost or damaged in shipment. We will return the repaired or replacement products to you. We will pay to ship the repaired or replaced products to you if you use an address in the United States (excluding Puerto Rico and U.S. possessions and territories). Otherwise, we will ship the product to you freight collect.

If we determine that the product is not covered under this warranty, we will notify you and inform you of service alternatives that are available to you on a fee basis.

**NOTE:** Before you ship the product(s) to us, make sure to back up the data on the hard drive(s) and any other storage device(s) in the product(s). Remove any confidential, proprietary, or personal information and removable media such as floppy disks, CDs, or PC Cards. We are not responsible for any of your confidential, proprietary, or personal information; lost or corrupted data; or damaged or lost removable media.

**During the remaining years:** For the remaining period of the limited warranty, we will replace any defective part with new or refurbished parts, if we agree that it needs to be replaced.

When you contact us, we will require a valid credit card number at the time you request a replacement part, but we will not charge you for the replacement part as long as you return the original part to us within 30 days after we ship the replacement part to you. If we do not receive the original part within 30 days, we will charge to your credit card the then-current standard price for that part.

We will pay to ship the part to you if you use an address in the United States (excluding Puerto Rico and U.S. possessions and territories). Otherwise, we will ship the part freight collect. We will also include a prepaid shipping container with each replacement part for your use in returning the replaced part to us.

**NOTE:** Before you replace parts, make sure to back up the data on the hard drive(s) and any other storage device(s) in the product(s). We are not responsible for lost or corrupted data.

## What if I purchased a service contract?

If your service contract is with Dell, service will be provided to you under the terms of the service agreement. Please refer to that contract for details on how to obtain service.

If you purchased through us a service contract with one of our third-party service providers, please refer to that contract for details on how to obtain service.

## How will you fix my product?

We use new and refurbished parts made by various manufacturers in performing warranty repairs and in building replacement parts and systems. Refurbished parts and systems are parts or systems that have been returned to Dell, some of which were never used by a customer. All parts and systems are inspected and tested for quality. Replacement parts and systems are covered for the remaining period of the limited warranty for the product you bought. Dell owns all parts removed from repaired products.

## May I transfer the limited warranty?

Limited warranties on systems may be transferred if the current owner transfers ownership of the system and records the transfer with us. The limited warranty on Dell-branded memory may not be transferred. You may record your transfer by going to Dell's website:

- If you are an Individual Home Consumer, go to [www.dell.com/us/en/dhs/topics/sbtopic\\_015\\_ccare.htm](http://www.dell.com/us/en/dhs/topics/sbtopic_015_ccare.htm)



- If you are a Home Office, Small, Medium, Large, or Global Commercial Customer, go to [www.dell.com/us/en/biz/topics/sbtopic\\_ccare\\_nav\\_015\\_ccare.htm](http://www.dell.com/us/en/biz/topics/sbtopic_ccare_nav_015_ccare.htm)
- If you are a Government, Education, or Healthcare Customer, or an Individual Home Consumer who purchased through an Employee Purchase Program, go to [www.dell.com/us/en/pub/topics/sbtopic\\_015\\_ccare.htm](http://www.dell.com/us/en/pub/topics/sbtopic_015_ccare.htm)

If you do not have Internet access, call your customer care representative or call 1-800-624-9897.

## "Total Satisfaction" Return Policy (U.S. Only)

We value our relationship with you and want to make sure that you're satisfied with your purchases. That's why we offer a "Total Satisfaction" return policy for most products that you—the end-user customer—purchase directly from Dell. Under this policy, you may return to Dell products that you purchased directly from Dell for a credit or a refund of the purchase price paid, less shipping and handling and applicable restocking fees as follows:

- **New Hardware Products and Accessories** — All new hardware, accessories, parts, and unopened software still in its sealed package, excluding the products listed below, may be returned within 30 days from the date on the packing slip or invoice. To return applications software or an operating system that has been installed by Dell, you must return the entire computer. A different return policy applies to nondefective products purchased through Dell's Software and Peripherals division by customers of our Small and Medium Business divisions. Those products may be returned within 30 days from the date on the packing slip or invoice, but a fifteen percent (15%) restocking fee will be deducted from any refund or credit. The "Total Satisfaction" Return Policy and Software and Peripherals division return policy are not available for Dell | EMC storage products, EMC-branded products, or enterprise software.
- **Reconditioned or Refurbished Dell-Branded Hardware Products and Parts** — All reconditioned or refurbished Dell-branded server and storage products may be returned within 30 days from the date on the packing slip or invoice. All other reconditioned or refurbished Dell-branded hardware products and parts may be returned within 14 days of the date on the packing slip or invoice.

To return products, e-mail or call Dell customer service to receive a Credit Return Authorization Number within the return policy period applicable to the product you want to return. You must obtain a Credit Return Authorization Number in order to return the product. See "Contacting Dell" or "Getting Help" in your customer documentation (or [www.dell.com/us/en/gen/contact.htm](http://www.dell.com/us/en/gen/contact.htm)) to find the appropriate contact information for obtaining customer assistance.

You must ship the products to Dell within 5 days of the date that Dell issues the Credit Return Authorization Number. You must also return the products to Dell in their original packaging, in as-new condition along with any media, documentation, and all other items that were included in the original shipment, prepay shipping charges, and insure the shipment or accept the risk of loss or damage during shipment.

## Limited Warranty Terms for Dell-Branded Hardware Products (Canada Only)

### What is covered by this limited warranty?

This limited warranty covers defects in materials and workmanship in your—our end-user customer's—Dell-branded hardware products, including Dell-branded peripheral products.

### What is not covered by this limited warranty?

This limited warranty does not cover:

- Software, including the operating system and software added to the Dell-branded hardware products through our factory-integration system, or the reloading of the software
- Non-Dell branded and Solution Provider Direct products and accessories
- Problems that result from:
  - External causes such as accident, abuse, misuse, or problems with electrical power
  - Servicing not authorized by Dell
  - Usage that is not in accordance with product instructions
  - Failure to follow the product instructions or failure to perform preventive maintenance
  - Problems caused by using accessories, parts, or components not supplied by Dell
- Products with missing or altered Service Tags or serial numbers
- Products for which Dell has not received payment

THIS WARRANTY GIVES YOU SPECIFIC LEGAL RIGHTS, AND YOU MAY ALSO HAVE OTHER RIGHTS WHICH VARY FROM PROVINCE TO PROVINCE. DELL'S RESPONSIBILITY FOR MALFUNCTIONS AND DEFECTS IN PRODUCT IS LIMITED TO REPAIR AND REPLACEMENT AS SET FORTH IN THIS WARRANTY STATEMENT, FOR THE TERM OF THE WARRANTY PERIOD REFLECTED ON YOUR PACKING SLIP OR INVOICE. EXCEPT FOR THE EXPRESS WARRANTIES CONTAINED IN THIS WARRANTY STATEMENT, DELL DISCLAIMS ALL OTHER WARRANTIES AND CONDITIONS, EXPRESS OR IMPLIED, INCLUDING WITHOUT LIMITATION IMPLIED WARRANTIES AND CONDITIONS OF MERCHANTABILITY AND FITNESS FOR A PARTICULAR PURPOSE, STATUTORY OR OTHERWISE. SOME PROVINCES DO NOT ALLOW THE EXCLUSION OF CERTAIN IMPLIED WARRANTIES OR CONDITIONS, OR LIMITATIONS ON HOW LONG AN IMPLIED WARRANTY OR CONDITION LASTS. THEREFORE, THE FOREGOING EXCLUSIONS AND LIMITATIONS MAY NOT APPLY TO YOU.

WE DO NOT ACCEPT LIABILITY BEYOND THE REMEDIES PROVIDED FOR IN THIS WARRANTY STATEMENT OR FOR SPECIAL, INDIRECT, CONSEQUENTIAL, OR INCIDENTAL DAMAGES, INCLUDING, WITHOUT LIMITATION, ANY LIABILITY FOR THIRD-PARTY CLAIMS AGAINST YOU FOR DAMAGES, FOR PRODUCTS NOT BEING AVAILABLE FOR USE, OR FOR LOST DATA OR LOST SOFTWARE. OUR LIABILITY WILL BE NO MORE THAN THE AMOUNT YOU PAID FOR THE PRODUCT THAT IS THE SUBJECT OF A CLAIM. THIS IS THE MAXIMUM AMOUNT FOR WHICH WE ARE RESPONSIBLE.

SOME PROVINCES DO NOT ALLOW THE EXCLUSION OR LIMITATION OF SPECIAL, INDIRECT, INCIDENTAL, OR CONSEQUENTIAL DAMAGES, SO THE ABOVE LIMITATION OR EXCLUSION MAY NOT APPLY TO YOU.

### **How long does this limited warranty last?**

This limited warranty lasts for the time period indicated on your packing slip or invoice, except that the limited warranty on Dell-branded batteries lasts only 1 year and the limited warranty on the lamps for Dell-branded projectors lasts only 90 days. The limited warranty begins on the date of the packing slip or invoice. The warranty period is not extended if we repair or replace a warranted product or any parts. Dell may change the terms and availability of limited warranties, at its discretion, but any changes will not be retroactive (that is, the warranty terms in place at the time of purchase will apply to your purchase).

## What do I do if I need warranty service?

Before the warranty expires, please call us at the relevant number listed in the following table. Please also have your Dell Service Tag or order number available.

<b>Individual Home Consumers; Home Office and Small Business Customers:</b>	<b>Canada Only</b>
Technical Support and Customer Service	1-800-847-4096
<b>Medium, Large, and Global Commercial Customers; Government, Education, and Healthcare Customers; and Value-Added Resellers (VARs):</b>	
Technical Support	1-800-387-5757
Customer Service	1-800-326-9463
<b>Government or Education Customers, or Individual Home Consumers who purchased through an Employee Purchase Program:</b>	
Technical Support	1-800-387-5757
Customer Service	1-800-326-9463 (Extension 8221 for Individual Consumers)
<b>Dell-Branded Memory</b>	<b>1-888-363-5150</b>

## What will Dell do?

**During the 90 days of the 90-day limited warranty and the first year of all other limited warranties:** During the 90 days of the 90-day limited warranty and the first year of all other limited warranties, we will repair any Dell-branded hardware products returned to us that prove to be defective in materials or workmanship. If we are not able to repair the product, we will replace it with a comparable product that is new or refurbished.

When you contact us, we will issue a Return Material Authorization Number for you to include with your return. You must return the products to us in their original or equivalent packaging, prepay shipping charges, and insure the shipment or accept the risk if the product is lost or damaged in shipment. We will return the repaired or replacement products to you. We will pay to ship the repaired or replaced products to you if you use an address in Canada. Otherwise, we will ship the product to you freight collect.

If we determine that the problem is not covered under this warranty, we will notify you and inform you of service alternatives that are available to you on a fee basis.

**NOTE:** Before you ship the product(s) to us, make sure to back up the data on the hard drive(s) and any other storage device(s) in the product(s). Remove any confidential, proprietary or personal information, removable media, such as floppy disks, CDs, or PC Cards. We are not responsible for any of your confidential, proprietary or personal information; lost or corrupted data; or damaged or lost removable media.

**During the remaining years following the first year of all limited warranties:** We will replace any defective part with new or refurbished parts, if we agree that it needs to be replaced. When you contact us, we will require a valid credit card number at the time you request a replacement part, but we will not charge you for the replacement part as long as you return the original part to us within 30 days after we ship the replacement part to you. If we do not receive the original part within 30 days, we will charge to your credit card the then-current standard price for that part.

We will pay to ship the part to you if you use an address in Canada. Otherwise, we will ship the part freight collect. We will also include a prepaid shipping container with each replacement part for your use in returning the replaced part to us.

**NOTE:** Before you replace parts, make sure to back up the data on the hard drive(s) and any other storage device(s) in the product(s). We are not responsible for lost or corrupted data.

### **What if I purchased a service contract?**

If your service contract is with Dell, service will be provided to you under the terms of the service contract. Please refer to that contract for details on how to obtain service. Dell's service contracts can be found online at [www.dell.ca](http://www.dell.ca) or by calling Customer Care at 1-800-847-4096. If you purchased through us a service contract with one of our third-party service providers, please refer to that contract (mailed to you with your packing slip or invoice) for details on how to obtain service.

### **How will you fix my product?**

We use new and refurbished parts made by various manufacturers in performing warranty repairs and in building replacement parts and systems. Refurbished parts and systems are parts or systems that have been returned to Dell, some of which were never used by a customer. All parts and systems are inspected and tested for quality. Replacement parts and systems are covered for the remaining period of the limited warranty for the product you bought. Dell owns all parts removed from repaired products.

### **May I transfer the limited warranty?**

Limited warranties on systems may be transferred if the current owner transfers ownership of the system and records the transfer with us. The limited warranty on Dell-branded memory may not be transferred. You may record your transfer by going to Dell's website:

- For Canada-purchased computers (in-country transfers) and to transfer from one customer to another, go to [www.dell.ca/ca/en/gen/topics/segtopic\\_ccare\\_nav\\_013\\_ccare.htm](http://www.dell.ca/ca/en/gen/topics/segtopic_ccare_nav_013_ccare.htm)
- For out-of-country transfers (outside of the original country of purchase), go to [www.dell.com/us/en/biz/topics/sbtopic\\_ccare\\_nav\\_016\\_ccare.htm](http://www.dell.com/us/en/biz/topics/sbtopic_ccare_nav_016_ccare.htm)

If you do not have Internet access, call Dell at 1-800-847-4096 (Home Consumer customers) or 1-800-326-9463 (Corporate Commercial or Government customers).

## "Total Satisfaction" Return Policy (Canada Only)

If you are an end-user customer who bought new products directly from Dell, you may return them to Dell up to 30 days after you receive them for a refund or credit of the product purchase price. If you are an end-user customer who bought reconditioned or refurbished products from Dell, you may return them to Dell within 14 days after the date on the packing slip or invoice for a refund or credit of the product purchase price. In either case, the refund or credit will not include any shipping and handling charges shown on your packing slip or invoice and will be subject to a fifteen percent (15%) restocking fee, unless otherwise prohibited by law. If you are an organization that bought the products under a written agreement with Dell, the agreement may contain different terms for the return of products than specified by this policy.

To return products, you must call Dell Customer Service at 1-800-847-4096 to receive a Credit Return Authorization Number. To expedite the process of your refund or credit, Dell expects you to return the products to Dell in their original packaging within 5 days of the date that Dell issues the Credit Return Authorization Number. You must also prepay shipping charges and insure the shipment or accept the risk of loss or damage during shipment. You may return software for a refund or credit only if the sealed package containing the floppy disk(s) or CD(s) is unopened. Returned products must be in as-new condition, and all of the manuals, floppy disk(s), CD(s), power cables, and other items included with a product must be returned with it. For customers who want to return, for refund or credit only, either application or operating system software that has been installed by Dell, the whole system must be returned, along with any media and documentation that may have been included in the original shipment.

The "Total Satisfaction" Return Policy does not apply to Dell | EMC storage products. It also does not apply to products purchased through Dell's Software and Peripherals division. For those products, please instead refer to Dell's Software and Peripherals then-current return policy (see the following section, "Dell Software and Peripherals (Canada Only)").

## Dell Software and Peripherals (Canada Only)

### Third-Party Software and Peripherals Products

Similar to other resellers of software and peripherals, Dell does not warrant third-party products. Third-party software and peripheral products are covered by the warranties provided by the original manufacturer or publisher only. Third-party manufacturer warranties vary from product to product. Consult your product documentation for specific warranty information. More information may also be available from the manufacturer or publisher.

While Dell offers a wide selection of software and peripheral products, we do not specifically test or guarantee that all of the products we offer work with any or all of the various models of Dell computers, nor do we test or guarantee all of the products we sell on the hundreds of different brands of computers available today. If you have questions about compatibility, we recommend and encourage you to contact the third-party software and peripheral product manufacturer or publisher directly.

### Dell-Branded Peripheral Products

Dell does provide a limited warranty for new Dell-branded peripheral products (products for which Dell is listed as the manufacturer) such as monitors, batteries, memory, docking stations, and projectors. To determine which limited warranty applies to the product you purchased, see the Dell packing slip or invoice and/or the product documentation that accompanied your product. Descriptions of Dell's limited warranties are described in preceding sections.

### Return Policy

If you are an end-user customer who bought Dell Software and Peripherals products directly from a Dell company, you may return Dell Software and Peripherals products that are in as-new condition to Dell up to 30 days from the date on the packing slip or invoice for a refund of the product purchase price if already paid. This refund will not include any shipping and handling charges shown on your packing slip or invoice; you are responsible for those.

To return products, you must call Dell Customer Service at 1-800-387-5759 to receive a Credit Return Authorization Number. You must ship the Dell Software and Peripherals products back to Dell in their original manufacturer's packaging (which must be in as-new condition), prepay shipping charges, and insure the shipment or accept the risk of loss or damage during shipment.

To qualify for refund or replacement, returned products must be in as-new condition, software products must be unopened, and all of the manuals, floppy disk(s), CD(s), power cables, and other items included with a product must be returned with it.

## 1-Year End-User Manufacturer Guarantee (Latin America and the Caribbean Only)

### Guarantee

Dell Computer Corporation ("Dell") warrants to the end user in accordance with the following provisions that its branded hardware products, purchased by the end user from a Dell company or an authorized Dell distributor in Latin America or the Caribbean, will be free from defects in materials, workmanship, and design affecting normal use, for a period of 1 year from the original purchase date. Products for which proper claims are made will, at Dell's option, be repaired or replaced at Dell's expense. Dell owns all parts removed from repaired products. Dell uses new and reconditioned parts made by various manufacturers in performing repairs and building replacement products.

### Exclusions

This Guarantee does not apply to defects resulting from: improper or inadequate installation, use, or maintenance; actions or modifications by unauthorized third parties or the end user; accidental or willful damage; or normal wear and tear.

### Making a Claim

Claims must be made in Latin America or the Caribbean by contacting the Dell point of sale within the guarantee period. The end user must always supply proof of purchase, indicating name and address of the seller, date of purchase, model and serial number, name and address of the customer, and details of symptoms and configuration at the time of malfunction, including peripherals and software used. Otherwise, Dell may refuse the guarantee claim. Upon diagnosis of a warranted defect, Dell will make arrangements and pay for ground freight and insurance to and from Dell's repair/replacement center. The end user must ensure that the defective product is available for collection properly packed in original or equally protective packaging together with the details listed above and the return number provided to the end user by Dell.

### Limitation and Statutory Rights

Dell makes no other warranty, guarantee or like statement other than as explicitly stated above, and this Guarantee is given in place of all other guarantees whatsoever, to the fullest extent permitted by law. In the absence of applicable legislation, this Guarantee will be the end user's sole and exclusive remedy against Dell or any of its affiliates, and neither Dell nor any of its affiliates shall be liable for loss of profit or contracts, or any other indirect or consequential loss arising from negligence, breach of contract, or howsoever.

**This Guarantee does not impair or affect mandatory statutory rights of the end user against and/or any rights resulting from other contracts concluded by the end user with Dell and/or any other seller.**



**Dell World Trade LP**

One Dell Way, Round Rock, TX 78682, USA

**Dell Computadores do Brasil Ltda (CNPJ No. 72.381.189/0001-10)/**

**Dell Commercial do Brasil Ltda (CNPJ No. 03 405 822/0001-40)**

Avenida Industrial Belgraf, 400

92990-000 - Eldorado do Sul - RS - Brasil

**Dell Computer de Chile Ltda**

Coyancura 2283, Piso 3- Of.302,

Providencia, Santiago - Chile

**Dell Computer de Colombia Corporation**

Carrera 7 #115-33 Oficina 603

Bogota, Colombia

**Dell Computer de Mexico SA de CV**

Paseo de la Reforma 2620 - 11° Piso

Col. Lomas Altas

11950 México, D.F.



# Glossary

**BLUETOOTH™** — A wireless technology standard for short-range (10 m [30 ft]) networking devices that allows for enabled devices to automatically recognize each other.

**COMPACTFLASH CARD** — A removable card that is used to expand the capabilities of a device. Common types of CompactFlash cards include memory and wireless cards.

**CRADLE** — A device that allows your handheld device to synchronize with a computer, recharge its battery, and run on AC power.

**DHCP** — dynamic host configuration protocol — A communication protocol that allows network administrators to manage and automate the assignment of Internet Protocol addresses to computers in a network.

**IMAP** — Internet message access protocol — A standard client/server protocol that allows you to access your e-mail from a server. Using IMAP, you can store and browse your e-mail on the server.

**INFRARED SENSOR** — A port that allows you to transfer data between the computer and infrared-compatible devices without using a cable connection.

**ISP** — Internet service provider — A company that allows you to access its host server to connect directly to the Internet, send and receive e-mail, and access websites. The ISP typically provides you with a software package, username, and access phone numbers for a fee.

**LAN** — local area network — A computer network covering a small area. A LAN usually is confined to a building or a few nearby buildings. A LAN can be connected to another LAN over any distance via telephone lines and radio waves to form a wide area network (WAN).

**PIM** — personal information manager — A program that stores and organizes your personal information, such as Calendar, Contacts, Inbox, and Tasks.

**POP3** — post office protocol 3 — A standard client/server protocol that allows you to access your e-mail from a server. Using POP3, you must download your e-mail to your local system to view and browse your messages.

**RAM** — random-access memory — The primary temporary storage area for program instructions and data. Any information stored in RAM is lost when you perform a reset.

**RAS** — remote access server — A type of server that allows users to access a network from a remote location.

**ROM** — read-only memory — Memory that stores data and programs that cannot be deleted or written to by the device. ROM, unlike RAM, retains its contents after you perform a reset. Some programs essential to the operation of your device reside in ROM.

**SDRAM** — synchronous dynamic random-access memory — A type of DRAM that is synchronized with the optimal clock speed of the microprocessor.

**SECURE DIGITAL CARD** — A type of removable memory commonly used in digital cameras, handheld devices, cell phones, and other devices. Secure Digital cards are approximately the size of a postage stamp.

**SERIAL CONNECTOR** — An I/O port often used to connect devices such as a handheld digital device or digital camera to your computer.

**SMS** — short message service — A service that is capable of sending short messages to wireless devices.

**SMTP** — simple mail transfer protocol — A type of protocol used for sending and receiving e-mail. SMTP is typically coupled with POP3 or IMAP.

**SYNC CABLE** — A cable through which you can connect a handheld device to a computer to transfer or synchronize files.

**SYNCHRONIZATION** — An automated process that replaces the files in one location with the most updated files from another location. For example, you can synchronize the files on your computer with the files on your handheld device.

**TCP/IP** — transmission control protocol/Internet protocol — The basic communication language of the Internet. TCP/IP can also be used as a communication protocol in an intranet or extranet.

**USB** — universal serial bus — A hardware interface for a low-speed device such as a USB-compatible keyboard, mouse, joystick, scanner, set of speakers, printer, broadband devices (DSL and cable modems), imaging devices, or storage devices. Devices are plugged directly into a 4-pin socket on your computer or into a multiport hub that plugs into your computer. USB devices can be connected and disconnected while the computer is turned on, and they can also be daisy-chained together.

**VPN** — virtual private network — A set of communication protocols that allows remote users to securely access a network.

**WAP** — wireless application protocol — A standardization for the way that wireless devices access the Internet.

# Index

## A

- ActiveSync
  - about 57
  - installing 59
- appointments
  - scheduling 63
- audio
  - Media player 91
  - notifications 76
- AvantGo
  - about 100

## B

- battery
  - backup 17
  - charging 18
  - main 16
  - using and installing 15
- block recognizer 43
- Bluetooth
  - cards 23
  - settings 55
- books
  - library 92
  - Reader 91

- books (*continued*)
  - reading ebooks 92
  - removing 95

## buttons

- about 28
- Calendar 13
- Contacts 13
- Home 13
- Inbox 13
- locations 12
- navigator 13
- power 12
- program buttons 31
- record 13
- reset 13
- scroll dial 13

## C

- Calendar
  - about 62
  - appointments 63
  - meeting requests 64
- command bar 33
- communicating
  - with other devices 105

## CompactFlash

- about 23
- installing 23
- slot 12

## computer

- connecting to 19

## Contacts

- about 65
- creating 66
- finding 66

## cradle

- connecting to a computer 19

## D

### data

- backing up 37

### disconnecting

- dial-up connection 110
- from a cable or cradle 110
- from a network 110
- infrared sensor 110

### drawing

- creating 48

## E

### editing

- written text 45

### e-mail

- composing messages 73
- connecting to a server 71, 111

### e-mail *(continued)*

- Inbox 70
- message list 71
- organizing 75
- synchronizing 70

### ethernet connection 108

### Excel

- about 86
- tips 88

### expansion slots

- CompactFlash 23
- locations 12
- Secure Digital card slot 24

## F

### files

- backing up 37
- File Explorer 80
- finding 80
- finding and organizing 36
- synchronizing 57

### finding information 9

- contacting Dell 128

## H

### help

- ActiveSync Help 111
- contacting Dell 128
- finding 111
- Pocket PC Help 9

## **I**

### icons

- program 32
- status 30

### Inbox

- about 70

### infrared

- using 106

### input panel 40

### Internet

- connecting to 105

### Internet Explorer

- about 97
- browsing the web 101
- favorite links 100
- mobile favorites 98, 100

## **K**

### keyboard

- soft 42

## **L**

### letter recognizer 42

## **M**

### Media Player

- about 91

### meeting requests

- creating 64

### memory

- conserving 99

### microphone

- recording a message 50

### modem connection 107

### MSN Messenger

- about 89
- setting up 89
- working with contacts 90

### My Text

- inserting 51

## **N**

### navigation bar 33

### network

- connecting to 105

### Notes

- creating 68

### notifications

- about 76

## **P**

### Pocket Outlook

- about 62

### Pocket PC

- getting started 27

- pop-up menus 35
- print-style text
  - converting written text to 42, 43
- programs
  - accessing 31
  - ActiveSync 57
  - adding and removing 77
  - adding programs using
    - ActiveSync 78
  - AvantGo 100
  - Calendar 62
  - Contacts 65
  - downloading 79
  - Inbox 70
  - Media Player 91
  - MSN Messenger 89
  - Notes 68
  - Pocket Excel 86
  - Pocket Internet Explorer 97
  - Pocket Outlook 62
  - Pocket Word 84
  - Reader 91
  - removing 81
  - Start menu 80
  - Switcher Bar 32
  - Tasks 67

## R

- Reader
  - about 91
  - features 93

- recording
  - voice messages 50
- reminders. *See* notifications
- reset
  - button 13
  - performing 24
- resources
  - finding 9

## S

- scroll dial 13
- Secure Digital card slot
  - about 24
  - installing cards 24
  - location 12
- service tag 9, 16
- settings
  - adjusting 53
  - Connections tab 55
  - Personal tab 54
  - System tab 54
- software. *See* programs
- specifications 114
- stylus
  - using 28
  - writing methods 39
- Switcher Bar 32
- sync cable
  - connecting to a computer 22



synchronizing  
with your computer 19

## T

### Tasks

about 67  
creating 67

### text

converting written text to  
print-style text 42, 43  
editing 44, 45  
input panel 40  
typing 42  
written 42, 43, 44

Today screen 28

transcriber 43

## V

### video

Media Player 91

VPN connection 109

## W

warranty 149

### Word

about 84

### writing

block recognizer 43  
converting written text to  
print-style text 42, 43  
drawing 48  
editing 44  
letter recognizer 42  
methods 39  
on the screen 44  
transcriber 43



## Free Manuals Download Website

<http://myh66.com>

<http://usermanuals.us>

<http://www.somanuals.com>

<http://www.4manuals.cc>

<http://www.manual-lib.com>

<http://www.404manual.com>

<http://www.luxmanual.com>

<http://aubethermostatmanual.com>

Golf course search by state

<http://golfingnear.com>

Email search by domain

<http://emailbydomain.com>

Auto manuals search

<http://auto.somanuals.com>

TV manuals search

<http://tv.somanuals.com>