

Dell™ 4610X WIRELESS PLUS
Projector
User's Guide

Notes, Notices, and Cautions



NOTE: A NOTE indicates important information that helps you make better use of your projector.



NOTICE: A NOTICE indicates either potential damage to hardware or loss of data and tells you how to avoid the problem.



CAUTION: A CAUTION indicates a potential for property damage, personal injury, or death.

Information in this document is subject to change without notice.

© 2009 Dell Inc. All rights reserved.

Reproduction of these materials in any manner whatsoever without the written permission of Dell Inc. is strictly forbidden.

Trademarks used in this text: *Dell* and the *DELL* logo are trademarks of Dell Inc.; *DLP* and *DLP* logo are trademarks of TEXAS INSTRUMENTS INCORPORATED; *Microsoft* and *Windows* are either trademarks or registered trademarks of Microsoft Corporation in the United States and/or other countries.

Other trademarks and trade names may be used in this document to refer to either the entities claiming the marks and names or their products. Dell Inc. disclaims any proprietary interest in trademarks and trade names other than its own.

Model 4610X WIRELESS PLUS

May 2009 Rev. A00

Contents

| | | |
|---|----------------------------------------------------------------------------------------------------------------|-----------|
| 1 | Your Dell Projector | 6 |
| | About Your Projector | 7 |
| 2 | Connecting Your Projector | 9 |
| | Installing the Antenna | 10 |
| | Connecting to a Computer | 11 |
| | Connecting a Computer Using a VGA Cable | 11 |
| | Monitor Loop-Through Connection Using VGA Cables | 12 |
| | Connecting a Computer Using an RS232 cable | 13 |
| | Connecting a Computer Using Wireless | 14 |
| | Connecting a DVD Player | 15 |
| | Connecting a DVD Player Using an S-video Cable | 15 |
| | Connecting a DVD Player Using a Composite Video Cable | 16 |
| | Connecting a DVD Player Using a Component Video Cable | 17 |
| | Connecting a DVD Player Using an HDMI Cable | 18 |
| | Connecting to Local Area Network | 19 |
| | To project an image and control the projector that is connected to a network through an RJ45 cable. | 19 |
| | Professional Installation Options: Installation for Driving Automatic Screen | 20 |

| | |
|----------------------------------------------------------|-----------|
| Connection With Commercial RS232 Control Box | 21 |
| 3 Using Your Projector | 22 |
| Turning Your Projector On | 22 |
| Turning Your Projector Off | 22 |
| Adjusting the Projected Image | 23 |
| Raising the Projector Height | 23 |
| Lowering the Projector Height | 23 |
| Adjusting the Projector Zoom and Focus | 24 |
| Adjusting Projection Image Size | 25 |
| Using the Control Panel | 27 |
| Using the Remote Control | 29 |
| Installing the Remote Control Batteries | 32 |
| Operating Range With Remote Control | 33 |
| Using the On-Screen Display | 34 |
| Main Menu | 34 |
| AUTO-ADJUST | 34 |
| INPUT SELECT | 35 |
| PICTURE (in PC Mode) | 36 |
| PICTURE (in Video Mode) | 37 |
| DISPLAY (in PC Mode) | 38 |
| DISPLAY (in Video Mode) | 40 |
| LAMP | 41 |
| SET UP | 41 |
| INFORMATION | 44 |

| | | |
|---|-------------------------------------------------------------|-----------|
| | OTHERS | 44 |
| | Wireless Networking Installation | 51 |
| | 4610X WIRELESS PLUS | |
| | Wireless Application Software | 55 |
| | Managing the Projector From Web Management | 59 |
| | Configuring the Network Setting | 59 |
| | Accessing Web Management | 59 |
| | Make Application Token | 78 |
| 4 | Troubleshooting Your Projector | 79 |
| | Guiding Signals | 83 |
| | Changing the Lamp | 85 |
| 5 | Specifications | 87 |
| 6 | Contacting Dell | 92 |
| 7 | Appendix: Glossary | 93 |

Your Dell Projector

Your projector comes with all the items shown below. Ensure that you have all the items, and contact Dell™ if anything is missing.

Package Contents

Power cable



1.8m VGA cable (VGA to VGA)



Antenna



Remote control



CD User's Guide & Documentation



Carrying case



AAA Batteries (2)



About Your Projector

Top View

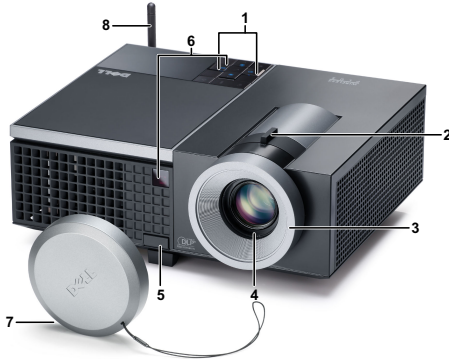

Bottom View

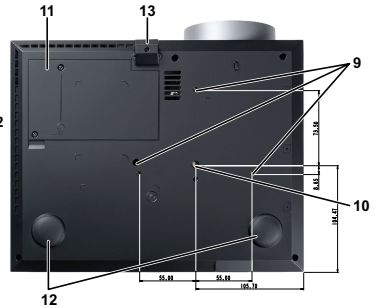

| | |
|----|-----------------------------------------------------------------------------------------------|
| 1 | Control panel |
| 2 | Zoom tab |
| 3 | Focus ring |
| 4 | Lens |
| 5 | Elevator button for height adjustments |
| 6 | IR receivers |
| 7 | Lens cap |
| 8 | Antenna |
| 9 | Mounting holes for ceiling mount: Screw hole M3 x 6.5mm depth. Recommended torque <8kgf-cm |
| 10 | Mounting hole for tripod: Insert nut 1/4" * 20 UNC |
| 11 | Lamp cover |
| 12 | Tilt adjustment wheel |
| 13 | Elevator foot |

⚠ CAUTION: Safety Instructions

- 1 Do not use the projector near appliances that generate a lot of heat.
- 2 Do not use the projector in areas where there is an excessive amount of dust. The dust may cause the system to fail and the projector will automatically shutdown.
- 3 Ensure that the projector is mounted in a well-ventilated area.

- 4 Do not block the ventilation slots and openings on the projector.
- 5 Ensure the projector operates between ambient temperatures (5°C to 35°C).
- 6 Do not try to touch the ventilation outlet as it can become very hot after the projector has been turned on or immediately after it is turned off.
- 7 Do not look into the lens while the projector is on as it may cause injury to your eyes.
- 8 Do not place any objects near or in front of the projector or cover its lens while the projector is on as the heat may cause the object to melt or burn.
- 9 Do not use the wireless projector near cardiac pacemakers.
- 10 Do not use the wireless projector near medical equipment.
- 11 Do not use the wireless projector near microwave ovens.



NOTE:

- Do not attempt to ceiling mount the projector yourself. It should be installed by a qualified technician.
- Recommended Projector Ceiling Mount Kit (P/N: C3505). For more information, see the Dell Support website at support.dell.com.
- For more information, see the *Safety Information* that shipped with your projector.

Connecting Your Projector

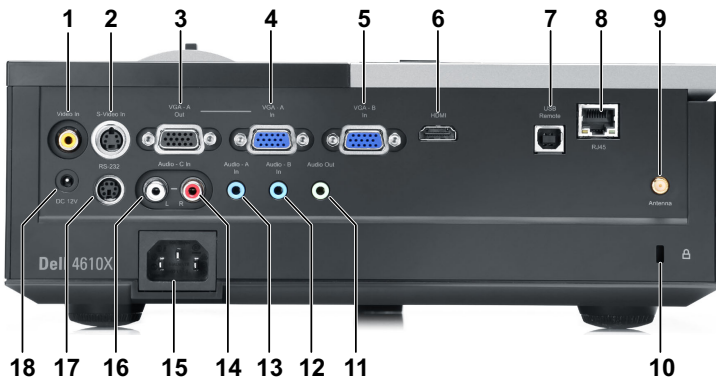

| | | | |
|---|----------------------------------------|----|------------------------------------------|
| 1 | Composite video connector | 10 | Security cable slot |
| 2 | S-video connector | 11 | Audio output connector |
| 3 | VGA-A output (monitor loop-through) | 12 | Audio-B input connector |
| 4 | VGA-A input (D-sub) connector | 13 | Audio-A input connector |
| 5 | VGA-B input (D-sub) connector | 14 | Audio-C right-channel input connector |
| 6 | HDMI connector | 15 | Power cord connector |
| 7 | USB remote connector | 16 | Audio-C left-channel input connector |
| 8 | RJ45 connector | 17 | RS232 connector |
| 9 | Antenna connector | 18 | +12V DC out connector |



CAUTION: Before you begin any of the procedures in this section, follow the Safety Instructions as described on page 7.

Installing the Antenna

Your projector comes with a wireless antenna for wireless networking. Refer to "Wireless Networking Installation" on page 51.

- 1 Screw the antenna to the antenna connector at the back of your projector.

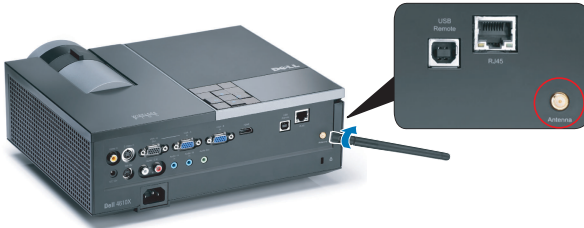

- 2 Raise the antenna to position as shown.



Connecting to a Computer

Connecting a Computer Using a VGA Cable



| | |
|---|----------------------|
| 1 | Power cord |
| 2 | VGA to VGA cable |
| 3 | USB-A to USB-B cable |



NOTE: The USB cable is not provided with your projector.



NOTE: The USB cable must be connected if you want to use the Page Up and Page Down features on the remote control.

Monitor Loop-Through Connection Using VGA Cables

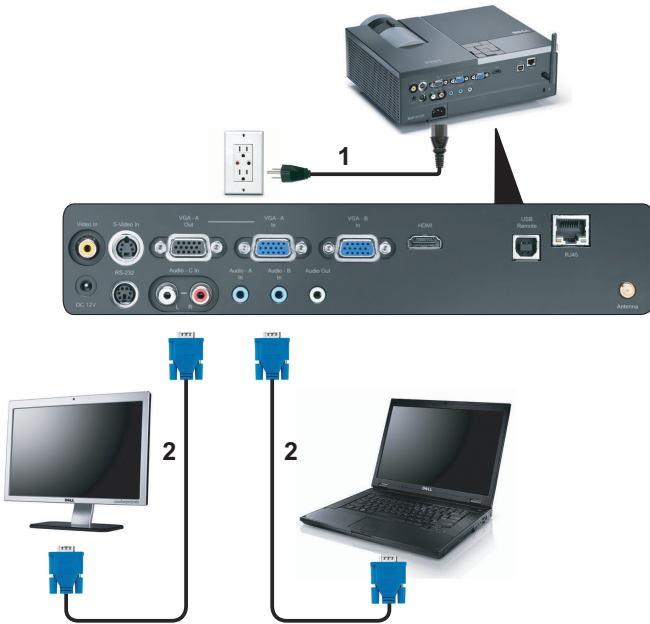

| | |
|---|------------------|
| 1 | Power cord |
| 2 | VGA to VGA cable |



NOTE: Only one VGA cable is shipped with your projector. An additional VGA cable can be purchased on the Dell website at dell.com.

Connecting a Computer Using an RS232 cable





| | |
|---|-------------|
| 1 | Power cord |
| 2 | RS232 cable |

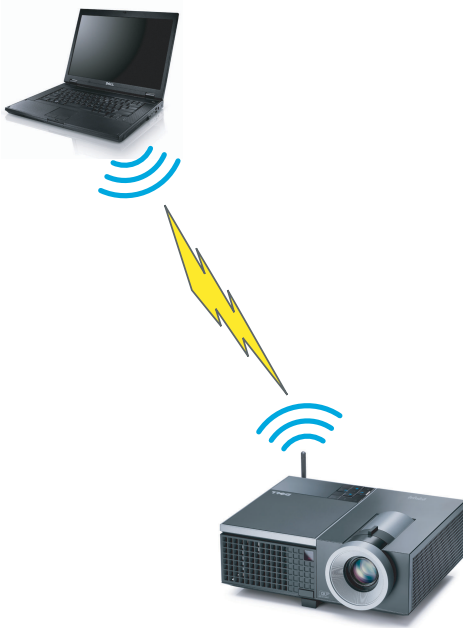

NOTE: The RS232 cable is not shipped with your projector. Consult a professional installer for the cable and RS232 remote control software.

Connecting a Computer Using Wireless



 **NOTE:** Your computer must have wireless function and should be configured properly to detect the wireless connection. Refer to your computer's documentation on how to configure wireless connection.

Connecting a DVD Player

Connecting a DVD Player Using an S-video Cable



| | |
|---|---------------|
| 1 | Power cord |
| 2 | S-video cable |



NOTE: The S-video cable is not shipped with your projector. You can purchase the S-Video extension (50 ft/100 ft) cable on the Dell website at dell.com.

Connecting a DVD Player Using a Composite Video Cable



| | |
|---|-----------------------|
| 1 | Power cord |
| 2 | Composite video cable |



NOTE: The Composite Video cable is not shipped with your projector. You can purchase the Composite Video Extension (50 ft/100 ft) cable on the Dell website at dell.com.

Connecting a DVD Player Using a Component Video Cable

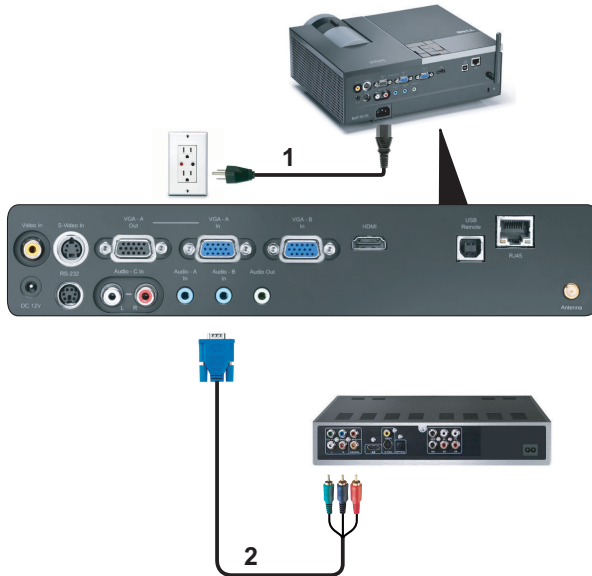

| | |
|---|------------------------------|
| 1 | Power cord |
| 2 | VGA to Component Video cable |



NOTE: The VGA to Component Video cable is not shipped with your projector. You can purchase the VGA to Component Video Extension (50 ft/100 ft) cable on the Dell website at dell.com.

Connecting a DVD Player Using an HDMI Cable



| | |
|---|------------|
| 1 | Power cord |
| 2 | HDMI cable |



NOTE: The HDMI cable is not shipped with your projector.

Connecting to Local Area Network

To project an image and control the projector that is connected to a network through an RJ45 cable.

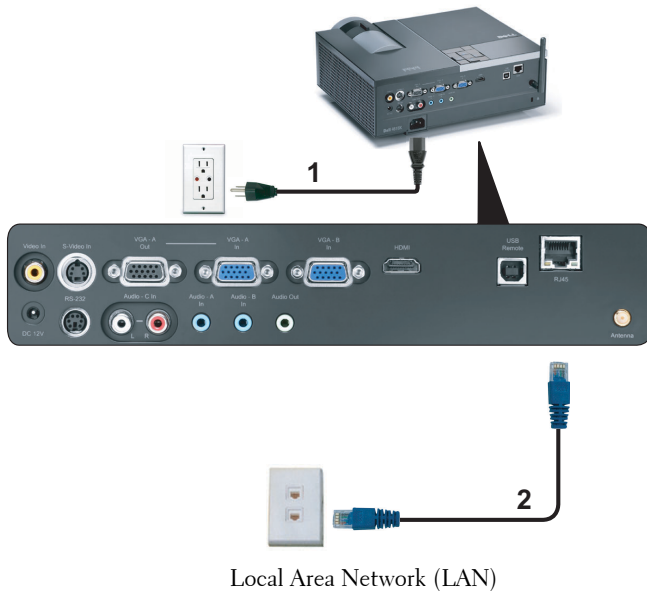

| | |
|---|------------|
| 1 | Power cord |
| 2 | RJ45 cable |



NOTE: The RJ45 cable is not shipped with your projector.

Professional Installation Options: Installation for Driving Automatic Screen

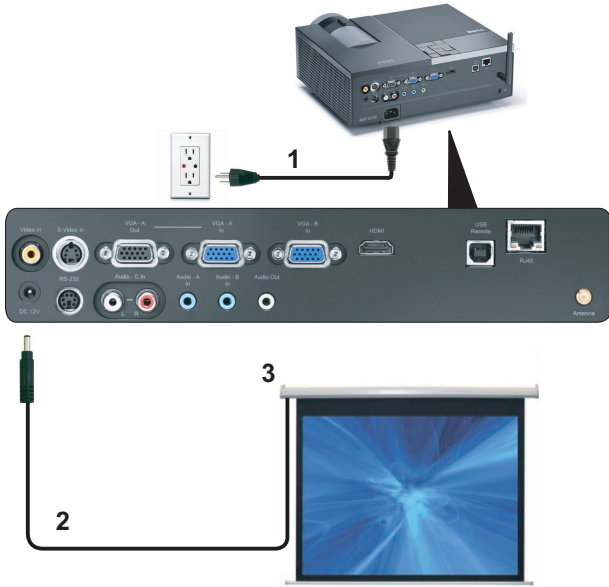

| | |
|---|------------------|
| 1 | Power cord |
| 2 | 12V DC Plug |
| 3 | Automatic Screen |



NOTE: Use the dimension of 12V DC plug in 1.7 mm (ID) x 4.00 mm (OD) x 9.5 mm (shaft) to connect the automatic screen with the projector.

12V DC Plug



Connection With Commercial RS232 Control Box

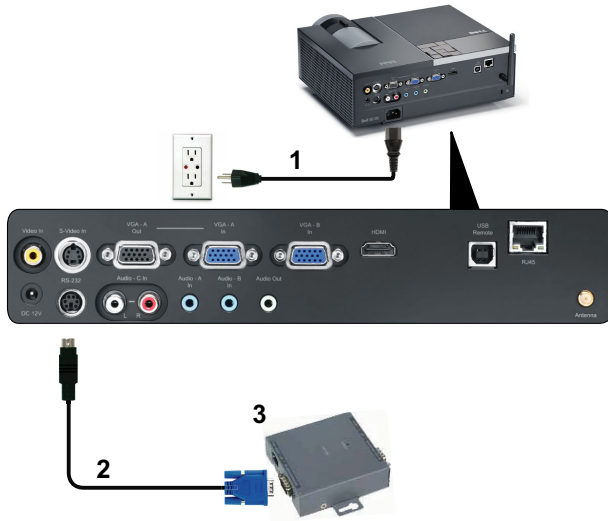

| | |
|---|------------------------------|
| 1 | Power cord |
| 2 | RS232 cable |
| 3 | Commercial RS232 control box |



NOTE: The RS232 cable is not shipped with your projector. Consult a professional technician to obtain the cable.

Using Your Projector

Turning Your Projector On

 **NOTE:** Turn on the projector before you turn on the source (computer, DVD player, etc.). The **Power** button light blinks blue until pressed.

- 1 Remove the lens cap.
- 2 Connect the power cord and appropriate signal cables. For information about connecting the projector, see "Connecting Your Projector" on page 9.
- 3 Press the **Power** button (see "Using the Control Panel" on page 27 to locate the **Power** button).
- 4 Turn on your source (computer, DVD player, etc.)
- 5 Connect your source to the projector using the appropriate cable. See "Connecting Your Projector" on page 9 for instructions to connect your source to the projector.
- 6 By default, the input source of projector is set to VGA-A. Change the input source of projector if necessary.
- 7 If you have multiple sources connected to the projector, press the **Source** button on the remote control or control panel to select the desired source. See "Using the Control Panel" on page 27 and "Using the Remote Control" on page 29 to locate the **Source** button.

Turning Your Projector Off

 **NOTICE:** Unplug the projector after properly shutting down as explained in the following procedure.

- 1 Press the **Power** button.

 **NOTE:** The "**Press Power Button to Turn off Projector**" message will appear on the screen. The message disappears after 5 seconds or you can press the **Menu** button to clear it.

- 2 Press the **Power** button again. The cooling fans continue to operate for 120 seconds.

3 To power off the projector quickly, press the Power button and hold for 1 second while the projector's cooling fans are still running.

 **NOTE:** Before you turn on the projector again, wait for 60 seconds to allow the internal temperature to stabilize.

4 Disconnect the power cord from the electrical outlet and the projector.

Adjusting the Projected Image

Raising the Projector Height

- 1 Press the Elevator button.
- 2 Raise the projector to the desired display angle, and then release the button to lock the elevator foot into position.
- 3 Use the tilt adjustment wheel to fine-tune the display angle.

Lowering the Projector Height

- 1 Press the Elevator button.
- 2 Lower the projector, and then release the button to lock the elevator foot into position.



| | |
|---|------------------------------------------------|
| 1 | Elevator button |
| 2 | Elevator foot (Angle of tilt: 0 to 9,5 degree) |
| 3 | Tilt adjustment wheel |

Adjusting the Projector Zoom and Focus

⚠ CAUTION: To avoid damaging the projector, ensure that the zoom lens and elevator foot are fully retracted before moving the projector or placing the projector in its carrying case.

- 1 Rotate the zoom tab to zoom in and out.
- 2 Rotate the focus ring until the image is clear. The projector focuses at distances ranging between 3.94 ft to 32.81 ft (1.2 m to 10 m).



| | |
|---|------------|
| 1 | Zoom tab |
| 2 | Focus ring |

Adjusting Projection Image Size

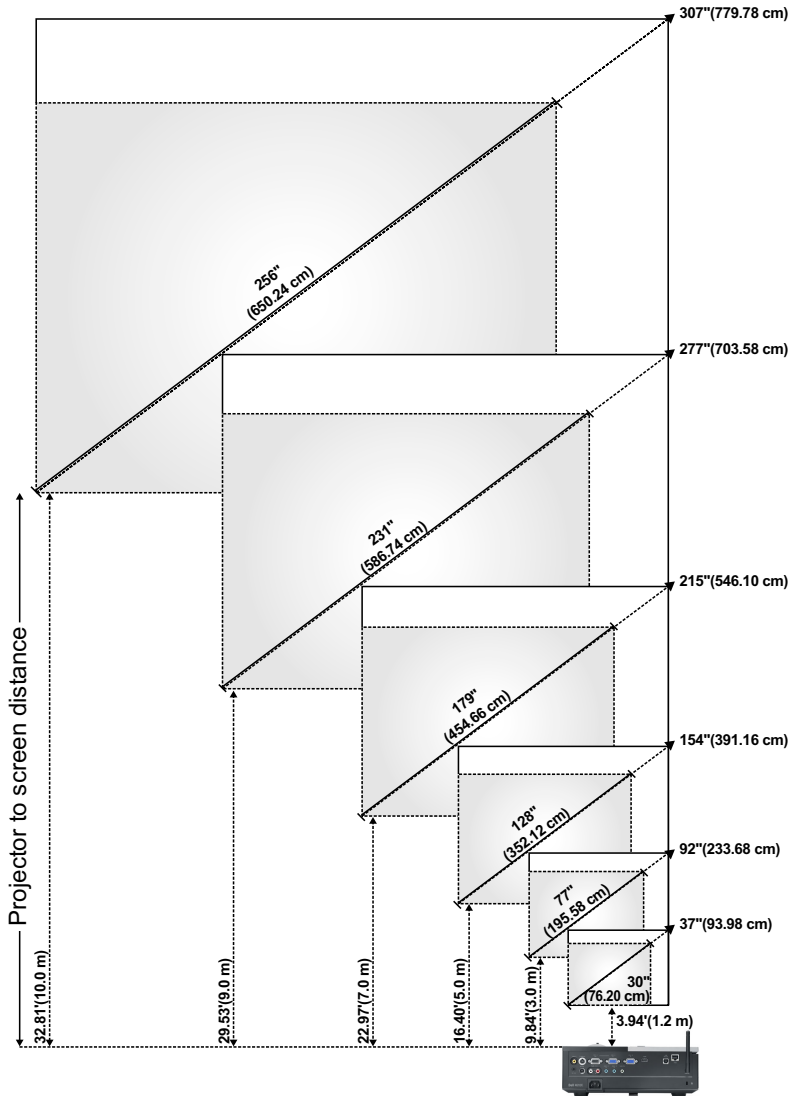

| | | | | | | | |
|------------------------------------------|------------|-----------------|-------------------|-------------------|-------------------|-------------------|-------------------|
| Screen (Diagonal) | Max. | 37" (93.98 cm) | 92" (233.68 cm) | 154" (391.16 cm) | 215" (546.10 cm) | 277" (703.58 cm) | 307" (779.78 cm) |
| | Min. | 30" (76.20 cm) | 77" (195.58 cm) | 128" (352.12 cm) | 179" (454.66 cm) | 231" (586.74 cm) | 256" (650.24 cm) |
| Screen Size | Max. (WxH) | 29.53" X 22.05" | 74.02" X 55.51" | 123.23" X 92.13" | 172.44" X 129.13" | 221.65" X 166.14" | 246.06" X 184.65" |
| | | (75 cm X 56 cm) | (188 cm X 141 cm) | (313 cm X 234 cm) | (438 cm X 328 cm) | (563 cm X 422 cm) | (625 cm X 469 cm) |
| | Min. (WxH) | 24.8" X 18.5" | 61.42" X 46.06" | 102.36" X 76.77" | 143.70" X 107.48" | 184.65" X 138.58" | 205.12" X 153.94" |
| | | (63 cm X 47 cm) | (156 cm X 117 cm) | (260 cm X 195 cm) | (365 cm X 273 cm) | (469 cm X 352 cm) | (521 cm X 391 cm) |
| Hd | Max. | 25.59" (65 cm) | 63.78" (162 cm) | 106.30" (270 cm) | 148.43" (377 cm) | 190.94" (485 cm) | 212.20" (539 cm) |
| | Min. | 21.26" (54 cm) | 53.15" (135 cm) | 88.58" (225 cm) | 123.62" (314 cm) | 159.06" (404 cm) | 176.77" (449 cm) |
| Distance | | 3.94' (1.2 m) | 9.8' (3.0 m) | 16.4' (5.0 m) | 23.0' (7.0 m) | 29.5' (9.0 m) | 32.81' (10.0 m) |
| * This graph is for user reference only. | | | | | | | |

Using the Control Panel

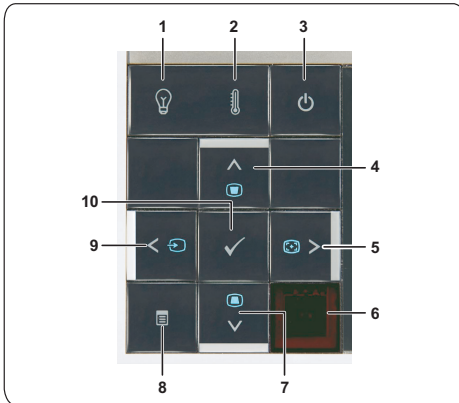

1 LAMP warning light

If the LAMP amber indicator is on or blinking, one of the following problems could be occurring:

- Lamp is reaching its end of usable life
- Lamp module is not properly installed
- Lamp driver failure
- Color wheel failure

For more information, see "Troubleshooting Your Projector" on page 79 and "Guiding Signals" on page 83.

2 TEMP warning light







If the TEMP amber indicator is on or blinking, one of the following problems could be occurring:

- Internal temperature of the projector is too high
- Color wheel failure

For more information, see "Troubleshooting Your Projector" on page 79 and "Guiding Signals" on page 83.





3 Power



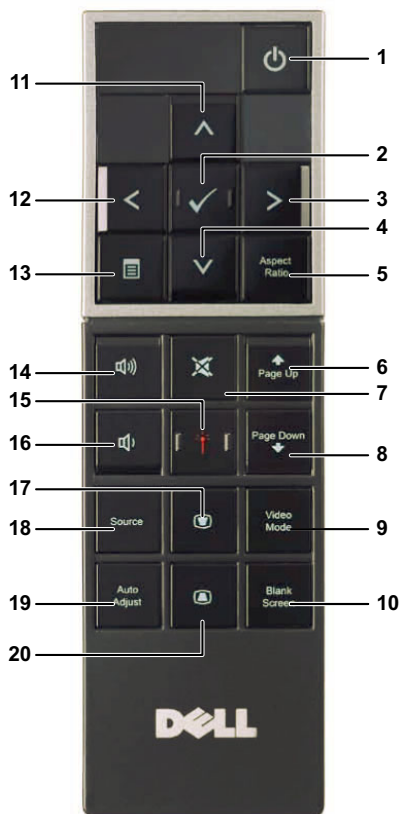









Turns the projector on or off. For more information, see "Turning Your Projector On" on page 22 and "Turning Your Projector Off" on page 22.

| | | |
|----|--------------------------------------------------------------------------------------------------------------|-------------------------------------------------------------------------------------------------------------------------------------------------------------------------------------------------------------------------------------------------------------------------------------------------------------------------|
| 4 | Up  / Keystone adjustment | <p>Press to navigate through the On-Screen Display (OSD) Menu items.</p> <p>Press to adjust image distortion caused by tilting the projector (+40/-35 degrees).</p> |
| 5 | Right  / Auto Adjust | <p>Press to navigate through the On-Screen Display (OSD) Menu items.</p> <p>Press to synchronize the projector to the input source.</p> <p> NOTE: Auto Adjust does not operate if the on-screen display (OSD) is displayed.</p> |
| 6 | IR Receiver | <p>Point the remote control towards the IR receiver and press a button.</p> |
| 7 | Down  / Keystone adjustment | <p>Press to navigate through the On-Screen Display (OSD) Menu items.</p> <p>Press to adjust image distortion caused by tilting the projector (+40/-35 degrees).</p> |
| 8 | Menu  | <p>Press to activate the OSD. Use the directional keys and the Menu button to navigate through the OSD.</p> |
| 9 | Left  / Source | <p>Press to navigate through the On-Screen Display (OSD) Menu items.</p> <p>Press to toggle through Analog RGB, Composite, Component (YPbPr via VGA), HDMI, and S-video sources when multiple sources are connected to the projector.</p> |
| 10 | Enter  | <p>Press to confirm the selection item.</p> |

Using the Remote Control



| | | |
|---|-------------------------------------------------------------------------------------------|----------------------------------------------------------------------------------------------------------------------------------------------|
| 1 | Power  | Turns the projector on or off. For more information, see "Turning Your Projector On" on page 22 and "Turning Your Projector Off" on page 22. |
| 2 | Enter  | Press to confirm the selection. |
| 3 | Right  | Press to navigate through the On-Screen Display (OSD) Menu items. |
| 4 | Down  | Press to navigate through the On-Screen Display (OSD) Menu items. |

| | | |
|----|---------------------------------------------------------------------------------------------------------|-----------------------------------------------------------------------------------------------------------------------------------------------------------------------------------------------------------------------------------------------------------------------------------------------------------------------------------------------------------------------------------------------------------------------------------------------------------------|
| 5 | Aspect Ratio | Press to change aspect ratio of a displayed image. |
| 6 | Page up  | Press to move to previous page.  NOTE: The USB cable must be connected if you want to use the Page Up feature. |
| 7 | Mute  | Press to mute or un-mute the projector speaker. |
| 8 | Page down  | Press to move to next page.  NOTE: The USB cable must be connected if you want to use the Page Down feature. |
| 9 | Video mode | The projector has preset configurations that are optimized for displaying data (presentation slides) or video (movies, games, etc.). Press the Video Mode button to toggle between Presentation mode , Bright mode , Movie mode , sRGB , or Custom mode . Pressing the Video Mode button once will show the current display mode. Pressing the Video Mode button again will switch between modes. |
| 10 | Blank screen | Press to hide/show the image. |
| 11 | Up  | Press to navigate through the On-Screen Display (OSD) Menu items. |
| 12 | Left  | Press to navigate through the On-Screen Display (OSD) Menu items. |
| 13 | Menu  | Press to activate the OSD. |
| 14 | Volume up  | Press to increase the volume. |
| 15 | Laser  | Point the remote control at the screen, press and hold the laser button to activate the laser light.  CAUTION: Do not look at the laser point when it is active. Avoid directing the laser light on your eyes. |
| 16 | Volume down  | Press to decrease the volume. |
| 17 | Keystone adjustment  | Press to adjust image distortion caused by tilting the projector (+40/-35 degrees). |
| 18 | Source | Press to switch between Analog RGB, Composite, Component (YPbPr, via VGA), HDMI, and S-video sources. |

| | | |
|----|---------------------|-----------------------------------------------------------------------------------------------------------------|
| 19 | Auto adjust | Press to synchronize the projector with the input source. Auto adjust does not operate if the OSD is displayed. |
| 20 | Keystone adjustment | Press to adjust image distortion caused by tilting the projector (+40/-35 degrees). |



Installing the Remote Control Batteries

 **NOTE:** Remove the batteries from the remote control when not in use.

1 Press the tab to lift the battery compartment cover.



2 Check the polarity (+/-) marking on the batteries.



3 Insert the batteries and align their polarity correctly according to the marking in the battery compartment.



 **NOTE:** Avoid mixing different types of batteries or using new and old batteries together.

4 Slip the battery cover back.





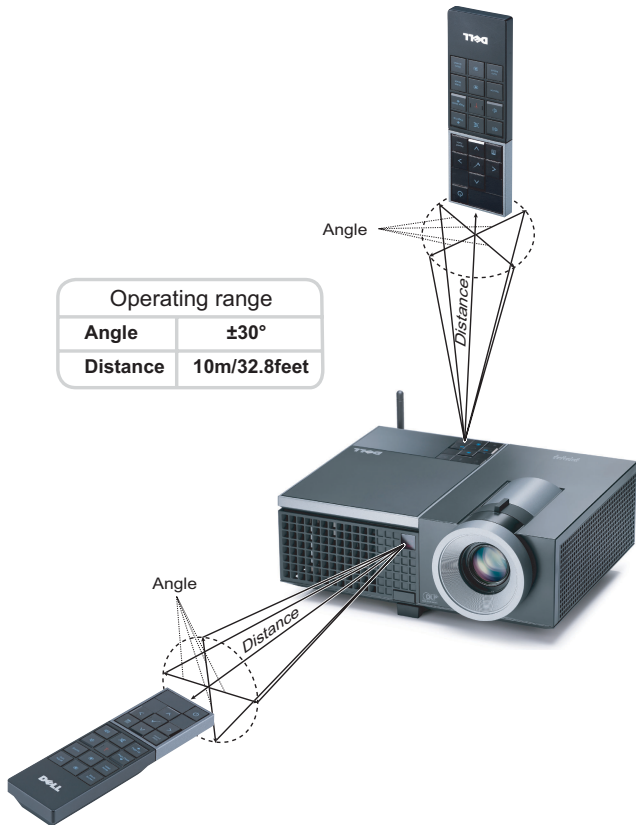





Operating Range With Remote Control



NOTE: Actual operating range may slightly differ from the diagram. Weak batteries will also prevent the remote control from properly operating the projector.

Using the On-Screen Display

- The projector has a multi-language On-Screen Display (OSD) Menu that can be displayed with or without an input source.
- To navigate through the tabs in the Main Menu, press the  or  buttons on your projectors control panel or remote control.
- To select a submenu, press the  button on your projector's control panel or remote control.
- To select an option, press the  or  buttons on your projector's control panel or remote control. The color changes to dark blue. When an item is selected, the color changes to dark blue.
- Use the  or  buttons on the control panel or remote control to adjust the settings.
- To go back to Main Menu, go to Back tab and press the  button on the control panel or the remote control.
- To exit the OSD, go to EXIT tab and press the  button or press the **Menu** button directly on the control panel or the remote control.

Main Menu



AUTO-ADJUST

Auto Adjust automatically adjusts the projector's **Frequency** and **Tracking** in PC mode. While Auto Adjustment is in progress, the following message appears on the screen:

Please wait...

INPUT SELECT

The Input Select menu allows you to select your projector's input source.

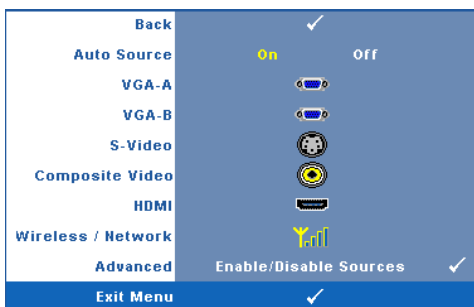

AUTO SOURCE—Select **Off** (the default) to lock the current input signal. If you press the **Source** button when the **Auto Source** mode is set to **Off**, you can manually select the input signal. Select **On** to auto detect the available input signals. If you press the **Source** button when the projector is on, it automatically finds the next available input signal.

VGA-A—Press to detect VGA-A signal.

VGA-B—Press to detect VGA-B signal.

S-VIDEO—Press to detect S-Video signal.

COMPOSITE VIDEO—Press to detect Composite Video signal.

HDMI—Press to detect HDMI signal.

WIRELESS / NETWORK—Wireless and Network must be **On**. See page 43. Press to access the projector's Wireless Guide screen.

ADVANCED—Press to activate Input Select Advanced menu.

INPUT SELECT ADVANCED

The Input Select Advanced menu allows you to enable or disable input sources.

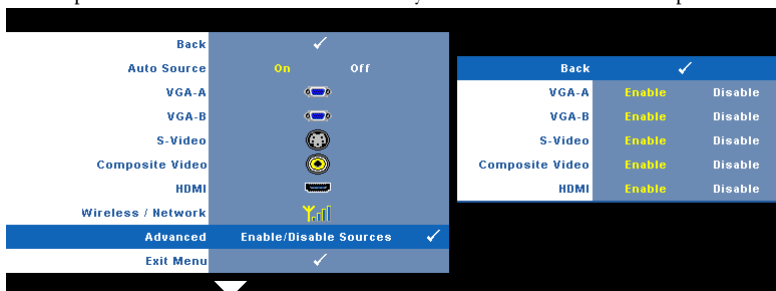

VGA-A—Use and to enable or disable VGA-A input.

VGA-B—Use and to enable or disable VGA-B input.

S-VIDEO—Use and to enable or disable S-Video input.

COMPOSITE VIDEO—Use and to enable or disable Composite Video input.

HDMI—Use and to enable or disable HDMI input.



NOTE: You cannot disable your current input source. At anytime, a minimum of two input sources have to be enabled.

PICTURE (in PC Mode)

Using the **Picture** menu, you can adjust the display settings of your projector. The **Picture** menu, provides the following options:

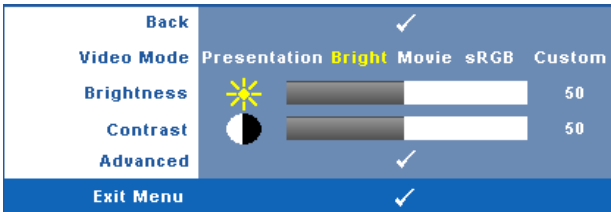

VIDEO MODE—Allows you to optimize the display image: **Presentation**, **Bright**, **Movie**, **sRGB** (provides more accurate color representation), and **Custom** (set your preferred settings).



NOTE: If you adjust the settings for **Brightness**, **Contrast**, **Saturation**, **Sharpness**, **Tint**, and **Advanced** the projector automatically switches to **Custom**.

BRIGHTNESS—Use and to adjust the brightness of the image.

CONTRAST—Use and to adjust the display contrast.

ADVANCED—Press to activate **Picture Advance** Menu. See "PICTURE ADVANCED" on page 38.

PICTURE (in Video Mode)

Using the **Picture** menu, you can adjust the display settings of your projectors. The **Picture** menu, provides the following options:

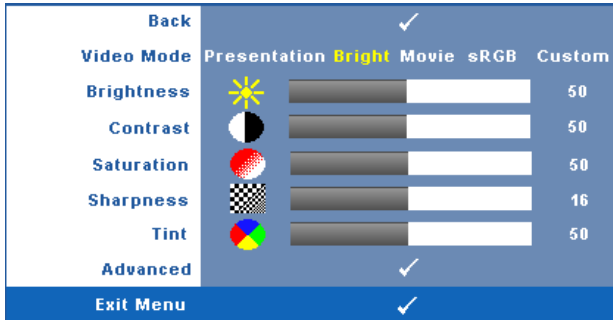

VIDEO MODE—Allows you to optimize the display image: **Presentation**, **Bright**, **Movie**, **sRGB** (provides more accurate color representation), and **Custom** (set your preferred settings).

 **NOTE:** If you adjust the settings for **Brightness**, **Contrast**, **Saturation**, **Sharpness**, **Tint**, and **Advanced**, the projector automatically switches to **Custom**.

BRIGHTNESS—Use and to adjust the brightness of the image.

CONTRAST—Use and to adjust the display contrast.

SATURATION—Allows you to adjust the video source from black and white to fully saturated color. Press to decrease the amount of color in the image and to increase the amount of color in the image.

SHARPNESS—Press to decrease the sharpness and to increase the sharpness.

TINT—Press to increase the amount of green in the image and to increase the amount of red in the image (available for NTSC only).

ADVANCED—Press to activate **Picture Advance Menu**. See "PICTURE ADVANCED" below.

 **NOTE:** **Saturation**, **Sharpness**, and **Tint** are only available when input source is from Composite or S-Video.

PICTURE ADVANCED

Using the Picture Advanced menu, you can adjust the display settings of your projector. The Picture Advanced menu provides the following options:

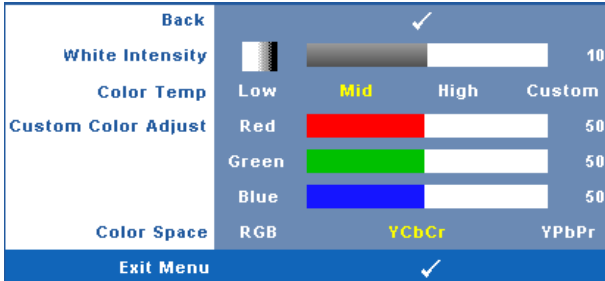

WHITE INTENSITY—Use and to adjust the display white intensity.

COLOR TEMP—Allows you to adjust the color temperature. The screen appears cooler at higher color temperatures and warmer at lower color temperatures. When you adjust the values in the **Color Adjust** menu, the Custom mode is activated. The values are saved in the Custom mode.

CUSTOM COLOR ADJUST—Allows you to manually adjust the colors red, green, and blue.



COLOR SPACE—Allows you to select the color space, options are: RGB, YCbCr, and YPbPr.

DISPLAY (in PC Mode)

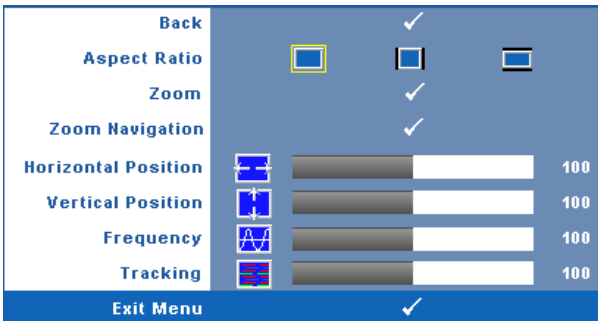
Using the Display menu, you can adjust the display settings of your projector. The Picture menu, provides the following options:



ASPECT RATIO—Allows you to select the aspect ratio to adjust how the image appears.

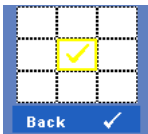

-  Original — Select Original to maintain the aspect ratio of image projected according to input source.
-  4:3 — The input source scales to fit the screen and projects a 4:3 image.
-  Wide — The input source scales to fit the width of the screen to project a wide screen image.



ZOOM—Press  to activate **Zoom** menu.

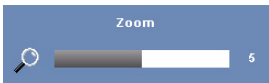



Select the area to zoom and press  to view zoomed image.







Adjust the image scale by pressing  or  and press  to view.



ZOOM NAVIGATION—Press  to activate **Zoom Navigation** menu.

Use     to navigate projection screen.

HORIZONTAL POSITION—Press  to move the image to the left and  to move the image to the right.

VERTICAL POSITION—Press  to move the image down and  to move the image up.

FREQUENCY—Allows you to change the display data clock frequency to match the frequency of your computer graphics card. If you see a vertical flickering wave, use Frequency control to minimize the bars. This is a coarse adjustment.



TRACKING—Synchronize the phase of the display signal with the graphic card. If you experience an unstable or flickering image, use **Tracking** to correct it. This is a fine adjustment.

DISPLAY (in Video Mode)

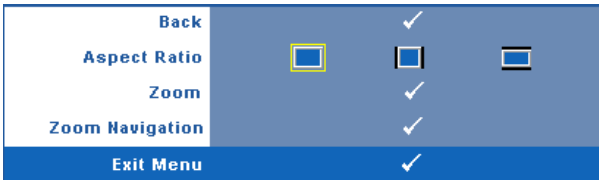
Using the **Display** menu, you can adjust the display settings of your projector. The **Picture** menu, provides the following options:





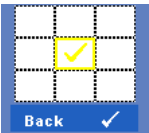

ASPECT RATIO—Allows you to select the aspect ratio to adjust how the image appears.



-  Original — Select Original to maintain the aspect ratio of image projected according to input source.
-  4:3 — The input source scales to fit the screen and projects a 4:3 image.
-  Wide — The input source scales to fit the width of the screen to project a wide screen image.



ZOOM—Press  to activate **Zoom** menu.

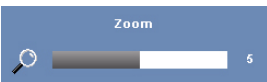



Select the area to zoom and press  to view zoomed image. Adjust the image scale by pressing  or  and press  to view.



Adjust the image scale by pressing  or  and press  to view.



ZOOM NAVIGATION—Press  to activate **Zoom Navigation** menu.

Use     to navigate projection screen.

LAMP

Using the **Lamp** menu, you can adjust the display settings of your projector. The Lamp menu provides the following options:

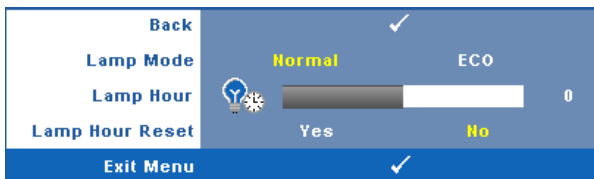

LAMP MODE—Allows you to select between Normal and ECO mode.

Normal mode operates at full power level. ECO Mode operates at a lower power level which may provide longer lamp life, quieter operation, and dimmer luminance output on the screen.

LAMP HOUR—Displays the operating hours since the last lamp timer reset.

LAMP HOUR RESET—Select **Yes** to reset the lamp timer.

SET UP



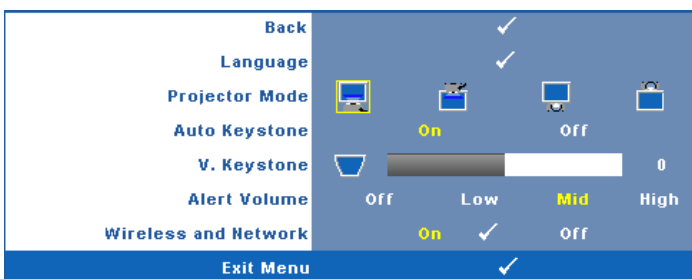

The Set Up menu allows you to adjust settings for Language, Projector Mode, Keystone, Alert Volume, and Wireless and Network.



LANGUAGE—Allows you to set the language for the OSD. Press  to activate the Language menu.



PROJECTOR MODE—Allows you to select the projector mode, depending upon how the projector is mounted.

-  Front Projection-Desktop — This is the default option.
-  Front Projection-Ceiling Mount — The projector turns the image upside down for ceiling-mounted projection.
-  Rear Projection-Desktop — The projector reverses the image so that you can project from behind a translucent screen.
-  Rear Projection-Ceiling Mount — The projector reverses and turns the image upside down. You can project from behind a translucent screen with a ceiling-mounted projection.

AUTO KEYSTONE—Select **On** to enable the auto correction for vertical image distortion caused by tilting the projector.

V. KEYSTONE—Manually adjust the vertical image distortion caused by tilting the projector.





ALERT VOLUME—Allows you to set buzzer alert loudness (Off, Low, Mid or High) for power on/off, warning and command keys.

WIRELESS AND NETWORK—Select **On** to activate wireless and network function. Press  to configure the **Wireless and Network** settings.

WIRELESS AND NETWORK

The **Wireless and Network** menu allows you to configure the network connection settings.

| | | |
|--------------------|---------------------|-------------------|
| Back | | ✓ |
| DHCP | On | Off |
| IP Address | 192 . 168 . 4 . 137 | |
| Subnet Mask | 255 . 255 . 255 . 0 | |
| Gateway | 192 . 168 . 4 . 137 | |
| DNS | 192 . 168 . 1 . 4 | |
| Store | | ✓ |
| Wireless | Connect | Disconnect |
| Reset | | ✓ |
| Exit Menu | | ✓ |

DHCP—If a DHCP server exists in the network to which the projector is connected, the IP address will automatically be acquired when you select **DHCP On**. If **DHCP** is **Off**, manually set the **IP Address**, **Subnet Mask**, and **Gateway**. Use   to select the number of **IP Address**, **Subnet Mask**, and **Gateway**. Key in **Enter** to confirm each number and then use   to set the next item.

IP ADDRESS—Automatically or manually assigns the IP address to the projector connected to the network.

SUBNET MASK—Configure the Subnet Mask of the network connection.

GATEWAY—Check the Gateway address with your network/system administrator if you configure it manually.

DNS—Check the DNS Server IP address with your network/system administrator if you configure it manually.

STORE—Press  to save the changes made in network configuration settings.

WIRELESS—Default is **Connect**. Select **Disconnect** to disable the wireless connection to use LAN networking only.



NOTE: It is recommended to use the default settings for **Wireless Connect**.

RESET—Press  to reset network configuration.

INFORMATION

The Information menu displays the current projector settings.





| | |
|----------------|--------------------------|
| Back | ✓ |
| Model Name | 4610X WIRELESS PLUS |
| Input Source | ANALOG RGB 1024X768 60Hz |
| Operating Hour | 10 hr |
| PPID | CN-0U812M-S0081-46B-0208 |
| IP Address | 192.168.4.137 |
| SSID | DELL 4610X Projector |
| Exit Menu | ✓ |

OTHERS

The Others menu allows you to change settings for Menu, Screen, Audio, Power, Security, and Closed Caption (for NTSC only). You can also perform Test Pattern and Factory Reset.

| | |
|-------------------|-------------|
| Back | ✓ |
| Menu Settings | ✓ |
| Screen Settings | ✓ |
| Audio Settings | ✓ |
| Power Settings | ✓ |
| Security Settings | ✓ |
| Closed Caption | On ✓ Off |
| Test Pattern | Off 1 ✓ 2 ✓ |
| Factory Reset | ✓ |
| Exit Menu | ✓ |

MENU SETTINGS—Select and press  to activate menu settings. The menu settings consists of the following options:

| | |
|-------------------|-------------------------------------------------------------------------------------------------------------------------------------------------------------------------|
| Back | ✓ |
| Menu Position |   |
| Menu Transparency |  0 |
| Menu Timeout |  20 |
| Menu Lock | On Off |
| Exit Menu | ✓ |

MENU POSITION—Allows you to change the position of the OSD menu on the screen.

MENU TRANSPARENCY—Select to change the transparency level of the OSD background.

MENU TIMEOUT—Allows you to adjust the time for an OSD timeout. By default, the OSD disappears after 20 seconds of non-activity.

MENU LOCK—Select **On** to enable Menu Lock and hide the OSD menu. Select **OFF** to disable the Menu Lock. If you want to disable the Menu Lock function and have the OSD disappear, press the **Menu** button on the control panel or remote control for 15 seconds, then disable the function.

SCREEN SETTINGS—Select and press to activate screen settings. The screen settings menu consists of the following options:



CAPTURE SCREEN—Select and press to capture the screen display, the following message appears on the screen.



 **NOTE:** To capture a full image, ensure the input signal that is connected to the projector is 1024 x 768 resolution.



SCREEN—Select **Dell** to use the Dell logo as wallpaper. Select **Captured** to set the captured image as wallpaper.

RESET—Select and press to delete the captured picture and set back to the default setting.

AUDIO SETTINGS—Select and press  to change audio settings. The audio settings menu consists of the following options:



AUDIO INPUT—Select the Audio input source, options are: Audio-A, Audio-B, Audio-C, and HDMI.

VOLUME—Press  to decrease the volume and  to increase the volume.

SPEAKER—Select **On** to enable speaker. Select **Off** to disable speaker.

MUTE—Allows you to mute the sounds for audio input and audio output.

POWER SETTINGS—Select and press  to activate power settings. The power settings menu consists of the following options:

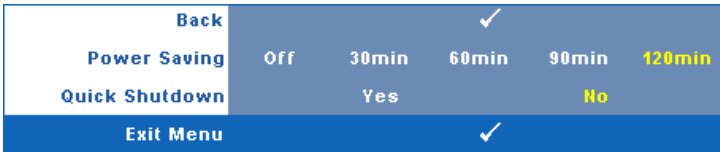

POWER SAVING—Select **Off** to disable Power Saving mode. By default, the projector is set to enter power saving mode after 120 minutes of no activity. A warning message appears on screen showing a 60-second countdown before switching to power saving mode. Press any key buttons during countdown period to stop power saving mode.

You can also set a different delay period to enter power saving mode. The delay period is the time you want the projector to wait without an input signal. Power saving can be set to 30, 60, 90, or 120 minutes.

If an input signal is not detected during the delay period, the projector turns off the lamp and goes into power saving mode. If an input signal is detected within the delay period, the projector automatically turns on. If an input signal is not detected within two hours during power saving mode, the projector switches from Power Saving mode to Power Off mode. To turn on the projector press the Power button.

QUICK SHUTDOWN—Select **Yes** to turn off the projector with a single press of the **Power** button. This function allows the projector to quick power off with an accelerated fan speed. Slightly higher acoustic noise is expected during quick power off.

 **NOTE:** Before you turn on the projector again, wait for 60 seconds to allow the internal temperature to stabilize. The projector will take a longer time to turn on if you try to power on immediately. Its cooling fan will run at full speed for about 30 seconds to stabilize the internal temperature.

SECURITY SETTINGS—Select and press to activate security settings. The security settings menu allows you to enable and set password protection.

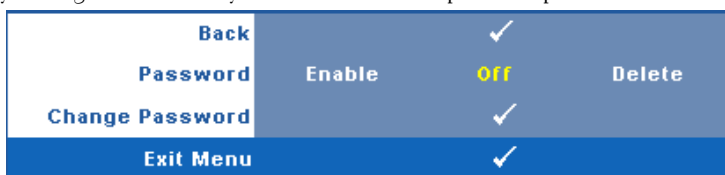

PASSWORD—When Password Protect is enabled, a Password Protect screen requesting you to enter a password will be displayed when the power plug is inserted into the electrical outlet and the power for the projector is first turned on. By default, this function is disabled. You can enable this feature, by selecting **Enabled**. If the password has been set before, key in the password first and select the function. This password security feature will be activated the next time you turn on the projector. If you enable this feature, you will be asked to enter the projector's password after you turn on the projector:

- 1 First time password input request:
 - a Go to **Others** menu, press and then select **Password** to **Enable** the password setting.

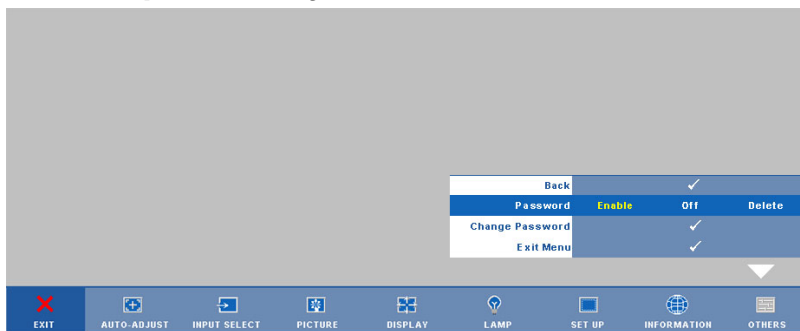

- b Enabling the Password function will pop up a character screen, key in a 4-digit number from the screen and press .

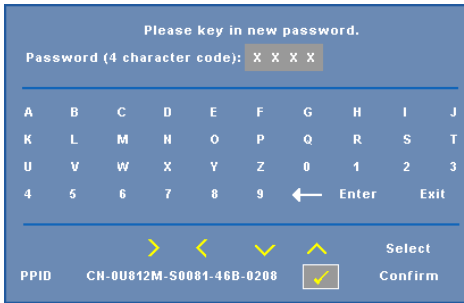

- c To confirm, enter the password again.
- d If the password verification is successful, you may resume with accessing the projector's functions and its utilities.
- 2 If you have entered an incorrect password, you will be given another 2 chances. After the three invalid attempts, the projector will automatically turn off.



NOTE: If you forget your password, contact DELL™ or a qualified service personnel.

- 3 To disable the password function, select **Off** to disable the function.
- 4 To delete the password, select **Delete**.

CHANGE PASSWORD—Key in the original password, then enter the new password and confirm the new password again.

Please key in the original password.

Password (4 character code): X X X X

| | | | | | | | | | |
|---|---|---|---|---|---|---|-------|------|---|
| A | B | C | D | E | F | G | H | I | J |
| K | L | M | N | O | P | Q | R | S | T |
| U | V | W | X | Y | Z | 0 | 1 | 2 | 3 |
| 4 | 5 | 6 | 7 | 8 | 9 | ← | Enter | Exit | |

>
<
✓
⬆
Select

PPID CN-0U842M-S0081-46B-0208 Confirm

Please key in new password.

Password (4 character code): X X X X

| | | | | | | | | | |
|---|---|---|---|---|---|---|-------|------|---|
| A | B | C | D | E | F | G | H | I | J |
| K | L | M | N | O | P | Q | R | S | T |
| U | V | W | X | Y | Z | 0 | 1 | 2 | 3 |
| 4 | 5 | 6 | 7 | 8 | 9 | ← | Enter | Exit | |

>
<
✓
⬆
Select

PPID CN-0U842M-S0081-46B-0208 Confirm

Please key in new password again.

Password (4 character code): X X X X

| | | | | | | | | | |
|---|---|---|---|---|---|---|-------|------|---|
| A | B | C | D | E | F | G | H | I | J |
| K | L | M | N | O | P | Q | R | S | T |
| U | V | W | X | Y | Z | 0 | 1 | 2 | 3 |
| 4 | 5 | 6 | 7 | 8 | 9 | ← | Enter | Exit | |

>
<
✓
⬆
Select





PPID CN-0U842M-S0081-46B-0208 Confirm

CLOSED CAPTION—Select **On** to enable close caption and activate the closed caption menu. Select an appropriate closed captions option: CC1, CC2, CC3, and CC4.

| | |
|-----------|-----------------------------------------------------------|
| Back | ✓ |
| Select | CC1 CC2 CC3 CC4 |
| Exit Menu | ✓ |

 **NOTE:** Closed caption option is available for NTSC only.

TEST PATTERN—Test Pattern is used to test focus and resolution.

You can enable or disable the **Test Pattern** by selecting **Off**, **1** or **2**. You can also invoke the **Test Pattern 1** by pressing and holding down  and  buttons on the control panel simultaneously for 2 seconds. You can also invoke the test pattern 2 by pressing and holding down  and  buttons on the control panel simultaneously for 2 seconds.

Test Pattern 1:

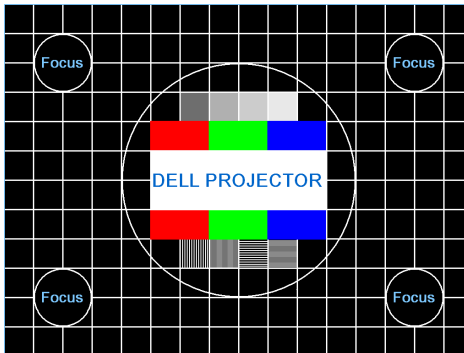

Test Pattern 2:



FACTORY RESET—Select and press  to reset all settings to its factory default, the warning message below appears.



Reset items include both computer sources and video source settings.

Wireless Networking Installation



NOTE: Your computer must have the following minimum system requirements:

Operating System:

- Windows
Microsoft Windows 2000 with service pack 4 or later, Windows XP Home or Professional Service pack 2 32-bit (recommended), and Windows Vista 32-bit
- MAC
MacBook and above, MacOS 10.5 and above

Minimum Hardware:

- a** Intel Pentium III-800 MHZ (or greater)
- b** 256MB of RAM required, 512 MB or more recommended.
- c** 10MB of available hard-disk space
- d** Super VGA supporting 800 x 600 16 bit high color or higher-resolution display recommended (PC and display)
- e** Ethernet adapter (10 / 100 bps) for an Ethernet connection
- f** A supported WLAN adapter for a WLAN connection (any NDIS-compliant 802.11b or 802.11g Wi-Fi device)

Web browser

Microsoft Internet Explorer 6.0 or 7.0 (recommended), Firefox 1.5 or 2.0, and Safari 3.0 and above

In order to use your projector wirelessly, you need to complete the steps below:

- 1 Install the wireless antenna. See "Installing the Antenna" on page 10.
- 2 Enable wireless connection on the projector. See "WIRELESS AND NETWORK" on page 43.
- 3 Set the Input Select menu to **Wireless / Network**. See "INPUT SELECT" on page 35. The **Wireless Guide Screen** shown below appears:.



- 4 Take note of the **LOGIN CODE**, **NETWORK NAME (SSID)**, and **IP ADDRESS**. You will need these information to login later.
- 5 Connect your computer to the **4610X WIRELESS PLUS** network.

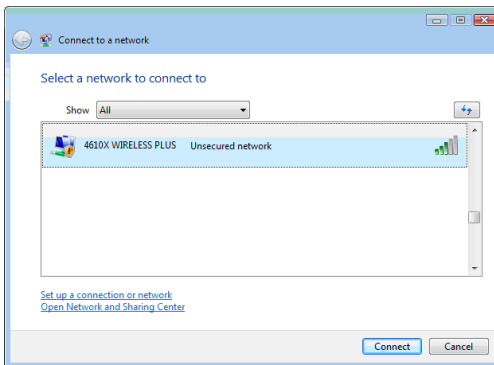

**NOTE:**

- Your computer must have wireless network function to detect the connection.
- When you connect to the **4610X WIRELESS PLUS** network, you will lose wireless connectivity with other wireless networks.

- 6 Open your internet browser. You will be automatically directed to the **4610X WIRELESS PLUS Web Management** web page.



NOTE: If the web page does not load automatically, enter the IP address noted from the projector's screen in the browser's address bar.

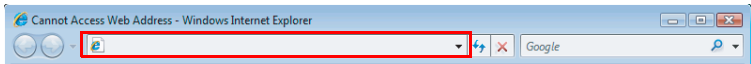

- 7 The **4610X WIRELESS PLUS Web Management** page opens. For first time use, click **Download**.



8 Select the appropriate operating system, then click **Download**.

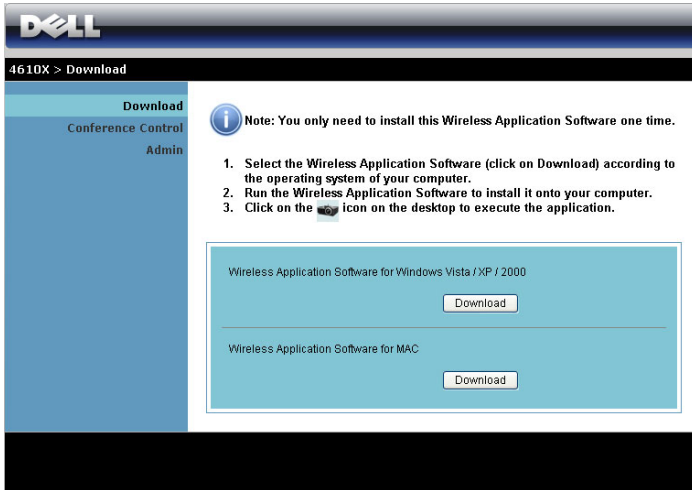

9 Click **Run** to proceed with the one-time installation of the software.



NOTE: You may choose to save the file and install it at latter time. To do this, click **Save**.

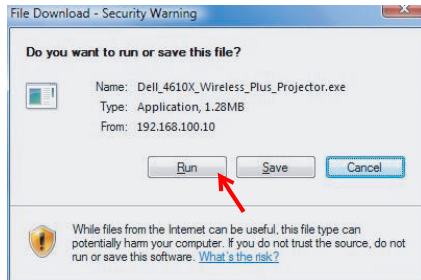

NOTE: The following warning messages may appear, select **Run** and **Allow** respectively.

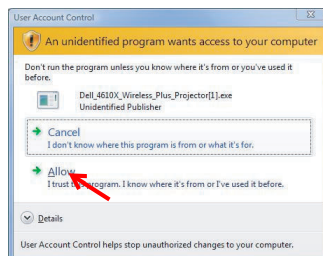
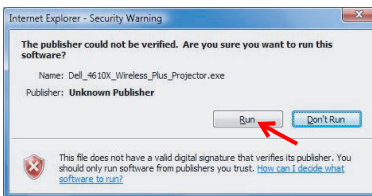

- 10 The installation software will launch. Follow the on-screen instructions to complete setup.

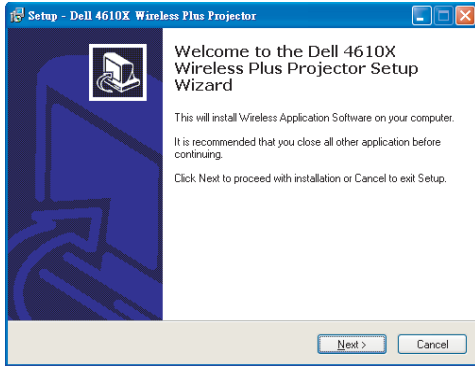

4610X WIRELESS PLUS Wireless Application Software

Once the installation is complete, 4610X WIRELESS PLUS Wireless Application software will launch and will search for the projector automatically. The screen below appears.



Login

To communicate with your projector, enter the Login Code provided for in Step 4 of "Wireless Networking Installation, then click OK.















NOTE: If IP Address is not detected, enter the IP Address displayed at the bottom left corner of the screen.





Understanding the Buttons

After a successful login, the following screen appears.



| | Item | Description |
|-------------------------------------------------------------------------------------------|-----------------------------------------------------------------------------------------------------|---------------------------------------------------------------------|
| 1 | Status Bar | Displays IP and LOGIN CODE information. |
| |  Menu | Click to activate the application menu. |
| |  Minimize button | Click to minimize the application. |
| |  Close button | Click to exit the application. |
| 2 | Controls Toolbar | |
| |  Full screen | Click to project the image in full screen. |
| |  Split 1 | Click to project the image in the upper left corner of the screen. |
| |  Split 2 | Click to project the image in the upper right corner of the screen. |
| |  Split 3 | Click to project the image in the lower left corner of the screen. |
| |  Split 4 | Click to project the image in the lower right corner of the screen. |
| |  Stop | Click to stop projection. |
| |  Pause | Click to pause projection. |
|  Refresh | Click to refresh projected image. | |
| 3 | Connection Status | |
| |  Connection Icon | Blinks when projection is in progress. |

Projecting the Presentation

- To project the presentation, click any of the projection buttons .
- To pause the presentation, click . The icon turns green.
- To continue the presentation, click  again.
- To stop the presentation, click .



NOTE: The following information is for wireless data presentation mode only. Image display could be slow or not displayed smoothly if displaying a video clip or animation, refer to the frame rate table below for reference.

Frame Rate of Wireless Presentation

| Screen Variation % ¹ | Estimated frame per second ² |
|---------------------------------|-----------------------------------------|
| <5 % | 30 ³ |
| <10% | 16 ³ |
| <20% | 12 ³ |
| <40% | 8 ³ |
| <75% | 5 ³ |
| 100% | 3 ³ |
| > 100% | ≤ 2 ⁴ |



NOTE:

- 1 The percentage of screen variation is based on 1024 x 768. Example, display a 320 x 240 video clip on 1024 x 768 desktop, the screen variation is 9.8%.
- 2 Actuate frame rate could be different depending on factors, such as network environment, image content, signal conditions, locations, and CPU performance.
- 3 Under clean WLAN environment using 802.11g connection, and no screen stretching.
- 4 Compressed to 1024 x 768 and under 802.11g.



NOTE: Your computer will not enter S1 (standby mode) / S3 (sleep mode) / S4 (hibernate mode) when running a wireless presentation.

Using the Menu

Click  to display the menu.

| |
|------------------------|
| Web Management |
| Search for Projector |
| Make Application Token |
| Info |
| About |
| Exit |

WEB MANAGEMENT—Click to open the Web Management page. See "Managing the Projector From Web Management" on page 59.

SEARCH FOR PROJECTOR—Click to search and connect to wireless projector..

MAKE APPLICATION TOKEN—Click to make application token. See "Make Application Token" on page 78.

INFO—Click to display system information.

ABOUT—Click to display the application version.

EXIT—Click to close the application.

Managing the Projector From Web Management

Configuring the Network Setting

If the projector is connected to a network, you can access the projector using a web browser. For configuring the network setting, refer to "WIRELESS AND NETWORK" on page 43.

Accessing Web Management

Use Internet Explorer 5.0 and above or Netscape Navigator 7.0 and above and enter the IP address. You can now access Web Management and manage the projector from a remote location.

Home Page



- Access the Web Management Home page by entering the projector's IP address at the web browser. See "WIRELESS AND NETWORK" on page 43.
- Select the language for web management from the list.
- Click any menu item on the left tab to access the page.

Download the Wireless Application Software

See also "Wireless Networking Installation" on page 51.

DELL

4610X > Download

Download
Conference Control
Admin

i Note: You only need to install this Wireless Application Software one time.

1. Select the **Wireless Application Software** (click on **Download**) according to the operating system of your computer.
2. Run the **Wireless Application Software** to install it onto your computer.
3. Click on the  icon on the desktop to execute the application.

Wireless Application Software for Windows Vista / XP / 2000

Download

Wireless Application Software for MAC

Download

Click the **Download** button of the corresponding operating system of your computer.

Conference Control

This allows you to host conference presentations from different sources without using projector cables and lets you control how each presentation will appear on screen.

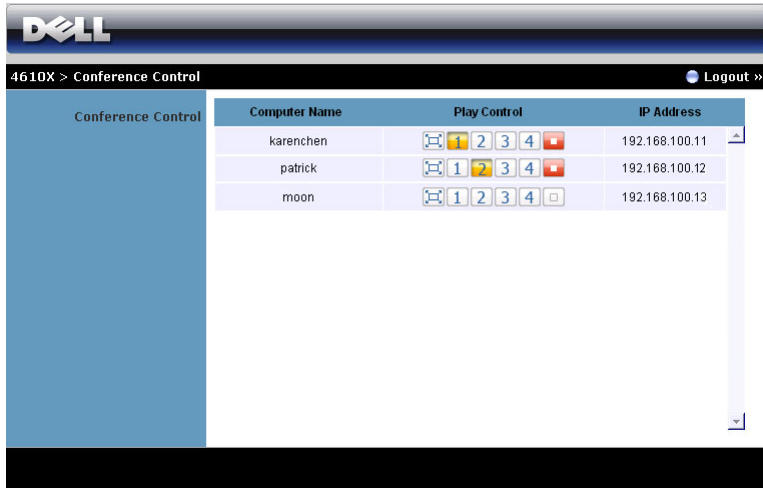

Computer Name: Lists the computers logged for conference control.

Play Control: Click the buttons to control how each computer's projection will appear on screen.

- Full screen projection — The presentation from the computer occupies the whole screen.
- Split 1 - The presentation from the computer appears on the upper left corner of the screen.
- Split 2- The presentation from the computer appears on the upper right corner of the screen.
- Split 3- The presentation from the computer appears on the lower left corner of the screen.
- Split 4- The presentation from the computer appears on the lower right corner of the screen.
- Stop - Projection from the computer is stopped.

IP Address: Shows each computer's IP Address.



NOTE: To end the conference, click **Logout**.

Managing Properties

Admin

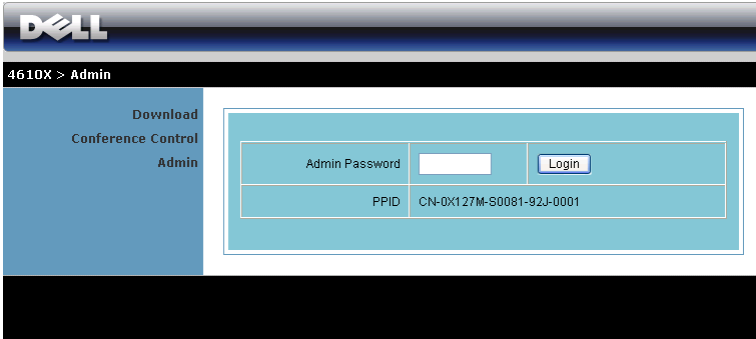

An administrator password is required to access the Admin page.

- **Admin Password:** Enter the administrator password then click **Login**. The default password is "admin". To change the password, see "Change Passwords" on page 67.

System Status

DELL

4610X > Admin > System Status Logout »

| | |
|-------------------------|-------------------------------------------|
| System Status | Network Status |
| Network Setup | IP Address: 192.168.3.68 |
| Projection Setup | Subnet Mask: 255.255.255.0 |
| Change Passwords | Default Gateway: 192.168.3.254 |
| Reset to Default | Wireless MAC Address: 00:22:5F:11:0A:1B |
| Firmware Update | Wire MAC Address: 11:22:33:44:55:66 |
| Projector Control Panel | Connection Status |
| Alert Setting | Projecting Status: Waiting for Projecting |
| Reboot System | Total Users: 0 |
| | Projector Status |
| | Model Name: 4610X WIRELESS PLUS |
| | Projector Name: |
| | Location: |
| | Contact: |
| | Status: Standby |
| | Lamp Hours: 0 hrs |

Displays the Network Status, Connection Status, and Projector Status information.

Network Status

See OSD section on page 43.

| | |
|---------------------------------------------------------------------------|---------------------------------------------------------------------------------------------------------------------------|
| System Status | |
| Network Setup | |
| Projection Setup | |
| Change Passwords | |
| Reset to Default | |
| Firmware Update | |
| Projector Control Panel | |
| Alert Setting | |
| Reboot System | |
| 4610X > Admin > Network Setup Logout » | |
| IP Setup | <input checked="" type="radio"/> Obtain an IP address automatically <input type="radio"/> Use the following IP address |
| | IP Address: 192 . 168 . 100 . 10 |
| | Subnet Mask: 255 . 255 . 255 . 0 |
| | Default Gateway: 192 . 168 . 100 . 10 |
| DNS Server: 192 . 168 . 100 . 10 | |
| DHCP Server Setup | <input type="radio"/> Auto <input checked="" type="radio"/> Disable |
| | Start IP: 192 . 168 . 100 . 11 |
| | End IP: 192 . 168 . 100 . 254 |
| | Subnet Mask: 255 . 255 . 255 . 0 |
| | Default Gateway: 192 . 168 . 100 . 10 |
| | DNS Server: 192 . 168 . 100 . 10 |
| Wireless Setup | Wireless LAN: <input checked="" type="radio"/> Enable <input type="radio"/> Disable |
| | Region: --- WORLDWIDE --- |
| | SSID: 4610X WIRELESS PLUS |
| | SSID Broadcast: <input checked="" type="radio"/> Enable <input type="radio"/> Disable |
| | Channel: Auto |
| | WEP: Disable |
| Key: | |
| GateKeeper | <input type="radio"/> All Pass <input checked="" type="radio"/> All Block <input type="radio"/> Internet Only |
| Apply Cancel | |

IP Setup

- Choose **Obtain an IP address automatically** to assign an IP address to the projector automatically, or **Use the following IP address** to assign an IP address manually.

DHCP Server Setup

- Choose **Auto** to automatically setup the **Start IP**, **End IP**, **Subnet Mask**, **Default Gateway**, and **DNS Server** address from a DHCP server, or **Disable** to disable this function.

Wireless Setup

- Choose **Enable** to setup the **Region**, **SSID**, **SSID Broadcast**, **Channel**, **WEP**, and **Key**. Choose **Disable** to disable wireless setup.

SSID: Up to maximum length of 32 characters.

WEP: You can Disable WEP key or select one of 64-bit or 128-bit in ASCII or HEX string.

Key: If WEP is enabled, you have to set key value according to WEP mode you selected.

GateKeeper

- There are 3 options:

All Pass: Allow users to access office network via wireless projector.

All Block: Block users to access all office network via wireless projector.

Internet Only: Block users from office network but still reserve Internet connection capability.

Click the **Apply** button to save and apply changes. The projector must be restarted for the changes to take effect.

Projection Setup

4610X > Admin > Projection Setup Logout »

| | | |
|------------------|----------------|-----------------------------------------------------------------------------------------------------------------------------------------------|
| Projection Setup | Resolution | XGA (1024x768) ▾ |
| | Color Depth | Normal (16 bit) ▾ |
| | Login Code | <input type="radio"/> Disable <input checked="" type="radio"/> Random <input type="radio"/> Use the following code <input type="text"/> |
| Projector Setup | Model Name | 4610X WIRELESS PLUS |
| | Projector Name | <input type="text"/> |
| | Location | <input type="text"/> |
| | Contact | <input type="text"/> |

Projection Setup

- **Resolution:** Allows you to select the resolution. Options are: XGA (1024 x 768) and WXGA (1280 x 768).
- **Color Depth:** Allows you to select the color depth for more vivid presentations. Options are: Normal (16 bit) and High (32 bit).
- **Login Code:** Select how you want the login code to be generated by the projector. There are 3 options:
 - **Disable:** Login code will not be required when logging in to the system.
 - **Random:** Default is **Random**. Login code will be randomly generated.
 - **Use the following code:** Enter a 4-digit code. This code will be used to login to the system.

Projector Setup

- Setup the **Model Name**, **Projector Name**, **Location**, and **Contact** information (up to 21 characters for each field).

Click the **Apply** button to save and apply changes. The projector must be restarted for the changes to take effect.

Change Passwords

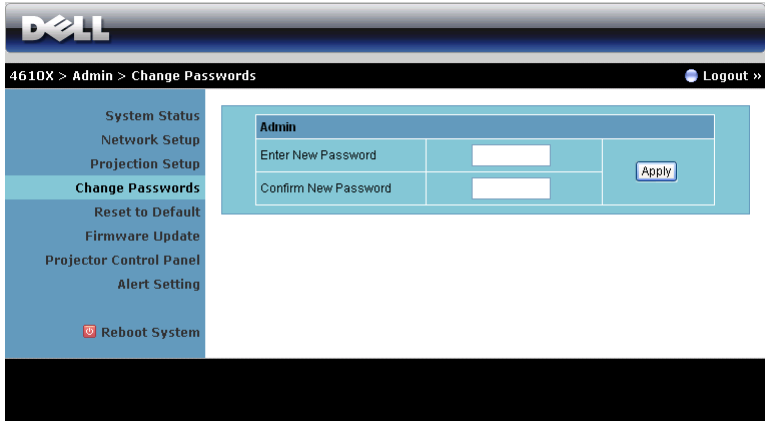

The screenshot shows the Dell 4610X Admin interface. At the top, there is a blue header with the Dell logo. Below the header, a navigation bar shows the path "4610X > Admin > Change Passwords" and a "Logout »" link. On the left side, there is a vertical menu with the following options: System Status, Network Setup, Projection Setup, Change Passwords (highlighted), Reset to Default, Firmware Update, Projector Control Panel, Alert Setting, and Reboot System (with a red square icon). The main content area is titled "Admin" and contains a form with two input fields: "Enter New Password" and "Confirm New Password". An "Apply" button is located to the right of the second input field.

This page allows you to change the administrator password.

- **Enter New Password:** Enter the new password.
- **Confirm New Password:** Enter the password again and click **Apply**.



NOTE: Contact Dell if you forget your administrator password.

Reset to Default

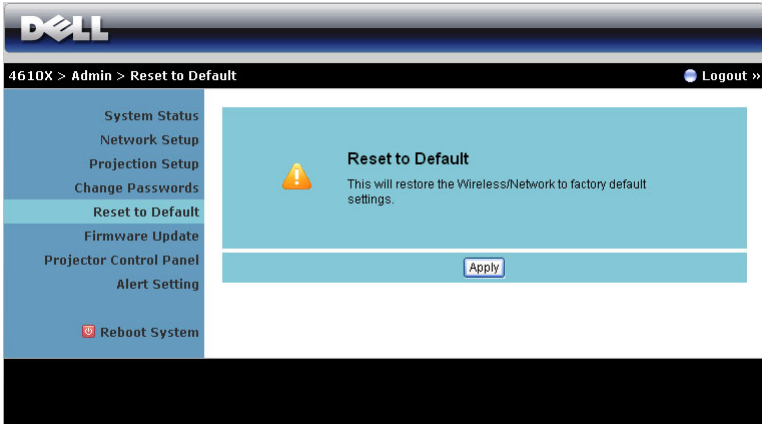

The screenshot shows the Dell 4610X Admin interface. At the top, there is a navigation bar with the Dell logo on the left and a 'Logout »' button on the right. Below the navigation bar, the breadcrumb path '4610X > Admin > Reset to Default' is displayed. On the left side, there is a vertical menu with the following items: System Status, Network Setup, Projection Setup, Change Passwords, Reset to Default (highlighted in light blue), Firmware Update, Projector Control Panel, Alert Setting, and Reboot System (with a red stop icon). The main content area is a light blue box with a warning icon (a yellow triangle with an exclamation mark) and the heading 'Reset to Default'. Below the heading, the text reads: 'This will restore the Wireless/Network to factory default settings.' At the bottom of this box, there is a button labeled 'Apply'.

Click the **Apply** button to restore all wireless/network setup to its factory default settings.

Firmware Update

Use the Firmware Update page to update your projector's firmware.

4610X > Admin > Firmware Update Logout >>

System Status
Network Setup
Projection Setup
Change Passwords
Reset to Default
Firmware Update
Projector Control Panel
Alert Setting
Reboot System

| | |
|---------------------------|----------|
| Wireless Firmware Version | W11 |
| Release Date | 20090313 |

Firmware update will take few minutes. Do not interrupt the process once it has begun. The wireless system will auto reboot after update is complete.
Select a file (*.awd) to update:

File Name

To start firmware update, do the following steps:

- 1 Press **Browse** to select the file to update.
- 2 Click the **Update** button to start. Wait while the system updates the firmware in your device.

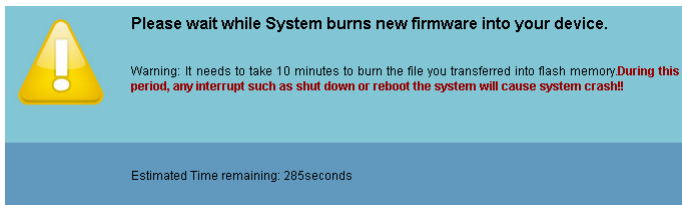

CAUTION: Do not interrupt the update process, this may cause the system to crash!

- 3 Click **OK** when update is complete.

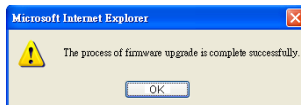

Projector Control Panel

The screenshot shows the Dell Projector Control Panel web interface. At the top left is the Dell logo. Below it, a breadcrumb trail reads "4610X > Admin > Projector Control Panel" and a "Logout »" link is on the right. The left sidebar contains a list of navigation options: System Status, Network Setup, Projection Setup, Change Passwords, Reset to Default, Firmware Update, **Projector Control Panel** (highlighted), Alert Setting, and Reboot System (with a red warning icon). The main content area is titled "Projector Information" and contains several sections:

- Projector Information:**
 - Projector Status: Standby (with a Refresh button)
 - Power Saving: Off (dropdown menu) (with Power ON and Power OFF buttons)
 - Alert Status: Good (with a Clear button)
- Image Control:**
 - Operation Mode: Normal Mode ECO Mode
 - Projector Mode: Front Projection-Desktop (dropdown menu)
 - Source Select: None (dropdown menu)
 - Video Mode: Presentation Mode (dropdown menu)
 - Blank Screen: On Off
 - Aspect Ratio: Original 4:3 Wide
 - Brightness: 0 (input field) (0-100) (with Set button)
 - Contrast: 0 (input field) (0-100) (with Set button)
 - Auto Adjust button
- Audio Control:**
 - Audio Input: Audio-A (dropdown menu)
 - Volume: 0 (input field) (0-20) (with Set button)
 - Speaker: On Off
 - Alert Volume: Off (dropdown menu)
 - Factory Reset button

Projector Information

- **Projector Status:** There are 4 status: Lamp On, Standby, Power Saving, and Cooling. Click the **Refresh** button to refresh the status and control settings.
- **Power Saving:** Power Saving can be set to Off, 30, 60, 90, or 120 minutes. For more information, see "Power Saving" on page 46.
- **Alert Status:** There are 5 alert status: Lamp fail, Lamp hours running out, Projector over-heating, Fan error, and Lamp over-heating. Your projector might lock up in protection mode if any of the alerts are activated. To exit protection mode, click the **Clear** button to clear the Alert Status before you Power ON your projector.

Image Control

- **Operation Mode:** Allows you to select the operation mode. The two options are: Normal Mode and ECO Mode.
- **Projector Mode:** Allows you to select the projector mode, depending on how the projector is mounted. There are 4 projection modes: Front Projection-Desktop, Front Projection-Ceiling Mount, Rear Projection-Desktop and Rear Projection-Ceiling Mount.
- **Source Select:** The Source Select menu allows you to select your projector input source. You can select VGA-A, VGA-B, S-Video, Composite Video, HDMI, and Wireless/Network.
- **Video Mode:** Select a mode to optimize the display image based on how the projector is being used:
 - **Presentation:** Best for presentation slides.
 - **Bright:** Maximum brightness and contrast.
 - **Movie:** For viewing movie & photo.
 - **sRGB:** Provide a more accurate color representation.
 - **Custom:** User preferred settings.
- **Blank Screen:** You can select On or Off.
- **Aspect Ratio:** Allows you to select the aspect ratio to adjust how the image appears.
- **Brightness:** Select value to adjust the brightness of the image.
- **Contrast:** Select value to adjust the display contrast.

Click the **Auto Adjust** button to adjust the settings automatically.

Audio Control

- **Audio Input:** Select the input source. Options are: Audio-A, Audio-B, Audio-C and HDMI.
- **Volume:** Select the value (0~20) for audio volume.
- **Speaker:** Select On to enable the audio function or select Off to disable the audio function.
- **Alert Volume:** Set the alert loudness (Off, Low, Mid, or High) for power on/off, warning and command keys.

Click the **Factory Reset** button to restore the factory defaults settings.

Alert Setting

4610X > Admin > Alert Setting Logout >>

E-Mail Alert

Enable Disable E-Mail Alert Test

To: @

Cc: @

From: @

Subject: 4610X WIRELESS PLUS-D33963 Alert

SMTP Setting

Out going SMTP Server:

Username:

Password:

Alert Condition

Lamp warning

Low lamp life

Temperature warning

Non-original Lamp module

E-mail Alert

- E-mail Alert: You can set whether to be notified by email (Enable) or not (Disable).
- To/CC/From: You can enter email address of sender (From) and recipients (To/Cc) to receive notification when an abnormality or warning occurs.
- Subject: You can enter the subject line of the email.

Click the **E-mail Alert Test** button to test the e-mail alert settings.

SMTP Setting

- **Out going SMTP server**, **User name** and **Password** should be provided by your network administrator or MIS.

Alert Condition

- You can select the abnormalities or warnings to be notified by email. When any of the alert conditions occur, an email will be sent to the recipients (To/Cc).

Click the **Save** button to save settings.

Reboot System

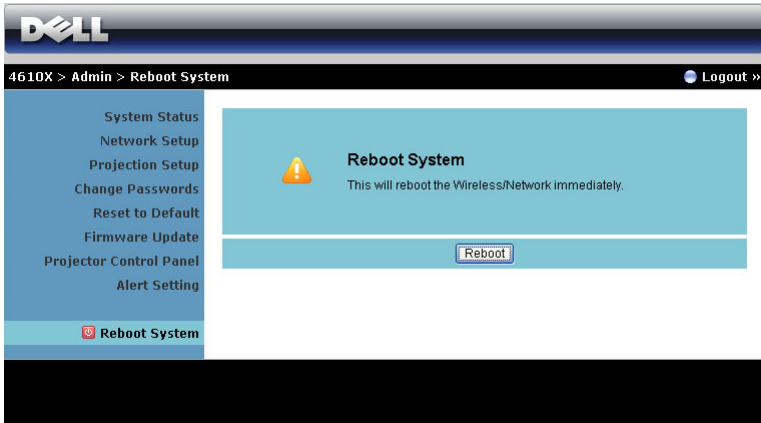

Click **Reboot** to reboot the system.

TIPS:

I would like remote access the projector via Internet. What is the better setting for the browser?

To have a better setting for the browser, please follow the steps below:

- 1 Open Control Panel → Internet Options → General tab → Temporary Internet Files → Settings → Select Every visit to the pages.
- 2 Some firewall or anti-virus may block the HTTP application, if possible turn off the firewall or anti-virus.

I would like to remote access the projector via Internet. What socket port number should I open for it in the firewall?

The following are TCP/IP socket ports which projector uses.

| UDP/TCP | Port Number | Description |
|---------|-------------|---------------------------------------------------|
| TCP | 80 | Web configuration (HTTP) |
| UDP/TCP | 25 | SMTP: used for email routing between mail servers |
| UDP/TCP | 161 | SNMP: Simple Network Management Protocol |
| UDP | 9131 | AMX: used for AMX discovery |

Why am I unable to access the projector via Internet?

- 1 Check whether your computer/laptop is connected to the Internet.
- 2 Check with your MIS or network administrator whether your computer/laptop is in the same subnet.

Why am I unable to access the SMTP server?

- 1** Check with your MIS or network administrator whether the SMTP server function is open for the projector and the IP assigned to the projector is allowed to access the SMTP server. The projector's SMTP socket port number is 25, this cannot be changed.
- 2** Check if the out going SMTP server, user name, and password are set correctly.
- 3** Some SMTP servers will check whether the mail address of "From" correlates with the "User name" and "Password". For example, you use test@dell.com as the mail address in "From". You should also use test@dell.com account information for the User name and the password to log in the SMTP server.

Why am I unable to receive the test alert email even though the projector already indicates the test mail is already sent?

It could be because the SMTP server recognized the alert mail as a spam mail or because of the SMTP server restriction. Check with your MIS or network administrator for the SMTP server's setting.

Firewall Configuration and FAQ

Q: Why can't I access the Web Management Page?

A: Your computer's firewall configuration may prevent you from accessing the Web Management Web Page. Please refer to the following configuration settings.

| Firewall Protection | Configuration |
|----------------------------|------------------------------------------------------------------------------------------------------------------------------------------------------------------------------------------------------------------------------------------------------------------------------------------------------------------------------------------------------------------------------------------------------------------------------------------------------------------------------------------------------------------------------------------------------|
| McAfee Security Center | <ol style="list-style-type: none">1 Launch McAfee Security Center (Start > All Programs > McAfee > McAfee Security Center).2 On the personal firewall plus tab, click View the Internet Applications List.3 Find and select Dell 4610X Wireless Plus Projector from the list.4 Right click on its Permissions column.5 Select Allow Full Access from the pop-up menu. |
| Norton AntiVirus | <ol style="list-style-type: none">1 Open Norton AntiVirus (Start > All Programs > Norton AntiVirus > Norton AntiVirus).2 Click Options menu, then select Norton AntiVirus.3 On the Status page, select Internet Worm Protection.4 Find and select Dell 4610X Wireless Plus Projector from the list of programs.5 Right click on its Internet Access column.6 Select Permit All from the pop-up menu.7 Click OK. |
| Sygate Personal Firewall | <ol style="list-style-type: none">1 Open Sygate Personal Firewall (Start > All Programs > Sygate > Sygate Personal Firewall).2 From the Running Applications list, find and right click on Dell 4610X Wireless Plus Projector.3 Select Allow from the pop-up menu. |

| Firewall Protection | Configuration |
|----------------------------|--------------------------------------------------------------------------------------------------------------------------------------------------------------------------------------------------------------------------------------------------------------------------------------------------------------------------------------------------------------------------------------------------------------------------------------------------------------------------------------------------------------------------------------------------------------------|
| Windows Firewall | <ol style="list-style-type: none"> 1 Open Windows Firewall (Start > All Programs > Control Panel). Double click on Windows Firewall. 2 On the General tab, uncheck Don't allow exceptions. 3 On the Exceptions tab, click the Add Program... button. 4 Find and select Dell 4610X Wireless Plus Projector from the list of programs, then click OK. 5 Click OK to confirm exceptions settings. |
| Zone Alarm | <ol style="list-style-type: none"> 1 Open Zone Alarm Firewall (Start > All Programs > Zone Labs > Zone Labs Center). 2 On the Program Control page, find and select Dell 4610X Wireless Plus Projector from the list. 3 Right click on its Access-Trusted column. 4 Select Allow from the pop-up menu. 5 Right click and select Allow for the Access-Internet, Server-Trusted, and Server-Internet columns. |

Make Application Token

The Application Token lets you perform Plug and Show using a USB token.

- 1 From the application software, click  > **Make Application Token**.
- 2 The following screen appears. Click **Next**.



- 3 Plug a flash drive into any of the USB ports on your computer. Select the drive from the list, then click **Next**.

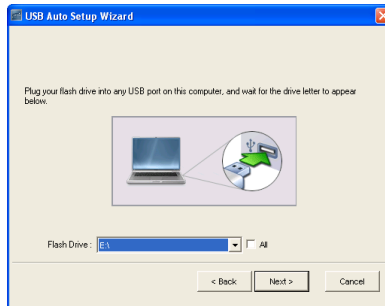

- 4 Click **Finish** to close the wizard.



Troubleshooting Your Projector

If you experience problems with your projector, see the following troubleshooting tips. If the problem persists, contact Dell™ (see Contacting Dell™ on page 92).

Problem

No image appears on the screen

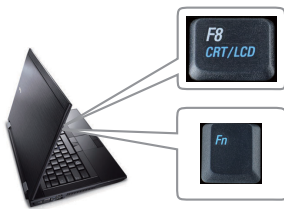





Possible Solution

- Ensure that the lens cap is removed and the projector is turned on.
- Ensure that the INPUT SELECT is set correctly in the OSD menu.
- Ensure the external graphics port is enabled. If you are using a Dell™ portable computer, press **Fn** **F8** (Fn+F8). For other computers, see your respective documentation. The output signal from the computer is not according to industry standards. Should this happen, upgrade the video driver of the computer. For Dell computer, see support.dell.com.
- Ensure that all the cables are securely connected. See "Connecting Your Projector" on page 9.
- Ensure that the pins of the connectors are not bent or broken.
- Ensure that the lamp is securely installed (see "Changing the Lamp" on page 85).
- Use **Test Pattern** in the **Others** menu. Ensure that the colors of the test pattern are correct.

Missing Input Source.
Cannot switch to particular
Input Source.

Go to Advanced Enable/Disable Sources,
ensure that particular Input Source is set to
Enable.

| Problem (continued) | Possible Solution (continued) |
|----------------------------------------------------|-----------------------------------------------------------------------------------------------------------------------------------------------------------------------------------------------------------------------------------------------------------------------------------------------------------------------------------------------------------------------------------------------------------------------------------------------------------------------------------------------------------------------------------------------------------------------------------------------------------------------------------------------------------------------------------------------------------------------------------------------------------------------------------------------------------------------------------------------------------------------------------------------------------------------------------------------------------------------------------------------------------------------------------------------------------------------------------------------------------------------------------------------------------------------------------------------------------------------------|
| Partial, scrolling, or incorrectly displayed image | <ol style="list-style-type: none"> 1 Press the Auto Adjust button on the remote control or the control panel. 2 If you are using a Dell™ portable computer, set the resolution of the computer to XGA (1024 x 768): <ol style="list-style-type: none"> a Right-click the unused portion of your Microsoft® Windows® desktop, click Properties and then select Settings tab. b Verify that the setting is 1024 x 768 pixels for the external monitor port. c Press   (Fn+F8). <p>If you experience difficulty in changing resolutions or your monitor freezes, restart all the equipment and the projector.</p> <p>If you are not using a Dell™ portable computer, see your computer's documentation. The output signal from the computer may not be according to industry standards. Should this happen, upgrade the video driver of the computer. For a Dell computer, see support.dell.com.</p> |
| The screen does not display your presentation | If you are using a portable computer, press   (Fn+F8). |
| Image is unstable or flickering | Adjust the tracking in the OSD Display sub-menu (in PC Mode only). |
| Image has vertical flickering bar | Adjust the frequency in the OSD Display sub-menu (in PC Mode only). |
| Image color is incorrect | <ul style="list-style-type: none"> • If the display receives the wrong signal output from the graphics card, please set the signal type to RGB in the OSD Display tab. • Use Test Pattern in the Others menu. Ensure that the colors of the test pattern are correct. |
| Image is out of focus | <ol style="list-style-type: none"> 1 Adjust the focus ring on the projector lens. 2 Ensure that the projection screen is within the required distance from the projector (3.94 ft [1.2 m] to 32.81 ft [10 m]). |

| Problem (continued) | Possible Solution (continued) |
|---------------------------------------------------|------------------------------------------------------------------------------------------------------------------------------------------------------------------------------------------------------------------------------------------------------------------------------------------------------------------------------------------------------------------------------------------------------------------------------------------------------------------------------------------------------------------------------------------------------------------------------------------------------------------|
| The image is stretched when displaying a 16:9 DVD | <p>The projector automatically detects the input signal format. It will maintain the aspect ratio of the projected image according to input signal format with an Original setting.</p> <p>If the image is still stretched, adjust the aspect ratio in the Set Up menu in the OSD.</p> |
| Image is reversed | Select Set Up from the OSD and adjust the projector mode. |
| Lamp is burned out or makes a popping sound | When the lamp reaches its end of life, it may burn out and may make a loud popping sound. If this occurs, the projector does not turn back on. To replace the lamp, see "Changing the Lamp" on page 85. |
| LAMP light is solid amber | If the LAMP light is solid amber, replace the lamp. |
| LAMP light is blinking amber | <p>If the LAMP light is blinking amber, Lamp module connection may be disrupted. Please check the lamp module and ensure that it is properly installed.</p> <p>If the LAMP light and the Power light are blinking amber, the lamp driver has failed and the projector will automatically shut down.</p> <p>If the LAMP and TEMP light are blinking amber and the Power light is solid blue, the color wheel has failed and the projector will automatically shut down.</p> <p>To clear the protection mode, press and hold the POWER button for 10 seconds.</p> |
| TEMP light is solid amber | The projector has overheated. The display automatically shuts down. Turn the display on again after the projector cools down. If the problem persists, contact Dell™. |

| Problem (continued) | Possible Solution (continued) |
|-----------------------------------------------------------------------------------|-------------------------------------------------------------------------------------------------------------------------------------------------------------------------------------------------------------------------------------------------------------------------------|
| TEMP light is blinking amber | A projector fan has failed and the projector will automatically shut down. Try to clear the projector mode by pressing and holding the POWER button for 10 seconds. Please wait for about 5 minutes and try to power up again. If the problem persists, contact Dell™. |
| The OSD does not appear on the screen | Try to press the Menu button on the panel for 15 seconds to unlock the OSD. Check the Menu Lock on page 45. |
| The remote control is not operating smoothly or works only within a limited range | The battery may be low. Check if the laser beam transmitted from the remote is too dim. If so, replace with 2 new AAA batteries. |

Guiding Signals

| Projector Status | Description | Control Buttons | | | Indicator | |
|----------------------------------|-------------------------------------------------------------------------------------------------------------------------------------------------------------------------------------------------------------------------------------------------------------|-----------------|------|--------|----------------|----------------|
| | | Power | Menu | Others | TEMP (Amber) | LAMP (Amber) |
| Standby mode | Projector in Standby mode. Ready to power on. | BLUE Flashing | OFF | OFF | OFF | OFF |
| Warming up mode | Projector takes some time to warm up and power on. | BLUE | BLUE | BLUE | OFF | OFF |
| Lamp on | Projector in Normal mode, ready to display an image.  Note: The OSD menu is not accessed. | BLUE | BLUE | OFF | OFF | OFF |
| Cooling mode | Projector is cooling to shutdown. | BLUE | OFF | OFF | OFF | OFF |
| Power Saving mode | Power Saving mode has been activated. The projector will automatically enter standby mode, if an input signal is not detected in two hours. | AMBER Flashing | OFF | OFF | OFF | OFF |
| Cooling before Power Saving mode | The projector takes 60 seconds to cool down before entering Power Saving mode. | AMBER | OFF | OFF | OFF | OFF |
| Projector overheated | Air vents might be blocked or ambient temperature may be above 35°C. The projector automatically shuts down. Ensure that the air vents are not blocked and that the ambient temperature is within operational range. If the problem persists, contact Dell. | OFF | OFF | OFF | AMBER | OFF |
| Lamp overheated | The lamp is overheated. The air vents may be blocked. The projector automatically shuts down. Turn the display on again after the projector cools down. If the problem persists, contact Dell. | BLUE | OFF | OFF | AMBER | OFF |
| Lamp driver overheated | The lamp driver is overheated. The air vents may be blocked. The projector automatically shuts down. Turn the display on again after the projector cools down. If the problem persists, contact Dell. | AMBER | OFF | OFF | AMBER | OFF |
| Fan breakdown | One of the fans has failed. The projector automatically shuts down. If the problem persists, contact Dell. | OFF | OFF | OFF | AMBER Flashing | OFF |
| Lamp driver breakdown | The lamp driver has failed. The projector automatically shuts down. Unplug the power cord after three minutes then turn the display on again. If this problem persists, contact Dell. | AMBER Flashing | OFF | OFF | OFF | AMBER Flashing |
| Color Wheel breakdown | Color wheel cannot start. The projector has failed and the projector automatically shuts down. Unplug the power cord after three minutes and then turn on the projector. If this problem persists, contact Dell. | BLUE | OFF | OFF | AMBER Flashing | AMBER Flashing |

| | | | | | | |
|---------------------------------|----------------------------------------------------------------------------------------------------------------------------------------------------------------------------------------------|----------------|-----|-----|-------|----------------|
| Lamp failure | Lamp is defective. Replace the lamp. | OFF | OFF | OFF | OFF | AMBER |
| Fault - DC supply (+12V) | Power supply has been interrupted. The projector automatically shuts down. Unplug the power cord after three minutes and then turn on the projector. If this problem persists, contact Dell. | AMBER Flashing | OFF | OFF | AMBER | AMBER |
| Fault - DC supplies (secondary) | Power supply has been interrupted. The projector automatically shuts down. Unplug the power cord after three minutes and then turn on the projector. If this problem persists, contact Dell. | AMBER Flashing | OFF | OFF | AMBER | OFF |
| Lamp module connection failed | Lamp module connection may be disrupted. Check the lamp module and ensure that it is properly installed. If the problem persists, contact Dell. | OFF | OFF | OFF | OFF | AMBER Flashing |

Changing the Lamp

⚠ CAUTION: Before you begin any of the procedures in this section, follow the Safety Instructions as described on page 7.

Replace the lamp when the message "Lamp is approaching the end of its useful life in the operation. Replacement suggested! www.dell.com/lamps" appears on the screen. If this problem persists after replacing the lamp, contact Dell™. For more information, see Contacting Dell™ on page 92.

⚠ CAUTION: Use an original lamp to ensure safe and optimal working condition of your projector.

⚠ CAUTION: The lamp becomes very hot when in use. Do not attempt to replace the lamp until the projector has been allowed to cool down for at least 30 minutes.

⚠ CAUTION: Do not touch the bulb or the lamp glass at any time. Projector lamps are very fragile and may shatter if touched. The shattered glass pieces are sharp and can cause injury.

⚠ CAUTION: If the lamp shatters, remove all broken pieces from the projector and dispose or recycle according to state, local, or federal law. For more information see www.dell.com/hg.

- 1 Turn off the projector and disconnect the power cord.
- 2 Let the projector cool for at least 30 minutes.
- 3 Loosen the two screws that secure the lamp cover, and remove the cover.
- 4 Loosen the two screws that secure the lamp.
- 5 Pull the lamp up by its metal handle.

✍ NOTE: Dell™ may require lamps replaced under warranty to be returned to Dell™. Otherwise, contact your local waste disposal agency for the address of the nearest deposit site.

- 6 Replace with the new lamp.
- 7 Tighten the two screws that secure the lamp.
- 8 Replace the lamp cover and tighten the two screws.



9 Reset the lamp usage time by selecting "Yes" for **Lamp Reset** in the OSD **Lamp** tab (see Lamp menu on page 41). When a new lamp module has been changed, the projector will automatically detect and reset the lamp hours.



CAUTION: Lamp Disposal (for the US only)

 **LAMP(S) INSIDE THIS PRODUCT CONTAIN MERCURY AND MUST BE RECYCLED OR DISPOSED OF ACCORDING TO LOCAL, STATE OR FEDERAL LAWS. FOR MORE INFORMATION, GO TO WWW.DELL.COM/HG OR CONTACT THE ELECTRONIC INDUSTRIES ALLIANCE AT WWW.EIAE.ORG. FOR LAMP SPECIFIC DISPOSAL INFORMATION CHECK WWW.LAMPRECYCLE.ORG.**

Specifications

| | |
|------------------------|-------------------------------------------------------------------------------------------------------------------------------------------------------------------------------------------------------------------------------------------------------------------------------------------------------------------|
| Light Valve | 0.55" XGA DMD Type X, DarkChip2™ |
| Brightness | 3500 ANSI Lumens (Max.) |
| Contrast Ratio | 2000:1 Typical (Full On/Full Off) |
| Uniformity | 85% Typical (Japan Standard - JBMA) |
| Number of Pixels | 1024 x 768 (XGA) |
| Displayable Color | 16.7M colors |
| Color Wheel Speed | 2X |
| Projection Lens | F-Stop: F/ 2.4~2.66 Focal length, f=18.2~21.8 mm 1.2X manual Zoom Lens Throw ratio = 1.6~1.92 wide and tele |
| Projection Screen Size | 30-307 inches (diagonal) |
| Projection Distance | 3.94~32.81 ft (1.2 m~10 m) |
| Video Compatibility | Composite Video / S-Video: NTSC (J, M, 4.43), PAL (B, D, G, H, I, M, N, Nc, 60), SECAM (B, D, G, K, K1, L) Component Video via VGA & HDMI: 1080i/p, 720p, 576i/p, 480i/p |
| Power Supply | Universal AC90-264 50/60 Hz with PFC input |
| Power Consumption | Normal mode: 375W ± 10% @ 110Vac (Wireless and Network On) Eco mode: 330W ± 10% @ 110Vac (Wireless and Network On) Power saving mode: <24W (Wireless and Network On, fan speed at minimum) Standby mode: <12W ± 10% @ 110Vac (Wireless and Network On) < 1W (Wireless and Network Off) |

| | |
|------------------------|---------------------------------------------------|
| Audio | 2 speakers x 5watt RMS |
| Noise Level | 35 dB(A) Normal mode, 32 dB(A) Eco mode |
| Weight | 6.55 ± 0.05 lbs (2.97 ± 0.02 kg) |
| Dimensions (W x H x D) | 11.26 x 4.33 x 9.76 inches (286 x 110 x 247.8 mm) |



| | |
|------------------------------------------------------------------------------------------------------|--------------------------------------------------------------------------------------------------------|
| Environmental | Operating temperature: 5°C - 35°C (41°F- 95°F) |
| | Humidity: 80% maximum |
| | Storage temperature: 0°C to 60°C (32°F to 140°F) |
| | Humidity: 90% maximum |
| I/O Connectors | Shipping temperature: -20°C to 60°C (-4°F to 140°F) |
| | Humidity: 90% maximum |
| | Power: One AC power socket (3-pins - C14 inlet) |
| | VGA input: Two 15-pins D-sub connectors (Blue), VGA-A & VGA-B, for analog RGB/Component input signals. |
| | VGA output: One 15-pins D-sub connector (Black) for VGA-A loop through. |
| | S-Video input: One standard 4-pins min-DIN S-Video connector for Y/C signal. |
| | Composite video input: One Yellow RCA jack for CVBS signal. |
| | HDMI input: One HDMI connector for supporting HDMI 1.3. HDCP compliant. |
| Analog Audio input: Two 3.5mm stereo mini phone jack (Blue) & one pair of RCA connector (Red/White). | |

| | |
|----------|--------------------------------------------------------------------------------|
| | Variable audio output: One 3.5mm stereo mini phone jack (Green). |
| | USB port: One USB slave for remote support. |
| | RS232 port: One mini-DIN 6-pins for RS232 communication. |
| | RJ45 port: One RJ45 connector for control of projector through network. |
| | 12V output: One 12V DC / 200mA max. relay output for driving automatic screen. |
| Wireless | Wireless Standard: IEEE802.11b/g |
| | OS environment: Windows Vista/XP/2000, MAC OS X |
| | Support: Presentation slides and projector control. |
| | Allow connection up to 20 users at the same time. |
| | 4-to-1 split screen. Allow 4 presentation slides to be projected on screen. |
| | Conference Control mode. |
| Lamp | Philips 280W user-replaceable lamp (up to 2500 hours in eco mode) |



NOTE: The lamp life rating for any projector is a measure of brightness degradation only, and is not a specification for the time it takes a lamp to fail and cease light output. Lamp life is defined as the time it takes for more than 50 percent of a lamp sample population to have brightness decrease by approximately 50 percent of the rated lumens for the specified lamp. The lamp life rating is not guaranteed in any way. The actual operating life span of a projector lamp will vary according to operating conditions and usage patterns. Usage of a projector in stressful conditions which may include dusty environments, under high temperatures, many hours per day and abrupt powering-off will most likely result in a lamp's shortened operating life span or possible lamp failure.

RS232 Pin Assignment

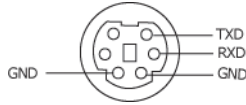

RS232 Protocol

- Communication Settings

| Connection settings | Value |
|---------------------|-------|
| Baud Rate: | 19200 |
| Data Bits: | 8 |
| Parity | None |
| Stop Bits | 1 |

- Command types

To pop up the OSD menu and adjust the settings.

- Control command Syntax (From PC to Projector)

[H][AC][SoP][CRC][ID][SoM][COMMAND]

- Example: Power ON Command (Send low byte firstly)

--> 0xBE, 0xEF, 0x10, 0x05, 0x00, 0xC6, 0xFF, 0x11, 0x11, 0x01, 0x00, 0x01

- Control Commands List

To view the latest RS232 code, go to the Dell Support site at: support.dell.com.

Compatibility Modes (Analog/Digital)

| Resolution | Refresh Rate (Hz) | Hsync Frequency (KHz) | Pixel Clock (MHz) |
|-----------------|-------------------|-----------------------|-------------------|
| 640 x 350 | 70.087 | 31.469 | 25.175 |
| 640 x 480 | 59.940 | 31.469 | 25.175 |
| 640 x 480 p60 | 59.940 | 31.469 | 25.175 |
| 720 x 480 p60 | 59.940 | 31.469 | 27.000 |
| 720 x 576 p50 | 50.000 | 31.250 | 27.000 |
| 720 x 400 | 70.087 | 31.469 | 28.322 |
| 640 x 480 | 75.000 | 37.500 | 31.500 |
| 848 x 480 | 60.000 | 31.020 | 33.750 |
| 640 x 480 | 85.008 | 43.269 | 36.000 |
| 800 x 600 | 60.317 | 37.879 | 40.000 |
| 800 x 600 | 75.000 | 46.875 | 49.500 |
| 800 x 600 | 85.061 | 53.674 | 56.250 |
| 1024 x 768 | 60.004 | 48.363 | 65.000 |
| 1280 x 720 p50 | 50.000 | 37.500 | 74.250 |
| 1280 x 720 p60 | 60.000 | 45.000 | 74.250 |
| 1920 x 1080 i50 | 50.000 | 28.125 | 74.250 |
| 1920 x 1080 i60 | 60.000 | 33.750 | 74.250 |
| 1280 x 720 | 59.855 | 44.772 | 74.500 |
| 1024 x 768 | 75.029 | 60.023 | 78.750 |
| 1280 x 800 | 59.810 | 49.702 | 83.500 |
| 1366 x 768 | 59.790 | 47.712 | 85.500 |
| 1360 x 768 | 60.015 | 47.712 | 85.500 |
| 1024 x 768 | 84.997 | 68.677 | 94.500 |
| 1440 x 900 | 59.887 | 55.935 | 106.500 |
| 1152 x 864 | 75.000 | 67.500 | 108.000 |
| 1280 x 960 | 60.000 | 60.000 | 108.000 |
| 1280 x 1024 | 60.020 | 63.981 | 108.000 |
| 1152 x 864 | 85.000 | 77.095 | 119.651 |
| 1400 x 1050 | 59.978 | 65.317 | 121.750 |
| 1280 X 800 | 84.880 | 71.554 | 122.500 |
| 1280 x 1024 | 75.025 | 79.976 | 135.000 |
| 1440 X 900 | 74.984 | 70.635 | 136.750 |
| 1680 x 1050 | 59.954 | 65.290 | 146.250 |
| 1280 x 960 | 85.002 | 85.938 | 148.500 |
| 1920 x 1080 | 60.000 | 67.500 | 148.500 |
| 1400 X 1050 | 74.867 | 82.278 | 156.000 |
| 1280 x 1024 | 85.024 | 91.146 | 157.000 |
| 1440 X 900 | 84.842 | 80.430 | 157.000 |
| 1600 x 1200 | 60.000 | 75.000 | 162.000 |

Contacting Dell

For customers in the United States, call 800-WWW-DELL (800-999-3355).



NOTE: If you do not have an active Internet connection, you can find contact information on your purchase invoice, packing slip, bill, or Dell product catalog.

Dell™ provides several online and telephone-based support and service options. Availability varies by country and product, and some services may not be available in your area. To contact Dell for sales, technical support, or customer service issues:

- 1 Visit support.dell.com.
- 2 Verify your country or region in the **Choose A Country/Region** drop-down menu at the bottom of the page.
- 3 Click **Contact Us** on the left side of the page.
- 4 Select the appropriate service or support link based on your need.
- 5 Choose the method of contacting Dell that is convenient for you.

Appendix: Glossary

ANSI LUMENS — A standard for measuring the brightness. It is calculated by dividing a square meter image into nine equal rectangles, measuring the lux (or brightness) reading at the center of each rectangle, and averaging these nine points.

ASPECT RATIO — The most popular aspect ratio is 4:3 (4 by 3). Early television and computer video formats are in a 4:3 aspect ratio, which means that the width of the image is $\frac{4}{3}$ times the height.

Brightness — The amount of light emitted from a display or projection display or projection device. The brightness of projector is measured by ANSI lumens.

Color Temperature — The color appearance of white light. Low color temperature implies warmer (more yellow/red) light while high color temperature implies a colder (more blue) light. The standard unit for color temperature is Kelvin (K).

Component Video — A method of delivering quality video in a format that consists of the luminance signal and two separate chrominance signals and are defined as Y'Pb'Pr' for analog component and Y'Cb'Cr' for digital component. Component video is available on DVD players.

Composite Video — A video signal that combines the luma (brightness), chroma (color), burst (color reference), and sync (horizontal and vertical synchronizing signals) into a signal waveform carried on a single wire pair. There are three kind of formats, namely, NTSC, PAL and SECAM.

Compressed Resolution — If the input images are of higher resolution than the native resolution of the projector, the resulting image will be scaled to fit the native resolution of the projector. The nature of compression in a digital device means that some image content is lost.

Contrast Ratio — Range of light and dark values in a picture, or the ratio between their maximum and minimum values. There are two methods used by the projection industry to measure the ratio:

1 Full On/Off — measures the ratio of the light output of an all white image (full on) and the light output of an all black (full off) image.

2 ANSI — measures a pattern of 16 alternating black and white rectangles. The average light output from the white rectangles is divided by the average light output of the black rectangles to determine the ANSI contrast ratio.

Full On/Off contrast is always a larger number than ANSI contrast for the same projector.

dB — decibel — A unit used to express relative difference in power or intensity, usually between two acoustic or electric signals, equal to ten times the common logarithm of the ratio of the two levels.

Diagonal Screen — A method of measuring the size of a screen or a projected image. It measures from one corner to the opposite corner. A 9FT high, 12FT wide, screen has a diagonal of 15FT. This document assumes that the diagonal dimensions are for the traditional 4:3 ratio of a computer image as per the example above.

DHCP — Dynamic Host Configuration Protocol — A network protocol that enables a server to automatically assign a TCP/IP address to a device.

DLP® — Digital Light Processing™ — Reflective display technology developed by Texas Instruments, using small manipulated mirrors. Light passes through a color filter is sent to the DLP mirrors which arrange the RGB colors into a picture projected onto screen, also known as DMD.

DMD — Digital Micro-Mirror Device — Each DMD consists of thousands of tilting, microscopic aluminum alloy mirrors mounted on a hidden yoke.

DNS — Domain Name System — An internet service that translates domain names into IP addresses.

Focal Length — The distance from the surface of a lens to its focal point.

Frequency — It is the rate of repetition in cycles per seconds of electrical signals. Measured in Hz (Hertz).

HDCP — High-Bandwidth Digital-Content Protection — A specification developed by Intel™ Corporation to protect digital entertainment across digital interface, such as DVI, HDMI.

HDMI — High-Definition Multimedia Interface — HDMI carries both uncompressed high definition video along with digital audio and device control data in a single connector.

Hz (Hertz) — Unit of frequency.

IEEE802.11 — A set of standards for wireless local are network (WLAN) communication. 802.11b/g uses the 2.4GHz band.

Keystone Correction — Device that will correct an image of the distortion (usually a wide-top narrow-bottom effect) of a projected image caused by improper projector to screen angle.

Maximum Distance — The distance from a screen the projector can be to cast an image that is usable (bright enough) in a fully darkened room.

Maximum Image Size — The largest image a projector can throw in a darkened room. This is usually limited by focal range of the optics.

Minimum Distance — The closest position that a projector can focus an image onto a screen.

NTSC — National Television Standards Committee. North American standard for video and broadcasting, with a video format of 525 lines at 30 frames per second.

PAL — Phase Alternating Line. A European broadcast standard for video and broadcasting, with a video format of 625 lines at 25 frames per second.

Reverse Image — Feature that allows you to flip the image horizontally. When used in a normal forward projection environment text, graphics, etc. are backwards. Reverse image is used for rear projection.

RGB — Red, Green, Blue — typically used to describe a monitor that requires separate signals for each of the three colors.

S-Video — A video transmission standard that uses a 4-pin mini-DIN connector to send video information on two signal wires called luminance (brightness, Y) and chrominance (color, C). S-Video is also referred to as Y/C.

SECAM — A French and international broadcast standard for video and broadcasting, closely related to PAL but with a different method of sending color information.

SSID — Service Set Identifiers — A name used to identify the particular wireless LAN to which a user wants to connect.

SVGA — Super Video Graphics Array — 800 x 600 pixels count.

SXGA — Super Extended Graphics Array, — 1280 x 1024 pixels count.

UXGA — Ultra Extended Graphics Array — 1600 x 1200 pixels count.

VGA — Video Graphics Array — 640 x 480 pixels count.

WEP — Wired Equivalent Privacy — This is a method for encrypting communication data. The encryption key is created and notified only to the communicating user, so the communication data cannot be decrypted by a third party.

XGA — Extended Video Graphics Array — 1024 x 768 pixels count.

Zoom Lens — Lens with a variable focal length that allows operator to move the view in or out making the image smaller or larger.

Zoom Lens Ratio — Is the ratio between the smallest and largest image a lens can project from a fixed distance. For example, a 1.4:1 zoom lens ratio means that a 10 foot image without zoom would be a 14 foot image with full zoom.

Index

A

Adjusting the Projected Image 23

Adjusting the Projector Height
23

lower the projector

Elevator button 23

Elevator foot 23

Tilt adjustment wheel 23

Adjusting the Projector Zoom and
Focus 24

Focus ring 24

Zoom tab 24

Audio Input 46

Audio Settings 46

Audio-B 9

Audio-C 9

audio-C 9

C

Capture Screen 45

Changing the Lamp 85

Closed Caption 49

Connecting the Projector

Composite video cable 16

Connecting a Computer with a
RS232 cable 13

Connecting with a Component
Cable 17

Connecting with a Composite
Cable 16

Connecting with an HDMI
Cable 18

Connecting with an S-video
Cable 15

HDMI cable 18, 19, 21

Power cord 11, 12, 13, 15, 16,
17, 18, 19, 20, 21

RS232 cable 13

S-video cable 15

To Computer 11

USB to USB cable 11

VGA to VGA cable 11, 12

VGA to YPbPr cable 17

Connection Ports

Audio input connector 9

Audio output connector 9

Composite video connector 9

Power cord connector 9

RS232 connector 9

Security cable slot 9

S-video connector 9

USB remote connector 9

VGA-A input (D-sub) connector
9

VGA-A output (monitor
loop-through) 9

VGA-B input (D-sub) connector
9

Contact Dell 6, 81, 85

Control Panel 27

D

DC Adapter 9

Dell

contacting 92

H

HDMI 9

M

Main Unit 7

Control panel 7

Elevator button 7

Focus ring 7

IR receiver 7

Lens 7

Zoom tab 7

Menu Position 45

Menu Settings 44

Menu Timeout 45

Menu Transparency 45

Mute 46

O

On-Screen Display 34

Auto-Adjust 36

Display (in PC Mode) 38

Display (in Video Mode) 40

Input Select 35

Lamp 41

Main Menu 34

Others 44

Picture (in PC Mode) 36

Picture (in Video Mode) 37

Set Up 41

P

Password 47

phone numbers 92

Power Saving 46

Power Settings 46

Powering On/Off the Projector

Powering Off the Projector 22

Powering On the Projector 22

Q

Quick Shutdown 47

R

Remote Control 29

IR receiver 28

Reset 45

Reset, Factory 50

RJ45 9

S

Screen 45

Screen Settings 45

Security Settings 47

Speaker 46

Specifications

Audio 88

Brightness 87

Color Wheel Speed 87

Contrast Ratio 87

Dimensions 88

Displayable Color 87

Environmental 88

I/O Connectors 88

Light Valve 87

Noise Level 88

Number of Pixels 87

Power Consumption 87

Power Supply 87

Projection Distance 87

Projection Lens 87

Projection Screen Size 87

RS232 Protocol 90

Uniformity 87

Video Compatibility 87

Weight 88

support

contacting Dell 92

T

telephone numbers 92

Test Pattern 50

Troubleshooting 79

Contact Dell 79

V

Volume 46

Free Manuals Download Website

<http://myh66.com>

<http://usermanuals.us>

<http://www.somanuals.com>

<http://www.4manuals.cc>

<http://www.manual-lib.com>

<http://www.404manual.com>

<http://www.luxmanual.com>

<http://aubethermostatmanual.com>

Golf course search by state

<http://golfingnear.com>

Email search by domain

<http://emailbydomain.com>

Auto manuals search

<http://auto.somanuals.com>

TV manuals search

<http://tv.somanuals.com>