

# Dell PowerEdge R620 Getting Started Guide

**Regulatory Model: E16S Series**  
**Regulatory Type: E16S001**



# Notes, Cautions, and Warnings



**NOTE:** A NOTE indicates important information that helps you make better use of your computer.



**CAUTION:** A CAUTION indicates potential damage to hardware or loss of data if instructions are not followed.



**WARNING:** A WARNING indicates a potential for property damage, personal injury, or death.

Information in this publication is subject to change without notice.

© 2011 Dell Inc. All rights reserved. Printed in the U.S.A.

Reproduction of these materials in any manner whatsoever without the written permission of Dell Inc. is strictly forbidden.

Trademarks used in this text: Dell™, the Dell logo, Dell Precision™, OptiPlex™, Latitude™, PowerEdge™, PowerVault™, PowerConnect™, OpenManage™, EqualLogic™, Compellent™, KACE™, FlexAddress™ and Vostro™ are trademarks of Dell Inc. Intel®, Pentium®, Xeon®, Core® and Celeron® are registered trademarks of Intel Corporation in the U.S. and other countries. AMD® is a registered trademark and AMD Opteron™, AMD Phenom™ and AMD Sempron™ are trademarks of Advanced Micro Devices, Inc. Microsoft®, Windows®, Windows Server®, Internet Explorer®, MS-DOS® and Windows Vista® are either trademarks or registered trademarks of Microsoft Corporation in the United States and/or other countries. Red Hat® and Red Hat® Enterprise Linux® are registered trademarks of Red Hat, Inc. in the United States and/or other countries. Novell® and SUSE® are registered trademarks of Novell Inc. in the United States and other countries. Oracle® is a registered trademark of Oracle Corporation and/or its affiliates. Citrix®, Xen®, XenServer® and XenMotion® are either registered trademarks or trademarks of Citrix Systems, Inc. in the United States and/or other countries. VMware®, Virtual SMP®, vMotion®, vCenter® and vSphere® are registered trademarks or trademarks of VMware, Inc. in the United States or other countries. IBM® is a registered trademark of International Business Machines Corporation.

Other trademarks and trade names may be used in this publication to refer to either the entities claiming the marks and names or their products. Dell Inc. disclaims any proprietary interest in trademarks and trade names other than its own.

2011 — 07

Rev. A00

# Installation And Configuration

 **WARNING:** Before performing the following procedure, review the safety instructions that came with the system.

## Unpacking a Rack System

Unpack your system and identify each item.

Assemble the rails and install the system in the rack following the safety instructions and the rack installation instructions provided with your system.

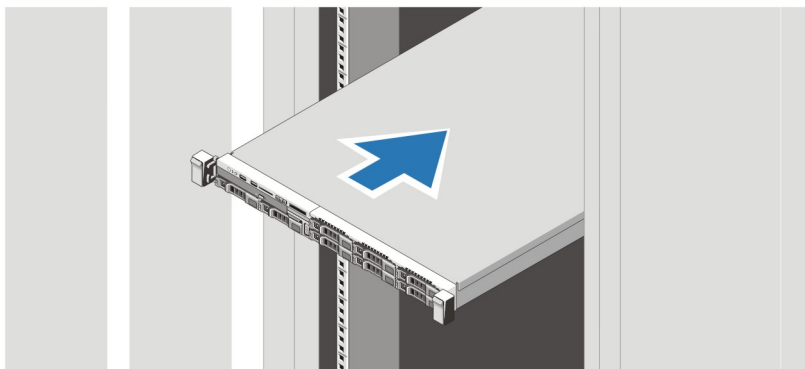

**Figure 1. Installing the Rails and System in a Rack**

## Optional—Connecting the Keyboard, Mouse, and Monitor

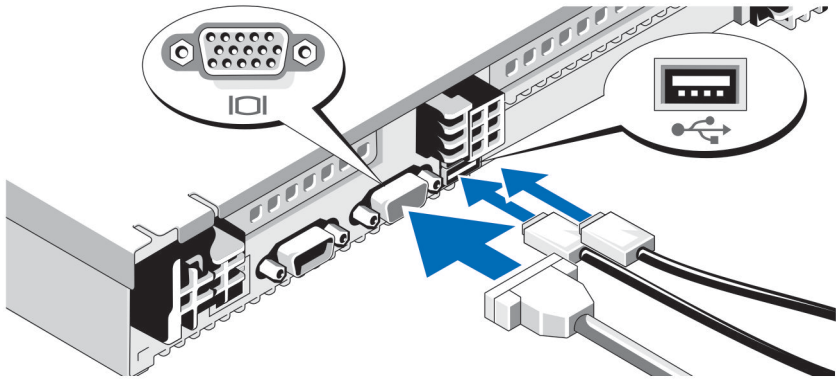
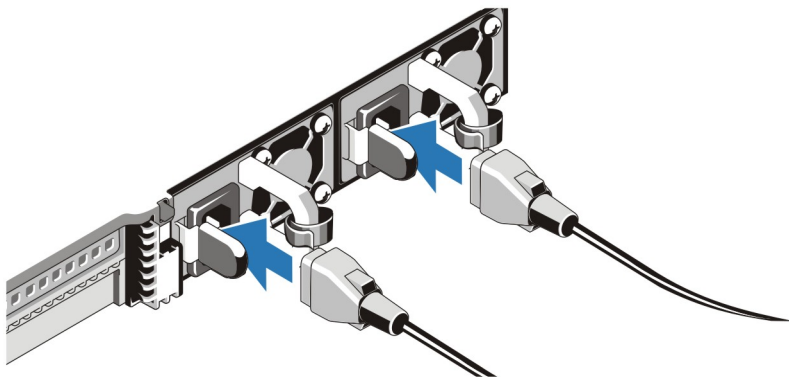

**Figure 2. Connecting Keyboard, Mouse, and Monitor**

Connect the keyboard, mouse, and monitor (optional).

The connectors on the back of your system have icons indicating which cable to plug into each connector. Be sure to tighten the screws (if any) on the monitor's cable connector.

## Connecting The Power Cable(s)



**Figure 3. Connecting Power Cable(s)**

Connect the system's power cable(s) to the system and, if a monitor is used, connect the monitor's power cable to the monitor.

## Securing The Power Cable(s)

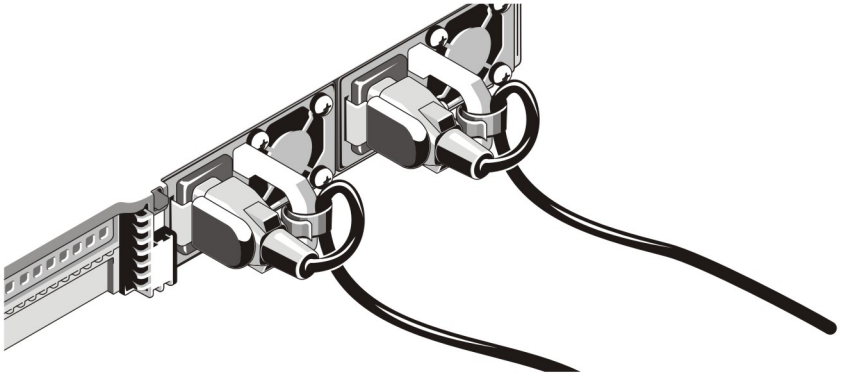
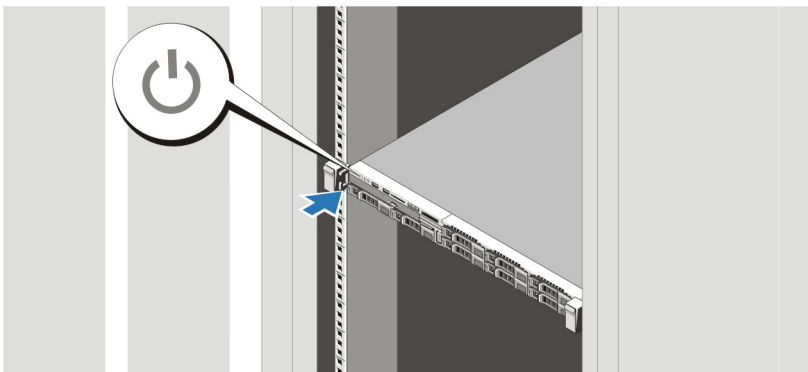

**Figure 4. Securing Power Cable(s)**

Bend the system power cable(s), as shown in the illustration, and attach to the cable strap.

Plug the other end of the power cable(s) into a grounded electrical outlet or a separate power source such as an uninterruptible power supply (UPS) or a power distribution unit (PDU).

## Turning On The System



**Figure 5. Turning on the System**

Press the power button on the system. The power indicator should light.

## Installing The Optional Bezel

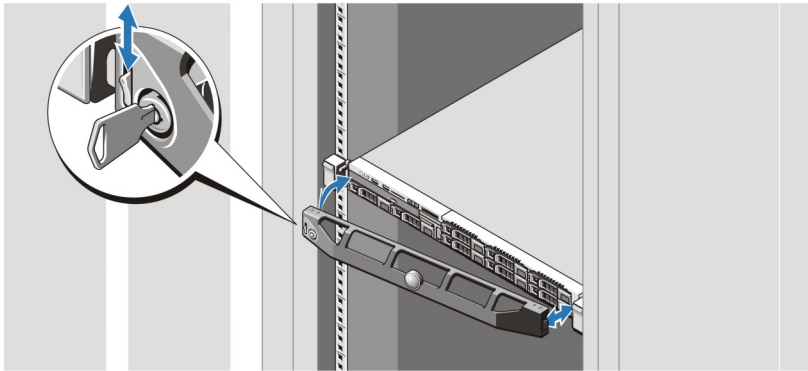

**Figure 6. Installing the Bezel**

Install the bezel (optional).

## Complete The Operating System Setup

If you purchased a preinstalled operating system, see the documentation associated with the operating system. To install an operating system for the first time, see the installation and configuration documentation for your operating system. Be sure the operating system is installed before installing hardware or software not purchased with the system.



**NOTE:** For the latest information on supported operating systems, see [dell.com/ossupport](http://dell.com/ossupport).

## Dell Software License Agreement

Before using your system, read the Dell Software License Agreement that came with your system. You must consider any media of Dell-installed software as BACKUP copies of the software installed on your system's hard drive. If you do not accept the terms of the agreement, call the customer assistance telephone number. For customers in the United States, call 800-WWW-DELL (800-999-3355). For customers outside the United States, visit [support.dell.com](http://support.dell.com) and select your country or region from the top of the page.

# Other Information You May Need



**WARNING:** See the safety and regulatory information that shipped with your system. Warranty information may be included within this document or as a separate document.

- The *Owner's Manual* provides information about system features and describes how to troubleshoot the system and install or replace system components. This document is available online at [support.dell.com/manuals](http://support.dell.com/manuals).
- The rack documentation included with your rack solution describes how to install your system into a rack, if required.
- Any media that ships with your system that provides documentation and tools for configuring and managing your system, including those pertaining to the operating system, system management software, system updates, and system components that you purchased with your system.



**NOTE:** Always check for updates on [support.dell.com/manuals](http://support.dell.com/manuals) and read the updates first because they often supersede information in other documents.

## Obtaining Technical Assistance

If you do not understand a procedure in this guide or if the system does not perform as expected, see your *Owner's Manual*. Dell offers comprehensive hardware training and certification. See [dell.com/training](http://dell.com/training) for more information. This service may not be offered in all locations.

## NOM Information

The following information is provided on the device described in this document in compliance with the requirements of the official Mexican standards (NOM):

Importer:	Dell Inc. de México, S.A. de C.V. Paseo de la Reforma 2620 -11º Piso Col. Lomas Altas 11950 México, D.F.
Model number:	E16S
Supply voltage:	100–240 V CA (with 495 W, 750 W, and 1100 W AC Power Supply Unit) or –(48–60) V de CC (with 1100 W DC power supply unit)

Frequency:	50 Hz/60 Hz (AC power supply unit)
Current consumption:	12 A – 6.5 A (X 2) (with 1100 W AC power supply unit) 10 A – 5 A (X 2) (with 750 W AC power supply unit) 6.5 A – 3 A (X 2) (with 495 W AC power supply unit) 32 A (X 2) (with 1100 W DC power supply unit)

## Technical Specifications

 **NOTE:** The following specifications are only those required by law to ship with your system. For a complete and current listing of the specifications for your system, go to [support.dell.com](http://support.dell.com).

---

### Power

---

#### AC Power Supply (per power supply)

Wattage	495 W, 750 W, or 1100 W
Heat dissipation	1908 BTU/hr maximum (495 W power supply) 2891 BTU/hr maximum (750 W power supply) 4100 BTU/hr maximum (1100 W power supply)
Voltage	100–240 V AC, autoranging, 50/60 Hz

 **NOTE:** This system is also designed to be connected to IT power systems with a phase to phase voltage not exceeding 230 V.

#### DC Power Supply (per power supply) (when available)

Wattage	1100 W
Heat dissipation	4416 BTU/hour maximum
Voltage	–(48–60) V DC

 **NOTE:** Heat dissipation is calculated using the power supply wattage rating.



---

## Power

---

### Battery

Coin-cell battery	3 V CR2032 Lithium coin cell
-------------------	------------------------------

---

## Physical

---

Height	42.8 mm (1.68 inch)
Width	482.4 mm (18.99 inch) with rack latches. 434 mm (17.08 inch) without rack latches.
Depth	
Ten-hard-drive systems	755.12 mm (29.73 inch)
Eight-hard-drive systems	700.5 mm (27.58 inch)
Weight (maximum configuration)	
Ten-hard-drive systems	19.76 kg (43.56 lb)
Eight-hard-drive systems	18.58 kg (40.96 lb)
Weight (empty)	
Ten-hard-drive systems	9.37 kg (20.66 lb)
Eight-hard-drive systems	8.58 kg (18.92 lb)

---

## Environmental

---

 **NOTE:** For additional information about environmental measurements for specific system configurations, see [dell.com/environmental\\_datasheets](http://dell.com/environmental_datasheets).

### Temperature

Operating	Continuous operation: 10 °C to 35 °C at 10% to 80% relative humidity (RH), with 26 °C max dew point. De-rate maximum allowable dry bulb temperature at 1 °C/300 m above 900 m (1°F per 550 ft).
-----------	---

 **NOTE:** For information on supported expanded operating temperature range and configurations, see [support.dell.com/manuals](http://support.dell.com/manuals).

---

## Environmental

---

Storage –40 °C to 65 °C (–40 °F to 149 °F) with a maximum temperature gradation of 20 °C per hour

### Relative humidity

Operating 20% to 80% (noncondensing) at a maximum wet bulb temperature of 29 °C (84.2 °F)

Storage 5% to 95% at a maximum wet bulb temperature of 38 °C (100.4 °F)

### Maximum vibration

Operating 0.26 Grms at 5 Hz to 350 Hz (all operation orientations)

Storage 1.87 Grms at 10 Hz to 500 Hz for 15 min (all six sides tested)

### Maximum shock

Operating One shock pulse in the positive z axis (one pulse on each side of the system) of 31 G for 2.6 ms in the operational orientation

Storage Six consecutively executed shock pulses in the positive and negative x, y, and z axes (one pulse on each side of the system) of 71 G for up to 2 ms  
Six consecutively executed shock pulses in the positive and negative x, y, and z axes (one pulse on each side of the system) of 32 G faired square wave pulse with velocity change at 270 inches/second (685 centimeters/second)

### Altitude

Operating –15.2 m to 3048 m (–50 to 10,000 ft)



**NOTE:** For altitudes above 2950 ft, the maximum operating temperature is derated 1 °F/550 ft.

---

**Environmental**

---

Storage -15.2 m to 10,668 m (-50 ft to 35,000 ft)

**Airborne Contaminant Level**

Class G1 as defined by ISA-S71.04-1985

## Free Manuals Download Website

<http://myh66.com>

<http://usermanuals.us>

<http://www.somanuals.com>

<http://www.4manuals.cc>

<http://www.manual-lib.com>

<http://www.404manual.com>

<http://www.luxmanual.com>

<http://aubethermostatmanual.com>

Golf course search by state

<http://golfingnear.com>

Email search by domain

<http://emailbydomain.com>

Auto manuals search

<http://auto.somanuals.com>

TV manuals search

<http://tv.somanuals.com>