

24 ³/₄" Planer

(Model 22-610, Three Phase)

INSTRUCTION MANUAL



PART NO. 428-08-651-0001 06-15-05
Copyright © 2005 Delta Machinery

 **DELTA[®] INDUSTRIAL**

To learn more about DELTA MACHINERY
visit our website at: www.deltamachinery.com.

**For Parts, Service, Warranty or other Assistance,
please call 1-800-223-7278 (In Canada call 1-800-463-3582).**

TABLE OF CONTENTS

IMPORTANT SAFETY INSTRUCTIONS2
SAFETY GUIDELINES3
GENERAL SAFETY RULES4
ADDITIONAL SPECIFIC SAFETY RULES5
FUNCTIONAL DESCRIPTION6
CARTON CONTENTS7
ASSEMBLY8
OPERATION10
TROUBLESHOOTING20
MAINTENANCE20
SERVICE21
ACCESSORIES21
WARRANTY21
SERVICE CENTER LOCATIONSback cover

IMPORTANT SAFETY INSTRUCTIONS

▲ WARNING Read and understand all warnings and operating instructions before using any tool or equipment. When using tools or equipment, basic safety precautions should always be followed to reduce the risk of personal injury. Improper operation, maintenance or modification of tools or equipment could result in serious injury and property damage. There are certain applications for which tools and equipment are designed. Delta Machinery strongly recommends that this product NOT be modified and/or used for any application other than for which it was designed.

If you have any questions relative to its application DO NOT use the product until you have written Delta Machinery and we have advised you.

Online contact form at www.deltamachinery.com

Postal Mail: Technical Service Manager
Delta Machinery
4825 Highway 45 North
Jackson, TN 38305

(IN CANADA: 125 Mural St. Suite 300, Richmond Hill, ON, L4B 1M4)

Information regarding the safe and proper operation of this tool is available from the following sources:

Power Tool Institute
1300 Sumner Avenue, Cleveland, OH 44115-2851
www.powertoolinstitute.org

National Safety Council
1121 Spring Lake Drive, Itasca, IL 60143-3201

American National Standards Institute, 25 West 43rd Street, 4 floor, New York, NY 10036 www.ansi.org
ANSI 01.1 Safety Requirements for Woodworking Machines, and

the U.S. Department of Labor regulations www.osha.gov

SAVE THESE INSTRUCTIONS!

SAFETY GUIDELINES - DEFINITIONS

It is important for you to read and understand this manual. The information it contains relates to protecting YOUR SAFETY and PREVENTING PROBLEMS. The symbols below are used to help you recognize this information.



- ▲ DANGER** Indicates an imminently hazardous situation which, if not avoided, will result in death or serious injury.
- ▲ WARNING** Indicates a potentially hazardous situation which, if not avoided, could result in death or serious injury.
- ▲ CAUTION** Indicates a potentially hazardous situation which, if not avoided, may result in minor or moderate injury.
- CAUTION** Used without the safety alert symbol indicates potentially hazardous situation which, if not avoided, may result in property damage.

CALIFORNIA PROPOSITION 65

▲ WARNING **SOME DUST CREATED BY POWER SANDING, SAWING, GRINDING, DRILLING, AND OTHER CONSTRUCTION ACTIVITIES** contains chemicals known to cause cancer, birth defects or other reproductive harm.

Some examples of these chemicals are:

- lead from lead-based paints,
- crystalline silica from bricks and cement and other masonry products, and
- arsenic and chromium from chemically-treated lumber.

Your risk from these exposures varies, depending on how often you do this type of work. To reduce your exposure to these chemicals: work in a well ventilated area, and work with approved safety equipment, always wear **NIOSH/OSHA** approved, properly fitting face mask or respirator when using such tools.

GENERAL SAFETY RULES



▲ WARNING READ AND UNDERSTAND ALL WARNINGS AND OPERATING INSTRUCTIONS BEFORE USING THIS EQUIPMENT. Failure to follow all instructions listed below, may result in electric shock, fire, and/or serious personal injury or property damage.

IMPORTANT SAFETY INSTRUCTIONS

- 1. FOR YOUR OWN SAFETY, READ THE INSTRUCTION MANUAL BEFORE OPERATING THE MACHINE.** Learning the machine's application, limitations, and specific hazards will greatly minimize the possibility of accidents and injury.
- 2. WEAR EYE AND HEARING PROTECTION. ALWAYS USE SAFETY GLASSES.** Everyday eyeglasses are NOT safety glasses. USE CERTIFIED SAFETY EQUIPMENT. Eye protection equipment should comply with ANSI Z87.1 standards. Hearing equipment should comply with ANSI S3.19 standards.
- 3. WEAR PROPER APPAREL.** Do not wear loose clothing, gloves, neckties, rings, bracelets, or other jewelry which may get caught in moving parts. Nonslip footwear is recommended. Wear protective hair covering to contain long hair.
- 4. DO NOT USE THE MACHINE IN A DANGEROUS ENVIRONMENT.** The use of power tools in damp or wet locations or in rain can cause shock or electrocution. Keep your work area well-lit to prevent tripping or placing arms, hands, and fingers in danger.
- 5. MAINTAIN ALL TOOLS AND MACHINES IN PEAK CONDITION.** Keep tools sharp and clean for best and safest performance. Follow instructions for lubricating and changing accessories. Poorly maintained tools and machines can further damage the tool or machine and/or cause injury.
- 6. CHECK FOR DAMAGED PARTS.** Before using the machine, check for any damaged parts. Check for alignment of moving parts, binding of moving parts, breakage of parts, and any other conditions that may affect its operation. A guard or any other part that is damaged **should be properly repaired or replaced.** Damaged parts can cause further damage to the machine and/or injury.
- 7. KEEP THE WORK AREA CLEAN.** Cluttered areas and benches invite accidents.
- 8. KEEP CHILDREN AND VISITORS AWAY.** Your shop is a potentially dangerous environment. Children and visitors can be injured.
- 9. REDUCE THE RISK OF UNINTENTIONAL STARTING.** Make sure that the switch is in the "OFF" position before plugging in the power cord. In the event of a power failure, move the switch to the "OFF" position. An accidental start-up can cause injury.
- 10. USE THE GUARDS.** Check to see that all guards are in place, secured, and working correctly to reduce the risk of injury.
- 11. REMOVE ADJUSTING KEYS AND WRENCHES BEFORE STARTING THE MACHINE.** Tools, scrap pieces, and other debris can be thrown at high speed, causing injury.
- 12. USE THE RIGHT MACHINE.** Don't force a machine or an attachment to do a job for which it was not designed. Damage to the machine and/or injury may result.
- 13. USE RECOMMENDED ACCESSORIES.** The use of accessories and attachments not recommended by Delta may cause damage to the machine or injury to the user.
- 14. USE THE PROPER EXTENSION CORD.** Make sure your extension cord is in good condition. When using an extension cord, be sure to use one heavy enough to carry the current your product will draw. An undersized cord will cause a drop in line voltage, resulting in loss of power and overheating. See the Extension Cord Chart for the correct size depending on the cord length and nameplate ampere rating. If in doubt, use the next heavier gauge. The smaller the gauge number, the heavier the cord.
- 15. SECURE THE WORKPIECE.** Use clamps or a vise to hold the workpiece when practical. Loss of control of a workpiece can cause injury.
- 16. FEED THE WORKPIECE AGAINST THE DIRECTION OF THE ROTATION OF THE BLADE, CUTTER, OR ABRASIVE SURFACE.** Feeding it from the other direction will cause the workpiece to be thrown out at high speed.
- 17. DON'T FORCE THE WORKPIECE ON THE MACHINE.** Damage to the machine and/or injury may result.
- 18. DON'T OVERREACH.** Loss of balance can make you fall into a working machine, causing injury.
- 19. NEVER STAND ON THE MACHINE.** Injury could occur if the tool tips, or if you accidentally contact the cutting tool.
- 20. NEVER LEAVE THE MACHINE RUNNING UNATTENDED. TURN THE POWER OFF.** Don't leave the machine until it comes to a complete stop. A child or visitor could be injured.
- 21. TURN THE MACHINE "OFF", AND DISCONNECT THE MACHINE FROM THE POWER SOURCE** before installing or removing accessories, before adjusting or changing set-ups, or when making repairs. An accidental start-up can cause injury.
- 22. MAKE YOUR WORKSHOP CHILDPROOF WITH PADLOCKS, MASTER SWITCHES, OR BY REMOVING STARTER KEYS.** The accidental start-up of a machine by a child or visitor could cause injury.
- 23. STAY ALERT, WATCH WHAT YOU ARE DOING, AND USE COMMON SENSE. DO NOT USE THE MACHINE WHEN YOU ARE TIRED OR UNDER THE INFLUENCE OF DRUGS, ALCOHOL, OR MEDICATION.** A moment of inattention while operating power tools may result in injury.
- 24. ▲ WARNING USE OF THIS TOOL CAN GENERATE AND DISBURSE DUST OR OTHER AIRBORNE PARTICLES, INCLUDING WOOD DUST, CRYSTALLINE SILICA DUST AND ASBESTOS DUST.** Direct particles away from face and body. Always operate tool in well ventilated area and provide for proper dust removal. Use dust collection system wherever possible. Exposure to the dust may cause serious and permanent respiratory or other injury, including silicosis (a serious lung disease), cancer, and death. Avoid breathing the dust, and avoid prolonged contact with dust. Allowing dust to get into your mouth or eyes, or lay on your skin may promote absorption of harmful material. Always use properly fitting NIOSH/OSHA approved respiratory protection appropriate for the dust exposure, and wash exposed areas with soap and water.

ADDITIONAL SPECIFIC SAFETY RULES

▲ WARNING

FAILURE TO FOLLOW THESE RULES MAY RESULT IN SERIOUS INJURY.

1. **DO NOT OPERATE THIS MACHINE** until it is completely assembled and installed according to the instructions. A machine incorrectly assembled can cause serious injury.
2. **OBTAIN ADVICE** from your supervisor, instructor, or another qualified person if you are not thoroughly familiar with the operation of this machine. Knowledge is safety.
3. **FOLLOW ALL WIRING CODES** and recommend electrical connections to prevent shock or electrocution.
4. **KEEP KNIVES SHARP** and free from rust and pitch. Dull or rusted knives work harder and can cause kickback.
5. **NEVER TURN THE MACHINE "ON"** before clearing the table of all objects (tools, scraps of wood, etc.). Flying debris can cause serious injury.
6. **NEVER TURN THE MACHINE "ON"** with the workpiece contacting the cutterhead. Kickback can occur.
7. **SECURE THE MACHINE TO A SUPPORTING SURFACE** to prevent the machine from sliding, walking or tipping over.
8. **PROPERLY SECURE THE KNIVES IN THE CUTTERHEAD** before turning the power "ON". Loose blades may be thrown out at high speeds causing serious injury.
9. **LOCK THE SPEED SETTING SECURELY** before feeding the workpiece through the machine. Changing speeds while planing can cause kick-back.
10. **AVOID AWKWARD OPERATIONS AND HAND POSITIONS.** A sudden slip could cause a hand to move into the knives.
11. **KEEP ARMS, HANDS, AND FINGERS** away from the cutterhead, the chip exhaust opening, and the feed rollers to prevent severe cuts.
12. **NEVER REACH INTO THE CUTTERHEAD AREA** while the machine is running. Your hands can be drawn into the knives.
13. **DO NOT STAND IN LINE OF THE WORKPIECE.** Kickback can cause injury.
14. **ALLOW THE CUTTERHEAD TO REACH FULL SPEED** before feeding a workpiece. Changing speeds while planing can cause kickback.
15. **WHEN PLANING BOWED STOCK,** place the concave (cup down) side of the stock on the table and cut with the grain to prevent kickback.
16. **DO NOT FEED A WORKPIECE** that is warped, contains knots, or is embedded with foreign objects (nails, staples, etc.). Kickback can occur.
17. **DO NOT FEED A SHORT, THIN, OR NARROW WORKPIECE INTO THE MACHINE.** Your hands can be drawn into the knives and/or the workpiece can be thrown at high speeds. See the "OPERATION" section of this instruction manual for details.
18. **DO NOT FEED A WORKPIECE** into the outfeed end of the machine. The workpiece will be thrown out of the opposite side at high speeds.
19. **REMOVE SHAVINGS ONLY** with the power "OFF" to prevent serious injury.
20. **PROPERLY SUPPORT LONG OR WIDE WORKPIECES.** Loss of control of the workpiece can cause serious injury.
21. **NEVER PERFORM LAYOUT, ASSEMBLY** or set-up work on the table/work area when the machine is running. Serious injury will result.
22. **TURN THE MACHINE "OFF", DISCONNECT IT FROM THE POWER SOURCE,** and clean the table/work area before leaving the machine. **LOCK THE SWITCH IN THE "OFF" POSITION** to prevent unauthorized use. Someone else might accidentally start the machine and cause injury to themselves or others.
23. **ADDITIONAL INFORMATION** regarding the safe and proper operation of power tools (i.e. a safety video) is available from the Power Tool Institute, 1300 Sumner Avenue, Cleveland, OH 44115-2851 (www.powertoolinstitute.com). Information is also available from the National Safety Council, 1121 Spring Lake Drive, Itasca, IL 60143-3201. Please refer to the American National Standards Institute ANSI O1.1 Safety Requirements for Woodworking Machines and the U.S. Department of Labor Regulations.

SAVE THESE INSTRUCTIONS.

Refer to them often and use them to instruct others.

POWER CONNECTIONS

A separate electrical circuit should be used for your machines. This circuit should not be less than #12 wire and should be protected with a 20 Amp time lag fuse. If an extension cord is used, use only 3-wire extension cords which have 3-prong grounding type plugs and matching receptacle which will accept the machine's plug. Before connecting the machine to the power line, make sure the switch (s) is in the "OFF" position and be sure that the electric current is of the same characteristics as indicated on the machine. All line connections should make good contact. Running on low voltage will damage the machine.

⚠ DANGER DO NOT EXPOSE THE MACHINE TO RAIN OR OPERATE THE MACHINE IN DAMP LOCATIONS.

MOTOR SPECIFICATIONS

The 22-610 has a 10 HP three phase motor that comes wired at 230 volts and 60 HZ alternating current. The motor is also capable of being wired for 460 volt operation, but this connection must be done by a qualified electrician and conform to the National Electric Code and all local codes and ordinances.

GROUNDING INSTRUCTIONS

⚠ DANGER THIS MACHINE MUST BE GROUNDED WHILE IN USE TO PROTECT THE OPERATOR FROM ELECTRIC SHOCK.

These machines are not supplied with power cords and they are intended to be permanently connected to the building's electrical system. All wiring must be done by a qualified electrician and conform to the National Electric Code and all local codes and ordinances. For wiring instructions, see section "ELECTRICAL CONNECTIONS" in this manual.

FUNCTIONAL DESCRIPTION

FOREWORD

The Delta Industrial Model 22-610 is a 24 3/4" Planer with a 10 HP, three-phase motor capable of 230 volt or 460 volt operation with an LVC magnetic starter and automatic reset overload protection; 4-knife cutterhead, infeed and out-feed rollers, chipbreakers, dust chute, knife-setting gauge and wrench.

NOTICE: THE PHOTO ON THE MANUAL COVER ILLUSTRATES THE CURRENT PRODUCTION MODEL. ALL OTHER ILLUSTRATIONS CONTAINED IN THE MANUAL ARE REPRESENTATIVE ONLY AND MAY NOT DEPICT THE ACTUAL COLOR, LABELING OR ACCESSORIES AND ARE INTENDED TO ILLUSTRATE TECHNIQUE ONLY.

CARTON CONTENTS

The 22-610 planer is shipped complete in one container mounted to a shipping skid. Remove the wooden crate from around the machine. The planer is shipped with the motor, motor pulleys and belts assembled to the machine. Fig. 2, illustrates the loose items supplied with the machine.

1. Planer
2. Cutterhead guard.
3. Dust chute
4. Knife guage
5. Open end wrenches
6. Hex wrenches
7. Gauge block

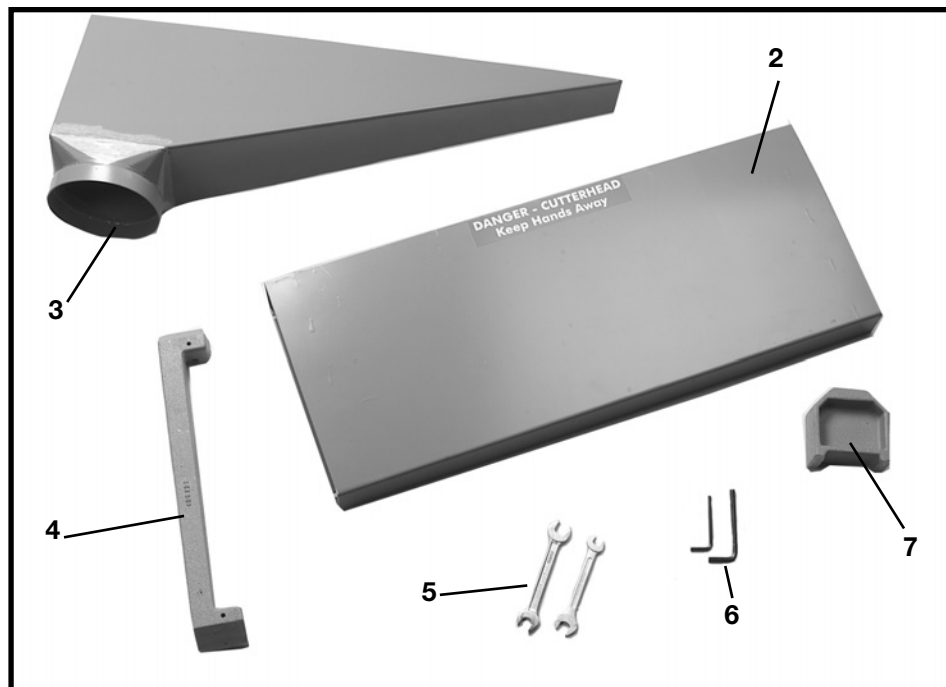

UNPACKING AND CLEANING

Carefully unpack the machine and all loose items from the shipping container(s). Remove the protective coating from all unpainted surfaces. This coating may be removed with a soft cloth moistened with kerosene (do not use acetone, gasoline or lacquer thinner for this purpose). After cleaning, cover the unpainted surfaces with a good quality household floor paste wax.

ASSEMBLY

ASSEMBLY TOOLS REQUIRED

- * Open end wrenches (supplied)
- * Hex wrenches (supplied)
- * Flat screwdriver (not supplied)

ASSEMBLY TIME ESTIMATE - 2-3 hours

UNLOADING AND POSITIONING MACHINE

This machine should be unloaded using a crane and slings around and under the table on both sides, as shown in Fig. 2. Lift the machine slowly, making sure it is well balanced, and lower it carefully.

Using rollers or a similar hauling device, push the machine to the desired working site. Once the machine is in position it should be leveled and positioned on hard rubber pads placed underneath the four corners.

Remove protective coating from the table, bed rolls, feed rolls and cutterhead. This coating may be removed with a stiff brush and/or soft cloth moistened with kerosene (do not use acetone, gasoline or lacquer thinner for this purpose).

⚠WARNING CARE MUST BE TAKEN WHEN CLEANING THE CUTTERHEAD AS THE KNIVES ARE IN THE CUTTERHEAD AND THESE KNIVES ARE VERY SHARP.

After cleaning table, cover table surface with a good quality paste wax.

ELECTRICAL CONNECTIONS

Before connecting your machine to an electrical power system, make sure the motor rating agrees with the electrical system it is to be connected to. The 24" Planer is shipped wired for 230 volts, three phase operation.

If you desire to operate your planer at 460 volts, three phase operation, refer to the Electrical Instruction Manual supplied with your planer for detailed instructions on Changing Voltage of LVC Motor Starters. Three STEPS must be followed when changing line voltage. These steps are as follows:

1. Change leads in the motor junction box for the proper line voltage, as shown on the motor nameplate. Refer to Fig. 3.
2. Move the transformer primary pigtail to the proper terminal corresponding to the new input voltage.

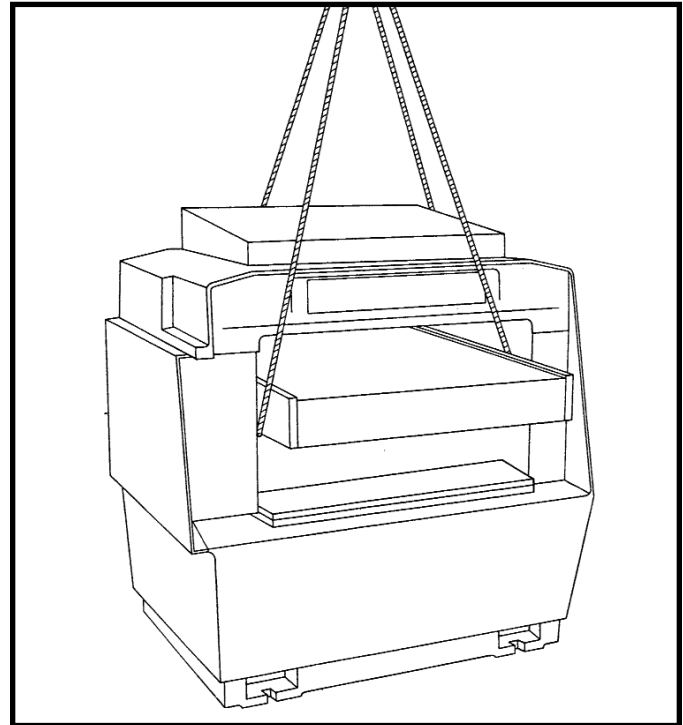

Fig. 2

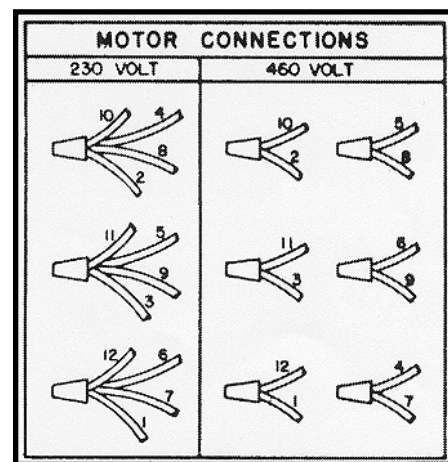

Fig. 3

3. Change the heater elements in the overload block for the proper voltage/amperage rating shown on the motor nameplate.

These three steps are clearly explained in the electrical instructions supplied with your planer.

To connect power to your machine, proceed as follows for either 200-230/460 volts, three phase operation.

1. Remove the four screws, one of which is shown at (A) Fig. 4, and remove cover (B).
2. Insert power line through entrance hole (E) and connect the three power lines to terminals L1, L2 and L3 (shown at C). The green ground wire should be connected to the ground terminal (J).
3. Replace cover (B) Fig. 4.

IMPORTANT: If after the machine is in operation, the cutterhead turns in the wrong direction, interchange any two of the three power lines (C) that are connected to terminals L1, L2 and L3.

OVERLOAD PROTECTION

Your planer is provided with overload protection which will shutoff the motor if the planer is overloaded or if line voltage falls below safe levels, lithe motor shuts off due to overloading or low voltage, let the motor cool three to five minutes. The overload block supplied with this planer will automatically reset itself and the machine can be started again by pushing the start button. If the machine continually shuts off due to overloading, the cause of overloading must be corrected. If this happens, it is recommended you obtain advice from a qualified electrician.

ASSEMBLING CUTTERHEAD GUARD AND DUST CHUTE

To assemble the cutterhead guard:

1. **⚠ WARNING DISCONNECT MACHINE FROM POWER SOURCE**
2. Remove four screws and washers at (A) Fig. 6.
3. Place guard on planer cover (C) so that the holes in the guard (B) align with the holes in the cover (C).
4. Replace screws and washer removed in Step 1.
5. Remove three screws (E) Fig. 7 on planer cover (C).
6. Place dust chute on cover so that the holes in the dust chute (D) align with the holes in the cover (C).
7. Replace the screws and washers removed in Step 5.
8. The cutterhead guard (B) Fig. 7A and dust chute (D) Fig. 7A should be arranged as shown in Fig. 7A

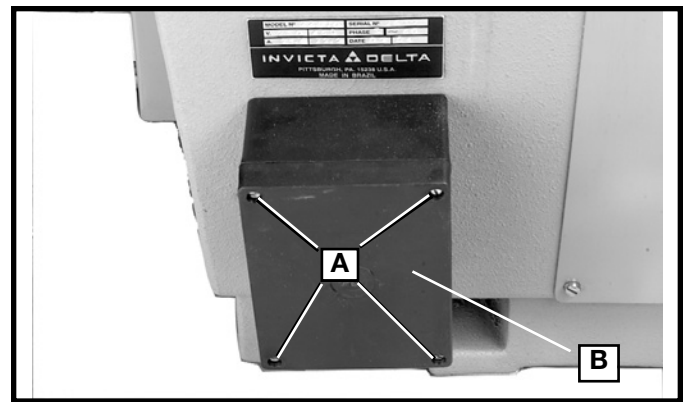

Fig. 4

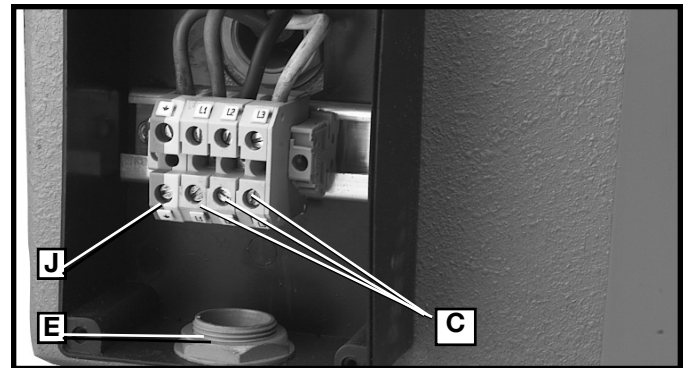

Fig. 5

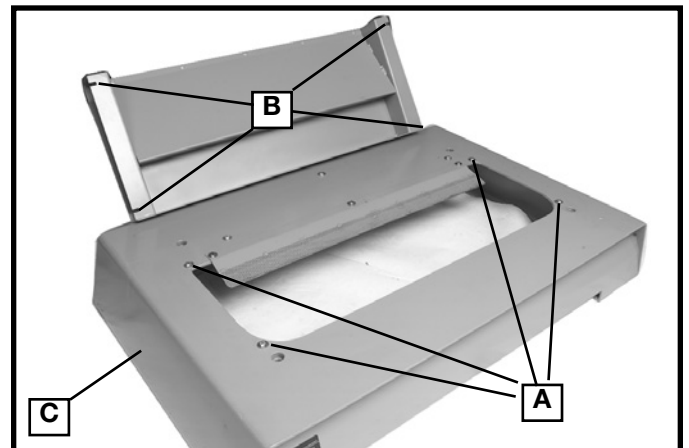

Fig. 6

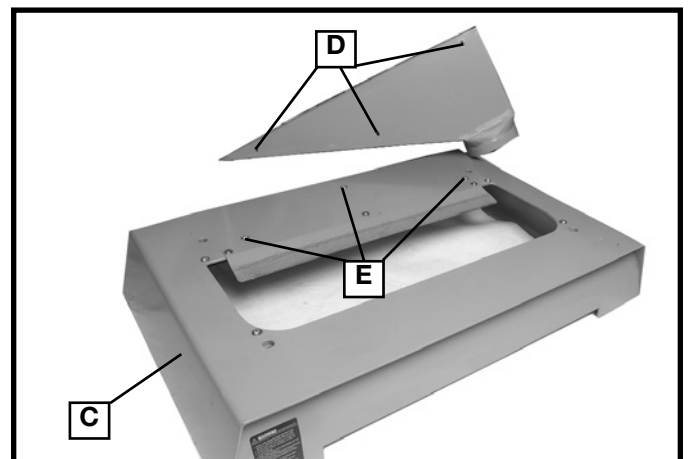

Fig. 7

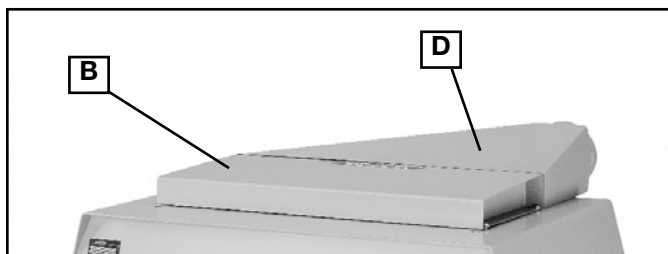

Fig. 7A

OPERATION

OPERATIONAL CONTROLS AND ADJUSTMENTS

STARTING AND STOPPING THE PLANER

The machine is started by pressing the green (shrouded) "ON" button (A) and stopped by pressing the red (mushroom type) "OFF" button (B), as shown in Fig. 8.

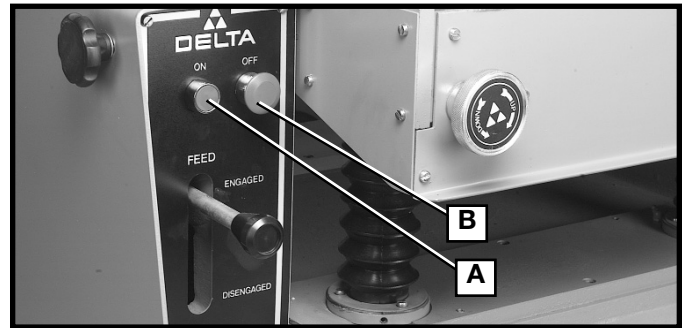

Fig. 8

TABLE RAISING AND LOWERING CONTROLS

⚠ WARNING DISCONNECT MACHINE FROM POWER SOURCE

For fast easy changes in thickness settings to accommodate thick or thin stock, the table can be rapidly raised or lowered by pulling up or pushing down on the table raising and lowering control lever (C) Fig. 9. NOTE: The machine must be turned "ON" and the feed rolls engaged when doing this.

Fine adjustment of the table height can be made by loosening lock knob (D) Fig. 9, and turning table raising and lowering handwheel (E). Tighten lock knob (D) after table adjustment is made. The handy English/Metric Scale (F) indicates the desired table height setting.



Fig. 9

The English/Metric scale and shelf (G) Fig. 10, located on the front of the table is used to quickly determine the thickness of stock, before or after planing, by simply placing the stock on the shelf as shown in Fig. 10. This enables you to quickly position the table for the next cut.

NOTE: The setting of the table to its final position should always be made by raising the table to the desired setting and not lowering the table. This insures that all backlash will be removed from the raising and lowering screws.



Fig. 10

FEED ROLL SPEED CONTROLS

Your planer is supplied with feed roll speeds of 25 and 46 feet per minute. When the feed roll lever (A) is in the "up" position as shown in Fig. 11, the feed rolls are engaged and the planer will feed. When the lever (A) is in the "down" position the feed rolls are disengaged and the planer will not feed. To disengage the feed rolls, at any time, simply push down on the engagement lever (A) Fig. 11.



Fig. 11

To change feed roll speeds, make sure the feed roll engagement lever (A) Fig. 12, is disengaged (in the down position) and open the left side door of the machine. When the belt (C) is on the smallest step of the motor pulley (D) and the largest step of the gearbox pulley (E), the feed roll speed will be 25 feet per minute. When the belt (C) is on the largest step of the motor pulley (D) and the smallest step of the gearbox pulley (E), the feed roll speed will be 46 feet per minute.

TABLE ROLLERS

Your planer is supplied with two table rollers (A) Fig. 13, which aid in feeding the stock by reducing friction and turn as the stock is fed through the planer. It is not possible to give exact dimensions on the proper height setting of the table rollers because each type of wood behaves differently. As a general rule, however, when planing rough stock the table rollers should be set HIGH and when planing smooth stock the table rollers should be set LOW.

To raise the table rollers (A) Fig. 13, turn adjustment knob (B) clockwise. To lower table rollers (A) turn adjustment knob (B) counterclockwise.

ANTI-KICKBACK FINGERS

Anti-kickback fingers (A) Fig. 14, are provided on your planer to prevent kickback. These fingers operate by gravity and it is necessary to inspect them occasionally to make sure they are free of gum and pitch so they move independently and operate correctly.

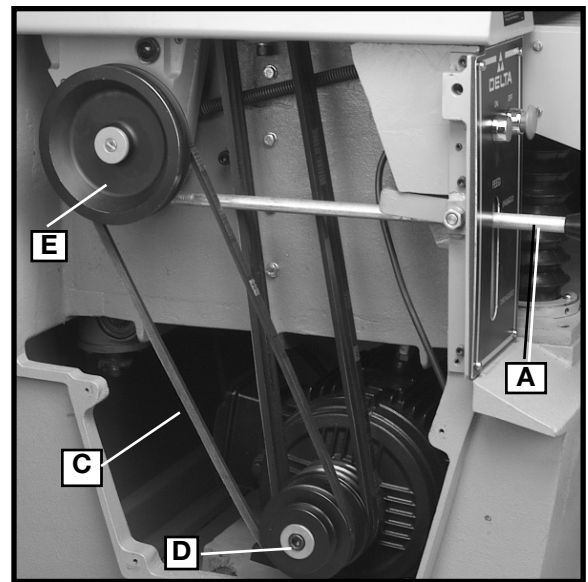

Fig. 12

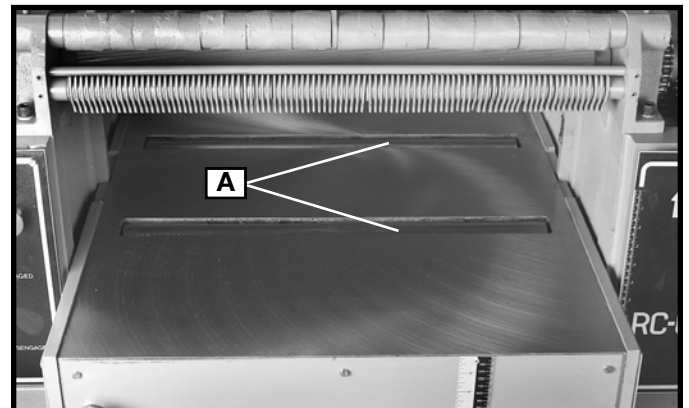

Fig. 13

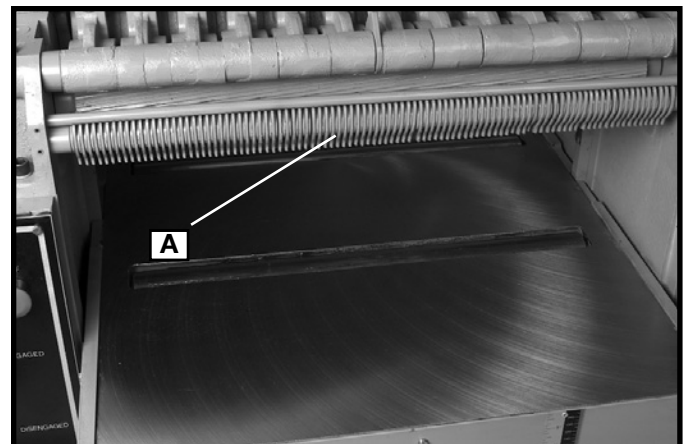

Fig. 14

CHECKING AND ADJUSTING BELT TENSION

DRIVE BELT TENSION: Proper drive belt tension is obtained when there is zero deflection, using light finger pressure, on drive belts (A) Fig. 16, midway between pulleys. If an adjustment is necessary, push down on lever (B) Fig. 16, to disengage feed roller. Loosen jam nut (C) Fig. 17, located on top of motor (D) and turn adjustment stud (E) right or left as needed until proper drive belt tension is obtained. Tighten jam nut (C) after adjustment is made.

FEED ROLL BELT TENSION: Proper tension on feed roll belt (F) Fig. 16, is obtained when there is approximately 1" deflection, using light finger pressure on feed roll belt (F), midway between pulleys.

If an adjustment is necessary, change position of rod (B) Fig. 18, in stud (G) by tightening and loosening two nuts (H) until correct belt tension is obtained. Both nuts (H) should be tight against stud (G) as shown in Fig. 18, after adjustment is made.

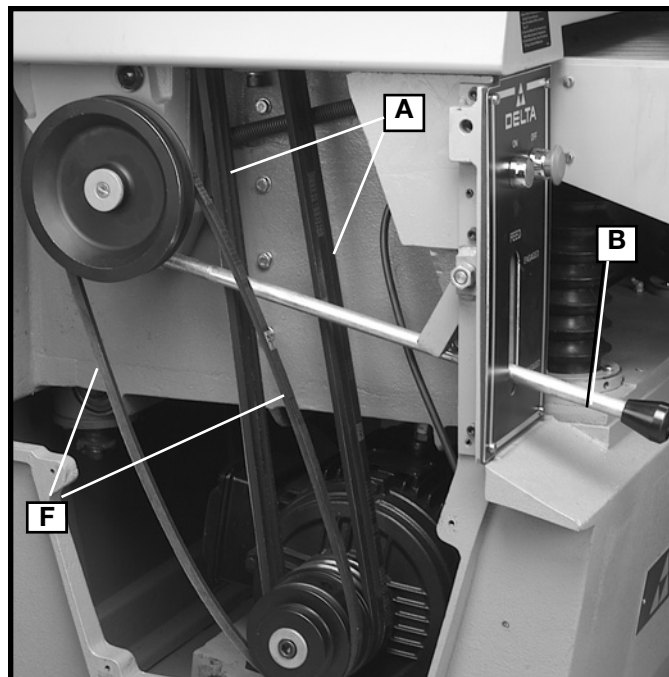

Fig. 16

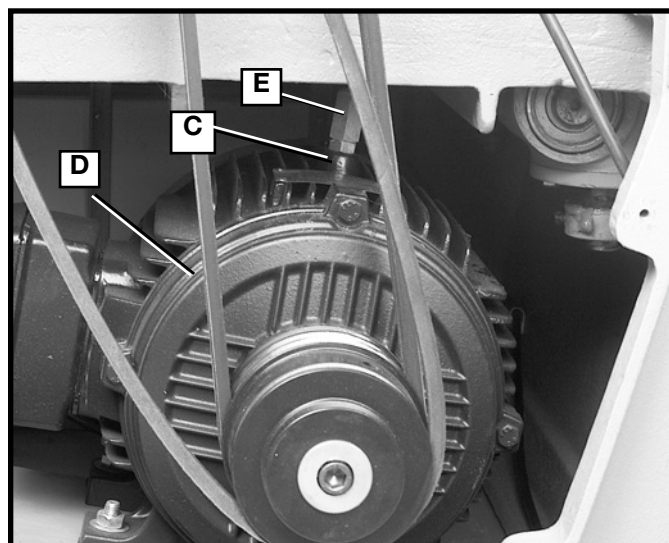

Fig. 17

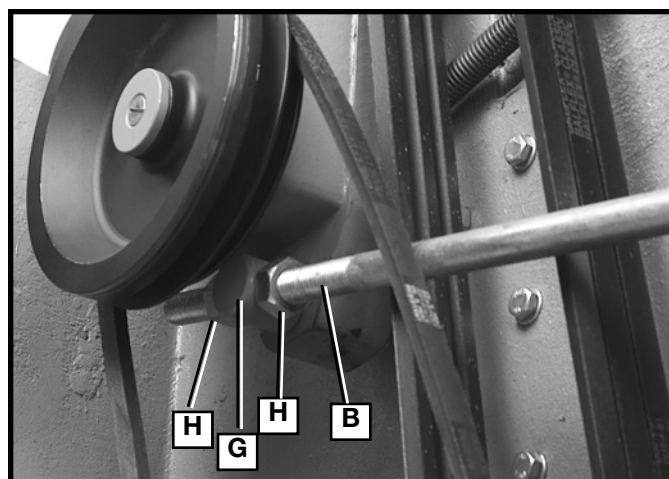

Fig. 18

CHECKING, ADJUSTING AND REPLACING KNIVES

1. When checking, adjusting or replacing the cutterhead knives on the planer, proceed as follows:

A. **⚠ WARNING** DISCONNECT MACHINE FROM POWER SOURCE

B. Remove the top cover of the planer exposing the cutterhead.

C. Check all four knives for proper setting using the knife guage (A), as shown in Fig. 20. When the guage (A) is placed on the cutterhead and the bottom of the two roll pins, one of which is shown at (B), are against the edge of the slot (C) opposite the knife, the knife should just contact the bottom of the guage (D).

D. If any of the knives require an adjustment, slightly loosen the knife locking bar of each of the four knives by turning the knife locking screws (E) Fig. 20, into the locking bar just enough to relieve stress in the cutterhead but not disturb the setting of the four knives.

E. To adjust the knife that must be reset, loosen all of that knife's locking screws (E) Fig. 20, by turning them into the locking bar. As the knife locking bar becomes loose, lifter springs under the knife will raise the knife until it contacts the bottom of the guage (D). Then snug up the knife locking bar by lightly backing out the locking screws (E) against the knife slot. **IMPORTANT: AT THIS TIME, ONLY TIGHTEN THE KNIFE INTO THE SLOT ENOUGH TO HOLD IT IN POSITION.**

F. If additional knives must be reset, repeat STEP C.

G. After all four knives are set with the screws just snug, back out and tighten the locking screws, five of which are shown at (E) Fig. 20, against the slot. Start with the end screws first and proceed on alternate sides toward the center screws until the knife is securely held in the cutterhead. Tighten the remaining three knives in the same manner.

2. **⚠ WARNING** IF THE KNIVES ARE TO BE REMOVED FOR SHARPENING OR REPLACEMENT, EXTREME CARE SHOULD BE TAKEN AS THE KNIVES ARE VERY SHARP. TO REMOVE THE KNIVES, WEAR GLOVES AND PROCEED AS FOLLOWS:

A. **⚠ WARNING** DISCONNECT MACHINE FROM POWER SOURCE

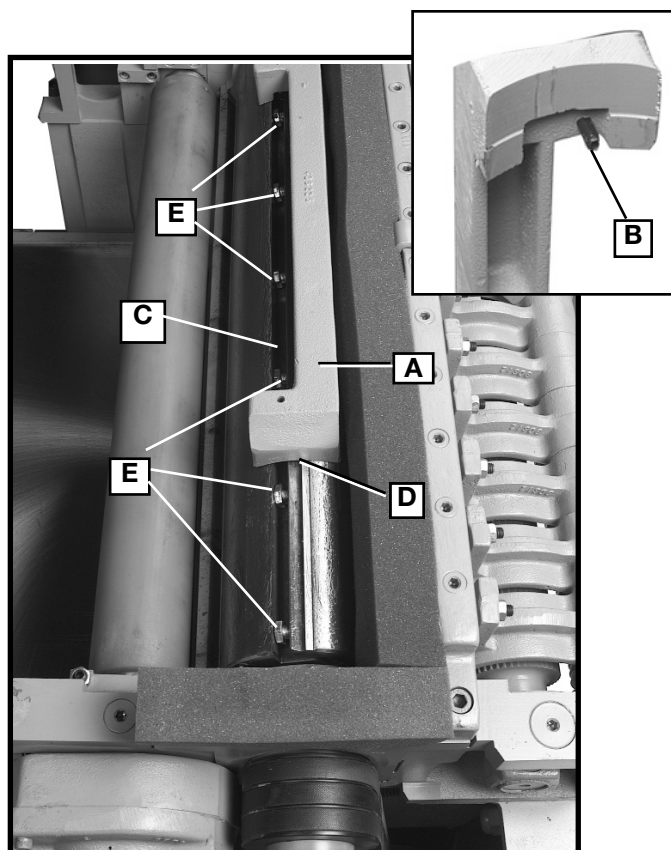

Fig. 20

B. To remove each knife, loosen the knife locking bar, by turning the locking screws, five of which are shown at (E) Fig. 20, into the knife locking bar and remove the locking bar, knife and springs located under the knife.

C. Remove the remaining three knives in the same manner.

D. Thoroughly clean the knife slots, knife bars, springs and screws. If the threads appear worn or stripped or if the heads are becoming rounded, replace them.

E. Inspect the cutting edge of the knives for nicks or wire edge. Hone the knives slightly using a stone or if the knives are to be sharpened, maintain a cutting angle of 40 degrees.

F. Insert springs, knives and knife locking bars into all four slots in the cutterhead. Push knives down as far as possible and back out locking screws, five of which are shown at (E) Fig. 20, just enough to hold all four knives in the cutterhead.

G. Adjust all four knives as explained in Step 1.

LEVELING THE TABLE

The table must be parallel to the cutterhead knives. To check and adjust, proceed as follows:

1. **⚠ WARNING DISCONNECT MACHINE FROM POWER SOURCE**

2. Remove the four screws that attach the top cover to the planer and carefully remove the top cover.

3. Place a straight edge (A) Fig. 21, on the ground surfaces (B) of the planer, as shown.

4. Place the guage block (C) Fig. 21, on the table directly underneath the straight edge at one side, as shown, Raise the table until the guage block just touches the straight edge. Do not raise or lower the table any further until the adjustment for leveling the table is completed.

5. Move the guage block (C) Fig. 21, to the opposite (left end) of the table and check to see if the table is the same distance from the straight edge as on the right side.

6. Place the straight edge (A) on the two ground surfaces (B) of the outfeed end of the planer as shown in Fig. 22. Check both ends of the table with guage block (C) to see if table is level.

7. If the table is low or high at any of the four points checked with the guage block in Figs. 21 and 22, locate the post directly underneath the end of the table that must be adjusted. Then loosen the three screws, two of which are shown at (A) Fig. 22A, and turn flange (B) to raise or lower the table at that end.

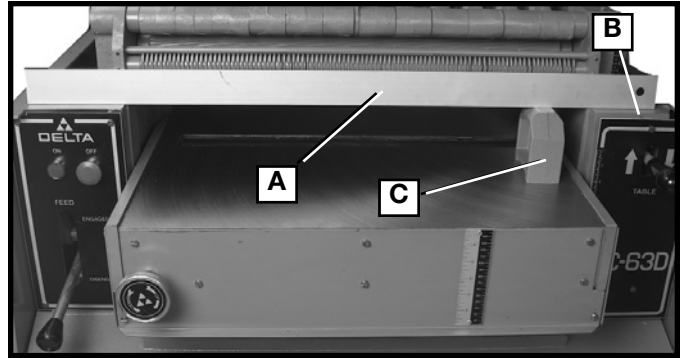

Fig. 21

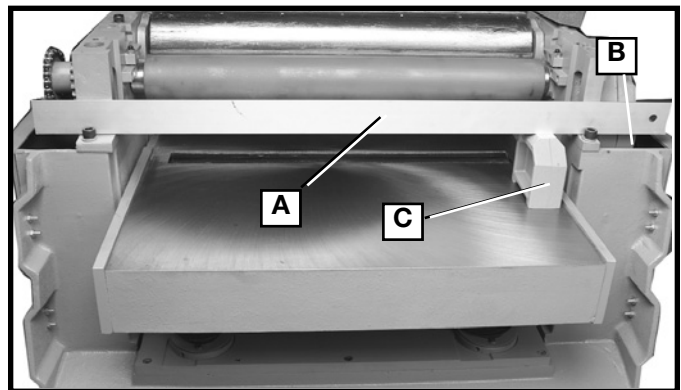

Fig. 22

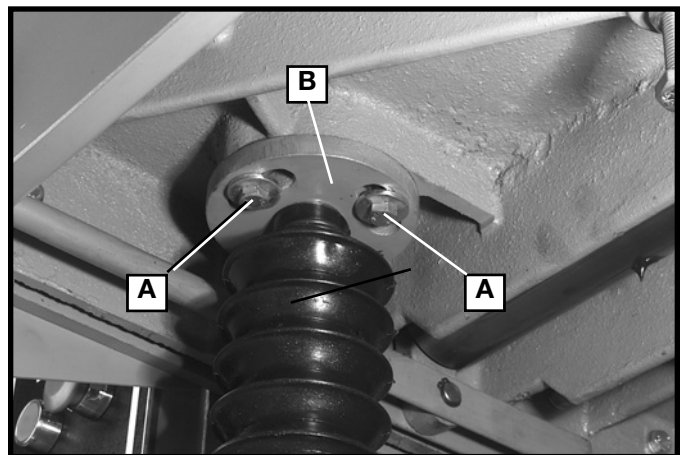

Fig. 22A

CHECKING AND ADJUSTING BED ROLL HEIGHT

The height of the bed rolls (A) and (E) Fig. 23A, should be set between .002" and .004" above the table surface, with the bed rolls at their lowest position. To check the infeed bed roller height setting, proceed as follows:

1. **⚠ WARNING DISCONNECT MACHINE FROM POWER SOURCE**
2. Turn height adjustment knob (B), counterclockwise as far as it will go.
3. Place a straight edge (C), across the infeed and outfeed rollers on the left side of the table as shown.
4. With a feeler gauge (D), measure the gap between the table surface and the straight edge (C) near the infeed roll (E).
5. If an adjustment to the infeed roller (E), is necessary, loosen set screw (F) Fig. 23B, located underneath the left front end of the table.
6. Turn adjustment collar (G) Fig. 23B left or right as needed to attain proper height adjustment.
7. Tighten set screw (F) Fig. 23B after adjustment is made.

To check the outfeed roller height setting, proceed as follows:

1. With a feeler gauge (H) Fig. 23C, measure the gap between the table surface and the straight edge (C) near the outfeed roller (E).
2. If an adjustment to the outfeed roller is necessary, loosen jam nut (K) Fig. 23D, located on the left side of machine under the table, and turn collar (L) right or left as needed until the outfeed roller is adjusted properly.
3. Tighten jam nut (K) Fig. 23D.

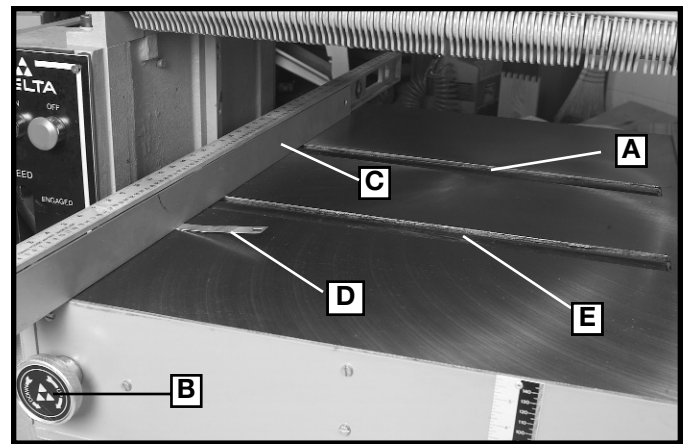

Fig. 23A

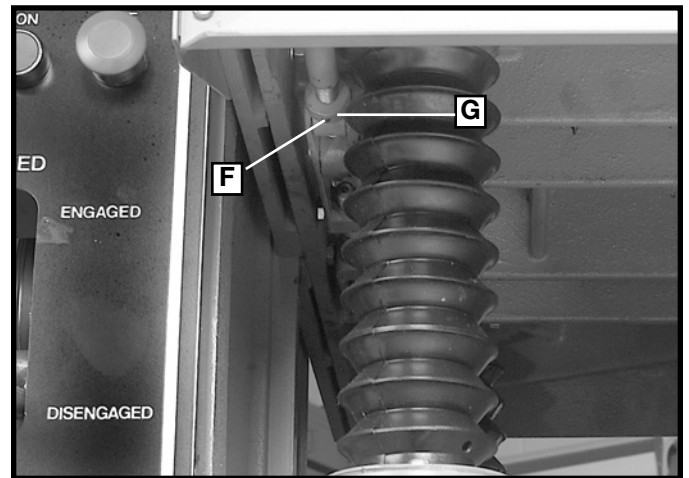

Fig. 23B

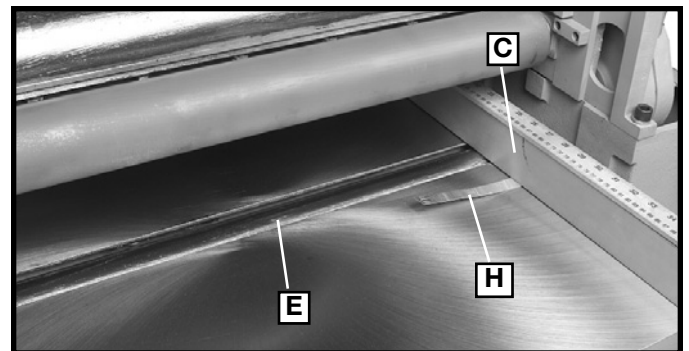

Fig. 23C

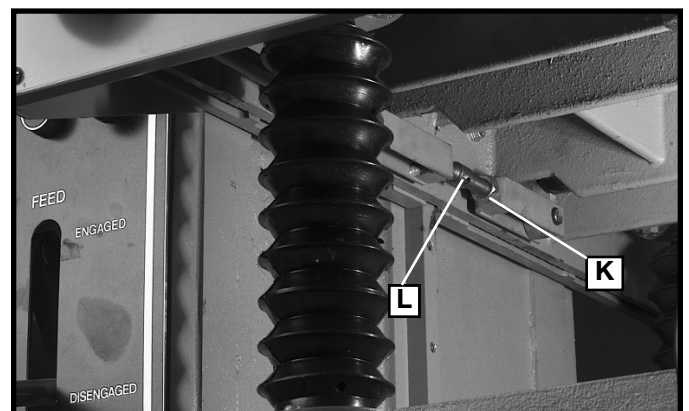

Fig. 23D

ADJUSTING PRESSURE BAR

IMPORTANT: THE PRESSURE BAR IS SET AT THE FACTORY AND SHOULD NOT NEED ASJUSTMENT. BUT WHEN KNIVES ARE SHARPENED OR REPLACED THE PRESSURE BAR SETTING SHOULD BE CHECKED AND ADJUSTED IF NECESSARY.

The pressure bar is located directly behind the cutter-head and rides on the planed surface of the stock, pressing the stock down on the table. If the stock does not feed, the pressure bar is set too low. If the stock has chatter marks, the pressure bar is set too high. The pressure bar must be parallel to the knives and set .040" below the cutting circle.

To check and adjust the pressure bar, proceed as follows:

1. **⚠ WARNING DISCONNECT MACHINE FROM POWER SOURCE**

2. Remove the four screws that attach the top cover (A) Fig. 24A to the planer and carefully remove the top cover.

3. Make certain the knives are adjusted properly as previously explained under CHECKING, ADJUSTING AND REPLACING KNIVES.

4. Place the guage block (A) Fig. 24B, on the table directly underneath the cutterhead as shown. Place a .040" feeler guage (B) Fig. 24B, on top of the guage block and raise the table until the knife (C) just touches the feeler guage when the knife is at its lowest point.

5. Next, set the feeler guage aside and move the guage block (A) Fig. 25, directly underneath the pressure bar (B) on one end of the table. The pressure bar (B) should just touch the guage block (A). Check the pressure bar at the opposite end of the table in the same manner.

6. If the pressure bar must be adjusted, remove screw (D) Fig. 26. Loosen screw (E) Fig. 26A, three or four turns. Turn screw (F) Fig. 26A clockwise to raise the bar or counter clockwise to lower the bar. The bottom of pressure bar should just touch the gauge block (A) Fig. 25.

8. Then tighten screw (E) Fig. 26A until it bottoms and then loosen it two complete turns. Replace screw (D) Fig. 26A.

9. This adjustment to the pressure bar should be made on the opposite end of the planer In the same manner.



Fig. 24A

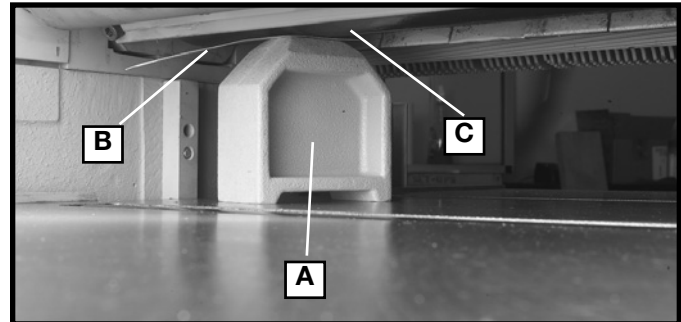

Fig. 24B

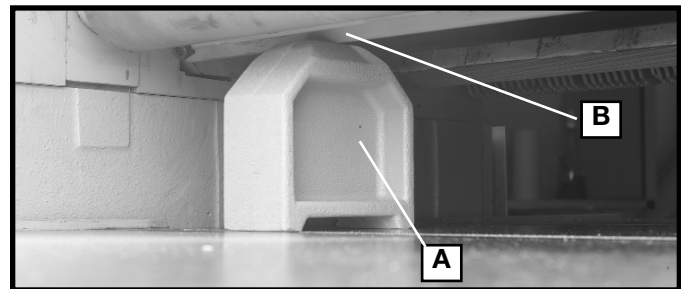

Fig. 25

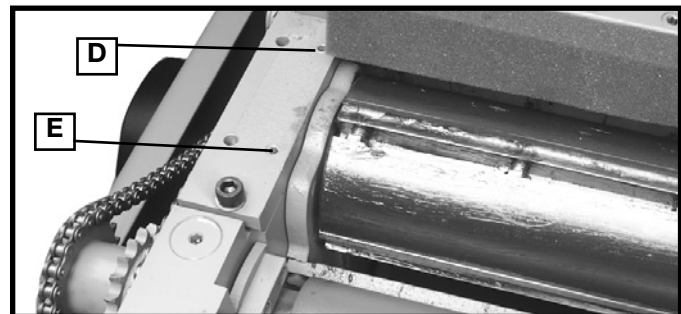

Fig. 26



Fig. 26A

ADJUSTING THE CHIPBREAKER

The chipbreaker is located on the top of the planer and extends down around the front of the cutterhead. The chip-breaker segments raise as stock is fed through and "break or curl" the chips the same as the plane iron cap on a hand plane. The bottom of the chipbreaker must be parallel to the knives and set .040" below the cutting circle. To check and adjust the chipbreaker, proceed as follows:

1. **⚠ WARNING DISCONNECT MACHINE FROM POWER SOURCE**

2. Remove the four screws that attach the top cover to the planer and carefully remove the top cover.

3 Make certain the knives are adjusted properly as previously explained under CHECKING, ADJUSTING AND REPLACING KNIVES.

4. Place the guage block (A) Fig. 29, on the table directly underneath the cutterhead as shown. To adjust the chipbreaker, place a .040" feeler gauge (B) Fig. 29, on top of the guage block and raise the table until the knife (C) just touches the feeler guage when the knife is at its lowest point.

5. Move the guage block (A) Fig. 30, underneath each chipbreaker segment (B) as shown. The bottom of each chipbreaker segment should just touch the top of the guage block.

6. If an adjustment to any of the chipbreaker segments is necessary, loosen the corresponding lock nut, such as (C) Fig. 31, and turn adjusting screw (D) in or out as required. Then tighten lock nut (C).

7. Spring tension on the chipbreaker segments is properly set when the head of corresponding screw (E) Fig. 32, is two complete turns below surface of casting (F).

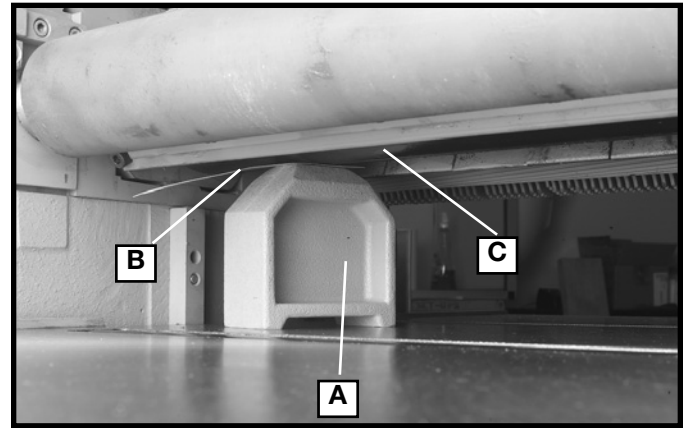

Fig. 29

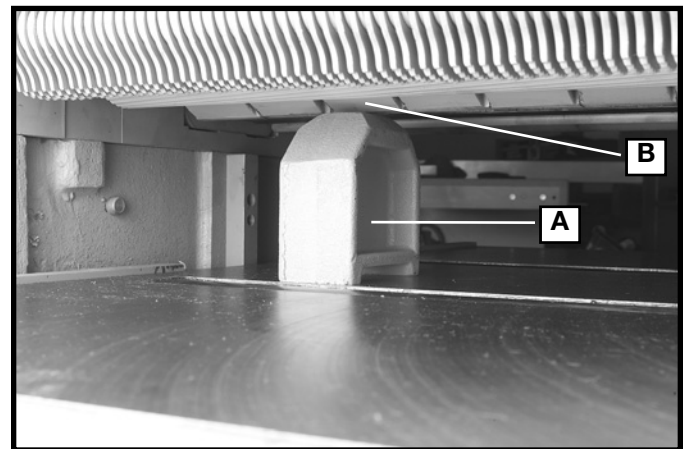

Fig. 30

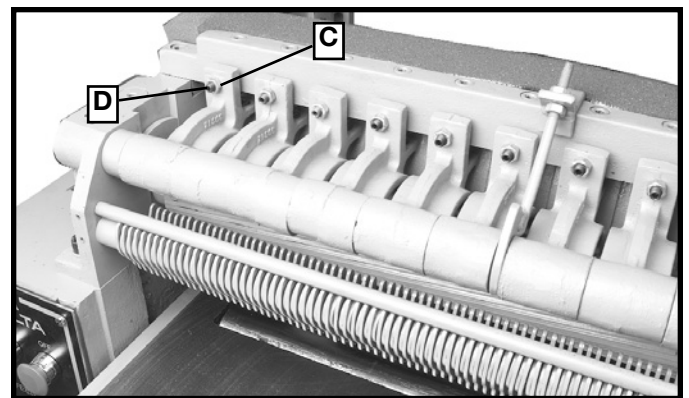

Fig. 31

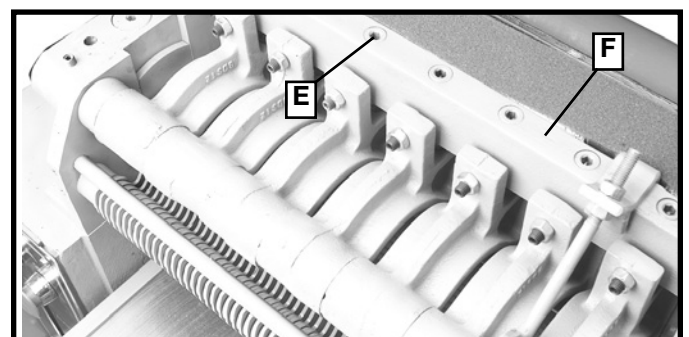

Fig. 32

ADJUSTING SPRING TENSION ON FEED ROLLERS

The outfeed roll (A) Fig. 33, and infeed roll (not visible) are those parts of your planer that feed the stock while it is being planed. The feed rolls are under spring tension and this tension must be sufficient to feed the stock uniformly through the planer without slipping but should not be too tight that it causes damage to the board. The tension should be equal at both ends of each roll.

To adjust spring tension on the infeed roll, turn screws (B) Fig. 33, right or left until they are flush with top of casting (C). To adjust spring tension on the outfeed roll (A), turn screws (D) until they are 2 to 3 complete turns below surface of casting (E).

ADJUSTING OUTFEED ROLLER

The outfeed roller (A) Fig. 34, should be .035" below the cutting circle. To check and adjust the outfeed roll, proceed as follows:

1. **⚠WARNING DISCONNECT MACHINE FROM POWER SOURCE**

2. Make certain the knives are adjusted properly as previously explained under CHECKING, ADJUSTING AND REPLACING KNIVES.

3. Place the gauge block (C) Fig. 35, on the table directly underneath the cutterhead, as shown. Place a .035" feeler gauge (B) on top of the gauge block and raise the table until the knife (A) just touches the feeler gauge when the knife is at its lowest point.

Do not move the table any further until the adjustment is completed.

4. Place the gauge block underneath outfeed roll (A) Fig. 36. The feed roll should just touch the top of the gauge block (C) which would be .035" below the cutting circle. If an adjustment is necessary, loosen locknut (D) Fig. 37, and turn adjusting screw (E) until the outfeed roll just touches the top of the gauge block. Repeat at opposite end of feed roll.

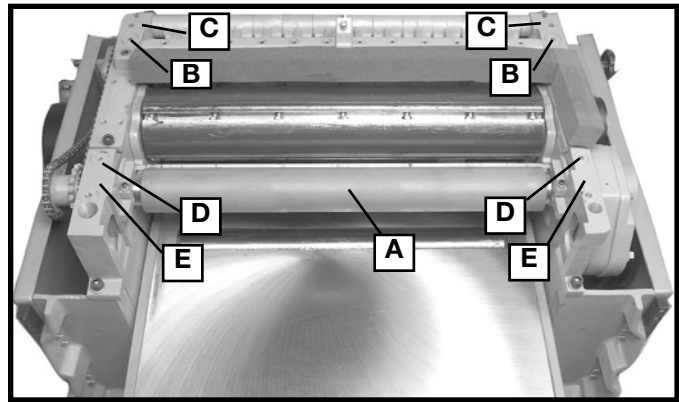

Fig. 33

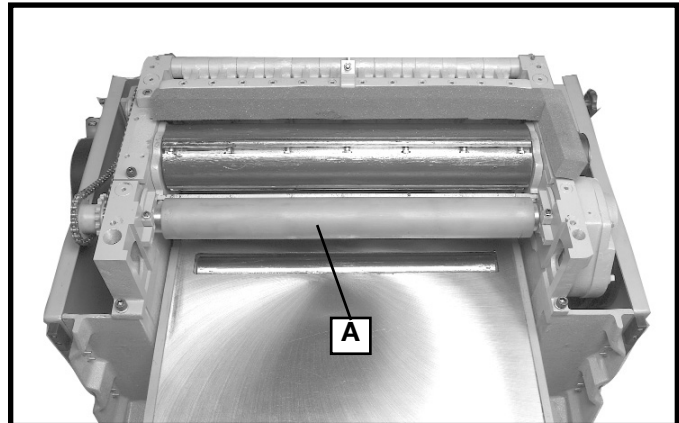

Fig. 34

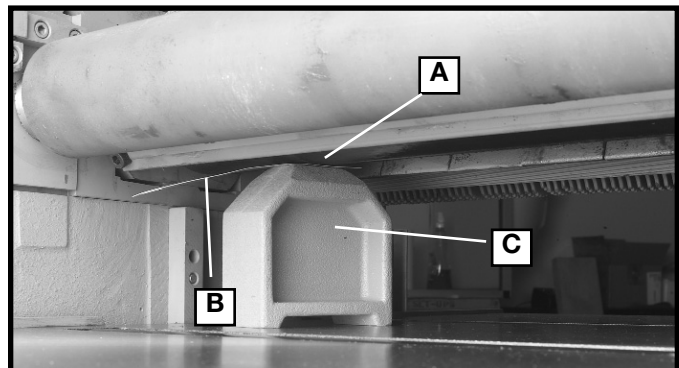

Fig. 35

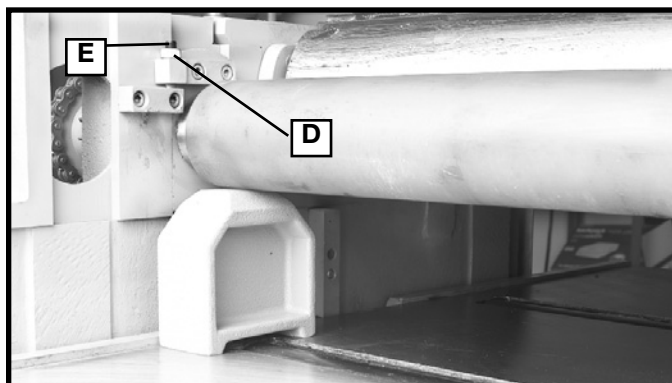

Fig. 37

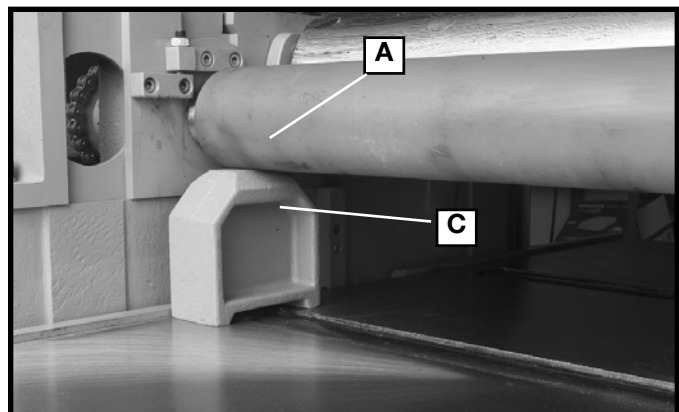

Fig. 36

ADJUSTING CHIP DEFLECTOR

1. **⚠ WARNING DISCONNECT MACHINE FROM POWER SOURCE**
2. Remove the cutterhead guard.
3. The edge (C) of the chip deflector (A) Fig. 38, should be adjusted so it is a minimum of .040" and a maximum of .080" away from the cutting circle. Place a feeler gauge between the knife and the edge of the chip deflector as shown in Fig. 38. If an adjustment is necessary, loosen three screws (B) and move chip deflector.

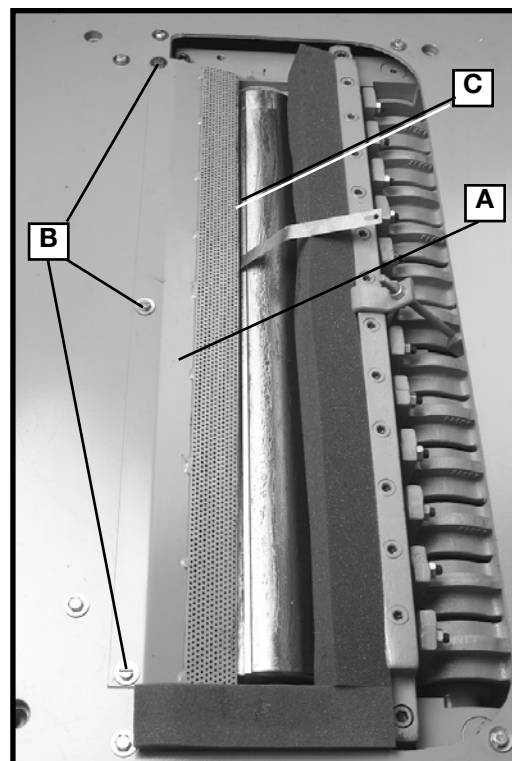

Fig. 38

ADJUSTING TABLE HEIGHT SCALE

The table height scale is adjusted at the factory to indicate the distance from the table to the cutting circle (depth of cut).

To check and adjust the pointer, proceed as follows:

1. Run a piece of wood part way through the planer and stop the machine.
2. Measure the thickness of the finished piece. If necessary, loosen two screws (A) Fig. 39 adjust pointer (B) and retighten screws (A).

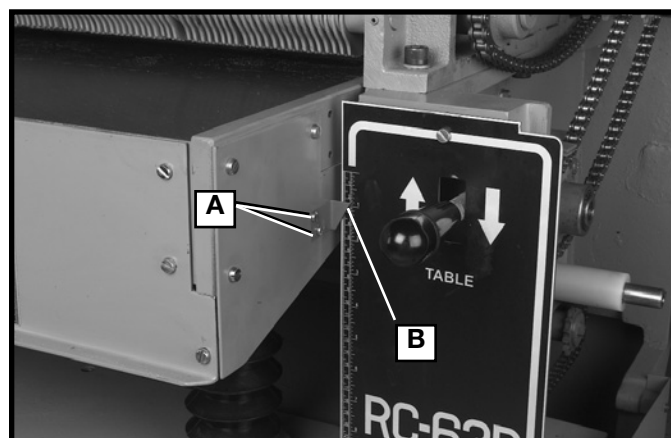

Fig. 39

GAUGE BLOCK

A gauge block has been supplied with your planer; however, if it is ever necessary to make a gauge block out of hardwood, follow the instructions shown in Fig. 40.

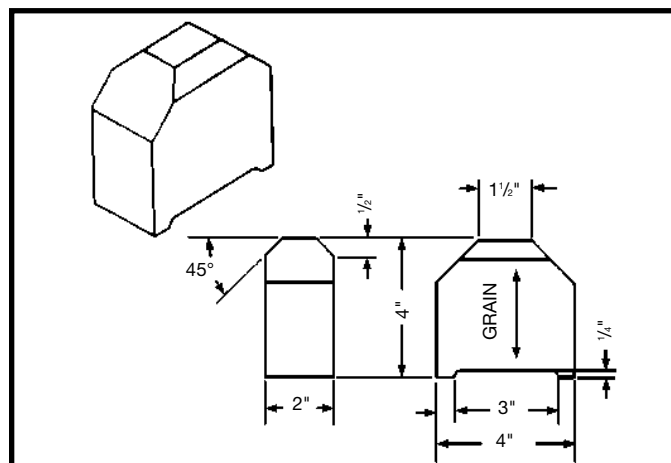

Fig. 40

MACHINE USE

When using your machine, follow these few simple steps for achieving the best results.

1. **True Up One Face** – Feed one face of the board over a jointer, making thin cuts with each pass, until the entire surface is flat.
2. **Plane to Thickness** – Place the side you planed in **STEP 1** face down and feed the board through the planer. Plane until this side is flat, then plane both sides of the board until you are satisfied with the thickness. Make thin cuts, and alternate sides with each pass. If, during the planing operation, you notice the board twisting, warping, or bowing, repeat **STEP 1** and true up one face.
3. When planing long stock, provide table extensions to support the infeed and outfeed end of the workpiece.
4. Plane with the grain only, and keep planer table clean. Occasionally, wax the table surface to reduce friction during the planing operation.
5. **Cross-cut to Final Length** – Cross-cut lumber to final length.

CAUTION

THE KNIVES ON THE PLANER WILL NOT WEAR EVENLY IF THE WOOD IS FED THROUGH THE SAME SPOT ON THE TABLE EVERY TIME. FEED THE WOOD THROUGH THE PLANER AT DIFFERENT SPOTS ON THE TABLE TO HELP ELIMINATE UNEVEN WEAR OF THE KNIVES.

TROUBLESHOOTING

For assistance with your machine, visit our website at www.deltamachinery.com for a list of service centers or call the DELTA Machinery help line at 1-800-223-7278 (In Canada call 1-800-463-3582).

MAINTENANCE

LUBRICATION

Your machine requires lubrication as follows:

1. The four grease fittings, one of which is shown at (A) Fig. 41, located at the base of the four table posts are to be lubricated every 100 hours of operation with an automotive type lithium grease or equivalent.
2. As required, lubricate the four table raising and lowering screws, three of which are shown at (B) Fig. 42, with an automotive type lithium grease or equivalent.
3. The gear box oil should be changed once a year using extreme pressure gear oil, available from Delta in one pint cans under part number 999-01-013-1210. The gear box drain plug is shown at (C) Fig. 43. The oil fill screw is shown at (B) and the oil level indicator is shown at (A) Fig. 43.

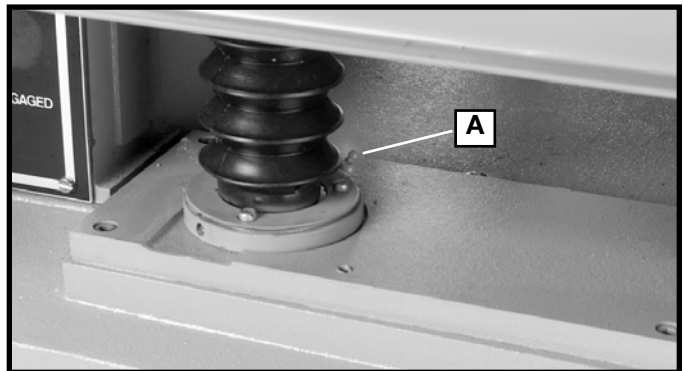

Fig. 41

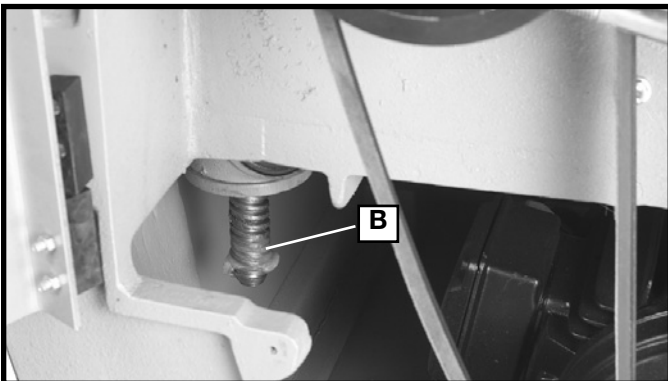

Fig. 42

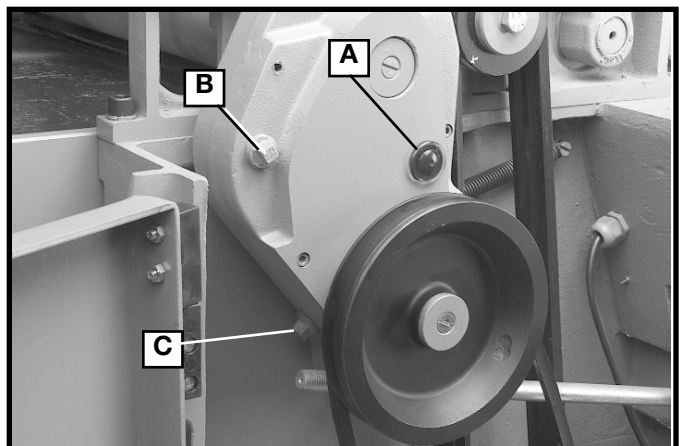

Fig. 43

KEEP MACHINE CLEAN

Periodically blow out all air passages with dry compressed air. All plastic parts should be cleaned with a soft damp cloth. NEVER use solvents to clean plastic parts. They could possibly dissolve or otherwise damage the material.

▲WARNING Wear ANSI Z87.1 safety glasses while using compressed air.

FAILURE TO START

Should your machine fail to start, check to make sure the prongs on the cord plug are making good contact in the outlet. Also, check for blown fuses or open circuit breakers in the line.

SURFACE LUBRICATION

Apply household floor paste wax to the machine table and extension table or other work surface weekly.

PROTECTING CAST IRON FROM RUST

To clean and protect cast iron tables from rust, you will need the following materials: 1 pushblock from a jointer, 1 sheet of medium Scotch-Brite™ Blending Hand Pad, 1 can of WD-40®, 1 can of degreaser, 1 can of TopCote® Aerosol. Apply the WD-40 and polish the table surface with the Scotch-Brite pad using the pushblock as a hold-down. Degrease the table, then apply the TopCote® accordingly.

SERVICE



PARTS, SERVICE OR WARRANTY ASSISTANCE

All Delta Machines and accessories are manufactured to high quality standards and are serviced by a network of Porter-Cable • Delta Factory Service Centers and Delta Authorized Service Stations. To obtain additional information regarding your Delta quality product or to obtain parts, service, warranty assistance, or the location of the nearest service outlet, please call 1-800-223-7278 (In Canada call 1-800-463-3582).

ACCESSORIES

A complete line of accessories is available from your Delta Supplier, Porter-Cable • Delta Factory Service Centers, and Delta Authorized Service Stations. Please visit our Web Site www.deltamachinery.com for a catalog or for the name of your nearest supplier.

▲WARNING Since accessories other than those offered by Delta have not been tested with this product, use of such accessories could be hazardous. For safest operation, only Delta recommended accessories should be used with this product.

WARRANTY



Two Year Limited New Product Warranty

Delta will repair or replace, at its expense and at its option, any new Delta machine, machine part, or machine accessory which in normal use has proven to be defective in workmanship or material, provided that the customer returns the product prepaid to a Delta factory service center or authorized service station with proof of purchase of the product within two years and provides Delta with reasonable opportunity to verify the alleged defect by inspection. For all refurbished Delta product, the warranty period is 180 days. Delta may require that electric motors be returned prepaid to a motor manufacturer's authorized station for inspection and repair or replacement. Delta will not be responsible for any asserted defect which has resulted from normal wear, misuse, abuse or repair or alteration made or specifically authorized by anyone other than an authorized Delta service facility or representative. Under no circumstances will Delta be liable for incidental or consequential damages resulting from defective products. This warranty is Delta's sole warranty and sets forth the customer's exclusive remedy, with respect to defective products; all other warranties, express or implied, whether of merchantability, fitness for purpose, or otherwise, are expressly disclaimed by Delta.

NOTES

NOTES

PORTER-CABLE • DELTA SERVICE CENTERS (CENTROS DE SERVICIO DE PORTER-CABLE • DELTA)

Parts and Repair Service for Porter-Cable • Delta Machinery are Available at These Locations
(Obtenga Refaccion de Partes o Servicio para su Herramienta en los Siguietes Centros de Porter-Cable • Delta)

ARIZONA

Phoenix 85013-2906
4501 N. 7th Ave.
Phone: (602) 279-6414
Fax: (602) 279-5470

CALIFORNIA

Ontario 91761 (Los Angeles)
3949A East Guasti Road
Phone: (909) 390-5555
Fax: (909) 390-5554

San Diego 92111
7290 Clairemont Mesa Blvd.
Phone: (858) 279-2011
Fax: (858) 279-0362

San Leandro 94577 (Oakland)
3039 Teagarden Street
Phone: (510) 357-9762
Fax: (510) 357-7939

COLORADO

Denver 80223
700 West Mississippi Ave.
Phone: (303) 922-8325
Fax: (303) 922-0245

FLORIDA

Davie 33314 (Miami)
4343 South State Rd. 7 (441)
Unit #107
Phone: (954) 321-6635
Fax: (954) 321-6638

Tampa 33634
4909 West Waters Ave.
Phone: (813) 884-0434
Fax: (813) 888-5997

GEORGIA

Forest Park 30297 (Atlanta)
5442 Frontage Road,
Suite 112
Phone: (404) 608-0006
Fax: (404) 608-1123

ILLINOIS

Addison 60101 (Chicago)
400 South Rohlwing Rd.
Phone: (630) 424-8805
Fax: (630) 424-8895

KANSAS

Overland Park 66214
9201 Quivira Road
Phone: (913) 495-4330
Fax: (913) 495-4378

MARYLAND

Elkridge 21075 (Baltimore)
7397-102 Washington Blvd.
Phone: (410) 799-9394
Fax: (410) 799-9398

MASSACHUSETTS

Franklin 02038 (Boston)
Franklin Industrial Park
101E Constitution Blvd.
Phone: (508) 520-8802
Fax: (508) 528-8089

MICHIGAN

Madison Heights 48071 (Detroit)
30475 Stephenson Highway
Phone: (248) 597-5000
Fax: (248) 597-5004

MINNESOTA

Eden Prairie 55344
9709 Valley View Road
Phone: (952) 884-9191
Fax: (952) 884-3750

MISSOURI

St. Louis 63146
11477 Page Service Drive
Phone: (314) 997-9100
Fax: (314) 997-9183

NEW YORK

Flushing 11365-1595 (N.Y.C.)
175-25 Horace Harding Expwy.
Phone: (718) 225-2040
Fax: (718) 423-9619

NORTH CAROLINA

Charlotte 28270
9129 Monroe Road, Suite 115
Phone: (704) 841-1176
Fax: (704) 708-4625

OHIO

Columbus 43229
1948 Schrock Road
Phone: (614) 895-3112
Fax: (614) 895-3187

Parma Heights OH 44130
6485 Pearl Road
Phone: (440) 842-9100
Fax: (440) 884-3430

OREGON

Portland 97230
14811 North East Airport Way
Phone: (503) 255-6556
Fax: (503) 255-6543

PENNSYLVANIA

Willow Grove 19090
(Philadelphia)
520 North York Road
Phone: (215) 658-1430
Fax: (215) 658-1433

TEXAS

Carrollton 75006 (Dallas)
1300 Interstate 35 N, Suite 112
Phone: (972) 446-2996
Fax: (972) 446-8157

Houston 77022-2122
536 East Tidwell Rd.
Phone: (713) 692-7111
Fax: (713) 692-1107

WASHINGTON

Auburn 98001(Seattle)
3320 West Valley HWY, North
Building D, Suite 111
Phone: (253) 333-8353
Fax: (253) 333-9613

Authorized Service Stations are located in many large cities. Telephone **800-438-2486** or **731-541-6042** for assistance locating one. Parts and accessories for Porter-Cable-Delta products should be obtained by contacting any Porter-Cable-Delta Distributor, Authorized Service Center, or Porter-Cable-Delta Factory Service Center. If you do not have access to any of these, call **800-223-7278** and you will be directed to the nearest Porter-Cable-Delta Factory Service Center. Las Estaciones de Servicio Autorizadas están ubicadas en muchas grandes ciudades. Llame al **800-438-2486** ó al **731-541-6042** para obtener asistencia a fin de localizar una. Las piezas y los accesorios para los productos Porter-Cable-Delta deben obtenerse poniéndose en contacto con cualquier distribuidor Porter-Cable-Delta, Centro de Servicio Autorizado o Centro de Servicio de Fábrica Porter-Cable-Delta. Si no tiene acceso a ninguna de estas opciones, llame al **800-223-7278** y le dirigirán al Centro de Servicio de Fábrica Porter-Cable-Delta más cercano.

CANADIAN PORTER-CABLE • DELTA SERVICE CENTERS

ALBERTA

Bay 6, 2520-23rd St. N.E.
Calgary, Alberta
T2E 8L2
Phone: (403) 735-6166
Fax: (403) 735-6144

BRITISH COLUMBIA

8520 Baxter Place
Burnaby, B.C.
V5A 4T8
Phone: (604) 420-0102
Fax: (604) 420-3522

MANITOBA

1699 Dublin Avenue
Winnipeg, Manitoba
R3H 0H2
Phone: (204) 633-9259
Fax: (204) 632-1976

ONTARIO

505 Southgate Drive
Guelph, Ontario
N1H 6M7
Phone: (519) 767-4132
Fax: (519) 767-4131

QUÉBEC

1515 ave.
St-Jean Baptiste, Suite 160
Québec, Québec
G2E 5E2
Phone: (418) 877-7112
Fax: (418) 877-7123

1447, Begin
St-Laurent, (Montréal),
Québec
H4R 1V8
Phone: (514) 336-8772
Fax: (514) 336-3505

The following are trademarks of PORTER-CABLE • DELTA (Las siguientes son marcas registradas de PORTER-CABLE • DELTA S.A.) (Les marques suivantes sont des marques de fabricant de la PORTER-CABLE • DELTA): Auto-Set®, BAMMER®, B.O.S.S.®, Builder's Saw®, Contractor's Saw®, Contractor's Saw II™, Delta®, DELTACRAFT®, DELTAGRAM™, Delta Series 2000™, DURATRONIC™, Emc2™, FLEX®, Flying Chips™, FRAME SAW®, Grip Vac™, Homecraft®, INNOVATION THAT WORKS®, Jet-Lock®, JETSTREAM®, 'kickstand®, LASERLOC®, MICRO-SET®, Micro-Set®, MIDI LATHE®, MORTEN™, NETWORK™, OMNIJIG®, POCKET CUTTER®, PORTA-BAND®, PORTA-PLANE®, PORTER-CABLE®&(design), PORTER-CABLE®PROFES-SIONAL POWER TOOLS, PORTER-CABLE REDEFINING PERFORMANCE™, Posi-Matic®, Q-3®&(design), QUICKSAND®&(design), QUICKSET™, QUICKSET II®, QUICKSET PLUS™, RIPTIDE™&(design), SAFE GUARD II®, SAFE-LOC®, Sanding Center®, SANDTRAP®&(design), SAW BOSS®, Sawbuck™, Sidekick®, SPEED-BLOC®, SPEEDMATIC®, SPEEDTRONIC®, STAIR EASE®, The American Woodshop®&(design), The Lumber Company®&(design), THE PROFESSIONAL EDGE®, THE PROFESSIONAL SELECT®, THIN-LINE™, TIGER®, TIGER CUB®, TIGER SAW®, TORQ-BUSTER®, TORQ-BUSTER®, TRU-MATCH™, TWIN-LITE®, UNIGUARD®, Unifence®, UNIFEEDER™, Unihead®, Uniplane™, Unirip®, Unisaw®, Univise®, Versa-Feeder®, VERSA-PLANE®, WHISPER SERIES®, WOODWORKER'S CHOICE™.

Trademarks noted with ™ and ® are registered in the United States Patent and Trademark Office and may also be registered in other countries. Las Marcas Registradas con el signo de ™ y ® son registradas por la Oficina de Registros y Patentes de los Estados Unidos y también pueden estar registradas en otros países.

PC7.2-0105-149

Free Manuals Download Website

<http://myh66.com>

<http://usermanuals.us>

<http://www.somanuals.com>

<http://www.4manuals.cc>

<http://www.manual-lib.com>

<http://www.404manual.com>

<http://www.luxmanual.com>

<http://aubethermostatmanual.com>

Golf course search by state

<http://golfingnear.com>

Email search by domain

<http://emailbydomain.com>

Auto manuals search

<http://auto.somanuals.com>

TV manuals search

<http://tv.somanuals.com>